

Panasonic[®]

Operating Instructions

Toaster Oven (Household Use)

Model No. **NB-G200**

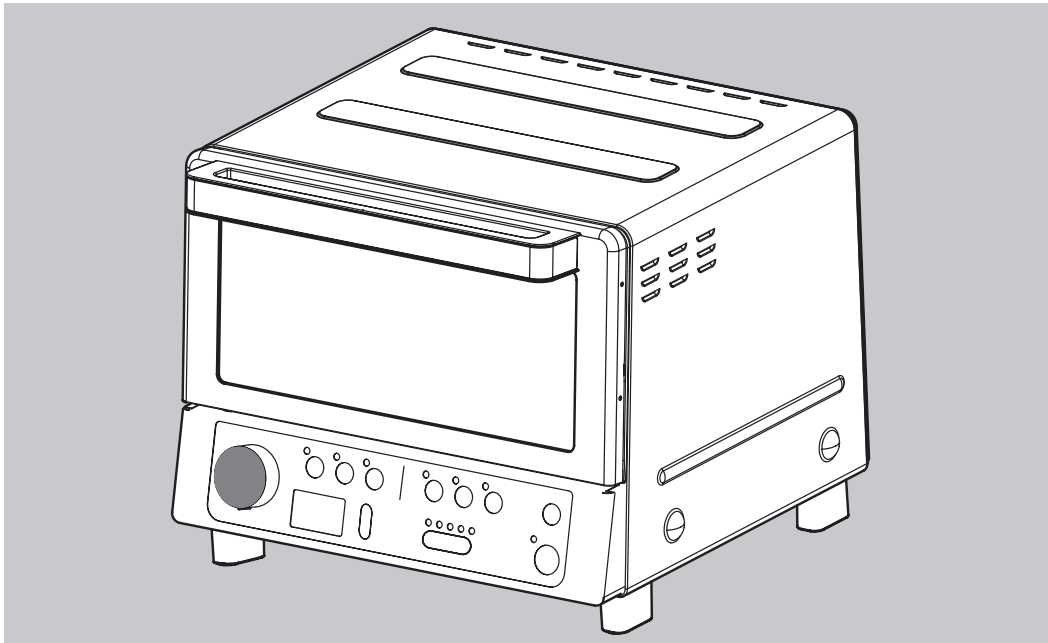

Thank you for purchasing Toaster Oven, NB-G200.
Please read these instructions carefully before using this product and save this manual for future use.
This product is intended for household use only.



BZ51A215
MX0824S0

Table of Contents

IMPORTANT SAFEGUARDS	3
SAVE THESE INSTRUCTIONS	4
Features	5
Safety precautions.....	6
Part Names and Handling Instructions.....	8
Cooking using automatic cooking keys	
Operating procedure.....	10
Toast, Frozen Waffle, Reheat Roll, Frozen Pizza	11
Reheat Quick, Frozen Hash Browns	12
Common to 6 automatic cooking menus	13
Cooking using the timer	
Operating procedure.....	14
Points for cooking with timer.....	15
Cooking guide.....	16
Maintenance	16
Troubleshooting.....	17
Specifications	17
Limited Warranty	18

IMPORTANT SAFEGUARDS

The following basic safety precautions apply when using electrical appliances:

1. Read all instructions.
2. Do not touch surfaces that may be hot. Use handles or knobs provided.
3. To protect against electrical shock do not immerse cord, plugs, portable appliances in water or other liquid.
4. Close supervision is necessary when any appliance is used by or near children.
5. Remove plug from outlet when the appliance is not in use, before putting on or taking off parts, and before cleaning. Allow to cool before handling.
6. Do not operate any appliance with a damaged cord or plug or after the appliance malfunctions or is dropped or damaged in any manner. Return appliance to the nearest authorized service facility for examination, repair, or electrical or mechanical adjustment.
7. The use of accessory attachments not recommended by the appliance manufacturer may cause injuries.
8. Do not use outdoors.
9. Do not let cord hang over edge of table or counter or touch hot surfaces.
10. Do not place on or near a hot gas or electric burner or in a heated oven.
11. Extreme caution must be used when moving an appliance containing hot oil or other hot liquids, which is produced during baking.
12. To disconnect, turn the control to OFF, then remove plug from wall outlet.
13. Do not use appliance for other than intended use.
14. Do not assume you know how to operate all parts of the toaster oven. Some features may work differently from those you are accustomed to.
15. Oversized foods or utensils must not be inserted in the appliance as they may create fire or electrical hazard.
16. A fire may occur if appliance is covered or touching flammable materials, including curtains, draperies, walls etc., when in operation. Do not store any item on top of the appliance when in operation.
17. Do not clean with metal scouring pads. Pieces can break off the pad and touch electrical parts, as they may creating electrical shock hazard.
18. Before using this appliance, move it 10 to 15cm (4 to 6 inches) away from the wall or any object on the counter top. Remove any object that may have been placed on top of the appliance. Do not use on surfaces where heat may cause a problem.

19. Extreme caution should be exercised when using containers constructed of other than metal or glass.
20. Replace cardboard lids on food containers with aluminum foil; cardboard lids may burn. When using aluminum foil, keep foil from touching heating elements.
21. Do not store any materials, other than manufacturer's recommended accessories, in this oven when not in use.
22. Do not place any of the following materials in the oven: paper, cardboard, plastic, etc.
23. Do not cover crumb tray or any part of the oven with metal foil. This will cause overheating of the oven.
24. In order to turn the appliance off, press the power button in the same way as for manual use even when you use the automatic cooking menu.
25. Do not use water on grease fires; smother fire or use dry chemical or foam type extinguisher.
26. Do not put food too close to the heating elements to prevent smoking, spattering, and the possibility of fats on foods catching fire.
27. Always make sure the toaster oven is turned off before opening the oven door.
28. Always use a pot holder or oven mitt to install or remove the baking pan or any cooking container.
29. Do not allow food to contact heater.
30. Keep interior of the toaster oven and crumb tray clean.

SAVE THESE INSTRUCTIONS

- A. A short power supply cord is provided to reduce the risk resulting from becoming entangled in or tripping over a longer cord.
- B. Longer detachable power-supply cords or extension cords are available and may be used if care is exercised in their use.
- C. If an extension cord is used, (1) the marked electrical rating of the extension cord should be at least as great as electrical rating of the appliance, and (2) the longer cord should be arranged so that it will not drape over the countertop or tabletop where it could be pulled on by children or tripped over unintentionally. (3) the cord set or extension cord should be a grounding-type 3-wire cord.

This appliance has a polarized plug (one blade is wider than the other). This plug is intended to fit into a polarized outlet only one way. If the plug does not fit fully into the outlet, reverse the plug. If it still does not fit, contact a qualified electrician.

Do not attempt to modify the plug in any way.

Features

The temperature can be controlled up to 8 levels ranging from 275 °F to 500 °F (135 °C to 260 °C).

This allows for a wider range of recipes using the oven, including baking cakes.

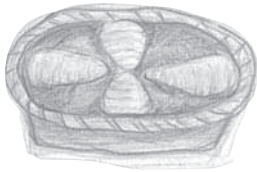

- In addition to the toaster function, its oven function allows you to bake cakes and tarts quickly and easily without preheating.

Double-heating using a combination of the far-infrared ray heater (Front heater) and the near-infrared ray heater (Rear heater) allows easy, quick cooking, such as heating frozen food and re-heating cold fries.

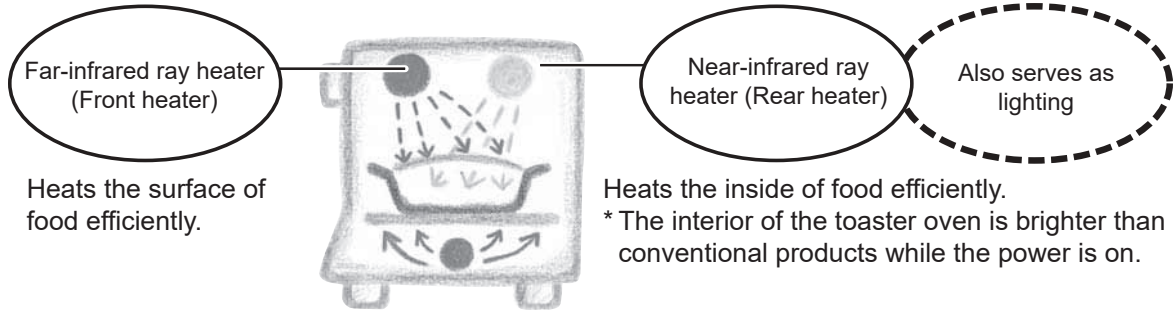

Six automatic cooking recipes for easy, convenient cooking.



- Press the recipe you want and adjust the degree of browning. Then, the microprocessor automatically controls the power and cooking time according to the recipe, to ensure a good result.



The interior is wide enough to bake a pizza as large as approx. 22.5cm (9 inches) in diameter.



Safety precautions Please observe these precautions fully.

In order to prevent accidents or injuries to the user, other people, and damage to property, please follow the instructions below.

■ The following chart indicates the degree of damage caused by improper operation.

 WARNING: Indicates serious injury or death.	 CAUTION: Indicates risk of injury or property damage.
--	--

■ The symbols are classified and explained as follows.

 This symbol indicates prohibition.	 This symbol indicates requirement that must be followed.
--	--

WARNING

-  • **Do not use the toaster oven near flammable materials such as a curtain.**
There is danger of fire hazard.
- **Do not put oil into the baking pan.**
There is danger of fire hazard.
- **Do not place the toaster oven in water. Avoid water splash.**
There is danger of short circuit or an electric shock.
- **Never try to disassemble, repair or remodel the toaster oven.**
There is danger of fire or malfunction, causing injury.
 - For repair, consult the store where you purchased this product.
- **Do not allow children to use the toaster oven. Do not use the toaster oven within the reach of children.**
There is danger of children getting burnt, electric shock or injury.
- **Never do anything that might cause damage to the cord or power plug.**
Do not modify it, place hot objects near it, bend it, twist it, stretch it, place heavy objects on it, or bundle it together.
If the unit is used when damaged, electrical short circuit or fire may result.
 - If in need of repair, please contact an authorized Service center.
- **Do not connect or disconnect the power plug with wet hands.**
This may result in electric shock.

-  • **Make sure the power plug is correctly inserted into the wall outlet.**
If the plug is inserted improperly, it may cause an electric shock or generate heat resulting in fire.
 - Do not use a damaged plug or a connection in a loose outlet.
- **Clean dust from the power plug regularly.**
A build-up of dust on the plug will attract condensation, which could cause cable damage resulting in fire.
 - Remove the plug and clean with a dry cloth.
- **Use a single outlet that matches the power rating of the unit.**
Heat generated when plugging in multiple appliances into one outlet may result in fire.
- **This appliance can be used by children aged from 8 years and above and persons with reduced physical, sensory or mental capabilities, or lack of experience and knowledge if they have been given supervision or instruction concerning use of the appliance in a safe way and understand hazards involved. Children shall not play with the appliance. Cleaning and user maintenance shall not be made by children unless they are older than 8 and supervised. Keep the appliance and its cord out of reach of children less than 8 years.**
(It may cause burns, injury or electric shock.)

⚠ CAUTION



- **Do not broil raw fish or meat directly.**

There is a chance the oil will catch fire.
• When grilling fish or meat, wrap in foil.
(See page 15.)

- **Do not leave the toaster oven unattended, when it is in use.**

There is a chance the food will catch fire.
• When you need to leave, make sure to turn off the power button.
• In particular, when baking something that is apt to easily catch fire, do not leave the toaster oven unattended. Watch the progress of cooking.

- **Do not put flammable materials on / under the toaster oven.**

There is danger of smoking, fire or burns.

- **Do not use this unit except for cooking.**

There is danger of fire hazard.

- **Do not bake bread with butter or jam.**

There is a chance the bread will catch fire.

- **Do not heat more than necessary.**

Overheating will cause the food to catch fire.
• Set the automatic cooking keys and timer correctly.



- **Always use with a crumb tray.**

There is danger of fire or injury hazard.
• Make sure the crumb tray is clean and set correctly when using the appliance.

- **Always clean the unit after use.**

• Otherwise it may cause smoke or fire.

- **If the food you are cooking emits smoke or catches fire, turn off the power button, then disconnect the power plug.**

• Do not open the door until the flame dies down.
• If air enters the interior of the toaster oven, the flame will become larger.
• Do not pour water on the toaster oven.
(The glass window will break.)

- **When unplugging the unit, pull by the power plug – not the cord.**

Electric shock and short circuit may result in fire.

- **When the unit is not in use, unplug the power plug from the wall outlet.**

Deteriorating insulation may result in an electric shock and/or fire.

- **This appliance is not intended to be operated by means of an external timer or separate remote-control system.**



- **Do not use the toaster oven near wall or cabinet.**

The wall or cabinet could become deformed or discolored.

• Keep the toaster oven away from flammable materials (wooden wall or cabinet) as follows:

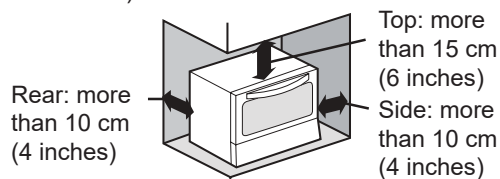

Set-up standard

• One side (right or left) of the toaster oven should be free from any obstacle.
• Keep the toaster oven further away from the wall than indicated above, if the wall or cabinet is coated with vinyl or resin.

- **Do not place the unit on unstable surfaces or surfaces that can be affected by heat. It may cause fire.**

There is danger of a fire hazard.

• Do not place the toaster oven on carpet.

- **Do not touch the metallic parts or the glass window during or immediately after use.**

There is danger of getting burnt.

• Make sure the toaster oven is not hot before performing maintenance.

- **Do not heat canned or bottled goods directly.**

There is danger of burns or injury.

- **Do not stare at the near-infrared ray heater for a long time.**

It could cause injury to your eyes.

- **Do not use parchment paper or cooking sheet other than for putting it under cake molds.**

• Do not use cake-mix paper molds.
The parchment paper or cooking sheet might burn or catch fire.

- **Do not use the appliance for any purpose other than those described in these instructions.**

There is danger of burns or injury.

• Panasonic will not accept any liability if the appliance is subject to improper use, or failure to comply with these instructions.

Part Names and Handling Instructions

Upper heater

- Near-infrared ray heater (Far end)
(Rear heater)

• Also serves as lighting.

- Far-infrared ray heater (Door side)
(Front heater)

Wire rack (Detachable)

Glass window

Door

Door handle

Crumb tray

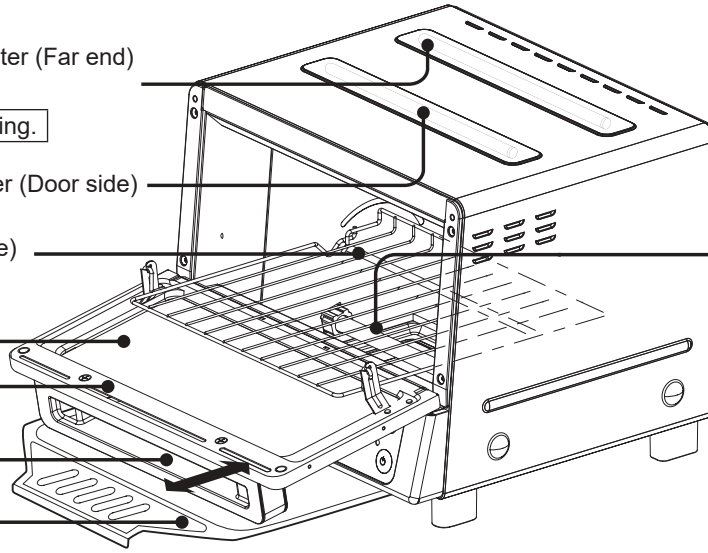

Lower heater

Power plug

Cord

- Insert the tray toward the far end securely.
(If the tray is not properly set, it may result in poor cooking.)
- Pull the tray toward you to remove.
- Make sure the toaster oven is cold before removing the tray.

- Do not use the cord in a tight bundle.
(The cord will become hot and cause malfunction of the toaster oven.)

Note

- The heaters automatically turn off and on during operation to control the temperature during cooking.
This is not a malfunction.

Important

- Do not open the door during cooking.
(Cooking will be uneven.)
- Do not pour water on the glass window if it is hot.
(The glass might break.)

Operation panel

Using automatic cooking key for cooking (See page 10.)

Using the time for cooking (See page 14.)

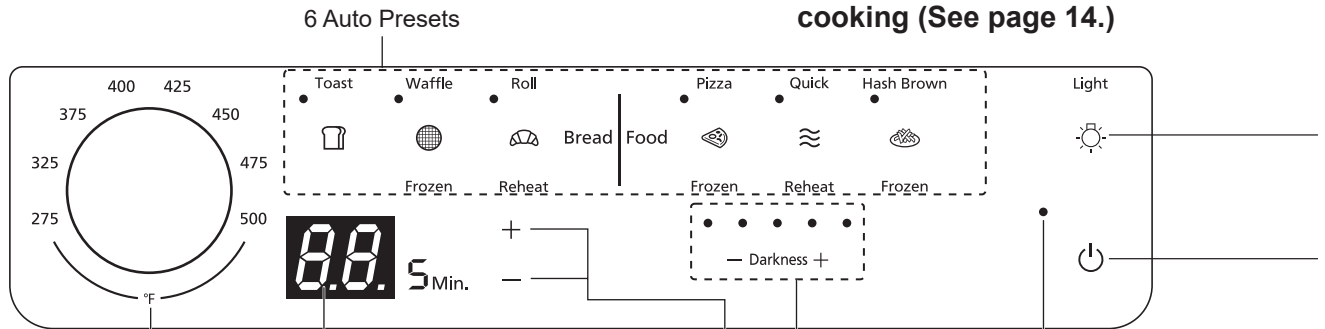

Set the temperature for timer cooking

Rough estimate, required cooking time is displayed (common to auto/timer)

Set time up to 25 mins

Select the color of browning

Power on lamp

To remove Wire rack

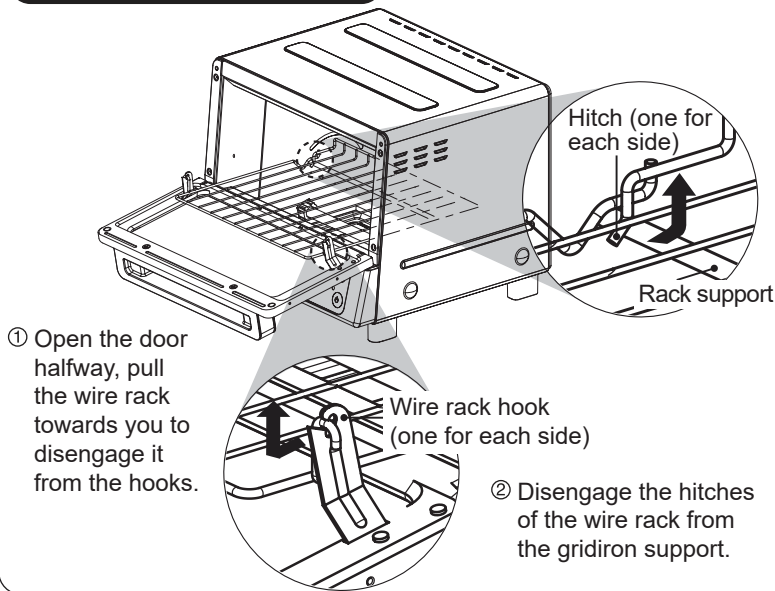

To attach

- ① Open the door. Engage the hitches of the wire rack onto the rack support inside the toaster oven.
- ② Pull the wire rack toward you while closing the door halfway and engaging the wire rack onto the hooks.

Accessory

1 baking pan

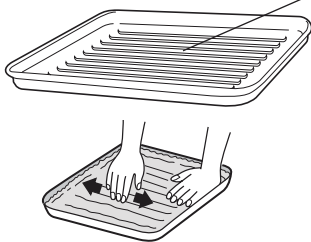

- The baking pan has a grooved surface for warming cold fried food efficiently. (The food might get groove patterns on its bottom.)
- It is good practice to put a sheet of aluminum foil on the baking pan to prevent stains.
- It is advisable to put a sheet of aluminum foil on the baking pan, pressing it with fingers along the grooves to ensure that frozen pizza or cold fried food can be crispy cooked.

Note

- It smells when using the product initially, but it won't smell after repeated using.

Lighting (near-infrared ray heater serves also as lighting.)

- Press the light button to turn on the near-infrared ray heater to brighten the interior of the toaster oven so that you can check the food. The heater will automatically turn off after a certain time.
- The length of time the near-infrared ray heater is kept on varies with the heating condition.
- You cannot turn off the lighting manually.
- Do not press the light button successively.
(The temperature inside the toaster oven will rise which will affect the cooking result.)

Power Off/On

- Press to turn on the toaster oven (lamp comes on).
- Press to turn off the toaster oven during operation (lamp goes out).
- Press after use (lamp goes out).



Cooking using automatic cooking keys (Operating procedure)

Preparations

- ① Insert the power plug into the wall outlet.
- ② Put the food inside the toaster oven.

1  Press [Power Off/On] (Red power lamp comes on.)

2 Press any of the automatic cooking keys.

3 - Darkness + Within 30 seconds, use the keys to adjust the color of browning.

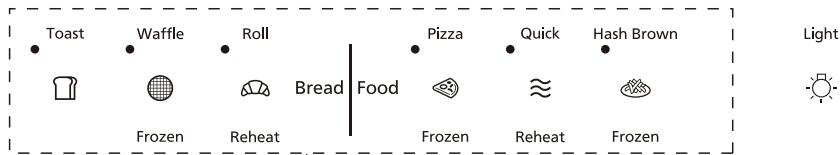
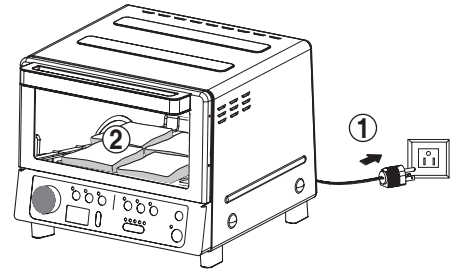

2

- Darkness +

1 

3

How to set the color of browning (Using the darkness control)

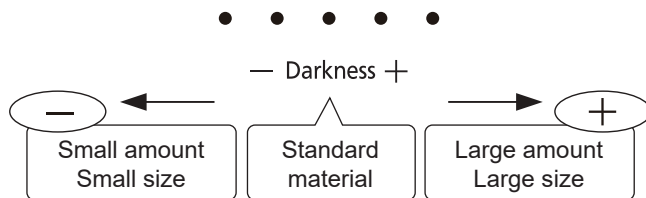

- Lighting of the lamps occur in intervals every time the button is pressed.
- The color of browning varies with the type and quantity of food and the size (weight) of each piece.
- Once the toaster oven is set to a color of browning, the next round of cooking will be performed at this setting.
- ※ The setting stored in memory will be lost if the power plug is removed.
- The color of browning will be set to medium when the power is turned on.

Cooking starts and the standard cooking time is displayed.



※ The displayed time counts down in increments of 0.5 minutes during cooking.

Note: For a while after cooking starts, the cooking time blinks. During this time, the baking time is checked. When the cooking time is confirmed, the displayed time stays on.



When cooking is finished, the buzzer sounds and the power is automatically turned off.

Take out the food with a pot holder (oven mitt).

• After use:

 Turn off unit by pressing the power button. The lamp goes out. Remove the power plug.

Toast

**Bread can be toasted to your desired color of browning.****(1–4 slices)****How to place food inside**

If you want to toast, place it at the center of wire rack.

Cooking note:

- The color of browning varies with type, size and thickness of bread.
- Bread containing a lot of sugar will brown darker. Set the level to the Light side.
- The surface of a thick slice of bread will brown a little darker.
- Standard cooking time: 2–3 min.
* Cooking time may vary according to darkness control setting.

Frozen Waffle

**Frozen bread can also be toasted to your desired color of browning.****(1–4 slices)****How to place food inside**

Remove frost from the surface of frozen bread and place it on the wire rack.

Cooking note:

- The color of browning varies with the type, size and thickness of bread. In addition, the inside of bread might not heat enough in some cases.
- The cooking of frozen bread takes time because the toaster oven defrosts frozen bread by turning the heater on and off repeatedly.
- The toaster oven performs optimal heating. It might take longer when the color of browning is set to Dark than when set to Light.
- When cooking bread containing a lot of sugar, set to the Light side.
- Standard cooking time: 4–5 min.
* Cooking time may vary according to darkness control setting.

Reheat Roll

**Rolls can be reheated without browning.****(1–4 pieces)****Cooking note:**

- When cooking bread containing a lot of sugar, set the level of browning to the Light side.
- Use the timer when warming stuffed or cooked bread such as hamburgers or the like.
- Standard cooking time: 2–3 min.
* Cooking time may vary according to darkness control setting.

Frozen Pizza

**Baking pizza up to 22.5cm (9 inches) in diameter.****(12.5-22.5cm) (5–9 inches)****How to place food inside**

Place aluminum foil on the baking pan. (See page 9.)
Remove frost from the surface of the pizza and place the frozen pizza on the baking pan.
Place the baking pan inside the toaster oven.

Cooking note:

- If cooking a large pizza, the side closer to the door might not bake enough. Make sure to put it toward the far end.
- Standard cooking time: 12–14 min.
* Cooking time may vary according to darkness control setting.

Reheat Quick



Warming fried food.

How to place food inside

Place aluminum foil on the baking pan.
(See page 9.)
Place cold fried food on the baking pan
and place it inside the toaster oven.

Cooking note:

- The inside of chilled fries might not be heated enough.
Provide additional heating. (See page 13.)
 - Standard cooking time: 5-7 min.
*Cooking time may vary according to darkness control setting.
-

Frozen Hash Browns



(Up to baking pan range)

Baking hash browns.

How to place food inside

Remove frost from the surface of the hash
browns.
Place onto the baking pan and keep proper
space between them, otherwise, they may
swell too much or sag when heated.

Cooking note:

- Standard cooking time: 4-6 min.
*Cooking time may vary according to darkness control setting.
-

Note

- The heater might stay off for a few minutes.
This is not a malfunction. In particular, when the toaster oven is used immediately after high-temperature cooking, the heater might stay off for about 3 minutes.
- If you adjust the color of browning to the light side, the cooking might end as soon as the time interval is established.

Common to 6 automatic cooking menus

- **To change the menus or the color of browning:**

- The color of browning can be changed if it is within 30 seconds after the automatic cooking key is pressed. You cannot change the color of browning if 30 seconds have elapsed.
- If 30 seconds have elapsed or if you want to change the menu press the power button. The lamp goes out. Start over again from the first step of the operating procedure. (See page 10.)

- **To stop the cooking halfway:**

Press the power button. The lamp goes out.

- **To provide additional heating:**

When the color of browning is lighter than you expected, or when the food was not heated enough.

- Press the same automatic cooking key you pressed in step 2 of the operating procedure. (See page 10.)
- Stand by the toaster oven to watch how the food is heated. Press power button when necessary to stop cooking. The lamp goes out.

- **To continue cooking in succession:**

Set the toaster oven, starting with step 2 (See page 10.) of the operating procedure.

- * The food might not be browned properly compared with the first time or the inside of food might not be heated enough. It is advisable to open the door and keep it open for a while to cool down the inside of the toaster oven before starting cooking again.

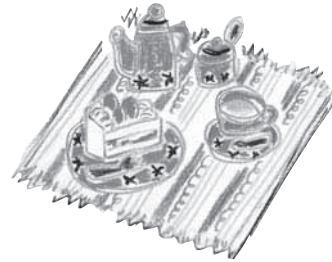

Cooking using the timer (Operating procedure)

Preparations

- ① Insert the power plug into the wall outlet.
- ② Place the food at the center inside the toaster oven.
- Place large food such as pizzas or cakes, or multiple food items such as cookies, at a position toward the far end, because those at the near end might not bake enough.

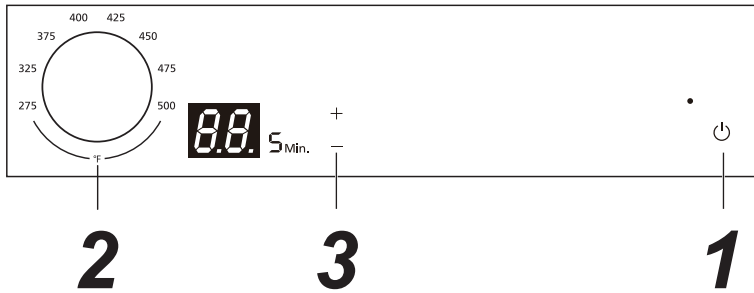
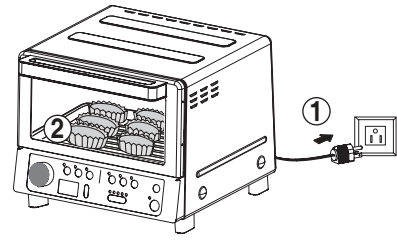

1 • Press [Power Off/On].

■ Power lamp comes on.



2 Select the cooking temperature.

■ Adjust the cooking temperature according to the recipe. (See page 16.)

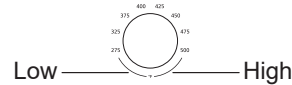

3 Set the timer.

■ Adjust the cooking time according to the recipe. (See page 16.)

As soon as the key is pressed, cooking starts.

The time on display increases (0→0.5→1)



The time on display decreases (0→25→24)



The set interval counts down in 0.5 minutes.

When the set interval is up, the buzzer sounds and the heater is automatically turned off.

- You can set the cooking time up to 10 min. in increments of 0.5 min. You can set up to 25 min. but in increments of one min. after 10 min.
- Press and hold down the key to increase or decrease the number rapidly.
- When the timer is set to "0" during cooking, the toaster oven will automatically turn off in 3 seconds.

Take the food out from the toaster oven using a pot holder.

* You can change the cooking temperature and the set the time freely during cooking.

- To stop the cooking halfway
Press the Power Off/On. (The heater lamp goes out.)
- To continue cooking in succession
Set the toaster oven, repeating with step 2 of the operating procedure.
- After use
Press the Power Off/On. The red lamp goes out. Remove the power plug.

Points for cooking with timer

Cooking time

- There is no need for preheating.
- The standard time varies with the temperature, quality, quantity of food and material of the cooking tray. Adjust properly by watching how the food is heated.
- If it takes more than 25 minutes to cook food, set the temperature and timer again, checking the result from time to time.
- If you cook in succession, the food might not brown enough or the inside might not heat properly.
- It is advisable to open the door and keep it open for a while to cool down the inside of the toaster oven, before starting the cooking again.
- If the food is not sufficiently heated, use the timer to heat it further, checking the result from time to time.
- * In particular, when baking cakes, cool down the inside of the toaster oven before cooking.

Cooking temperature

- If food is heated at the same temperature as used for a large oven, it might bake too much because of the difference in the interior size. Adjust the temperature properly watching how the food is heated.
- For food that has been cooked using a toaster oven without temperature control function, set the cooking temperature to 475 °F–500 °F (246 °C–260 °C) and use the timer, cook and watch the result of baking.

When baking commercial frozen food

- Use the frozen food key for the toaster oven.
- Do not rely too much on the power level and refer cooking time written on the package.

When baking tall food items such as cakes

- Any tall food is browned easily. When the food is browned properly, cover it with a foil before baking further.
- Cut a sheet of aluminum foil into a size a little larger than the mold and use it, because large pieces of foil make it difficult to bake the food properly.

Baking mold for cakes

- Avoid using molds made of porcelain or heat-resistant glass, or those with a metal hook.

Important

- Do not try to bake meat or fish which oozes oil without wrapping. When baking meat or fish, wrap it in a foil to prevent oil from splashing, and put it on the baking pan.
- Do not use the toaster oven for steaming.
(Steam will cause malfunction of the toaster oven.)
- Do not use parchment paper or cooking sheeting other than for putting it under cake molds.
Cut away excess parchment paper or cooking sheeting from the cake molds.
(They might catch fire when in contact with the heater.)
- Do not use paper baking molds for cake mix.
(There is a danger of fire.)
- When cooking with foil, such as when baking cakes or large potatoes, use caution to prevent the foil from coming in contact with the heater.
(The foil might melt away and adhere to the surface of the heater, causing malfunction of the toaster oven.)

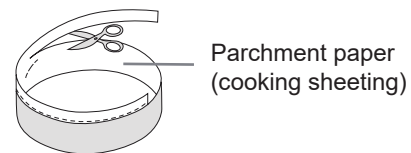

Cooking guide

Automatic cooking Cooking results may vary. Adjust darkness control to your individual preferences.

Key	Recipes	Quantity	Baking pan	Standard cooking time	Note
Toast	Bread	1-4 slices	—	2-3 min.	Place sliced surface up.
	Bagels		—		
Frozen Waffle	Bread, Frozen	1-4 slices	—	4-5 min.	Place sliced surface up.
	Bagels, Frozen		—		
	Garlic Bread, Frozen		○		
	Waffles, Frozen		—		
	French Toast, Frozen		—		
Reheat Roll	Hot Dog Rolls	1-4 Rolls	—	2-3 min.	
	Hamburger Buns	1-4 Buns	—		
	Cinnamon Rolls	1-4 Rolls	○		
Frozen Pizza	Frozen Pizza	Up to 9 inches	○	12-14 min.	
	Frozen Chicken Nuggets	Up to baking pan range	○		
	Frozen Fish Sticks		○		
	Frozen Fish Fillets		○		
Reheat Quick	Egg Rolls	Up to baking pan range	○	5-7 min.	
	Chicken Wings		○		
	Pizza		○		
	Hot Dogs		○		
	Hot Sandwiches		○		
Frozen Hash Browns	Frozen Hash Browns	Up to baking pan range	○	4-6 min.	
	Frozen French Fries		○		
	Frozen Onion Rings		○		

- *1 The color of browning varies depending on the type of toast. Adjust the darkness control according to the condition of the ingredients.
 *2 Depending on the different quantity of ingredients, the ingredients may not be sufficiently heated. Reheat according to the condition of the ingredients.

Cooking using the timer Cooking results may vary. Adjust temperature and time settings to your individual preferences.

Recipes	Temperature	Time	Note
Cookies (Refrigerated Dough)	375 °F (191 °C)	10-20 min.	Set the temperature according to the instruction on the food package to avoid burning. No preheat necessary.
Cinnamon Rolls (Refrigerated Dough)	325 °F (163 °C)	17-22 min.	
Muffins	325 °F (163 °C)	10-15 min.	

* If it takes more than 25 minutes to cook a food item, set the temperature and timer again by watching the result of heating.

Maintenance: Remove the power plug and make sure the toaster oven is cold.

Wipe clean the exterior and interior of the toaster oven with a well-wrung towel.

- * Do not use benzene, thinner or polishing powder; otherwise, the surface will be damaged.
- When the toaster oven is severely stained or dirty, wipe with a towel saturated with a diluted solution of neutral kitchen detergent.
- When cleaning the bottom of the interior, remove the wire rack and crumb tray.
- * Do not touch the heaters to avoid damaging them.

Crumb tray, baking pan, wire rack (See page 9 for how to remove.)

Wash them with a diluted solution of neutral kitchen detergent and sponge and dry well.

- * Do not use metal brush or nylon brush.
(The surfaces of the trays or gridiron might be damaged.)
- * In particular, wash the crumb tray frequently.
Do not use a dirty tray; the baked may burn or might result in a lighter color of browning on the lower surface of food.
- * Do not wash the tray in the dishwasher.
(To avoid discoloration of the tray)

Troubleshooting

If...	Possible cause and how to fix
The toaster oven cannot be turned on when the power button is pressed.	Check to see if the power plug is securely inserted into the wall outlet.
The automatic cooking function does not function properly.	The plug has been disconnected. • Read "Cooking using automatic cooking keys". (See pages 10 to 13.)
The heater turns on and off.	It is not a malfunction. The heater is automatically turned on and off by the microprocessor to control the cooking temperature.
The heater turns off during cooking.	It is not a malfunction. The heater may stay off for about 3 minutes if low-temperature cooking is carried out immediately after high-temperature cooking.
Light color of browning on the bottom surface of bread.	Check the crumb tray if properly cleaned. • Clean the crumb tray.

- **H1** appears on display (self-check function):

Please contact service center listed in the warranty.

Any other servicing should be performed by an authorized service representative.

- **H2** appears on display (self-check function):

When the knob is abnormal, "H2" will be prompted.

Turn the knob to align with the temperature scale and a sound is heard.

Specifications

Power Supply	120 V ~ 60 Hz	
Power consumpt	1300 W	
Temperature control (approx.)	275 – 500 °F (135 – 260 °C)	
Timer	0.5 –25 min	
Dimensions (W x D x H) (approx.)	Outer dimensions	33.1 x 30.5 x 26.3 cm (13 x 12 x 10.4 inches)
	Inner dimensions	26.0 x 25.0 x 10.5 cm (10.2 x 9.8 x 4.1 inches)
	Baking pan (inner dimensions)	23.5 x 23.5 x 1.8 cm (9.3 x 9.3 x 0.7 inches)
Mass (approx.)	7.7 lbs (3.5 kg)	
Power Cord (approx.)	93 cm (36.6 inches)	

- The power consumption is about 0.4 W when the power plug is inserted into the wall outlet without the Power button pressed.

Limited Warranty (ONLY FOR U.S.A.)

Panasonic Products Limited Warranty

Limited Warranty Coverage (For USA Only)

If your product does not work properly because of a defect in materials or workmanship, Panasonic Consumer Electronics Company (referred to as "the warrantor") will, for the length of the period indicated on the chart below, which starts with the date of original purchase ("warranty period"), at its option either (a) repair your product with new or refurbished parts, (b) replace it with a new or a refurbished equivalent value product, or (c) refund your purchase price. The decision to repair, replace or refund will be made by the warrantor.

Product or Part Name	Labor	Parts
Kitchen Appliances	1 yr.	1 yr.
Large Capacity Rice Cookers (SR-42 series)	6 Months	6 Months

During the "Labor" warranty period there will be no charge for labor. During the "Parts" warranty period, there will be no charge for parts. This warranty only applies to products purchased and serviced in the United States. This warranty is extended only to the original purchaser of a new product which was not sold "as is".

Mail-In Service – Online or Telephone Repair Request

Online Repair Request

To submit a new repair request, and for quick repair status visit our Web Site at: <http://shop.panasonic.com/support>

When shipping the unit, carefully pack and send it prepaid in the original (or supplied) carton. Include a letter detailing the complaint along with the bill of sales and provide a daytime phone number where you can be reached. A valid registered receipt is required under the Limited Warranty.

When shipping Lithium Ion batteries please visit our web site at <http://shop.panasonic.com/support> as Panasonic is committed to providing the most up to date information.

IF REPAIR IS NEEDED DURING THE WARRANTY PERIOD, THE PURCHASER WILL BE REQUIRED TO FURNISH A SALES RECEIPT/ PROOF OF PURCHASE INDICATING DATE OF PURCHASE, AMOUNT PAID AND PLACE OF PURCHASE. CUSTOMER WILL BE CHARGED FOR THE REPAIR OF ANY UNIT RECEIVED WITHOUT SUCH PROOF OF PURCHASE.

Limited Warranty Limits And Exclusions

This warranty ONLY COVERS failures due to defects in materials or workmanship, and DOES NOT COVER glass, plastic parts, temperature probes (if included) and normal wear and tear or cosmetic damage. The warranty ALSO DOES NOT COVER damages which occurred in shipment, or failures which are caused by products not supplied by the warrantor, or failures which result from accidents, misuse, abuse, neglect, bug infestation, mishandling, misapplication, alteration, faulty installation, set-up adjustments, maladjustment of consumer controls, improper maintenance, power line surge, lightning damage, modification, or commercial use (such as in a hotel, office, restaurant, or other business), rental use of the product, service by anyone other than a factory service center or other authorized servicer, or damage that is attributable to acts of God.

THERE ARE NO EXPRESS WARRANTIES EXCEPT AS LISTED UNDER "LIMITED WARRANTY COVERAGE".

THE WARRANTOR IS NOT LIABLE FOR INCIDENTAL OR CONSEQUENTIAL DAMAGES RESULTING FROM THE USE OF THIS PRODUCT, OR ARISING OUT OF ANY BREACH OF THIS WARRANTY.

(As examples, this excludes damages for lost time, travel to and from the servicer, loss of or damage to media or images, data or other memory or recorded content. The items listed are not exclusive, but for illustration only.)

ALL EXPRESS AND IMPLIED WARRANTIES, INCLUDING THE WARRANTY OF MERCHANTABILITY, ARE LIMITED TO THE PERIOD OF THE LIMITED WARRANTY.

Some states do not allow the exclusion or limitation of incidental or consequential damages, or limitations on how long an implied warranty lasts, so the exclusions may not apply to you.

This warranty gives you specific legal rights and you may also have other rights which vary from state to state. If a problem with this product develops during or after the warranty period, you may contact your dealer or Service Center. If the problem is not handled to your satisfaction, then write to:

Panasonic Corporation of North America
Consumer Affairs Department
Two Riverfront Plaza
Newark NJ 07102-5490

PARTS AND SERVICE, WHICH ARE NOT COVERED BY THIS LIMITED WARRANTY, ARE YOUR RESPONSIBILITY.

Shop
Accessories!
for all your Panasonic gear

Go to

<http://shop.panasonic.com/support>

Get everything you need to get the most out of your Panasonic products
Accessories & Parts for your Camera, Phone, A/V products, TV, Computers & Networking, Personal Care, Home Appliances, Headphones, Batteries, Backup Chargers & more...

Customer Services Directory

For Product Information, Operating Assistance, Parts, Owner's Manuals, Dealer and Service info go to <http://shop.panasonic.com/support>

For the hearing or speech impaired TTY: 1- 877-833-8855

As of February 2024

Memo

Panasonic Corporation of North America

Two Riverfront Plaza, Newark, NJ 07102-5490

www.panasonic.com

© Panasonic Manufacturing (Xiamen) Co.,Ltd. 2024

Printed in China