

# Panasonic®

## Operating Instructions

**Air Fry Toaster Oven (Household Use)**

Model No. **NB-G210**  
**NB-G211**  
**NB-G212**

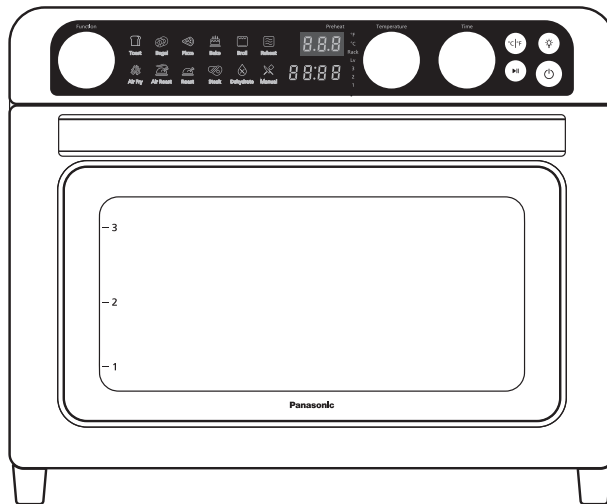

Thank you for purchasing this Panasonic product.

- This product is intended for household use only.
- Please read these instructions thoroughly to use product correctly and safely.
- Please retain this Operating Instructions for future use.
- Panasonic will not accept any liability if the appliance is subject to improper use, or failure to comply with these instructions.

## Contents

IMPORTANT SAFEGUARDS	3
Safety Precautions	5
Part Names and Instructions	8
How to use	10
Recipe	12
Cleaning & Care	14
Troubleshooting	15
Specifications	16
Limited Warranty	17

# IMPORTANT SAFEGUARDS

The following basic safety precautions apply when using electrical appliances:

1. Read all instructions.
2. Do not touch hot surfaces. Use handles or knobs.
3. To protect against electrical shock do not immerse cord, plugs, or appliance in water or other liquid.
4. Close supervision is necessary when any appliance is used by or near children.
5. Unplug from outlet when not in use and before cleaning. Allow to cool before putting on or taking off parts.
6. Do not operate any appliance with a damaged cord or plug or after the appliance malfunctions or has been damaged in any manner. Return appliance to the nearest authorized service facility for examination, repair, or adjustment. (See P.17)
7. The use of accessory attachments not recommended by the appliance manufacturer may cause injuries.
8. Do not use outdoors.
9. Do not let cord hang over edge of a table or counter, or touch hot surfaces.
10. Do not place on or near a hot gas or electric burner, or in a heated oven.
11. Extreme caution must be used when moving an appliance containing hot oil or other hot liquids.
12. Always attach plug to appliance first, then plug cord into the wall outlet. To disconnect, turn any control to "off" , then remove plug from wall outlet.
13. Do not use appliance for other than intended use.
14. Oversize foods or metal utensils must not be inserted in the appliance as they may create a fire or risk of electric shock.
15. A fire may occur if the oven is covered or touching flammable material, including curtains, draperies, walls, and the like, when in operation. Do not store any item on top of the appliance when in operation.
16. Do not clean with metal scouring pads. Pieces can break off the pad and touch electrical parts involving a risk of electric shock.
17. Extreme caution should be exercised when using containers constructed of other than metal or glass.
18. Replace cardboard lids on food containers with aluminum foil as cardboard lids may burn. When using aluminum foil, keep it from touching heating elements.
19. Do not store any materials, other than manufacturer's recommended accessories, in this oven when not in use.

# IMPORTANT SAFEGUARDS

20. Do not place any of the following materials in the oven: paper, cardboard, plastic and the like.
21. Do not cover crumb tray or any part of the oven with metal foil. This will cause overheating of the oven.
22. Use extreme caution when removing tray or disposing of hot grease.
23. To turn off the appliance, press the power button. The display window will turn off and disable any cooking function.

# SAVE THESE INSTRUCTIONS

A short power-supply cord is provided to reduce the risk resulting from becoming entangled in or tripping over a longer cord.



- Do not use a longer detachable power-supply cord or extension cord.

# Safety Precautions



Please make sure to follow these instructions.

In order to prevent accidents or injuries to the user, other people, and damage to property, please follow the instructions below.

■ The following chart indicates the degree of damage caused by improper operation.

 <b>WARNING:</b>	Indicates potential hazard that could result in serious injury or death.
 <b>CAUTION:</b>	Indicates potential hazard that could result in minor injury or property damage.

■ The symbols are classified and explained as follows:

	This symbol indicates prohibition.
	This symbol indicates requirement that must be followed.

## **WARNING**

To reduce the risk of electric shock, burns, fire, or injury to persons:



- Do not disassemble, repair or modify this appliance.
  - Contact Service Center for inspection or repair.
- Do not damage the power cord or power plug.  
The following actions are strictly prohibited:  
Modifying, touching on or placing near heating elements or hot surfaces, bending, twisting, pulling, hanging / pulling over sharp edges, putting heavy objects on top, bundling the power cord or carrying the appliance by the power cord.
- Do not use the appliance if the power cord or power plug is damaged or the power plug is loosely connected to the outlet.
  - If the power cord is damaged, it must be replaced by the manufacturer, its service center or similarly qualified person in order to avoid a hazard.
  - Insert the power plug firmly.
- Do not plug or unplug the power plug with wet hands.
- Do not immerse the appliance, power cord and power plug in water, or splash them with water and/or any liquid.
- Do not let the power cord hang over the edge of table or worktop, or touch hot surfaces.
- Do not allow children to use the oven. Do not use the oven within the reach of children.
- Do not allow infants and children to play with packaging material.
- Do not use this appliance near any combustible materials or under the curtains.

# Safety Precautions

Please make sure to follow these instructions.

## WARNING

### To reduce the risk of electric shock, burns, fire, or injury to persons:

-  ● This appliance is not intended for use by persons (including children) with reduced physical, sensory or mental capabilities, or lack of experience and knowledge, unless they have been given supervision or instruction concerning use of the appliance by a person responsible for their safety. Children should be supervised to ensure that they do not play with the appliance. Keep the appliance and its power cord out of reach of children.
- Discontinue using the appliance immediately and unplug in the unlikely event that this appliance stops working properly.  
e.g. for abnormal occurrences or breaking down
  - The power plug or the power cord become abnormally hot.
  - The appliance power fails.
  - The main unit is deformed, has visible damage or is abnormally hot.
  - There is an unpleasant odor.
  - There is abnormal turning noise while in use.
  - There is another abnormality or failure.→ Contact Service Center for inspection or repair.
- Make sure the voltage indicated on the label of the appliance is the same as your local supply. Also avoid plugging other devices into the same outlet to prevent electrical overloading. If you connect a number of appliances to the same outlet, ensure the total wattage does not exceed the rated wattage of the outlet.
- Insert the power plug firmly.
- Dust off the power plug regularly.  
→ Unplug the power plug, and wipe with a dry cloth.

## CAUTION

### To reduce the risk of electric shock, burns, fire, or injury to persons:

-  ● Never leave the appliance unattended during operation.
- Do not touch hot surfaces, such as the top of the oven body, control panel, metal surface of the door frame, the Air fryer basket, baking pan, crumb tray, wire rack and the pizza stone (only for NB-G212) while the oven is in use or just after use. The oven is easy to become hot during use, and the surface temperature during use is very high. Let it cool down before cleaning after use.
- Do not touch the appliance with wet hands.
- Do not touch, block or cover the appliance during use.
- Do not put or insert flammable materials on / under the oven.
- Do not use a knife or sharp tool, as these may cause damage to the heating elements.
- Do not directly heat cans or glass bottles.
- Do not use the appliance near wall, furniture, or in enclosed spaces such as a built-in cupboard.



## CAUTION

To reduce the risk of electric shock, burns, fire, or injury to persons:



- Do not use the appliance on following places.
  - On uneven surfaces, on carpet, non-heat-resistant surfaces or tablecloths etc.
  - Places where it may be splashed with water or near a heat source.
  - Near any open water sources such as sinks, or the like.

→ Place on a flat, stable surface. To have sufficient air flow, i.e. 10 cm (4")\*<sup>1</sup> at one side, 30 cm (12")\*<sup>1</sup> clear over the top, 10 cm (4")\*<sup>1</sup> at the rear.

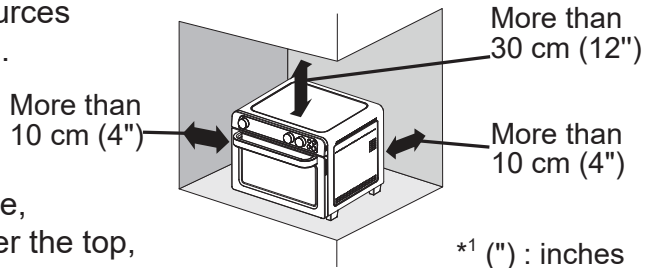

- Do not use an external timer etc.
  - This appliance is not intended to be operated by means of an external timer or separate remote control system.
- Do not open the door when the food generates smoke or catches fire. (Before the fire goes out.)
  - Turn off the power and remove the power plug immediately.
  - Do not extinguish the fire with water.
- Do not place oil in the baking pan for heating.



- To ensure continued protection against risk of electric shock, connect to properly grounded outlets only.
- Always disconnect the appliance from the supply if it is left unattended and before assembling, disassembling, moving or cleaning.
- Ensure to operate and rest the appliance as stated on specification table. (See P.16 "Specifications")
- Ensure to clean the appliance especially surfaces in contact with food after use. (See P.14 "Cleaning & Care")
- Make sure the crumb tray is clean and set correctly when using the appliance.
- Beware not to be tripped over or get caught in the power cord while in use.
- Make sure to hold the power plug when unplugging it. Never pull on the power cord.
- Be sure to set the wire rack into the middle position when using the menus of "Toast" and "Bagel".
- To prevent dropping ingredients such as cheese, butter or cooking batter onto the lower heater when using the wire rack, place aluminum foil or the like over the wire rack, then place the food.
- This product is intended for household use only.



This symbol on the products indicates "Hot surface and should not be touched without caution".

# Part Names and Instructions

## Main unit & Accessories

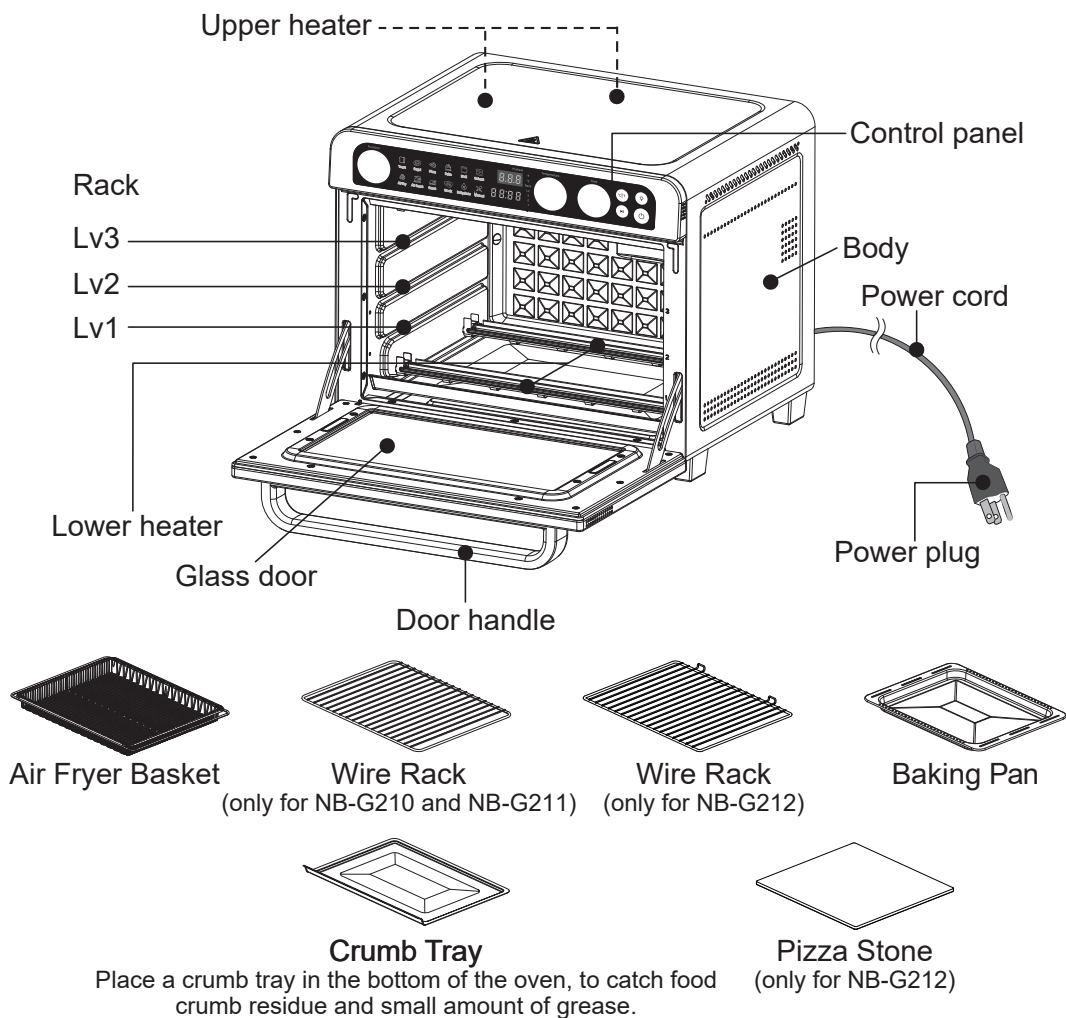





## Before use

- Dispose of the packaging materials (of the main unit and all accessories, including Air fryer basket, baking pan, crumb tray, wire rack, and pizza stone), and wash the main unit / accessories when using for the first time. (See P.14)
- Clean the main unit / accessories when you have not used for a long time.
- The first time you use it, use the air frying function first for 10-15 minutes of empty heating. It is a normal phenomenon that the product may emit a strange odor.
- It is normal for the product to make a sound during empty heating for the first time.
- Smoke and odor will be released when the product is heated empty. Please open the door of the product to let the smoke dissipate easily. Once the smoke and odor are released, they will not be emitted when the product is used.
- After empty heating, wait until the product has cooled down before using it again.

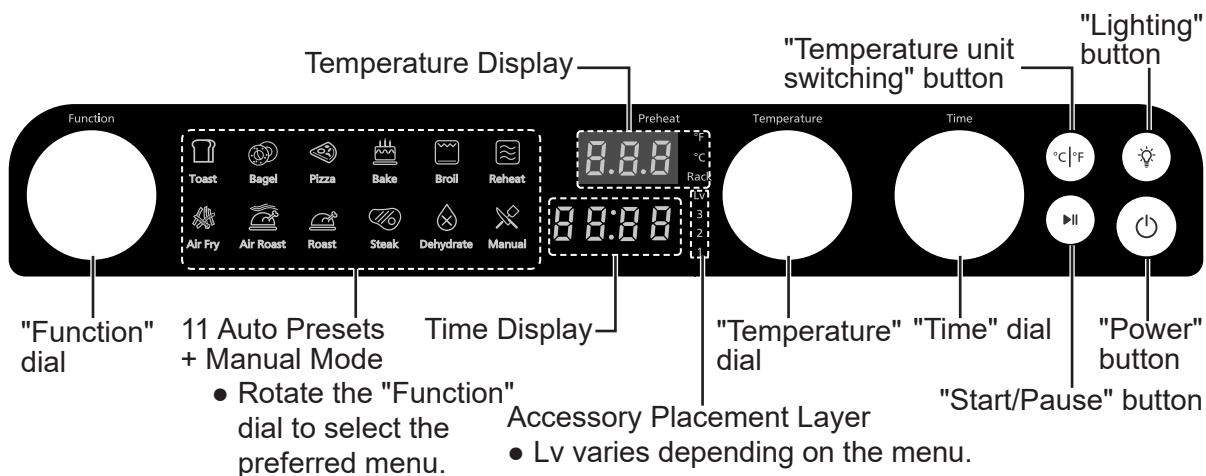



## Control Panel



Button Name	Function or Display Description
 "Power" button	<ol style="list-style-type: none"> <li>1. After the power supply is connected and the control panel is fully illuminated, the temperature and time display goes out, the menu is fully illuminated and the product enters the standby mode. If there is no operation within 10 minutes, the product enters the shutdown mode.</li> <li>2. In any mode, press the "Power" button to enter the shutdown mode.</li> <li>3. In the shutdown mode, press the "Power" button to enter the standby mode.</li> </ol>
 "Start/Pause" button	<ol style="list-style-type: none"> <li>1. After selecting the menu, press the "Start/Pause" button to start preheating or cooking. Press the "Start/Pause" button again to pause preheating or cooking.</li> <li>2. It is not effective to press the "Start/Pause" button in standby mode.</li> <li>3. When preheating is completed, press the "Start/Pause" button to start cooking.</li> <li>4. If there is no operation during pause within 10 minutes, the product will enter Shutdown mode.</li> </ol>
 "Lighting" button	<ol style="list-style-type: none"> <li>1. The "Lighting" button is the switch to control the oven light. After the power supply is connected, press this button under the power-on state, and you can light up or extinguish the oven light at any time.</li> <li>2. The light will turn on during the cooking or pause period. If the light is OFF during cooking, it will remain OFF during pause. If the menu contains preheating, the light will turn ON when the preheating is completed.</li> </ol>
Temperature  "Temperature" dial	<ol style="list-style-type: none"> <li>1. You can rotate the "Temperature" dial during setup. The Temperature character is always ON during setup and it flashes when you stop rotating. The temperature setting can be cycled.</li> <li>2. You can also rotate the "Temperature" dial during the cooking process. When you stop rotating, the temperature character will blink and then light up.</li> <li>3. The temperature setting can be increased or decreased by 5 °F.</li> </ol>

# Part Names and Instructions

## Control Panel

Button Name	Function or Display Description
<p>Time</p>  <p>"Time" dial</p>	<ol style="list-style-type: none"><li>1.You can rotate the "Time" dial during setup. The Time character is always ON during setup and it flashes when you stop rotating. The time setting can be cycled.</li><li>2.You can also rotate the "Time" dial during the cooking process. When you stop rotating, the time character will blink and then light up.</li><li>3.When you rotate in fast or slow motion, the time increase or decrease will vary depending on the menu. (See P.13)</li></ol>
<p>Function</p>  <p>"Function" dial</p>	<ol style="list-style-type: none"><li>1.After entering the standby mode, you can select the preferred menu by rotating the "Function" dial. The function setting can be cycled.</li><li>2.The selected menu blinks and other menus are always illuminated.</li></ol>
<p>°C   °F</p> <p>"Temperature unit switching" button</p>	Switch between °C and °F on the display.

## How to use

- Install the Air fryer basket, baking pan, wire rack or pizza stone into the correct position. (See P.12) Put the food inside unit.
- When using a pizza stone, preheat the stone well and avoid cooking oily foods and meats directly on it.

### 1 Insert the power plug into the outlet and the product will enter Standby mode.



- In any mode, press the "Power" button to enter the shutdown mode.
- In the shutdown mode, press the "Power" button to enter the standby mode.

### 2 Select menu

Function



- Rotate the "Function" dial continuously to select the desired menu.

### 3 Set cooking temperature

Temperature



- Rotate the "Temperature" dial to set the appropriate cooking temperature. It is recommended to use the default temperature.

## 4 Set cooking time



- Rotate the "Time" dial to set the appropriate cooking time. It is recommended to use the default time.

## 5 Preheat (only required for preheat menu, skip this step if without preheat menu (See P.13))



Press the "Start/Pause" button to start preheating.

- During preheating, the display shows the preheating temperature of the menu.
- The display time shows a dynamic cycle of "---".
- During preheating, the temperature can be set freely according to the properties of the food and personal preference.
- When the preheating temperature is reached, beep sounds will be heard, indicating that the preheating is completed. When the preheating is completed, the light will turn ON and the "Preheat", temperature and time displays on the display will blink.
- After the preheating is completed, the product will enter Standby mode without any operation within 10 minutes.

## 6 Start cooking



Press the "Start/Pause" button to start cooking.

The ":" symbol of the time display is blinking, the menu, temperature and time are always illuminated and the time is counting down.

- During the cooking process, the temperature and time can be set freely according to the properties of the food and your personal preferences.
- If you want to pause, press the "Start/Pause" button. You can also set the temperature and time during the pause.
- When the cooking is finished, the product enters the standby mode.

## 7 Take out the food when you hear beep sounds

- Use oven mitts to remove the air fryer basket, wire rack, baking pan or pizza stone. (Use your dry oven mitts.)

### Note

- Continuous cooking or main unit still having residual heat: Even using auto mode, cooking condition will not be the same as the first time.
- The white smoke may appear if the food contains a lot of moisture or cooking amount is large. It is the moisture from the food and is not abnormal.
- Do not open the door during cooking. (Cooking will be uneven.)
- Do not pour water or cold liquid on the glass window when it is hot. (The glass might break.)

# Recipe

Function	Menu	Quantity	Accessories	Layer of placement	Time	Adjustment range	Temperature (°C)
Toast	Thick Sliced Toast	4 slices	Wire Rack	2	6 min	1-12 min	220
Bagel	Bagel	2 cross-cut halves (about 250 g)	Wire Rack	2	10 min	1-20 min	180
Pizza	Pizza	12 inches (Approx. 435 g)	Wire Rack or Wire Rack + Pizza Stone (Pizza Stone only for G212)	2	12 min	1-24 min	190
Bake	Cookies	16 pcs	Baking Pan	2	15 min	1-30 min	175
Broil	Salmon Fillet	2 pcs (Approx. 600 g)	Baking Pan	2	30 min	1-60 min	200
	Macaroni Cheese	1 box of macaroni and cheese (about 200 g)			12 min		
Reheat	Fried Chicken Leg	3 pcs	Baking Pan	2	12 min	1-24 min	160
Air Fry	French Fries	Approx. 350 g	Middle Air Fryer Basket (for food) Lower Baking Pan (for grease)	2	12 min	1-36 min	230
	Chicken Nugget				12 min		
	Chicken Wing	12 pcs (Approx. 420 g)			15 min		
	Chicken Leg	12 pcs (Approx. 660 g)			18 min		
Air Roast	Grilled Vegetable	Approx. 450 g	Baking Pan	2	12 min	1-24 min	220
Roast	Grilled Chicken	Approx. 1.8 kg	Baking Pan	1	80 min	1 min-2 h 40 min	190
Steak	Steak	2 pcs (Approx. 500 g)	Baking Pan	2	18 min	1-36 min	230
Dehydrate	Dried Mango	Approx. 500 g	Air Fryer Basket	3	4 h	10 min-8 h	90
Manual	—	—	—	—	—	1 min-2 h	90

## Note

To avoid smoke or fire:

- Keep the ingredients and aluminum foil away from the heating tube.

Temperature (°F)	Adjustment range (°C)	Adjustment range (°F)	Time Setup Speed (Quick/Slow)	Preheating	Note
430	200-230	395-445	1 min	—	The color of browning varies with type, size, and thickness of bread.
355	160-200	320-395	1 min	—	1. Use halved bagels. 2. The color of browning varies with type, size, and thickness of bagel.
375	170-230	340-445	1 min	✓	1. Use frozen pizza. 2. The preset temperature and time values may vary depending on the toppings and crust type of the pizza. Adjust according to the actual situation. 3. If you are using a pizza stone, place it on a wire rack and preheat in the oven in Manual mode at 445 °F for 15 minutes, and then immediately use the Pizza mode. After preheating is complete, place the pizza on the pizza stone for cooking. 4. The recommended cooking time for microfrozen pizza is 8 minutes, and for handmade pizza is 8 minutes. If the color of browning needs adjusting, you can adjust the cooking time by yourself.
350	155-195	310-385	1 min	✓	The thickness is about 0.5 inch. Adjust the cooking time again if the thickness of the cookies is less than or more than 0.5 inch.
395	180-220	355-430	5 min / 1 min	—	1. Adjust the cooking time if you are using marinades that are easy to color, such as soy sauce, to avoid burning. 2. Add some milk to the macaroni and cheese, mix well. Sprinkle shredded cheese on the surface, and bake until the cheese melts on the surface.
320	140-180	285-355	1 min	—	1. If the reheating ingredients are different, you can also use Manual mode, and choose the right temperature and time for heating. 2. This refers to the reheating of refrigerated ingredients. If frozen ingredients are used, adjust the time accordingly or use Manual mode.
445	210-230	410-445	5 min / 1 min	✓	1. When heating meat, fish or other greasy foods, put the baking pan on the lower level to prevent the fat from dripping directly onto the heating tubes. 2. Adjust the cooking time if you are using marinades that are easy to color, such as soy sauce, to avoid burning.
430	200-230	395-445	1 min	✓	1. The preset temperature and time values may vary depending on the type and quantity of vegetable to be roasted. 2. Cut the vegetable to the appropriate size and drizzle with a good amount of olive oil to make them more evenly roasted.
375	170-210	340-410	10 min / 1 min	✓	Adjust the cooking time if you are using marinades that are easy to color, such as soy sauce, to avoid burning.
445	210-230	410-445	5 min / 1 min	✓	The thickness is about 0.8 inch. Adjust the cooking time again if the thickness of the steak is less than or more than 0.8 inch.
195	70-110	160-230	30 min / 10 min	—	Cut into strips of 0.4 inch thick and 0.8 inch wide. Try not to overlap, but turn them over as needed.
195	70-230	160-445	10 min / 1 min	—	

- Do not use parchment paper or cooking sheet other than for putting on to a baking pan.
- Do not use a cake pan made of paper.
- The preset temperature and time values may vary depending on the temperature, type, quantity or container of the ingredients. Adjust the values according to the actual cooking level.

# Cleaning & Care

- Before cleaning, unplug from outlet and allow the unit to completely cool.
  - Do not use benzine, thinner, alcohol, bleach, polishing powder, metal brush or nylon brush, otherwise the surface will be damaged.
  - After every use, clean the main unit and crumb tray thoroughly.
  - The aluminum base of the heating tube is sharp. Cleaning gloves are recommended when cleaning the interior.
  - The pizza stone is made of cordierite mixed with sintered mineral materials. Its porous structure is highly absorbent of water and oil. After using pizza stone to cook food, due to the differences in ingredients, the color may change to some degree. It is a normal phenomenon and does not affect its performance.
  - Pizza stone belongs to consumables. Long-term use will cause different degrees of appearance changes on the surface. This is a normal phenomenon.

## Exterior

- Wipe with a well-wrung cloth.

## Interior

- Wipe with a well-wrung cloth. When the interior is severely stained or dirty, wipe with a towel saturated with a diluted solution of a mild dishwashing liquid.
- Do not wipe the heating tubes to avoid damaging.

## Crumb tray

- Wash with diluted dish soap (neutral) and soft sponge. Dry it well and set it back to the main unit firmly.

## Air fryer basket/wire rack/baking pan

- Wash with diluted dish soap (neutral) and soft sponge. Dry it well.
- The baking pan is dishwasher safe. Do not use the dishwasher to clean this product and other accessories.
- Always use specific cleaners for dishwasher and drying.

## Pizza stone

- Make sure the pizza stone is completely cooled down before cleaning.
- Do not immerse the pizza stone in water.
- Do not use detergents, etc. It is recommended to clean it with water. After cleaning, bake it in the oven or stove for 30 minutes. Take out and store it in a ventilated, dry location. (Using without thoroughly drying may cause the risk of cracking, and the slate is susceptible to mold when wet.)
- Do not use sharp, rough tools to clean the pizza stone.

# Troubleshooting

Problems	Cause and solution
<p>The power indicator or display window does not turn on even though it is plugged in.</p>	<ul style="list-style-type: none"> <li>● The plug is not inserted properly. → Insert the power plug firmly into the outlet.</li> <li>● If the main unit is idle for more than 10 minutes, the power will be turned off automatically. → Press "Power" button to return to standby status. If power indicator does not turn on even after pressing, contact Service Center for inspection or repair. (See P.17)</li> </ul>
<p>Cooking does not complete even when the main unit has started.</p>	<ul style="list-style-type: none"> <li>● There is a problem with the main unit. → Contact Service Center for inspection or repair. (See P.17)</li> </ul>
<p>There is a burnt smell.</p>	<ul style="list-style-type: none"> <li>● The cooking time is too long. → Turn off the main unit.</li> <li>● The fats and gravy on the air fryer basket, wire rack, baking pan or the pizza stone may cause smoke during cooking, especially when using "Broil" menu. → Clean the air fryer basket, wire rack, baking pan or the pizza stone after every use.</li> <li>● There is dripping gravy, ingredients or crumbs on the crumb tray. → Clean the crumb tray.</li> </ul>
<p>Heater tubes turn off during cooking.</p>	<ul style="list-style-type: none"> <li>● The heater tubes turn on/off to control temperature. It is not a malfunction.</li> </ul>
<p>Smoke comes out.</p>	<ul style="list-style-type: none"> <li>● The fat from the food sticking to the heater may cause smoke during cooking, especially when using "Broil" menu. → Set lower temperature if necessary.</li> </ul>

Code	Root Cause Analysis	Solution
H01	This is malfunctioning.	Contact Service Center for inspection or repair.
H02		
H03		
H51		

# Specifications

<b>Power supply</b>		<b>120 V ~ 60 Hz</b>
<b>Power consumption</b>		<b>1800 W</b>
<b>Capacity (approximately)</b>		<b>0.99 CU FT / 28 L</b>
<b>Temperature setting of cavity center (approximately)</b>		<b>160-445 °F (70-230 °C)</b>
<b>Timer</b>		<b>1 min-6 h</b>
<b>Weight (approximately)</b>		<b>11.9 kg (26.2 lbs) (only for NB-G210 and NB-G211) 13.4 kg (29.5 lbs) (only for NB-G212)</b>
<b>Power cord length (approximately)</b>		<b>0.95 m (37.4 inches)</b>
<b>Size (approximately)</b>	<b>External dimension (W×D×H)</b>	<b>43.0 × 40.3 × 35.3 cm (16.9 × 15.8 × 13.9 inches)</b>
	<b>Internal dimension (W×D×H)</b>	<b>36.8 × 30.7 × 24.8 cm (14.4 × 12.1 × 9.7 inches)</b>
	<b>Air fryer basket (internal dimension) (W×D×H)</b>	<b>33.8 × 29.7 × 2 cm (13.3 × 11.6 × 0.8 inches)</b>
	<b>Wire rack (internal dimension) (W×D×H)</b>	<b>36.6 × 29.7 × 0.4 cm (14.4 × 11.6 × 0.15 inches) (only for NB-G210 and NB-G211) 36.6 × 29.8 × 1.5 cm (14.4 × 11.7 × 0.6 inches) (only for NB-G212)</b>
	<b>Baking pan (internal dimension) (W×D×H)</b>	<b>36.6 × 29.7 × 2.05 cm (14.4 × 11.6 × 0.8 inches)</b>
	<b>Pizza stone (internal dimension) (W×D×H)</b>	<b>30.2 × 30.2 × 1 cm (11.9 × 11.9 × 0.4 inches)</b>



# Limited Warranty (ONLY FOR U.S.A.)

## Panasonic Products Limited Warranty

### Limited Warranty Coverage (For USA Only)

If your product does not work properly because of a defect in materials or workmanship, Panasonic Consumer Electronics Company (referred to as "the warrantor") will, for the length of the period indicated on the chart below, which starts with the date of original purchase ("warranty period"), at its option either (a) repair your product with new or refurbished parts, (b) replace it with a new or a refurbished equivalent value product, or (c) refund your purchase price. The decision to repair, replace or refund will be made by the warrantor.

Product or Part Name	Labor	Parts
Kitchen Appliances	1 yr.	1 yr.
Large Capacity Rice Cookers (SR-42 series)	6 Months	6 Months

During the "Labor" warranty period there will be no charge for labor. During the "Parts" warranty period, there will be no charge for parts. This warranty only applies to products purchased and serviced in the United States. This warranty is extended only to the original purchaser of a new product which was not sold "as is".

### Mail-In Service – Online or Telephone Repair Request

#### Online Repair Request

To submit a new repair request, and for quick repair status visit our Web Site at: <http://shop.panasonic.com/support>

When shipping the unit, carefully pack and send it prepaid in the original (or supplied) carton. Include a letter detailing the complaint along with the bill of sales and provide a daytime phone number where you can be reached. A valid registered receipt is required under the Limited Warranty. When shipping Lithium Ion batteries please visit our web site at <http://shop.panasonic.com/support> as Panasonic is committed to providing the most up to date information.

**IF REPAIR IS NEEDED DURING THE WARRANTY PERIOD, THE PURCHASER WILL BE REQUIRED TO FURNISH A SALES RECEIPT/ PROOF OF PURCHASE INDICATING DATE OF PURCHASE, AMOUNT PAID AND PLACE OF PURCHASE. CUSTOMER WILL BE CHARGED FOR THE REPAIR OF ANY UNIT RECEIVED WITHOUT SUCH PROOF OF PURCHASE.**

#### Limited Warranty Limits And Exclusions

This warranty ONLY COVERS failures due to defects in materials or workmanship, and DOES NOT COVER glass, plastic parts, temperature probes (if included) and normal wear and tear or cosmetic damage. The warranty ALSO DOES NOT COVER damages which occurred in shipment, or failures which are caused by products not supplied by the warrantor, or failures which result from accidents, misuse, abuse, neglect, bug infestation, mishandling, misapplication, alteration, faulty installation, set-up adjustments, maladjustment of consumer controls, improper maintenance, power line surge, lightning damage, modification, or commercial use (such as in a hotel, office, restaurant, or other business), rental use of the product, service by anyone other than a factory service center or other authorized servicer, or damage that is attributable to acts of God.

**THERE ARE NO EXPRESS WARRANTIES EXCEPT AS LISTED UNDER "LIMITED WARRANTY COVERAGE".**

**THE WARRANTOR IS NOT LIABLE FOR INCIDENTAL OR CONSEQUENTIAL DAMAGES RESULTING FROM THE USE OF THIS PRODUCT, OR ARISING OUT OF ANY BREACH OF THIS WARRANTY.**

(As examples, this excludes damages for lost time, travel to and from the servicer, loss of or damage to media or images, data or other memory or recorded content. The items listed are not exclusive, but for illustration only.)

**ALL EXPRESS AND IMPLIED WARRANTIES, INCLUDING THE WARRANTY OF MERCHANTABILITY, ARE LIMITED TO THE PERIOD OF THE LIMITED WARRANTY.**

Some states do not allow the exclusion or limitation of incidental or consequential damages, or limitations on how long an implied warranty lasts, so the exclusions may not apply to you.

This warranty gives you specific legal rights and you may also have other rights which vary from state to state. If a problem with this product develops during or after the warranty period, you may contact your dealer or Service Center. If the problem is not handled to your satisfaction, then write to:

Panasonic Corporation of North America  
Consumer Affairs Department  
Two Riverfront Plaza  
Newark NJ 07102-5490

**PARTS AND SERVICE, WHICH ARE NOT COVERED BY THIS LIMITED WARRANTY, ARE YOUR RESPONSIBILITY.**

**Shop**  
**Accessories!**  
for all your Panasonic gear

Go to

<http://shop.panasonic.com/support>

Get everything you need to get the most out of your Panasonic products  
Accessories & Parts for your Camera, Phone, A/V products, TV, Computers & Networking, Personal Care, Home Appliances, Headphones, Batteries, Backup Chargers & more...

**Customer Services Directory**

For Product Information, Operating Assistance, Parts, Owner's Manuals, Dealer and Service info go to <http://shop.panasonic.com/support>

For the hearing or speech impaired TTY: 1- 877-833-8855

As of February 2024

## **Panasonic Corporation of North America**

Two Riverfront Plaza, Newark, NJ 07102-5490  
<https://www.panasonic.com>