

Panasonic[®]

Operating Instructions / Owner's Manual

<Complete Guide>

XLR Microphone Adaptor

Model No. **DMW-XLR2**

LUMIX

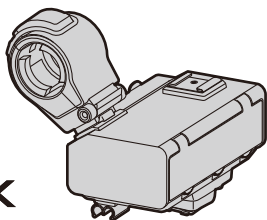

Please read these instructions carefully before using this product.

DVQP3126ZA
F0624KN0

About Operating Instructions

This document, "Operating Instructions / Owner's Manual <Complete Guide>", includes detailed explanations of the functions and operations of the unit.

❖ Symbols Used in This Document

Notification classification symbols

In this document, notifications are classified and described using the following symbols:

 : To confirm prior to using the function

 : Notifications and supplementary items regarding specifications

- Images and illustrations used in this document are for explaining the functions.

Contents

About Operating Instructions **2**

Introduction **4**

Precautions.....	5
Standard Accessories.....	7
Names of Parts.....	8

Getting Started **10**

Attaching the Microphone Holder	11
Attaching to the Camera.....	14
Connecting a Microphone.....	16
Connecting External Audio Devices, etc.....	22

Using the XLR Microphone Adaptor **24**

Setting the Recording Channels	25
Setting Input Gain	28
Setting the Recording Level.....	29
Decrease Noise Caused by Wind or Handling	31

Materials **32**

Cautions for Use	33
Specifications.....	36

Introduction

This chapter describes information you should know before starting.

- [Precautions: 5](#)
- [Standard Accessories: 7](#)
- [Names of Parts: 8](#)

Precautions

This unit is an XLR microphone adaptor for Panasonic digital cameras. Commercially available XLR microphones and stereo microphones (compatible with stereo mini plugs) can be fitted.

Use in combination with a digital camera to enable high-quality audio recordings, high-resolution audio recordings, and 4-channel audio recordings.

Furthermore, by using in combination with a digital camera that supports float recording, it is also possible to make 32-bit float recordings capable of high-quality audio recordings without having to make settings for the recording level.

❖ Compatible models (As of June 2024)

Compatible models: DC-GH7, DC-GH6*

* Use with the firmware on the Digital Camera updated to the most recent version.

DC-GH6 does not support float recording or 4-channel audio recording with just a microphone connected to this unit.

- For the latest information on the firmware or to download/update the firmware, visit the following support site:

<https://panasonic.jp/support/global/cs/dsc/download/index.html>

(English only)

- For the latest information on compatible devices, see the operating instructions, catalogue or website of the digital camera.

❖ Handling the unit

Do not subject the unit to strong vibration or impact. Those actions may result in malfunctions and failure.

Sand and dirt may cause the unit to malfunction. When using the unit in an environment such as a beach, take steps to protect it from sand and dirt.

When using the unit on rainy days or on a beach, take care to keep the unit dry.

This unit is neither dust-proof nor splash-resistant. If by any chance water droplets, etc. are splashed on the unit, wipe them off with a dry cloth. If the unit fails to function correctly, consult your dealer or Panasonic.

Please also read the manual of your digital camera.

- Please be advised that Panasonic is not liable for any damage directly or indirectly caused by use or malfunction of this product.
- The external design and specifications of this product, as described in this document, may differ from the actual product due to improvements made.

Standard Accessories

Check the supplied items. (Product numbers correct as of June 2024.)

Pouch

DVPY1024Z

Microphone holder

1AC1XLRMC8243Z

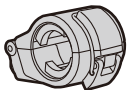

Cable holder

DVGE1055Z

- This is attached to the unit at the time of purchase.

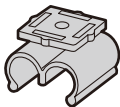

- Consult the dealer or Panasonic if you lose the supplied accessories. (You can purchase the accessories separately.)

Names of Parts

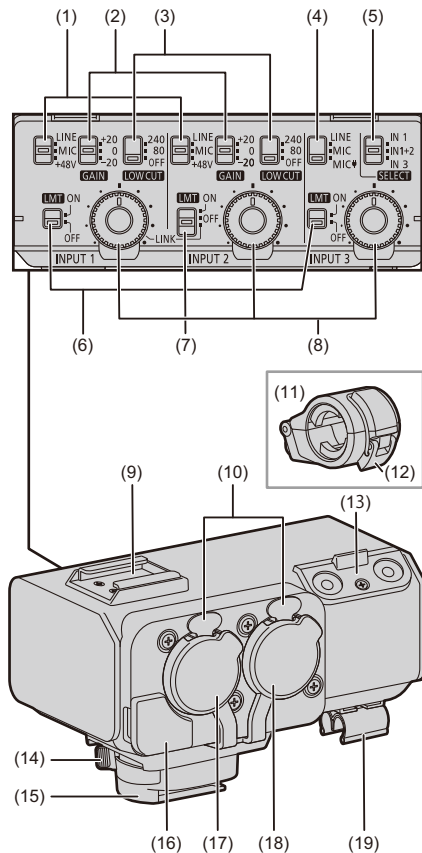

- (1) LINE/MIC/+48V switch (INPUT1/INPUT2)
- (2) GAIN switch (INPUT1/INPUT2)
- (3) LOW CUT switch (INPUT1/INPUT2)
- (4) LINE/MIC/MIC  switch (INPUT3)
- (5) SELECT switch
- (6) LMT switch (INPUT1/INPUT3)
- (7) LMT/LINK switch (INPUT2)
- (8) AUDIO LEVEL dial (INPUT1/INPUT2/INPUT3)
- (9) Accessory shoe
- (10) Release lever
- (11) Microphone holder
- (12) Buckle
- (13) Microphone holder mounting section
- (14) Lock lever
- (15) Hot shoe mount
- (16) Microphone terminal (INPUT3)
- (17) XLR terminal (INPUT2)
- (18) XLR terminal (INPUT1)
- (19) Cable holder

Getting Started

Before recording, read this chapter to prepare.

- [Attaching the Microphone Holder: 11](#)
- [Attaching to the Camera: 14](#)
- [Connecting a Microphone: 16](#)
- [Connecting External Audio Devices, etc.: 22](#)

Attaching the Microphone Holder

Attach the supplied microphone holder to this unit.

1 Open the microphone holder.

- Open buckle (1), and detach fitting (2) from hook (3).

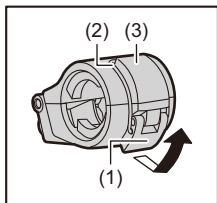

2 Attach the microphone holder to the microphone holder mounting section.

- Firmly screw in the screws of the microphone holder into the screw holes on the microphone holder mounting section.
- Attach using a commercially-available screwdriver.

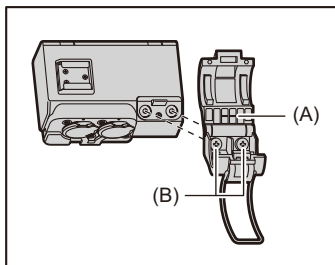

(A) Microphone holder

(B) Screws

3 Close the microphone holder.

- Attach the fitting (1) to the hook (2) and close the buckle (3) in the direction indicated by the arrow.

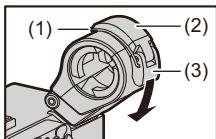

Attaching to the Camera

Confirm that the camera is off. Attaching or removing the XLR microphone adaptor while the camera is on may result in malfunction.

- 1 Slide the lock lever in the direction opposite to that indicated by the [LOCK ►] icon.**

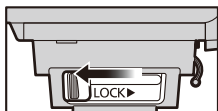

- 2 Slide the XLR microphone adaptor into the hot shoe until it clicks securely into place.**

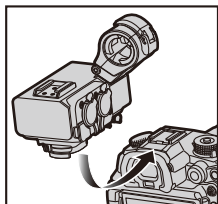

3 Slide the lock lever to the [LOCK ►] position.

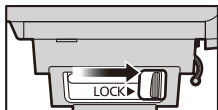

- To remove the XLR microphone adaptor, slide the lock lever in the direction opposite to the [LOCK ►] arrow and slide it from the hot shoe.

Connecting a Microphone

❖ Attaching a Microphone

1 Open the microphone holder.

- Open buckle (1), and detach fitting (2) from hook (3).

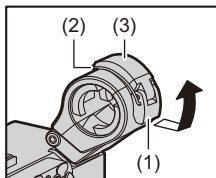

2 Attach the external microphone to the microphone holder, then close the buckle to secure the external microphone.

- Attach the fitting (1) to the hook (2) and close the buckle (3) in the direction indicated by the arrow.

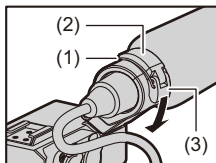

- When recording while using a microphone, take care that the microphone does not get in the shot.

❖ Connecting an XLR Microphone



- To prevent unnecessary force being applied to the digital camera hot shoe, insert the plug while holding the unit with your hand.
- If there is only one cable to be connected, connect it to terminal [INPUT1].

1 Insert the microphone cable plug into the XLR terminal of the unit.

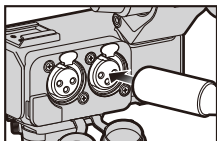

2 Set the LINE/MIC/+48V switch (INPUT1/INPUT2) to match the connected device.

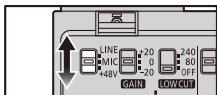

[LINE]	External audio devices (such as mixers)
[MIC]	Dynamic microphone or microphone with built-in battery
[+48V]	Microphone that supports +48V power supply (phantom power supply)

- When set to [+48V], connecting a device that does not support +48V power supply may cause damage to the connected device. Check the device before connecting.
- If noise from the unconnected terminal is bothering, set the LINE/MIC/+48V switch to [LINE].

3 Set the channels to record with the SELECT switch.
(→ [Setting the Recording Channels: 25](#))

**4 Set the input gain with the GAIN switch (INPUT1/
INPUT2).** (→ [Setting Input Gain: 28](#))

**5 Set the recording level with the AUDIO LEVEL dial
(INPUT1/INPUT2/INPUT3).** (→ [Setting the Recording
Level: 29](#))

- Use a shielded XLR microphone cable with a XLR (3 pin) terminal.
- When using a stereo microphone that has 2 XLR (3 pin) plugs, connect the Lch to the XLR terminal (INPUT1) and the Rch to the XLR terminal (INPUT2).

- The microphone cable can be attached to the unit's cable holder.

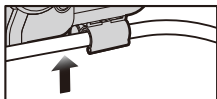

- The orientation of the cable holder can be changed. Remove the cable holder and attach it in a different orientation.

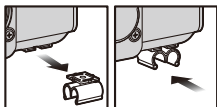

- A commercially available XLR microphone or microphone holder can be attached to the unit's accessory shoe.

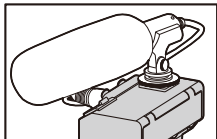

❖ **Remove the microphone cable**

Press the release lever, and hold the plug to remove it.

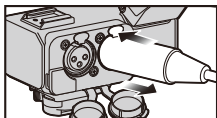

Connecting External Audio Devices, etc.



- To prevent unnecessary force being applied to the digital camera hot shoe, insert the plug while holding the unit with your hand.
- If there is only one cable to be connected, connect it to terminal [INPUT1].

- 1 Insert the plug of the device being connected into the INPUT1 terminal/INPUT2 terminal/INPUT3 terminal of this unit.**

- 2 Set the LINE/MIC/+48V switch (INPUT1/INPUT2) or the LINE/MIC/MIC Ψ switch (INPUT3) to suit the device to be connected.**

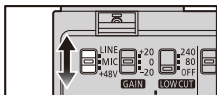

[LINE]	External audio devices (such as mixers)
[MIC]	Dynamic microphone or microphone with built-in battery
[+48V]	Microphone that supports +48V power supply (phantom power supply)
[MIC Ψ]	Plug-in power compatible microphone

- When set to [+48V], connecting a device that does not support +48V power supply may cause damage to the connected device. Check the device before connecting.
- If you are concerned about noise from terminals that are not connected, set the LINE/MIC/+48V switch (INPUT1/INPUT2) or LINE/MIC/MIC Ψ switch (INPUT3) to [LINE].

- 3 Set the channels to record with the SELECT switch.** (→ [Setting the Recording Channels: 25](#))
- 4 Set the input gain with the GAIN switch (INPUT1/ INPUT2).** (→ [Setting Input Gain: 28](#))
- 5 Set the recording level with the AUDIO LEVEL dial (INPUT1/INPUT2/INPUT3).** (→ [Setting the Recording Level: 29](#))

Using the XLR Microphone Adaptor

This unit can be used by turning the power of the digital camera [ON] while this unit is mounted on the digital camera.

- The operational sound of the switch operation may be recorded or the sound may get interrupted, such as when the switch is operated during the recording of a motion picture.
- [Setting the Recording Channels: 25](#)
- [Setting Input Gain: 28](#)
- [Setting the Recording Level: 29](#)
- [Decrease Noise Caused by Wind or Handling: 31](#)

Setting the Recording Channels

Set the recording channels to match the settings in the digital camera menu ([4ch Audio Recording]).





❖ When [4ch Audio Recording] Is [OFF]

Select the input audio to be recorded to CH1/CH2 with the SELECT switch.

Settings	Audio recorded with CH1/CH2
[IN1]	INPUT1 → CH1 INPUT1 → CH2
[IN1+2]	INPUT1 → CH1 INPUT2 → CH2
[IN3]	INPUT3 (L/R) → CH1 INPUT3 (L/R) → CH2

❖ When [4ch Audio Recording] Is [XLR+CAMERA]

Select the input audio to be recorded to CH1/CH2 with the SELECT switch.

Settings	Audio recorded with CH1/CH2
[IN1]	 <p>INPUT1 ————┐ └───> CH1 └───> CH2</p>
[IN1+2]	 <p>INPUT1 —————> CH1 INPUT2 —————> CH2</p>
[IN3]	 <p>INPUT3 (L/R) ———┐ └───> CH1 └───> CH2</p>

- The input audio from the built-in microphone of the digital camera or the external microphone connected to the digital camera is recorded to CH3/CH4.

❖ When [4ch Audio Recording] Is [XLR]

Irrespective of the position of the SELECT switch, the input audio recorded to each channel is fixed.

Audio to be Recorded to CH1/CH2/CH3/CH4

INPUT1 → CH1

INPUT2 → CH2

INPUT3 (L) → CH3

INPUT3 (R) → CH4



- If there is no [4ch Audio Recording] in the menus of the digital camera, it is not possible to record 4-channel audio with only the microphone connected to this unit.

Setting Input Gain

You can change the input gain with the GAIN switch (INPUT1/INPUT2) when the LINE/MIC/+48V switch (INPUT1/INPUT2) is set to [MIC] or [+48V].

Set the input gain with the GAIN switch (INPUT1/INPUT2).



[+20]	+20 dB
[0]	0 dB (Default setting, standard level: -40 dBu)
[-20]	-20 dB



- Input gain cannot be changed during 32-bit float recording.

Setting the Recording Level

Set the recording level for audio that is input through the input terminals (INPUT1, INPUT2, INPUT3).

Turn the AUDIO LEVEL dial (INPUT1/INPUT2/INPUT3) to set the recording level (volume).

- Setting the level while checking with headphones connected to the digital camera or the digital camera microphone level display is recommended.
- Sound is muted if you turn the dial all the way to the left.

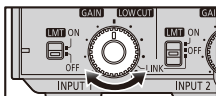

❖ Matching the Recording Levels of INPUT1 and INPUT2

Set the LMT/LINK switch (INPUT2) to [LINK]. The recording levels for both INPUT1 and INPUT2 can be set at the same time with the AUDIO LEVEL dial (INPUT1). The setting of the LMT switch (INPUT1) is also applied to INPUT2.

❖ Adjust the recording level automatically

Set the LMT switch (INPUT1/INPUT3) or the LMT/LINK switch (INPUT2) to [ON]. At high volumes, the recording level is decreased automatically to reduce distortion with the sound.



- The recording level of the built-in microphone of the digital camera and the [MIC] terminal cannot be set.
- Recording levels other than mute cannot be changed during 32-bit float recording.
- The recording volume may vary if you switch between float format and linear format.

Decrease Noise Caused by Wind or Handling

Noise caused by wind or handling is reduced by cutting out low-frequency components that are input to the XLR terminals (INPUT1, INPUT2).

Set the LOW CUT switch (INPUT1/INPUT2) to [80] or [240].

- Select based on the type of noise.

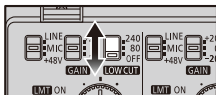

Materials

This chapter describes procedures to try when there is a problem and provides information about the specifications for your reference.

- [Cautions for Use: 33](#)
- [Specifications: 36](#)

Cautions for Use

❖ About the unit

Do not use this unit near radio transmitters or high-voltage lines.

- Noise may be present in images and sound recorded near radio transmitters or high-voltage lines. Perform recording in locations away from them. The level of noise varies depending on the XLR microphone used.

Keep the unit away from insecticide sprays and other volatile substances.

- Exposure to such substances may cause damage to the external case and the text and symbols printed on the unit.
- Do not leave the unit in contact with any items made of rubber or PVC for prolonged periods of time.

Do not carry the unit with your hands while it is still attached to a digital camera.

- Under no circumstances should the unit be used or stored in any of the following locations since doing so may cause trouble in operation or malfunctioning:
 - In direct sunlight or on a beach in summer
 - In locations with high temperatures and humidity levels or where changes in temperature and humidity are acute
 - In locations with high concentrations of sand, dust or dirt
 - Where there is fire
 - Near heaters, air conditioners or humidifiers
 - Where water may make the unit wet
 - Where there is vibration
 - Inside a vehicle
- Do not drop the unit, knock it into other objects or subject it to any other kind of strong impact or shock.
- When recording a motion picture, the digital camera or lens sounds or other operating noise may be recorded. If the sound from the lens is particularly bothering, set the camera to manual focus during use. If the operating noise is particularly bothering, position the microphone away from the digital camera during use.
- If the terminals are dirty they can cause faulty connections. Wipe clean with a soft dry cloth before connecting.
- Do not attach or remove cables with the power of the digital camera turned [ON].
- If you start video recording immediately after turning on the digital camera, a period with no sound may be recorded at the beginning.
- Before use, check that the XLR microphone adaptor is recording normally.
- Do not disassemble or modify this unit.

❖ Cleaning

When cleaning, wipe the unit with a dry soft cloth.

- When the unit is soiled badly, it can be cleaned by wiping the dirt off with a wrung wet cloth, and then with a dry cloth.
- Do not use solvents such as benzine, thinner, alcohol, kitchen detergents, etc., to clean the unit, as these may damage the external case and the text and symbols printed on the unit.
- When using a chemical cloth, be sure to follow the accompanying instructions.

Specifications

The specifications are subject to change for performance enhancement.

INPUT1 terminal, INPUT2 terminal

- **Input terminal**

XLR3-pin, female

- **Standard input level**

LINE: 0 dBu

MIC, +48V: -40 dBu

(0 dBu=0.775 Vrms)

- **Standard recording level**

-12 dBFS (at the standard input)

- **Frequency characteristic**

20 Hz to 40 kHz, +1/-1 dB (Fs= during 96 kHz, during LINE)

- **Phantom power source**

48 V

INPUT3 terminal

- **Input terminal**

Ø3.5 mm stereo mini jack

- **Standard input level**

LINE: –10 dBV

MIC, MIC (plug-in power): –40 dBV

(0 dBV=1 Vrms)

- **Standard recording level**

–12 dBFS (at the standard input)

- **Frequency characteristic**

20 Hz to 40 kHz, +1/–1 dB (Fs= during 96 kHz, during LINE)

- **Plug-in power**

2.5 V

Sampling frequency/bit length/number of recording channels

- **During linear recording**

48 kHz/24 bit/2ch, 96 kHz/24 bit/2ch

(Select one of INPUT1, INPUT1+2, or INPUT3)

48 kHz/24 bit/4ch

- **During float recording**

48 kHz/32 bit/2ch, 96 kHz/32 bit/2ch

(Select one of INPUT1, INPUT1+2, or INPUT3)

48 kHz/32 bit/4ch

External dimensions

Approx. 61.2 mm (W)×60.9 mm (H)×92.0 mm (D)

[2.41" (W)×2.40" (H)×3.63" (D)]

(microphone holder not attached)

(excluding the projecting parts)

Approx. 94.6 mm (W)×106.2 mm (H)×92.0 mm (D)

[3.73" (W)×4.19" (H)×3.63" (D)]

(microphone holder attached)

(excluding the projecting parts)

Mass (weight)

Approx. 158 g/0.35 lb (microphone holder not attached)

Approx. 192 g/0.43 lb (microphone holder attached)

Operating temperature

– 10 °C to 40 °C (14 °F to 104 °F)

Operating humidity

10 %RH to 80 %RH

The symbols on this product (including the accessories) represent the following:

⎓ DC
