

Panasonic[®]

Operating Instructions

2-in-1 Corded | Cordless Phone

Model No. **KX-TGF892C**

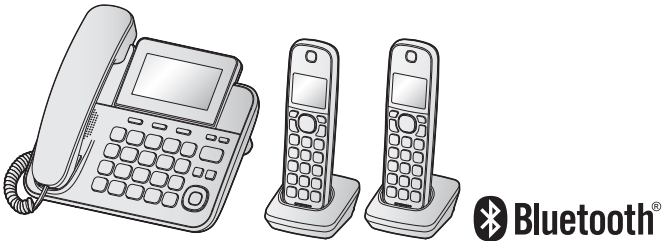

Model shown is KX-TGF892.

Before initial use, see “Getting Started” on page 9.

Thank you for purchasing a Panasonic product.

Please read these operating instructions before using the unit and save them for future reference.

For assistance, please visit our Support page:

www.panasonic.ca/english/support

Table of Contents

Introduction

Accessory information	3
Graphical symbols for use on equipment and their descriptions	4

Important Information

For your safety	5
Important safety instructions	6
For best performance	7
Other information	7
Specifications	8

Getting Started

Setting up	9
Controls	12
Display icons	13
Language settings	14
Date and time	15
Recording your greeting message	15
Other settings	15

Using Bluetooth® Headphone

Using a Bluetooth headphone	16
Operating a Bluetooth headphone	17

Making/Answering Calls

Making calls	19
Answering calls	20
Useful features during a call	20

Answer by Voice Command

Answer by voice command	24
-------------------------------	----

Intercom

Intercom	25
----------------	----

Call Block

Call block	26
Storing unwanted callers	26

Enhanced Call Block

Automated call block	29
Telemarketing call block	31

Phonebook

Phonebook	32
Speed dial	34
One-touch dial buttons	35

Programming

Menu list	37
Alarm	43
Night mode	44
Baby monitor	44
Other programming	46
Registering a unit	46

Caller ID Service

Using Caller ID service	48
Caller list	49

Answering System

Answering system	51
Turning the answering system on/off	51
Greeting message	51
Listening to messages	52
Advanced new message alerting features	53
Remote operation	55
Answering system settings	56

Useful Information

Voicemail service	57
Wall mounting	58
Error messages	59
Troubleshooting	60
Other notices and information (for Canada)	67
Warranty	68

Index

Index	69
-------------	----

Accessory information

Supplied accessories

No.	Accessory item/Part number	Quantity
①	AC adaptor/PNLV226	1
②	Telephone line cord	1
③	Desk stand/Wall mounting adaptor* ¹	1
④	Base battery cover* ²	1
⑤	Corded handset	1
⑥	Corded handset cord	1
⑦	Rechargeable batteries* ³	4
⑧	Handset cover* ⁴	2
⑨	Charger	2

*1 The desk stand/wall mounting adaptor comes attached to the base unit.

*2 The base battery cover comes attached to the base unit.

*3 See page 3 for replacement battery information.

*4 The handset cover comes attached to the handset.

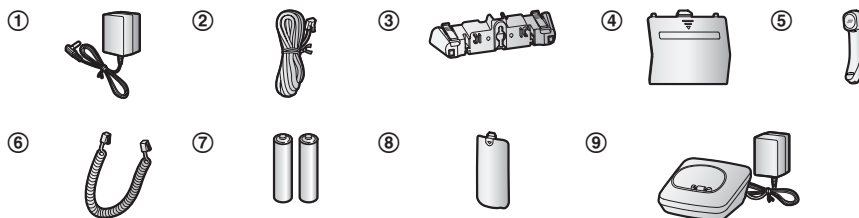

Additional/replacement accessories

Please contact your nearest Panasonic dealer for sales information.

Accessory item	Model number/Specifications
Rechargeable batteries	HHR-4DPA* ¹
	Battery type: – Nickel metal hydride (Ni-MH) – 2 x AAA (R03) size for each handset

*1 Replacement batteries may have a different capacity from that of the supplied batteries.

Other information

- Design and specifications are subject to change without notice.
- The illustrations in these instructions may vary slightly from the actual product.

Expanding your phone system

Handset (optional): KX-TGDA99C	
<p>You can expand your phone system by registering optional handsets (6 max.) to a single base unit.</p> <ul style="list-style-type: none"> Optional handsets may be a different colour from that of the supplied handsets. 	

Bluetooth® devices

You can expand your phone system by pairing a Bluetooth headphone to the handset.













<p>Your Bluetooth headphone*1: 4 max. (for a wireless hands-free conversation: page 16)</p>	
--	---

*1 Your headphone must be Bluetooth wireless technology compatible.

Trademarks

- The Bluetooth® word mark and logos are registered trademarks owned by Bluetooth SIG, Inc., and any use of such marks by Panasonic Holdings Corporation is under licence.
- All other trademarks identified herein are the property of their respective owners.

Graphical symbols for use on equipment and their descriptions

Symbol	Explanation	Symbol	Explanation
	Alternating current (A.C.)		Class II equipment (equipment in which protection against electric shock relies on Double Insulation or Reinforced Insulation)
	Direct current (D.C.)		"ON" (power)
	Protective earth		"OFF" (power)
	Protective bonding earth		Stand-by (power)
	Caution, risk caused by visible radiation		"ON"/"OFF" (power; push-push)
	For indoor use only		Caution, risk of electric shock

For your safety

To prevent severe injury and loss of life/property, read this section carefully before using the product to ensure proper and safe operation of your product.

WARNING

Power connection

- Use only the power source marked on the product.
- Do not overload power outlets and extension cords. This can result in the risk of fire or electric shock.
- Completely insert the AC adaptor/power plug into the power outlet. Failure to do so may cause electric shock and/or excessive heat resulting in a fire.
- Regularly remove any dust, etc. from the AC adaptor/power plug by pulling it from the power outlet, then wiping with a dry cloth. Accumulated dust may cause an insulation defect from moisture, etc. resulting in a fire.
- Unplug the product from power outlets if it emits smoke, an abnormal smell, or makes an unusual noise. These conditions can cause fire or electric shock. Confirm that smoke has stopped emitting and contact us by visiting our Support page:
www.panasonic.ca/english/support
- Unplug from power outlets and never touch the inside of the product if its casing has been broken open.
- Never touch the plug with wet hands. Danger of electric shock exists.

Installation

- To prevent the risk of fire or electrical shock, do not expose the product to rain or any type of moisture.
- Do not place or use this product near automatically controlled devices such as automatic doors and fire alarms. Radio waves emitted from this product may cause such devices to malfunction resulting in an accident.
- Do not allow the AC adaptor or telephone line cord to be excessively pulled, bent or placed under heavy objects.

- Disconnect the telephone cord before opening battery cover of base unit.

Operating safeguards

- Unplug the product from power outlets before cleaning. Do not use liquid or aerosol cleaners.
- Do not disassemble the product.
- Do not spill liquids (detergents, cleansers, etc.) onto the telephone line cord plug, or allow it to become wet at all. This may cause a fire. If the telephone line cord plug becomes wet, immediately pull it from the telephone wall jack, and do not use.
- Do not excessively pull the corded handset cord from the base unit. This may cause the base unit to fall, resulting in injury.

Medical

- Consult the manufacturer of any personal medical devices, such as pacemakers or hearing aids, to determine if they are adequately shielded from external RF (radio frequency) energy. (The product operates in the frequency range of 1.92 GHz to 1.93 GHz, and the RF transmission power is 115 mW (max.))
- Do not use the product in health care facilities if any regulations posted in the area instruct you not to do so. Hospitals or health care facilities may be using equipment that could be sensitive to external RF energy.

CAUTION

Installation and location

- Never install telephone wiring during an electrical storm.
- Never install telephone line jacks in wet locations unless the jack is specifically designed for wet locations.
- Never touch uninsulated telephone wires or terminals unless the telephone line has been disconnected at the network interface.
- Use caution when installing or modifying telephone lines.
- The AC adaptor is used as the main disconnect device. Ensure that the AC outlet is installed near the product and is easily accessible.
- The product is only use for mounting at heights ≤ 2 m.

Important Information

Note:

- This height is not guaranteed for product reliability.
- To prevent serious injuries due to the product unexpectedly falling, the product must be installed at a height of 1.5 m or lower.
- This cordless handset is unable to make calls when:
 - the handset batteries need recharging or have failed.
 - there is a power failure.

Ni-MH rechargeable batteries

- We recommend using the batteries noted on page 3. **USE ONLY rechargeable Ni-MH batteries AAA (R03) size.**
- Do not mix old and new batteries.
- Do not open or mutilate the batteries. Released electrolyte from the batteries is corrosive and may cause burns or injury to the eyes or skin. The electrolyte is toxic and may be harmful if swallowed.
- Exercise care when handling the batteries. Do not allow conductive materials such as rings, bracelets, or keys to touch the batteries, otherwise a short circuit may cause the batteries and/or the conductive material to overheat and cause burns.
- Charge the batteries provided with or identified for use with this product only, in accordance with the instructions and limitations specified in this manual.
- Only use a compatible base unit (or charger) to charge the batteries. Do not tamper with the base unit (or charger). Failure to follow these instructions may cause the batteries to swell or explode.
- Avoid the use in the following conditions
 - High or low extreme temperatures during use, storage or transportation.
 - Replacement of a battery with an incorrect type that can defeat a safeguard.
 - Disposal of a battery into fire or a hot oven, or mechanically crushing or cutting of a battery, that can result in an explosion.
 - Extremely high temperature and/or extremely low air pressure that can result in an explosion or the leakage of flammable liquid or gas.

Attention:



A nickel metal hydride battery that is recyclable powers the product you have purchased. Please call 1-800-8-BATTERY (1-800-822-8837) for information on how to recycle this battery.

Note when using alkaline batteries for power backup

- The batteries should be used correctly, otherwise the unit may be damaged due to battery leakage.
- Do not charge, short-circuit, disassemble, or heat the batteries.
- Do not dispose of batteries in a fire.
- Remove all the batteries when replacing.
- Do not mix old, new or different types of batteries.
- It is recommended that batteries are replaced annually.

Important safety instructions

When using your product, basic safety precautions should always be followed to reduce the risk of fire, electric shock, and injury to persons, including the following:

1. Do not use this product near water for example, near a bathtub, washbowl, kitchen sink, or laundry tub, in a wet basement or near a swimming pool.
2. Avoid using a telephone (other than a cordless type) during an electrical storm. There may be a remote risk of electric shock from lightning.
3. Do not use the telephone to report a gas leak in the vicinity of the leak.
4. Use only the power cord and batteries indicated in this manual. Do not dispose of batteries in a fire. They may explode. Check with local codes for possible special disposal instructions.

SAVE THESE INSTRUCTIONS

For best performance

Base unit location/avoiding noise

The base unit and other compatible Panasonic units use radio waves to communicate with each other.

- For maximum coverage and noise-free communications, place your base unit:
 - at a convenient, high, and central location with no obstructions between the cordless handset and base unit in an indoor environment.
 - away from electronic appliances such as TVs, radios, personal computers, wireless devices, or other phones.
 - facing away from radio frequency transmitters, such as external antennas of mobile phone cell stations. (Avoid putting the base unit on a bay window or near a window.)
- Coverage and voice quality depends on the local environmental conditions.
- If the reception for a base unit location is not satisfactory, move the base unit to another location for better reception.

Environment

- Keep the product away from electrical noise generating devices, such as fluorescent lamps and motors.
- The product should be kept free from excessive smoke, dust, high temperature, and vibration.
- The product should not be exposed to direct sunlight.
- Do not place heavy objects on top of the product.
- When you leave the product unused for a long period of time, unplug the product from the power outlet.
- The product should be kept away from heat sources such as heating devices, cooking appliances, etc. It should not be placed in rooms where the temperature is less than 0 °C (32 °F) or greater than 40 °C (104 °F). Damp basements should also be avoided.
- The maximum calling distance may be shortened when the product is used in the following places: Near obstacles such as hills, tunnels, underground, near metal objects such as wire fences, etc.

- Operating the product near electrical appliances may cause interference. Move away from the electrical appliances.

Routine care

- **Wipe the outer surface of the product with a soft moist cloth.**
- Do not use benzine, thinner, or any abrasive powder.

Other information

- The applied nameplate is located at the bottom or rear of the product.

⚠ CAUTION: Risk of explosion if battery is replaced by an incorrect type. Dispose of used batteries according to the instructions.

Notice for product disposal, transfer, or return

- This product can store your private/confidential information. To protect your privacy/confidentiality, we recommend that you erase information such as phonebook or caller list entries from the memory before you dispose of, transfer, or return the product.

Compliance with TIA-1083 standard

Telephone handsets identified with this logo have reduced noise and interference when used with T-Coil equipped hearing aids and cochlear implants.



Specifications

- **Standard:**
 - Bluetooth wireless technology 4.2
 - Hands Free Profile (HFP)
- **Frequency range:**
 - 1.92 GHz to 1.93 GHz (DECT)
 - 2.402 GHz to 2.48 GHz (Bluetooth)
- **RF transmission power:**
 - 115 mW (max.)
- **Power source:**
 - 120 V AC, 60 Hz
- **Power consumption:**
 - Base unit:**
 - Standby: 1.0 W
 - Maximum: 4.3 W
 - Charger:**
 - Standby: 0.1 W
 - Maximum: 1.8 W
- **Operating conditions:**
 - 0 °C – 40 °C (32 °F – 104 °F), 20 % – 80 %
relative air humidity (dry)

Setting up

Connections

■ Base unit

- ① Connect the AC adaptor to the unit by pressing the plug firmly.
- ② Connect the telephone line cord to the unit until you hear a click.
- ③ Fasten the AC adaptor cord and the telephone line cord by hooking it.
- ④ Connect the AC adaptor to the power outlet.
- ⑤ Connect the telephone line cord to the single-line telephone jack (RJ11C) until you hear a click.
- ⑥ A DSL/ADSL filter (not supplied) is required if you have a DSL/ADSL service.
- ⑦ Connect the corded handset cord to the corded handset and the base unit until you hear a click.

Note:

- Use only the supplied Panasonic AC adaptor PNLV226.

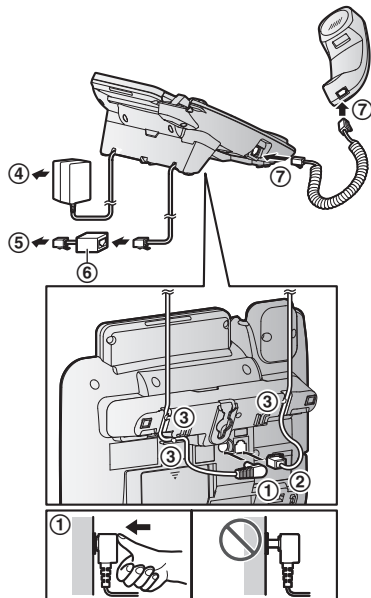

- Follow the directions on the display to set up the unit.

■ Charger

- ① Connect the AC adaptor to the power outlet.

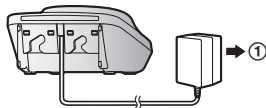

Handset battery installation

- USE ONLY rechargeable Ni-MH batteries AAA (R03) size (A).
- Do NOT use alkaline/manganese/Ni-Cd batteries.
- Confirm correct polarities (⊕, ⊖).

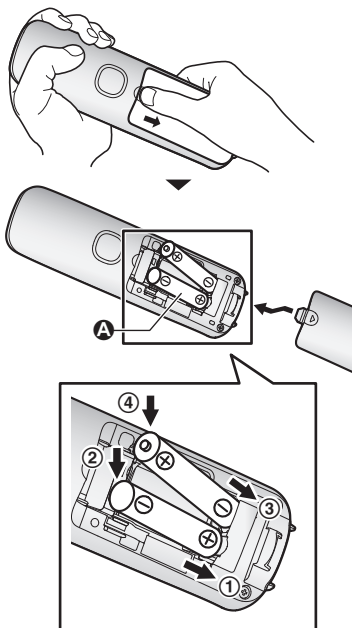

- Follow the directions on the display to set up the unit.

Removing the battery

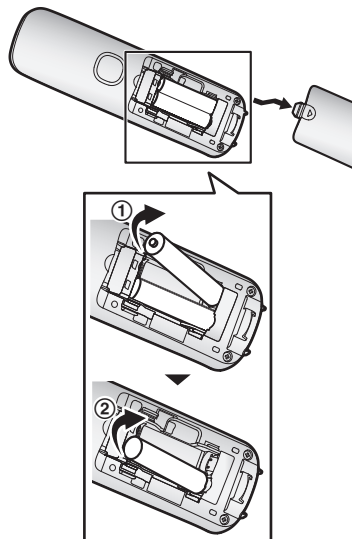

Handset battery charging

Charge for about 7 hours.

- Confirm “Charging” is displayed (A).
- When the batteries are fully charged, “Fully charged” is displayed.



Handset battery level

Icon	Battery level
	High
	Medium
	Low
	Needs charging.
	Empty

Note:

- At the end of each call, the unit displays a large icon for a few moments to indicate the battery level.
- You can set the unit to beep when the battery needs charging. (page 15)

Ni-MH battery performance (supplied batteries)

Bluetooth	Operating time
	In continuous use
Off	10 hours max.*1
On	7 hours max.*1

*1 If eco mode is on.

Note:

- Actual battery performance depends on usage and ambient environment.

Base unit battery installation (for power backup)

You can insert 2 AAA (R03) batteries (not supplied) into the base unit that will power the unit temporarily in the event of a power failure.

Important:

- The following batteries can be used with the base unit:
 - Rechargeable Ni-MH batteries*1, *2 (including the batteries used in your handset(s))
 - Standard (non-rechargeable) alkaline batteries*3
- Do NOT use manganese batteries.
- Confirm correct polarities (⊕, ⊖).

*1 The base unit can fully charge Ni-MH batteries in about 15 hours.

*2 We recommend using HHR-4DPA batteries (page 3).

*3 Only insert alkaline batteries once a power failure occurs. Remove the alkaline batteries when power is restored.

- 1 Disconnect the telephone line cord (1).
- 2 Open the battery cover (2).
- 3 Install the batteries in the battery compartment (3).

- 4 Close the cover, then reconnect the telephone line cord (4).

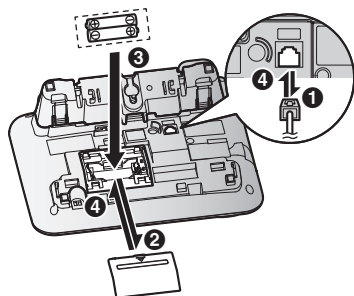

Note:

- If your phone service provider requires additional devices in order to make and receive calls, such as a modem, you may still not be able to make and receive calls even if the base unit's power backup feature is functioning.

Base unit battery status when a power failure occurs

Icon	Battery status
	Power backup mode is on.
	Battery power is low.*1

- *1 If begins flashing on the base unit, replace the batteries with new ones as soon as possible. If you replace Ni-MH batteries with alkaline batteries, insert the Ni-MH batteries into the base unit again after the power is restored so that they will be recharged.

Battery saving mode setting

This feature allows the base unit to reduce its power consumption by limiting the available functions and therefore extend battery life during a power failure.

The following settings are available:

- “On”: The unit will work as a standard telephone. Only the corded handset can be used to make and receive calls. (You cannot use the base unit display, phonebook, one-touch dial, answering system, speakerphone, etc.)
The base unit display is blank.
- “Off” (default): You can use the full functions of the base unit, but battery life is not extended.

The brightness level for the base unit display is lowered.

Base unit

- 1 [MENU]#150
- 2 (↑): Select the desired setting.
- 3 [SAVE] → [EXIT]

Note:

- Once the battery saving mode is set to “On”, the unit rings with the volume level 1 even if the ringer volume for the base unit is set to “Off” to let you know an incoming call is being received.

Ni-MH battery performance (optional batteries) when operating on backup battery power

Operation	Saving mode	
	Off	On
In continuous use	1.5 hours max.	5 hours max.
Not in use (standby)	2 hours max.	6 hours max.

Note:

- Battery performance depends on the type of batteries.
- Actual battery performance depends on usage and ambient environment.

Note when setting up

Note for connections

- The AC adaptor must remain connected at all times. (It is normal for the adaptor to feel warm during use.)
- The AC adaptor should be connected to a vertically oriented or floor-mounted AC outlet. Do not connect the AC adaptor to a horizontally oriented AC outlet that faces the floor, such as an AC outlet installed on a ceiling or under a table, as the weight of the adaptor may cause it to become disconnected.

Note for Ni-MH battery installation



- **Handset:** Use the supplied rechargeable batteries.
- **Handset/Base unit:** For replacement, we recommend using the Panasonic rechargeable batteries noted on page 3, 6.

Note for battery charging

- It is normal for the handset to feel warm during charging.
- Clean the charge contacts of the handset and charger with a soft and dry cloth once a month. Before cleaning the unit, disconnect from power outlets and any telephone line cords. Clean more often if the unit is exposed to grease, dust, or high humidity.

Intelligent eco mode

This feature automatically reduces handset power consumption by suppressing handset transmission power when the handset is close to the base unit.

- When this feature is activated,  is displayed. However, when answer by voice command is turned on (page 24),  is not displayed even though this feature is activated.

Controls

Handset

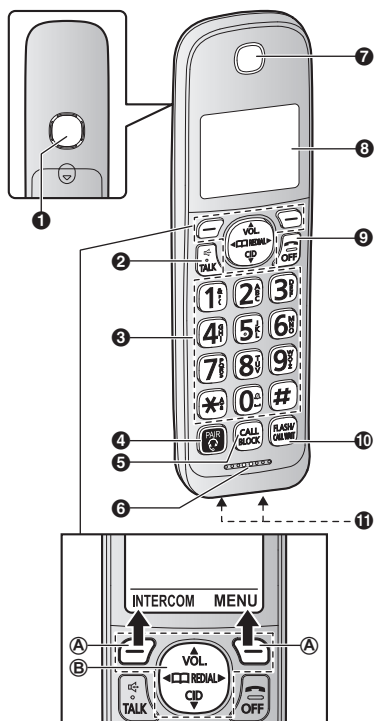

- 1 Speaker
- 2 **[TALK]** (Talk/Speakerphone)
- 3 Dial keypad
 - : Temporary tone dialing
 - : (A) Ringer off
- 4 **[PAIR]** ()
- 5 **[CALL BLOCK]**
- 6 Microphone
- 7 Receiver
- 8 Display
- 9 **[OFF]** ()
- 10 **[FLASH][CALL WAIT]**
- 11 Charge contacts

Control type

A Soft keys

By pressing a soft key, you can select the feature shown directly above it on the display.

B Navigator key

- [▲], [▼], [◀], or [▶]: Scroll through various lists and items.
- VOL. (Volume: [▲] or [▼]): Adjust the receiver or speaker volume while talking.
- [◀] □□: View the phonebook entry.
- [▶] REDIAL: View the redial list.
- [▼] CID (Caller ID): View the caller list.

Base unit

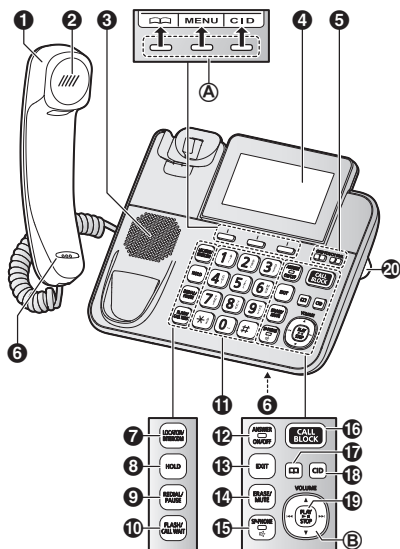

- 1 Corded handset**
- 2 Receiver**
- 3 Speaker**
- 4 Display**
 - The display can be moved back and forth to select the desired angle.
- 5 ONE-TOUCH DIAL buttons**
- 6 Microphone**
- 7 [LOCATOR][INTERCOM]**
 - You can locate a misplaced handset by pressing [LOCATOR].
- 8 [HOLD]**
- 9 [REDIAL][PAUSE]**
- 10 [FLASH][CALL WAIT]**
- 11 Dial keypad**
 - ☒: Temporary tone dialing
- 12 [ANSWER ON/OFF]**
ANSWER ON/OFF indicator
- 13 [EXIT]**
- 14 [ERASE][MUTE]**
- 15 [☎] (SP-PHONE: Speakerphone)**
SP-PHONE indicator

- 16 [CALL BLOCK]**
- 17 [☐☐] (Phonebook)**
- 18 [CID] (Caller ID)**
- 19 [▶■] (PLAY/STOP)**
Message indicator
- 20 Desk stand/Wall mounting adaptor**
 - The adaptor is a removable attachment for desk stand or wall mounting use (page 58).

Control type

A Soft keys

By pressing a soft key, you can select the feature shown directly above it on the display.









B Navigator key

- [▲], [▼], [◀], or [▶]: Scroll through various lists and items.
- VOLUME ([▲] or [▼]): Adjust the receiver or speaker volume while talking.
- [◀◀]/[▶▶]: Repeat/skip messages during playback.

Display icons







Handset display items

Item	Meaning
	Within base unit range
	Out of base unit range
	The line is in use. <ul style="list-style-type: none"> • When flashing slowly: The call is on hold. • When flashing rapidly: An incoming call is now being received.
	Eco mode is on. (page 12)
	A Bluetooth headphone is connected to the handset. It is ready for use.*1
	A Bluetooth headphone is in use.*1
	Noise reduction is set. (page 21)
	Equalizer is set. (page 21)
	Speakerphone is on. (page 19)
	Ringer volume is off. (page 20,40)
	Night mode is on. (page 44)
	Privacy mode is on.*2 (page 42)

Item	Meaning
	Alarm is on.*2 (page 43)
	Handset number
	Battery level
	Answer by voice command is on. (page 24)
	Blocked call (page 49)
	Automated call block is set to "Block". (page 29)
	Blocked automated call (page 49)
	Baby monitor is activated. The name/number displayed next to the icon indicates the monitoring unit. (page 44)
In use	Answering system is being used by another unit.
Line in use	Someone is using the line.

- *1 Corresponding headphone number is indicated next to the item.
- *2 When the Bluetooth headphone is connected to the handset, the item is not displayed even though the feature is activated.

Base unit display items

Item	Meaning
	The line is in use. <ul style="list-style-type: none"> When flashing slowly: The call is on hold. When flashing rapidly: An incoming call is now being received.
	Ringer volume is off. (page 40)
	Night mode is on. (page 44)
PRIV	Privacy mode is on. (page 42)
GO	"Greeting only" is selected. Caller messages are not recorded. (page 56)
	Power backup mode is on. (page 11)
	Answer by voice command is on. (page 24)
	Blocked call (page 49)

Item	Meaning
	<ul style="list-style-type: none"> Automated call block is set to "Block". (page 29) Blocked automated call (page 49)
In use	Answering system is being used by the handset.
Line in use	Someone is using the line.

Language settings

Display language

Handset / Base unit

- [MENU]** **#** **1** **1** **0**
- [↕]**: Select the desired setting. → **[SAVE]**
- Proceed with the operation for your unit.
Handset: [OFF]
Base unit: [EXIT]

Voice announcement language

You can select the language used for the following features.

- Answering system guidance
- Automated call block guidance
- Telemarketing call block guidance
- Talking Caller ID
- Answer by voice command announcement
- 2-way recording announcement

Handset / Base unit

- [MENU]** **#** **1** **1** **2**
- [↕]**: Select the desired setting. → **[SAVE]**
- Proceed with the operation for your unit.
Handset: [OFF]
Base unit: [EXIT]

Date and time

Handset / Base unit

- 1** **[MENU]** **#** **1** **0** **1**
- 2** Enter the current month, date, and year by selecting 2 digits for each.
Example: July 12, 2023
0 **7** **1** **2** **2** **3**
- 3** **[OK]**
- 4** Enter the current hour and minute (12-hour clock format) by selecting 2 digits for each.
Example: 9:30
0 **9** **3** **0**
- 5** Proceed with the operation for your unit.
Handset: **[X]**: Select “**AM**” or “**PM**”.
Base unit: **[AM/PM]**: Select “**AM**” or “**PM**”.
- 6** **[SAVE]**
- 7** Proceed with the operation for your unit.
Handset: **[OFF]**
Base unit: **[EXIT]**

Note:

- When English is selected as the display language, 12-hour clock format is used. When French is selected, 24-hour clock format is used.

Recording your greeting message

You can record your own greeting message instead of using a pre-recorded greeting message. See page 51 for details.

Handset / Base unit

- 1** **[MENU]** **#** **3** **0** **2**
- 2** **[↕]**: “**Yes**” → **[SELECT]**
- 3** Record a greeting message. → **[STOP]**
- 4** Proceed with the operation for your unit.
Handset: **[OFF]**
Base unit: **[EXIT]**

Other settings

Dialing mode

If you cannot make calls, change this setting according to your telephone line service. The default setting is “**Tone**”.

“**Tone**”: For tone dial service.

“**Pulse**”: For rotary/pulse dial service.

Handset / Base unit

- 1** **[MENU]** **#** **1** **2** **0**
- 2** **[↕]**: Select the desired setting. → **[SAVE]**
- 3** Proceed with the operation for your unit.
Handset: **[OFF]**
Base unit: **[EXIT]**

Low battery alert

This feature allows the unit to beep when the handset battery needs charging.

When this feature is turned on, the unit notifies you as follows.

■ When you end a call:

- The unit beeps when the battery needs charging.

■ When the handset is in standby mode:

- If the battery needs charging, the unit beeps at the selected interval up to 3 times.

Note for handset:

- At the end of each call, the unit displays a large icon for a few moments to indicate the battery level.

Setting low battery alert

To turn this feature on, select the desired alert interval, or select “**Off**” to turn this feature off.

The default setting is “**Every hour**”.

Handset

- 1** **[MENU]** **#** **1** **7** **6**
- 2** **[↕]**: Select the desired setting. → **[SAVE]**
→ **[OFF]**

Using a Bluetooth headphone

By pairing a Bluetooth headphone to the handset, you can enjoy hands-free conversations when talking over the phone.

Important:

- Your Bluetooth headphone must support the Hands Free Profile (HFP) specification.
- Up to 4 Bluetooth headphones can be paired to the handset.
- Only 1 Bluetooth headphone can be used with the unit at a time.
- For best performance, we recommend using your Bluetooth headphone within 3 m (10 feet) of the handset. The handset can communicate with Bluetooth headphones within an approximately 10 m (33 feet) range without any obstacles or line of sight.

Turning Bluetooth feature on/off

Once this feature is turned on, the Bluetooth **[PAIR]** button is enabled for use and the handset can perform other Bluetooth functions. The default setting is “OFF”.

- 1 To turn on:**
Press **[PAIR]**.
To turn off:
[MENU]#613
- 2 [↕]:** Select the desired setting. → **[SAVE]**
- 3 [OFF]**

Pairing a Bluetooth headphone to the handset

Important:

- Refer to the headphone's operating instructions. If your headphone PIN is not “0000”, change the Bluetooth PIN beforehand (page 17).

- 1 Bluetooth headphone:**
Set your headphone to pairing mode.
- 2 Handset:**
Press and hold **[PAIR]** for about 3 seconds.
- 3** Wait until a long beep sounds.
 - When  is displayed, the headphone is available for use.*1

*1 Corresponding headphone number is indicated next to the item.

Note:

- In step 2, if the handset has been paired with a maximum of 4 headphones, you can overwrite any unwanted headphone by pressing **[YES]** → **[↕]**: Select the desired headphone. → **[SELECT]**
- If you cannot pair the headphones to the handset, make sure that the Bluetooth headphones are not connected to another Bluetooth device.

Connecting/disconnecting a Bluetooth headphone

Headphones that are on can be connected automatically with the paired handset, while headphones that are off will be disconnected from the handset.

If the headphones do not connect automatically or if you want to use them with another Bluetooth device, you may need to connect/disconnect them manually.

Important:

- Make sure that the headphone is turned on.

- 1 To connect/disconnect:**
Press **[PAIR]**. → **[↕]**: Select the desired headphone. → **[SELECT]**
- 2 [↕]:** “Connect” or “Disconnect” → **[SELECT]**
 - A long beep sounds.
 - If another headphone is already connected when “Connect” is selected, the unit prompts you to disconnect the Bluetooth connection with the current headphone. → **[YES]**
- 3 [OFF]**

Note:

- A disconnected headphone is not unpaired from the handset, so pairing it to the handset again is unnecessary.

Unpairing a Bluetooth headphone

You can remove the Bluetooth headphone information stored in your handset.

- 1 Press **[PAIR]**. → **[↕]**: Select the desired headphone. → **[SELECT]**
- 2 **[↕]**: “Unpair” → **[SELECT]**
- 3 **[↕]**: “Yes” → **[SELECT]**
 - A long beep sounds.
- 4 **[OFF]**

Changing the headphone name

The name of the paired headphone will be displayed while talking using a Bluetooth headphone or in the headphone list. You can customize the name of paired Bluetooth headphones.

- 1 Press **[PAIR]**. → **[↕]**: Select the desired headphone. → **[SELECT]**
- 2 **[↕]**: “Change name” → **[SELECT]** → Enter the desired name (16 characters max.).
- 3 **[SAVE]** → **[OFF]**

Note:

- When the headphone is unpaired, the headphone name stored in the handset will be deleted.

Changing the Bluetooth PIN (Personal Identification Number)

The PIN is used to pair the headphone to the handset. The default PIN is “0000”. If your headphone PIN is not “0000”, change the Bluetooth PIN beforehand.

Important:

- Please make note of your new PIN. The unit will not reveal the PIN to you. If you forget your PIN, see page 66.

- 1 **[MENU]****#****6****4****5**
 - If the unit prompts you to enter the old PIN (When the default has been changed), enter the current 4-digit PIN.
- 2 Enter the new 4-digit PIN. → **[OK]**
- 3 Enter the new 4-digit PIN again. → **[SAVE]** → **[OFF]**

Operating a Bluetooth headphone

Important:

- Refer to your headphone’s operating instructions for details.
- Some features described here may not be available depending on Bluetooth headphone.
- Make sure that the headphone is turned on.

Making calls with your headphone

Important:

- Only 1 Bluetooth headphone can be used with the unit at a time.
- Make sure that the Bluetooth headphone is not connected to another Bluetooth device.

- 1 Lift the handset and then dial the phone number.
 - To correct a digit, press **[CLEAR]**.
- 2 Press **[PAIR]**.
 - The unit starts dialing immediately if only 1 Bluetooth headphone is paired and connected. Go to step 4.
- 3 If 2 or more Bluetooth headphones are paired, **[↕]**: Select the desired headphone. → **[SELECT]**
 - The unit starts dialing immediately if no other Bluetooth headphone is connected.
 - If the selected headphone is other than the one already connected, the unit prompts you to disconnect the Bluetooth connection with the current headphone. → **[YES]**
- 4 When you finish talking, press **[OFF]** or press your headphone’s button referring to your headphone’s operating instructions.

Note:

- **☎**₂ is displayed on the handset.*1
- While talking on the headphone, you can switch to the receiver by pressing **[TALK/☎]**.

*1 Corresponding headphone number is indicated next to the item.

Answering calls with your headphone

During an incoming call, you can answer the call in the following situations:

■ If the headphone is already connected and it rings:

- 1 Press **[PAIR]** or press your headphone's button referring to your headphone's operating instructions to answer the call.
- 2 When you finish talking, press **[OFF]** or press your headphone's button referring to your headphone's operating instructions.

■ If the headphone does not ring:

- 1 Press **[TALK/📞]** on the handset. You can also answer the call by pressing **[PAIR]** to connect to your headphone.
 - Answered call will automatically be directed to the speakerphone, since with some headphones it takes some time to connect.
 - During this time "Connecting" is displayed on the handset. Go to step 3.
- 2 To switch to your headphone, refer "Switching between the handset and your headphone", page 18.
- 3 When you finish talking, press **[OFF]** or press your headphone's button referring to your headphone's operating instructions.

Note:

- The first ring of an incoming call will not be heard when using a Bluetooth headphone.
- During an incoming call, press **[PAIR]** after receiving Caller ID information to answer the call and to select headphone listed, if 2 or more Bluetooth headphones are paired.
- Depending on your headphone, it may take some time to switch the call from the handset to headphone.

Switching between the handset and your headphone

You can switch between the handset and your headphone:

- during a call.
- during an intercom call.

■ To switch to your headphone during a call by the handset:

- 1 Press **[PAIR]** on the handset.
 - The call is automatically switched when there is only 1 Bluetooth headphone is paired and connected.
- 2 If 2 or more Bluetooth headphones are paired,
[↕]: Select the desired headphone. → **[SELECT]**
 - The call will be switched if no other Bluetooth headphone is connected.
 - If the selected headphone is other than the one already connected, the unit prompts you to disconnect the Bluetooth connection with the current headphone → **[YES]**

■ To switch to your handset during a call by the headphone:

Press **[TALK/📞]** on the handset.

Note:

- Make sure that the Bluetooth headphone is not connected to any other Bluetooth device.

Adjusting your headphone receiver volume

Press **[▲]** or **[▼]** repeatedly on the handset while using your headphone.

Note:

- Depending on your headphone, the receiver volume may not be adjustable.

Adjusting your headphone ringer volume

When using your headphone, press **[▲]** or **[▼]** repeatedly on the handset to select the desired volume while ringing.

- To turn the ringer off, press **[▼]** repeatedly.

Note:

- The ringer volume of the headphone corresponds to the handset ringer volume.
- Depending on your headphone, the ringer volume may not be adjustable.

Making calls

Using the handset

- 1 Lift the handset and then dial the phone number.
 - To correct a digit, press **[CLEAR]**.
- 2 Press **[TALK/📞]** to make the call.
 - To make the call using the speakerphone, press and hold **[TALK/📞]** for a few seconds.
- 3 When you finish talking, press **[OFF]** or place the handset on the charger.

Note:

- While talking, you can switch between the receiver and the speakerphone by pressing **[TALK/📞]**.
- In step 1, you can store the dialed phone number to the phonebook by pressing and holding **[◀] []** for a few seconds.

Making a call using the redial list

The last 5 phone numbers dialed are stored in the redial list (48 digits max. each).

- 1 **[▶] REDIAL**
- 2 **[↕]**: Select the desired entry.
- 3 Press **[TALK/📞]**.

Erasing a number in the redial list

- 1 **[▶] REDIAL**
- 2 **[↕]**: Select the desired entry. → **[ERASE]**
- 3 **[↕]**: “Yes” → **[SELECT]** → **[OFF]**

Using the base unit

- 1 Dial the phone number.
 - To correct a digit, press **[CLEAR]**.
- 2 Lift the corded handset.
 - To make the call using the speakerphone, press **[📞]**.
- 3 When you finish talking, place the corded handset on the cradle. When the speakerphone is used, press **[📞]**.

Note:

- You can also dial the phone number after lifting the corded handset.
- To switch to the speaker, press **[📞]**.

To switch back to the receiver, lift the corded handset.

- While on a call, you can switch from the base unit to the cordless handset as follows. The privacy mode must be on (page 42).
 - ① **Handset:** Press **[TALK/📞]**.
 - ② **Base unit:** Place the corded handset on the cradle. When the speakerphone is used, press **[📞]**.

Making a call using the redial list

The last 10 phone numbers dialed are stored in the redial list (48 digits max. each).

- 1 **[REDIAL]**
- 2 **[↕]**: Select the desired entry.
- 3 Lift the corded handset, or press **[📞]**.

Erasing a number in the redial list

- 1 **[REDIAL]**
- 2 **[↕]**: Select the desired entry. → **[ERASE]**
- 3 **[↕]**: “Yes” → **[SELECT]** → **[EXIT]**

Adjusting the receiver or speaker volume

Handset / Base unit

Press **[▲]** or **[▼]** repeatedly while talking.

Note for handset:

- If the receiver volume is set to level 5 (max.), it will be changed to level 4 in the next call.

Pause (for PBX/long distance service users)

A pause is sometimes required when making calls using a PBX or long distance service. When storing a calling card access number and/or PIN in the phonebook, a pause is also needed (page 34).

Example: If you need to dial the line access number “9” when making outside calls with a PBX:

Handset

- 1 **[9] → [▲]** (Pause)
- 2 Dial the phone number. → **[TALK/📞]**

Base unit

- 1 **[9]** → **[PAUSE]**
- 2 Dial the phone number.
- 3 Lift the corded handset.

Note for handset and base unit:

- A 3.5 second pause is inserted each time you press **[▲]** (Pause) on the handset or **[PAUSE]** on the base unit.

Answering calls

Using the handset

- 1 When the unit rings, lift the handset.
 - **To answer using the receiver:**
Press **[TALK/☎]**.
 - **To answer using the speakerphone:**
Press and hold **[TALK/☎]** for a few seconds.
- 2 When you finish talking, press **[OFF]** or place the handset on the charger.

Any key answer: You can answer the call by pressing any dial key (except **[0]** key).

Auto talk: You can answer calls simply by lifting the handset (page 41).

Temporary handset ringer off: You can turn the ringer off temporarily by pressing **[⏏]** (left soft key).

Using the base unit

When a call is being received, the SP-PHONE indicator flashes rapidly.

- 1 Lift the corded handset or press **[☎]** when the unit rings.
- 2 When you finish talking, place the corded handset on the cradle. When the speakerphone is used, press **[☎]**.

Temporary ringer off: You can turn the ringer off temporarily by pressing **[⏏]** (left soft key).

Adjusting the ringer volume

Handset

Press **[▲]** or **[▼]** repeatedly to select the desired volume while ringing.

- To turn the ringer off, press **[▼]** repeatedly.

Base unit

Press **[▲]** or **[▼]** repeatedly to select the desired volume while ringing.

- To turn the ringer off, press and hold **[▼]** until the unit beeps.

Note:

- To change the ringer volume and ringer tone for an outside call, see page 40.

One-touch ringer off for the handset

Press and hold **[0]** (**⏏**) until the unit beeps to turn the ringer off. While the ringer is turned off, the handset will not ring for calls.

- You can turn the ringer on again by pressing and holding **[0]** (**⏏**) until the unit beeps.

Useful features during a call

Hold

Handset

- 1 Press **[MENU]** during an outside call.
- 2 **[↕]**: “Hold” → **[SELECT]**
- 3 To release hold, press **[TALK/☎]**.
 - Another handset user can take the call by pressing **[TALK/☎]**.
 - The base unit user can take the call by lifting the corded handset.

Base unit

- 1 Press **[HOLD]** during an outside call.
 - If you are using the corded handset, you can place it on the cradle.
- 2 To release hold, lift the corded handset.
 - A handset user can take the call by pressing **[TALK/☎]**.

Note for handset and base unit:

- After holding for 10 minutes, the call is disconnected.

Note for base unit:

- While an outside call is on hold, the SP-PHONE indicator flashes.

Mute

Handset

- 1 Press **[MUTE]** during a call.
- 2 To return to the call, press **[MUTE]**.

Base unit

- 1 Press **[MUTE]** during a call.
 - When the speakerphone is used, the SP-PHONE indicator flashes.
- 2 To return to the call, press **[MUTE]**.

Note for handset:

- **[MUTE]** is a soft key visible on the display during a call.

Flash

Handset / Base unit

[FLASH] allows you to use the special features of your host PBX such as transferring an extension call, or accessing optional telephone services.

Note:

- To change the flash time, see page 42.

For call waiting or Call Waiting Caller ID service users

To use call waiting or Call Waiting Caller ID, you must first subscribe with your phone service provider.

This feature allows you to receive calls while you are already talking on the phone. If you receive a call while on the phone, you will hear a call waiting tone.

If you subscribe to both Caller ID and Call Waiting with Caller ID services, the 2nd caller's information is displayed on the unit that is in use after you hear the call waiting tone.

Handset / Base unit

- 1 Press **[CALL WAIT]** to answer the 2nd call.
- 2 To switch between calls, press **[CALL WAIT]**.

Note:

- Please contact your phone service provider for details and availability of this service in your area.

Temporary tone dialing (for rotary/pulse service users)

Handset / Base unit

Press **[X]** before entering access numbers which require tone dialing.

Handset noise reduction

This feature allows you to hear the voice of the person you are talking to more clearly, by reducing the surrounding noise coming from the other party's telephone.

- 1 Press **[MENU]** while talking.
- 2 **[↕]**: "Noise reduction on" or "Noise reduction off" → **[SELECT]**

Note:

- Depending on the environment where this handset is being used, this feature may not be effective.
- This feature is not available while using the speakerphone and Bluetooth headphone.

Handset equalizer

This feature clarifies the voice of the person you are talking to, producing a more natural-sounding voice that is easier to hear and understand.

- 1 Press **[MENU]** while talking.
- 2 **[↕]**: "Equalizer" → **[SELECT]**
- 3 **[↕]**: Select the desired setting.
- 4 Press **[OK]** to exit.

Note:

- Depending on the condition and quality of your telephone line, this feature may emphasize existing line noise. If it becomes difficult to hear, select another setting.
- This feature is not available while using the speakerphone and Bluetooth headphone.
- When both the "Equalizer" setting and noise reduction are activated, **NR** is shown on the display.

Recording a telephone conversation (2-way recording)

This unit can record a telephone conversations during outside calls.

Handset

- 1 Press **[MENU]** during an outside call.
- 2 **[↕]**: “2 way recording” → **[SELECT]**
 - The total recordable time is displayed.
 - The unit announces to both parties that the recording will start.
 - The unit starts recording.
- 3 To stop recording, press **[MENU]** → **[↕]**: “Stop recording” → **[SELECT]**
 - You can continue the conversation with the outside caller.

Base unit

- 1 Press **[RECORD]** (right soft key) during an outside call.
 - The total recordable time is displayed.
 - The unit announces to both parties that the recording will start.
 - The unit starts recording.
- 2 To stop recording, press **[STOP]** (left soft key).
 - You can continue the conversation with the outside caller.

Note:

- When recording is completed:
 - The total number of recordings will be added to the number of messages in the answering system.
 - **[▶■]** on the base unit flashes.
 - “New message” is displayed.
 - Audible message alert sounds on base unit (page 53).
- To listen to the recorded conversation, refer “Listening to messages”, page 52.
- 2 way recording is not available during conference calls.
- The recording will end in the following situations:
 - When **[FLASH]** is pressed.
 - When the hold or intercom feature is used.
- When memory is/becomes full:
 - “Memory full” is shown on the display.
 - An error tone sounds.

Call share

You can join an existing outside call.

Handset

To join the conversation, press **[TALK/☎]** when the other unit is on an outside call.

Base unit

To join the conversation, lift the corded handset when the handset is on an outside call.

Note for handset and base unit:

- When another user joins the conversation, the interrupt tone sounds.
- A maximum of 3 parties (including 1 outside party) can join a conversation using 2 extensions. **(3-way conference)**
- To prevent other users from joining your conversations with outside callers, turn privacy mode off (page 42).
- A 2nd party cannot join an outside call that is being recorded (page 22).

Transferring calls, conference calls

Outside calls can be transferred or a conference call with an outside party can be made:

- between handsets
- between a handset and the base unit

Handset

- 1 During an outside call, press **[MENU]**.
- 2 **[↕]**: “Intercom” → **[SELECT]**
- 3 **[↕]**: Select the desired unit. → **[SELECT]**
 - If you select “Voice paging”, the call will be switched from the ear-receiver mode to the speakerphone mode.
- 4 Wait for the paged party to answer.
 - If the paged party does not answer, press **[BACK]** to return to the outside call.
- 5 **To complete the transfer:**
Press **[OFF]**.
To establish a conference call:
[MENU] → **[↕]**: “Conference” → **[SELECT]**
 - To leave the conference, press **[OFF]**. The other 2 parties can continue the conversation.

- To put the outside call on hold: **[MENU]** → **[↕]**: “Hold” → **[SELECT]**
To resume the conference: **[MENU]** → **[↕]**: “Conference” → **[SELECT]**
- To cancel the conference: **[MENU]** → **[↕]**: “Stop conference” → **[SELECT]**
You can continue the conversation with the outside caller.

Base unit

- 1** During an outside call, press **[INTERCOM]**.
When 2 or more handsets are registered:
[↕]: Select the desired unit. → **[SELECT]**
 - To page all handsets, press **[0]** or wait for a few seconds.
- 2** Wait for the paged party to answer.
 - If paged party does not answer, press **[INTERCOM]** to return to the outside call.
- 3 To complete the transfer:**
Place the corded handset on the cradle.
 - The outside call is being routed to the handset.**To establish a conference call:**
Press **[CONF]** (left soft key).
 - To leave the conference, place the corded handset on the cradle. The other 2 parties can continue the conversation.
 - To put the outside call on hold, press **[HOLD]**. To resume the conference, press **[CONF]** (left soft key).

Answer by voice command

This feature allows you to answer incoming calls automatically with your voice. When your voice is detected, answered calls will automatically be directed to the speakerphone mode. The default setting is “**OFF**”.

Important:

- Before using this feature, we recommend that you test it and adjust the voice command sensitivity as needed.
- For best performance, answer the call within a range of 50 cm (20 inches) to 1 m (40 inches).
- Once this feature is turned on, the Talking Caller ID will be activated automatically. To turn off the Talking Caller ID feature, see page 40.
- Ambient noise (dog barking, TV sound, etc.) may cause the unit to answer an incoming call.
- When this feature is used, the unit disconnects the call automatically after 3 minutes. You may hear a warning tone and the unit may prompt you to press **[X]** to continue talking 1 minute before disconnecting.
- Once you press any key during a call, the call is continued.

Note:

- When a call is manually answered using a unit, voice detection will end, and the answer by voice command feature stops operating.
- This feature is not available while baby monitor is set to “**On**” (page 44).
- The speaker of the handset responds even if the headphones are connected.

Turning answer by voice command on/off

Handset

- 1 Press and hold **[X]** for about 2 seconds.
- 2 **[↕]**: Select the desired setting. → **[SAVE]**
 - If you selected “**OFF**”, go to step 4 to exit.
- 3 **[YES]** → The unit will display and announce the voice command guidance.
 - We recommend answering calls as demonstrated.
 - There must be a 1 second pause between the two phrases.
- 4 **To stop:** Press **[STOP]**.
To playback: Press **[YES]**.
To exit: Press **[OFF]**.

Note:

- If you wish to turn on answer by voice command feature, select “**Tone 1**” to “**Tone 5**” as your ringer tone (page 40). If another ringer tone is selected, the unit will automatically use “**Tone 1**” as the default ringer tone.

Answer by voice command sensitivity

You can adjust the sensitivity of the answer by voice command. Increase or decrease the sensitivity to adjust the sound level needed to trigger the answer by voice command feature.

Handset

- 1 **[MENU]****[#]****[1]****[0]****[7]**
- 2 **[↕]**: Select the desired setting. → **[SAVE]**
→ **[OFF]**

Answering calls

Handset / Base unit

- 1 When the unit rings, speak clearly as demonstrated by the voice guidance. Refer to step 3, “Turning answer by voice command on/off”, page 24.
- 2 When you finish talking, press **[OFF]** on the handset or **[M]** on the base unit.

Note for base unit:

- In step 1, you need to answer a call while the base unit is not ringing or not announcing caller information.

Intercom

Intercom calls can be made:

- between handsets
- between a handset and the base unit

Note:

- When paging unit(s), the paged unit(s) beeps for 1 minute.
- If you receive an outside call while talking on the intercom, the interrupt tone sounds.
 - **Handset:** To finish intercom, press **[OFF]**. To answer the call, press **[TALK/☎]**.
 - **Base unit:** To finish intercom, place the corded handset on the cradle. If the speakerphone is used, press **[☎]**. To answer the call, lift the corded handset or press **[☎]**.
- To change the handset ringer volume and ringer tone for intercom, see page 40.

Making an intercom call

Handset

- 1 **[MENU]** → **[↕]**: “Intercom” → **[SELECT]**
- 2 **[↕]**: Select the desired unit or “voice paging”. → **[SELECT]**
 - If you select “voice paging”, speak into the microphone after the beep. Your voice will be heard using the speakers of the base unit and all handsets, until a paged party answers your page or until you press **[OFF]**. After the other party answers, the speakerphone mode is turned on.
- 3 When you finish talking, press **[OFF]**.

Note:

- You can also use the **[INTERCOM]** soft key, if displayed, to make intercom calls.
- You cannot use voice paging if other units are in use.

Base unit

- 1 Press **[INTERCOM]**.
 - When 2 or more handsets are registered:**
 - [↕]**: Select the desired unit. → **[SELECT]**
 - To page all handsets, press **[0]** or wait for a few seconds.
 - Lift the corded handset if needed.
- 2 When you finish talking, press **[☎]** or place the corded handset on the cradle.

Answering an intercom call

Handset

- 1 Press **[TALK/☎]** to answer the page.
- 2 When you finish talking, press **[OFF]**.

Base unit

- 1 Press **[☎]** or lift the corded handset to answer the page.
- 2 When you finish talking, press **[☎]** or place the corded handset on the cradle.

Turning auto intercom on/off

This feature allows the handset or base unit to answer intercom calls automatically when it is called. You do not need to press **[TALK/☎]**, lift the corded handset, or press **[☎]**. When this feature is set to “On”, the monitoring handset or base unit for the baby monitor feature (page 46) will also answer baby monitor calls automatically. The default setting is “Off”.

Handset / Base unit

- 1 **[MENU]** **#** **2** **7** **3**
- 2 **[↕]**: Select the desired setting. → **[SAVE]**
- 3 Proceed with the operation for your unit.
Handset: [OFF]
Base unit: [EXIT]

Note:

- This feature is not available for all handsets paging and voice paging even if it is turned on.

Call block

You can press the **[CALL BLOCK]** button in the following situations to disconnect the current call and add a phone number to the call block list:

- when an incoming call is being received
- when an incoming call is being recorded by the answering system
- when talking on an outside call

Once a phone number has been added to the call block list, the unit will block calls from that phone number in the future.

Handset / Base unit

- 1 Press **[CALL BLOCK]** under the situations shown above.
- 2 Confirm the call block number and press **[YES]**.
 - The call block number is stored in the call block list, confirmation tone sounds*1 and “Call blocked” is displayed, and then the call is disconnected.

*1 Confirmation tones are used with permission of © 2018 Copyrights Vision Inc.

Note:

- If the call has no phone number, the call is blocked but it is not stored in the call block list.
- The call block feature is not available for intercom calls or calls received by call waiting.
- Blocked calls are logged in the caller list.

Storing unwanted callers

The unit can block calls by storing the desired items in the call block list beforehand (Caller ID subscribers only).

- “**Block a single number**”: The unit blocks calls from specific phone numbers stored in the call block list.
- “**Block range of numbers**”: The unit blocks calls that begin with a number stored in the call block list, such as a toll-free phone number prefix or certain area codes.
- “**Block unknown CID**”: The unit blocks calls that have no phone number.

Single phone numbers and ranges of numbers can be stored in the call block list up to 1,000 items in total.

Blocking unwanted callers:

When a call is received, the unit will not ring while caller information is being received*1.

If the caller's phone number matches an entry in the call block list, the unit emits no sound to the caller, and disconnects the call.

*1 If you want the first ring to sound, select “**Yes**” in “Turning the first ring on/off” (page 27).

Storing a single phone number

Important:

- We recommend storing 10 digits (including the area code). If only 7 digits are stored, all numbers that have the same last 7 digits will be blocked.

Adding call blocked numbers from the caller list

Handset

- 1 **[▼]** CID
- 2 **[↕]**: Select the desired entry to be blocked.
 - To edit the number: **[MENU]** → **[↕]**: “**Edit**” → **[SELECT]**
Press **[EDIT]** repeatedly until the phone number is shown in the 10-digit format. → **[SAVE]** → **[↕]**: “**Call block**” → **[SELECT]** → Go to step 4.
- 3 **[CALL BLOCK]**
- 4 **[↕]**: “**Yes**” → **[SELECT]**
- 5 Edit the phone number if necessary (24 digits max.) → **[SAVE]** → **[OFF]**

Base unit

- 1 **[CID]**
- 2 **[↕]**: Select the entry to be blocked.
 - To edit the number: Press **[EDIT]** repeatedly until the phone number is shown in the 10-digit format.
- 3 **[CALL BLOCK]**
- 4 **[↕]**: “**Yes**” → **[SELECT]**
- 5 Edit the phone number if necessary (24 digits max.) → **[SAVE]** → **[EXIT]**

Adding call blocked numbers manually

Handset

- 1 **[CALL BLOCK]**
- 2 **[↕]**: “**Block a single number**” → **[SELECT]**

- 3 [MENU] → [↕]: "Add" → [SELECT]
- 4 Enter the phone number (24 digits max.) → [SAVE] → [OFF]

Base unit

- 1 [CALL BLOCK]
- 2 [↕]: "Block a single number" → [SELECT] → [ADD]
- 3 Enter the phone number (24 digits max.) → [SAVE] → [EXIT]

Storing a range of number

Handset

- 1 [CALL BLOCK]
- 2 [↕]: "Block range of numbers" → [SELECT]
- 3 [MENU] → [↕]: "Add" → [SELECT]
- 4 Enter the desired number (2-8 digits) → [SAVE] → [OFF]

Base unit

- 1 [CALL BLOCK]
- 2 [↕]: "Block range of numbers" → [SELECT] → [ADD]
- 3 Enter the desired number (2-8 digits) → [SAVE] → [EXIT]

Blocking incoming calls that have no phone number

You can block calls when no phone number is provided, such as private callers or out of area calls.

Handset / Base unit

- 1 [CALL BLOCK]
- 2 [↕]: "Block unknown CID" → [SELECT]
- 3 [↕]: Select the desired setting. → [SAVE]
- 4 Proceed with the operation for your unit.
Handset: [OFF]
Base unit: [EXIT]

Turning the first ring on/off

You can choose whether the first ring sounds when a call is received.

"Yes": The first ring for all calls will be heard, including calls from blocked phone numbers.
"No" (default): The first ring is muted for all calls. If this setting is selected, the unit will never ring for calls from blocked phone numbers.

Handset / Base unit

- 1 [CALL BLOCK]
- 2 [↕]: "One ring for blocked call" → [SELECT]
- 3 [↕]: Select the desired setting. → [SAVE]
- 4 Proceed with the operation for your unit.
Handset: [OFF]
Base unit: [EXIT]

Viewing/editing/unblocking call block numbers

Handset

- 1 [CALL BLOCK]
- 2 [↕]: "Block a single number" or "Block range of numbers" → [SELECT]
- 3 [↕]: Select the desired entry.
• After viewing, press [OFF] to exit.
- 4 To edit a number:
[EDIT] → Edit the number. → [SAVE] → [OFF]

To unblock a number:

[UNBLOCK] → [↕]: "Yes" → [SELECT] → [OFF]

Base unit

- 1 [CALL BLOCK]
- 2 [↕]: "Block a single number" or "Block range of numbers" → [SELECT]
- 3 [↕]: Select the desired entry.
• After viewing, press [EXIT] to exit.
- 4 To edit a number:
[EDIT] → Edit the number. → [SAVE] → [EXIT]

To unblock a number:

[UNBLOCK] → [↕]: "Yes" → [SELECT] → [EXIT]

Note:

- When editing, press the desired dial key to add digits and press [CLEAR] to erase digits.

Unblocking all call block numbers

Handset / Base unit

- 1 **[CALL BLOCK]**
- 2 **[↕]**: “Block a single number” or “Block range of numbers” → **[SELECT]**
- 3 Proceed with the operation for your unit.
Handset: [MENU] → **[↕]**: “Unblock all” → **[SELECT]**
Base unit: [UNBLOCK]
- 4 **[↕]**: “Yes” → **[SELECT]**
- 5 **[↕]**: “Yes” → **[SELECT]**
- 6 Proceed with the operation for your unit.
Handset: [OFF]
Base unit: [EXIT]

Displaying and clearing the blocked call count

The total number of blocked calls (up to 65,000) will be displayed.

Handset

- 1 **[CALL BLOCK]**
- 2 **[↕]**: “Blocked calls count” → **[SELECT]**
 - To exit, press **[OFF]**.
- 3 **[CLEAR]**
- 4 **[↕]**: “Yes” → **[SELECT]** → **[OFF]**

Automated call block

With automated call block, the unit screens incoming calls before ringing for allowed calls, or ends the calls without ringing for calls identified as robocalls, telemarketing calls, or other undesirable calls (Caller ID subscribers only).

The unit will play the greeting message for automated call block and prompt the caller to enter an access code in order for the unit to identify whether the call is automated.

You can set the unit to block or unblock mode. The default setting is “UnbLock”.

Note:

- The unit connects the call without prompting to enter the access code in the following situations:
 - the caller’s phone number matches an entry in the phonebook (page 32).
 - the caller’s name matches an entry in the allow name list (page 30).
 - the caller’s phone number is memorized in the allowed number database (page 29).
- If the number is stored in the call block list (page 26), the unit disconnects the call without playing the greeting message for automated call block.
- The automated call block feature is not available:
 - when battery saving mode is on (page 11).
- When the answering system answers a call from a caller who is not registered in the phonebook, allow name list, or allowed number database, the following operations are delayed:
 - answering a call
 - remote turn on
 - toll saver
- When the unit receives a call from a caller who is not registered in the phonebook, allow name list, or allow number database in the following situations, the unit shifts to standby mode:
 - when searching the phonebook, caller list, call block list, or allow name list
 - when programming (depending on settings)
 - when using the answering system
 - when paging all handsets or base unit
- Blocked calls are logged in the caller list. We recommend you to check the caller list periodically. If necessary, register the entry to the phonebook or allow name list to connect the call next time.

Allowed number database

Once the caller enters the access code, the caller’s phone number is memorized in the allowed number database as an unblocked number.

Callers from this database are allowed to connect without the access code from their next call.

100 entries can be stored to the database (22 digits max. each).

Note:

- When the database memory is full, the latest call received will replace the oldest number stored in the list.
- The numbers stored in the database will be erased when you change the access code (page 29).
- The numbers stored in the database cannot be displayed.

Setting the automated call block

Handset

- 1 **[MENU]** **#** **7** **8** **7**
- 2 **[↕]**: Select the desired setting. → **[SAVE]**
- 3 **[↕]**: “Yes” → **[SELECT]** → **[OFF]**

Note:

- We recommend you perform a test run of the automated call block procedure to ensure that the automated call block feature is set correctly.

Changing the access code

If the unit answers undesirable calls such robocalls even though the automated call block function is on, change the access code (3 digits max.). The default setting is “1”.

Handset

- 1 **[MENU]** **#** **7** **8** **9**
- 2 **[CLEAR]**
- 3 Enter the new access code. → **[SAVE]** → **[OFF]**

Displaying and clearing the blocked call count

The total number of blocked calls (up to 65,000) will be displayed.

Handset

- 1 **[MENU]** **#** **7** **9** **0**
 - To exit, press **[OFF]**.
- 2 **[CLEAR]**
- 3 **[↕]**: “Yes” → **[SELECT]** → **[OFF]**

Adding to the allow name list

You can allow specific callers to pass through by adding the caller's name to the allow name list. You can store up to 100 names (16 characters max.). If the name stored in the allow name list matches the incoming Caller ID, the unit rings. Callers listed in the allow name list are not required to enter the access code.

Adding allowed names from the caller list

Handset

- 1 **[▼]** CID
- 2 **[↕]**: Select the desired entry. → **[MENU]**
- 3 **[↕]**: “Save allow name” → **[SELECT]** → **[OFF]**

Viewing/erasing an entry

Handset

- 1 **[MENU]** **#** **7** **9** **4**
- 2 **[↕]**: Select the desired entry.
 - After viewing, press **[OFF]** to exit.
- 3 **[ERASE]** → **[↕]**: “Yes” → **[SELECT]** → **[OFF]**

Erasing all entries

Handset

- 1 **[MENU]** **#** **7** **9** **4**
- 2 **[ERASE]** → **[↕]**: “Yes” → **[SELECT]**
- 3 **[↕]**: “Yes” → **[SELECT]** → **[OFF]**

Greeting message for automated call block

Handset

When the unit answers a call, a greeting message is played to the caller.

You can use either:

- your own greeting message and pre-recorded greeting message
- pre-recorded greeting message

Recording a greeting message for automated call block

Using this feature, the unit can play your own greeting message and pre-recorded greeting message.

Example of your own greeting message:

“Hi, you have reached xxxxxx (Name).”

“Thank you for your calling, You have reached xxxxxx (Name).”

“Hi, you have reached the xxxxxx (Name) residence.”

- 1 **[MENU]** **#** **7** **9** **1**
- 2 **[↕]**: “Yes” → **[SELECT]**
- 3 After a beep sounds, hold the handset about 20 cm (8 inches) away and speak clearly into the microphone (2 minutes max.).
- 4 Press **[STOP]** to stop recording.
- 5 The unit will play the recorded greeting message for automated call block. → **[OFF]**

Resetting to the pre-recorded greeting message for automated call block

This procedure will erase your greeting message for automated call block and reset to the pre-recorded one.

- 1 **[MENU]** **#** **7** **9** **3**
- 2 **[YES]** → **[OFF]**

Playing back the greeting message for automated call block

- 1 **[MENU]** **#** **7** **9** **2**
- 2 To exit, press **[OFF]**.

Telemarketing call block

In addition to Automated call block (page 29), you can use Telemarketing call block to further screen calls to stop telemarketer calls from getting through.

Using this feature, the unit will prompt callers to say their names, and after checking the names, you can decide whether to answer the calls or not.

Note:

- While screening the call, call waiting feature is unavailable (page 21).

Operating telemarketing call block

Handset

- 1 When an outside call is being received, lift the handset and then press **[TELE.BLK.]**.
 - The unit prompts callers to say their names.

- 2 **To answer the call:**

Press **[TALK/☎]**.

To block the call:

Press **[CALL BLOCK]*1** → **[YES]**.

- The unit announces that the call will be disconnected, and disconnects the call.
- The caller will be registered to call block list.

*1 The user can still answer the call after pressing **[CALL BLOCK]**. To answer the call, press **[TALK/☎]**.

Base unit

- 1 Press **[TELE.BLK.]** during an outside call.
 - The unit prompts callers to say their names.

- 2 **To answer the call:**

Lift the corded handset or press **[☎]**.

To block the call:

Press **[CALL BLOCK]*1** → **[YES]**.

- The unit announces that the call will be disconnected, and disconnects the call.
- The caller will be registered to call block list.

*1 The user can still answer the call after pressing **[CALL BLOCK]**. To answer the call, lift the corded handset or press **[☎]**.

Note:

- If there is no response from the caller, and the user does not press any key in step 2 within 10 seconds, the unit will announce that the call will be disconnected, and disconnects the call.

Note for handset:

- While on the charger, the **[TELE.BLK.]** key is not available. Lift the handset from the charger to use this feature.
- To use this feature, set the Auto talk feature to "OFF".

Phonebook

You can add 100 names (16 characters max.) and phone numbers (24 digits max.) to the phonebook, and assign each phonebook entry to the desired group (page 33).

Important:

- All entries can be shared by the base unit and any registered handset.

Adding phonebook entries

Handset / Base unit

- 1 Proceed with the operation for your unit.
Handset: [**◀**] **[□□]** → **[MENU]**
Base unit: **[□□]** → **[MENU]**
- 2 [**↕**]: “Add new entry” → **[SELECT]**
- 3 Enter the party’s name. → **[OK]**
- 4 Enter the party’s phone number. → **[OK]**
- 5 [**↕**]: Select the desired group. → **[SELECT]**
2 times
- 6 Proceed with the operation for your unit.
Handset: **[OFF]**
Base unit: **[EXIT]**

Note for base unit:

- You can also add entries as follows:
Press **[□□]**. → **[ADD]** → Go to step 3.

Entering characters

Press the dial key that corresponds to the desired character. Press repeatedly to scroll through the available characters.

The following operations are also available.

Key	Operation
[☒]	Switch between the uppercase and lowercase (A ↔ a)
[◀] [▶]	Move the cursor
[CLEAR]	Erase the character or number • To erase all, press and hold it.

- To enter another character that is located on the same dial key:
Handset: Press **[▶]** to move the cursor to the next space.
Base unit: Press **[▶▶]** to move the cursor to the next space.

- If you do not press any dial key within 2 seconds after entering a character, the character is fixed and the cursor moves to the next space.

Storing a redial list number to the phonebook

Phone numbers of up to 24 digits can be stored in the phonebook.

Handset

- 1 [**▶**] **[REDIAL]**
- 2 [**↕**]: Select the desired entry. → **[SAVE]**
- 3 To store the name, continue from step 3, “Editing entries”, page 33.

Base unit

- 1 **[REDIAL]**
- 2 [**↕**]: Select the desired entry. → **[SAVE]**
- 3 To store the name, continue from step 3, “Editing entries”, page 33.

Note for handset and base unit:

- The name stored in the phonebook will be reflected in the redial list after you make a call using that phonebook entry.

Storing caller information to the phonebook

Handset

- 1 [**▼**] **[CID]**
- 2 [**↕**]: Select the desired entry. → **[MENU]**
 - To edit the number: [**↕**]: “Edit” → **[SELECT]**
Press **[EDIT]** repeatedly until the phone number is shown in the desired format → **[SAVE]** → [**↕**]: “Phonebook” → **[SELECT]** → Go to step 4.
- 3 [**↕**]: “Save phonebook” → **[SELECT]**
- 4 Continue from step 3, “Editing entries”, page 33.

Base unit

- 1 **[CID]**
- 2 [**↕**]: Select the desired entry.
 - To edit the number, press **[EDIT]** repeatedly until the phone number is shown in the desired format.
- 3 **[SAVE]**
- 4 [**↕**]: “Phonebook” → **[SELECT]**

- 5 Continue from step 3, "Editing entries", page 33.

Groups

Groups can help you find entries in the phonebook quickly and easily. You can change the names of groups assigned for phonebook entries ("Friends", "Family", etc.). By assigning different ringer tones for different groups of callers, you can identify who is calling (ringer ID), if you have subscribed to Caller ID service.

Changing group names/setting ringer ID

The default group name is "Group 1" to "Group 9".

Handset / Base unit

- Proceed with the operation for your unit.
Handset: [←] □□ → [MENU]
Base unit: [□□] → [MENU]
- [↕]: "Group" → [SELECT]
- [↕]: Select the desired group. → [SELECT]
- To change group names**
[↕]: "Group name" → [SELECT] → Edit the name (10 characters max.). → [SAVE]
- To set group ringer tone (handset)**
[↕]: Select the current setting of the group ringer tone. → [SELECT] → [↕]: Select the desired ringer tone. → [SAVE]
- Proceed with the operation for your unit.
Handset: [OFF]
Base unit: [EXIT]

Finding and calling from a phonebook entry

Handset / Base unit

- Proceed with the operation for your unit.
Handset: [←] □□
Base unit: [□□]
- To scroll through all entries**
[↕]: Select the desired entry.
To search by first character
 - Press the dial key ([0] to [9], or [#]) which contains the character you are searching for.
 - [↕]: Scroll through the phonebook if necessary.**To search by group**

- [GROUP]
- [↕]: Select the desired group. → [SELECT]
- [↕]: Scroll through the phonebook if necessary.

- 3 Proceed with the operation for your unit.
Handset: [TALK/☎]
Base unit: Lift the corded handset.

Editing entries

Handset

- Find the desired entry (page 33).
- [MENU] → [↕]: "Edit" → [SELECT]
- Edit the name if necessary. → [OK]
- Edit the phone number if necessary. → [OK]
- [↕]: Select the desired group (page 33). → [SELECT] 2 times → [OFF]

Base unit

- Find the desired entry (page 33).
- [EDIT]
- Edit the name if necessary. → [OK]
- Edit the phone number if necessary. → [OK]
- [↕]: Select the desired group (page 33). → [SELECT] 2 times → [EXIT]

Erasing entries

Erasing an entry

Handset

- Find the desired entry (page 33).
- [MENU] → [↕]: "Erase" → [SELECT]
- [↕]: "Yes" → [SELECT] → [OFF]

Base unit

- Find the desired entry (page 33).
- [ERASE] → [↕]: "Yes" → [SELECT] → [EXIT]

Erasing all entries

Handset / Base unit

- Proceed with the operation for your unit.
Handset: [←] □□ → [MENU]
Base unit: [□□] → [MENU]
- [↕]: "Erase all" → [SELECT]

- 3 [↕]: “Yes” → [SELECT]
- 4 [↕]: “Yes” → [SELECT]
- 5 Proceed with the operation for your unit.
Handset: [OFF]
Base unit: [EXIT]

Chain dial

This feature allows you to dial phone numbers in the phonebook while you are on a call. This feature can be used, for example, to dial a calling card access number or bank account PIN that you have stored in the phonebook, without having to dial manually.

Handset / Base unit

- 1 Proceed with the operation for your unit.
Handset: During an outside call, press [←] □□.
Base unit: During an outside call, press [□□].
- 2 [↕]: Select the desired entry.
- 3 Press [CALL] to dial the number.

Note:

- When storing a calling card access number and your PIN in the phonebook as one phonebook entry, press [▲] (Pause) on the handset or [PAUSE] on the base unit to add pauses after the number and PIN as necessary (page 19).
- If you have rotary/pulse service, you need to press [X] before pressing [←] □□ on the handset or [□□] on the base unit in step 1 to change the dialing mode temporarily to tone. When adding entries to the phonebook, we recommend adding [X] to the beginning of phone numbers you wish to chain dial (page 32).

Speed dial

You can store phone numbers to the base unit and handset separately:

- Handset: up to 9 entries.
- Base unit: up to 9 entries.

Adding phone numbers to speed dial keys

Handset/Base unit

You can assign 1 phone number to each of the dial keys ([1] to [9]).

■ By entering phone numbers:

- 1 Press and hold the desired speed dial key ([1] to [9]).
- 2 Proceed with the operation for your unit.
Handset: [ADD] → [↕]: “Manual” → [SELECT]
Base unit: [EDIT]
- 3 Enter the party's name (16 characters max.). → [OK]
- 4 Enter the party's phone number (24 digits max.). → [OK] → [SELECT]
- 5 Proceed with the operation for your unit.
Handset: [OFF]
Base unit: [EXIT]

■ From the phonebook:

- 1 Press and hold the desired speed dial key ([1] to [9]).
- 2 Proceed with the operation for your unit.
Handset: [ADD] → [↕]: “Phonebook” → [SELECT]
Base unit: [□□]
- 3 [↕]: Select the desired entry. → [SAVE]
- 4 Proceed with the operation for your unit.
Handset: [OFF]
Base unit: [EXIT]

Note for handset and base unit:

- If you edit a phonebook entry which is assigned to a speed dial key, the edited entry does not transfer to the speed dial key.

Editing an entry

Handset/Base unit

- 1 Press and hold the desired speed dial key ([1] to [9]).
- 2 Proceed with the operation for your unit.
Handset: [MENU] → [↕]: “Edit” → [SELECT]
Base unit: [EDIT]
- 3 Edit the name if necessary. → [OK]
- 4 Edit the phone number if necessary. → [OK] → [SELECT]
- 5 Proceed with the operation for your unit.
Handset: [OFF]
Base unit: [EXIT]

Erasing an entry

Handset / Base unit

- 1 Press and hold the desired speed dial key ([1] to [9]).
- 2 Proceed with the operation for your unit.
Handset: **[MENU]** → [↕]: “Erase” → **[SELECT]**
Base unit: **[ERASE]**
- 3 [↕]: “Yes” → **[SELECT]**
- 4 Proceed with the operation for your unit.
Handset: **[OFF]**
Base unit: **[EXIT]**

Viewing an entry/Making a call

Handset

- 1 Press and hold the desired speed dial key ([1] to [9]).
- 2 To make a call, press **[TALK/☎]**.

Base unit

- 1 Press and hold the desired speed dial key ([1] to [9]).
- 2 Lift the corded handset.

One-touch dial buttons

You can store phone numbers or extension numbers to the base unit's one-touch dial buttons (1 or 2).

- phone numbers for outside calls
- extension numbers for handsets

Note:

- You can transfer a call to a handset. While you are on an outside call, press the one-touch dial button with an extension number stored. The line is put on hold and the base unit pages the handset. After the handset answers the page, place the corded handset on the cradle to complete the transfer.

Adding phone numbers for outside calls

Base unit

■ By entering phone numbers:

- 1 Press and hold the desired one-touch dial button (1 or 2). → **[EDIT]**
- 2 Enter the party's name (16 characters max.). → **[OK]**
- 3 Enter the party's phone number (24 digits max.). → **[OK]** → **[SELECT]** → **[EXIT]**

■ From the phonebook:

- 1 Press and hold the desired one-touch dial button (1 or 2).
- 2 [☐☐]
- 3 [↕]: Select the desired entry. → **[SAVE]** → **[EXIT]**

Note:

- If you edit a phonebook entry which is assigned to a one-touch dial button, the edited entry does not transfer to the one-touch dial button.

Adding extension numbers for handsets

Base unit

- 1 Press and hold the desired one-touch dial button (1 or 2). → **[EDIT]**
- 2 Press **[INT]**.
- 3 [↕]: Select the desired unit. → **[SELECT]** 2 times → **[EXIT]**

Viewing/editing/erasing an entry

Base unit

- 1 Press and hold the desired one-touch dial button (1 or 2).
 - After viewing, press **[EXIT]** to exit.
- 2 **To edit an entry**
[EDIT] → Edit the name if necessary. → **[OK]** → Edit the phone number if necessary. → **[OK]** → **[SELECT]** → **[EXIT]**
To erase an entry
[ERASE] → [↕]: “Yes” → **[SELECT]** → **[EXIT]**

Making a call

Base unit

Press the desired one-touch dial button (1 or 2), then lift the corded handset.

Note:

- You can dial phone numbers in the one-touch dial button while you are on a call.

Menu list

To access the features, there are 2 methods.

Handset / Base unit





■ Scrolling through the display menus

- 1 **[MENU]**
- 2 Press **[▼]** or **[▲]** to select the desired main menu. → **[SELECT]**
- 3 Press **[▼]** or **[▲]** to select the desired item from the next sub-menus. → **[SELECT]**
- 4 Press **[▼]** or **[▲]** to select the desired setting. → **[SAVE]**

■ Using the direct command code



- 1 **[MENU]** → Enter the desired code.
Example: Press **[MENU][#][1][0][1]**.
- 2 Select the desired setting. → **[SAVE]**

Note:



- The unit column shows the unit(s) that can be used to program the item.
 - : Only the handset can program the item.
 - : Only the base unit can program the item.
 - : Both the handset and base unit can program the item.
- To exit the operation, press **[OFF]** on the handset or **[EXIT]** on the base unit.
- In the following table, < > indicates the default settings.
- In the following table,  indicates the reference page number.
- Display menu order and sub-menu may vary depending on your model.

Display menu tree and direct command code table

Main menu:  "Phonebook"

Operation	Code	Unit	
Viewing the phonebook entry.	#280		33





Main menu:  "Caller list"

Operation	Code	Unit	
Viewing the caller list.	#213		49













Main menu:

Handset:  "Answering device"

Base unit:  "Answering device"

Sub-menu 1	Sub-menu 2	Settings	Code	Unit	
Play new message	–	–	#323		52
Play all message	–	–	#324		52
Erase all message*1	–	–	#325		53



Programming

Sub-menu 1	Sub-menu 2	Settings	Code	Unit	
Greeting	Record greeting* ¹	–	#302		51
	Check greeting	–	#303		52
	Pre-recorded* ¹ (Reset to pre-recorded greeting)	–	#304		52
New message alert* ¹	Outgoing call – On/Off	On <Off>	#338		53
	Outgoing call – Notification to	–			
	Outgoing call – Remote code	Activate <Inactivate>			
	Base unit beep	On <Off>	#339		53
Settings	Ring count* ¹	Toll saver 2-7 rings <4 rings>	#211		56
	Recording time* ¹	<3 min> 1 min Greeting only* ²	#305		56
	Remote code* ¹	<111>	#306		55
	Screen call	<On> Off	#310		56
Answer on* ¹	–	–	#327		51
Answer off* ¹	–	–	#328		51



Main menu:  “Voicemail access”







Operation	Code	Unit	
Listening to voicemail messages.	#330		58

Main menu:  “Intercom”





Operation	Code	Unit	
Paging the desired unit.	#274		25

Main menu:  “Bluetooth”

Sub-menu 1	Sub-menu 2	Settings	Code	Unit	
On/Off	–	On <Off>	#613		16

Sub-menu 1	Sub-menu 2	Settings	Code	Unit	
Headphone* ³ – 1:Add new device (for Headphone 1)* ⁴ – 2:Add new device (for Headphone 2)* ⁴ – 3:Add new device (for Headphone 3)* ⁴ – 4:Add new device (for Headphone 4)* ⁴	Connect/ Disconnect	–	#6461* ⁵ #6462* ⁶ #6463* ⁷ #6464* ⁸		16
	Change name	–	#6471* ⁵ #6472* ⁶ #6473* ⁷ #6474* ⁸		17
	Pair	–	#6481* ⁵ #6482* ⁶ #6483* ⁷ #6484* ⁸		16
	Unpair	–	#6491* ⁵ #6492* ⁶ #6493* ⁷ #6494* ⁸		17
Connection after the call* ³	–	<Stay connected> Disconnect	#644		–
Set PIN* ³	–	<0000>	#645		17

Main menu:  “Set date & time”



























Sub-menu 1	Sub-menu 2	Settings	Code	Unit	
Date and time* ¹	–	–	#101		15
Memo alarm	Alarm1-3	<Off> Once Daily Weekly	#720		43
Time adjustment* ^{1, *9}	–	<Caller ID auto> Manual	#226		–



















Main menu:  “Speed dial”

Operation	Code	Unit	
Viewing the speed dial entry.	#261		34













Programming

Main menu:  "Settings"



Sub-menu 1	Sub-menu 2	Settings	Code	Unit		
Ring adjustments	Ringer volume (Incoming)	Off-6 <6>	#160		–	
	Ringer volume	Off-6 <6>	#160		–	
	Intercom ringer volume	1–6 <6>	#175		–	
	Ringer tone (Incoming) ^{*10, *11}	<Tone 1>	#161		–	
	Intercom ringer tone ^{*10, *11}	<Tone 3>	#163		–	
	Night mode – On/Off	On <Off>	#238	 	44	
	Night mode – Start/End	<11:00 PM/06:00 AM>	#237	 	44	
	Night mode – Select group	Group 1-9	#241	 	44	
Set date & time	Date and time ^{*1}	–	#101	 	15	
	Memo alarm – Alarm1-3	<Off> Once Daily Weekly	#720		43	
	Time adjustment ^{*1, *9}	<Caller ID auto> Manual	#226	 	–	
Talking caller ID	–	Handset: <On> Off Base unit: On <Off>	#162	 	48	
Low battery alert	–	Off <Every hour> Every 3 hours Every 6 hours	#176		15	
Automated call block ^{*1}	Block/Unblock	Block <Unblock>	#787		29	
	Allow name list	–	#794		30	
	Access code	<1>	#789		29	
	Automated call greeting	Record greeting	Record greeting	#791		30
		Check greeting	Check greeting	#792		30
		Pre-recorded	Pre-recorded	#793		30
	Blocked calls count	–	#790		30	

Sub-menu 1	Sub-menu 2	Settings	Code	Unit	
Call block* ¹	Block a single number	–	#217		26
	Block range of numbers	–			27
	Block unknown CID (CID: Caller ID)	Block <Unblock>	#240		27
	One ring for blocked call	Yes <No>	#173		27
	Blocked calls count	–	#177		28
One-touch dial	–	–	#247		35
Speed dial	–	–	#261		34
Record greeting* ¹	–	–	#302		51
Voicemail	Save VM access#* ¹ , * ¹² (VM: Voicemail) Save voicemail access#* ¹ , * ¹³	–	#331		57
	VM tone detect* ¹	<On> Off	#332		57
LCD contrast (Display contrast)	–	Handset: Level 1-4 <2> Base unit: Level 1-6 <3>	#145		–
Handset name	–	–	#104		46
Display name	–	On <Off>	#105		46
Answer by voice command* ¹	On/Off	On <Off>	#106		24
	Sensitivity level	Low <Normal> High	#107		24
Auto intercom	–	On <Off>	#273		25
Key tone	–	<On> Off	#165		–
Auto talk* ¹⁴	–	On <Off>	#200		20



Programming

Sub-menu 1	Sub-menu 2	Settings	Code	Unit	
Set tel line* ¹	Set dial mode	<Tone> Pulse	#120		15
	Set flash time* ¹⁵	80 ms 90 ms 100 ms 110 ms 160 ms 200 ms 250 ms 300 ms 400 ms 600 ms <700 ms> 900 ms	#121		21
	Set line mode* ¹⁶	A 	#122		–
	C. WTG options (Call Waiting Deluxe options)	On <Off>	#215		48
Privacy mode* ¹	–	On <Off>	#194		22
Registration	Register handset	–	#130		47
	Deregistration* ²	–	#131		47
Deregistration* ²	–	–	#131		47
Battery saving mode	–	On <Off>	#150		11
Change language	Display	<English> Français	#110		14
	Announcement* ¹	<English> Français	#112		14

Main menu: “Customer support”

Operation	Code	Unit	
Displaying customer support Web address.	#680		–

Main menu: “Baby monitor”

Sub-menu 1	Sub-menu 2	Settings	Code	Unit	
On/Off	–	On <Off>	#268		45
Sensitivity level	–	Low <Middle> High	#269		46

*1 If you program these settings using one of the units, you do not need to program the same item using another unit.

*2 This menu is not displayed when scrolling through the display menus. It is only available in direct command code.

- *3 When the Bluetooth feature for handset is turned off, these menus are not displayed (page 16).
- *4 After the Bluetooth headphone is paired, the headphone name is displayed.
- *5 For Headphone 1.
- *6 For Headphone 2.
- *7 For Headphone 3.
- *8 For Headphone 4.
- *9 To use this feature, set the date and time first (page 15).
This feature allows the unit to automatically adjust the date and time each time caller information including date and time is received. (Caller ID subscribers only)
To turn this feature on, select “**Caller ID auto**”.
To turn this feature off, select “**Manual**”.
- *10 The preset melodies in this product (“**Melody 1**” - “**Melody 10**”) are used with permission of © 2012 Copyrights Vision Inc.
- *11 If you subscribe to a distinctive ring service, select a tone (tone 1 to 5). If you select a melody, you cannot distinguish lines by their ringers.
- *12 Handset
- *13 Base unit
- *14 If you subscribe to a Caller ID service and want to view the caller’s information after lifting up the handset to answer a call, turn off this feature.
- *15 The flash time depends on your telephone exchange or host PBX. Contact your PBX supplier if necessary.
- *16 Generally, the line mode setting should not be changed. This setting automatically maintains receiver volume at the proper level depending on the current telephone line condition. Set the line mode to “**A**” if telephone line condition is not good.

Alarm

An alarm sounds at the set time for 1 minute and is repeated 5 times at 5 minute intervals (snooze function). A text memo can also be displayed for the alarm. A total of 3 separate alarm times can be programmed for each handset. You can set one of 3 different alarm options (once, daily, or weekly) for each alarm time.

Important:

- Make sure the unit’s date and time setting is correct (page 15).

Handset

- 1 **[MENU]** **#** **7** **2** **0**
- 2 **[↕]**: Select the desired alarm. → **[SELECT]**
- 3 **[↕]**: Select the desired alarm option. → **[SELECT]**

“Off”	Turns alarm off. Go to step 10.
“Once”	An alarm sounds once at the set time.
“Daily”	An alarm sounds daily at the set time. Go to step 5.

“Weekly”	Alarm sounds weekly at the set time(s).
----------	---

- 4 Proceed with the operation according to your selection in step 3.
 - **Once:**
Enter the desired month and date. → **[OK]**
 - **Weekly:**
[↕]: Select the desired day of the week and press **[SELECT]**. → **[OK]**
 - 5 Set the desired time.
 - 6 **[☒]**: Select “**AM**” or “**PM**”. → **[OK]**
 - 7 Enter a text memo (10 characters max.). → **[OK]**
 - 8 **[↕]**: Select the desired alarm tone. → **[SELECT]**
 - We recommend selecting a different ringer tone from the one used for outside calls.
 - 9 **[↕]**: Select the desired snooze setting. → **[SAVE]**
 - 10 **[SELECT]** → **[OFF]**
- Note:**
- Press **[STOP]** to stop the alarm completely.

Programming

- When the handset is in use, the alarm will not sound until the handset is in standby mode.
- Press any dial key or **[SNOOZE]** to stop the sound but keep the snooze function activated.
- If you want to make an outside call when the snooze function is activated, please stop the snooze function before making the call.

Night mode

Night mode allows you to select a period of time during which the handset and/or base unit will not ring for outside calls. This feature is useful for time periods when you do not want to be disturbed, for example, while sleeping. Night mode can be set for each unit.

Using the phonebook's group feature (page 33), you can also select groups of callers whose calls override night mode and ring the unit (Caller ID subscribers only).

Important:

- Make sure the unit's date and time setting is correct (page 15).
- If you have set the alarm, the alarm sounds even if the night mode is turned on.

Turning night mode on/off

Handset

- 1 **[MENU]** **#** **2** **3** **8**
- 2 **[↕]**: Select the desired setting. → **[SAVE]**
 - If you select "0££", press **[OFF]** to exit.
- 3 Enter the desired hour and minute you wish to start this feature.
- 4 **[x]**: Select "AM" or "PM". → **[OK]**
- 5 Enter the desired hour and minute you wish to end this feature.
- 6 **[x]**: Select "AM" or "PM".
- 7 **[SAVE]** → **[OFF]**

Base unit

- 1 **[MENU]** **#** **2** **3** **8**
- 2 **[↕]**: Select the desired setting. → **[SAVE]**
 - If you select "0££", press **[EXIT]** to exit.
- 3 Enter the desired hour and minute you wish to start this feature.
- 4 **[AM/PM]**: Select "AM" or "PM". → **[OK]**

- 5 Enter the desired hour and minute you wish to end this feature.
- 6 **[AM/PM]**: Select "AM" or "PM".
- 7 **[SAVE]** → **[EXIT]**

Changing the start and end time

Handset / Base unit

- 1 **[MENU]** **#** **2** **3** **7**
- 2 Continue from step 3 for handset or step 3 for base unit, "Turning night mode on/off", page 44.

Selecting groups to bypass night mode

Handset / Base unit

- 1 **[MENU]** **#** **2** **4** **1**
- 2 **[↕]**: Select the desired groups. → **[SELECT]**
 - "✓" is displayed next to the selected group numbers.
 - To cancel the selected group:
[↕]: Select the group. → Press **[SELECT]** again. "✓" disappears.
- 3 **[SAVE]**
- 4 Proceed with the operation for your unit.
Handset: [OFF]
Base unit: [EXIT]

Baby monitor

This feature allows you to listen in on a room where another handset is located, allowing you to easily monitor from different areas of the house or even while away from home. The monitored handset (placed in a baby's room, for example) will automatically call the monitoring handset, base unit, or the phone number stored when it detects sound.

Important:

- Before using this feature, we recommend that you test it and adjust the baby monitor sensitivity as needed, especially if you plan to monitor from outside.
- This feature should not be used as a substitute for a medical or caregiver's supervision. It is the caregiver's responsibility to stay close enough to handle any eventuality.

Note:

- If the unit is connected to a PBX system, you cannot set the baby monitor.
- During the monitoring mode, battery consumption is faster than usual. We recommend leaving the monitored handset on charger.
- The monitored handset never rings while it is being monitored. If the base unit is placed near the monitored handset, we recommend turning off the base unit ringer volume (page 40).

Setting the baby monitor

Perform the setting operation with the handset to be monitored (for example, the handset placed in a baby's room).

To monitor with a unit

The internal baby monitor feature is available:

- between handsets
- between a handset and the base unit

Handset

- 1 **[MENU]#268**
- 2 **[↕]: "On" → [SELECT]**
- 3 **[↕]:** Select the desired unit's number to monitor with. → **[SAVE]**
 - "Baby monitor" will be displayed.
 - The registered unit's name/number is displayed.

Note:

- When this feature is on, another handset or the base unit can hear the monitored handset by making an intercom call.

To monitor from outside

If you enable this feature, the unit will call a pre-programmed phone number when the handset detects sound. After you answer the call, you can listen in on the room where the handset is located.

Handset

■ From the phonebook:

- 1 **[MENU]#268**
- 2 **[↕]: "On" → [SELECT]**
- 3 **[↕]:** Select "Outgoing call" to monitor from outside. → **[ADD]**
- 4 **[↕]: "Phonebook" → [SELECT]**

- 5 **[↕]:** Select the phonebook entry. → **[SAVE]**
 - "Baby monitor" will be displayed.

Note:

- If you edit a phonebook entry which is assigned for monitoring, the edited entry does not transfer to the monitor.

■ By entering phone numbers:

- 1 **[MENU]#268**
- 2 **[↕]: "On" → [SELECT]**
- 3 **[↕]:** Select "Outgoing call" to monitor from outside. → **[ADD]**
- 4 **[↕]: "Manual" → [SELECT]**
- 5 Enter the desired name. → **[OK]**
- 6 Enter the desired number. → **[OK] → [SELECT]**
 - "Baby monitor" will be displayed.

Note:

- The registered name/number is displayed.

Turning off the baby monitor

The monitored handset cannot be used while baby monitor is set to "On".

Handset

- 1 Press **[MENU]** on the handset being monitored.
- 2 **[↕]: "On/Off" → [SELECT]**
- 3 **[↕]: "Off" → [SELECT] → [OFF]**

Editing an outside monitoring number

Handset

- 1 Press **[MENU]** on the handset being monitored.
- 2 **[↕]: "On/Off" → [SELECT]**
- 3 **[↕]: "On" → [SELECT]**
- 4 **[↕]:** Select the outside line. → **[MENU]**
- 5 **[↕]: "Edit" → [SELECT]**
- 6 Edit the name if necessary. → **[OK]**
- 7 Edit the phone number if necessary. → **[OK] → [SELECT]**

Erasing an outside monitoring number

Handset

- 1 Press **[MENU]** on the handset being monitored.
- 2 **[↕]**: “On/Off” → **[SELECT]**
- 3 **[↕]**: “On” → **[SELECT]**
- 4 **[↕]**: Select the outside line. → **[MENU]**
- 5 **[↕]**: “Erase” → **[SELECT]**
- 6 **[↕]**: “Yes” → **[SELECT]** → **[OFF]**

Baby monitor sensitivity

You can adjust the sensitivity of the baby monitor. Increase or decrease the sensitivity to adjust the sound level needed to trigger the baby monitor feature.

- This feature cannot be set during a monitoring call.

Handset

- 1 Press **[MENU]** on the handset being monitored.
- 2 **[↕]**: “Sensitivity level” → **[SELECT]**
- 3 **[↕]**: Select the desired setting. → **[SAVE]** → **[OFF]**

Answering the baby monitor

Handset / Base unit

■ When monitoring with a unit:

Handset: Press **[TALK/📞]** to answer a call.

Base unit: Press **[📞]** to answer a call.

If you want to respond from the monitoring unit, press **[MUTE]**.

- The monitoring unit will respond calls automatically when the auto intercom feature is set to “On” (page 25).

Note:

- If you receive an outside call when communicating with the monitored handset, the interrupt tone sounds.
 - To answer the call with the handset, press **[OFF]**, then press **[TALK/📞]**.
 - To answer the call with the base unit, press **[📞]** 3 times.*¹

*¹ If **[MUTE]** is pressed, press **[📞]** 2 times.

■ When monitoring from outside:

Answer the call.

If you want to respond from your monitoring phone, press **[#1]** using tone dialing.

You can turn off the baby monitor feature by pressing **[#0]**.

Note:

- The unit disconnects the call automatically after 2 minutes.

Other programming

Changing the handset name

The default handset name is “Handset 1” to “Handset 6”. You can customize the name of each handset (“Bob”, “Kitchen”, etc.). This is useful when you make intercom calls between handsets. To display the handset name in standby mode, turn on the handset name display feature (page 46).

Handset

- 1 **[MENU]****[#104]**
- 2 Enter the desired name (10 characters max.). → **[SAVE]** → **[OFF]**

Displaying the handset name

You can select whether or not the handset name is displayed in standby mode. The default setting is “Off”.

Handset

- 1 **[MENU]****[#105]**
- 2 **[↕]**: Select the desired setting. → **[SAVE]** → **[OFF]**

Registering a unit

Operating additional units

Additional handsets

Up to 6 handsets can be registered to the base unit.

Important:

- See page 4 for information on the available model.

Registering a handset to the base unit

The supplied handset and base unit are pre-registered. If for some reason the handset is not registered to the base unit, re-register the handset.

1 Handset:

[MENU] **#** **1** **3** **0**

2 Base unit:

Press and hold **[LOCATOR]** for about 5 seconds.

- If all registered handsets start ringing, press **[LOCATOR]** again to stop, then repeat this step.

3 Handset:

Press **[OK]**, then wait until a long beep sounds.

Deregistering a handset

A handset can cancel its own registration to the base unit, or other handsets registered to the same base unit. This allows the handset to end its wireless connection with the system.

Handset / Base unit**1 [MENU] # 1 3 1**

- All handsets registered to the base unit are displayed.

2 [↕]: Select the handset you want to cancel.
→ **[SELECT]****3 [↕]:** “Yes” → **[SELECT]****4** Proceed with the operation for your unit.

Handset: **[OFF]**

Base unit: **[EXIT]**

Using Caller ID service

Important:

- This unit is Caller ID compatible. To use Caller ID features, you must subscribe to a Caller ID service. Contact your phone service provider for details.

Caller ID features

Handset / Base unit

When an outside call is being received, the caller information is displayed.

Caller information for the last 50 callers is logged in the caller list from the most recent call to the oldest.

- If the unit cannot receive caller information, the following is displayed:
 - “Unavailable”^{*1}/“Unavailable Name & No.”^{*2}: The caller dials from an area which does not provide a Caller ID service.
 - “Private caller”: The caller requests not to send caller information.
 - “Long distance”: The caller makes a long distance call.
- If the unit is connected to a PBX system, caller information may not be properly received. Contact your PBX supplier.

*1 Handset

*2 Base unit

Missed calls

Handset / Base unit

If a call is not answered, the unit treats it as a missed call. The display shows “Missed call”.

Note:

- Even when there are unviewed missed calls, “Missed call” disappears from the standby display if the following operation is performed by one of the units:
 - A handset is replaced on the charger.
 - Pressing **[OFF]** on a handset.
 - Pressing **[EXIT]** on the base unit.

Phonebook name display

When caller information is received and it matches a phone number stored in the phonebook, the stored name in the phonebook is displayed and logged in the caller list.

Talking Caller ID

Handset / Base unit

This feature lets you know who is calling without looking at the display.

To use this feature, you must:

- subscribe to a Caller ID service of your phone service provider.
- turn this feature on (page 40).

When caller information is received, the handsets and/or base unit announce the caller’s name or phone number received from your phone service provider following every ring.

- Name pronunciation may vary. This feature may not pronounce all names correctly.
- Caller ID service has a limit of how many characters can be displayed. If the caller’s name is too long, the unit may not be able to display or announce the entire name.

Phonebook name announcement

When caller information is received and it matches a phone number stored in the phonebook, the stored name in the phonebook is announced.

For Call Waiting Deluxe service users

To use Call Waiting Deluxe, you must subscribe to Call Waiting Deluxe from your phone service provider. This feature not only allows the unit currently in use to display the 2nd caller’s information, but also offers you a variety of ways to deal with the 2nd call.

Important:

- Please contact your phone service provider for details and availability of this service in your area.
- This feature must be turned on before it can be used.

To turn Call Waiting Deluxe on/off

Handset / Base unit

To use Call Waiting Deluxe, you must turn this feature on. The default setting is “OFF”.

- 1 **[MENU]** **[#]** **[2]** **[1]** **[5]**
- 2 **[↕]**: Select the desired setting.
- 3 **[SAVE]**
- 4 Proceed with the operation for your unit.
Handset: [OFF]

Base unit: [EXIT]

Call Waiting Deluxe service options

When a 2nd call is received, you can choose how to handle the call by selecting an option shown on the unit display.

Note:

- Your phone service provider may not offer all of the options (page 49).

Displayed option	Function
Answer	Answers the waiting call, while keeping the 1st call on hold.
Hold	Holds the waiting call. The caller will hear the pre-recorded hold message played by your phone service provider.
Announce	The caller will hear the pre-recorded busy message played by your phone service provider (for example, "We are not available now.") and will then be disconnected.
Forward	Forwards the waiting call to the voicemail service provided by your phone service provider. You must subscribe to voicemail service to use this function.
Drop	Disconnects (drops) the current call and answers the waiting call.
Conference	Answers the waiting call and combines it with the current call to make a conference call (3-party call).
Return	Returns to the waiting caller while keeping the current call on hold.
Drop caller1	Disconnects (drops) the 1st call during a conference call.
Drop caller2	Disconnects (drops) the 2nd call during a conference call.

To use Call Waiting Deluxe service

Handset / Base unit

- When you hear a Call Waiting tone during an outside call, press [FLASH].
 - The option menu is displayed.
- [↕]: Select the desired option. → [SELECT]
 - After selecting "Answer", "Hold", or "Conference", you can select another option. → [FLASH] → [↕]: Select the desired option. → [SELECT]

Note:

- To exit from the option menu, wait for 20 seconds.

Caller list

Important:

- Make sure the unit's date and time setting is correct (page 15).

Viewing the caller list and calling back

Handset / Base unit

- Proceed with the operation for your unit.

Handset: [▼] CID
Base unit: [CID]
- Press [▼] to search from the most recent call, or [▲] to search from the oldest call.
- Proceed with the operation for your unit.

Handset:

 - To call back, press [TALK/☎].
 - To exit, press [OFF].

Base unit:

 - To call back, lift the corded handset.
 - To exit, press [EXIT].

Note:

- If the entry has already been viewed or answered, "✓" is displayed.
 - Handset:** "☎#" or "☎" indicates the caller information for blocked calls.
 - Base unit:** "☎" or "☎" indicates the caller information for blocked calls.

Editing a caller's phone number

You can edit a phone number in the caller list by adding the long distance code "1" or removing its area code.

Handset

- 1 **[▼]** CID
- 2 **[↕]**: Select the desired entry. → **[MENU]**
- 3 **[↕]**: "Edit" → **[SELECT]**
- 4 Press **[EDIT]** repeatedly until the phone number is shown in the desired format.
- 5 **[TALK/☎]**

Base unit

- 1 **[CID]**
- 2 **[↕]**: Select the desired entry.
- 3 Press **[EDIT]** repeatedly until the phone number is shown in the desired format.
- 4 Lift the corded handset.

Note:

- The edited phone number is not saved in the caller list.

Erasing selected caller information

Handset / Base unit

- 1 Proceed with the operation for your unit.
Handset: **[▼]** CID
Base unit: **[CID]**
- 2 **[↕]**: Select the desired entry.
- 3 **[ERASE]** → **[↕]**: "Yes" → **[SELECT]**
- 4 Proceed with the operation for your unit.
Handset: **[OFF]**
Base unit: **[EXIT]**

Erasing all caller information

Handset / Base unit

- 1 Proceed with the operation for your unit.
Handset: **[▼]** CID
Base unit: **[CID]**
- 2 **[ERASE]** → **[↕]**: "Yes" → **[SELECT]**
- 3 Proceed with the operation for your unit.
Handset: **[OFF]**
Base unit: **[EXIT]**

Answering system

The answering system can answer and record calls for you when you are unavailable to answer the phone.

The unit can be set to play a greeting message but not to record caller messages by selecting “**Greeting only**” as the recording time setting (page 56).

You can also record phone conversations (page 22).

Important:

- Make sure the unit’s date and time setting is correct (page 15).

Memory capacity (including your greeting message)

The total recording capacity is about 15 minutes. A maximum of 64 messages can be recorded.

Note:

- When message memory becomes full:
 - “**Messages full**” is shown on the handset and base unit display.
 - The ANSWER ON/OFF indicator on the base unit flashes rapidly if the answering system is turned on.
 - If you use the pre-recorded greeting message, the unit automatically switches to another pre-recorded greeting message asking callers to call again later.
 - If you recorded your own greeting message, the same message is still announced to callers even though their messages are not recorded.

Turning the answering system on/off

Base unit

Press **[ANSWER ON/OFF]** to turn on/off the answering system.

Handset

- 1 To turn on:
[MENU]#327
To turn off:
[MENU]#328

2 [OFF]

Note for handset and base unit:

- When the answering system is turned on, the ANSWER ON/OFF indicator on the base unit lights up.

Greeting message

When the unit answers a call, a greeting message is played to callers.

You can use either:

- your own greeting message
- a pre-recorded greeting message

Recording your greeting message

Handset / Base unit

- 1 **[MENU]#302**
- 2 **[↕]: “yes” → [SELECT]**
- 3 After a beep sounds, speak clearly about 20 cm (8 inches) away from the microphone (2 minutes max.).
- 4 Press **[STOP]** to stop recording.
- 5 Proceed with the operation for your unit.
Handset: [OFF]
Base unit: [EXIT]

Using a pre-recorded greeting message

The unit provides 2 pre-recorded greeting messages:

- If you reset to pre-recorded greeting or do not record your own greeting message, the unit plays a pre-recorded greeting asking callers to leave a message.
- If the message recording time (page 56) is set to “**Greeting only**”, callers’ messages are not recorded and the unit plays a different pre-recorded greeting message asking callers to call again.

Answering System

Resetting to a pre-recorded greeting message

Use this procedure to erase your greeting message and use a pre-recorded one.

Handset / Base unit

- 1 **[MENU]** **#** **3** **0** **4**
- 2 **[YES]**
- 3 Proceed with the operation for your unit.
Handset: **[OFF]**
Base unit: **[EXIT]**

Playing back the greeting message

Handset / Base unit

- 1 **[MENU]** **#** **3** **0** **3**
- 2 Proceed with the operation for your unit.
Handset: To exit, press **[OFF]**.
Base unit: To exit, press **[EXIT]**.

Listening to messages

Important:

- When using the base unit or handset to listen to messages, the noise reduction feature (page 21) is activated automatically in spite of the setting (**NR** is not displayed).

Using the base unit

When new messages have been recorded:

- **[▶■]** on the base unit flashes.
- “New message” is displayed.

Press **[▶■]** (PLAY).

- During playback, **[▶■]** on the base unit lights.
- If new messages have been recorded, the base unit plays back new messages.
- If there are no new messages, the base unit plays back all messages.

Operating the answering system during playback

Key	Operation
[▲] or [▼]	Adjust the speaker volume
[◀◀]	Repeat message*1
[▶▶]	Skip message

Key	Operation
[PAUSE]	Pause message To resume playback, press [▶■] .
[▶■] (STOP)	Stop playback
[ERASE]	Erase currently playing message

*1 If pressed within the first 5 seconds of a message, the previous message is played.

Calling back (Caller ID subscribers only)

During playback, lift the corded handset.

- To edit the number before calling back, press **[EDIT]** repeatedly until the phone number is shown in the desired format (page 50).

Erasing all messages

Press **[ERASE]** 2 times while the unit is not in use.

Using the handset

When new messages have been recorded, “New message” is displayed.

1 To listen to new messages:

[MENU] **#** **3** **2** **3**

To listen to all messages:

[MENU] **#** **3** **2** **4**

2 When finished, press **[OFF]**.

Note:

- To switch to the receiver, press **[TALK/☎]**.
- You can also use the **[PLAY]** soft key, if displayed, to play new messages.

Operating the answering system

[MENU] → **[⬆]**: “Answering device” → **[SELECT]**

Key	Operation
[▲] or [▼]	Adjust the receiver/speaker volume (during playback)
[1] or [◀]	Repeat message (during playback)*1
[2] or [▶]	Skip message (during playback)
[3]	Enter the “Settings” menu
[4]	Play new messages
[5]	Play all messages
[6]	Play greeting message
[7] [6]	Record greeting message

Key	Operation
[8]	Turn answering system on
[PAUSE]	Pause message ²
[9] or [STOP]	Stop recording Stop playback
[0]	Turn answering system off
[X] [4] ^{*3}	Erase currently playing message
[X] [5]	Erase all messages
[X] [6]	Reset to a pre-recorded greeting message

- *1 If pressed within the first 5 seconds of a message, the previous message is played.
- *2 To resume playback:
[↕]: "Playback" → [SELECT]
- *3 You can also erase as follows:
[PAUSE] → [↕]: "Erase" → [SELECT]
→ [↕]: "Yes" → [SELECT]

Calling back (Caller ID subscribers only)

- 1 Press [PAUSE] during playback.
- 2 [↕]: "Call back" → [SELECT]

Editing the number before calling back

- 1 Press [PAUSE] during playback.
- 2 [↕]: "Edit & Call" → [SELECT]
- 3 Press [EDIT] repeatedly until the phone number is shown in the desired format (page 50). → [TALK/📞]

Erasing all messages

- 1 [MENU]# [3] [2] [5]
- 2 [↕]: "Yes" → [SELECT] → [OFF]

Advanced new message alerting features

Audible message alert

This feature allows the base unit to beep to inform you of a new message arrival when new messages are recorded. The base unit beeps 2 times every minute until you listen to the messages, if the "Base unit beep" setting is turned on. The default setting is "Off".

Handset / Base unit

- 1 [MENU]# [3] [3] [9]
- 2 [↕]: Select the desired setting. → [SAVE]
- 3 Proceed with the operation for your unit.
Handset: [OFF]
Base unit: [EXIT]

New message alert by a call

This feature allows you to receive a notification by phone when new messages are recorded. The base unit calls a phone number you specify. You can then operate the answering system remotely to listen to the new message.

To use this feature, you must:

- store a phone number to which the unit makes the call to.
- turn on the new message alert setting.

After you answer the new message alert call, you can listen to messages from that call (page 54).

Important:

- A new message alert is stopped 1 minute after the unit starts to call. The unit will not retry the call even if the call is not answered.

Storing a phone number to which the unit makes an alert call

Handset

■ From the phonebook:

- 1 [MENU]# [3] [3] [8]
- 2 [↕]: "Notification to" → [SELECT] → [ADD]
- 3 [↕]: "Phonebook" → [SELECT]
- 4 [↕]: Select the desired phonebook entry. → [SAVE] → [OFF]

■ By entering a phone number:

- 1 [MENU]# [3] [3] [8]
- 2 [↕]: "Notification to" → [SELECT] → [ADD]
- 3 [↕]: "Manual" → [SELECT]
- 4 Enter the desired name (16 characters max.). → [OK]
- 5 Enter the desired number (24 digits max.). → [OK] → [SELECT] → [OFF]

Base unit

■ From the phonebook:

- 1 [MENU]# 3 3 8
- 2 [↕]: "Notification to" → [SELECT] → [OK]
- 3 [↕]: Select the desired phonebook entry. → [SAVE] → [EXIT]

■ By entering a phone number:

- 1 [MENU]# 3 3 8
- 2 [↕]: "Notification to" → [SELECT] → [EDIT]
- 3 Enter the desired name (16 characters max.). → [OK]
- 4 Enter the desired number (24 digits max.). → [OK] → [SELECT] → [EXIT]

Turning on/off the new message alert setting

Handset / Base unit

- 1 [MENU]# 3 3 8
- 2 [↕]: "On/Off" → [SELECT]
- 3 [↕]: Select the desired setting. → [SAVE]
- 4 Proceed with the operation for your unit.
Handset: [OFF]
Base unit: [EXIT]

Editing the set phone number

Handset

- 1 [MENU]# 3 3 8
- 2 [↕]: "Notification to" → [SELECT]
- 3 [MENU] → [↕]: "Edit" → [SELECT]
- 4 Edit the name if necessary (16 characters max.). → [OK]
- 5 Edit the phone number if necessary (24 digits max.). → [OK] → [SELECT] → [OFF]

Base unit

- 1 [MENU]# 3 3 8
- 2 [↕]: "Notification to" → [SELECT] → [EDIT]
- 3 Edit the name if necessary (16 characters max.). → [OK]
- 4 Edit the phone number if necessary (24 digits max.). → [OK] → [SELECT] → [EXIT]

Erasing the set phone number

Handset

- 1 [MENU]# 3 3 8
- 2 [↕]: "Notification to" → [SELECT]
- 3 [MENU] → [↕]: "Erase" → [SELECT]
- 4 [↕]: "Yes" → [SELECT] → [OFF]
 - The new message alert setting is turned off.

Base unit

- 1 [MENU]# 3 3 8
- 2 [↕]: "Notification to" → [SELECT] → [ERASE]
- 3 [↕]: "Yes" → [SELECT] → [EXIT]
 - The new message alert setting is turned off.

Activating/inactivating the remote access code to play messages

If you activate this feature, you must enter the remote access code (page 55) to play the new message from the new message alert call. This is so that unauthorized parties cannot listen to your messages. The default setting is "Inactivate".

- "Inactivate": You can listen to the message by pressing [4] to play new messages (without entering the remote access code).
- "Activate": You must enter your remote access code and then press [4] to play new message.

Handset / Base unit

- 1 [MENU]# 3 3 8
- 2 [↕]: "Remote code" → [SELECT]
- 3 [↕]: Select the desired setting. → [SAVE]
- 4 Proceed with the operation for your unit.
Handset: [OFF]
Base unit: [EXIT]

Listening to messages

After you answer the new message alert, you can listen to the messages as follows.

■ When the remote access code is set to "Inactivate":

Press [4] to play the new message during the announcement.

■ **When the remote access code is set to “Activate”:**

- 1 Enter the remote access code (page 55) during the announcement.
- 2 Press **[4]** to play the new message.

Note:

- Within 10 seconds after listening to new messages, you can press **[#][9]** during the call to turn off the new message alert by a call feature.
- Even if the unit makes a new message alert call, the handset redial list does not show the record. However, on the base unit redial list it is shown as “**Message alert**”.

Remote operation

Using a touch-tone phone, you can call your phone number from outside and access the unit to listen to messages or change answering system settings. The unit’s voice guidance prompts you to press certain dial keys to perform different operations.

Remote access code

A 3-digit remote access code must be entered when operating the answering system remotely. This code prevents unauthorized parties from listening to your messages remotely. The default setting is “111”.

Important:

- To prevent unauthorized access to this product, we recommend that you regularly change the remote code.

Handset / Base unit

- 1 **[MENU][#][3][0][6]**
- 2 Enter the desired 3-digit remote access code.
- 3 **[SAVE]**
- 4 Proceed with the operation for your unit.
Handset: [OFF]
Base unit: [EXIT]

Deactivating remote operation

Press **[X]** in step 2 on “Remote access code”, page 55.

- The entered remote access code is deleted.

Using the answering system remotely

- 1 Dial your phone number from a touch-tone phone.
- 2 After the greeting message starts, enter your remote access code.
- 3 Follow the voice guidance prompts as necessary or control the unit using remote commands (page 55).
- 4 When finished, hang up.

Voice guidance

During remote operation, the unit’s voice guidance starts and prompts you to press **[1]** to perform a specific operation, or press **[2]** to listen to more available operations.

Note:

- If you do not press any dial keys within 10 seconds after a voice guidance prompt, the unit disconnects your call.

Remote commands

You can press dial keys to access certain answering system functions without waiting for the voice guidance to prompt you.

Key	Operation
[1]	Repeat message (during playback)*1
[2]	Skip message (during playback)
[4]	Play new messages
[5]	Play all messages
[9]	Stop playback Start voice guidance
[0]	Turn answering system off
[X][4]	Erase currently playing message
[X][5]	Erase all messages
[X][#]	End remote operation (or hang up)

*1 If pressed within the first 5 seconds of a message, the previous message is played.

Turning on the answering system remotely

- 1 Dial your phone number from a touch-tone phone.
- 2 Let the phone ring 15 times.
 - A long beep is heard.
- 3 Enter your remote access code within 10 seconds after the long beep.
 - The greeting message is played back.
 - You can either hang up, or enter your remote access code again and begin remote operation (page 55).

Answering system settings

Call screening

Handset / Base unit

While a caller is leaving a message, you can listen to the call through the unit's speaker.

To adjust the speaker volume, press **[▲]** or **[▼]** repeatedly.

You can answer the call by:

- lifting the corded handset from the base unit, or
- pressing **[TALK/📞]** on the handset.

Call screening can be set for each unit. The default setting is "On".

- 1 **[MENU]#310**
- 2 **[↕]**: Select the desired setting. → **[SAVE]**
- 3 Proceed with the operation for your unit.
Handset: [OFF]
Base unit: [EXIT]

Number of rings before the unit answers a call

You can change the number of times the phone rings "Ring count" before the unit answers calls. You can select 2 to 7 rings, or "Toll saver".

The default setting is "4 rings".

"Toll saver": The unit's answering system answers at the end of the 2nd ring when new messages have been recorded, or at the end of the 5th ring when there are no new messages. If you call your phone from outside to listen to new messages (page 55), you know that there are no new messages when the phone rings for the 3rd

time. You can then hang up without being charged for the call.

Handset / Base unit

- 1 **[MENU]#211**
- 2 **[↕]**: Select the desired setting. → **[SAVE]**
- 3 Proceed with the operation for your unit.
Handset: [OFF]
Base unit: [EXIT]

Caller's recording time

You can change the maximum message recording time allowed for each caller. The default setting is "3 min".

Handset / Base unit

- 1 **[MENU]#305**
- 2 **[↕]**: Select the desired setting. → **[SAVE]**
- 3 Proceed with the operation for your unit.
Handset: [OFF]
Base unit: [EXIT]

Selecting "Greeting only"

You can select "Greeting only" which sets the unit to announce a greeting message to callers but not record messages.

Select "Greeting only" in step 2 on "Caller's recording time", page 56.

Note:

- When you select "Greeting only":
 - If you do not record your own message, the unit will play the pre-recorded greeting-only message asking callers to call again later.
 - If you use your own message, record the greeting-only message asking callers to call again later (page 51).

Voice mail service

In addition to your unit's answering system you may also have voicemail service from your phone service provider. Voicemail is an answering service that may be offered by your phone service provider. This service can also record calls when you are unavailable to answer the phone or when your line is busy. Messages are recorded on the phone company system and not on the unit's answering system.

- To use the voicemail service rather than the unit's answering system, turn off the answering system (page 51).

If you have unit's answering system set to on and also the voicemail enabled, the system with least amount of rings will record the message first.

Example:

If the unit's answering system is set to 4 rings (page 56) and the voicemail answering system provided by your phone company is set to 6 rings (call your service provider), the unit's answering system will record the incoming call first.

Storing the voicemail (VM) access number

In order to listen to your voicemail messages, you must dial your phone service provider's voicemail access number. Once you have stored your voicemail access number, you can dial it automatically (page 58).

Handset / Base unit

- [MENU]** **#** **3** **3** **1**
- Enter your access number (24 digits max.). → **[SAVE]**
- Proceed with the operation for your unit.
Handset: [OFF]
Base unit: [EXIT]

Note:

- When storing your voicemail access number and your mailbox password, press **[▲]** (Pause) on the handset or **[PAUSE]** on the base unit to add pauses (page 19) between the access number and the password as necessary. Contact your phone service provider for the required pause time.

Example:

1-222-333-4444	PPPP	8888
VM access	Pauses	Password
number		

To erase the voicemail access number

Handset / Base unit

- [MENU]** **#** **3** **3** **1**
- Press and hold **[CLEAR]** until all digits are erased. → **[SAVE]**
- Proceed with the operation for your unit.
Handset: [OFF]
Base unit: [EXIT]

Voice mail (VM) tone detection

Handset / Base unit

Your phone service provider sends special signals (sometimes called "voicemail tones" or "stutter tones") to the unit to let you know you have new voicemail messages. If you hear a series of dial tones followed by a continuous dial tone after you press **[TALK/📞]** on the handset or lift the corded handset, you have new voicemail messages. Soon after you hang up a call or after the phone stops ringing, your unit checks the phone line to see if new voicemail messages have been recorded.

Turn this feature off when:

- You do not subscribe to voicemail service.
 - Your phone service provider does not send voicemail tones.
 - Your phone is connected to a PBX.
- If you are not sure which setting is required, contact your phone service provider.

Turning VM tone detection on/off

The default setting is "On".

Handset / Base unit

- [MENU]** **#** **3** **3** **2**
- [↕]**: Select the desired setting. → **[SAVE]**
- Proceed with the operation for your unit.
Handset: [OFF]
Base unit: [EXIT]

Listening to voicemail messages

When new messages have been recorded, "Voicemail msg. via phone co." is displayed if message indication service is available.

Handset / Base unit

1 [MENU]#330

- The speakerphone turns on.
- Lift the corded handset if needed.

2 Follow the pre-recorded instructions.

3 When finished, hang up.

Note:

- You can also use the [ACCESS] soft key, if displayed, to play new voicemail messages.
- If the handset and base unit still indicate there are new messages even after you have listened to all new messages, turn it off by pressing and holding [#] until the handset or base unit beeps.

Wall mounting

The base unit can be mounted on a wall by changing the wall mounting adaptor's position.

Note:

- Make sure that the wall and the fixing method are strong enough to support the weight of the unit.

Base unit

- 1 To remove the wall mounting adaptor, push down the release levers (1). Remove the adaptor (2).

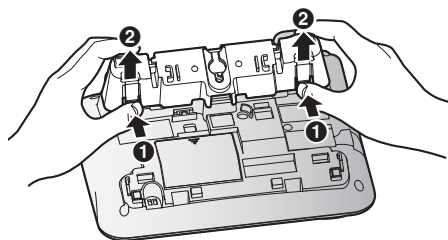

- 2 ① Turn the adaptor so that the words "UP WALL" are facing up.
- ② Tuck the telephone line cord inside the wall mounting adaptor.
- ③ Connect the AC adaptor cord and telephone line cord.

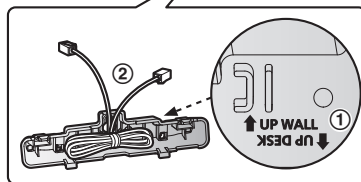
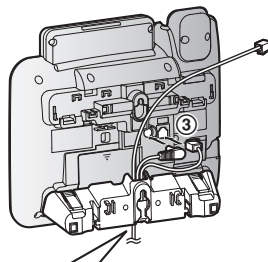

- 3 Insert the lower tabs of the adaptor into the unit's bottom slots (1), then insert by pushing down the levers of the adaptor into the upper slots (2).
- The words "UP WALL" should be facing up.

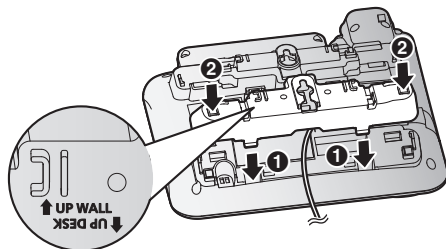

- 4 Mount the unit on a wall then slide down to secure in place.
- This product is compliant with the following wall phone plate sizes (2 types).
 - A** 83 mm (3 1/4 inches)
 - B** 102 mm (4 inches)
- Fit the slots of the unit onto the corresponding wall phone plate tabs for **(C)** and **(D)** respectively.

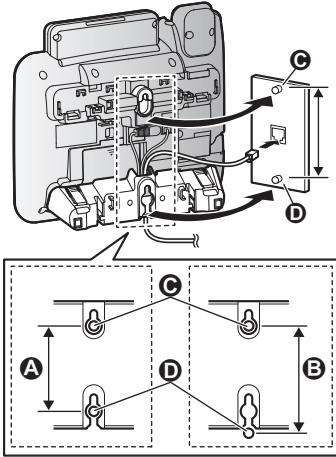

Charger

- Drive the screws **(A)** (not supplied) into the wall.
- B** 27.2 mm (1 1/16 inches)

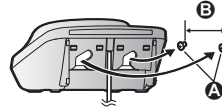

Error messages

Display message	Cause/solution
Ask phone company for VM access #	<ul style="list-style-type: none"> You have not stored the voicemail access number. Store the number (page 57).
Main unit no power or No link. Re-connect base AC adaptor.	<ul style="list-style-type: none"> Confirm the base unit's AC adaptor is connected to the unit and the power outlet correctly. The handset has lost communication with the base unit. Move closer to the base unit and try again. Unplug the base unit's AC adaptor to reset the unit. Reconnect the adaptor and try again. The handset's registration may have been cancelled. Re-register the handset (page 47).
Busy	<ul style="list-style-type: none"> The called unit is in use. Other units are in use and the system is busy. Try again later. The handset you are using is too far from the base unit. Move closer and try again. The automated call block function is in operation. Try again later. One of the units is screening for telemarketing call. Try again later. One of the units is recording a conversation with outside caller. Try again later.

Useful Information

Display message	Cause/solution
Check tel line	<ul style="list-style-type: none">● The supplied telephone line cord has not been connected yet or not connected properly. Check the connections (page 9).
Checking	<ul style="list-style-type: none">● The automated call block function is in operation. Try again later.
Error!!	<ul style="list-style-type: none">● Recording was too short. Try again.● Although the unit tried to pair with the headphone, the pairing has been failed.<ul style="list-style-type: none">– Make sure that the headphone is not connected to other Bluetooth devices.– The headphone is turned off or the battery is low. Turn it on or fully charge the headphone.– The Bluetooth headphone is out of range. Move closer and try again.– The Bluetooth headphone is in the cradle. Lift the headphone.– The same headphone is already paired.
Memory full	<ul style="list-style-type: none">● The recording memory is full. Erase unwanted recordings (page 53).
Invalid	<ul style="list-style-type: none">● There is no handset registered to the base unit matching the handset number you entered.● The handset is not registered to the base unit. Register the handset (page 47).
Requires subscription to Caller ID.	<ul style="list-style-type: none">● You must subscribe to a Caller ID service. Once you receive caller information after subscribing to a Caller ID service, this message will not be displayed.
Use rechargeable battery.	<ul style="list-style-type: none">● A wrong type of battery such as alkaline or manganese was inserted. Use only the rechargeable Ni-MH batteries noted on page 3, 6.
Failed. Check power at headphone.	<ul style="list-style-type: none">● Although the unit tried to connect to the headphone, the connection has failed.<ul style="list-style-type: none">– Make sure that the headphone is not connected to other Bluetooth devices.– The headphone is turned off or the battery is low. Turn it on or fully charge the headphone.– The Bluetooth headphone is out of range. Move closer and try again.– The Bluetooth headphone is in the cradle. Lift the headphone.
Check Bluetooth connection.	<ul style="list-style-type: none">● Although the unit tried to connect to the headphone, the connection has failed.<ul style="list-style-type: none">– Make sure that the headphone is not connected to other Bluetooth devices.
Already stored.	<ul style="list-style-type: none">● The same headphone is already paired.● The same information is already stored in the phonebook.

Troubleshooting

If you still have difficulties after following the instructions in this section, disconnect the base unit's AC adaptor, then reconnect the base unit's AC adaptor. Remove the batteries from the handset, and then insert them into the handset again.

If the base unit batteries for power backup are installed, remove the batteries from the base unit, and then insert them into the base unit again.

General use

Problem	Cause/solution
The handset does not turn on even after installing charged batteries.	<ul style="list-style-type: none"> Place the handset on the charger to turn on the handset.
The unit does not work.	<ul style="list-style-type: none"> Make sure the batteries are installed correctly (page 9). Fully charge the batteries (page 10). Check the connections (page 9). Unplug the base unit's AC adaptor to reset the unit. Reconnect the adaptor and try again. The handset has not been registered to the base unit. Register the handset (page 47).
I cannot hear a dial tone.	<ul style="list-style-type: none"> The base unit's AC adaptor or telephone line cord is not connected. Check the connections. Disconnect the base unit from the telephone line and connect the line to a known working telephone. If the working telephone operates properly, contact our service personnel to have the unit repaired. If the working telephone does not operate properly, contact your phone service provider.
The base unit beeps.	<ul style="list-style-type: none"> New messages have been recorded. Listen to the new messages (page 52).
Error sound is heard when I press some keys on base unit.	<ul style="list-style-type: none"> Automated call block is being screened. Try again later.
The unit does not emit the specified number of rings.	<ul style="list-style-type: none"> The number of rings decreases by 1 from the specified number of rings in below situations: <ul style="list-style-type: none"> the first ring is turned off ("No") (page 27). answer by voice command is set to "On" (page 24).
The unit does not work during a power failure.	<ul style="list-style-type: none"> You can insert 2 AAA (R03) batteries (not supplied) into the base unit that will power the unit temporarily in the event of a power failure (page 10). The base unit display is blank if the saving mode is "On" (page 11).



Menu list

Problem	Cause/solution
The display is in a language I cannot read.	<ul style="list-style-type: none"> Change the display language (page 14).
I cannot register a handset to a base unit.	<ul style="list-style-type: none"> The maximum number of handsets (6) is already registered to the base unit. Cancel unused handset registrations from the base unit (page 47).





Battery recharge

Problem	Cause/solution
The handset beeps and/or  flashes.	<ul style="list-style-type: none"> Battery charge is low. Fully charge the batteries (page 10).

Useful Information

Problem	Cause/solution
<p>I fully charged the batteries, but</p> <ul style="list-style-type: none"> –  still flashes, –  is displayed, or – the operating time seems to be shorter. 	<ul style="list-style-type: none"> ● Clean the battery ends (\oplus, \ominus) and the charge contacts with a dry cloth and charge again. ● It is time to replace the batteries (page 9).

Making/answering calls, intercom

Problem	Cause/solution
<p> is displayed.</p>	<ul style="list-style-type: none"> ● The handset is too far from the base unit. Move closer. ● The base unit's AC adaptor is not properly connected. Reconnect AC adaptor to the base unit. ● The handset is not registered to the base unit. Register it (page 47).
<p>Noise is heard, sound cuts in and out.</p>	<ul style="list-style-type: none"> ● You are using the handset or base unit in an area with high electrical interference. Re-position the base unit and use the handset away from sources of interference. ● Move closer to the base unit. ● If you use a DSL/ADSL service, we recommend connecting a DSL/ADSL filter between the base unit and the telephone line jack. Contact your DSL/ADSL provider for details.
<p>The handset or base unit does not ring.</p>	<ul style="list-style-type: none"> ● The ringer volume is turned off. Adjust the ringer volume (page 20, 40). ● Night mode is turned on. Turn it off (page 44). ● The ringer volume is turned off by pressing and holding  () on the handset. Press and hold  () again to turn it on (page 20).
<p>I cannot make a call.</p>	<ul style="list-style-type: none"> ● The dialing mode may be set incorrectly. Change the setting (page 15).
<p>I cannot answer an incoming call using voice commands.</p>	<ul style="list-style-type: none"> ● The answer by voice command feature is turned off. To turn it on, see page 24. ● Baby monitor is set to "On". Turn off the baby monitor feature (page 45).
<p>The unit answers an incoming call on its own.</p>	<ul style="list-style-type: none"> ● This situation might happen due to a false detection of ambient noise (dog barking, TV sound, etc.). Move the unit further away from the noise sources. ● If you are using other telephone that has Talking Caller ID feature turned on, it may also trigger false detection. Turn the Talking Caller ID feature off on the other telephone. ● To minimize false detection, decrease the sensitivity level of the answer by voice command (page 24, 41).
<p>I cannot make long distance calls.</p>	<ul style="list-style-type: none"> ● Make sure that you have long distance service.
<p>I cannot use voice paging.</p>	<ul style="list-style-type: none"> ● You cannot use voice paging if other units are in use.

Call block

Problem	Cause/solution
The dedicated key for Telemarketing call block is not displayed.	<ul style="list-style-type: none"> While on charger, the [TELE.BLK.] key is not available. Lift the handset from the charger. If Auto talk feature is set to on, the call is answered automatically when the handset is lifted from the charger during an incoming call. Turn off the auto talk feature (page 41).

Caller ID/Talking Caller ID

Problem	Cause/solution
Caller information is not displayed.	<ul style="list-style-type: none"> You must subscribe to Caller ID service. Contact your phone service provider for details. If your unit is connected to any additional telephone equipment such as a Caller ID box or cordless telephone line jack, plug the unit directly into the wall jack. If you use a DSL/ADSL service, we recommend connecting a DSL/ADSL filter between the base unit and the telephone line jack. Contact your DSL/ADSL provider for details. The name display service may not be available in some areas. Contact your phone service provider for details. Other telephone equipment may be interfering with this unit. Disconnect the other equipment and try again.
Caller information is displayed or announced late.	<ul style="list-style-type: none"> Depending on your phone service provider, the unit may display or announce the caller's information at the 2nd ring or later. Move closer to the base unit.
Caller information is not announced.	<ul style="list-style-type: none"> The ringer volume is turned off. Adjust the ringer volume (page 20,40). The Talking Caller ID feature is turned off. Turn it on (page 40). The number of rings for the answering system is set to "2 rings" or "Toll saver". Select a different setting (page 56). If the base unit and another handset are having an intercom call, your handset does not announce caller information.
I cannot dial the phone number edited in the caller list.	<ul style="list-style-type: none"> The phone number you dialed might have been edited incorrectly (for example, the long distance "1" or the area code is missing). Edit the phone number with another pattern (page 50).
Time on the unit has shifted.	<ul style="list-style-type: none"> Incorrect time information from incoming Caller ID changes the time. Set the time adjustment to "Manual" (off) (page 40).
The 2nd caller's information is not displayed during an outside call.	<ul style="list-style-type: none"> In order to use Caller ID, call waiting, or Call Waiting Caller ID (CWID), you must first contact your phone service provider and subscribe to the desired service. After subscribing, you may need to contact your phone service provider again to activate this specific service, even if you already subscribed to both Caller ID and Call Waiting with Caller ID services (CWID).

Useful Information

Using Bluetooth headphone

Problem	Cause/solution
I cannot have a conversation using the headphone. or I cannot connect my headphone to the handset.	<ul style="list-style-type: none">● Your Bluetooth headphone is not paired. Pair it (page 16).● Turn your headphone off, then turn it on and try again.● If your headphone is already connected to another Bluetooth device such as your cellular phone, disconnect the headphone from your cellular phone, then perform the connecting procedure to the handset.● Only 1 Bluetooth headphone can be used with the unit at a time.
I cannot pair my headphone.	<ul style="list-style-type: none">● Confirm that the Bluetooth wireless headphone supports the Hands Free Profile (HFP) specification. If your headphone do not support the HFP specification, your headphone is not compatible to be paired within the handset.● If your headphone is already connected to another Bluetooth device such as your cellular phone, disconnect the headphone from your cellular phone, then perform the pairing procedure to the handset.
Noise is heard during a call on the headphone.	<ul style="list-style-type: none">● A Bluetooth headphone can communicate with the handset within a range of approximately 10 m (33 feet). The connection may be subject to interference from obstructions such as walls or electronic devices. Move closer to the handset.
Some headphone enhanced features are not available.	<ul style="list-style-type: none">● The handset does not support enhanced features such as Last number redial or Call reject.
By pressing [TALK/☎] on the handset while making or answering a call, the call will automatically become a headphone call.	<ul style="list-style-type: none">● Disconnect the headphone or put it in the cradle in advance.

Problem	Cause/solution
<p>Some Bluetooth headphones can only be connected to one device at a time.</p> <p>If you want to use these types of Bluetooth headphones mainly by connecting a smartphone, you can disconnect the Bluetooth headphones automatically after the call has ended.*1</p>	<ul style="list-style-type: none"> By setting below function, you may be able to automatically reconnect the Bluetooth headphones to your smartphone when the call is ended with Panasonic handset KX-TGDA99C. <p>Connection after the call:</p> <p>You can set to disconnect the Bluetooth headphone connection after the call has ended. The default setting is “Stay connected”.</p> <ol style="list-style-type: none"> [MENU]#644 [↕]: “Disconnect” → [SAVE] [OFF] <p>(For example, if you want to use the same Bluetooth headphone with your smartphone and KX-TGDA99C alternately).</p> <ul style="list-style-type: none"> If you select “Stay connected”: The Bluetooth headphones will be connected to the Panasonic handset. However, in order for you to connect that Bluetooth headphones back to your smartphone, you have to manually enter the smartphone Bluetooth settings and select the headphones to connect. If you select “Disconnect”: After the call, the Bluetooth headphones will be disconnected from the Panasonic handset and it will automatically be connected to your smartphone. <p>Note:</p> <ul style="list-style-type: none"> In some cases when “Disconnect” is selected, during an incoming call when you press [PAIR] button, it might take some time to connect to the headphone.*2 However, the handset speaker is turned on so that you do not miss the call. During this time “Connecting” will be displayed on the handset. Once the Bluetooth connection is established, the call will automatically switched to headphone.

*1 This feature depends on the Bluetooth headphone/smartphone specifications.

*2 If 2 or more Bluetooth headphones are paired, **[↕]**: Select the desired headphone. → **[SELECT]**

Answering system

Problem	Cause/solution
<p>The unit does not record new messages.</p>	<ul style="list-style-type: none"> The answering system is turned off. Turn it on (page 51). The message memory is full. Erase unnecessary messages (page 53). The recording time is set to “Greeting only”. Change the setting (page 56). Your phone service provider’s voicemail service may be answering your calls before the unit’s answering system can answer your calls. Change the unit’s number of rings setting (page 56) to a lower value, or contact your phone service provider. The answering system will not answer incoming calls while the other devices such as handsets are engaged in a call.

Useful Information

Problem	Cause/solution
I cannot operate the answering system remotely.	<ul style="list-style-type: none">• The remote access code is not set. Set the remote access code (page 55).• You are entering the wrong remote access code. If you have forgotten your remote access code, enter the remote access code setting to check your current code (page 55).• The answering system is turned off. Turn it on (page 56).

Bluetooth PIN

Problem	Cause/solution
I cannot remember the PIN.	<ul style="list-style-type: none">• Change the PIN using the following method. Handset: 1 [MENU] [#] 6 4 5 2 [X] 7 0 0 0 3 Enter the new 4-digit PIN. → [OK] 4 Enter the new 4-digit PIN again. → [SAVE] → [OFF]

Voicemail

Problem	Cause/solution
“Voicemail msg. via phone co.” is shown on the display. How do I remove this message from the display?	<ul style="list-style-type: none">• This notification is displayed when your phone service provider’s voicemail service (not the unit’s answering system) has recorded a message for you. Typically you can remove this notification from the display by listening to the message. To listen to the message, dial the voicemail number provided by your phone service provider (for most cases, this will be your own phone number), and follow the voice instructions. Depending on your phone service provider, you may need to remove all messages from your voice mailbox to remove the notification. You can also remove this notification by pressing and holding [#] until the unit beeps.

Liquid damage

Problem	Cause/solution
Liquid or other form of moisture has entered the handset/base unit.	<ul style="list-style-type: none">• Disconnect the AC adaptor and telephone line cord from the base unit. Remove the batteries from the handset/base unit and leave to dry for at least 3 days. After the handset/base unit are completely dry, reconnect the AC adaptor and telephone line cord. Insert the batteries and charge fully before use. If the unit does not work properly, contact an authorized service centre.

Caution:

- To avoid permanent damage, do not use a microwave oven to speed up the drying process.

Other notices and information (for Canada)

Notice:

This equipment meets the applicable Innovation, Science and Economic Development Canada Terminal Equipment Technical Specifications. This is confirmed by the registration number. The abbreviation, "IC:", before the registration number signifies that registration was performed based on a Declaration of Conformity indicating that Innovation, Science and Economic Development Canada technical specifications were met. It does not imply that Innovation, Science and Economic Development Canada approved the equipment. Users should ensure, for their own protection, that the electrical ground connections of the power utility, telephone lines and internal metallic water pipe system, if present, are connected together. This precaution may be particularly important in rural areas.

Notice:

The **Ringer Equivalence Number (REN)** assigned to each terminal device provides an indication of the maximum number of terminals allowed to be connected to a telephone interface. The termination on an interface may consist of any combination of devices subject only to the requirement that the sum of the Ringer Equivalence Numbers of all the devices does not exceed 5.

The Ringer Equivalence Number (REN) of this unit: (found on the bottom of the unit).

Notice:

This device complies with Innovation, Science and Economic Development Canada licence-exempt RSS standard(s).

Operation is subject to the following two conditions: (1) this device may not cause interference, and (2) this device must accept any interference, including interference that may cause undesired operation of the device.

Privacy of communications may not be ensured when using this telephone.

Some cordless telephones operate at frequencies that may cause interference to nearby TVs and VCRs. To minimize or prevent such interference, the base of the cordless telephone should not be placed near, or on top of, a TV or VCR. If interference is experienced, move the cordless telephone further away from the TV or VCR. This will often reduce, or eliminate, interference.

RF Exposure Warning:

- This product complies with ISED radiation exposure limits set forth for an uncontrolled environment.
- To comply with ISED RF exposure requirements, the base unit must be installed and operated 20 cm (8 inches) or more between product and all person's body.
- This product may not be collocated or operated in conjunction with any other antenna or transmitter.
- For body-worn operation, the handset must be used only with a non-metallic accessory. Use of other accessories may not ensure compliance with ISED RF exposure requirements.

Charge only mode

The charge only mode is the dedicated mode to charge the backup batteries of the base unit. Do not use this mode if it is unnecessary because all functions except the base unit's battery charge is disabled with this feature on. Leave all the registered handsets on the chargers during use of the charge only mode.

■ To activate the charge only mode:

- 1 Disconnect the telephone line cord, the AC adaptor plug, and remove the batteries from the base unit with the corded handset placed on the cradle.
- 2 Press and hold **[3]**, **[*]**, and **[HOLD]** at the same time, then insert the AC adaptor plug to the base unit.
Keep on pressing these keys until:
 - a beep tone sounds, and
 - the ANSWER ON/OFF indicator and SP-PHONE indicator flash once.
- 3 Release these keys.
 - LCD turns off.
- 4 Insert batteries.
 - The batteries are started to be charged.

Note:

- If the LCD is still on when you release the keys, the base unit is not in the charging only mode. Repeat from step 1. The charge only mode is cancelled when the corded handset comes off during or after setting up.

■ To deactivate the charge only mode:

- Lift the corded handset from the base unit and replace it.
- Press any key.
- 24 hours passed after activating the charge only mode.

Warranty

Panasonic Canada Inc.
5770 Ambler Drive, Mississauga, Ontario L4W 2T3
PANASONIC PRODUCT - LIMITED WARRANTY

EXCHANGE PROGRAM

Panasonic Canada Inc. warrants this product to be free from defects in material and workmanship under normal use and for a period as stated below from the date of original purchase agrees to, at its option either (a) repair your product with new or refurbished parts, (b) replace it with a new or a refurbished equivalent value product, or (c) refund your purchase price. The decision to repair, replace or refund will be made by Panasonic Canada Inc.

Telephone Accessory / Product

One (1) year

This warranty is given only to the original purchaser, or the person for whom it was purchased as a gift, of a Panasonic brand product mentioned above sold by an authorized Panasonic dealer in Canada and purchased and used in Canada, which product was not sold "as is", and which product was delivered to you in new condition in the original packaging.

IN ORDER TO BE ELIGIBLE TO RECEIVE WARRANTY SERVICE HEREUNDER, A PURCHASE RECEIPT OR OTHER PROOF OF DATE OF ORIGINAL PURCHASE, SHOWING AMOUNT PAID AND PLACE OF PURCHASE IS REQUIRED

LIMITATIONS AND EXCLUSIONS

This warranty **ONLY COVERS** failures due to defects in materials or workmanship, and **DOES NOT COVER** normal wear and tear or cosmetic damage. The warranty **ALSO DOES NOT COVER** damages which occurred in shipment, or failures which are caused by products not supplied by Panasonic Canada Inc., or failures which result from accidents, misuse, abuse, neglect, mishandling, misapplication, alteration, faulty installation, set-up adjustments, misadjustment of consumer controls, improper maintenance, improper batteries, power line surge, lightning damage, modification, introduction of sand, humidity or liquids, commercial use such as hotel, office, restaurant, or other business or rental use of the product, or service by anyone other than a Authorized Servicer, or damage that is attributable to acts of God.

Rechargeable batteries are warranted for ninety (90) days from date of original purchase.

THIS EXPRESS, LIMITED WARRANTY IS IN LIEU OF ALL OTHER WARRANTIES, EXPRESS OR IMPLIED, INCLUDING ANY IMPLIED WARRANTIES OF MERCHANTABILITY AND FITNESS FOR A PARTICULAR PURPOSE. IN NO EVENT WILL PANASONIC CANADA INC. BE LIABLE FOR ANY SPECIAL, INDIRECT OR CONSEQUENTIAL DAMAGES RESULTING FROM THE USE OF THIS PRODUCT OR ARISING OUT OF ANY BREACH OF ANY EXPRESS OR IMPLIED WARRANTY. (As examples, this warranty excludes damages for lost time, travel to and from the Authorized Servicer, loss of or damage to media or images, data or other memory or recorded content. This list of items is not exhaustive, but for illustration only.)

In certain instances, some jurisdictions do not allow the exclusion or limitation of incidental or consequential damages, or the exclusion of implied warranties, so the above limitations and exclusions may not be applicable. This warranty gives you specific legal rights and you may have other rights which vary depending on your province or territory.

CONTACT INFORMATION

For product information and operation assistance, please visit our Support page:

www.panasonic.ca/english/support

For defective product exchange within the warranty period, please contact the original dealer.

Index

- # 3-way conference: 22
- A** Additional handset: 46
 - Alarm: 43
 - Answer by voice command: 24
 - Answering calls: 20
 - Answering system
 - Call screening: 56
 - Erasing messages: 52, 53, 55
 - Greeting message: 51
 - Greeting only: 56
 - Listening to messages: 52, 55
 - New message alerting: 53
 - Number of rings: 56
 - Recording time: 56
 - Remote access code: 55
 - Remote operation: 55
 - Ring count: 56
 - Toll saver: 56
 - Turning on/off: 51
 - Auto intercom: 25
 - Auto talk: 20, 41
 - Automated call block: 29
- B** Baby monitor: 44
 - Battery: 9, 11
 - Battery saving mode: 11
 - Bluetooth: 16
 - Bluetooth headphone
 - Answering calls: 18
 - Connection: 16
 - Making calls: 17
 - Pair: 16
 - Unpairing: 17
- C** C.WTG (Call Waiting Deluxe): 48
 - Call block: 26
 - One ring for blocked call: 27
 - Call share: 22
 - Call waiting: 21
 - Call Waiting Caller ID: 21
 - Caller ID service: 48
 - Caller list: 49
 - Caller list edit: 50
 - Chain dial: 34
 - CID (Caller ID): 49
 - Conference calls: 22
 - Control type: 12, 13
 - Customer support: 42
- D** Date and time: 15
 - Dialing mode: 15
 - Direct command code: 37
- Display
 - Contrast: 41
 - Language: 14
- E** Eco mode: 12
 - Equalizer: 21
 - Error messages: 59
- F** Flash: 21, 42
- G** Groups: 33
- H** Handset
 - Deregistration: 47
 - Locator: 13
 - Name: 46
 - Registration: 47
 - Hold: 20
- I** Intercom: 25
- K** Key tone: 41
- L** Line mode: 42
 - Low battery alert: 15
- M** Making calls: 19
 - Missed calls: 48
 - Mute: 21
- N** Night mode: 44
 - Noise reduction: 21
- O** One-touch dial buttons: 35
- P** Pause: 19
 - Phonebook: 32
 - Power failure (power backup operation): 10
 - Privacy mode: 42
- R** Recording telephone conversations: 22
 - Redialing: 19
 - Ringer ID: 33
 - Ringer tone: 40
 - Rotary/pulse service: 21
- S** Speed dial: 34
 - SP-PHONE (Speakerphone): 19
- T** Talking Caller ID: 48
 - Telemarketing call block: 31
 - Temporary tone dialing: 21
 - Time adjustment: 40
 - Transferring calls: 22
 - Troubleshooting: 60
- V** VM (Voicemail): 57
 - Voice announcement language: 14
 - Voice paging: 25
 - Voicemail: 57
 - Volume
 - Receiver: 19
 - Ringer (Base unit): 20, 40
 - Ringer (Handset): 20, 40
 - Ringer for intercom call (Handset): 40
 - Speaker: 19
- W** Wall mounting: 58

For your future reference

We recommend keeping a record of the following information to assist with any repair under warranty.

Serial No.	Date of purchase
(found on the bottom of the base unit)	
Name and address of dealer	

Attach your purchase receipt here.

Panasonic Canada Inc.
5770 Ambler Drive, Mississauga, Ontario L4W 2T3

© Panasonic Entertainment & Communication Co., Ltd. 2023

Printed in Vietnam



PNQX9251ZA

PNQX9251ZA PP0823BQ0