

Panasonic[®]

LUMIX

S5

Owner's Manual

Digital Camera

DC-S5

A firmware update has been made available to improve camera capabilities and to add functionality.

- For information about functions that have been added or modified, refer to the pages for "Firmware Update".



[Click here to move to "Firmware Update".](#)

DVQP2197ZC
F0920MR2031

Please read these instructions carefully before using this product, and save this manual for future use.

Register online at <http://shop.panasonic.com/support>
(U.S. customers only)

Dear Customer,

Thank you for choosing Panasonic!

You have purchased one of the most sophisticated and reliable products on the market today. Used properly, we're sure it will bring you and your family years of enjoyment. Please take time to fill in the information below. The serial number is on the tag located on the underside of your camera. Be sure to **retain this manual** as your convenient camera information source.

Date of Purchase	Dealer Phone No.
Dealer Purchased From	Model No.
Dealer Address	Serial No.

Please note that the actual controls and components, menu items, etc. of your Digital Camera may look somewhat different from those shown in the illustrations in this Owner's Manual.

Carefully observe copyright laws.

Recording of pre-recorded tapes or discs or other published or broadcast material for purposes other than your own private use may infringe copyright laws. Even for the purpose of private use, recording of certain material may be restricted.

❖ Finding the Information You Need

You can find the information you need by looking at the following pages in this document.

Contents	→ 6
Contents by Function	→ 15
Names of Parts	→ 27
Menu Guide	→ 344
Index	→ 560

About Owner's Manual

❖ Symbols Used in This Document

Symbols for recording modes, pictures, and videos that can be used

In this document, symbols are placed at the start of functional explanations (recording modes, pictures, and videos) showing conditions in which these functions can be used.





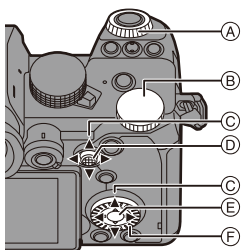

Black icons show conditions in which these can be used, and gray icons show conditions in which these cannot be used.

Example: **iA P A S M**  **S&Q** /  

Operating symbols

In this document, camera operation is explained using the following symbols:







(A)		Front dial
(B)		Rear dial
(C)		Cursor button up/down/left/right or Joystick up/down/left/right
(D)		Press the center of the joystick
(E)		[MENU/SET] button
(F)		Control dial

- Other symbols, such as icons shown on the camera screen, are also used in explanations.
- This document describes the procedure for selecting menu items as follows:
Example) Set [Picture Quality] of the [Photo] ([Image Quality]) menu to [STD.]

 ⇒  ⇒  ⇒ [Picture Quality] ⇒ Select [STD.]

Notification classification symbols

In this document, notifications are classified and described using the following symbols:

	To confirm prior to using the function
	Hints for better use of the camera and tips for recording
	Notifications and supplementary items regarding specifications
	Related information and page number

-
- Images and illustrations used in this document are for explaining the functions.
 - Description in this document is based on the interchangeable lens (S-R2060).

Chapters

1. Introduction	19
2. Getting Started	33
3. Basic Operations	57
4. Image Recording	83
5. Focus/Zoom	92
6. Drive/Shutter/Image Stabilizer	128
7. Metering/Exposure/ISO Sensitivity	184
8. White Balance/Image Quality	202
9. Flash	227
10. Recording Videos	240
11. Connections with External Devices (Video)	289
12. Playing Back and Editing of Images	300
13. Camera Customization	320
14. Menu Guide	344
15. Wi-Fi/Bluetooth	416
16. Connecting to Other Devices	473
17. Materials	490

Contents

About Owner's Manual	3
Chapters	5
Contents by Function	15

1. Introduction **19**

Before Use	19
Standard Accessories	22
Lenses That Can Be Used	23
Memory Cards That Can Be Used	24
Names of Parts	27
Camera	27
Supplied Lens	31
Viewfinder/Monitor Displays	32

2. Getting Started **33**

Attaching a Shoulder Strap	33
Charging the Battery	34
Charging with the Charger	34
Battery Insertion	37
Inserting a Battery into the Camera for Charging	39
Notifications Regarding Charging/Power Supply	42
[Power Save Mode]	44
Inserting Cards (Optional)	46
Formatting Cards (Initialization)	48
Attaching a Lens	49
Attaching a Lens Hood	51
Adjusting the Monitor Direction and Angle	53
Setting the Clock (When Turning On for the First Time)	54

3. Basic Operations 57

Basic Recording Operations	57
How to Hold the Camera	57
Recording	59
Selecting the Recording Mode	60
Camera Setting Operations	61
Monitor/Viewfinder Display Settings	65
Setting the Viewfinder	65
Switching Between the Monitor and Viewfinder	66
Switching the Display Information	67
Quick Menu.....	69
Control Panel.....	71
Menu Operation Methods	73
[Reset]	76
Intelligent Auto Mode	77
Recording Using Touch Functions.....	80
Touch AF/Touch Shutter	80
Touch AE.....	81

4. Image Recording 83

[Aspect Ratio]	83
[Picture Size].....	85
[Picture Quality]	86
[Double Card Slot Function].....	88
[Folder / File Settings].....	89
[File Number Reset].....	91

5. Focus/Zoom 92

Selecting the Focus Mode	93
Using AF	94
[AF Custom Setting(Photo)]	98
Selecting the AF Mode	100
[Face/Eye/Body/Animal Detect.].....	102
[Tracking].....	105
[225-Area].....	107
[Zone (Vert./ Horz.)]/ [Zone (Square)]/ [Zone (Oval)].....	108
[1-Area+]/ [1-Area].....	110
[Pinpoint]	111
[Custom1] to [Custom3].....	113
AF Area Movement Operation	115
Moving the AF Area by Touch	116
Moving the AF Area Position with the Touch Pad	118
[Focus Switching for Vert / Hor].....	119
Record Using MF	120
Recording with Zoom.....	124
Extended Tele Conversion	125

6. Drive/Shutter/Image Stabilizer 128

Selecting the Drive Mode.....	128
Taking Burst Pictures.....	129
6K/4K Photo Recording	133
Selecting Pictures from a 6K/4K Burst File.....	139
Correcting Pictures After Recording (Post-Recording Refinement).....	140
Picture Selection Operations	141
Recording with Time Lapse Shot.....	145
Recording with Stop Motion Animation	149
Time Lapse Shot/Stop Motion Animation Videos	152
Recording Using the Self-timer.....	154
Bracket Recording	156
[Live View Composite]	162

Post-Focus Recording	166
Selecting the Focus Point for the Picture to Save	169
Focus Stacking	171
[Silent Mode]	174
[Shutter Type]	175
Image Stabilizer	177
Image Stabilizer Settings	179

7. Metering/Exposure/ISO Sensitivity **184**

[Metering Mode]	184
Program AE Mode	185
Aperture-Priority AE Mode	187
Shutter-Priority AE Mode	190
Manual Exposure Mode	192
Preview Mode	195
Exposure Compensation	196
Locking Focus and Exposure (AF/AE Lock)	198
ISO Sensitivity	199

8. White Balance/Image Quality **202**

White Balance (WB)	202
Adjusting the White Balance	206
[Photo Style]	208
[Filter Settings]	215
[Simultaneous Record w/o Filter]	220
[High Resolution Mode]	221
[HLG Photo]	225

9. Flash **227**

Using an External Flash (Optional).....	227
Removing the Hot Shoe Cover.....	227
Setting Flash.....	229
[Flash Mode].....	229
[Red-Eye Removal].....	231
[Firing Mode]/[Manual Flash Adjust.].....	232
[Flash Adjust.].....	233
[Flash Synchro].....	234
[Auto Exposure Comp.].....	235
Recording Using a Wireless Flash.....	236

10. Recording Videos **240**

Recording Videos.....	240
Recording Modes Specifically for Video (Creative Video/S&Q).....	244
Setting the Exposure for Recording Videos.....	245
Separating Settings for Recording Video and Pictures.....	247
Video Recording Settings.....	248
[Switch NTSC/PAL].....	248
[Rec. File Format].....	249
[Image Area of Video].....	249
[Rec Quality].....	250
Time Code.....	254
Setting the Time Code.....	254
Using AF (Video).....	256
[Continuous AF].....	256
[AF Custom Setting(Video)].....	258
Video Brightness and Coloring.....	259
[Luminance Level].....	259
Recording While Controlling Overexposure (Knee).....	260
[ISO Sensitivity (video)].....	262
Audio Settings.....	263
Main Assist Functions.....	264
[Waveform Monitor].....	264

[Luminance Spot Meter]	266
[Zebra Pattern]	267
[Frame Marker]	268
Slow & Quick Video	269
[Live Cropping]	272
Log Recording	276
[V-Log View Assist]	278
HLG Videos	280
[HLG View Assist]	282
Anamorphic Recording	283
[Anamorphic(4:3)]	284
[Anamorphic Desqueeze Display]	286
List of Recording Qualities That Enable Special Videos to be Recorded	287

11. Connections with External Devices (Video) 289

HDMI Devices (HDMI Output)	289
Images Output via HDMI	290
[HDMI Rec Output]	292
External Microphones (Optional)	293
XLR Microphone Adaptor (Optional)	296
Headphones	298

12. Playing Back and Editing of Images 300

Playing Back Pictures	300
Playing Back Videos	303
Extracting a Picture	305
Switching the Display Mode	306
Enlarged Display	306
Thumbnail Screen	308
Calendar Playback	309
Group Images	310
Deleting Images	311
[RAW Processing]	312
[Video Divide]	318

13. Camera Customization 320

Fn Buttons	321
Register Functions to the Fn Buttons	323
Use the Fn Buttons	329
[Dial Operation Switch]	330
Register Functions to the Dials.....	330
Temporarily Change Dial Operation	331
Quick Menu Customization	332
Register to the Quick Menu	332
Custom Mode	337
Register in Custom Mode	337
Using Custom Mode	339
Calling Up Settings	340
My Menu	341
Registration in My Menu.....	341
[Save/Restore Camera Setting]	343

14. Menu Guide 344

List of Menu	345
[Photo] Menu	350
[Video] Menu.....	364
[Custom] Menu	370
[Setup] Menu	395
[Playback] Menu	406
Entering Characters.....	415

15. Wi-Fi/Bluetooth 416

Connecting to a Smartphone	418
Installing "LUMIX Sync"	419
Connecting to a Smartphone (Bluetooth Connection).....	420
Connecting to a Smartphone ([Wi-Fi connection]).....	424
Operating the Camera with a Smartphone	430
[Remote shooting]	431
[Shutter Remote Control].....	433

[Import images].....	435
[Auto Transfer].....	437
[Location Logging].....	439
[Remote Wakeup].....	440
[Auto Clock Set].....	441
[Camera settings copy].....	442
Sending Images from the Camera.....	443
[Smartphone].....	447
[PC].....	451
[Printer].....	454
[Web service].....	456
[Cloud Sync. Service].....	458
Wi-Fi Connections.....	460
[Via Network].....	460
[Direct].....	463
Connect to Wi-Fi Using Previously Saved Settings.....	464
Send Settings and Selecting Images.....	466
Image Send Settings.....	466
Selecting Images.....	467
[Wi-Fi Setup] Menu.....	468
“LUMIX CLUB”.....	469

16. Connecting to Other Devices 473

Viewing on a TV.....	475
Importing Images to a PC.....	478
Copying Images to a PC.....	478
Installing Software.....	480
Storing on a Recorder.....	483
Tethered Recording.....	484
Installing Software.....	484
Operating the Camera from a PC.....	485
Printing.....	486

17. Materials **490**

Using Optional Accessories	490
Battery Grip (Optional)	490
Shutter Remote Control (Optional)	491
Tripod Grip (Optional).....	492
AC Adaptor (Optional)/DC Coupler (Optional).....	492
Monitor/Viewfinder Displays	493
Recording Screen.....	493
Playback Screen	499
Message Displays.....	502
Troubleshooting	505
Cautions for Use	516
Number of Pictures That Can Be Taken and Available Recording Time with the Battery.....	525
Number of Still Images That Can Be Taken and Video Recording Time with Cards	528
List of Default Settings/Custom Saving/Settings Available for Copying.....	531
List of Functions That Can Be Set in Each Recording Mode...	545
Specifications.....	550
Index	560
Trademarks and Licenses	567

Contents by Function

Power Source

Charging	→ 34
Charging error	→ 36
	→ 40
Battery indication	→ 42
Power supply	→ 41
Power save function	→ 44
Number of pictures that can be taken, available recording time	→ 525

Card

Cards that can be used	→ 24
[Card Format]	→ 48
[Double Card Slot Function]	→ 88
[Destination Card Slot]	→ 88
Switching the playback card	→ 302
	→ 308
Folder structure	→ 479
[Folder / File Settings]	→ 89
[File Number Reset]	→ 91
Entering characters	→ 415
Number of pictures, length of recording time	→ 528

Lens

Attaching	→ 49
[Focal Length Set]	→ 183

Basic Settings

[Language]	→ 405
[Clock Set]	→ 54
[Time Zone]	→ 404
[Beep]	→ 399
[Copyright Information]	→ 395
[Reset]	→ 76

Viewfinder

Diopter adjustment	→ 65
Eye sensor	→ 66
[Eye Sensor AF]	→ 376

Display

Recording screen	→ 493
Playback screen	→ 499
Viewfinder	→ 32
Control panel	→ 71
	→ 497
Switching display	→ 67
Monitor/viewfinder adjustment	→ 397
Monitor/viewfinder luminance	→ 398
Display speed	→ 396
Level gauge	→ 391
Grid lines	→ 385
[Histogram]	→ 384
[Sheer Overlay]	→ 390
Checking overexposure	→ 389
[V-Log View Assist]	→ 278
[HLG View Assist]	→ 282

AF/MF

Focus mode	→ 93
[Continuous AF]	→ 256
Selecting the AF mode	→ 100
	→ 375
Face/eye/human detection	→ 102
Animal detection	→ 103
Movement tracking	→ 105
[AF ON]	→ 95
Moving the AF area	→ 115

Enlarged display	→ 97
	→ 122
Setting the AF sensitivity	→ 98
	→ 258
AF/AE Lock	→ 198
Touch AF	→ 80
	→ 117
[Touch Pad AF]	→ 118
[AF Assist Light]	→ 355
MF	→ 120
[MF Guide]	→ 374
[MF Assist]	→ 374
[Focus Peaking]	→ 356

Image Stabilizer

[Image Stabilizer]	→ 177
[Operation Mode]	→ 181
[E-Stabilization (Video)]	→ 179
[Boost I.S. (Video)]	→ 182
[Anamorphic (Video)]	→ 182
[Focal Length Set]	→ 183

Drive

Drive mode	→ 128
Burst	→ 129
[6K/4K PHOTO]	→ 133
[Time Lapse Shot]	→ 145
Recording with Stop Motion Animation	→ 149
[Self Timer]	→ 154
[Post-Focus]	→ 166

Image Quality

[Picture Size]	→ 85
[Picture Quality]	→ 86
RAW	→ 86
JPEG	→ 86
Aspect ratio	→ 83
[White Balance]	→ 202
[Photo Style]	→ 208
[Filter Settings]	→ 215
[Color Space]	→ 371
[Reduce Rolling Shutter]	→ 140
[6K/4K PHOTO Noise Reduction]	→ 141
[Long Exposure NR]	→ 351
[i.Dynamic Range]	→ 353
[Vignetting Comp.]	→ 354
[Diffraction Compensation]	→ 354

Taking Pictures

Recording mode	→ 60
Quick menu	→ 69
Zoom	→ 124
[Ex. Tele Conv.]	→ 125
Bracket recording	→ 156
[Live View Composite]	→ 162
Bulb recording	→ 194
[High Resolution Mode]	→ 221
[Multiple Exposure]	→ 362
[HLG Photo]	→ 225
[Shutter Type]	→ 175
[Silent Mode]	→ 174
Remote control recording	→ 491
Screen display	→ 493

Exposure

[Exposure Comp.]	→ 196
Program Shift	→ 186
Preview mode	→ 195
[Metering Mode]	→ 184
AE Lock	→ 198
[One Push AE]	→ 325
[Touch AE]	→ 81
[Sensitivity]	→ 199
[Extended ISO]	→ 371

Flash

External flash	→ 227
[Firing Mode]	→ 232
[Flash Mode]	→ 229
[Flash Adjust.]	→ 233
[Flash Synchro]	→ 234
[Wireless Flash Setup]	→ 236

Video Recording

Video recording	→ 240
[Switch NTSC/PAL]	→ 248
[Image Area of Video]	→ 249
Creative Video mode	→ 244
Slow & Quick mode	→ 244 → 269
[Live Cropping]	→ 272
Log recording (V-Log)	→ 276
HLG video	→ 280
Anamorphic Recording	→ 283
[Time Code]	→ 254
Remote control recording	→ 491

Display (Video)

[Waveform Monitor]	→ 264
[Luminance Spot Meter]	→ 266
[Zebra Pattern]	→ 267
[Frame Marker]	→ 268

Image Quality (Video)

[Rec. File Format]	→ 249
[Rec Quality]	→ 250
Resolution	→ 250
Recording frame rate	→ 250
Bit rate	→ 250
[Flicker Decrease (Video)]	→ 365

Exposure (Video)

Exposure settings	→ 241 → 247
Luminance level	→ 259
Knee	→ 260

Audio

External microphone	→ 293
XLR Microphone Adaptor	→ 296
Headphones	→ 298
[Sound Output]	→ 298
[Sound Rec Level Disp.]	→ 263
[Sound Rec Level Adj.]	→ 263
Wind noise reduction	→ 263
Attenuator	→ 263

Playback	
[Auto Review]	→ 382
Playing back pictures	→ 300
Playing back videos	→ 303
Thumbnail display	→ 308
Calendar display	→ 309
Enlarged display	→ 306
Group images	→ 310
Saving 6K/4K photos	→ 139
Viewing on a TV	→ 475
Deleting	→ 311
Screen display	→ 499
[Slide Show]	→ 407

Editing of Images	
[RAW Processing]	→ 312
[Protect]	→ 411
[Rating]	→ 411
[Resize]	→ 412
[Rotate]	→ 412
[Video Divide]	→ 318
[Copy]	→ 413

Customization	
[Custom] menu	→ 370
Function button	→ 321
Custom recording mode	→ 337
[My Menu]	→ 341
Quick menu	→ 332
Dial operation	→ 330
Saving camera settings	→ 343

Connecting with Other Devices	
Sending images (PC)	→ 478
Printing	→ 486
Viewing on a TV	→ 475
HDMI output	→ 289 → 476
Tethered recording	→ 484

Wi-Fi/Bluetooth	
Bluetooth connection	→ 420
[Wi-Fi connection]	→ 424 → 460
[Wi-Fi Setup]	→ 468
Smartphone app “LUMIX Sync”	→ 418
[Remote shooting]	→ 431
Location information	→ 439
Sending images ([Smartphone])	→ 435 → 447
Sending images ([PC])	→ 451
Sending images ([Printer])	→ 454
Sending images ([Web service])	→ 456
Sending images ([Cloud Sync. Service])	→ 458
Saving camera settings	→ 442
“LUMIX CLUB”	→ 469

Software	
“PHOTOfunSTUDIO”	→ 481
“SILKYPIX”	→ 482
“LUMIX Tether”	→ 484

Maintenance	
[Sensor Cleaning]	→ 404
[Pixel Refresh]	→ 404

1. Introduction

Before Use

❖ Firmware of Your Camera/Lens

Firmware updates may be provided in order to improve camera capabilities or to add functionality. For smoother recording, we recommend updating the firmware of the camera/lens to the latest version.

- **For the latest information on the firmware or to download/update the firmware, visit the following support site:**
<https://panasonic.jp/support/global/cs/dsc/>
(English only)
- To check the firmware version of the camera/lens, attach the lens to the camera and select [Firmware Version] in the [Setup] ([Others]) menu. You can also update the firmware in [Firmware Version]. (→ 405)
- You can also update the firmware from a smartphone.
For details, refer to [Help] in “LUMIX Sync”. (→ 419)
- This document provides explanations for camera firmware version 1.0.

❖ Handling of the Camera

When using the camera, take care not to drop it, bump it, or apply undue force. These may cause malfunction or damage to the camera and lens.

If sand, dust, or liquid gets on the monitor, wipe it off with a dry soft cloth.

- Touch operations may be incorrectly recognized.

Do not place a hand inside the camera mount.

This may cause a failure or damage because the sensor is a precision device.

The sensor can move, making a rattling noise, when the camera is shaken while it is off. This is caused by the image stabilizer mechanism in the body. It is not a malfunction.

❖ **Splash Resistant**

Splash Resistant is a term used to describe an extra level of protection this camera offers against exposure to a minimal amount of moisture, water or dust. Splash Resistant does not guarantee that damage will not occur if this camera is subjected to direct contact with water.

In order to minimize the possibility of damage please be sure the following precautions are taken:

- Splash Resistant works in conjunction with the lenses that were specifically designed to support this feature.
- Securely close the doors, contact points cover, etc.
- When the lens or cap is removed or a door is open, do not allow sand, dust, and moisture to enter inside.
- If liquid gets on the camera, wipe it off with a dry soft cloth.

❖ **Condensation (When the Lens, the Viewfinder or Monitor is Fogged Up)**

- Condensation occurs when there are temperature or humidity differences. Take care as this may lead to soiling, mold, and malfunctions in the lens, viewfinder, and monitor.
- If condensation occurs, turn off the camera and leave it for approx. 2 hours. The fog will disappear naturally when the temperature of the camera becomes close to the ambient temperature.

❖ **Be Sure to Perform Trial Recording in Advance**

Perform trial recording in advance of an important event (wedding, etc.) to check that recording can be performed normally.

❖ **No Compensation Regarding Recording**

Please note that compensation cannot be provided in the event that recording could not be performed due to a problem with the camera or a card.

❖ **Be Careful with Regard to Copyrights**

Under copyright law, you may not use the images and audio you have recorded for other than personal enjoyment without the permission of the copyright holder. Be careful because there are cases where restrictions apply to recording even for the purpose of personal enjoyment.

❖ **Also Read “Cautions for Use” (→ [516](#))**

Standard Accessories

Check that all the accessories are supplied before using the camera.

- The accessories and their shape will differ depending on the country or area where the camera was purchased.

For details on the accessories, refer to "Owner's Manual <Basic>" (supplied).

- **Digital camera body** is referred to as **camera** in this document.
- **Battery pack** is referred to as **battery pack** or **battery** in this document.
- **Battery charger** is referred to as **battery charger** or **charger** in this document.
- **The memory card is optional.**

Lenses That Can Be Used

The lens mount of this camera is compliant with the L-Mount standard of Leica Camera AG.

It can be used with 35 mm full-frame interchangeable lenses and APS-C size interchangeable lenses of this standard.

- The interchangeable lenses used in the explanations are designated as follows in this document.

Types of interchangeable lens	Designation in this document
35 mm full-frame interchangeable lens	full-frame lens
APS-C-size interchangeable lens	APS-C lens

- When there is no distinguishing the type of lens, the explanation will use **lens**.
- **Refer to catalogs/websites for most current information regarding supported lenses.**

<https://panasonic.jp/support/global/cs/dsc/>

(English only)



- The angle of view while recording with an APS-C lens is equivalent to the angle of view of a focal length of 1.5× when converted to the focal length of a 35 mm film camera. (If a 50 mm lens is used, the angle of view will be equivalent to a 75 mm lens.)
- As the image area narrows, the following functions are not available when using an APS-C lens:
 - 6K photo
 - [High Resolution Mode]
 - [Multiple Exposure]

Memory Cards That Can Be Used

You can use the following memory cards with this camera.

- SD memory card, SDHC memory card, and SDXC memory card are referred to by the generic name of **card** in this document.





SD memory card (512 MB to 2 GB)	The SDHC/SDXC cards supported by card slot 1 and 2 on this camera are different.  <ul style="list-style-type: none">• Card slot 1<ul style="list-style-type: none">– UHS Speed Class 3 of the UHS-I/UHS-II standard– Video Speed Class 90 of the UHS-II standard• Card slot 2<ul style="list-style-type: none">– UHS Speed Class 3 of the UHS-I standard• Operation with the Panasonic cards on the left has been verified.
SDHC memory card (4 GB to 32 GB)	
SDXC memory card (48 GB to 128 GB)	

❖ Cards That Can Be Used Stably with This Camera

When using the following functions, use cards that have the correct SD Speed Class, UHS Speed Class, and Video Speed Class.

- Speed classes are standards to guarantee the minimum speed necessary for continuous writing.

[Video Record]

Bit rate of the recording quality	Speed Class	Example of indication
72 Mbps	Class 10	CLASS  
	UHS Speed Class 1 or higher	
	Video Speed Class 10 or higher	V10
100 Mbps to 200 Mbps	UHS Speed Class 3	
	Video Speed Class 30 or higher	V30

[6K/4K PHOTO]/[Post-Focus]

Speed Class	Example of indication
UHS Speed Class 3	
Video Speed Class 30 or higher	V30



- You can prevent the writing and deleting of data by setting the write-protect switch (A) on the card to "LOCK".
- The data stored on a card may be damaged due to electromagnetic waves, static electricity or a failure of the camera or card. We recommend backing up important data.
- Keep the memory card out of reach of children to prevent swallowing.



Names of Parts

Camera

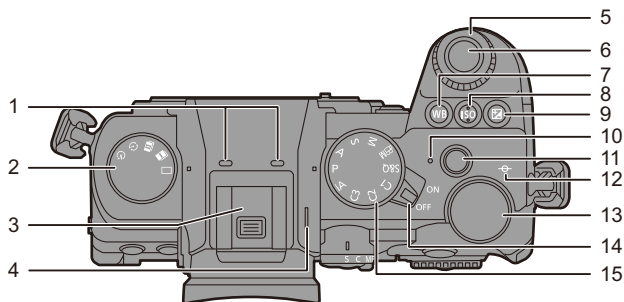

1	<p>Stereo microphone (→ 263)</p> <ul style="list-style-type: none"> • Do not block the microphone with a finger. Audio will be difficult to record.
2	Drive mode dial (→ 128)
3	<p>Hot shoe (hot shoe cover) (→ 227)</p> <ul style="list-style-type: none"> • Keep the hot shoe cover out of reach of children to prevent swallowing.
4	Speaker (→ 399)
5	Front dial (→ 61)
6	Shutter button (→ 59)
7	[WB] (White balance) button (→ 202)

8	[ISO] (ISO sensitivity) button (→ 199)
9	[+/-] (Exposure compensation) button (→ 196)
10	Charging light (→ 40)/ Wireless connection light (→ 416)
11	Video rec. button (→ 240)
12	[-∞] (Recording distance reference mark) (→ 123)
13	Rear dial (→ 61)
14	Camera on/off switch (→ 54)
15	Mode dial (→ 60)

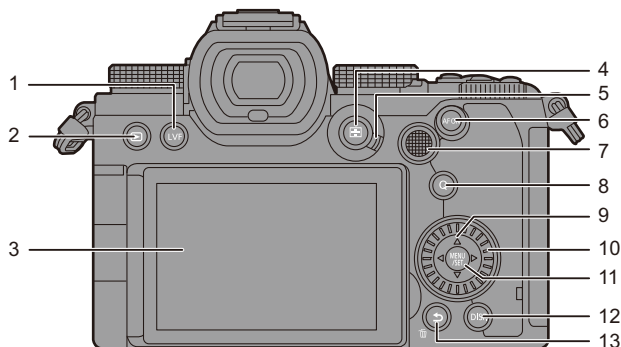

1	[LVF] button (→ 66)
2	[▶] (Playback) button (→ 300)
3	Monitor (→ 32, 493)/ Touch screen (→ 64)
4	[[] (AF mode) button (→ 94)
5	Focus mode lever (→ 93, 94, 120)
6	[AF ON] button (→ 95)
7	Joystick (→ 63)/ Fn buttons (→ 321) Center: Fn8, ▲: Fn9, ▶: Fn10, ▼: Fn11, ◀: Fn12

8	[Q] (Quick menu) button (→ 69)
9	Cursor buttons (→ 62)/ Fn buttons (→ 321) ▲: Fn13, ▶: Fn14, ▼: Fn15, ◀: Fn16
10	Control dial (→ 62)
11	[MENU/SET] button (→ 62, 73)
12	[DISP.] button (→ 67)
13	[↵] (Cancel) button (→ 68, 75)/ [🗑️] (Delete) button (→ 311)/ Fn button (Fn1) (→ 321)

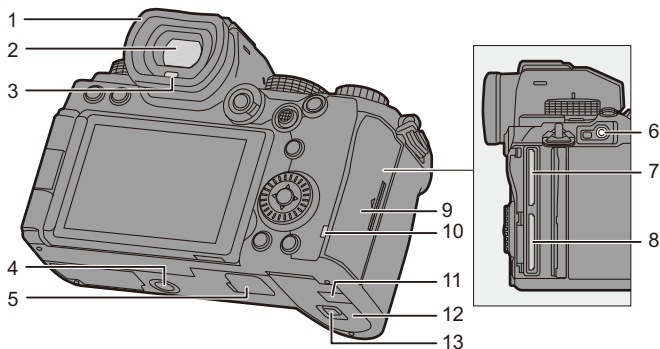

1	Eye cup (→ 518)	6	[REMOTE] socket (→ 491)
2	Viewfinder (→ 32, 66, 493)	7	Card slot 1 (→ 46)
3	Eye sensor (→ 66)	8	Card slot 2 (→ 46)
4	Tripod mount (→ 523) • If you attempt to attach a tripod with a screw length of 5.5 mm (0.22 inches) or more, you may not be able to securely fix it in place or it may damage the camera.	9	Card door (→ 46)
5	Battery grip connector (cover for the battery grip connector) (→ 490) • Keep the cover for the battery grip connector out of reach of children to prevent swallowing.	10	Card access light (→ 46)
		11	DC coupler cover (→ 492) • When using an AC adaptor, ensure that the Panasonic DC Coupler (DMW-DCC17: optional) and AC Adaptor (DMW-AC10: optional) are used.
		12	Battery door (→ 37)
		13	Battery door release lever (→ 37)

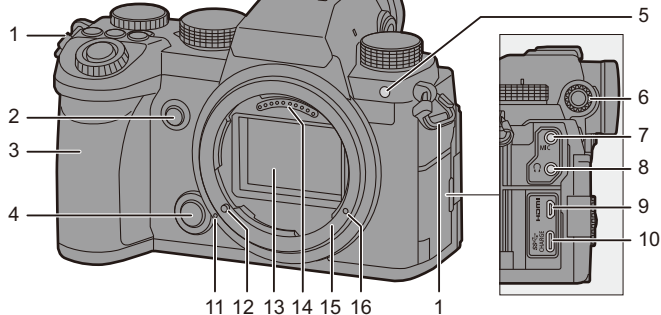

1	Shoulder strap eyelet (→ 33)
2	Preview button (→ 195)/ Fn button (Fn2) (→ 321)
3	Grip
4	Lens release button (→ 49)
5	Self-timer light (→ 154)/ AF assist light (→ 355)
6	Diopter adjustment dial (→ 65)
7	[MIC] socket (→ 293)
8	Headphone socket (→ 298) • Excessive sound pressure from earphones and headphones can cause hearing loss.

9	[HDMI] socket (→ 289, 473)
10	USB port (→ 39, 474)
11	Lens fitting mark (→ 49)
12	Lens lock pin
13	Sensor
14	Contact points
15	Mount
16	Screw hole for function expansion

Supplied Lens

S-R2060

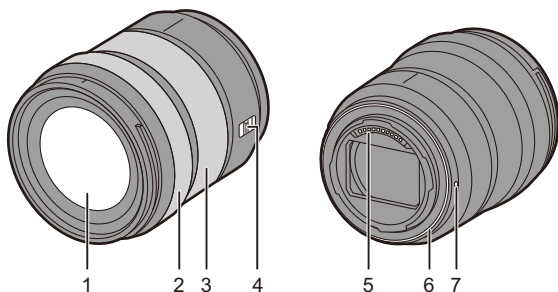

1	Lens surface
2	Focus ring (→ 121)
3	Zoom ring (→ 124)
4	[AF/MF] switch (→ 94, 120) <ul style="list-style-type: none"> You can switch between AF and MF. If [MF] is set on either the lens or camera, operation will be with MF.

5	Contact points
6	Lens mount rubber (→ 519)
7	Lens fitting mark (→ 49)

- 
 Recording at or near the closest focusing distance at wide angle will degrade image quality around the edges of the image. We recommend checking each picture after you have taken it when recording.

Viewfinder/Monitor Displays

At the time of purchase, the viewfinder/monitor displays the following icons.

- For information about the icons other than those described here, refer to page 493.

Viewfinder

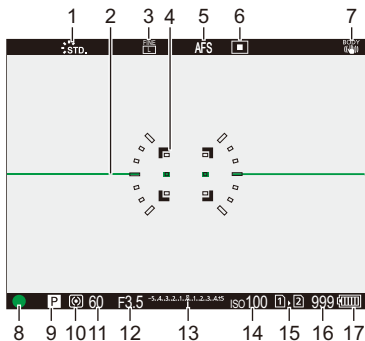

Monitor

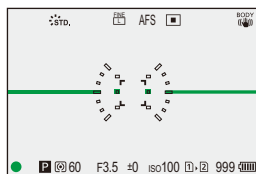

1	Photo Style (→ 208)
2	Level gauge (→ 391)
3	Picture quality (→ 86)/ Picture size (→ 85)
4	AF area (→ 115)
5	Focus mode (→ 93, 120)
6	AF mode (→ 100)
7	Image stabilizer (→ 177)
8	Focus (green) (→ 59, 95)/ Recording state (red) (→ 223, 241)
9	Recording mode (→ 60)
10	Metering mode (→ 184)

11	Shutter speed (→ 59)
12	Aperture value (→ 59)
13	Exposure compensation value (→ 196)/ Manual Exposure Assist (→ 193)
14	ISO sensitivity (→ 199)
15	Card slot (→ 46)/ Double card slot function (→ 88)
16	Number of still images that can be taken (→ 528)/ Number of pictures that can be taken continuously (→ 131)
17	Battery indication (→ 42)



- Press [↵] to switch between display/hide of the level gauge.

2. Getting Started

Attaching a Shoulder Strap

Attach a shoulder strap to the camera with the following procedure to prevent it from dropping.

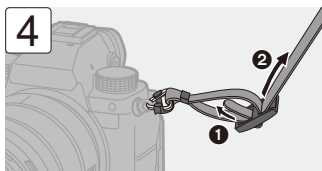
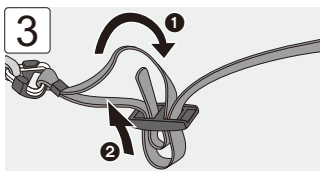
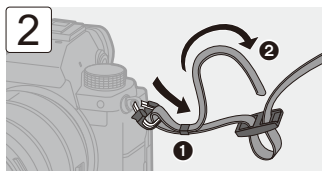
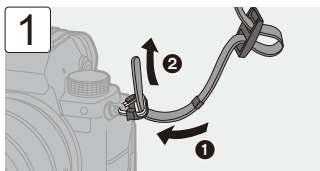

- Pull the shoulder strap and check that it will not come out.
- Attach the opposite end of the shoulder strap with the same procedure.
- Use the shoulder strap around your shoulder.
 - Do not wrap the strap around your neck.
It may result in injury or accident.
- Do not leave the shoulder strap where an infant can reach it.
 - It may result in an accident by mistakenly wrapping around the neck.

Charging the Battery

You can charge the battery either using the supplied charger, or in the camera body.

You can also turn on the camera and supply power from an electrical outlet.

- The battery that can be used with the camera is DMW-BLK22. (As of September 2020)



- The battery is not charged at the time of purchase. Charge the battery before use.

Charging with the Charger

Charging time	Approx. 230 min
----------------------	-----------------

- Use the supplied charger and AC adaptor.
- The indicated charging time is for when the battery has been discharged completely. The charging time may vary depending on how the battery has been used. The charging time for the battery in hot/cold environments or a battery that has not been used for a long time may be longer than normal.



- **Use the products supplied with the camera for charging.**
- Use the charger indoors.

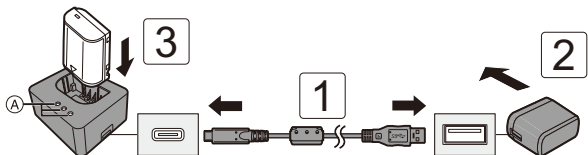

1 Connect the charger and the AC adaptor with the USB connection cable.

- Check the direction of the terminals and plug in/out straight holding onto the plug.
(Inserting these at an angle may cause deformation or malfunction)

2 Connect the AC adaptor to an electrical outlet.

3 Insert the battery.

- The charging lights ([CHARGE]) (A) blink and charging begins.



- Do not use any other USB connection cables except the supplied one. This may cause malfunction.
- Do not use any other AC adaptors except the supplied one. This may cause malfunction.

❖ Charging Lights Indications

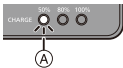
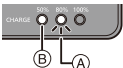
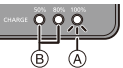
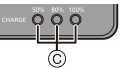
Charging status	0 % to 49 %	50 % to 79 %	80 % to 99 %	100 %
Charging lights				
	(A) Blinking	(B) On	(C) Off	

- When the battery is inserted while the charger is not connected to the power source, the charging lights turn on for a certain period to allow you to confirm the battery level.



- After charging, disconnect the power source connection and remove the battery.
- If the [50%] light is blinking quickly, then charging is not occurring.
 - The temperature of the battery or surroundings is either too high or too low. Try charging at an ambient temperature between 10 °C and 30 °C (50 °F and 86 °F).
 - The terminals of the charger or the battery are dirty. Remove the connection to the power source, and wipe with a dry cloth.

Battery Insertion

- Always use genuine Panasonic batteries (DMW-BLK22).
- If you use other batteries, we cannot guarantee the quality of this product.

- ✎ • Check that the camera on/off switch is set to [OFF].

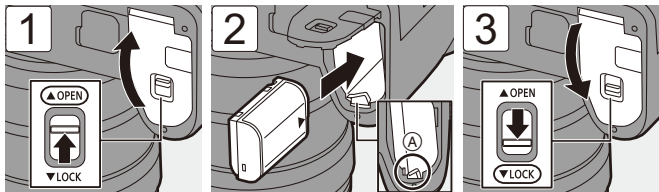

- Check that the lever (A) is holding the battery in place.

❖ Removing the Battery

- 1 Set the camera on/off switch to [OFF].
- 2 Open the battery door.
 - Check that the card access light (B) is turned off and then open the battery door.
- 3 Push the lever (A) in the direction of the arrow and then remove the battery.

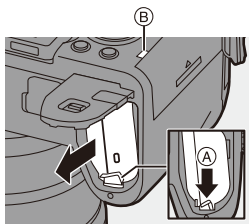



- Ensure that no foreign objects are adhering to the inner side (cushion) of the battery door.
- Remove the battery after use.
(The battery will drain if left inserted in the camera for a long period of time.)
- The battery becomes warm after use, during charging, and immediately after charging.
The camera also becomes warm during use. This is not a malfunction.
- Be careful when removing the battery as the battery will jump out.

Inserting a Battery into the Camera for Charging

Charging time

Approx. 240 min

- Using the camera body and the supplied AC adaptor.
- The indicated charging time is for when the battery has been discharged completely. The charging time may vary depending on how the battery has been used. The charging time for the battery in hot/cold environments or a battery that has not been used for a long time may be longer than normal.

- Use the products supplied with the camera for charging.

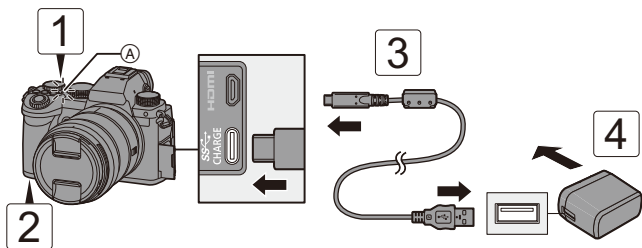

- 1** Set the camera on/off switch to [OFF].
- 2** Insert the battery into the camera.
- 3** Connect the camera USB port and the AC adaptor using the USB connection cable.
 - Check the direction of the terminals and plug in/out straight holding onto the plug.
(Inserting these at an angle may cause deformation or malfunction)
- 4** Connect the AC adaptor to an electrical outlet.
 - The charging light (A) turns red and charging begins.

❖ Charging Light Indications

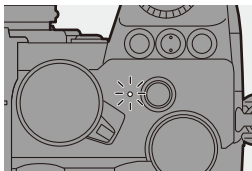

Charging light (red)

On: Charging.

Off: Charging has completed.

Blinking: Charging error.



- You can also charge the battery by connecting a USB device (PC, etc.) and the camera with the USB connection cable. Charging may take longer in this case.
- The battery in the Battery Grip (DMW-BGS5: optional) cannot be charged.



- Do not use any other USB connection cables except the supplied one. This may cause malfunction.
- Do not use any other AC adaptors except the supplied one. This may cause malfunction.
- After charging, disconnect the connection to the power source.
- While the charging light is blinking red, charging is not possible.
 - The temperature of the battery or surroundings is either too high or too low. Try charging at an ambient temperature between 10 °C and 30 °C (50 °F and 86 °F).
 - The terminals of the battery are dirty. Remove the battery and wipe off the dirt with a dry cloth.
- Even when the camera on/off switch is set to [OFF] thus turning the camera off, it consumes power. When the camera will not be used for a long time, remove the power plug from the electrical outlet in order to save power.

❖ Power Supply

When the battery is inserted into the camera for charging and the camera is turned on, you can record while the camera is being supplied with power.

- [] is displayed in the screen while power is being supplied.





- You can also supply power by using a USB connection cable to connect the camera and a USB device (PC, etc.).



- The battery cannot be charged while power is being supplied.
- Turn off the camera before connecting or disconnecting the AC adaptor.
- Remaining charge in the battery may decrease depending on usage conditions. When the battery level is depleted, the camera will turn off.
- If the temperature of the camera rises, [] may be displayed, recording may stop, and some functions may become unavailable temporarily. Wait until the camera cools down.
- Depending on the power supply capabilities of the connected device, it may not be possible to supply power.



- USB power supply can be turned off:
[] ⇒ [] ⇒ [USB] ⇒ [USB Power Supply] (→ 400)

Notifications Regarding Charging/Power Supply

❖ Power Indications

Indication on monitor

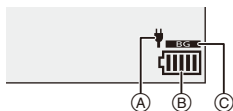

- Ⓐ USB connection cable supplying power
- Ⓑ Battery indication
- Ⓒ Using the battery in the Battery Grip

	80 % or higher
	60 % to 79 %
	40 % to 59 %
	20 % to 39 %
	19 % or below
	Low battery <ul style="list-style-type: none"> • Charge or replace the battery.



- The battery level indicated on the screen is approximate.
The exact level varies depending on the environment and the operating conditions.



- **We recommend that genuine Panasonic batteries are used.**
There is a possibility that the use of non-genuine batteries can cause accidents or malfunctions that may lead to fire or explosion.
Please be advised that we are not liable for any accident or failure resulting from the use of non-genuine batteries.
- Do not leave any metal items (such as clips) near the contact areas of the power plug.
Otherwise, a fire and/or electric shocks may be caused by short-circuiting or the resulting heat generated.
- Do not use the AC adaptor or USB connection cable on other devices.
This may cause a malfunction.
- Do not use USB extension cables or USB conversion adaptors.
- The battery can be charged even when it still has some charge left, but it is not recommended that the battery charge be frequently topped up while the battery is fully charged.
(Since characteristic swelling may occur.)
- If there is a power outage or other problem with the electrical outlet, then charging may not complete successfully.
Reconnect the power plug.
- Do not connect to keyboard or printer USB ports, or to USB hubs.
- If the connected PC enters sleep status, then charging/power supply may stop.

[Power Save Mode]

This is a function to automatically turn the camera to sleep (power save) status or turn off the viewfinder/monitor if no operation is performed for a set time. Reduces battery consumption.

 ⇒ [] ⇒ [] ⇒ Select [Power Save Mode]

[Sleep Mode]	Sets the amount of time until the camera is put to sleep.	
[Sleep Mode(Wi-Fi)]	Sets the camera to sleep 15 minutes after being disconnected from Wi-Fi.	
[Auto LVF/Monitor Off]	Sets the amount of time it takes for the viewfinder/monitor to turn off. (The camera is not turned off.)	
[Power Save LVF Shooting]	Puts the camera to sleep when the recording screen is being displayed on the monitor when automatic viewfinder/monitor switching is active.	
	[Time to Sleep]	Sets the amount of time until the camera is put to sleep.
	[Method of Activation]	Sets the screen where the camera is put to sleep. [Only Control Panel]: Puts the camera to sleep only when the control panel (→ 67) is displayed. [While Recording Standby]: Puts the camera to sleep from any screen during recording standby.

- To recover from [Sleep Mode], [Sleep Mode(Wi-Fi)], or [Power Save LVF Shooting], perform one of the following operations:
 - Press the shutter button halfway.
 - Set the camera on/off switch to [OFF] and then [ON] again.
- To recover from [Auto LVF/Monitor Off], press any button.



- [Power Save Mode] is not available in the following cases:
 - While connected to a PC or printer
 - During video recording/video playback
 - When recording with [6K/4K Pre-Burst]
 - During a [Time Lapse Shot]
 - When recording with [Stop Motion Animation] (when [Auto Shooting] is set)
 - When recording with [Live View Composite]
 - When recording with [Multiple Exposure]
 - During a [Slide Show]
 - During HDMI output for recording

Inserting Cards (Optional)

This camera supports the double card slot function.

When two cards are used, relay recording, backup recording, and allocation recording are available.

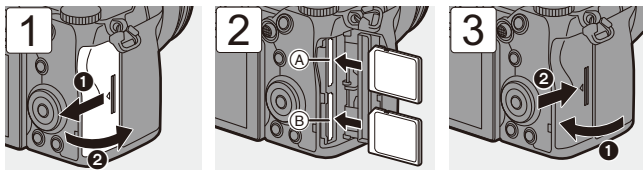

(A) Card slot 1 (compatible with UHS-I/UHS-II)

(B) Card slot 2 (compatible with UHS-I)

- Match the orientation of the cards as shown in the figure and then insert them firmly until they click.



• You can set the way to record to card slots 1 and 2:

[] ⇒ [] ⇒ [Double Card Slot Function] (→ 88)

❖ Card Access Indications

The card access light turns on while the card is being accessed.

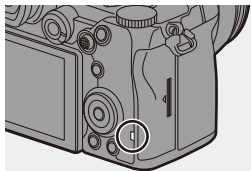

❖ Removing a Card

- 1 Open the card door.
 - Check that the card access light (A) is turned off and then open the card door.
- 2 Push the card until it clicks and then pull the card out straight.

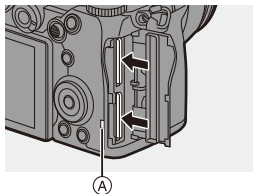

- The card may be warm just after the camera has been used.
- **Do not perform the following operations during access. The camera may operate incorrectly or the card and recorded images may be damaged.**
 - Turn off the camera.
 - Remove the battery or card or disconnect the power plug.
 - Subject the camera to vibration, impacts, or static electricity.

Formatting Cards (Initialization)



Format the cards with the camera before use.



- When a card is formatted, all of the data stored in the card is erased and cannot be restored.

Save a backup of necessary data before formatting the card.



⇒ [] ⇒ [] ⇒ Select [Card Format]



Settings: [Card Slot 1]/[Card Slot 2]



- Do not turn off the camera or perform another operation during formatting.
- Take care not to turn off the camera while formatting is in progress.
- If the card has been formatted with a PC or other device, format it again with the camera.



- You can format the card while keeping the camera settings information stored on the card:

[] ⇒ [] ⇒ [Save/Restore Camera Setting] ⇒ [Keep Settings While Format] (→ [343](#))

Attaching a Lens

You can attach the Leica Camera AG L-Mount standard lens to this camera.

For information about the lenses that can be used, refer to page 23.

-  • Check that the camera on/off switch is set to [OFF].
- Change the lens in a location where there is not a lot of dirt and dust. If dirt or dust gets on the lens, refer to page 517.
- Change the lens while the lens cap is attached.

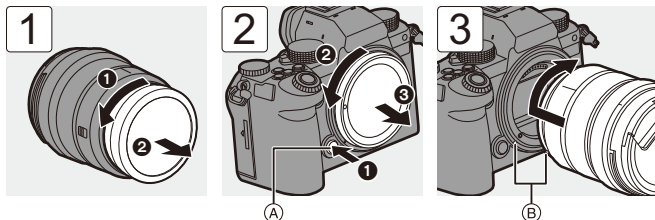

- When removing the body cap, rotate it while pressing the lens release button (A).

(B) Lens fitting marks

❖ Removing a Lens

- While pressing the lens release button (A), rotate the lens in the direction of the arrow until it stops and then remove it.

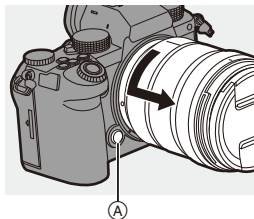



- When you have attached a lens that does not have a communication function with this camera, after turning on the camera, a message asking for confirmation of the focal length setting is displayed.
You can register the focal length of the lens when you select [Yes]. (→ [183](#))
- Insert the lens straight in.
Inserting this at an angle to attach it may damage the camera lens mount.
- After removing the lens, be sure to attach the body cap and the lens rear cap.

Attaching a Lens Hood

For recording against strong backlight, a lens hood can reduce the inclusion of unwanted light in images and drop in contrast resulting from the irregular reflection of light that occurs within the lens.

It allows you take more beautiful pictures by cutting out excess light.

When attaching the lens hood (flower shape) supplied with the interchangeable lens (S-R2060)

Hold the lens hood by placing your fingers as shown in the figure.

- Do not hold the lens hood in such a way that it will become bent.

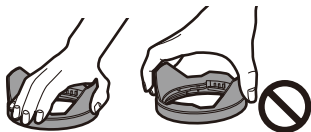

- 1** Align mark **A** (□) on the lens hood with the mark on the tip of the lens.

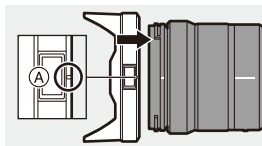

- 2** Rotate the lens hood in the direction of the arrow to align mark **B** (○) on the lens hood with the mark on the tip of the lens.

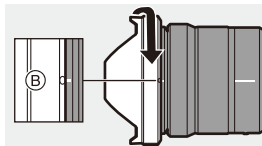

- Attach the lens hood by rotating it until it clicks.

❖ Removing the Lens Hood

While pressing the lens hood button (A), rotate the lens hood in the direction of the arrow and then remove it.

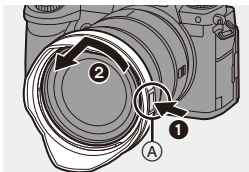

• The lens hood can be attached in the reverse direction when carrying the camera.

- 1 Align mark (B) (O) on the lens hood with the mark on the tip of the lens.
- 2 Attach the lens hood by rotating it in the direction of the arrow until it clicks.

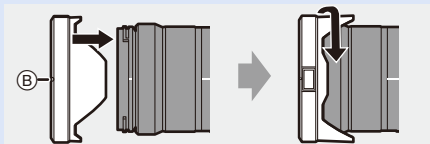

Adjusting the Monitor Direction and Angle

At the time of purchase, the monitor is stowed in the camera body.

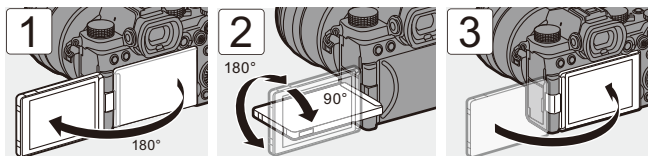

- The angles of adjustment are guides only.
- Do not apply an excessive force to the monitor. This may cause damage or malfunction.
- When not using the camera, close the monitor with the monitor surface facing in.

Setting the Clock (When Turning On for the First Time)

When you turn the camera on for the first time, a screen to set the time zone and clock appears.

Be sure to set these settings before use to ensure images are recorded with the correct date and time information.



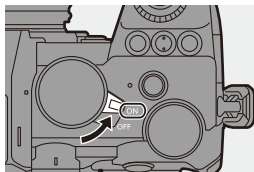

1 Set the camera on/off switch to [ON].

- If the language select screen is not displayed, proceed to Step 4.









2 When [Please set the language] appears, press or .

3 Set the language.

- Press   to select the language and then press  or .

4 When [Please set the time zone] appears, press or .

5 Set the time zone.

- Press   to select the time zone and then press  or .
- If you are using Daylight Savings [], press . (The time will move forward by 1 hour.)
To return to the normal time, press  again.





 A Time difference from GMT (Greenwich Mean Time)

6 When [Please set the clock] appears, press  or .

7 Set the clock.

- ◀▶: Select an item (year, month, day, hour, minute, or second).
- ▲▼: Select a value.

To set the display order  and time display format 

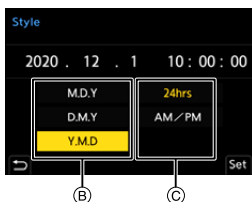
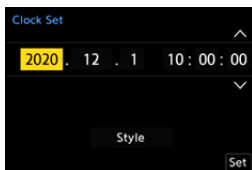

- Press ◀▶ to select [Style] and then press  or  to display the screen for setting the display order and time display format.

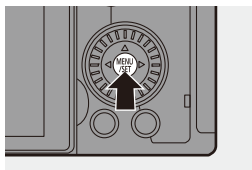

8 Confirm your selection.

- Press  or .







9 When [The clock setting has been completed.] appears, press  or .



- If the camera is used without setting the clock, it will be set to 0:00:00, January 1st 2020.
- Clock settings are maintained for approx. 3 months using the built-in clock battery even without the battery.
(Leave the fully-charged battery in the camera for approx. 24 hours to charge the built-in battery.)



- [Time Zone] and [Clock Set] can be changed from the menu:
 - [] ⇒ [] ⇒ [Time Zone] (→ [404](#))
 - [] ⇒ [] ⇒ [Clock Set]

3. Basic Operations

Basic Recording Operations

How to Hold the Camera

To minimize camera shake, hold the camera so that it will not move during recording.

Hold the camera with both hands, keep your arms still at your side, and stand with your feet shoulder width apart.

- Hold the camera firmly by wrapping your right hand around the camera grip.
- Support the lens from below with your left hand.
- Do not cover the AF assist light (A) or microphone (B) with your fingers or other objects.

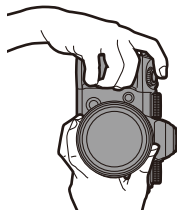
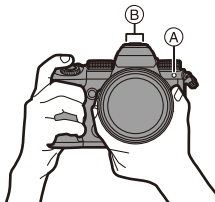

❖ Vertical Orientation Detection Function

This function detects when pictures were recorded with the camera held vertically orientated.

With the default settings, pictures are automatically played back vertically oriented.

- If you set [Rotate Disp.] to [OFF], pictures will be played back without being rotated. (→ [407](#))

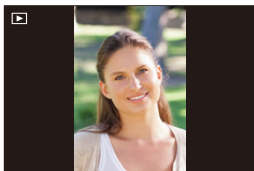

- When the camera is tilted significantly up or down, the vertical orientation detection function may not work correctly.
- Images recorded using the following functions are played back vertically oriented only when displayed in thumbnail format:
 - Video recording/[6K/4K PHOTO]/[Post-Focus]

Recording

1 Adjust the focus.

- Press the shutter button halfway (press it gently).
- The aperture value (A) and shutter speed (B) are displayed. (When the correct exposure cannot be obtained, the indications blink in red.)
- Once the subject is in focus, the focus icon (C) lights. (When the subject is not in focus, the icon blinks.)
- You can also perform the same operation by pressing [AF ON].

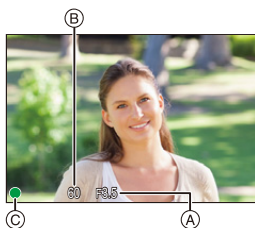
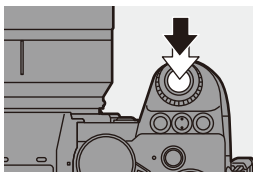

2 Start recording.

- Press the shutter button fully (press it further).
- When recording videos, press the video rec. button. (→ 240)

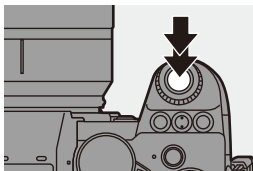



Recorded pictures can be displayed automatically by setting [Auto Review] of the [Custom] ([Monitor / Display (Photo)]) menu. You can also change the picture display duration to your preferred setting. (→ 382)



With the default settings, you cannot take a picture until the subject is brought into focus.

If you set [Focus/Shutter Priority] in the [Custom] ([Focus/Shutter]) menu to [BALANCE] or [RELEASE], you will be able to take a picture even when the subject is not in focus. (→ 373)

Selecting the Recording Mode

Rotate the mode dial to select the recording mode.

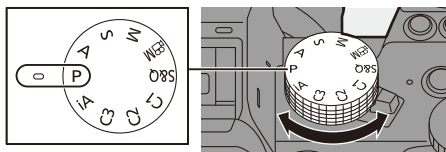

[iA]	Intelligent Auto mode (→ 77)
[P]	Program AE mode (→ 185)
[A]	Aperture-Priority AE mode (→ 187)
[S]	Shutter-Priority AE mode (→ 190)
[M]	Manual Exposure mode (→ 192)
[M]	Creative Video mode (→ 244)
[S&Q]	Slow & Quick mode (→ 269)
[C1]/[C2]/[C3]	Custom mode (→ 337)

Camera Setting Operations

When changing the camera settings, operate the camera using the following operation parts.

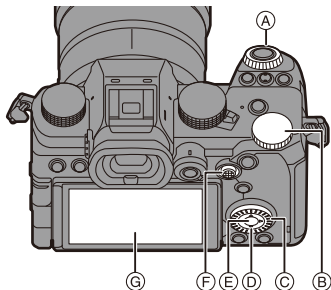

A	Front dial (→ 61)
B	Rear dial (→ 61)
C	Control dial (→ 62)
D	Cursor buttons (→ 62)
E	[MENU/SET] button (→ 62)
F	Joystick (→ 63)
G	Touch screen (→ 64)

❖ Front Dial (☀️)/Rear Dial (☂️)

Rotate:

Selects an item or numeric value.

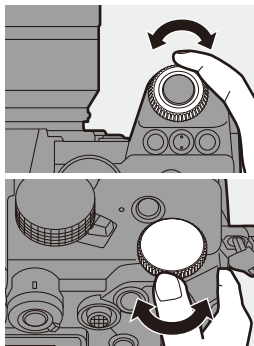

❖ Control Dial ()

Rotate:

Selects an item or numeric value.

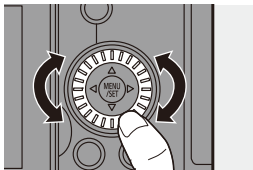

❖ Cursor Buttons ()

Press:

Selects an item or numeric value.

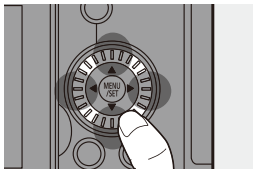

❖ [MENU/SET] Button ()

Press:

Confirms a setting.

- Displays the menu during recording and playback.

❖ Joystick (▲▼◀▶/⊙)

The joystick can be operated in 4 directions by tilting it up, down, left and right and by pressing the center part.

- Ⓐ **Tilt:** Selects an item or numeric value, or moves a position.
- Place your finger on the center of the joystick before tilting. The joystick may not work as expected when the sides are pressed.
- Ⓑ **Press:** Confirms a setting.

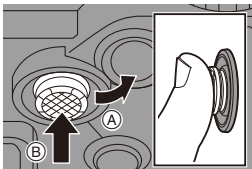

- ➔ • You can register [Operation Lock] to the Fn button to disable the operations of operating parts:
 [⚙] ➔ [🌞] ➔ [Fn Button Set] ➔ [Setting in REC mode] ➔ [Operation Lock] (➔ 321)

❖ Touch Screen

Operations can be performed by touching the icons, slide bars, menus, and other items displayed on the screen.

Ⓐ Touch

Operation of touching and then lifting your finger from the touch screen.

Ⓑ Drag

Operation of moving a finger while it touches the touch screen.

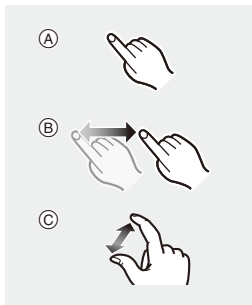

Ⓒ Pinch (widen/narrow)

Operations of widening the distance between two fingers (pinch out) and narrowing the distance between two fingers (pinch in) while they are touching the touch screen.



- If you will use a commercially available monitor protection sheet, observe the precautions for the sheet.
(Visibility and operability may be impaired depending on the type of monitor protection sheet.)



- Touch operations can be disabled:
[] → [] → [Touch Settings] (→ [377](#))

Monitor/Viewfinder Display Settings

Setting the Viewfinder

❖ Adjusting the Viewfinder Diopter

Rotate the diopter adjustment dial while looking through the viewfinder.

- Adjust until you can clearly see the text on the viewfinder.

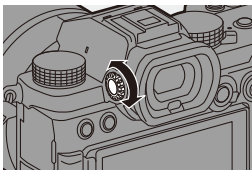

Switching Between the Monitor and Viewfinder

With the default settings, automatic viewfinder/monitor switching is set. When you look through the viewfinder, the eye sensor (A) works and the camera switches from monitor display to viewfinder display.

You can switch to viewfinder display or monitor display with [LVF] button (B).

Press [LVF].

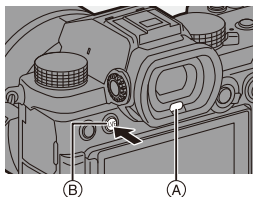

Automatic viewfinder/
monitor switching

Viewfinder display

Monitor display

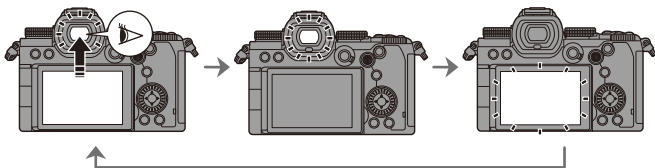

- The eye sensor may not work correctly due to the shape of eyeglasses, the way the camera is held, or bright light shining around the eyepiece.
- During video playback or slide show, automatic viewfinder/monitor switching does not work.



- To focus when looking through the viewfinder:
[] → [] → [Eye Sensor AF] (→ 376)
- The sensitivity of the eye sensor can be changed:
[] → [] → [Eye Sensor] (→ 398)

Switching the Display Information

Press [DISP.].

- The display information is switched.

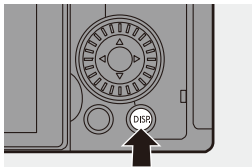

❖ Recording Screen

Monitor

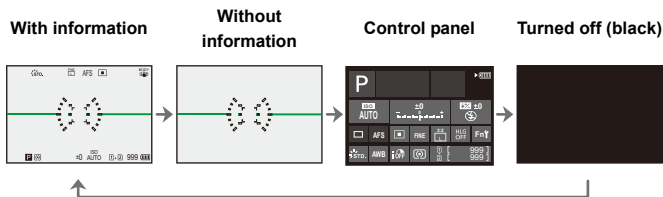

Viewfinder

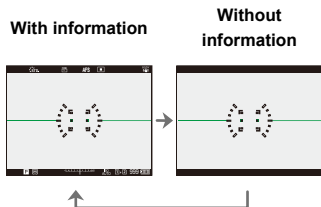



- Press [] to switch between display/hide of the level gauge.
This can also be set by using [Level Gauge]. (→ 391)



- Control panel operation (→ 71)
- You can hide the control panel and black screen:
[] → [] → [Show/Hide Monitor Layout] (→ 391)
- The display can be changed so that live view and display information do not overlap:
[] → [] → [LVF/Monitor Disp. Set] (→ 387)

❖ Playback Screen

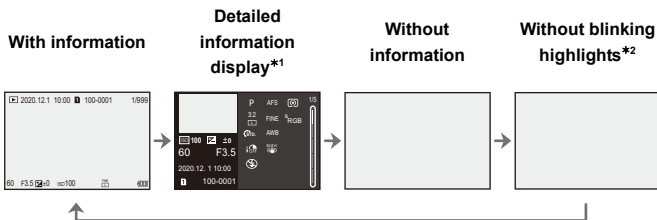

*1 Pressing ▲▼ switches the display information. (→ 501)

*2 This is a screen without blinking highlights display that is shown when [Blinking Highlights] of the [Custom] ([Monitor / Display (Photo)]) menu is set to [ON]. In other than this screen, overexposed parts of the screen will blink. (→ 389)

Quick Menu

This menu enables you to quickly set functions that are frequently used during recording without calling up the menu screen. You can also change the Quick menu display method and the items to display.

1 Display the Quick menu.

- Press [Q].

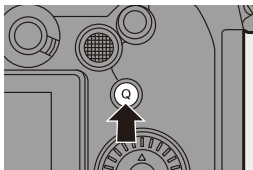



2 Select a menu item.

- Press ▲▼◀▶.
- Selection is also possible by rotating .
- Selection is also possible by touching a menu item.



3 Select a setting item.

- Rotate  or .
- Selection is also possible by touching a setting item.

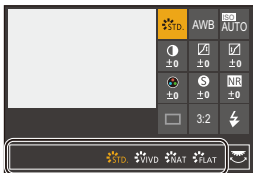

4 Close the Quick menu.

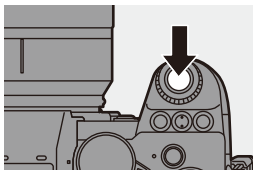

- Press the shutter button halfway.
- You can also close the menu by pressing [Q].





- Some items cannot be set depending on the recording mode or camera settings.



- The Quick menu can be customized:
[] → [] → [Q.MENU Settings] (→ [332](#))

Control Panel

This screen allows you to view the current recording settings on the monitor. You can also touch the screen to change the settings.

1 Display the control panel.

- Press [DISP.] several times.



2 Touch the items.

- The setting screens for each of the items are displayed.

3 Change the setting.

Example) Changing the AF mode



- Touch the setting item.
- Refer to the pages explaining each item for information on how to change the settings.



4 Touch [Set].

❖ Changing Directly Using the Dial

Steps **2** to **4** can also be changed using the following operations.

- 1 Press one of ▲▼◀▶ to enable selection of items.
 - Selected items are displayed in yellow.
- 2 Press ▲▼◀▶ to select an item.
 - Selection is also possible by rotating  or .
- 3 Rotate  to change the settings values.

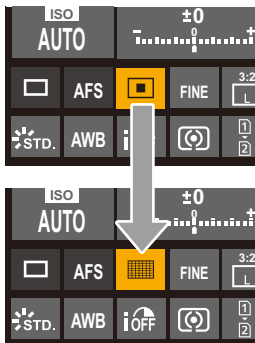

- Some items cannot be set depending on the recording mode or camera settings.

Menu Operation Methods



In this camera, the menu is used for setting a wide variety of functions and performing camera customizations.

Menu operations can be performed using the cursors, joystick, dial, or by touch.

Configuration and operation parts of the menu

The menu can be operated by pressing ◀▶ to move between menu screens. Direct operation of the main tabs, sub tabs, page tabs, and menu items is also possible without moving through the different menu levels by using the operation parts indicated in the parentheses below.

• You can also operate by touching the icons, menu items, and setting items.

- (A) Main tabs ([Q] button)
- (B) Sub tabs ()
- (C) Menu items ()
- (D) Page tabs ()
- (E) Setting items

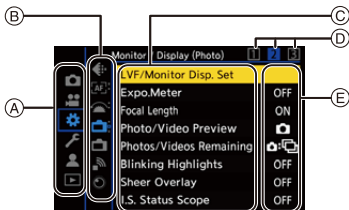

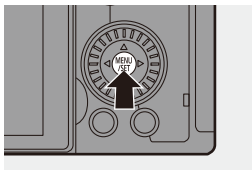

1 Display the menu.

- Press  .







2 Select a main tab.

- Press ▲▼ to select a main tab and then press ►.
- You can also perform the same operation by rotating  to select the main tab and then pressing  or .





3 Select a sub tab.

- Press ▲▼ to select a sub tab and then press ►.
- You can also perform the same operation by rotating  to select the sub tab and then pressing  or .
- If there are page tabs , then after the page tabs have finished switching, the next sub tab is switched to.



4 Select a menu item.

- Press ▲▼ to select a menu item and then press ►.
- You can also perform the same operation by rotating  to select the menu item and then pressing  or .



5 Select a setting item and then confirm your selection.

- Press ▲▼ to select a setting item and then press or .
- You can also perform the same operation by rotating to select the setting item and then pressing or .



6 Close the menu.

- Press the shutter button halfway.
- You can also close the menu by pressing several times.

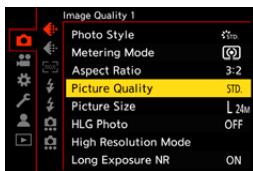

• For details about menu items, refer to Menu Guide. (→ 344)

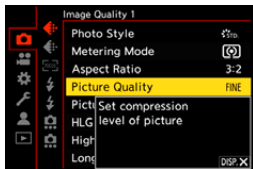

❖ Displaying Descriptions About Menu Items and Settings

If you press [DISP.] while a menu item or setting item is selected, a description about the item is displayed on the screen.



❖ Grayed Out Menu Items

Menu items that cannot be set are displayed grayed out.

If you press  or  while a grayed out menu item is selected, the reason why it cannot be set is displayed.

- The reason why a menu item cannot be set may not be displayed depending on the menu item.

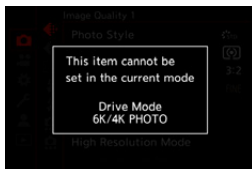



[Reset]

Return each of the following settings to the default setting:

- Recording settings
- Network settings (settings of [Wi-Fi Setup] and [Bluetooth])
- Setup and custom settings (other than [Wi-Fi Setup] and [Bluetooth])

 ⇒ [] ⇒ [] ⇒ Select [Reset]

-  • If the setup and custom settings are reset, the [Playback] menu is also reset.
- The folder numbers and clock settings are not reset.

-  • List of default settings and settings that can be reset (→ [531](#))

Intelligent Auto Mode

iA P A S M  S&Q



The [iA] mode (Intelligent Auto mode) can record images using settings automatically selected by the camera.

The camera detects the scene to set the optimal recording settings automatically to match the subject and recording conditions.

1 Set the mode dial to [iA].

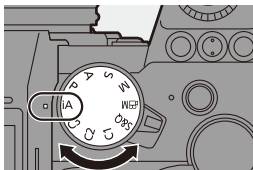

2 Aim the camera at the subject.

- When the camera detects the scene, the recording mode icon changes.
(Automatic Scene Detection)



3 Adjust the focus.

- Press the shutter button halfway.
- Once the subject is in focus, the focus icon lights.
(When the subject is not in focus, the icon blinks.)

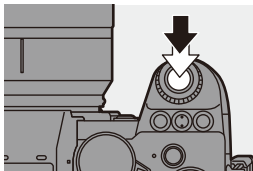

- [] of the AF mode works and the AF area is displayed aligned to any humans.

4 Start recording.

- Press the shutter button fully.

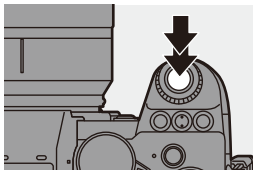

- Backlight compensation operates automatically to prevent subjects from appearing dark when there is a backlight.

❖ Types of Automatic Scene Detection

: Scenes detected during picture taking

: Scenes detected during video recording



:
i-Portrait



:
i-Portrait & Animal*1



:
i-Scenery



:
i-Macro



:
i-Night Portrait*2



:
i-Night Scenery



:
i-Food



:
i-Sunset



:
i-Low Light



:
iA

*1 Detected when animal detection is enabled. (→ 103)



*2 Detected when using an external flash.

- If none of the scenes are applicable, recording is with [iA] (standard setting).
- Different scene types may be selected for the same subject depending on the recording conditions.

❖ AF Mode

Changing the AF mode.

- Each press of [] changes the AF mode.

<p>[]/[] ([Face/Eye/ Body/Animal Detect.])</p>	<p>The camera detects a person's face, eyes, and body (entire body or upper half of the body) and the body of animals, and adjusts the focus.</p> <ul style="list-style-type: none"> • Each press of  switches the person, animal or eye to be brought into focus. It cannot be switched by touching. • Animal detection will maintain the enable/disable setting selected during other than [iA] mode. 	
<p>[] ([Tracking])</p>	<p>When the focus mode is set to [AFC], the AF area follows the movement of the subject, maintaining focusing.</p> <p>Aim the AF area over the subject and then press and hold the shutter button halfway.</p> <ul style="list-style-type: none"> • The camera will track the subject while the shutter button is pressed halfway or fully. 	

- ➔ • For information about AF modes, refer to page [102](#) and [105](#).

❖ Flash

When recording using a flash, the camera switches to the appropriate flash mode for the recording conditions.

When Slow Sync. ([iS], [iS]), be careful with regard to camera shake because the shutter speed becomes slow.

- When [iA] or [iS], Red-Eye Removal works.

- ➔ • For information about external flashes, refer to page [227](#).

Recording Using Touch Functions

Touch AF/Touch Shutter



Touch functions allow you to focus on the point that you touch, release the shutter, etc.

- With the default settings, the Touch Tab is not displayed. Set [Touch Tab] to [ON] in [Touch Settings] in the [Custom] ([Operation]) menu. (→ 377)

1 Touch [**<**].

2 Touch the icon.



- The icon switches each time you touch it.



Touch AF	Focus on the touched position.
Touch Shutter	Record with focus on the point touched.
OFF	—

3 (When set to anything other than OFF)
Touch the subject.



- When the Touch Shutter fails, the AF area first turns red and then disappears.
- ➔ • Refer to “Operations on the AF area movement screen” on page 104 for information about operations to move the AF area.
- It is also possible to optimize the focus and brightness on the touched position:
 [] ➔ [] ➔ [Touch Settings] ➔ [Touch AF] ➔ [AF+AE] (➔ 116)

Touch AE

iA P A S M  S&Q



This function adjusts the brightness according to a touched position. When a subject's face appears dark, you can make the screen brighter to match the face.

- With the default settings, the Touch Tab is not displayed. Set [Touch Tab] to [ON] in [Touch Settings] in the [Custom] ([Operation]) menu. (➔ 377)

1 Touch [].

2 Touch [ AE].

- The Touch AE settings screen appears.



3 Touch the subject to which you wish to adjust the brightness.

- To return the position to which to adjust the brightness to the center, touch [Reset].



4 Touch [Set].

❖ How to Disable Touch AE



Touch [].



- When the following function is being used, Touch AE is not available:
– [Live Cropping]



- You can also adjust both the focus and brightness to those of the position you touch. (At this time, Touch AE is not available):

[] ⇒ [] ⇒ [Touch Settings] ⇒ [Touch AF] ⇒ [AF+AE] (→ 116)

4. Image Recording

[Aspect Ratio]

iA P A S M  S&Q



You can select the image aspect ratio.



 → [] → [] → Select [Aspect Ratio]

[4:3]	Aspect ratio of a 4:3 monitor
[3:2]	Aspect ratio of a standard film camera
[16:9]	Aspect ratio of a 16:9 TV
[1:1]	Square aspect ratio
[65:24]	Panoramic aspect ratio
[2:1]	



- [16:9] and [1:1] aspect ratios are not available when using the following functions:
 - 6K photo
 - [Post-Focus] (when set to [6K 18M])
- [65:24] and [2:1] aspect ratios are not available when using the following functions:
 - [iA] mode
 - Taking burst pictures
 - [6K/4K PHOTO]/[Post-Focus]
 - [Time Lapse Shot]
 - [Stop Motion Animation]
 - [HLG Photo]
 - [High Resolution Mode]
 - [Filter Settings]
 - [Live View Composite]
 - [Multiple Exposure]
- When using APS-C lenses, [65:24] and [2:1] are not available.



- A frame for trimming (cropping) can be displayed on the recording screen:
[] ⇒ [] ⇒ [Frame Marker] (→ [268](#))

[Picture Size]

iA P A S M  S&Q



Sets the picture's image size. The image size varies depending on the [Aspect Ratio] or the lens used.

When an APS-C lens is used, the image area switches to the one for APS-C, thereby narrowing the angle of view.

 →  →  → Select [Picture Size]

[Aspect Ratio]	[Picture Size]			
	When using full-frame lenses		When using APS-C lenses	
[4:3]	[L] (21.5M)	5328×4000	[L] (9.5M)	3536×2656
	[M] (10.5M)	3792×2848	[M] (5M)	2560×1920
	[S] (5.5M)	2688×2016	[S] (2.5M)	1840×1376
[3:2]	[L] (24M)	6000×4000	[L] (10.5M)	3984×2656
	[M] (12M)	4272×2848	[M] (5.5M)	2880×1920
	[S] (6M)	3024×2016	[S] (3M)	2064×1376
[16:9]	[L] (20M)	6000×3368	[L] (9M)	3984×2240
	[M] (10M)	4272×2400	[M] (4.5M)	2880×1624
	[S] (5M)	3024×1704	[S] (2M)	1920×1080
[1:1]	[L] (16M)	4000×4000	[L] (7M)	2656×2656
	[M] (8M)	2848×2848	[M] (3.5M)	1920×1920
	[S] (4M)	2016×2016	[S] (2M)	1376×1376
[65:24]	[L] (13M)	6000×2208	—	
[2:1]	[L] (18M)	6000×3000	—	

- When [Ex. Tele Conv.] is set, the [M] and [S] image sizes are indicated with [EX].





- When the following functions are being used, [Picture Size] is not available:
 - [6K/4K PHOTO]/[Post-Focus]
 - [RAW] ([Picture Quality])
 - [High Resolution Mode]
 - [Multiple Exposure]

[Picture Quality]

iA P A S M  S&Q



Set the compression rate used for storing pictures.

 → [] → [] → Select [Picture Quality]

Setting	File format	Settings details
[FINE]	JPEG	JPEG images that give priority to image quality.
[STD.]		JPEG images of standard image quality. This is useful for increasing the number of recordable pictures without changing the picture size.
[RAW+FINE]	RAW+JPEG	This records RAW and JPEG images ([FINE] or [STD.]) simultaneously.
[RAW+STD.]		
[RAW]	RAW	This records RAW images.



Note on RAW

RAW format refers to a data format of images that have not been processed on the camera.

Playback and editing of RAW images require the camera or the dedicated software.

- You can process RAW images on the camera. (→ 312)
- Use software (“SILKYPIX Developer Studio” by Ichikawa Soft Laboratory) to process and edit RAW files on a PC. (→ 482)
- Pictures taken with [RAW] cannot be displayed enlarged to the maximum magnification during playback.
Take pictures with [RAW+FINE] or [RAW+STD.] if you want to check their focus on the camera after recording.





- RAW images are always recorded in the [L] size of the [3:2] aspect ratio.
- When you delete an image recorded with [RAW+FINE] or [RAW+STD.] on the camera, both the RAW and JPEG images will be deleted simultaneously.
- When the following functions are being used, [Picture Quality] is not available:
 - [6K/4K PHOTO]/[Post-Focus]
 - [High Resolution Mode]
 - [Multiple Exposure]

[Double Card Slot Function]

This sets the way recording to the card slots 1 and 2 is performed.

 → [] → [] → Select [Double Card Slot Function]

[Recording Method]	 [Relay Rec]	Selects the priority of card slots for recording. [Destination Card Slot]: [1 → 2]/[2 → 1] Relays recording to the card in the other card slot after the first card runs out of free space.
	 [Backup Rec]	Records the same images to both cards simultaneously.
	 [Allocation Rec]	Allows you to specify the card slot to be used for recording for different image formats. [JPEG/HLG Photo Destn.]/[RAW Destination]/[6K/4K Photo Destination]/[Video Destination]



Notes about Backup Recording

- We recommend using cards with the same Speed Class rating and capacity. If the card Speed Class or capacity is insufficient when video recording, recording to both cards stops.
- When using the following combinations of cards, backup recording for videos, 6K/4K photos, and [Post-Focus] are not available:
 - SD/SDHC memory card, and SDXC memory card

[Folder / File Settings]

Set the folder and file name where to save the images.

Folder name		File name	
100ABCDE 		PABC0001.JPG 	
1	Folder number (3 digits, 100 to 999)	3	Color space ([P]: sRGB, [_]: AdobeRGB)
2	5-character user-defined segment	4	3-character user-defined segment
		5	File number (4 digits, 0001 to 9999)
		6	Extension

⇒ [] ⇒ [[^]] ⇒ Select [Folder / File Settings]

[Select Folder]*	Selects a folder for storing images.	
[Create a New Folder]	Creates a new folder with an incremented folder number. <ul style="list-style-type: none"> If there are no recordable folders in the card, a screen for resetting the folder number is displayed. 	
	[OK]	Increments the folder number without changing the 5-character user-defined segment (2 above).
	[Change]	Changes the 5-character user-defined segment (2 above). This will also increment the folder number.
[File Name Setting]	[Folder Number Link]	Uses the 3-character user-defined segment (4 above) to set the folder number (1 above).
	[User Setting]	Changes the 3-character user-defined segment (4 above).

* When [Double Card Slot Function] is set to [Allocation Rec], [Select Folder (Slot 1)] and [Select Folder (Slot 2)] will be displayed.



- Follow the steps on page 415 when the character entry screen is displayed.
Available characters: alphabetic characters (upper-case), numerals, [_]



- Each folder can store up to 1000 files.
- File numbers are assigned sequentially from 0001 to 9999 in the order of recording.
If you change the storage folder, a number continuing on from the last file number will be assigned.
- In the following cases, a new folder with an incremented folder number will be created automatically when the next file is saved:
 - The number of files in the current folder reaches 1000.
 - The file number reaches 9999.
- New folders cannot be created when there are folders numbered from 100 all the way up to 999.
We recommend backing up your data and formatting the card.
- [Select Folder] is not available when [Backup Rec] in [Double Card Slot Function] is being used.

[File Number Reset]

Refresh the folder number to reset the file number to 0001.

 ⇒ [] ⇒ [] ⇒ Select [File Number Reset]
Settings: [Card Slot 1]/[Card Slot 2]



- When the folder number reaches 999, the file number cannot be reset. We recommend backing up your data and formatting the card.
- **To reset the folder number to 100:**
 - ① Perform [Card Format] to format the card. (→ 48)
 - ② Perform [File Number Reset] to reset the file number.
 - ③ Select [Yes] on the folder number reset screen.

5. Focus/Zoom

Smoother focusing is possible by selecting the focus mode and AF mode most suited to the recording conditions and the subject.

It is also possible to customize the AF tracking features with [AFC].

Select the focus mode.



[AFS]

→ 93

[AFC]

• [AF Custom Setting(Photo)] (→ 98)

[MF]

→ 120

Select the AF mode.



AFS

These focus on the subject the camera automatically selected.



AFC



AFS

These focus on the specified AF area.

→ 100



AFC



AFS



AFC

This keeps tracking and focusing on subject.

Move the position of the AF area.



Joystick

→ 115

Touch operation

→ 116

Touch pad

→ 118

Selecting the Focus Mode

iA P A S M  S&Q



Select the focusing method (focus mode) to match subject movement.

Set the focus mode lever.

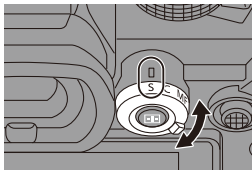

<p>[S] ([AFS])</p>	<p>This is suitable for recording still subjects. When the shutter button is pressed halfway, the camera focuses once. The focus stays locked while the shutter button is pressed halfway.</p>
<p>[C] ([AFC])</p>	<p>This is suitable for recording moving subjects. While the shutter button is pressed halfway, the focus is constantly adjusted according to the movement of the subject.</p> <ul style="list-style-type: none"> • This predicts the movement of the subject, maintaining focusing. (Movement prediction)
<p>[MF]</p>	<p>Manual focusing. Use this when you want to fix the focus or avoid activating AF. (→ 120)</p>



- In the following cases, [AFC] works the same as [AFS] when the shutter button is pressed halfway:
 - [M] mode
 - [S&Q] mode
 - In low light situations
- When the following functions are being used, [AFC] switches to [AFS]:
 - [65:24]/[2:1] ([Aspect Ratio])
 - [High Resolution Mode]
- This function is not available for Post-Focus recording.

Using AF

iA P A S M  S&Q



AF (Auto Focus) refers to automatic focusing.



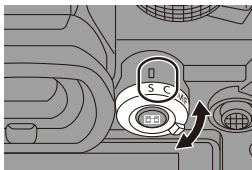

Select the focus mode and the AF mode appropriate for the subject and scene.

1 Set the focus mode to [S] or [C].



- Set the focus mode lever. (→ 93)



2 Select the AF mode.

- Press [] to display the AF mode selection screen, and set using  or . (→ 100)
- Selection is also possible by pressing [].



- In [iA] mode, each press of [] switches between [] and []. (→ 79)

3 Press the shutter button halfway.

- The AF operates.

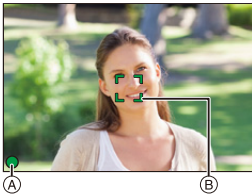

	Focus	
	In focus	Not in focus
Focus icon (A)	Lights	Blinking
AF area (B)	Green	Red
AF beep	Two beeps	—

Low illumination AF

- In dark environments, low illumination AF automatically operates, and the focus icon is indicated as [LOW].
- Achieving focus may take more time than usual.

Starlight AF

- If the camera detects stars in the night sky after determining low illumination AF, then Starlight AF will be activated.
When focus is achieved, the focus icon will display [STAR], and the AF area will be displayed on the area in focus.
- Edges of the screen cannot detect Starlight AF.

❖ [AF ON] button

You can also activate AF by pressing [AF ON].

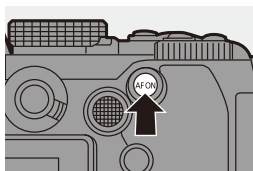

**Subjects and recording conditions that make focusing difficult with AF mode**



- Fast-moving subjects
- Extremely bright subjects
- Subjects without contrast
- Subjects recorded through windows
- Subjects near shiny objects
- Subjects in very dark locations
- When recording subjects both distant and near
- You can change the operation of AF-ON so that AF prioritizes subjects close by.

This function is useful when the camera mistakenly focuses on the background:

[] ⇒ [] ⇒ [Fn Button Set] ⇒ [Setting in REC mode] ⇒ [AF-ON : Near Shift] (→ 321)

- You can change the operation of AF-ON so that AF prioritizes subjects far away.

This function is useful when taking pictures through fences or nets:

[] ⇒ [] ⇒ [Fn Button Set] ⇒ [Setting in REC mode] ⇒ [AF-ON : Far Shift] (→ 321)



- When the following operations are performed while recording with [AFC], it may take some time for the camera to focus:
 - When zooming from the wide-angle end to the telephoto end
 - When the subject is suddenly changed from one far away to one close by
- If using the zoom after achieving focus, the focus may be erroneous. In that case, re-adjust the focus.



- When camera shake reduces, it is possible to focus automatically:

[] ⇒ [] ⇒ [Quick AF] (→ 376)

- You can change the settings so that AF does not function when the shutter button is pressed halfway:

[] ⇒ [] ⇒ [Half-Press Shutter] (→ 376)



- The AF beep volume and sound can be changed:

[] ⇒ [] ⇒ [Beep] ⇒ [AF Beep Volume]/[AF Beep Tone] (→ 399)

❖ Magnify the AF Area Position ([AF-Point Scope])



iA P A S M  S&Q





This magnifies the focus point when the AF mode is [, [, or []. (In other AF modes, the center of the screen is magnified.)

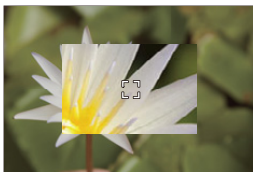

You can check focus and observe an enlarged subject as with a telephoto lens.

- 1 Register [AF-Point Scope] to the Fn button. (→ 321)
- 2 Enlarge the AF area position by pressing and holding the Fn button.

- When the screen is enlarged, pressing the shutter button halfway re-acquires focus in a small central AF area.
- When the screen is enlarged, turn  or  to adjust the magnification. Use  for more detailed adjustments.



-  • When the screen is enlarged, [AFC] changes to [AFS].
- When the following functions are being used, AF-Point Scope does not work:
 - [Post-Focus]
 - [6K/4K Pre-Burst]
 - [65:24]/[2:1] ([Aspect Ratio])
 - [Miniature Effect] ([Filter Settings])
 - [Multiple Exposure]
 - [Live Cropping]

-  • You can change the display method of the magnified screen:
[] → [] → [AF-Point Scope Setting] (→ 376)

[AF Custom Setting(Photo)]



Select features of AF operation when recording using [AFC] that are appropriate for the subject and scene.

Each of these features can be further customized.

1 Set the focus mode to [AFC]. (→ 93)

2 Set [AF Custom Setting(Photo)].

- → → → [AF Custom Setting(Photo)]

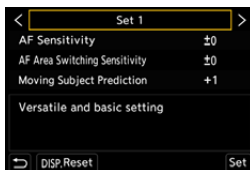



[Set 1]	Basic general-purpose setting.
[Set 2]	Suggested for situations where the subject moves at a constant speed in one direction.
[Set 3]	Suggested when the subject moves randomly, and other objects may be in the scene.
[Set 4]	Suggested for situations where the speed of the subject changes significantly.



- When the following function is being used, [AF Custom Setting(Photo)] is not available:
 - [6K/4K PHOTO]

❖ Adjusting AF Custom Settings

- 1 Press ◀▶ to select the AF Custom setting type.
- 2 Press ▲▼ to select items and press ◀▶ to adjust.
 - To reset settings to the default, press [DISP.].
- 3 Press  or .

[AF Sensitivity]	Sets the tracking sensitivity for the movement of subjects.	
	[+]	When the distance to the subject changes drastically, the camera re-adjusts the focus immediately. You can bring different subjects into focus one after another.
	[-]	When the distance to the subject changes drastically, the camera waits for a short period of time before re-adjusting the focus. This allows you to prevent the focus from being accidentally re-adjusted when, for example, an object moves across the image.
[AF Area Switching Sensitivity]	Sets the sensitivity for switching the AF area to match subject movement. (When in an AF mode where the AF area uses 225-area focusing)	
	[+]	When the subject moves out of the AF area, the camera immediately switches the AF area to keep the subject in focus.
	[-]	The camera switches the AF area at a gradual pace. Effects caused by a slight movement of the subject or by obstacles in front of the camera will be minimized.
[Moving Subject Prediction]	Sets the level of movement prediction for changes in the speed of subject movement. <ul style="list-style-type: none"> • At larger setting values, the camera tries to maintain focus by responding even to sudden movements of the subject. However, the camera becomes more sensitive to slight movements of the subject, so focusing may become unstable. 	
	[0]	This is suited to a subject with minimal changes in speed.
	[+1]	These are suited to a subject that changes its speed.
	[+2]	

Selecting the AF Mode

iA P A S M  S&Q





Select the focusing method to match the position and number of subjects.

1 Press [].

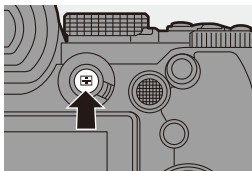











- The AF mode selection screen appears.



2 Select the AF mode.





- Press ◀▶ to select an item and then press  or .
- Selection is also possible by pressing [].



	[Face/Eye/Body/ Animal Detect.]	→ 102
	[Tracking]	→ 105
	[225-Area]	→ 107
	[Zone (Vert./ Horz.)]	→ 108
	[Zone (Square)]*	→ 108
	[Zone (Oval)]	→ 108
	[1-Area+]	→ 110
	[1-Area]	→ 110
	[Pinpoint]	→ 111
	[Custom1]*,	
	[Custom2]*,	→ 113
	[Custom3]*	

* This is not displayed with the default settings. From [Show/Hide AF Mode] in the [Custom] ([Focus/Shutter]) menu, you can set the items to display on the selection screen. (→ 375)



- When the following functions are being used, [] is not available:
 - [Time Lapse Shot]
 - [Live View Composite]
- When the focus mode is set to [AFC], [] is not available.
- When the following function is being used, the AF mode is fixed to [] (face detection):
 - [Live Cropping]
- When the following functions are being used, the AF mode is fixed to []:
 - [65:24]/[2:1] ([Aspect Ratio])
 - [Miniature Effect] ([Filter Settings])
- The AF mode cannot be set when using Post-Focus.

[Face/Eye/Body/Animal Detect.]

The camera detects a person's face, eyes, and body (entire body or upper half of the body) and adjusts the focus.

When animal detection is enabled, animals, such as birds, canines (including wolves), and felines (including lions) will also be detected.

When the camera detects a person's face (A)/(B) or body or an animal's body (C), an AF area is displayed.

Yellow	AF area to be brought into focus. The camera selects this automatically.
White	Displayed when multiple subjects are detected.

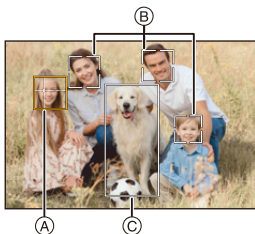



- Eye detection works only for the eyes inside the yellow frame (A).



- When a person's eyes are detected, the eye closer to the camera will be brought into focus.
The exposure will be adjusted to the face. (When [Metering Mode] is set to [☉])
- The camera can detect the faces of up to 15 people.
- The camera can detect a combined total of up to 3 human and animal bodies.
- If any humans or animals are not detected, the camera operates as [📏].

❖ Enable/Disable Animal Detection



- ❶ Press [] to display the AF mode selection screen.
- ❷ Select [] and then press **▲**.
 - This enables animal detection, and the icon changes to [].
 - Press **▲** again to disable animal detection.

❖ Specify the Person, Animal, or Eye to Bring into Focus

When the person or animal to be brought into focus is shown using the white AF area, you can change this to a yellow AF area.

● Touch operation

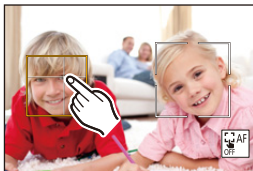

Touch the person, animal or eye indicated with the white AF area.

- The AF area will change to yellow.
- Touching outside the AF area displays the AF area setting screen. Touch [Set] to set the [] AF area at the position touched.
- To cancel the setting, touch [].



● Button operation









Press .

- Each press of  switches the person, animal or eye to be brought into focus.
- To cancel the settings specified, press .

❖ Move and Change the Size of the Yellow AF Area



You can move the yellow AF area to the position of the white AF area and replace the white AF area with the yellow AF area.

If moving to a position outside an AF area, then the [■] AF area will be set.

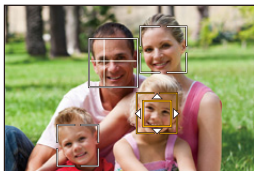
- 1 Press [] to display the AF mode selection screen.
- 2 Select [] or [] and then press ▼.
- 3 Press ▲▼◀▶ to move the position of the AF area.
- 4 Rotate  ,  or  to change the size of the AF area.
- 5 Press  .
 - On the recording screen, press  , or touch [] to cancel the AF area setting.



Operations on the AF area movement screen

Button operation	Touch operation	Description of operation
▲▼◀▶	Touch	Moves the AF area.
	Pinch out/ pinch in	Enlarges/reduces the AF area in small steps.
 / 	—	Enlarges/reduces the AF area.
[DISP.]	[Reset]	First time: Returns the AF area position to the center. Second time: Returns the AF area size to the default setting.



[Tracking]

When the focus mode is set to [AFC], the AF area follows the movement of the subject, maintaining focusing.



Start tracking.

- Aim the AF area over the subject, and press the shutter button halfway. The camera will track the subject while the shutter button is pressed halfway or pressed fully.
- If tracking fails, the AF area blinks red.
- When set to [AFS], the focus will be on the AF area position. Tracking will not work.





- In [pM]/[S&Q] mode, while recording video, and while recording with [6K/4K Burst(S/S)], tracking will continue even if the shutter button is released. To cancel tracking, press  or , or touch . Tracking is also available with [AFS].



- Set [Metering Mode] to  to continue to adjust the exposure as well.
- In the following,  operates as :
 - [Monochrome]/[L.Monochrome]/[L.Monochrome D]/[Monochrome(HLG)] ([Photo Style])
 - [Sepia]/[Monochrome]/[Dynamic Monochrome]/[Rough Monochrome]/[Silky Monochrome]/[Soft Focus]/[Star Filter]/[Sunshine] ([Filter Settings])

❖ Move the Position of the AF Area

- 1 Press [] to display the AF mode selection screen.
- 2 Select [] and then press ▼.
- 3 Press ▲▼◀▶ to move the position of the AF area.
 - You can also move the AF area by touching.
 - To return the position back to the center, press [DISP].
- 4 Press  .

[225-Area]

The camera selects the most optimal AF area to focus from 225 areas.





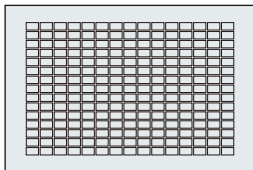



When multiple AF areas are selected, all selected AF areas will be brought into focus.

When the focus mode is set to [AFC], ensuring that the subject stays within the 225 areas during recording will ensure the subject stays in focus.



❖ Specify the [AFC] Start Point

When the focus mode is set to [AFC], you can specify at which area to start [AFC].

- ❶ Set the focus mode to [AFC]. (→ 93)
- ❷ Set [AFC Start Point (225-Area)] to [ON].
 -  ⇒  ⇒ [] ⇒ [AFC Start Point (225-Area)] ⇒ [ON]
- ❸ Press [] to display the AF mode selection screen.
- ❹ Select [] and then press ▼.
 - After performing Steps ❶ and ❷, the icon changes from [] to [].
- ❺ Press ▲▼◀▶ to move the AF area to the start point.
 - You can also move the AF area by touching.
 - To return the position back to the center, press [DISP].
- ❻ Press .

 [Zone (Vert./ Horz.)]/  [Zone (Square)]/  [Zone (Oval)]

 [Zone (Vert./ Horz.)]

Within the 225 AF areas, vertical and horizontal zones can be focused.

Horizontal pattern

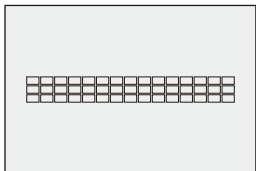

Vertical pattern

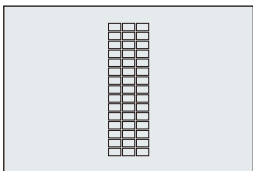

 [Zone (Square)]

Within the 225 AF areas, a central square zone can be focused.

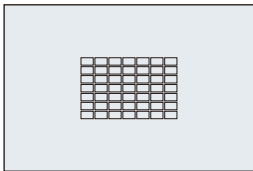





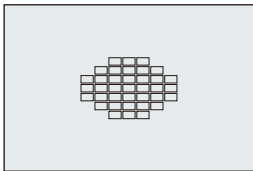



 [Zone (Oval)]

Within the 225 AF areas, a central oval zone can be focused.





-  is not displayed with default settings. Set [Zone (Square)] to [ON] in [Show/Hide AF Mode] in the [Custom] ([Focus/Shutter]) menu. (→ 375)

❖ Move and Change the Size of the AF Area

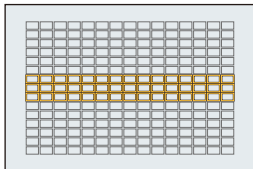
- 1 Press [] to display the AF mode selection screen.
- 2 Select [], [] or [] and then press ▼.
- 3 Press ▲▼◀▶ to move the position of the AF area.
 - You can also move the AF area by touching.
 - When [] is selected
 - Press ▲▼ to switch to a horizontal pattern AF area.
 - Press ▶▶ to switch to a vertical pattern AF area.
- 4 Rotate  ,  or  to change the size of the AF area.
 - You can also pinch out/pinch in the AF area to change the size.
 - The first press of [DISP.] returns the AF area position to the center. The second press returns the size of the AF area to the default.
- 5 Press .



- ➔ • The display method for the AF area using 225-area focusing can be changed:
 [] ➔ [] ➔ [AF Area Display] (➔ 385)

[1-Area+]/ [1-Area]

[1-Area+]

Emphasis within a single AF area can be focused.

Even when the subject moves out of the single AF area, the subject remains focused in a supplementary AF area (A).

- Effective when recording moving subjects that are difficult to track with [].

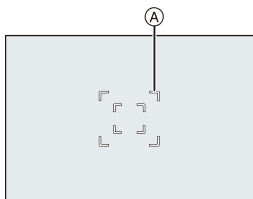





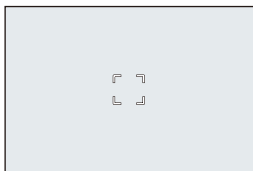

[1-Area]

Specify the point to be brought into focus.



❖ Move and Change the Size of the AF Area

- 1 Press [] to display the AF mode selection screen.
- 2 Select [] or [] and then press ▼.
- 3 Press ▲▼◀▶ to move the position of the AF area.
- 4 Rotate ,  or  to change the size of the AF area.
- 5 Press .

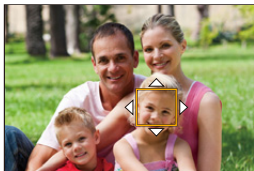

- Refer to “Operations on the AF area movement screen” on page 104 for information about detailed operations to move the AF area.

- Change the movement speed of a single AF area:

[] → [] → [1-Area AF Moving Speed] (→ 356)

[Pinpoint]





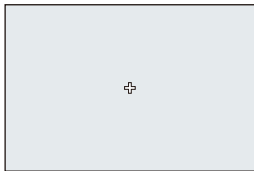



You can achieve a more precise focus on a small point.

If you press the shutter button halfway, the screen that lets you check the focus will be enlarged.





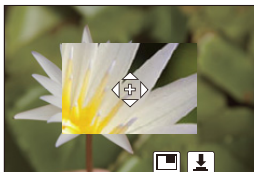

- When the focus mode is set to [AFC], [] is not available.

❖ Move the Position of the AF Area



- 1 Press [] to display the AF mode selection screen.
- 2 Select [] and then press ▼.
- 3 Press ▲▼◀▶ to set the position of [] and then press  or  .
 - The selected position on the screen will be enlarged.
 - The AF area cannot be moved to the edge of the screen.
- 4 Press ▲▼◀▶ to fine-adjust the position of [].
- 5 Press  or  .



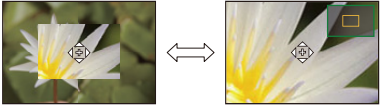

Operations on the Magnification Window

Button operation	Touch operation	Description of operation
▲▼◀▶	Touch	Moves [].
	Pinch out/ pinch in	Enlarges/reduces the screen in small steps.
	—	Enlarges/reduces the screen.
		Switches magnification window (windowed mode/full screen mode). 
[DISP.]	[Reset]	First time: Returns to the screen in Step ❸. Second time: Returns the AF area position to the center.



- When the picture is displayed in windowed mode, you can enlarge the picture by approx. 3× to 6×; when the picture is displayed in full screen, you can enlarge the picture by approx. 3× to 10×.
- You can also take a picture by touching [].

 • When the following functions are being used, [] switches to []:
– Video recording/[6K/4K PHOTO]

 • You can change the display method of the magnified screen:
[] → [] → [Pinpoint AF Setting] (→ 375)

[Custom1] to [Custom3]





The shape of the AF area can be set freely in the 225 AF areas.

The set AF area can be registered using [] to [].

The AF area can also be moved while maintaining the set shape.

 • This is not displayed with default settings. In [Show/Hide AF Mode] in the [Custom] ([Focus/Shutter]) menu, set [Custom1] to [Custom3] to [ON].
(→ 375)

Register the AF Area Shape

- 1 Press [] to display the AF mode selection screen.
- 2 Select one of [] to [] and then press .



3 Select the AF area.



● Touch operation

Touch the area to make the AF area.

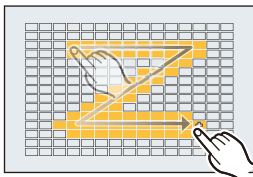

- To select consecutive points, drag the screen.
- To cancel selection of the selected AF area, touch it again.



● Button operation

Press ▲▼◀▶ to select the AF area and then set with  or .

(Repeat this)

- To cancel selection of the selected AF area, press  or  again.
- To cancel all selections, press [DISP.].

4 Press [Q].

❖ Move the Position of the AF Area

1 Press [] to display the AF mode selection screen.

2 Select a registered AF mode shape ([C1] to [C3]) and then press ▼.

3 Press ▲▼◀▶ to move the position of the AF area and then press



- Press [DISP.] to return the [+] position to the center.

AF Area Movement Operation

iA P A S M  S&Q





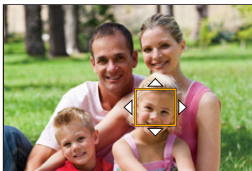
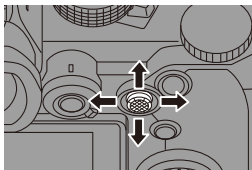

In default settings, you can use the joystick to directly move and change the size of the AF area when recording.

1 Move the position of the AF area.





- On the recording screen, tilt the joystick.

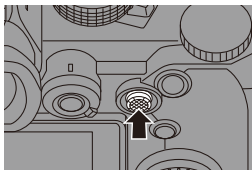

- Pressing  enables switching between the default and set AF area positions.
In []/[], this operation switches the person, animal or eye to be brought into focus.
In [], this operation displays the enlarged screen.



2 Change the size of the AF area.

- Rotate ,  or .
- Use  for more detailed adjustments.
- The first press of [DISP.] returns the AF area position to the center. The second press returns the size of the AF area to the default.

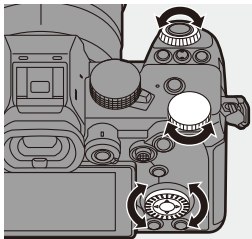

3 Confirm your selection.

- Press the shutter button halfway.
- This will return you to the recording screen.

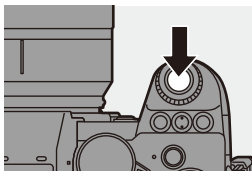

- When [Metering Mode] is [], the metering target also moves together with the AF area.
- In [], [], [], and [] to [], the size of the AF area cannot be changed.
- In [], it is not possible to move the AF area or change its size.
- In the [iA] mode, the []/[] AF area cannot be moved.



- You can set the AF area to loop when moved:
[] → [] → [Looped Focus Frame] (→ 377)

Moving the AF Area by Touch

You can move the AF area to a touched position on the monitor.
You can also change the size of the AF area.

[MENU/SET] → [] → [] → [Touch Settings] →
Select [Touch AF]

[AF]	This focuses on the touched subject.
[AF+AE]	This focuses on and adjusts brightness for the touched subject.

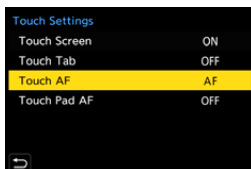

- The default setting is [AF].

❖ Focus on the Touched Position ([AF])

- 1 Touch the subject.
 - The AF area moves to the touched position.
- 2 Pinch out/pinch in to change the AF area size.
 - The first touch of [Reset] returns the AF area position to the center. The second touch returns the size of the AF area to the default.
- 3 Touch [Set].
 - In [+], touch [Exit].
 - For [AF] / [AF], the AF area setting is canceled if you touch [AF OFF] on the recording screen.

❖ Focus on and Adjust Brightness for the Touched Position ([AF+AE])

- 1 Touch the subject to which you wish to adjust the brightness.
 - At the touched position, an AF area that works in the same way as [AF] is displayed. This places a point to adjust brightness at the center of the AF area.
- 2 Pinch out/pinch in to change the AF area size.
 - The first touch of [Reset] returns the AF area position to the center. The second touch returns the size of the AF area to the default.
- 3 Touch [Set].
 - The [AF+AE] area setting is canceled if you touch [AF OFF AE] (when [AF] or [AF] is set: [AF OFF AE]) on the recording screen.

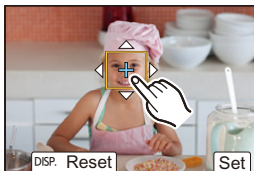

Moving the AF Area Position with the Touch Pad

During viewfinder display, you can touch the monitor to change the position and size of the AF area.

1 Set [Touch Pad AF].

-  →  →  → [Touch Settings] → [Touch Pad AF] → [EXACT]/[OFFSET1] to [OFFSET7]

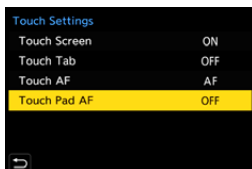



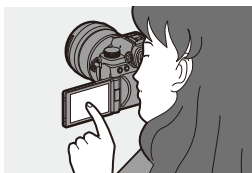

2 Move the position of the AF area.

- During viewfinder display, touch the monitor.



3 Change the size of the AF area.

- Rotate ,  or .
- Use  for more detailed adjustments.
- The first press of [DISP.] returns the AF area position to the center. The second press returns the size of the AF area to the default.

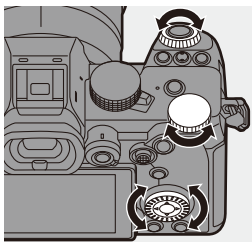

4 Confirm your selection.

- Press the shutter button halfway.

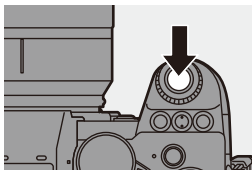

❖ Setting Items ([Touch Pad AF])

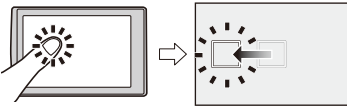
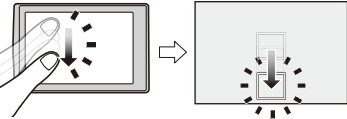
[EXACT]	<p>Moves the AF area of the viewfinder by touching a desired position on the touch pad.</p>	
[OFFSET1] to [OFFSET7]	<p>Moves the AF area of the viewfinder according to the distance you drag your finger on the touch pad.</p> <p>Select the range to be detected with the drag operation. [OFFSET1] (entire area)/[OFFSET2] (right half)/[OFFSET3] (upper right)/[OFFSET4] (lower right)/[OFFSET5] (left half)/[OFFSET6] (upper left)/[OFFSET7] (lower left)</p>	
[OFF]	—	—

[Focus Switching for Vert / Hor]

Memorizes separate positions for AF areas for when the camera is vertically aligned and for when it is horizontally aligned.

Two vertical orientations, left and right, are available.



[MENU/SET] → **[Settings]** → **[AF]** → Select [Focus Switching for Vert / Hor]

[ON]	Memorizes separate positions for vertical and horizontal orientations.
[OFF]	Sets the same position for vertical and horizontal orientations.



- In MF, this memorizes the MF Assist position.
- This does not work in the **[Grid]** and **[C1]** to **[C3]** AF modes.

Record Using MF

iA P A S M  S&Q



MF (Manual Focus) refers to manual focusing.

Use this function when you want to fix the focus or when the distance between the lens and the subject is determined and you do not want to activate AF.

1 Set the focus mode lever to [MF].

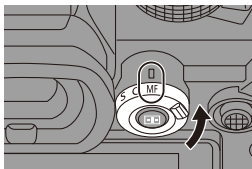

2 Select the focus point.

- Tilt the joystick to select the focus point.
- To return the point to be brought into focus to the center, press [DISP.].

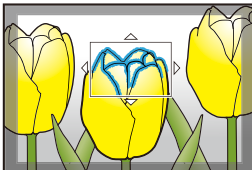
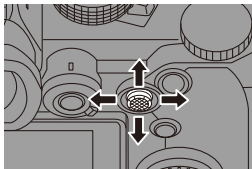

3 Confirm your selection.

- Press .
- This switches to the MF Assist screen, and shows an enlarged display.

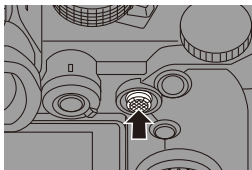

4 Adjust the focus.

- Rotate the focus ring.
- Ⓐ MF Assist (enlarged screen)
 - This will display the in-focus portion highlighted with color. (Focus Peaking Ⓑ)
 - A recording distance guideline is displayed. (MF Guide Ⓒ)
- Ⓓ Indicator for ∞ (infinity)

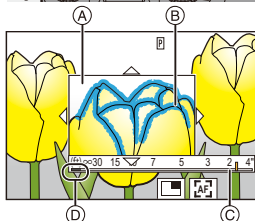
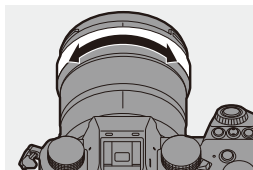

5 Close the MF Assist screen.





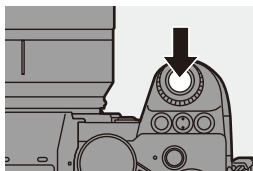

- Press the shutter button halfway.
- This operation can also be performed by pressing .

6 Start recording.

- Press the shutter button fully.

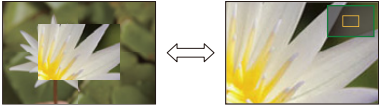

❖ Operations on the MF Assist Screen









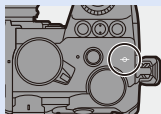







Button operation	Touch operation	Description of operation
▲▼◀▶	Drag	Moves the enlarged display position.
	Pinch out/ pinch in	Enlarges/reduces the screen in small steps.
	—	Enlarges/reduces the screen.
		Switches magnification window (windowed mode/full screen mode). 
[DISP.]	[Reset]	First time: Returns the MF Assist position to the center. Second time: Returns the MF Assist magnification to the default setting.
[AF ON]		The AF operates.

- When the picture is displayed in windowed mode, you can enlarge the picture by approx. 3× to 6×; when the picture is displayed in full screen, you can enlarge the picture by approx. 3× to 20×.



- On the recording screen, you can rotate the focus ring to display the MF Assist screen. If the focus ring has been rotated to enlarge the display, the assist screen will be exited a short time after you cease the operation.
- You can also display the MF Assist screen by pressing the [].
- During MF, pressing [AF ON] will activate AF.
- The recording distance reference mark indicates the position of the imaging surface. This becomes the reference when measuring the recording distance.



- You can change the Focus Peaking sensitivity and the display method:
[] ⇒ [] ⇒ [Focus Peaking] (→ 356)
- You can memorize the MF Assist position separately for vertical and horizontal orientations:
[] ⇒ [] ⇒ [Focus Switching for Vert / Hor] (→ 119)
- You can change the display method of the magnified screen:
[] ⇒ [] ⇒ [MF Assist] (→ 374)
- You can change the MF Guide display units:
[] ⇒ [] ⇒ [MF Guide] (→ 374)
- You can disable focus ring operation:
[] ⇒ [] ⇒ [Focus Ring Lock] (→ 374)
- You can set the movement of the MF Assist position to loop:
[] ⇒ [] ⇒ [Looped Focus Frame] (→ 377)
- The camera memorizes the focus point when you turn it off:
[] ⇒ [] ⇒ [Lens Focus Resume] (→ 394)
- The amount of focus movement can be set:
[] ⇒ [] ⇒ [Focus Ring Control] (→ 394)

Recording with Zoom

iA P A S M S&Q



Use the optical zoom of the lens to zoom to telephoto or wide-angle. When taking pictures, use [Ex. Tele Conv.] to increase a telescopic effect without image deterioration.

When recording videos, use [Image Area of Video] to obtain the same telescopic effect as [Ex. Tele Conv.].



- For details about [Image Area of Video], refer to page [249](#).

Rotate the zoom ring.

- T**: Telephoto
- W**: Wide-angle

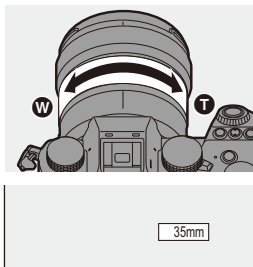
- Rotating the zoom ring displays the focal length on the recording screen.



- The focal length display can be hidden:
[] → [] → [Focal Length] (→ [388](#))

Extended Tele Conversion



[Ex. Tele Conv.] enables you to take pictures that are further enlarged beyond what is available with the optical zoom, without any deterioration in image quality.

- The [Ex. Tele Conv.] maximum magnification ratio differs depending on the [Picture Size] set in the [Photo] ([Image Quality]) menu.
 - Set to [EXM]: 1.4×
 - Set to [EXS]: 2.0× (1.9× when using APS-C lenses)

1 Set [Picture Size] to [M] or [S].

- → [📷] → [🔍] → [Picture Size] → [M]/[S]



2 Set [Ex. Tele Conv.].

- → [📷] → [🔍] → [Ex. Tele Conv.]

[ZOOM]	Changes the zoom magnification.
[TELE CONV.]	Fixes the zoom magnification at the maximum.
[OFF]	—

❖ Changing the Zoom Magnification





Button operation

- 1 Set [Ex. Tele Conv.] to [ZOOM].
 -  ⇒ [] ⇒ [] ⇒ [Ex. Tele Conv.] ⇒ [ZOOM]
 - 2 Set the Fn button to [Zoom Control]. (→ 321)
 - 3 Press the Fn button.
 - 4 Press the cursor buttons to operate the zoom.
 - ▲▶: T (telephoto)
 - ◀▼: W (wide-angle)
 - Press the Fn button again, or wait a specified time to end zoom operation.
- (A) Zoom magnification



Touch operation

- With the default settings, the Touch Tab is not displayed. Set [Touch Tab] to [ON] in [Touch Settings] in the [Custom] ([Operation]) menu. (→ 377)

- 1 Set [Ex. Tele Conv.] to [ZOOM].
 -  ⇒ [] ⇒ [] ⇒ [Ex. Tele Conv.] ⇒ [ZOOM]
- 2 Touch [].
- 3 Touch [].



- 4 Drag the slide bar to operate the zoom.

- T: Telephoto
- W: Wide-angle

- To end Touch Zoom operations, touch [T/W] again.



- When displaying the [Ex. Tele Conv.] setting screen using the Fn button, pressing [DISP.] allows you to change the [Picture Size] setting.
- When the following functions are being used, [Ex. Tele Conv.] is not available:
 - [6K/4K PHOTO]
 - [65:24]/[2:1] ([Aspect Ratio])
 - [RAW] ([Picture Quality])
 - [HLG Photo]
 - [High Resolution Mode]
 - [Toy Effect]/[Toy Pop] ([Filter Settings])
 - [Post-Focus]
 - [Multiple Exposure]

6. Drive/Shutter/Image Stabilizer

Selecting the Drive Mode



You can switch the drive mode to Single, Burst, etc. to match the recording conditions.

Rotating the drive mode dial.

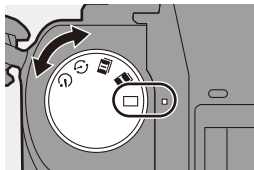

[□]	Single	Takes one picture each time the shutter button is pressed.
[I]/[II]	Burst (→ 129, 133)	Takes pictures continuously while the shutter button is pressed and held. 6K/4K photo recording is also possible.
[⌚]	Time Lapse Shot/ Stop Motion Animation (→ 145, 149)	Takes pictures with Time Lapse Shot or Stop Motion Animation.
[⌚]	Self-timer (→ 154)	Takes pictures when the set time elapses after the shutter button is pressed.

➔ • The detailed setting screens for each drive mode can be called up with an Fn button:

[⚙] → [🌅] → [Fn Button Set] → [Setting in REC mode] → [Drive Mode]

Taking Burst Pictures

iA P A S M S&Q



Takes pictures continuously while the shutter button is pressed and held. You can choose a burst setting which enables burst recording in high image quality, [H], [M] or [L], or one which enables high-speed burst recording, [] (6K/4K photo), to suit the recording conditions.

1 Set the drive mode dial to [] (Burst Shot 1) or [] (Burst Shot 2).

- Configure the burst settings for each of [] and [].

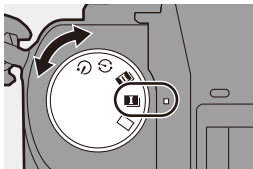

2 Select the burst rate.

- → [] → [] → [Burst Shot 1 Setting]/[Burst Shot 2 Setting]
- With the default settings, [H] is set for [] and [] is set for [].



	For information about 6K/4K photo recording, refer to “6K/4K Photo Recording”. (→ 133)
[H]	Takes high-speed burst pictures.
[M]	Takes medium-speed burst pictures.
[L]	Takes low-speed burst pictures.

3 Close the menu.

- Press the shutter button halfway.

4 Start recording.

- Takes burst pictures while the shutter button is pressed fully.

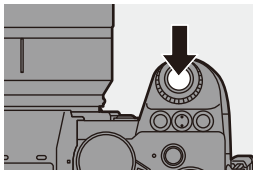

❖ Burst Rate

	Mechanical shutter, electronic front curtain	Electronic shutter	Live View when taking burst pictures
[H] (High speed)	7 frames/second ([AFS]/[MF]) 5 frames/second ([AFC])	7 frames/second ([AFS]/[MF]) 5 frames/second ([AFC])	None ([AFS]/[MF]) Available ([AFC])
[M] (Medium speed)	5 frames/second	5 frames/second	Available
[L] (Low speed)	2 frames/second	2 frames/second	Available

- The burst rate may be lower depending on the settings for recording such as [Picture Size] and focus mode.

❖ Maximum Number of Frames Recordable

	[Picture Quality]	
	[FINE]/[STD.]	[RAW + FINE]/[RAW + STD.]/[RAW]
[H] (High speed)	999 frames or more	24 frames or more
[M] (Medium speed)		
[L] (Low speed)		

- When recording under the test conditions specified by Panasonic. (Using a card in card slot 1 compatible with UHS-II)
Recording conditions may reduce the maximum number of frames recordable.
- The burst rate will become lower during recording but pictures can continue to be taken until the card becomes full.

❖ Number of Pictures That Can Be Taken Continuously

When you press the shutter button halfway, the number of pictures that can be taken continuously will appear on the recording screen.



Example) When 20 frames: [r20]

- Once recording starts, the number of pictures that can be taken continuously will decrease.
When [r0] appears, the burst rate decreases.
- When [r99+] is displayed on the recording screen, you can take 100 or more burst pictures.

❖ Focus when Taking Burst Pictures

Focus mode	[Focus/Shutter Priority] (→ 373)	[H]	[M]/[L]
[AFS]	[FOCUS]	Fixed to the focus of the first frame	
	[BALANCE]		
	[RELEASE]		
[AFC]	[FOCUS]	Estimated focus	Normal focus
	[BALANCE]	Estimated focus	
	[RELEASE]		
[MF]	—	Focus set with manual focus	

- When the subject is dark with [AFC], the focus is fixed to that of the first frame.
- With estimated focus, the burst rate takes priority and the focus is estimated to the extent possible.
- With normal focus, the burst rate may become slow.

❖ Exposure when Taking Burst Pictures

Focus mode	[H]	[M]/[L]
[AFS]	Fixed to the exposure of the first frame	The exposure is adjusted for each frame
[AFC]	The exposure is adjusted for each frame	
[MF]	Fixed to the exposure of the first frame	



- It may take a while to save burst pictures.
If you continue to take burst pictures while saving is in progress, the maximum number of frames recordable will be reduced.
When taking burst pictures, we recommend using a high-speed card.
- Taking burst pictures does not work while you are using the following functions:
 - [High Resolution Mode]
 - [Rough Monochrome]/[Silky Monochrome]/[Miniature Effect]/[Soft Focus]/[Star Filter]/[Sunshine] ([Filter Settings])
 - [Live View Composite]
 - [Post-Focus]
 - [Multiple Exposure]

6K/4K Photo Recording

iA P A S M  S&Q



With 6K Photo, you can take high-speed burst pictures at 30 frames/second and save the desired pictures, each made up of approx. 18 million pixels, extracted from their burst file.

With 4K photo, you can take high-speed burst pictures at 60 frames/second and save the desired pictures, each made up of approx. 8 million pixels.

- “6K PHOTO” is a high-speed burst picture function to extract and save the desired pictures from images with an aspect ratio for pictures of 4:3 or 3:2 and an effective picture size equivalent to the number of pixels (approx. 18 megapixels) for images of 6K size (around 6,000 wide×3,000 high).





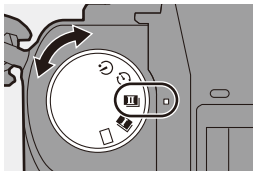

- Use a UHS Speed Class 3 or higher card when recording.
- The angle of view becomes narrower (when using a full-frame lens).

1 Set the drive mode dial to [I₁] (Burst Shot 1) or [I₂] (Burst Shot 2).

- Configure the burst settings for each of [I₁] and [I₂].



2 Select [6K/4K PHOTO].

-  ⇒  ⇒  ⇒ [Burst Shot 1 Setting]/[Burst Shot 2 Setting] ⇒ 
- With the default settings,  is set for [I₂].

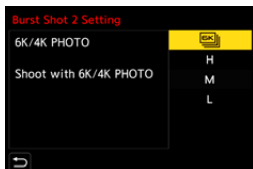

3 Select [Picture Size / Burst Speed].

-  →  →  → [6K/4K PHOTO] → [Picture Size / Burst Speed]

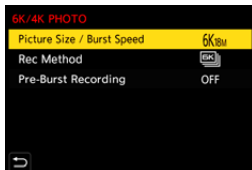

	Picture size	Burst rate	[Rec Quality]*
[6K 18M]	[4:3]: 4992×3744 [3:2]: 5184×3456	30 frames/ second	[6K/200M/30p]
[4K H 8M]	[4:3]: 3328×2496 [3:2]: 3504×2336	60 frames/ second	[4K/150M/60p]
[4K 8M]	[16:9]: 3840×2160 [1:1]: 2880×2880	30 frames/ second	[4K/100M/30p]

* Saved as 6K/4K burst files whose [Rec. File Format] is [MP4].

4 Select [Rec Method].

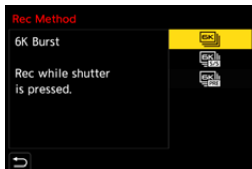



  
([6K/4K Burst])

When you wish to capture the best moments of a fast-moving subject

Takes burst pictures while the shutter button is pressed.

Audio recording: None

 <p>([6K/4K Burst(S/S)])</p> <p>"S/S" is an abbreviation for start/stop.</p>	<p>When you wish to capture an unpredictable photo opportunity</p> <p>Starts taking burst pictures when the shutter button is pressed. Pressing the button again stops taking burst pictures.</p> <p>The start tone and stop tone are output.</p> <p style="text-align: center;">Audio recording: Available*</p>			
 <p>([6K/4K Pre-Burst])</p>	<p>When you wish to capture at the moment of a photo opportunity</p> <p>Takes burst pictures for approx. 1 second before and after the moment the shutter button is pressed. The shutter sound is output once only.</p> <table border="1" data-bbox="406 594 970 666"> <tr> <td data-bbox="406 594 692 666">Recording duration: Approx. 2 seconds</td> <td data-bbox="692 594 970 666">Audio recording: None</td> </tr> </table>		Recording duration: Approx. 2 seconds	Audio recording: None
Recording duration: Approx. 2 seconds	Audio recording: None			

* Audio is not played back during playback with the camera.

5 Close the menu.

- Press the shutter button halfway.

6 Start recording.

- [Continuous AF] works and the focus is adjusted continuously during recording with AF.

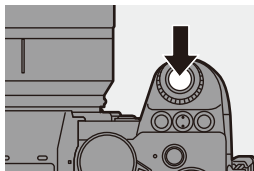

[6K/4K Burst]

- 1 Press the shutter button halfway.
- 2 Press the shutter button fully and keep it pressed during recording.

- (A) Press and hold
(B) Recording is performed

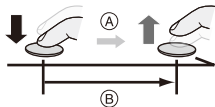

- Press the shutter button fully early because recording will take approx. 0.5 second to start after it is pressed fully.

[6K/4K Burst(S/S)]

- 1 Press the shutter button fully to start recording.
- 2 Press the shutter button fully again to stop recording.

- Ⓒ Start (First)
- Ⓓ Stop (Second)
- Ⓔ Recording is performed

- You can add markers by pressing [Q] during recording. (Up to 40 markers per recording)

This allows you to skip to the positions where you added markers when selecting pictures from a 6K/4K burst file.

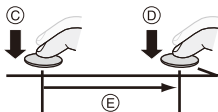
**[6K/4K Pre-Burst]**

Press the shutter button fully.

- Ⓕ Approx. 1 second
- Ⓖ Recording is performed

- While the recording screen is displayed, the AF will operate constantly to continue focusing.

The exposure is also adjusted continuously, except in [M] mode.

- When the subject is not at the center, use AF/AE Lock if you wish to lock the focus and exposure. (→ 198)

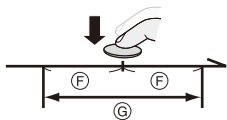



- In default settings, Auto Review operates, and a screen that lets you select pictures from a burst file will be displayed.

To continue recording, press the shutter button halfway to return to the recording screen.

For how to select and save pictures from a recorded 6K/4K burst file, refer to page 139.

❖ [Pre-Burst Recording] ([6K/4K Burst]/[6K/4K Burst(S/S)])

The camera starts recording approx. 1 second before the shutter button is pressed fully, so you will not miss a photo opportunity.

 ⇒ [] ⇒ [] ⇒ [6K/4K PHOTO] ⇒ Select [Pre-Burst Recording]
Settings: [ON]/[OFF]

- When [Pre-Burst Recording] is being used, [PRE] is displayed on the recording screen.
- The AF behavior and functionality restrictions when using [Pre-Burst Recording] are the same as for [6K/4K Pre-Burst].



- Setting ranges become the following with 6K/4K photo recording:
 - Shutter speed: 1/30 (1/60 when [4K H 8M] is set) to 1/8000
 - [Min. Shutter Speed]: [1/500] to [1/30] ([1/60] when [4K H 8M] is set)
 - Exposure compensation: ± 3 EV
- Recording stops when the continuous recording time exceeds 15 minutes.
- The file save method differs depending on the type of card.
 - SDHC memory card:
A new file will be created to continue recording if the file size exceeds 4 GB.
 - SDXC memory card:
Files are not divided for recording.
- If the temperature of the camera rises, [] may be displayed, recording may stop, and some functions may become unavailable temporarily. Wait until the camera cools down.
- When [6K/4K Pre-Burst] or [Pre-Burst Recording] is set, the battery drains faster and the camera temperature rises. Set these settings only when recording.
- For 6K/4K photo, the menu items below are fixed to the following settings:
 - [Shutter Type]: [ELEC.]
 - [Picture Quality]: [FINE]





- With 6K/4K photo recording, the following functions are not available:
 - Flash
 - [Bracketing]
 - Program Shift
 - AF mode ([+])
 - [MF Assist] ([6K/4K Pre-Burst] only)
- When you record in an extremely bright location or under lighting such as fluorescent or LED lighting, the coloring or brightness of the image may change or horizontal stripes may appear on the screen. Lowering the shutter speed may reduce the effect of horizontal stripes.
- The following functions are restricted when recording 6K/4K photos when connected to an external device (TV, etc.) via HDMI:
 - HDMI output is not possible during recording.
 - [6K/4K Pre-Burst] changes to [6K/4K Burst].
 - [Pre-Burst Recording] is not available.
- 6K/4K photo recording does not work while you are using the following functions:
 - [High Resolution Mode]
 - [Rough Monochrome]/[Silky Monochrome]/[Miniature Effect]/[Soft Focus]/[Star Filter]/[Sunshine] ([Filter Settings])
 - [Live View Composite]
 - [Post-Focus]
 - [Multiple Exposure]
- When using APS-C lenses, 6K photo is not available.

Selecting Pictures from a 6K/4K Burst File

You can select pictures from the 6K/4K burst files and save them.

- When continuing to select pictures from the Auto Review after recording 6K/4K photos, start the operation from either Step **2** or **3**.

1 Select a 6K/4K burst file on the playback screen. (→ 300)

- Select an image with the  or  icon and then press **▲**.
- You can also perform the same operation by touching  or .



- If the images were recorded with [6K/4K Pre-Burst], proceed to Step **3**.

2 Roughly select the scene.

- Drag the slide bar **(A)**.
- For information about how to use the picture selection slide view screen, refer to page 141.
- If the images were recorded with [6K/4K Burst] or [6K/4K Burst(S/S)], touching  allows you to select the scene in the 6K/4K burst playback screen. (→ 143)

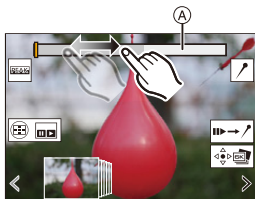

Picture selection slide view screen

3 Select the frame to save.

- Drag the picture selection slide view **(B)**.
- You can also perform the same operation by pressing **◀▶**.
- To continuously rewind or forward frame-by-frame, touch and hold **[<]** / **[>]**.

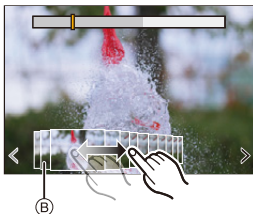

4 Save the picture.

- Touch [] or [.
- A confirmation screen appears.

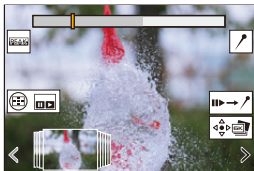

- The picture is saved in JPEG format ([FINE] picture quality).
- The recording information (Exif information), such as the shutter speed, aperture, and ISO sensitivity, is also saved with the picture that is saved.

Correcting Pictures After Recording (Post-Recording Refinement)

❖ Correcting Distortion in Pictures ([Reduce Rolling Shutter])

When saving pictures, correct any distortion caused by the electronic shutter (rolling shutter effect).



- 1 On the save confirmation screen in Step 4 on page 140, touch [Reduce Rolling Shutter].
 - If there is no effect even after using correction, after a message is displayed advising that there is no effect, the confirmation screen returns.
- 2 Check the correction result and then touch [Save].
 - To check the corrected and uncorrected versions of the picture, touch [Set/Cancel].



- The angle of view may become narrower if correction is performed.
- The correction may appear unnatural due to the movement of subjects.

❖ Reducing Noise Caused by High Sensitivity ([6K/4K PHOTO Noise Reduction])

When saving pictures, reduce the noise that occurs due to high ISO sensitivity.

 ⇒  ⇒  ⇒ Select [6K/4K PHOTO Noise Reduction]
Settings: [AUTO]/[OFF]









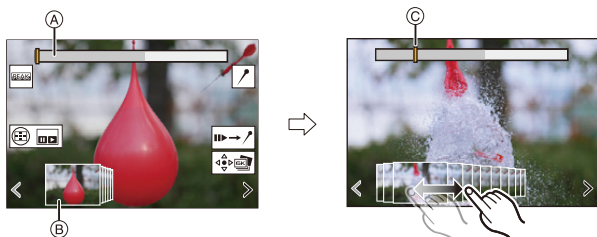







• This is not applied to pictures saved with [6K/4K PHOTO Bulk Saving].

Picture Selection Operations





❖ Picture Selection Slide View Screen Operations



- (A) Slide bar
- (B) Picture selection slide view
- (C) Position of displayed frame

Button operation	Touch operation	Description of operation
	Drag/ < >	Selects a frame. <ul style="list-style-type: none"> To change the frames displayed in the picture selection slide view, select the frame at the left/right end and then touch [<] or [>].
Press and hold 	< > Touch and hold	Continuously rewinds or forwards frame-by-frame.
—	 Touch/drag	Selects the frame to display.
	Pinch out/ pinch in	Enlarges or reduces the display.
	—	Selects a frame while maintaining the enlarged display (during enlarged display).
	Drag	Moves the enlarged display position (during enlarged display).
[]		Displays the 6K/4K burst playback screen.
—		Switches to marker operation.
—		Adds or deletes a marker.
—		Displays the in-focus portion highlighted with color ([Focus Peaking]). <ul style="list-style-type: none"> [ON]/[OFF] are switched.
	 / 	Saves the picture.

- During marker operation, you can skip to set markers or the beginning or end of the 6K/4K burst file. Touch [] to return to the previous operation.

Button operation	Touch operation	Description of operation
		Moves to the next marker.
		Moves to the previous marker.

❖ 6K/4K Burst Playback Screen Operations

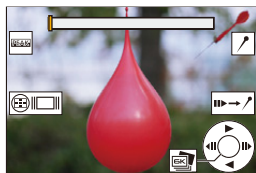





While paused





During continuous playback

Button operation	Touch operation	Description of operation
▲	—	Performs continuous playback or pauses (during continuous playback).
▼	—	Performs continuous rewind playback or pauses (during continuous rewind playback).
▶ / [Sawtooth] / [Gear]	—	Performs fast-forward playback or performs frame-by-frame forwarding (while paused).
◀ / [Sawtooth] / [Gear]	—	Performs fast-rewind playback or performs frame-by-frame rewinding (while paused).
—	Touch/drag	Selects the frame to display (while paused).
	Pinch out/ pinch in	Enlarges or reduces the display (while paused).
/ [Gear]	—	Selects a frame while maintaining the enlarged display (during enlarged display).
▲▼◀▶	Drag	Moves the enlarged display position (during enlarged display).
[[Grid]]		Displays the picture selection slide view screen (while paused).
—		Switches to marker operation.
—	/	Adds or deletes a marker.

—		Displays the in-focus portion highlighted with color ([Focus Peaking]). • [ON]/[OFF] switches.
		Saves the picture (while paused).

- During marker operation, you can skip to set markers or the beginning or end of the 6K/4K burst file. Touch [] to return to the previous operation.









Button operation	Touch operation	Description of operation
	—	Moves to the next marker.
	—	Moves to the previous marker.



- To select and save pictures from a 6K/4K burst file on a PC, use the “PHOTOfunSTUDIO” software.
However, it is not possible to treat 6K/4K burst files as videos in “PHOTOfunSTUDIO”.
- To play and edit 6K burst files on a PC, you need a high-performance PC environment.
We recommend selecting and saving pictures with the camera.

❖ [6K/4K PHOTO Bulk Saving]

You can save any 5 second period of pictures from a 6K/4K burst file all at once.

- 1 Select [6K/4K PHOTO Bulk Saving].
 -  ⇒ [] ⇒ [] ⇒ [6K/4K PHOTO Bulk Saving]
- 2 Press  to select a 6K/4K burst file and then press  or  .
 - If the burst time is 5 seconds or less, all frames are saved as pictures.
- 3 Select the first frame of the pictures to be saved all at once and then press  or  .
 - The pictures are saved as a group of burst pictures in JPEG format.

Recording with Time Lapse Shot

iA P A S M  S&Q



Pictures are taken automatically at a set recording interval.

This feature is ideal for keeping track of changes over time in subjects such as animals and plants.

The pictures taken will be saved as a set of group images that can also be combined into a video.



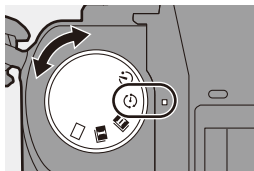

- Check that the clock is set correctly. (→ 54)
- For long recording intervals, we recommend setting [Lens Focus Resume] to [ON] in the [Custom] ([Lens / Others]) menu.

1 Set the drive mode dial to [].



2 Set [Mode] to [Time Lapse Shot].

-  → [] → [] → [Time Lapse/Animation] → [Mode] → [Time Lapse Shot]

Time Lapse/Animation	
Mode	Time Lapse Shot
Shooting Interval Setting	ON
Start Time	Now
Image Count	1
Shooting Interval	1m00s
Exposure Leveling	OFF
End	2020.12.1 10:00

3 Set the recording settings.

[Mode]	Switches between Time Lapse Shot and Stop Motion Animation.	
[Shooting Interval Setting]	[ON]	Sets the interval before the next recording takes place.
	[OFF]	Takes pictures without leaving recording intervals.
[Start Time]	[Now]	Starts recording when the shutter button is pressed fully.
	[Start Time Set]	Starts recording at the set time.
[Image Count]/ [Shooting Interval]	Sets the number of pictures and the recording interval to be taken. <ul style="list-style-type: none"> • [Shooting Interval] is not available when [Shooting Interval Setting] is set to [OFF]. 	
[Exposure Leveling]	Adjusts the exposure automatically to prevent large changes in brightness between adjacent frames.	

4 Close the menu.

- Press the shutter button halfway.

5 Start recording.

- Press the shutter button fully.
- When [Start Time Set] is set, the camera will enter into sleep status until the start time is reached.
- During recording standby, the camera enters into sleep status when no operation is performed for a certain period of time.
- The recording will stop automatically.

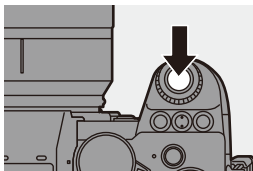

6 Create a video. (→ 152)

- After the recording has stopped, select [Yes] on the confirmation screen to proceed to create a video.
Even if you select [No], you can still create a video with [Time Lapse Video] in the [Playback] ([Process Image]) menu.
(→ 410)

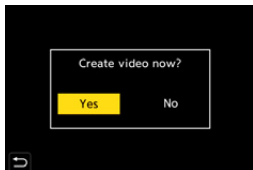

❖ Operations during Time Lapse Shot Recording

Pressing the shutter button halfway during sleep status will turn on the camera.

- You can perform the following operations by pressing [Q] during Time Lapse Shot recording.

[Continue]	Returns to the recording. (Only during recording)
[Pause]	Pauses the recording. (Only during recording)
[Resume]	Resumes the recording. (Only while paused) <ul style="list-style-type: none"> • You can also press the shutter button to resume.
[End]	Stops the Time Lapse Shot recording.



- Pictures recorded to more than one card cannot be combined into a single video.
- Pictures taken with [HLG Photo] cannot be converted to videos.
- The camera gives priority to achieving the standard exposure, so it may not take pictures at the set interval or take the set number of pictures. Furthermore, it may not end at the end time displayed on the screen.
- Time Lapse Shot is paused in the following cases.
 - When the charge on the battery runs out
 - When you set the camera on/off switch to [OFF]
You can set the camera on/off switch to [OFF] and replace the battery or card.
Set the camera on/off switch to [ON] and then press the shutter button fully to resume recording.
(Note that the images recorded after replacing the card will be saved as a separate set of group images.)
- [Exposure Leveling] is not available if ISO sensitivity is set to other than [AUTO] in [M] mode.
- [Time Lapse Shot] is not available when using the following functions:
 - [High Resolution Mode]
 - [Live View Composite]
 - [Post-Focus]
 - [Multiple Exposure]

Recording with Stop Motion Animation

iA P A S M M S&Q



Take pictures while moving the subject little by little.

The pictures taken will be saved as a set of group images that can be combined into a stop motion video.

1 Set the drive mode dial to [].

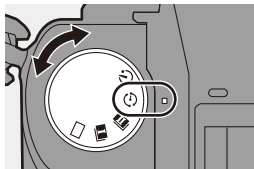

2 Set [Mode] to [Stop Motion Animation].

- → [] → [] → [Time Lapse/Animation] → [Mode] → [Stop Motion Animation]

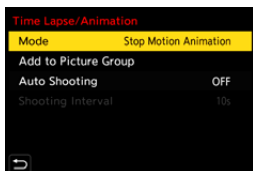

3 Set the recording settings.

[Mode]	Switches between Time Lapse Shot and Stop Motion Animation.	
[Add to Picture Group]	Allows you to continue recording for a set of stop motion images that have already been recorded. <ul style="list-style-type: none"> • Select an image and proceed to Step 5. 	
[Auto Shooting]	[ON]	Takes pictures automatically at a set recording interval.
	[OFF]	This is for taking pictures manually, frame by frame.
[Shooting Interval]	Sets the recording interval for [Auto Shooting].	

4 Close the menu.

- Press the shutter button halfway.

5 Start recording.

- Press the shutter button fully.
- Take pictures repeatedly while moving the subject little by little.
- The recording screen displays up to two pictures taken previously. Use them as reference for the amount of movement.
- You can play back the recorded stop motion images by pressing [▶] during recording.
Press [🗑️] to delete unnecessary images.
To return to the recording screen, press [▶] again.

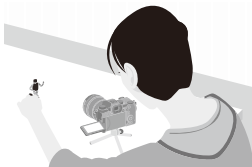
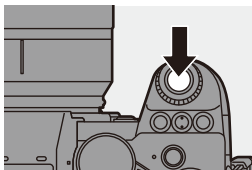

6 Stop recording.

- Press **MENU/SET** and then select [Time Lapse/Animation] from the [Photo] menu to stop recording.

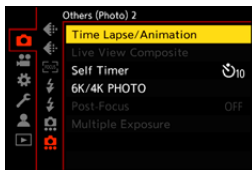

7 Create a video. (→ 152)

- After the recording has stopped, select [Yes] on the confirmation screen to proceed to create a video.
Even if you select [No], you can still create a video with [Stop Motion Video] in the [Playback] ([Process Image]) menu. (→ 410)





- Pictures taken with [HLG Photo] cannot be converted to videos.
- Up to 9999 frames can be recorded.
- If the camera is turned off while recording, a message for resuming the recording is displayed when it is turned on. Selecting [Yes] allows you to continue the recording from the interruption point.
- The camera gives priority to achieving the standard exposure, so it may not take pictures at the set interval when the flash, etc. is used for recording.
- A picture cannot be selected from [Add to Picture Group] when it is the only one that was taken.
- [Stop Motion Animation] is not available when using the following functions:
 - [High Resolution Mode]
 - [Live View Composite]
 - [Post-Focus]
 - [Multiple Exposure]

Time Lapse Shot/Stop Motion Animation Videos

After performing Time Lapse Shot or stop motion recording, you can proceed to create a video.

- Refer to the sections below about these recording functions.
 - Time Lapse Shot recording: → 145
 - Stop motion recording: → 149
- You can also create videos with [Time Lapse Video] (→ 410) or [Stop Motion Video] (→ 410) in the [Playback] menu.

1 Select [Yes] on the confirmation screen that appears after recording.

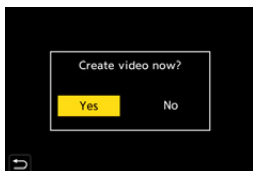

2 Set the options for creating a video.

3 Select [OK].

- A video will be created in the [MP4] recording file format.



[OK]	Creates a video.	
[Rec Quality]	Sets the video image quality.	
[Frame Rate]	Sets the number of frames per second. The larger the number is, the smoother the video will be.	
[Sequence]	[NORMAL]	Splices pictures together in recording order.
	[REVERSE]	Splices pictures together in reverse recording order.



- The [Rec Quality] setting returns to the default setting when the [Switch NTSC/PAL] setting is changed.
- Videos cannot be created if the recording time exceeds 29 minutes and 59 seconds.
- In the following cases, videos cannot be created if the file size exceeds 4 GB:
 - When an SDHC memory card is being used and a 4K [Rec Quality] is set
 - When an FHD [Rec Quality] is set

Recording Using the Self-timer

iA P A S M  S&Q



- 1** Set the drive mode dial to [⏸].

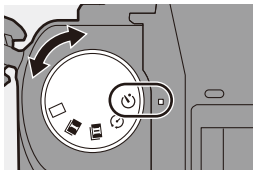

- 2** Decide on the composition and then adjust the focus.

- Press the shutter button halfway.
- The focus and exposure are fixed when the shutter button is pressed halfway.









- 3** Start recording.

- Press the shutter button fully.
- The self-timer light blinks and then the shutter is released.



❖ Setting the Self-timer Time

 →  →  → Select [Self Timer]

	Takes a picture after 10 seconds.
	Takes 3 pictures at approx. 2 second intervals after 10 seconds.
	<p>Takes a picture after 2 seconds.</p> <ul style="list-style-type: none"> • This setting is a convenient way to avoid camera shake caused by pressing the shutter button.



- We recommend using a tripod when recording with the self-timer.



- When the following functions are being used,  is not available:
 - [Simultaneous Record w/o Filter] ([Filter Settings])
 - [Bracketing]
 - [Live View Composite]
 - [Multiple Exposure]
- The self-timer does not work while you are using the following functions:
 - [High Resolution Mode]
 - [Post-Focus]

Bracket Recording

iA P A S M  S&Q



When the shutter button is pressed, the camera can record multiple images while automatically changing the setting value for exposure, aperture, focus or white balance (adjustment value or color temperature).



- Aperture Bracket can be selected in the following modes:
 - [A] mode
 - [M] mode (when ISO sensitivity is set to [AUTO])
- White Balance Bracket (Color Temperature) can be selected when the white balance is set to [K1], [K2], [K3], or [K4].

1 Set [Bracketing Type].

- MENU/SET → [CAMERA] → [BRACKETING] → [Bracketing] → [Bracketing Type]

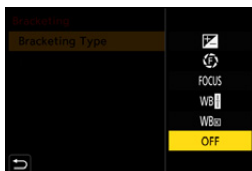

2 Set [More Settings].

- For information about [More Settings], refer to page for each bracketing method.

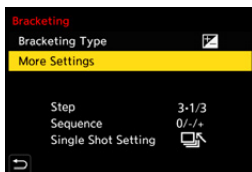



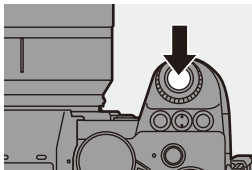

3 Close the menu.

- Press the shutter button halfway.

4 Focus on the subject and then take pictures.



❖ Setting Items ([Bracketing Type])

[] Exposure Bracket	When the shutter button is pressed, the camera records while changing the exposure. (→ 159)
[] Aperture Bracket	When the shutter button is pressed, the camera records while changing the aperture value. (→ 159)
[FOCUS] Focus Bracket	When the shutter button is pressed, the camera records while changing the focus point. (→ 160)
[WB ] White Balance Bracket	When the shutter button is pressed once, the camera automatically records three images with the different white balance adjustment values. (→ 161)
[WB ] White Balance Bracket (Color Temperature)	When the shutter button is pressed once, the camera automatically records three images with the different white balance color temperatures. (→ 161)
[OFF]	—

❖ How to Cancel Bracketing

Select [OFF] in Step 1.



- When [Aspect Ratio] is set to [65:24]/[2:1], only the Exposure Bracket can be used.
- White Balance Bracket and White Balance Bracket (Color Temperature) are not available when using the following functions:
 - [iA] mode
 - Taking burst pictures
 - [RAW+FINE]/[RAW+STD.]/[RAW] ([Picture Quality])
 - [HLG Photo]
 - [Filter Settings]
- Bracket recording is not available while you are using the following functions:
 - [6K/4K PHOTO]/[Post-Focus]
 - [Time Lapse Shot]
 - [Stop Motion Animation] (when [Auto Shooting] is set)
 - [High Resolution Mode]
 - [Rough Monochrome]/[Silky Monochrome]/[Miniature Effect]/[Soft Focus]/[Star Filter]/[Sunshine] ([Filter Settings])
 - [Live View Composite]
 - [Multiple Exposure]

❖ [More Settings] (Exposure Bracket)

[Step]	Sets the image count and exposure compensation step. [3•1/3] (record 3 images in 1/3 EV steps) to [7•1] (record 7 images in 1 EV steps)
[Sequence]	Sets the order in which images are recorded.
[Single Shot Setting]	<p>[☐]: Takes only one image each time the shutter button is pressed.</p> <p>[☐/5]: Takes all of the set number of images when the shutter button is pressed once.</p> <ul style="list-style-type: none"> • The [BKT] icon blinks until all of the set number of pictures is taken.



- When you record images with Exposure Bracket after setting the exposure compensation value, the images recorded are based on the selected exposure compensation value.

❖ [More Settings] (Aperture Bracket)

[Image Count]	<p>[3]/[5]: Records the set number of images while alternately setting the aperture value in the sequence of one before and then one after using the initial aperture value as the reference.</p> <p>[ALL]: Records images using all aperture values.</p>
----------------------	---

Example when the initial position is set to F8.0

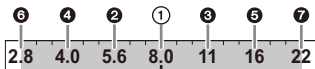

① 1st image, ② 2nd image, ③ 3rd image ... ⑦ 7th image

❖ [More Settings] (Focus Bracket)

[Step]	<p>Sets the focus adjustment step.</p> <ul style="list-style-type: none"> The distance that the focus point is moved becomes shorter if the initial focus point is close, and longer if it is far away.
[Image Count]	<p>Sets the image count.</p> <ul style="list-style-type: none"> This cannot be set when taking burst pictures. Burst pictures are taken while the shutter button is pressed.
[Sequence]	<p>[0/-/+]: Records while alternately moving the focus point in the sequence of forward and then backward using the initial focus point as the reference.</p> <p>[0/+]: Records while moving the focus point toward the far side using the initial focus point as the reference.</p>

Example when [Sequence]: [0/-/+] is set

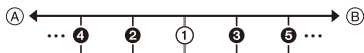

Example when [Sequence]: [0/+] is set



(A) Focus: closer





(B) Focus: more distant

① 1st image, ② 2nd image ... ⑤ 5th image ...



• Pictures recorded with Focus Bracket are displayed as images of one group.

❖ [More Settings] (White Balance Bracket)

Rotate ,  or  to set the correction step and then press  or .

Rotate to the right:

Horizontal direction ([A] - [B])

Rotate to the left:



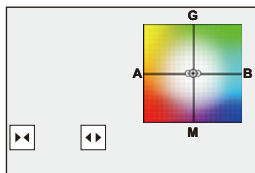

Vertical direction ([G] - [M])

- The correction step can also be set by touching

   .



❖ [More Settings] (White Balance Bracket (Color Temperature))

Rotate ,  or  to set the correction step and then press  or .

- The correction step can also be set by touching

 .

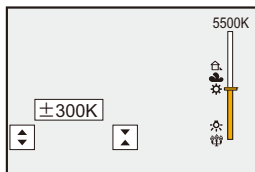

[Live View Composite]

iA P A S **M**  S&Q



Images are recorded over several times and only the parts that change to become brighter form part of the composition.

The images composed by recording at a set exposure time (shutter speed) are displayed, allowing the images to be confirmed as recording proceeds. This allows you to reduce the overall brightness for recording, so it is convenient for recording the light trails of stars or fireworks against a bright nightscape.

-  • Use a tripod to minimize camera shake.

1 Set the mode dial to [M].

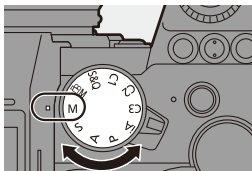



2 Set [Live View Composite].

-  →  →  → [Live View Composite]





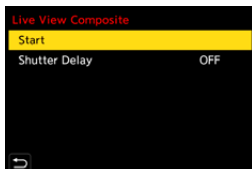

3 Start Live View Composite recording.

- Select [Start] and then press  or .



4 Decide on the composition and then fix the camera in place.

5 Set the shutter speed and ISO sensitivity.

- Rotate  to set the shutter speed.
- Press [ISO], then rotate , , or  to set the ISO sensitivity.

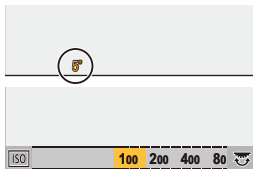

- The shutter speed can be set in the range between 60 seconds and 1/1.6 of a second.
- The ISO sensitivity can be set in the range between [100] and [3200] ([50] and [3200] when [Extended ISO] is set).

6 Get the image to use for noise reduction.

- Press the shutter button fully.

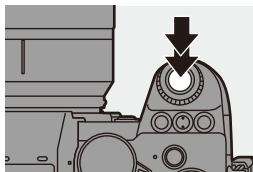

7 Start recording.

- Press the shutter button fully.
 - Recording is done according to the settings in Step 5, and images processed with noise reduction are merged a frame at a time.
- Histogram display
 - Shutter speed × Number of images merged
 - Elapsed time

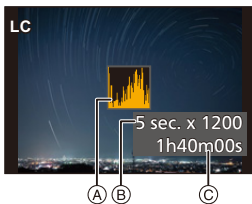

8 Stop recording.

- Press the shutter button fully.
- A maximum of 3 hours can be recorded with one Live View Composite recording.
(Recording automatically ends when the time exceeds 3 hours.)

9 End [Live View Composite].

- Press [Q].

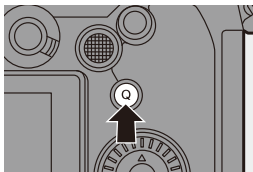

❖ Setting Items ([Live View Composite])

[Start]	Starts Live View Composite recording.
[Shutter Delay]	Sets the delay time from when the shutter button is pressed until the shutter is released. [8 SEC]/[4 SEC]/[2 SEC]/[1 SEC]/[OFF]



- [Long Exposure NR] will be [ON].
- When recording with the flash, the flash fires only in the first frame.
- Some menus are not displayed after getting the noise reduction image.
- The image for noise reduction is discarded when you do the following. Do Step **6** again.
 - Modify the shutter speed/ISO sensitivity
 - Switch the playback mode
- When pressing the shutter button fully to end recording, the last image may not be merged.
- During Live View Composite recording, audio is not output to an external device connected by HDMI.
- [Live View Composite] is not available when using the following functions:
 - [ELEC.]/[ELEC.+NR] ([Shutter Type])
 - [High Resolution Mode]
 - [Filter Settings]
 - [Silent Mode]
 - [Multiple Exposure]

Post-Focus Recording

iA P A S M  M S&Q



Taking burst pictures with the same image quality as 6K/4K photos while automatically changing the focus point.

You can select the focus point for the picture to save after recording.

Also Focus Stacking lets you merge images with multiple focus points.

This function is suitable for subjects that do not move.



Perform burst 6K/4K photo recording while automatically shifting the focus.

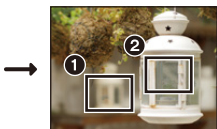

Touch the desired focus point.



A picture with the desired focus point is made.



- Use a UHS Speed Class 3 or higher card when recording.
- The angle of view during recording becomes narrower. (when using a full-frame lens)
- If you are going to perform Focus Stacking after recording, we recommend using a tripod during recording.

1 Set the image quality for [Post-Focus].

-  →  →  →
 [Post-Focus] → [6K 18M]/[4K 8M]

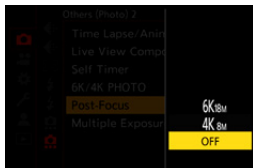

2 Close the menu.

- Press the shutter button halfway.

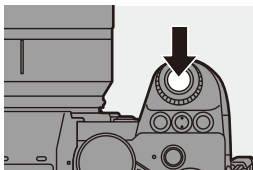

3 Decide on the composition and then adjust the focus.

- Press the shutter button halfway.
- AF detects the focus point on the screen. (Excluding the edges of the screen)

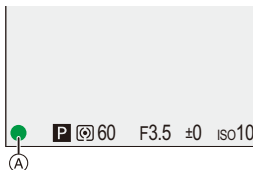

- If no areas on the screen can be brought into focus, the focus icon (A) blinks and recording is not possible.
- Maintain the same distance to the subject and the same composition until recording finishes.

4 Start recording.

- Press the shutter button fully.
- Recording is performed while automatically changing the focus point. When the icon (B) disappears, recording ends automatically.
- A video will be recorded with [Rec. File Format] set to [MP4]. (Audio will not be recorded.)
- In default settings, Auto Review operates, and a screen that lets you select the focus point will be displayed. (→ 169)







- Since recording is performed with the same image quality as 6K/4K photos, limitations apply to recording functions and menus.
- Focus settings cannot be changed during Post-Focus recording.
- When using APS-C lenses, [6K 18M] is not available.
- When the following functions are being used, [Post-Focus] is not available:
 - [Time Lapse Shot]
 - [Stop Motion Animation]
 - [High Resolution Mode]
 - [Rough Monochrome]/[Silky Monochrome]/[Miniature Effect]/[Soft Focus]/[Star Filter]/[Sunshine] ([Filter Settings])
 - [Live View Composite]
 - [Multiple Exposure]

Selecting the Focus Point for the Picture to Save

1 Select a Post-Focus image on the playback screen. (→ 300)

- Select an image with the [] icon and then press ▲.
- You can also perform the same operation by touching the [] icon.



2 Touch the focus point.











- When the point is in focus, a green frame appears.
- If there is no picture with the selected point in focus, a red frame appears. A picture cannot be saved.
- The edge of the screen cannot be selected.

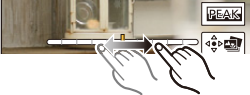

3 Save the picture.

- Touch [].
- The picture is saved in JPEG format.

❖ Focus Point Selection Operations

Button operation	Touch operation	Description of operation
	Touch	<p>Selects a focus position.</p> <ul style="list-style-type: none"> • Selection is not possible during enlarged display.
		<p>Enlarges the display.</p> <ul style="list-style-type: none"> • During enlarged display, you can fine-adjust the focus by dragging the slide bar. (You can also perform the same operation by pressing ◀▶.) 
		Reduces the display (during enlarged display).
		Switches to Focus Stacking operation. (→ 171)
—		<p>Displays the in-focus portion highlighted with color ([Focus Peaking]).</p> <ul style="list-style-type: none"> • [ON]/[OFF] switches.
		Saves the picture.

 • You cannot display an image on a TV screen and then select the focus point.

Focus Stacking

By merging multiple focus points, you can save pictures that are focused from the foreground through to the background.



- (A) Focus: closer
 (B) Focus: more distant

1 On the screen for selecting the focus point in Step 2 on page 169, touch [].

- You can also perform the same operation by pressing [].

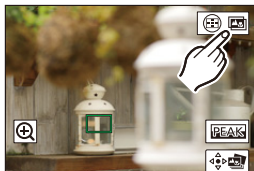

2 Select the merging method.

[Auto Merging]	Automatically selects pictures suitable for merging and then merges them into a single picture.
[Range Merging]	Merges pictures with selected focus points into a single picture.

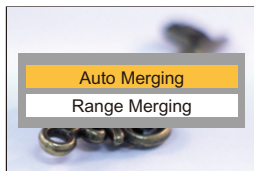

3 (When [Range Merging] is selected)

Touch the focus points.



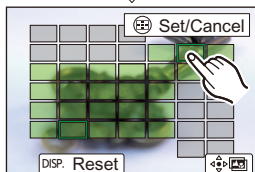
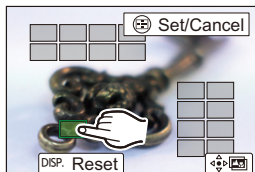

- Select at least two points.
Selected points are indicated with a green frame.
- The in-focus range between the two selected points is displayed in green.
- Ranges that cannot be selected are displayed in gray.
- To cancel the selection, touch a point with a green frame again.
- To select consecutive points, drag the screen.



4 Save the picture.

- Touch [].

❖ Operations when [Range Merging] Is Selected

Button operation	Touch operation	Description of operation
	Touch	Selects a point.
[]	[Set/Cancel]	Sets or cancels a point.
[DISP.]	[All]	Selects all points. (Before selecting points)
	[Reset]	Cancels all selections. (After selecting points)
		Merges the pictures and saves the resulting picture.



- The picture is saved in JPEG format ([FINE] picture quality), and the recording information (Exif information), such as the shutter speed, aperture, and ISO sensitivity, of the picture with the closest point is also saved with the picture that is saved.
- Image misalignment due to camera shake will be adjusted automatically. If adjustments are made, the angle of view will become slightly narrower when the pictures are merged.
- If the subject moves during recording or the distance between subjects is great, merging may create an unnatural picture.





[Silent Mode]

iA P A S M  S&Q



This disables all operation sounds and light output at once.

The audio from the speaker will be muted and the flash and the AF assist light will be set to forced off mode.

- The following settings are fixed:
 - [Flash Mode]: [] (Forced Flash Off)
 - [AF Assist Light]: [OFF]
 - [Shutter Type]: [ELEC.]
 - [Beep Volume]: [] (OFF)
 - [AF Beep Volume]: [] (OFF)
 - [E-Shutter Vol]: [] (OFF)

 ⇒ [] ⇒ [] ⇒ Select [Silent Mode]

Settings: [ON]/[OFF]



- Even when [ON] is set, the following functions light/blink:
 - Charging light/wireless connection light
 - Card access light
 - Self-timer light
- Use this function at your own responsibility sufficiently considering the privacy, portrait, and other rights of subjects.

[Shutter Type]

iA P A S M  S&Q



Selects the shutter type to use for taking pictures.

 →  →  → Select [Shutter Type]

[AUTO]	Switches the shutter type automatically depending on the recording conditions and shutter speed.
[MECH.]	Records with the mechanical shutter type.
[EFC]	Records with the electronic front curtain type.
[ELEC.]	Records with the electronic shutter type.
[ELEC.+NR]	Records with the electronic shutter type. When pictures are taken at slower shutter speeds, the shutter is closed after recording to perform long shutter noise reduction.

	Mechanical shutter type	Electronic front curtain type	Electronic shutter type
Mechanism	This type starts and ends exposure with the mechanical shutter.	This type starts exposure electronically and ends it with the mechanical shutter.	This type starts and ends exposure electronically.
Flash	✓	✓	—
Shutter speed (sec.)	[B] (Bulb, max. approx. 30 minutes) ^{*1} , 60 to 1/8000	[B] (Bulb, max. approx. 30 minutes) ^{*1} , 60 to 1/2000	[B] (Bulb, max. approx. 60 seconds) ^{*1} , 60 to 1/8000
Shutter sound	Mechanical shutter sound	Mechanical shutter sound	Electronic shutter sound ^{*2}



*1 This setting is available only in [M] mode.

*2 The electronic shutter sound can be set in [E-Shutter Vol] and [E-Shutter Tone] in [Beep] of the [Setup] ([IN/OUT]) menu. (→ 399)

- The electronic front curtain type reduces blur caused by the shutter because the amount of vibration from the shutter is small compared to the mechanical shutter type.
- The electronic shutter type allows you to record without vibration from the shutter.



- To reduce shutter-induced blur, you can set the shutter to release a few seconds after the shutter button is pressed:

[] → [] → [Shutter Delay] (→ [360](#))



- When [E] is displayed on the screen, recording will be with the electronic shutter type.
- When a moving subject is recorded using the electronic shutter, the subject may appear distorted in the picture.
- When you record using the electronic shutter under lighting such as fluorescent or LED lighting, horizontal stripes may be recorded. In such a case, lowering the shutter speed may reduce the effect of horizontal stripes.
- When using APS-C lenses, the electronic front curtain is not available.

Image Stabilizer

iA P A S M  S&Q







This camera can use both the in-body image stabilizer and the in-lens image stabilizer.

It is compatible with the Dual I.S.2 system that is an effective combination of the 2 image stabilizers.

Furthermore, during video recording, you can use the 5-Axis Hybrid Image Stabilizer that incorporates electronic stabilization.

Combinations of lenses and image stabilizers (As of September 2020)

Image stabilizers that can be used will differ depending on the attached lens.

Attached lens	Available image stabilizer	Example of icon
Panasonic lenses with image stabilization function	Body+Lens (Dual I.S.2)	DUAL2 
Other manufacturers' lenses with image stabilization function	Body or Lens	BODY / LENS 
Lenses without image stabilizer	Body	BODY 
Lenses without communication function	Body	BODY 

- The 5-Axis Hybrid Image Stabilizer (→ [179](#)) can be used with any lenses.

❖ Using the Image Stabilizer

- When using a lens with an O.I.S. switch, set the switch on the lens to [ON].
- When using lenses without a function for communicating with this camera, a message asking you to check the focal length setting is displayed after you turn on the camera.

Correctly operating the image stabilization function requires that the focal length be set to match the attached lens.

Set the focal length in accordance as prompted by the message.

This can also be set using the menu. (→ [183](#))



- When the shutter button is pressed halfway, the camera shake alert icon [([📷])] may be displayed on the recording screen.
If this is displayed, we recommend using a tripod, the self timer or the Shutter Remote Control (DMW-RS2: optional).
- We recommend turning off the image stabilizer function when using a tripod.



- The image stabilizer may cause vibration or produce operational sound during operation, but these are not malfunctions.
- When the following function is being used, the image stabilizer function is not available:
 - [High Resolution Mode]







- You can display the reference point and check the camera shake status:
[⚙️] → [📷] → [I.S. Status Scope] (→ [390](#))

Image Stabilizer Settings



Set the image stabilizer operation to match the recording situation.

 →  →  → Select [Image Stabilizer]

[Operation Mode]	Sets the stabilization movement (blur) to match the recording method (normal, panning). (→ 181)	
[Body(B.I.S.) / Lens(O.I.S.)]	[^{BODY} ] ([Body])	The in-body image stabilizer corrects for vertical, horizontal, and rotational shake.
	[^{LENS} ] ([Lens + Body (Roll)])	The in-lens image stabilizer corrects for vertical and horizontal shake, while the in-body image stabilizer corrects for rotational shake.
	<ul style="list-style-type: none"> • This can be set when using other manufacturers' lenses with an image stabilization function. 	
[When to Activate]	[ALWAYS]	The image stabilizer is always operating.
	[HALF-SHUTTER]	The image stabilizer operates when the shutter button is pressed halfway.
[E-Stabilization (Video)]	<p>Camera shake during video recording is corrected along the vertical, horizontal, roll, pitch, and yaw axes through the combined use of the in-lens, in-body, and electronic image stabilizers. (5-Axis Hybrid Image Stabilizer)</p> <ul style="list-style-type: none"> • The  on the recording screen changes to  while [E-Stabilization (Video)] is functioning. • The angle of view may become narrower if set to [ON]. 	
[Boost I.S. (Video)]	<p>Increases the effectiveness of the image stabilizer during video recording.</p> <p>This effect can help provide a stable composition when you want to perform recording from a fixed perspective. (→ 182)</p>	





[Anamorphic (Video)]	You can switch to an image stabilizer that suits anamorphic recording. (→ 182)
[Focal Length Set]	When using lenses without a function for communicating with this camera, manually set the focal length. (→ 183)





- When the following functions are being used, [When to Activate] is fixed to [ALWAYS]:
 - [] ([Body(B.I.S.) / Lens(O.I.S.)])
 - [ M] mode
 - [S&Q] mode
 - Video recording/[6K/4K PHOTO]/[Post-Focus]
- When the following functions are being used, [E-Stabilization (Video)] is not available:
 - [S&Q] mode
 - [Live Cropping]

❖ [Operation Mode]

Set the stabilization movement (blur) to match the recording method (normal, panning).

 [Normal]	Corrects vertical, horizontal, and rotational camera shake. This function is suitable for normal recording.
 [Panning (Auto)]	Automatically detects the panning direction, and corrects vertical and horizontal camera shake. This function is suitable for panning.
 [Panning (Left/Right)]	Corrects vertical camera shake. This is suitable for horizontal panning.
 [Panning (Up/Down)]	Corrects horizontal camera shake. This is suitable for vertical panning.
[OFF]	Turns the image stabilization function OFF.

- Operation modes that can be used will differ depending on the used lenses and on [Body(B.I.S.) / Lens(O.I.S.)] settings.
- [Panning (Auto)] is not displayed when using other manufacturers' lenses with an image stabilization function with [Body(B.I.S.) / Lens(O.I.S.)] set to []. Set to either [Panning (Left/Right)] or [Panning (Up/Down)] to suit the panning direction.
- When using lenses with an O.I.S. switch, the camera's operation mode cannot be set to [OFF]. Set the switch on the lens to [OFF].
- When the following functions are being used, [Operation Mode] switches to [] ([Normal]):
 - [] mode
 - [S&Q] mode
 - Video recording/[6K/4K PHOTO]/[Post-Focus]

❖ [Boost I.S. (Video)]

Increase the effectiveness of the image stabilizer during video recording. This effect can help provide a stable composition when you want to perform recording from a fixed perspective.

Settings: [ON]/[OFF]





- When [Boost I.S. (Video)] is operating, [] is displayed on the recording screen.
- To change composition while recording, first set this to [OFF] before moving the camera.
To set this to [OFF] during recording, use the Fn button. (→ 321)
- Longer focal lengths will result in weaker stabilization.





- When [Body(B.I.S.) / Lens(O.I.S.)] is set to [, [Boost I.S. (Video)] is not available.

❖ [Anamorphic (Video)]

You can switch to an image stabilizer that suits anamorphic recording.

Settings: []([2.0×])/[]([1.8×])/[]([1.5×])/[]([1.33×])/[]([1.30×])/[OFF]

- Make settings to suit the magnification of the anamorphic lens you are using.
- While [Anamorphic (Video)] is functioning, the set magnification appears on the image stabilizer icons on the recording screen, as shown by [] and [].





- When [Boost I.S. (Video)] is set, [Boost I.S. (Video)] is prioritized.
- When the following function is being used, [Anamorphic (Video)] is fixed to [OFF]:
– [] ([Body(B.I.S.) / Lens(O.I.S.)])
- Image stabilizer functions on your lens may not work correctly. Turn off the image stabilizer function on your lens if this is the case.

❖ [Focal Length Set]

When using lenses without a function for communicating with this camera, manually set the focal length inscribed on the lens.

Up to three focal length settings can be registered.

Registered focal length settings can be called.

Entering focal length input (A)	Enter the focal length. ◀▶: Select ▲▼: Select a numeric value. MENU/SET or  : Confirm • 0.1 mm to 1000.0 mm can be set.
Registration and calling (B)	Register the entered focal length. Call the registered focal length. ◀▶: Select [DISP.]: Register the entered focal length. MENU/SET or  : Call the registered focal length.

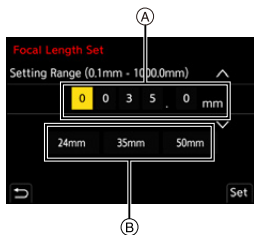

7. Metering/Exposure/ISO Sensitivity

[Metering Mode]

iA P A S M S&Q



Type of optical measurement to measure brightness can be changed.

→ [] → [] → Select [Metering Mode]

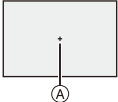
[] (Multi-metering)	Method in which the most suitable exposure is measured by judging the allocation of brightness on the whole screen.
[] (Center-weighted)	Method used to perform measuring which focuses on the center of the screen.
[] (Spot)	Method used to measure the extremely small part around the spot-metering target (A). <ul style="list-style-type: none">• When you move the AF area, the spot metering target also moves to match. 
[] (Highlight-weighted)	Method used to perform measuring which focuses on the highlighted parts of the screen to prevent overexposure. This is suitable for theatre photography, etc.

→ • The standard value for standard exposure can be adjusted:
[] → [] → [Exposure Offset Adjust.] (→ 371)

Program AE Mode

iA **P** A S M  S&Q



In [P] mode (Program AE mode), the camera automatically sets the shutter speed and aperture value for the brightness of the subject.

You can also use Program Shift to change combinations of shutter speed and aperture values while keeping the same exposure.

1 Set the mode dial to [P].

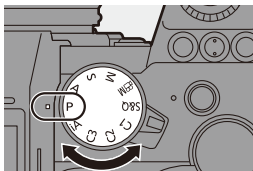

2 Press the shutter button halfway.

- This displays the aperture value (A) and shutter speed value (B) on the recording screen.
- If the correct exposure is not achieved, the aperture value and shutter speed blink red.

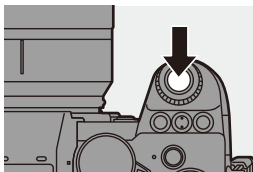

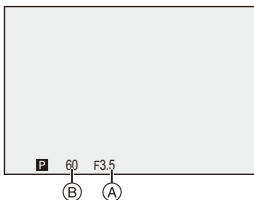

3 Start recording.



❖ Program Shift



You can change the shutter speed and aperture value combination set automatically by the camera while maintaining the same exposure.

With this, you can, for example, make the background more defocused by decreasing the aperture value or capture a moving subject more dynamically by slowing the shutter speed.

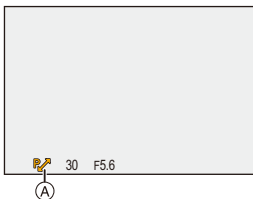
- ❶ Press the shutter button halfway.
 - This displays the aperture value and shutter speed value on the recording screen. (Approx. 10 seconds)
- ❷ Rotate  or  while the values are displayed.
 - This displays the Program Shift icon (A) on the recording screen.
- ❸ Start recording.



Canceling Program Shift

- Set the camera on/off switch to [OFF].
- Rotate  or  until the Program Shift icon disappears.



- Program Shift is not available when using the following functions:
 - Flash
 - [6K/4K PHOTO]/[Post-Focus]



- You can customize dial operations:
 - [] ⇒ [] ⇒ [Dial Set.] ⇒ [Assign Dial (F/SS)]/[Rotation (F/SS)] (→ 380)
- The recording screen can display an exposure meter indicating the relationship between aperture value and shutter speed:
 - [] ⇒ [] ⇒ [Expo.Meter] (→ 388)

Aperture-Priority AE Mode

iA P **A** S M  S&Q



In [A] mode (Aperture-Priority AE mode), you can set the aperture value before recording.

The shutter speed will be automatically set by the camera.



Smaller aperture values

It becomes easier to defocus the background.



Larger aperture values

It becomes easier to bring everything into focus including the background.

1 Set the mode dial to [A].

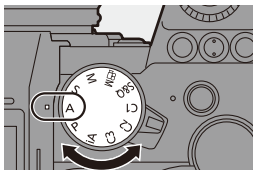

2 Set the aperture value.

- Rotate  or .

3 Start recording.

- If the correct exposure is not achieved when the shutter button is pressed halfway, the aperture value and the shutter speed blink red.

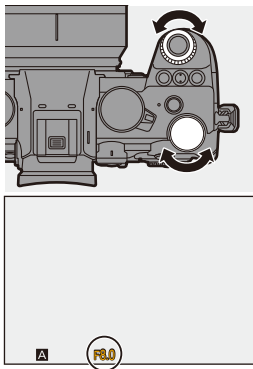

❖ Depth of Field Characteristics



Aperture value	Small	Large
Focal length of lens	Telephoto	Wide-angle
Distance to subject	Near	More distant
Depth of field (area in sharp focus)	Shallow (narrow) Example: When you want to take a image with a defocused background.	Deep (wide) Example: When you want to take a image with focus as far as the background.



- The effects of the set aperture value and shutter speed will not be visible on the recording screen.

To check the effects on the recording screen, use [Preview]. (→ 195)

You can set the preview of the aperture effect to constantly operate in [A] mode to check the depth of field while recording:

[] ⇒ [] ⇒ [Constant Preview] (→ 383)

- The brightness of the recording screen and of actual recorded images may differ.

Check the images on the playback screen.



- When using a lens with an aperture ring, set the position of the aperture ring to other than [A] to use the aperture value of the lens.



- You can customize dial operations:

[] ⇒ [] ⇒ [Dial Set.] ⇒ [Assign Dial (F/SS)]/[Rotation (F/SS)] (→ 380)

- The recording screen can display an exposure meter indicating the relationship between aperture value and shutter speed:

[] ⇒ [] ⇒ [Expo.Meter] (→ 388)

Shutter-Priority AE Mode

iA P A **S** M  S&Q



In [S] mode (Shutter-Priority AE mode), you can set the shutter speed before recording.

The aperture value will be automatically set by the camera.



Slower shutter speeds

It becomes easier to capture motion



Faster shutter speeds

It becomes easier to freeze motion

- 1 Set the mode dial to [S].

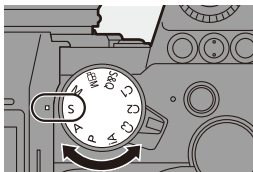

2 Set the shutter speed.

- Rotate  or .



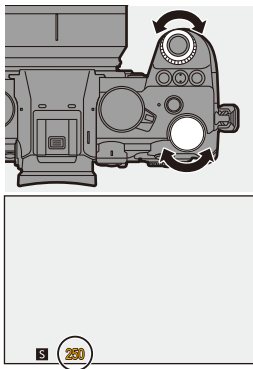

3 Start recording.

- If the correct exposure is not achieved when the shutter button is pressed halfway, the aperture value and the shutter speed blink red.



- The effects of the set aperture value and shutter speed will not be visible on the recording screen.
To check the effects on the recording screen, use [Preview]. (→ 195)
- The brightness of the recording screen and of actual recorded images may differ.
Check the images on the playback screen.
- Shutter speeds faster than 1/250 of a second are not available when recording using a flash. (→ 231)



- You can customize dial operations:
[] → [] → [Dial Set.] → [Assign Dial (F/SS)]/[Rotation (F/SS)] (→ 380)
- The recording screen can display an exposure meter indicating the relationship between aperture value and shutter speed:
[] → [] → [Expo.Meter] (→ 388)

Manual Exposure Mode

iA P A S **M** S&Q



In [M] mode (Manual Exposure mode), you can take pictures by manually setting the aperture value and shutter speed.

In default settings, the ISO sensitivity is set to [AUTO].



As a result, the ISO sensitivity will be adjusted according to the aperture value and shutter speed.

Exposure compensation can also be used when ISO sensitivity is set to [AUTO].

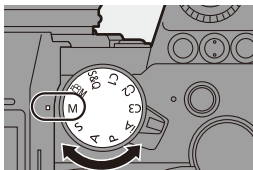
1 Set the mode dial to [M].



2 Set the aperture value and shutter speed.

- Rotate  to set the aperture value (A), and  to set the shutter speed (B).

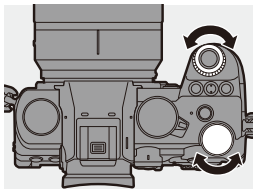

3 Start recording.

- If the correct exposure is not achieved when the shutter button is pressed halfway, the aperture value and the shutter speed blink red.

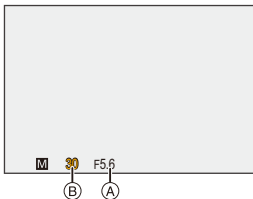

❖ Available Shutter Speeds (Sec.)

[MECH.]	[B] (Bulb, max. approx. 30 minutes), 60 to 1/8000
[EFC]	[B] (Bulb, max. approx. 30 minutes), 60 to 1/2000
[ELEC.]	[B] (Bulb, max. approx. 60 seconds), 60 to 1/8000



- The effects of the set aperture value and shutter speed will not be visible on the recording screen.

To check the effects on the recording screen, use [Preview]. (→ 195)

You can set the preview of the aperture effect and the shutter speed effect to constantly operate in [M] mode to check the depth of field and movement of the subject while recording:

[] → [] → [Constant Preview] (→ 383)

- The brightness of the recording screen and of actual recorded images may differ.

Check the images on the playback screen.

- When using a lens with an aperture ring, set the position of the aperture ring to other than [A] to use the aperture value of the lens.
- Shutter speeds faster than 1/250 of a second are not available when recording using a flash. (→ 231)



- You can customize dial operations:

[] → [] → [Dial Set.] → [Assign Dial (F/SS)]/[Rotation (F/SS)] (→ 380)

- The recording screen can display an exposure meter indicating the relationship between aperture value and shutter speed:

[] → [] → [Expo.Meter] (→ 388)

❖ Manual Exposure Assist

When ISO sensitivity is set to other than [AUTO], Manual Exposure Assist (example: +1) will be displayed on the recording screen.

You can check the difference between the current exposure value and the standard exposure (± 0) measured by the camera.

- Use Manual Exposure Assist as a guide.

We recommend checking the images on the playback screen when recording.

❖ [B] (Bulb)

If you set the shutter speed to [B] (Bulb), the shutter stays open while the shutter button is pressed fully. (up to approx. 30 minutes)

The shutter closes when the shutter button is released.

Use this when you want to keep the shutter open for a long time to record images of fireworks, night scenery or a starry sky.



- We recommend using a tripod or the Shutter Remote Control (DMW-RS2: optional) during bulb recording.
- Bulb recording may create noticeable noise.
If you are concerned about noise, we recommend that you set [Long Exposure NR] (→ 351) to [ON] in the [Photo] ([Image Quality]) menu before recording.



- Bulb is not available when using the following functions:
 - [6K/4K PHOTO]/[Post-Focus]
 - [Time Lapse Shot]
 - [Stop Motion Animation] (when set to [Auto Shooting])
 - [High Resolution Mode]
 - [Bracketing]
 - [Live View Composite]

Exposure Compensation

iA P A S M  S&Q



You can compensate the exposure when the standard exposure determined by the camera is too bright or too dark.

You can adjust the exposure in 1/3 EV steps in a range of ± 5 EV.

When recording videos or recording with 6K/4K photo or Post-Focus, the range changes to ± 3 EV.

- 1 Press [].
- 2 Compensate the exposure.

- Rotate  ,  , or  .

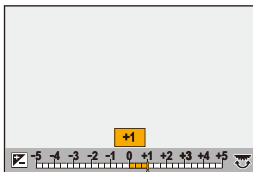
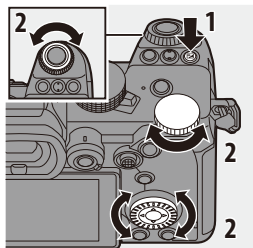



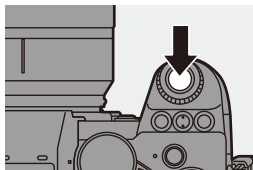





- 3 Confirm your selection.
 - Press the shutter button halfway.





- In [M] mode, you can compensate the exposure by setting the ISO sensitivity to [AUTO].
- When the exposure compensation value falls below or exceeds ± 3 EV, the brightness of the recording screen will no longer change.
Press the shutter button halfway or use AE Lock to reflect the value on the recording screen.
- The set exposure compensation value is stored even if you turn off the camera.



- The standard value for standard exposure can be adjusted:
[] \Rightarrow [] \Rightarrow [Exposure Offset Adjust.] (\rightarrow 371)
- You can set the exposure compensation value to be reset when the camera is turned off:
[] \Rightarrow [] \Rightarrow [Exposure Comp. Reset] (\rightarrow 372)
- You can change the operation of the [] button:
[] \Rightarrow [] \Rightarrow [WB/ISO/Expo. Button] (\rightarrow 379)
- Exposure Bracket can be set and flash output can be adjusted on the exposure compensation screen:
[] \Rightarrow [] \Rightarrow [Exposure Comp. Disp. Setting] (\rightarrow 379)

Locking Focus and Exposure (AF/AE Lock)

iA P A S M S&Q



Lock the focus and exposure in advance to take pictures with the same focus and exposure settings while changing the composition.

This is useful when you want to bring an edge of the screen into focus or there is a backlight, for example.

1 Register [AE LOCK], [AF LOCK], or [AF/AE LOCK] to the Fn button. (→ 321)

- These cannot be registered to [Fn3] to [Fn7].

[AE LOCK]	The exposure is locked.
[AF LOCK]	The focus is locked.
[AF/AE LOCK]	Both focus and exposure are locked.

2 Lock focus and exposure.

- Press and hold the Fn button.
- If focus is locked, then the AF lock icon will be displayed.
- If exposure is locked, then the AE lock icon will be displayed.

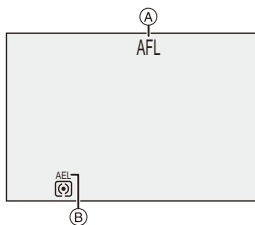

3 Hold the Fn button to decide on the composition and then perform recording.

- Press the shutter button fully.



- In the [M] mode, the AE Lock can be used when ISO sensitivity is set to [AUTO].
- Program Shift can be set even when AE is locked.



- You can maintain lock even without pressing and holding the Fn button:
 → [] → [AF/AE Lock Hold] (→ 373)

ISO Sensitivity

iA P A S M  S&Q





You can set light sensitivity (ISO sensitivity).

With the default settings, you can set 100 to 51200 in 1/3 EV increments.

This camera supports Dual Native ISO which enables recording at high sensitivity and with reduced noise by switching the base sensitivity.

The base sensitivity is automatically switched according to the brightness.

- 1 Press [ISO].**
- 2 Select ISO sensitivity.**
 - Rotate , , or .
 - Selection is also possible by pressing [ISO].

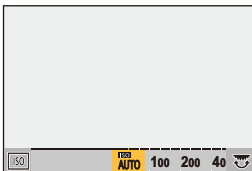
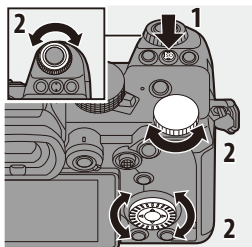

- 3 Confirm your selection.**
 - Press the shutter button halfway.

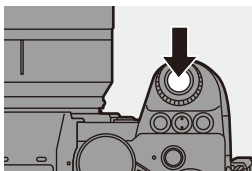



Characteristics of the ISO Sensitivity

By increasing the ISO sensitivity, the shutter speed can be increased in dark places to prevent camera shake and subject blur. However, higher ISO sensitivities also increase the amount of noise in the recorded images.

❖ Setting Items (ISO Sensitivity)

[AUTO]	The ISO sensitivity is automatically adjusted according to the brightness. <ul style="list-style-type: none">• Taking picture: Maximum [6400]^{*1}• Video recording: Maximum [6400]^{*2}
[100] to [51200]	The ISO sensitivity is fixed at the selected value. <ul style="list-style-type: none">• You can extend the ISO sensitivity range in between a lower limit of [50] and an upper limit of [204800] by setting [Extended ISO] (→ 371) to [ON] in the [Custom] ([Image Quality]) menu.

*1 Default setting. The upper limit can be changed with [ISO Sensitivity (photo)].

*2 Default setting. The upper limit can be changed with [ISO Sensitivity (video)].

- When the following functions are being used, the ISO sensitivity that can be set is restricted.
 - [High Resolution Mode]: Up to an upper limit of [3200]
 - [High Dynamic] ([Filter Settings]): Down to a lower limit of [400], up to an upper limit of [6400]
 - Other than [High Dynamic] ([Filter Settings]): Up to an upper limit of [6400]
 - [Live View Composite]: [100] to [3200] (when [Extended ISO] is set: [50] to [3200])
 - [Multiple Exposure]: Down to a lower limit of [100], up to an upper limit of [6400]
 - [Cinelike D2]/[Cinelike V2] ([Photo Style]): Down to a lower limit of [200] (The lower limit changes to [100] when [Extended ISO] is set.)
 - [Like709] ([Photo Style]): Down to a lower limit of [100]
 - [V-Log] ([Photo Style]): Down to a lower limit of [640], up to an upper limit of [51200] (The lower limit changes to [320] when [Extended ISO] is set.)
 - [Like2100(HLG)]/[Standard(HLG)]/[Monochrome(HLG)] ([Photo Style]): Down to a lower limit of [400]



- You can set upper and lower limits for ISO Auto:
 - [📷] → [⚙️] → [ISO Sensitivity (photo)] (→ 352)
 - [👤] → [⚙️] → [ISO Sensitivity (video)] (→ 262)
- You can change the intervals between ISO sensitivity settings values:
 - [⚙️] → [⚙️] → [ISO Increments] (→ 370)
- The setting range of ISO sensitivity can be extended:
 - [⚙️] → [⚙️] → [Extended ISO] (→ 371)
- You can set the lower limit for shutter speed for ISO Auto:
 - [📷] → [⚙️] → [Min. Shutter Speed] (→ 352)
- You can change the operation of the [ISO] button:
 - [⚙️] → [🌅] → [WB/ISO/Expo. Button] (→ 379)
- You can set the upper limit for ISO Auto on the ISO sensitivity settings screen:
 - [⚙️] → [🌅] → [ISO Displayed Setting] (→ 379)

8. White Balance/Image Quality

White Balance (WB)

iA P A S M S&Q



White balance (WB) is a function that corrects the color cast produced by the light illuminating the subject.

It corrects the colors so that white objects appear in white to make the overall color closer to what is seen by the eye.

Normally, you can use auto ([AWB], [AWBc] or [AWBw]) to obtain the optimal white balance.

Set this function when the coloring of the image is different from what you expected, or you want to change the coloring to capture the ambience.

- 1 Press [WB].
- 2 Select the white balance.
 - Rotate , or .
 - Selection is also possible by pressing [WB].

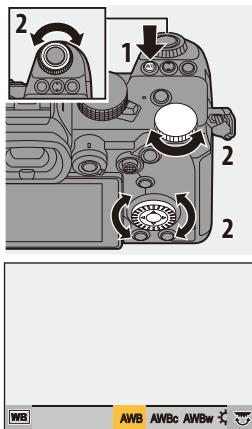

3 Confirm your selection.

- Press the shutter button halfway.

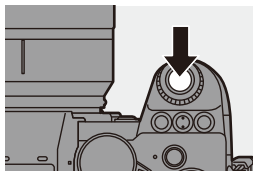

❖ Setting Items (White Balance)

[AWB]	Auto
[AWBc]	Auto (Reduces the reddish hue under an incandescent light source)
[AWBw]	Auto (Leaves the reddish hue under an incandescent light source)
[☀]	Clear sky
[☁]	Cloudy sky
[🏠]	Shade under a clear sky
[☀-]	Incandescent light
[⚡WB]*	Flash
[1] to [4]	Set mode 1 to 4 (→ 205)
[K1] to [K4]	Color temperatures 1 to 4 (→ 205)

* It operates as [AWB] during video recording or when recording with [6K/4K PHOTO] or [Post-Focus].

8. White Balance/Image Quality

1 [AWB] will work within this range.

- 2 Blue sky
- 3 Cloudy sky (Rain)
- 4 Shade
- 5 Sunlight
- 6 White fluorescent light
- 7 Incandescent light bulb
- 8 Sunrise and sunset
- 9 Candlelight

K=Kelvin Color Temperature

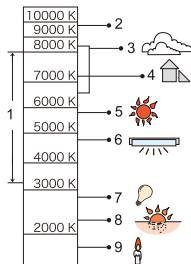

- Under lighting such as fluorescent or LED lighting, the appropriate white balance will vary depending on the lighting type.

Use [AWB], [AWBc], [AWBw] or [] to [].



- The white balance is fixed to [AWB] while [Filter Settings] is being used.



- You can change the operation of the [WB] button:

[] ⇒ [] ⇒ [WB/ISO/Expo. Button] (→ 379)

Adjusting the White Balance

You can adjust the coloring even when the coloring you want to apply is not produced by the selected white balance.

1 Press [WB].

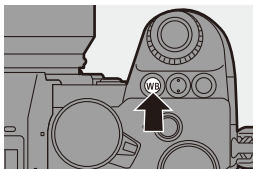





2 Select the white balance and then press ▼.

- The adjustment screen is displayed.

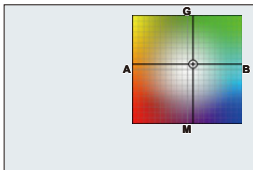
3 Adjust the coloring.

- ◀: [A] (AMBER: ORANGE)
- ▲: [G] (GREEN: GREENISH)
- ▶: [B] (BLUE: BLUISH)
- ▼: [M] (MAGENTA: REDDISH)



- You can also touch the graph to make adjustments.
 - Press [DISP.] to return to the unadjusted state.
 - You can set the White Balance Bracket by rotating ,  or .
- (→ 161)

4 Confirm your selection.

- Press the shutter button halfway.

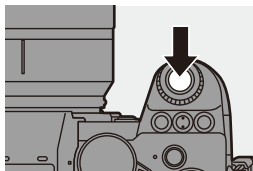

- When the white balance is adjusted, the color of its recording screen icon changes to the adjusted color.
Adjusting toward the [G] side will display [+], while adjusting toward the [M] side will display [-].

[Photo Style]











iA P A S M  S&Q







You can select the finishing settings of images to suit your subjects and expression styles.

The image quality can be adjusted for each Photo Style.

 → [] → [] → Select [Photo Style]



 STD. [Standard]	The standard setting.
 VIVID [Vivid]	A setting that produces a more vivid quality with higher saturation and contrast.
 NAT [Natural]	A setting that produces a softer quality with lower contrast.
 FLAT [Flat]	A setting that produces a flatter image quality with lower saturation and contrast.
 LAND [Landscape]	A setting suited for sceneries with vivid blue skies and greens.
 PORT [Portrait]	A setting suited for portraits with a healthy and beautiful skin tone.
 MONO [Monochrome]	A monochrome setting with no color shades.
 L.MONO [L.Monochrome]	A black-and-white setting with rich gradation and crisp black accents.
 L.MONO D [L.Monochrome D]	A monochrome setting that creates a dynamic impression with enhanced highlights and shadows.
 CINED2 [Cinelike D2]	A setting that creates a film-like finishing touch using a gamma curve and gives priority to the dynamic range. <ul style="list-style-type: none"> • This function is suitable for video editing processes.
 CINEV2 [Cinelike V2]	A setting that creates a film-like finishing touch using a gamma curve that gives priority to the contrast.

 [Like709]	<p>A setting that minimizes overexposure by applying a gamma curve correction equivalent to Rec.709 to perform compression (knee adjustment) of high-luminance areas.</p> <ul style="list-style-type: none"> Rec.709 is an abbreviation of "ITU-R Recommendation BT.709", a standard for high-definition broadcasting.
 [V-Log]	<p>Gamma curve setting intended for post-production processing.</p> <ul style="list-style-type: none"> It allows you to add rich gradation to images during post-production editing.
 [Like2100(HLG)]*1	<p>A setting used to record HLG format video.</p>
 [MY PHOTO STYLE 1]*2 to [MY PHOTO STYLE 10]*2	<p>Adjusts the image quality of Photo Style items to your preferred settings and registers these as My Photo Style items. (→ 214)</p>

*1 Can only be selected when in the [M] mode and set to a 10-bit [Rec Quality]. (→ 250)

*2 Effects up to [MY PHOTO STYLE 4] are displayed with the default settings. You can set the items to display in the menu with [Show/Hide Photo Style] in [Photo Style Settings]. (→ 370)



• When [HLG Photo] is set, the items will be as follows.

 [Standard(HLG)]	<p>Standard [HLG Photo] setting.</p>
 [Monochrome(HLG)]	<p>Black and white setting for [HLG Photo].</p>





- In [iA] mode, operation differs from that in other recording modes.
 - [Standard] or [Monochrome] can be set.
 - The setting will be reset to [Standard] when the camera is switched to another recording mode or it is turned off.
 - Image quality cannot be adjusted.
- The range of available ISO sensitivities is different when [Photo Style] is set to the following:
 - [Cinelike D2], [Cinelike V2]: Down to a lower limit of [200]
(The lower limit changes to [100] when [Extended ISO] is set.)
- You can set the knee mode with [Like709].
For details, refer to page [260](#).
- When [Filter Settings] is being used, [Photo Style] is not available.







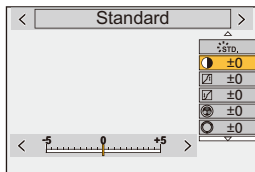

- You can make detailed Photo Style settings:
[] → [] → [Photo Style Settings] (→ [370](#))







❖ Adjusting Image Quality

- 1 Press ◀▶ to select the type of Photo Style.
- 2 Press ▲▼ to select an item and then press ◀▶ to adjust.
 - Adjusted items are indicated with [*].
- 3 Press  or .
 - When the image quality is adjusted, the Photo Style icon on the recording screen is indicated with [*].





Settings Items (Image Quality Adjustment)

	[Contrast]	Adjusts the contrast in the image.
	[Highlight]	Adjusts the brightness of bright areas.
	[Shadow]	Adjusts the brightness of dark areas.
	[Saturation]	Adjusts the vividness of colors.
	[Color Tone]	Adjusts blue and yellow tints.
	[Hue]	Assuming that the reference point is red, this rotates the hue toward violet/magenta or yellow/green to adjust the coloring of the entire image.
	[Yellow]	Enhances the contrast. (Effect: weak) Records the sky with a clear blue.
	[Orange]	Enhances the contrast. (Effect: medium) Records the sky with a darker blue.
	[Red]	Enhances the contrast. (Effect: strong) Records the sky with a much darker blue.
	[Green]	Skin and lips of people appear in natural tones. Green leaves appear brighter and more enhanced.
	[Off]	—

 [Grain Effect]	[Low]/ [Standard]/ [High]	Sets the grain effect level.
	[Off]	—
 [Sharpness]		Adjusts the outlines in the image.
 [Noise Reduction]		Adjusts the noise reduction effect. • Increasing the effect may cause a slight drop in picture resolution.
 [Sensitivity]*		Sets the ISO sensitivity. (→ 199)
 [White Balance]*		Sets the white balance. (→ 202) • While [WB] is selected, press [] to display the white balance setting screen. Press [] again to return to the original screen.

* Available when the following is set while [MY PHOTO STYLE 1] to [MY PHOTO STYLE 10] are selected:

[] ⇒ [] ⇒ [Photo Style Settings] ⇒ [My Photo Style Settings] ⇒ [Add Effects] ⇒ [Sensitivity]/[White Balance] ⇒ [ON]

- The items that you can adjust the image quality for depend on the Photo Style type.

	STD. VIVID NAT FLAT LAND PORT CNE2 CNEV2 STD. ^{HLG}	MONO LMONO LMONOD	709L 2100 ^{HLG}	V-Log	MONO ^{HLG}
	✓	✓	—	—	✓
	✓	✓	—	—	✓
	✓	✓	—	—	✓
 ([Saturation])	✓	—	✓	—	—
 ([Color Tone])	—	✓	—	—	✓
	✓	—	✓	—	—
	—	✓	—	—	✓
	—	✓	—	—	—
	✓	✓	✓	✓	✓
	✓	✓	✓	✓	✓







- The effects of [Grain Effect] cannot be checked on the recording screen.
- [Grain Effect] is not available when using the following functions:
 - Video recording/[6K/4K PHOTO]/[Post-Focus]
 - [High Resolution Mode]

❖ Registering Settings in My Photo Style

iA P A S M  S&Q



- 1 Press ◀▶ to select the type of Photo Style.
- 2 Adjust the image quality.
 - My Photo Style displays the types of Photo Style at the top of image quality adjustment.
Select the base Photo Style.
- 3 Press [DISP.].
- 4 (When [MY PHOTO STYLE 1] to [MY PHOTO STYLE 10] is selected) Press ▲▼ to select [Save Current Setting] and then press  or  .
- 5 Press ▲▼ to select the registration destination number and then press  or  .
 - A confirmation screen will be displayed.
On the confirmation screen, press [DISP.] to change the My Photo Style name.
Up to 22 characters may be entered. Double-byte characters are treated as 2 characters.
How to enter characters (→ 415)



- My Photo Style cannot be registered when using [HLG Photo].

❖ Changing the Registered Contents of My Photo Style

- 1 Select any value from [MY PHOTO STYLE 1] to [MY PHOTO STYLE 10].
- 2 Press [DISP.] and then set the item.

[Load Preset Setting]

[Save Current Setting]

[Edit Title]

[Restore to Default]

[Filter Settings]

iA P A S M S&Q



This mode records with additional image effects (filters).

You can adjust the effect for each filter.

In addition, you can simultaneously take pictures without effects.

1 Set the [Filter Effect].

- → [] → [] → [Filter Settings] → [Filter Effect] → [SET]

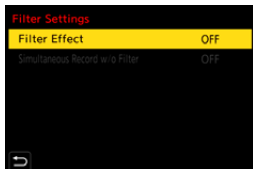

2 Select the filter.

- Press ▲▼ to select, and then press

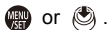

- You can also select the image effect (filter) by touching the sample picture.

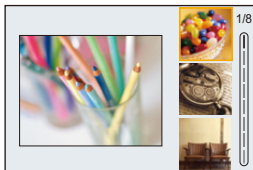

- Press [DISP.] to switch the screen in the order of normal display, guide display, and list display.



The guide display shows the description of each filter.

❖ Adjusting the Filter Effect

You can adjust the filter effect.

- 1 Select the filter.
- 2 On the recording screen, press [WB].
- 3 Rotate , or to set.
 - To return to the recording screen, press [WB] again.
 - When the filter effect is adjusted, the filter icon on the recording screen is indicated with [*].



Filter	Items that can be adjusted
[Expressive]	Vividness
[Retro]	Coloring
[Old Days]	Contrast
[High Key]	Coloring
[Low Key]	Coloring
[Sepia]	Contrast
[Monochrome]	Coloring
[Dynamic Monochrome]	Contrast
[Rough Monochrome]	Grittiness
[Silky Monochrome]	Defocus level
[Impressive Art]	Vividness
[High Dynamic]	Vividness
[Cross Process]	Coloring
[Toy Effect]	Coloring
[Toy Pop]	Area with reduced peripheral brightness
[Bleach Bypass]	Contrast
[Miniature Effect]	Vividness
[Soft Focus]	Defocus level
[Fantasy]	Vividness
[Star Filter]	 : Short rays/Long rays
	 : Few rays/Many rays
	 : Rotate to left/Rotate to right
[One Point Color]	Amount of color left
[Sunshine]	Coloring

❖ Setting a Filter with Touch Operation



- The default settings are for the Touch Tab to not be displayed. Set [Touch Tab] to [ON] in [Touch Settings] in the [Custom] ([Operation]) menu. (→ 377)

1 Touch [].



2 Touch the item to set.

[]: Filter on/off

[EXPS]: Filter

[]: Filter effect adjustment











- White balance will be fixed to [AWB] and the flash will be fixed to [] (Forced Flash Off).
- The upper limit to ISO sensitivity is [6400].
- When [High Dynamic] is set, the lower limit of the ISO sensitivity is fixed to [400] and the higher limit to [6400].
- Depending on the filter, the recording screen may seem as if frames are missed.
- [Rough Monochrome]/[Silky Monochrome]/[Soft Focus]/[Star Filter]/[Sunshine] are not available when using the following function:
 - [] mode
- When using APS-C lenses, [Toy Effect]/[Toy Pop] are not available.
- When [Image Area of Video] is [APS-C] or [PIXEL/PIXEL], recording video with [Toy Effect]/[Toy Pop] is not possible.
- [Filter Effect] is not available when using the following functions:
 - [High Resolution Mode]
 - [Live View Composite]
 - [Multiple Exposure]
 - [Live Cropping]



- When displaying the [Filter Effect] setting screen using the Fn button, pressing [DISP.] displays the filter selection screen.

❖ Setting the Type of Defocus ([Miniature Effect])

- 1 Set [Filter Effect] to [Miniature Effect].
- 2 Press ▲ to display the setting screen.
 - The setting screen can also be displayed by touching [] then [].
- 3 Press ▲▼ or ◀▶ to move the in-focus portion.
 - You can also move the in-focus portion by touching the screen.
 - You can also switch the defocus orientation by touching [].
- 4 Rotate ,  or  to change the size of in-focus portion.
 - The portion can also be enlarged/reduced by pinching out/pinching in the screen.
 - To reset the in-focus portion setting to the default, press [DISP.].
- 5 Press  or  to set.



-  • No audio is recorded in videos.
- When the [Switch NTSC/PAL] is set to [NTSC], the length of the video recorded will be approx. 1/10 of the actual recording time. The displayed video recording time will be approx. 10 times longer than the recording time displayed during normal video recording.
When the [Switch NTSC/PAL] is set to [PAL], the length of the video recorded will be approx. 1/8 of the actual recording time. The displayed video recording time will be approx. 8 times longer than the recording time displayed during normal video recording.
- If you end video recording after a short time, the camera may go on recording for a certain period.

❖ Setting the Color to Be Left ([One Point Color])

- 1 Set [Filter Effect] to [One Point Color].
- 2 Press ▲ to display the setting screen.

- The setting screen can also be displayed by touching [] then [].

- 3 Press ▲▼◀▶ to move the frame and select the color you want to leave.

- You can also select the color you want to leave by touching the screen.
- To return the frame back to the center, press [DISP.].

- 4 Press  or  to set.





❖ Setting the Light Source Position and Size ([Sunshine])

- 1 Set [Filter Effect] to [Sunshine].
- 2 Press ▲ to display the setting screen.

- The setting screen can also be displayed by touching [] then [].

- 3 Press ▲▼◀▶ to move the center position of the light source.

- The position of the light source can also be moved by touching the screen.

- 4 Rotate ,  or  to adjust the size of the light source.

- This can also be enlarged/reduced by pinching out/pinching in the screen.

- To reset the light source setting to the default, press [DISP.].

- 5 Press  or  .

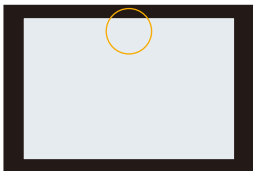



[Simultaneous Record w/o Filter]

iA P A S M  S&Q



You can simultaneously take pictures with no added filter effects.

 ⇒ [] ⇒ [] ⇒ [Filter Settings] ⇒ Select [Simultaneous Record w/o Filter]

Settings: [ON]/[OFF]

 • [Simultaneous Record w/o Filter] is not available when using the following functions:

- Burst recording
- [6K/4K PHOTO]/[Post-Focus]
- [Time Lapse Shot]
- [Stop Motion Animation]
- [RAW+FINE]/[RAW+STD.]/[RAW] ([Picture Quality])
- [Bracketing]

[High Resolution Mode]

iA P A S M  S&Q

This merges pictures with a high resolution from multiple recorded images. This function is suitable for recording subjects that do not move. The picture after merging can be saved in RAW or JPEG format.



- Use a tripod to minimize camera shake.
- The image stabilization function is automatically turned off.

1 Set [High Resolution Mode].

-  →  →  → [High Resolution Mode]

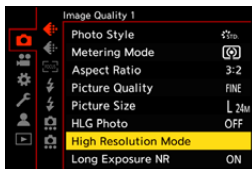



2 Set the recording settings.

[Start]	Starts High Resolution mode.
[Picture Size]	<p>Sets the image size after merging.</p> <p>When the [Aspect Ratio] is [4:3].</p> <p>[XL] (85 M): 10656×8000</p> <p>[LL] (42.5 M): 7552×5664</p> <p>When the [Aspect Ratio] is [3:2].</p> <p>[XL] (96 M): 12000×8000</p> <p>[LL] (48 M): 8496×5664</p> <p>When the [Aspect Ratio] is [16:9].</p> <p>[XL] (81 M): 12000×6736</p> <p>[LL] (40.5 M): 8496×4784</p> <p>When the [Aspect Ratio] is [1:1].</p> <p>[XL] (64 M): 8000×8000</p> <p>[LL] (32 M): 5664×5664</p> <ul style="list-style-type: none"> • RAW images are always recorded in the [3:2] (12000×8000) aspect ratio.

[Picture Quality]	<p>Set the compression rate at which the pictures are to be stored.</p> <p>[COMBINED]/[FINE]/[RAW+FINE]/[RAW]</p> <ul style="list-style-type: none"> When set to [COMBINED], recording is with the same settings as [Picture Quality] in the [Photo] ([Image Quality]) menu. (However, [STD.] changes to [FINE].)
[Simul Record Normal Shot]	<p>Simultaneously takes pictures that are not merged when [ON] is set. The first picture will be saved with [Picture Size] set to [L].</p>
[Shutter Delay]	<p>Sets the delay time from when the shutter button is pressed until the shutter is released.</p> <p>[30 SEC]/[15 SEC]/[8 SEC]/[4 SEC]/[2 SEC]/[1 SEC]/[1/2 SEC]/[1/4 SEC]/[1/8 SEC]/[Off]</p>
[Motion Blur Processing]	<p>Sets the correction method to use when the subject moved.</p> <p>[MODE1]: This gives priority to High Resolution mode, therefore subject blur appears as an afterimage in the picture.</p> <p>[MODE2]: This reduces afterimage from subject blur, but cannot obtain the same High Resolution mode effect in the corrected range.</p>

3 Start High Resolution mode.

- Select [Start] and then press  or .

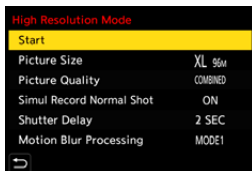

4 Decide on the composition and then fix the camera in place.

- If blurring is detected, the High Resolution mode icon (A) blinks.

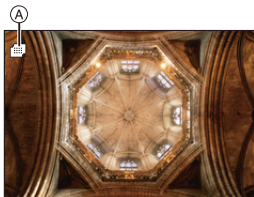

5 Start recording.

- Press the shutter button fully.
- With the default settings, [Shutter Delay] is activated, so there will be a gap in time from when the shutter button is pressed until the shutter is released.
- The screen goes dark during recording.
- The recording state indication (red) (B) blinks.
- Do not move the camera while it is blinking.
- You can continue recording when the merging process ends.



6 End [High Resolution Mode].

- Press [Q].

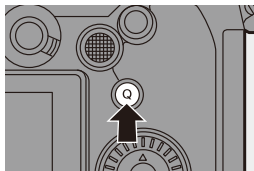



- In [High Resolution Mode], recording will be performed using the following settings:
 - [Shutter Type]: [ELEC.] (When [Long Exposure NR] is set to [OFF])/ [ELEC.+NR] (When [Long Exposure NR] is set to [ON])
 - Minimum aperture value: F16
 - Shutter speed: 8 seconds to 1/8000 of a second
 - ISO sensitivity: Upper limit to [3200]
 - Focus mode: [AFS]/[MF]
- When you record in an extremely bright location or under lighting such as fluorescent or LED lighting, the coloring or brightness of the image may change or horizontal stripes may appear on the screen. Lowering the shutter speed may reduce the effect of horizontal stripes.
- Devices other than this camera may not be able to play back images recorded using [High Resolution Mode].
- When the following functions are being used, [High Resolution Mode] is not available:
 - [Time Lapse Shot]
 - [Stop Motion Animation]
 - [Filter Settings]
 - [Live View Composite]
 - [Multiple Exposure]
- When using APS-C lenses, recording in [High Resolution Mode] is not possible.

[HLG Photo]

iA P A S M  S&Q



Records an HLG format picture with a wide dynamic range. Bright lights that are easily overexposed, and dark areas that are easily underexposed can be recorded showing fine quality and rich colors just as seen with the human eyes.

Recorded pictures can be output over HDMI to devices (TV, etc.) that support HLG format pictures for viewing.

Additionally, devices that support the HSP format can directly play back images.

- “HLG (Hybrid Log Gamma)” is an international standard (ITU-R BT.2100) HDR format.
- “HSP” is an HDR picture format using HLG format video technology. These images are saved with a “.HSP” file extension.

 → [] → [] → Select [HLG Photo]

Setting items	[Aspect Ratio]					
	[4:3]	[3:2]	[16:9]	[1:1]	[65:24]	[2:1]
[Full-Res.]	5312×3984	5984×4000	5888×3312	4000×4000	—	—
[4K-Res.]	2880×2160	3232×2160	3840×2160	2144×2144	—	—
[OFF]	—					

- [Photo Style] can be selected from [Standard(HLG)] or [Monochrome(HLG)]. (→ 208)
- JPEG images and RAW images are recorded simultaneously in accordance with [Picture Quality] (→ 86) and [Picture Size] (→ 85).
RAW images recorded with [HLG Photo] can be saved in the HLG format by using [RAW Processing]. (→ 312)

❖ ISO Sensitivity When [HLG Photo] Is Set

The lower limit of available ISO sensitivities will become [400].



- The monitor and viewfinder on this camera do not support display of HLG format images.
In the [Custom] ([Monitor / Display (Video)]) menu, you can display the images converted for monitoring on the monitor/viewfinder of this camera with [Monitor] in [HLG View Assist]. (→ 282)



- HLG images appear darker on devices that do not support the HLG format.
With [HDMI] in [HLG View Assist] in the [Custom] ([Monitor / Display (Video)]) menu, you can set the conversion method for images displayed for monitoring. (→ 282)
- When using APS-C lenses, [Full-Res.] cannot be used.
- When the following functions are being used, [HLG Photo] is not available:
 - [6K/4K PHOTO]/[Post-Focus]
 - [High Resolution Mode]
 - [Filter Settings]
 - [Live View Composite]
 - [Multiple Exposure]

9. Flash

Using an External Flash (Optional)

iA P A S M  S&Q



If you attach the Flash (DMW-FL580L/DMW-FL360L/DMW-FL200L: optional) to the hot shoe, you can record using the flash.

Furthermore, by attaching an external flash that supports wireless flash recording, you can wirelessly control an external flash that is in a position separate from the camera.



- Remove the lens hood to prevent vignetting.
- Flash recording is not possible when the following functions are being used:
 - [6K/4K PHOTO]/[Post-Focus]
 - [ELEC.]/[Silent Mode]/[High Resolution Mode]
 - [Filter Settings]

Removing the Hot Shoe Cover

Before attaching the Flash (optional), remove the hot shoe cover.

Refer to the operating instructions for the Flash for details about how to attach it.

Remove the hot shoe cover by pulling it in the direction indicated by arrow ② while pressing it in the direction indicated by arrow ①.

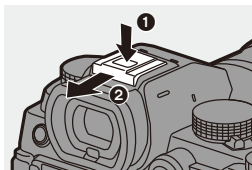

❖ Notes on Flash Recording



- Do not bring any object near the flash. Heat or light may cause the object to deform or discolor.
- If you record repeatedly, time may be needed to charge the flash. While the flash is charging, images will be recorded without the flash firing.
- When an external flash is attached, do not carry the camera by holding only the external flash. It may become detached.
- When using a commercially available external flash, do not use one with reversed polarity or function for communicating with a camera. It may cause the camera to malfunction, or it may not operate correctly.
- Refer to the operating instructions for the external flash for details.

Setting Flash

iA P A S M  S&Q







You can set the flash function to control flash firing from the camera.

[Flash Mode]





Sets the flash mode.

 → [] → [] → **Select [Flash Mode]**



<p>[] (Forced Flash On)</p>	<p>The flash fires every time regardless of the recording conditions.</p>
<p>[] (Forced On/Red-Eye)</p>	<p>This is suitable for recording when there is backlighting or under lighting such as fluorescent lighting.</p>
<p>[] (Slow Sync.)</p> <p>[] (Slow Sync./Red-Eye)</p>	<p>When recording images against a nightscape, this will slow the shutter speed when the flash fires to make not only the subject but also the nightscape appear brighter.</p> <ul style="list-style-type: none"> Slower shutter speeds may result in blurry images. To avoid this, we recommend using a tripod.
<p>[] (Forced Flash Off)</p>	<p>The flash does not fire.</p>







- The flash fires twice.
The interval between the first and second firings is longer when [] or [] is set. The subject should not move until the second firing has finished.
- [] and [] cannot be used when the following are set:
 - [Firing Mode]: [MANUAL]
 - [Flash Synchro]: [2ND]
 - [Wireless]: [ON]
- Some flash modes may not be available depending on the settings on the external flash.
- The effectiveness of red-eye reduction varies from person to person.
The effect, which is influenced by factors such as distance to the subject and whether the subject is looking at the camera when the preliminary flash is fired, may not be very noticeable in some cases.



❖ Available Flash Settings by Recording Mode

The available flash settings depend on the recording mode.

(✓: Available, —: Not available)

Recording mode	[]	[]	[]	[]	[]
[P]/[A]	✓	✓	✓	✓	✓
[S]/[M]	✓	✓	—	—	✓



- [] and [] can be set in [iA] mode. In [], the flash mode switches to one suited to the recording situation.

❖ Shutter Speeds for Flash Modes

[Flash Mode]	Shutter speed (sec.)
[⚡]	1/60 ^{*1} to 1/250 ^{*2}
[⚡Ⓞ]	
[⚡S]	1 to 1/200
[⚡SⓄ]	

*1 In [S] mode, this will be 60 seconds and in [M] mode it will be [B] (Bulb).

*2 The maximum setting changes to 1/200 of a second in [P]/[A] modes.

- The guide number decreases when the shutter speed is set to 1/250 of a second.

[Red-Eye Removal]

When [Flash Mode] is set to [⚡Ⓞ] or [⚡SⓄ], the camera automatically detects red-eye and corrects image data.

 →  →  → **Select [Red-Eye Removal]**

Settings: [ON]/[OFF]



- When [ON] is set,  is displayed on the flash icon.
- Red-eye cannot be corrected depending on its appearance.
- When [HLG Photo] is being used, [Red-Eye Removal] is not available.

[Firing Mode]/[Manual Flash Adjust.]

You can select whether to set the flash output automatically or manually.



- The settings made here are enabled when some flashes from other manufacturers are attached.
Set on the flash when a Flash (DMW-FL580L/DMW-FL360L/DMW-FL200L: optional) is attached.

1 Set the [Firing Mode].

- → → [Firing Mode]



[TTL]	Sets flash output to be set automatically by the camera.
[MANUAL]	<p>Sets the flash output manually.</p> <ul style="list-style-type: none"> With [TTL], you can record the images you want even when recording dark scenes where the flash output tends to become greater. The flash output ([1/1], etc.) is displayed on the flash icon of the recording screen.

2 (When set to [MANUAL]) Select [Manual Flash Adjust.] and then press or .



3 Press ◀▶ to set the flash output and then press or



- It can be set within the range of [1/1] (full flash output) to [1/128] in 1/3 steps.

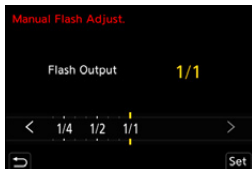

[Flash Adjust.]

You can adjust the flash output when taking pictures with the flash in TTL output mode.

1 Select [Flash Adjust.].

-  → [] → [] → [Flash Adjust.]



2 Press ◀▶ to adjust the flash output and then press or



- It can be adjusted within the range of [-3 EV] to [+3 EV] in 1/3 EV steps.

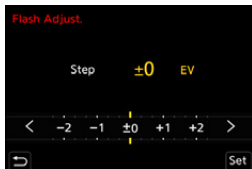

- [] is displayed on the recording screen.
- For information about adjusting the flash output when recording using a wireless flash, refer to page 238.
- [Flash Adjust.] cannot be used when the following are set:
 - [Firing Mode]: [MANUAL]
 - [Wireless]: [ON]



[Flash Synchro]

When a moving subject is recorded at night using a slow shutter and flash, a trail of light may appear in front of the subject.

If you set [Flash Synchro] to [2ND], you can take a dynamic picture with a trail of light appearing behind the subject by firing the flash immediately before the shutter closes.

 →  →  → **Select [Flash Synchro]**



[1ST]	This is the normal method for recording with the Flash.	
[2ND]	The light source appears behind the subject and the picture becomes dynamic.	



- When [2ND] is set, [2nd] is displayed on the flash icon of the recording screen.
- When the following functions are being used, the setting is fixed to [1ST]:
 - [Wireless]
 - [Live View Composite]
- The effect may not be adequately achieved at faster shutter speeds.

[Auto Exposure Comp.]

Automatically adjust the flash output in conjunction with the exposure compensation value. (→ [196](#))

 → [] → [] → **Select [Auto Exposure Comp.]**

Settings: [ON]/[OFF]

Recording Using a Wireless Flash

iA P A S M M S&Q



You can use a Flash (DMW-FL580L/DMW-FL360L/DMW-FL200L: optional) to record using a wireless flash.

You can separately control the firing of three flash groups and the flash attached to the hot shoe of the camera.

❖ Placing a Wireless Flash

Place the wireless flash with its wireless sensor facing the camera.

Placement example

When **C** is placed to erase the shadow in the background of the subject that the flash groups **A** and **B** will create **B** will create

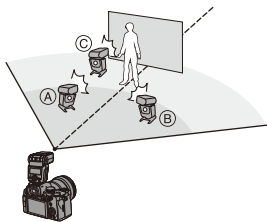

Placement range

When DMW-FL360L is attached

- D** 5.0 m (16 feet)
- E** 7.0 m (23 feet)

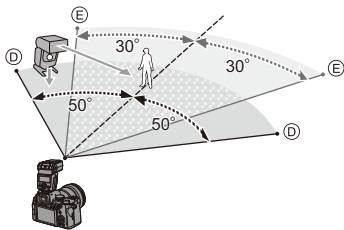

- The placement range serves as a guide for when recording with the camera held horizontally. The range differs depending on the surrounding environment.
- We recommend using a maximum of three wireless flashes in each group.
- If the subject is too close, communication light may affect the exposure. You can reduce the effect by setting [Communication Light] to [LOW] or lowering the output with a diffuser or similar device. (→ 239)

- 1** Attach an external flash to the camera. (→ 227)

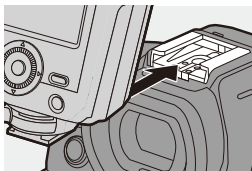

- 2** Set the wireless flashes to [RC] mode and then place them.

- Set the channel and group for the wireless flashes.

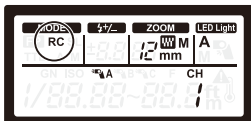

- 3** Enable the wireless flash function of the camera.

- **MENU** SET → [CAMERA] → [WIRELESS] → [Wireless] → [ON]



- 4** Set [Wireless Channel].

- Select the same channel as on the wireless flash side.



- 5** Set [Wireless Setup].

- Set the firing mode and flash output.



❖ Setting Items ([Wireless Setup])

- To fire a test flash, press [DISP.].

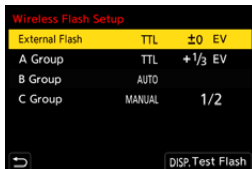



[External Flash]*1	[Firing Mode]	<p>[TTL]: The camera automatically sets the flash output.</p> <p>[AUTO]*2: Sets the flash output on the external flash side.</p> <p>[MANUAL]: Sets the flash output of the external flash manually.</p> <p>[OFF]: The external flash outputs only communication light.</p>
	[Flash Adjust.]	Adjusts the flash output of the external flash manually when [Firing Mode] is set to [TTL].
	[Manual Flash Adjust.]	<p>Sets the flash output of the external flash when [Firing Mode] is set to [MANUAL].</p> <ul style="list-style-type: none"> It can be set within the range of [1/1] (full flash output) to [1/128] in 1/3 steps.
[A Group]/ [B Group]/ [C Group]	[Firing Mode]	<p>[TTL]: The camera automatically sets the flash output.</p> <p>[AUTO]*1: Sets the flash output on the wireless flash side.</p> <p>[MANUAL]: Sets the flash output of the wireless flash manually.</p> <p>[OFF]: The wireless flashes of the specified group will not fire.</p>
	[Flash Adjust.]	Adjusts the flash output of the wireless flash manually when [Firing Mode] is set to [TTL].
	[Manual Flash Adjust.]	<p>Sets the flash output of the wireless flash when [Firing Mode] is set to [MANUAL].</p> <ul style="list-style-type: none"> It can be set within the range of [1/1] (full flash output) to [1/128] in 1/3 steps.

*1 This cannot be selected when [Wireless FP] is set.

*2 This cannot be set when using the Flash (DMW-FL200L: optional).



❖ [Wireless FP]

The external flash performs FP firing (repeated high-speed firing of the flash) during wireless recording, enabling recording using the Flash even at fast shutter speeds.

 → [] → [] → Select [Wireless FP]
Settings: [ON]/[OFF]

❖ [Communication Light]

Set the strength of communication light.

 → [] → [] → Select [Communication Light]
Settings: [HIGH]/[STANDARD]/[LOW]

10. Recording Videos

Recording Videos

iA P A S M  S&Q



It is possible with this camera to record video in 2 recording file formats, MP4 and MOV, to a maximum resolution of 4K.

It is also compatible with both the NTSC and PAL TV broadcast systems. [Creative Video mode] mode (Creative Video mode) and [S&Q] mode (Slow & Quick mode) are recording modes specifically for video.

In the [S&Q] mode, you can record smooth slow motion video and quick motion video by changing the frame rate.

1 Start recording.

- Press the video rec. button.
- Release the video rec. button right after you press it.

2 Stop recording.

- Press the video rec. button again.

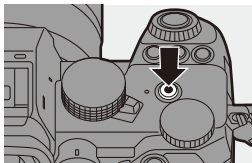

❖ Screen Displays While Video Recording

The live view angle of view changes to the angle of view for video recording, and video recording time (A) and elapsed recording time (B) are displayed.

- “h” is an abbreviation for hour, “m” for minute and “s” for second.
- The recording state indication (C) and card access indication (D) turn red while videos are being recorded.

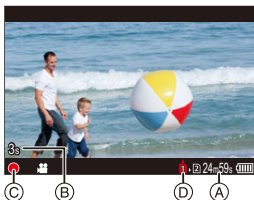

- If maintaining focus on the subject is difficult during video recording with AF, press the shutter button halfway to re-adjust the focus.

❖ Exposure Control While Video Recording

Videos will be recorded using the aperture, shutter speed, and ISO sensitivity settings below.

Recording mode	Aperture value/shutter speed/ISO sensitivity
[iA]	The camera automatically makes the settings to suit the scene. (→ 78)
[P]/[A]/[S]/[M]	The settings vary depending on the [Auto Exposure in P/A/S/M] in the [Custom] ([Image Quality]) menu. The default setting is [ON]. (→ 372) [ON]: Records with values set automatically by the camera. [OFF]: Records with manually set values.
[M]/[S&Q]	Records with manually set values.







❖ Size Interval for Dividing Files

[Rec. File Format]	[Rec Quality]	Size interval for dividing files
[MP4]	[FHD]	A new file will be created to continue recording if the continuous recording time exceeds 30 minutes or the file size exceeds 4 GB.
	[4K]	When using an SDHC memory card: A new file will be created to continue recording if the continuous recording time exceeds 30 minutes or the file size exceeds 4 GB.
[MOV]	All	When using an SDXC memory card: A new file will be created to continue recording if the continuous recording time exceeds 3 hours and 4 minutes or the file size exceeds 96 GB.



- If an operation such as a zoom or button operation is performed during video recording, that operation sound may be recorded.
- The lens operation sound (AF and image stabilizer) may be recorded to video.
- If the operation sound of pressing the video rec. button to end recording bothers you, try the following:
 - Record the video about 3 seconds longer, and then divide the last part of the video using [Video Divide] in the [Playback] ([Edit Image]) menu.
 - Use the Shutter Remote Control (DMW-RS2: optional) for recording.
- Depending on the type of card, the card access indication may appear for a while after video recording. This is not a malfunction.
- Even when playback is performed on a supported device, situations may occur where image or sound quality is poor, recording information is not displayed correctly, or playback is not possible, for example. If you experience any of these, play them back on the camera.
- If the temperature of the camera rises, [,] may be displayed, recording may stop, and some functions may become unavailable temporarily. Wait until the camera cools down.
- Video recording is not possible while you are using the following functions:
 - [Time Lapse Shot]
 - [Stop Motion Animation]
 - [Rough Monochrome]/[Silky Monochrome]/[Soft Focus]/[Star Filter]/[Sunshine] ([Filter Settings])
 - [HLG Photo]
 - [Post-Focus]



- The available recording time can be displayed during recording standby:
 - [] → [] → [Photos/Videos Remaining] (→ [389](#))
- You can switch the live view angle of view to the angle of view for video recording:
 - [] → [] → [Photo/Video Preview] (→ [388](#))
- You can display a red frame on the recording screen that indicates that video is being recorded:
 - [] → [] → [Red REC Frame Indicator] (→ [393](#))

Recording Modes Specifically for Video (Creative Video/S&Q)



[M] mode (Creative Video mode) and [S&Q] mode (Slow & Quick mode) are recording modes specifically for video.

In the [S&Q] mode, you can record smooth slow motion video and quick motion video by changing the frame rate.

In the recording modes specifically for video, you can start and stop video recording with the shutter button.

Change the exposure and audio settings with touch operation to prevent operation sounds from being recorded.

Settings such as exposure and white balance can be changed independent of picture taking settings.

Setting the Exposure for Recording Videos

- 1 Set the mode dial to [M] or [S&Q].

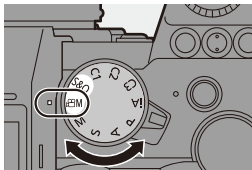

- 2 Set the exposure mode.

- Press **MENU/SET** → [Video Mode] → [Exposure Mode] → [P]/[A]/[S]/[M]
- You can perform the same exposure operations as the [P]/[A]/[S]/[M] modes.

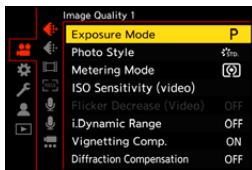

- 3 Close the menu.

- Press the shutter button halfway.

- 4 Start recording.

- Press the shutter button (A) or video rec. button (B).

- 5 Stop recording.

- Press the shutter button or video rec. button again.

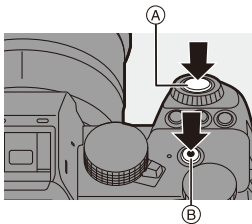

- ➔ • Refer to “Slow & Quick Video” on page 269 for information about slow motion video and quick motion video recording.

❖ Operations During Video Recording

You can change the exposure and other settings with touch operations to prevent operation sounds from being recorded.



- With the default settings, the Touch Tab is not displayed.
Set [Touch Tab] to [ON] in [Touch Settings] in the [Custom] ([Operation]) menu. (→ 377)

① Touch [] or [].

② Touch an icon.

F	Aperture value	ISO	ISO sensitivity
SS	Shutter speed	*1	Sound recording level adjustment
	Exposure compensation	*2	Slow & Quick setting

*1 This setting is available only in [CM] mode.

*2 This setting is available only in [S&Q] mode. (The setting cannot be changed during recording)

③ Drag the slide bar to set the item.

[▼]/[▲]: Changes the setting slowly.

[▼]/[▲]: Changes the setting quickly.

- If you touch icon (A), the screen of Step ② is redisplayed.

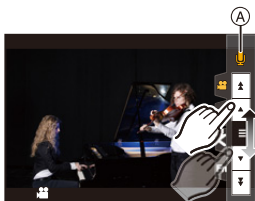



Separating Settings for Recording Video and Pictures



iA P A S M  S&Q



In default settings, settings such as exposure and white balance changed in [M]/[S&Q] mode are also reflected in picture recording in [P]/[A]/[S]/[M] modes.

From the [CreativeVideo Combined Set.] menu, you can separate settings for video recording and for picture recording.

 →  →  → Select [CreativeVideo Combined Set.]

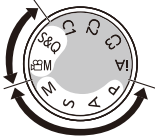
[F/SS/ISO/Exposure Comp.]	 : The recording settings are linked across recording modes. 
[White Balance]	
[Photo Style]	 : Recording settings can be separated by the [M]/[S&Q] mode and the [P]/[A]/[S]/[M] mode. 
[Metering Mode]	
[AF Mode]	

-  The [iA] mode uses the optimum recording settings for the camera automatically, so the recording settings will be independent, irrespective of the settings made with this function.

Video Recording Settings

This section describes the settings used when video recording.

- ➔ • In “4. Image Recording”, the functions described work with both pictures and video.

Please also refer to that section.

- [Double Card Slot Function]: ➔ 88
- [Folder / File Settings]: ➔ 89
- [File Number Reset]: ➔ 91

[Switch NTSC/PAL]



The image qualities you can select in [Rec Quality] are switched to the image qualities with the frame rate to suit the NTSC/PAL TV broadcast system.

The default setting is for the frame rate to be set to suit the TV broadcast system for the region where the camera was purchased.

➔ ➔ ➔ Select [Switch NTSC/PAL]

[NTSC]	The image qualities for NTSC can be selected in [Rec Quality].
[PAL]	The image qualities for PAL can be selected in [Rec Quality].

- ⏴ • If you record using the setting that differs from the broadcasting system of your region, it may not be possible for you to properly play back videos on your TV.

We recommend using the setting as it was at the time of purchase if you are unsure about broadcasting systems.

[Rec. File Format]

iA P A S M  S&Q



Sets the recording file format of videos to be recorded.

 →  →  → Select [Rec. File Format]

[MP4]	This file format is suitable for playback on PCs.
[MOV]	This file format is suitable for image editing.

[Image Area of Video]

iA P A S M  S&Q



Set the image area during video recording. The angle of view differs depending on the image area. Narrowing the image area allows you to achieve a telescopic effect without image deterioration.

 →  →  → Select [Image Area of Video]

Item	Settings details	Angle of view	Telescopic effect
[FULL]	Recording is within the area suited to the image circle of a full-frame lens.	Wide ⇕ Narrow	None ⇕ High
[APS-C]	Records using a range corresponding to the APS-C lens image circle.		
[PIXEL/PIXEL]	Records with one pixel on the sensor, which is equal to one pixel of the video. Records a range corresponding to the resolution range in [Rec Quality]. (→ 250)		

- To check the image area in recording modes other than [M] / [S&Q] mode, set [Photo/Video Preview] to []. (→ 388)
- It is not possible to set to [FULL] in the following cases.
 - When a 4K/60p or 4K/50p [Rec Quality] is set
 - When set to [Anamorphic(4:3)]
 - When using APS-C lenses
- When set to [Live Cropping], the setting is fixed to [FULL]. However, the setting is fixed to [APS-C] in the following case:
 - When a 60p or 50p [Rec Quality] is set

Image area (Ex.: FHD video)

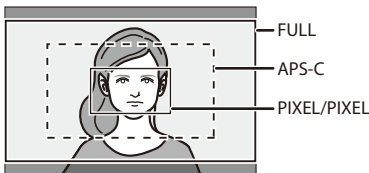

[Rec Quality]



Sets the image quality of videos to be recorded.

The image qualities you can select depend on the [Switch NTSC/PAL] and [Rec. File Format] settings.

→ [] → [] → Select [Rec Quality]

- To record video with a bit rate of 72 Mbps or more, you require a card with the corresponding Speed Class.
For information about the cards that can be used, refer to page 25.
- You can set the recording quality for anamorphic recordings made with an aspect ratio of 4:3 in the [Anamorphic(4:3)] menu. (→ 284)

❖ [Rec. File Format]: [MP4]

- Audio format: AAC (2ch)

- (A) Recording frame rate
- (B) Bit rate (Mbps)
- (C) Video compression format (**HEVC**: H.265/HEVC, **AVC**: H.264/MPEG-4 AVC)

[Switch NTSC/PAL]: [NTSC]					
[Rec Quality]	Resolution	YUV/bit	(A)	(B)	(C)
[4K/10bit/100M/60p]*	3840×2160	4:2:0/10 bit	59.94p	100	HEVC
[4K/8bit/100M/30p]	3840×2160	4:2:0/8 bit	29.97p	100	AVC
[4K/10bit/72M/30p]*	3840×2160	4:2:0/10 bit	29.97p	72	HEVC
[4K/8bit/100M/24p]	3840×2160	4:2:0/8 bit	23.98p	100	AVC
[4K/10bit/72M/24p]*	3840×2160	4:2:0/10 bit	23.98p	72	HEVC
[FHD/8bit/28M/60p]	1920×1080	4:2:0/8 bit	59.94p	28	AVC
[FHD/8bit/20M/30p]	1920×1080	4:2:0/8 bit	29.97p	20	AVC
[FHD/8bit/24M/24p]	1920×1080	4:2:0/8 bit	23.98p	24	AVC

[Switch NTSC/PAL]: [PAL]					
[Rec Quality]	Resolution	YUV/bit	(A)	(B)	(C)
[4K/10bit/100M/50p]*	3840×2160	4:2:0/10 bit	50.00p	100	HEVC
[4K/8bit/100M/25p]	3840×2160	4:2:0/8 bit	25.00p	100	AVC
[4K/10bit/72M/25p]*	3840×2160	4:2:0/10 bit	25.00p	72	HEVC
[FHD/8bit/28M/50p]	1920×1080	4:2:0/8 bit	50.00p	28	AVC
[FHD/8bit/20M/25p]	1920×1080	4:2:0/8 bit	25.00p	20	AVC

* Recording stops when the continuous recording time exceeds 30 minutes.

❖ [Rec. File Format]: [MOV]

- Audio format: LPCM (2ch)

- (A) Recording frame rate
- (B) Bit rate (Mbps)
- (C) Video compression format (**HEVC**: H.265/HEVC, **AVC**: H.264/MPEG-4 AVC)

[Switch NTSC/PAL]: [NTSC]					
[Rec Quality]	Resolution	YUV/bit	(A)	(B)	(C)
[4K/60p/420/10-L]*	3840×2160	4:2:0/10 bit	59.94p	200	HEVC
[4K/60p/420/8-L]*	3840×2160	4:2:0/8 bit	59.94p	150	AVC
[4K/30p/422/10-L]*	3840×2160	4:2:2/10 bit	29.97p	150	AVC
[4K/30p/420/8-L]	3840×2160	4:2:0/8 bit	29.97p	100	AVC
[4K/24p/422/10-L]*	3840×2160	4:2:2/10 bit	23.98p	150	AVC
[4K/24p/420/8-L]	3840×2160	4:2:0/8 bit	23.98p	100	AVC
[FHD/60p/422/10-L]	1920×1080	4:2:2/10 bit	59.94p	100	AVC
[FHD/60p/420/8-L]	1920×1080	4:2:0/8 bit	59.94p	100	AVC
[FHD/30p/422/10-L]	1920×1080	4:2:2/10 bit	29.97p	100	AVC
[FHD/30p/420/8-L]	1920×1080	4:2:0/8 bit	29.97p	100	AVC
[FHD/24p/422/10-L]	1920×1080	4:2:2/10 bit	23.98p	100	AVC
[FHD/24p/420/8-L]	1920×1080	4:2:0/8 bit	23.98p	100	AVC

[Switch NTSC/PAL]: [PAL]					
[Rec Quality]	Resolution	YUV/bit	(A)	(B)	(C)
[4K/50p/420/10-L]*	3840×2160	4:2:0/10 bit	50.00p	200	HEVC
[4K/50p/420/8-L]*	3840×2160	4:2:0/8 bit	50.00p	150	AVC
[4K/25p/422/10-L]*	3840×2160	4:2:2/10 bit	25.00p	150	AVC
[4K/25p/420/8-L]	3840×2160	4:2:0/8 bit	25.00p	100	AVC
[FHD/50p/422/10-L]	1920×1080	4:2:2/10 bit	50.00p	100	AVC
[FHD/50p/420/8-L]	1920×1080	4:2:0/8 bit	50.00p	100	AVC
[FHD/25p/422/10-L]	1920×1080	4:2:2/10 bit	25.00p	100	AVC
[FHD/25p/420/8-L]	1920×1080	4:2:0/8 bit	25.00p	100	AVC

* Recording stops when the continuous recording time exceeds 30 minutes.

- In this document, videos are indicated as follows according to their resolution:
 - 4K (3840×2160) video: **4K video**
 - Full High Definition (1920×1080) video: **FHD video**



- All videos will be recorded using Long GOP to compress the images.
- Since the camera employs the VBR recording format, the bit rate is changed automatically depending on the subject to record. As a result, video recording time is shortened when a fast-moving subject is recorded.
- When using the following function, you can only select 8-bit FHD video:
 - [Miniature Effect] ([Filter Settings])

Time Code

iA P A S M S&Q



When video is recorded in the MOV format, the hour, minute, seconds, and number of frames information (time code) is recorded automatically.

The time code is used to synchronize multiple image and audio sources.

- The time code is not recorded with video in the MP4 format.

Setting the Time Code

Sets the recording, display, and output of the time code.

1 Set [Rec. File Format] to [MOV].

- → → → [Rec. File Format] → [MOV]

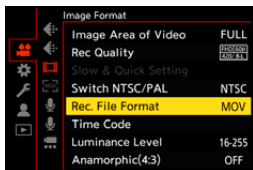

2 Select [Time Code].

- → → → [Time Code]

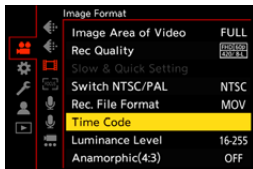

[Time Code Display]	Displays the time code on the recording screen/playback screen.	
[Count Up]	[REC RUN]	Counts the time code only when recording videos.
	[FREE RUN]	Counts the time code also when video recording is stopped and when the camera is turned off.

[Time Code Value]	[Reset]	Sets to 00:00:00:00 (hour: minute: second: frame)
	[Manual Input]	Manually input hour, minute, second and frame.
	[Current Time]	Sets hour, minute and second to current time and sets frame to 00.
[Time Code Mode]	[DF]	Drop Frame. The camera modifies the difference between recorded time and time code. <ul style="list-style-type: none"> Seconds and frames are separated by “.”. (Example: 00:00:00.00)
	[NDF]	Non-Drop Frame. Records the time code without drop frame. <ul style="list-style-type: none"> Seconds and frames are separated by “.”. (Example: 00:00:00:00)
	<ul style="list-style-type: none"> When the following functions are being used, [Time Code Mode] is fixed to [NDF]: <ul style="list-style-type: none"> – [PAL] ([Switch NTSC/PAL]) – 24p [Rec Quality] 	
[HDMI Time Code Output]	<p>Time code information is added to images output via HDMI when recording with the [pM] mode.</p> <ul style="list-style-type: none"> The time code can also be output via HDMI by setting the mode dial to [pM] during playback. In the [Setup] ([IN/OUT]) menu, set [HDMI Mode (Playback)] in [TV Connection] to [AUTO]. (→ 401) The device screen may go dark depending on the connected device. 	

Using AF (Video)

This section describes the use of AF when video recording.

- ➔ In “5. Focus/Zoom”, the functions described work with both pictures and video. Please also refer to that section.
 - Selecting the Focus Mode: ➔ 93
 - Selecting the AF Mode: ➔ 100
 - AF Area Movement Operation: ➔ 115
 - Record Using MF: ➔ 120
 - Recording with Zoom: ➔ 124

[Continuous AF]



You can select how to set the focus in AF when recording videos.

➔ ➔ ➔ Select [Continuous AF]

[MODE1]	The camera continues to automatically focus only during recording.
[MODE2]	<p>The camera automatically keeps focusing on subjects during recording standby and during recording.</p> <ul style="list-style-type: none"> • The camera can keep focusing during recording standby when any of the following are set: <ul style="list-style-type: none"> – [iA/M] mode – [S&Q] mode – [Photo/Video Preview] in the [Custom] ([Monitor / Display]) menu is set to
[OFF]	The camera maintains the focus point at the start of recording.



- In the [iA] mode, the camera automatically keeps focusing during recording standby, irrespective of the [Continuous AF] setting.
- Depending on the recording conditions or lens used, the AF operation sound may be recorded during video recording.
If the operation sound bothers you, we recommend recording with [Continuous AF] set to [OFF].
- If the zoom is operated while recording videos, the subject may take a while to come into focus.
- When the following function is being used, [MODE1] switches to [MODE2]:
 - HDMI output
- [MODE2] does not work during recording standby in the following cases:
 - In preview mode
 - In low light situations

[AF Custom Setting(Video)]



You can fine-adjust the focusing method for video recording using [Continuous AF].

→ → → Select [AF Custom Setting(Video)]

[ON]	Enables the following settings.	
[OFF]	Disables the following settings.	
[SET]	[AF Speed]	<p>[+] side: Focus moves at a faster speed.</p> <p>[-] side: Focus moves at a slower speed.</p>
	[AF Sensitivity]	<p>[+] side: When the distance to the subject changes significantly, the camera immediately readjusts the focus.</p> <p>[-] side: When the distance to the subject changes significantly, the camera waits for a little before readjusting the focus.</p>

Video Brightness and Coloring



This section describes the brightness and coloring settings used during video recording.

- ➔ In “7. Metering/Exposure/ISO Sensitivity” and “8. White Balance/Image Quality”, the functions described work with both pictures and video. Please also refer to those sections.
 - [Metering Mode]: ➔ 184
 - Exposure Compensation: ➔ 196
 - Locking Focus and Exposure (AF/AE Lock): ➔ 198
 - ISO Sensitivity: ➔ 199
 - White Balance (WB): ➔ 202
 - [Photo Style]: ➔ 208
 - [Filter Settings]: ➔ 215

[Luminance Level]



You can set the luminance range to suit the purpose of video recording. You can set to [16-235] or [16-255], the standard for video, or to [0-255], which covers the entire range of luminance, the same as pictures.

 ➔  ➔  ➔ Select [Luminance Level]
Settings: [0-255]/[16-235]/[16-255]

-  • When set to a 10-bit [Rec Quality], the setting items change to [0-1023], [64-940], and [64-1023].
- When [Photo Style] is set to [V-Log], this is fixed to [0-255] ([0-1023]).
- When [Photo Style] is set to [Like2100(HLG)], this is fixed to [64-940].

Recording While Controlling Overexposure (Knee)

iA P A S M S&Q



When [Photo Style] is set to [Like709], you can adjust the knee so that recording can be performed with minimal overexposure.

1 Set [Photo Style] to [Like709].

- → [] → [] → [Photo Style] → [Like709]

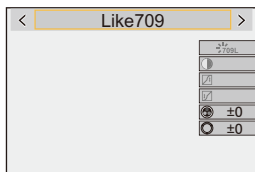

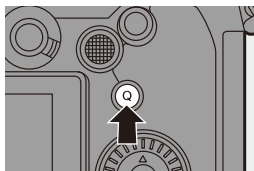

2 Press [Q].

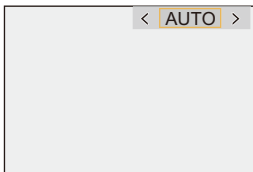

3 Select a knee setting.

- Press ◀▶ to select a setting item.



[AUTO]	Adjusts the compression levels of high-luminance areas automatically.
[MANUAL]	<p>You can set the luminance where compression starts (knee master point) and the intensity of compression (knee master slope).</p> <p>Press ▲▼ to select an item and then press ◀▶ to adjust.</p> <p>[POINT]: Knee master point [SLOPE]: Knee master slope</p> <ul style="list-style-type: none"> • Rotate  to adjust the knee master point, and  to adjust the knee master slope. • Values within the following ranges can be set: <ul style="list-style-type: none"> – Knee master point: 80.0 to 107.0 – Knee master slope: 0 to 99
[Off]	—

4 Confirm your selection.

- Press  or .

[ISO Sensitivity (video)]

iA P A S M  S&Q



Sets the lower and upper limits for ISO sensitivity when ISO sensitivity is set to [AUTO].

- 1 Set the mode dial to [] or [S&Q].

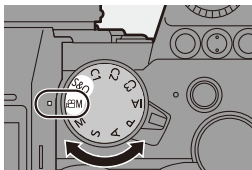

- 2 Set [ISO Sensitivity (video)].

-  → [] → [] → [ISO Sensitivity (video)]

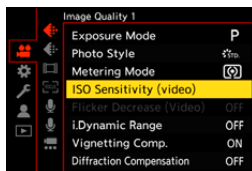

❖ Setting Items ([ISO Sensitivity (video)])

[ISO Auto Lower Limit Setting]	Sets the lower limit for ISO sensitivity when ISO sensitivity is [AUTO]. <ul style="list-style-type: none"> • Set in the range between [100] and [25600].
[ISO Auto Upper Limit Setting]	Sets the upper limit for ISO sensitivity when ISO sensitivity is [AUTO]. <ul style="list-style-type: none"> • Set to [AUTO] or in the range between [200] and [51200].



Audio Settings



iA P A S M  S&Q



This section describes the audio settings used when video recording.

Displaying the [Audio] menu.

-  → [] [Video] menu → [] [Audio]

[Sound Rec Level Disp.]	<p>The sound recording level is displayed on the recording screen.</p> <ul style="list-style-type: none"> • When [Sound Rec Level Limiter] is set to [OFF], [Sound Rec Level Disp.] is fixed to [ON].
[Sound Rec Level Adj.]	<p>Manually adjust the sound recording level.</p> <p>Press ◀▶ to adjust the sound recording level and then press  or .</p> <p>[MUTE]/[-12dB] to [+6dB]</p> <ul style="list-style-type: none"> • You can adjust by 1 dB increments. • Displayed dB values are approximate. • When set to [MUTE], [] is displayed in the recording screen.
[Sound Rec Level Limiter]	<p>The sound recording level is adjusted automatically to minimize sound distortion (crackling noise).</p>
[Wind Noise Canceller]	<p>This reduces the wind noise coming into the built-in microphone while maintaining sound quality.</p> <p>[HIGH]: This effectively reduces the wind noise by reducing the low-pitched sound when a strong wind is detected.</p> <p>[STANDARD]: This reduces wind noise without loss of sound quality by filtering out only wind noise.</p> <p>[OFF]: Turns the function off.</p> <ul style="list-style-type: none"> • You may not see the full effect depending on the recording conditions. • This function works only with the built-in microphone. When an external microphone is connected, [Wind Cut] is displayed. (→ 295)

Main Assist Functions

This section describes the main assist functions that are convenient when recording.

- ➔ The [Custom] ([Monitor / Display (Video)]) menu has display assist functions such as the center marker.
For details, refer to page 392.

[Waveform Monitor]

iA P A S M  S&Q





You can display in the recording screen a waveform.

You can check detailed information about the brightness.

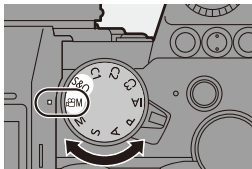
- 1 Set the mode dial to [M] or [S&Q].



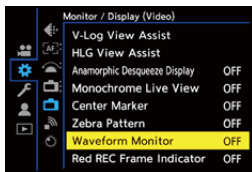

- 2 Set [Waveform Monitor].

-  ➔  ➔  ➔ [Waveform Monitor] ➔ [ON]



3 Select the position to display.

- Press ▲▼◀▶ to select and then press  or .
- You can also move using touch operations.
- To return the waveform or vector scope position back to the center, press [DISP.].

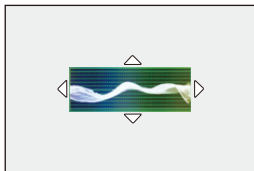

❖ Screen Displays

(%, IRE (Institute of Radio Engineers))



The range between 0 and 100 shows dotted lines at intervals of 10.

* Dotted line

Display example)

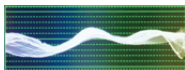

- The waveform displayed on the camera indicates the luminance as values based on the conversions below:

0 % (IRE): Luminance value 16 (8-bit)

100 % (IRE): Luminance value 235 (8-bit)



- You can also change the position by dragging on the recording screen.
- Waveforms cannot be output over HDMI.

[Luminance Spot Meter]

iA P A S M  S&Q









Specify any spot on the subject to measure the luminance over a small area.

1 Set [Luminance Spot Meter].

- Press  → [] → [] → [Luminance Spot Meter] → [ON]



2 Select the position where you want to measure the luminance.

- Press     to select and then press  or .

 Luminance value

- You can also change the position by dragging the frame on the recording screen.
- To return the position back to the center, press [DISP.].

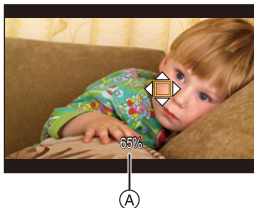

❖ Measurement Range

Measuring is possible in the range -7% to 109% (IRE).

- When [Photo Style] is set to [V-Log], this can be measured with “Stop” units. (Calculated as “0 Stop”= 42% (IRE))

[Zebra Pattern]

iA P A S M  S&Q



Parts that are brighter than the base value are displayed with stripes. You can also set the base value and the breadth of the range so that the stripes are displayed on parts that are within the range of brightness you specify.



[ZEBRA1]



[ZEBRA2]



[ZEBRA1+2]

 ⇒ [] ⇒ [] ⇒ Select [Zebra Pattern]

[ZEBRA1]	Parts that are brighter than the base value are displayed with [ZEBRA1] stripes.		
[ZEBRA2]	Parts that are brighter than the base value are displayed with [ZEBRA2] stripes.		
[ZEBRA1+2]	Both [ZEBRA1] and [ZEBRA2] are displayed.		
[OFF]	—		
[SET]	[Zebra 1]	[50%] to [105%] [BASE/RANGE]	Sets the base brightness.
	[Zebra 2]	[50%] to [105%] [BASE/RANGE]	

❖ When [BASE/RANGE] Was Selected with [SET]

Centered on the brightness set with [Base Level], parts with the brightness in the range set in [Range] are displayed with the stripes.

- [Base Level] can be set in the range between 0 % and 109 % (IRE).
- [Range] can be set in the range between ± 1 % and ± 10 % (IRE).
- When [Photo Style] is set to [V-Log], these are set at "Stop" units.
(Calculated as "0 Stop"=42 % (IRE))



- [ZEBRA1+2] cannot be selected while you are setting [BASE/RANGE].

[Frame Marker]



A frame with the set aspect ratio is displayed on the recording screen. This allows you to see during recording the angle of view that will be achieved with trimming (cropping) in post-processing.



⇒ [] ⇒ [] ⇒ Select [Frame Marker]

[ON]		Displays the Frame Marker on the recording screen.
[OFF]		—
[SET]	[Frame Aspect]	Sets the aspect ratio of the Frame Marker. [2.39:1]/[2.35:1]/[2.00:1]/[1.85:1]/[16:9]/[4:3]/ [5:4]/[1:1]/[4:5]/[9:16]
	[Frame Color]	Sets the color of the Frame Marker.
	[Frame Mask]	Sets the opacity of the outside of the Frame Marker. [100%]/[75%]/[50%]/[25%]/[OFF]

Slow & Quick Video

iA P A S M  S&Q



In the [S&Q] mode, the camera records at a different frame rate to the recording frame rate, enabling the creation of slow motion video and quick motion video in the MP4 format.

<p>Slow Motion Video (Overcrank Recording)</p>	<p>Set a number of frames that is higher than the recording frame rate of the [Rec Quality]. For example: When recording at 60 fps when set to a 30p [Rec Quality], the speed is halved.</p>
<p>Quick Motion Video (Undercrank Recording)</p>	<p>Set a number of frames that is lower than the recording frame rate of the [Rec Quality]. For example: When recording at 15 fps when set to a 30p [Rec Quality], the speed is doubled.</p>

1 Set the mode dial to [S&Q].

- [Rec. File Format] changes to [MP4].

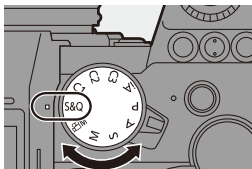



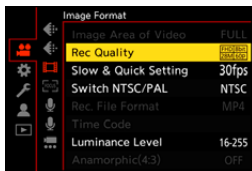

2 Select a recording quality with which you can record Slow & Quick video.

-  →  →  → [Rec Quality]

- Items available for recording with Slow & Quick video are indicated as [S&Q available].
- Recording qualities with which you can record Slow & Quick video: → 287



3 Set the frame rate.

- Press **MENU/SET** → [] → [] → [Slow & Quick Setting]
- Rotate ,  or  to select a numeric value, then press **MENU/SET** or .

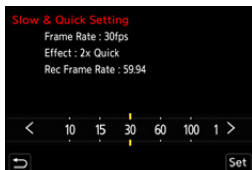

- You can set a frame rate in the following ranges:
 - 4K video: 1 fps to 60 fps
 - FHD video: 1 fps to 180 fps

❖ Frame Rate Combinations and Playback Speeds

Frame rate	[Switch NTSC/PAL]: [NTSC]				
	4K/30p	4K/24p	FHD/60p	FHD/30p	FHD/24p
180 fps	—	—	3× Slow	6× Slow	7.5× Slow
150 fps	—	—	2.5× Slow	5× Slow	6.25× Slow
120 fps	—	—	2× Slow	4× Slow	5× Slow
100 fps	—	—	1.67× Slow	3.33× Slow	4.17× Slow
60 fps	2× Slow	2.5× Slow	1× Normal	2× Slow	2.5× Slow
30 fps	1× Normal	1.25× Slow	2× Quick	1× Normal	1.25× Slow
15 fps	2× Quick	1.6× Quick	4× Quick	2× Quick	1.6× Quick
10 fps	3× Quick	2.4× Quick	6× Quick	3× Quick	2.4× Quick
5 fps	6× Quick	4.8× Quick	12× Quick	6× Quick	4.8× Quick
2 fps	15× Quick	12× Quick	30× Quick	15× Quick	12× Quick
1 fps	30× Quick	24× Quick	60× Quick	30× Quick	24× Quick

Frame rate	[Switch NTSC/PAL]: [PAL]		
	4K/25p	FHD/50p	FHD/25p
180 fps	—	3.6× Slow	7.2× Slow
150 fps	—	3× Slow	6× Slow
120 fps	—	2.4× Slow	4.8× Slow
100 fps	—	2× Slow	4× Slow
60 fps	2.4× Slow	1.2× Slow	2.4× Slow
30 fps	1.2× Slow	1.67× Quick	1.2× Slow
15 fps	1.67× Quick	3.33× Quick	1.67× Quick
10 fps	2.5× Quick	5× Quick	2.5× Quick
5 fps	5× Quick	10× Quick	5× Quick
2 fps	12.5× Quick	25× Quick	12.5× Quick
1 fps	25× Quick	50× Quick	25× Quick



- Audio will not be recorded during Slow & Quick recording.
- When [Rec Quality] is set to [4K], [Image Area of Video] is fixed to [APS-C].
- When [Rec Quality] is set to [FHD], [Image Area of Video] is fixed to [FULL].
- The mode switches to MF when you set to a frame rate of 150 fps or more.
- The angle of view is reduced when you set the frame rate to 180 fps.
- Recording stops when the continuous recording time exceeds 30 minutes.

[Live Cropping]

iA P A S M  S&Q



By cropping a part of the image from the image displayed in the live view, it is possible to record FHD video that incorporates panning and zooming with the camera staying in a fixed position.



Pan

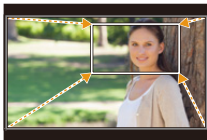

Zoom in



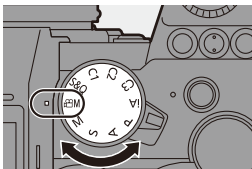

- Use a tripod to minimize camera shake.

1 Set the mode dial to [S&M].



2 Set [Rec. File Format] to [MP4] or [MOV].

-  →  →  → [Rec. File Format] → [MP4]/[MOV]

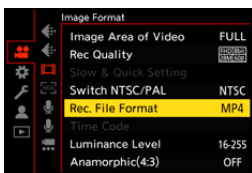

3 Select a recording quality with which you can record [Live Cropping] video.

- **MENU/SET** → [] → [] → [Rec Quality]

- A recording quality with which you can record [Live Cropping] video: → 287

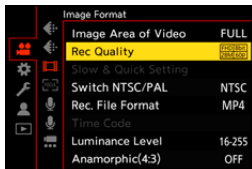

4 Set the time for panning or zooming.

- **MENU/SET** → [] → [] → [Live Cropping] → [40SEC]/[20SEC]

- If you have selected a recording quality where Live Cropping recording is not available, the camera switches to an FHD video recording quality where recording is possible. (→ 287)



5 Set the cropping start frame (A).

- Select the range to be cropped and press **MENU/SET** or **DISP.**.

6 Set the cropping end frame (B).

- Select the range to be cropped and press **MENU/SET** or **DISP.**.

- To redo the settings for the position and size of the start frame and the end frame, press **DISP.**.

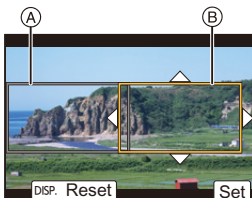



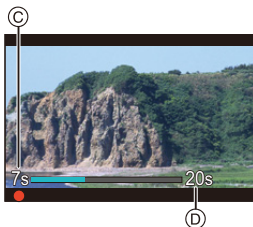
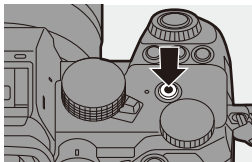

7 Start Live Cropping recording.



- Press the video rec. button.
 - Ⓒ Elapsed recording time
 - Ⓓ Set operating time
- When the set operating time has elapsed, recording automatically ends.
To end recording midway, press the video rec. button again.



❖ Operations for Setting the Cropping Frame

Button operation	Touch operation	Description of operation
	Touch	Moves the frame.
	Pinch out/ pinch in	Enlarges/reduces the frame in small steps.
	—	Enlarges/reduces the frame.
[DISP.]	[Reset]	Start frame: Returns the frame position and size to the default settings. End frame: Cancels the settings for the position and size of the frame.
	[Set]	Confirms the frame position and size.



- AF mode switches to [] (face detection). (Human bodies cannot be detected. It is not possible to specify the person to bring into focus.)
- Brightness measurements and focusing are performed within the cropping frame. To lock the focus point, set [Continuous AF] to [OFF], or set the focus mode to [MF].
- [Metering Mode] will be [] (multi-metering).

Log Recording

iA P A S M  S&Q



Setting [Photo Style] to [V-Log] enables Log recording.

Images finished with rich gradation can be created through post-production processing.

 → [] → [] → [Photo Style] → Select [V-Log]



- Post-production processing is enabled by utilizing LUT (Look-Up Table). You can download LUT data from the following support site:
<https://panasonic.jp/support/global/cs/dsc/download/index3.html>
(English only)

❖ ISO Sensitivity When [V-Log] Is Set

The lower limit of available ISO sensitivity is [640] (when [Extended ISO] is set: [320]), and the upper limit is [51200].

❖ Exposure When [V-Log] Is Set

The [V-Log] curve characteristics comply with “V-Log/V-Gamut REFERENCE MANUAL Rev.1.0”. When set to [V-Log], the standard exposure when gray with a reflectance ratio of 18 % is imaged is IRE 42 %.

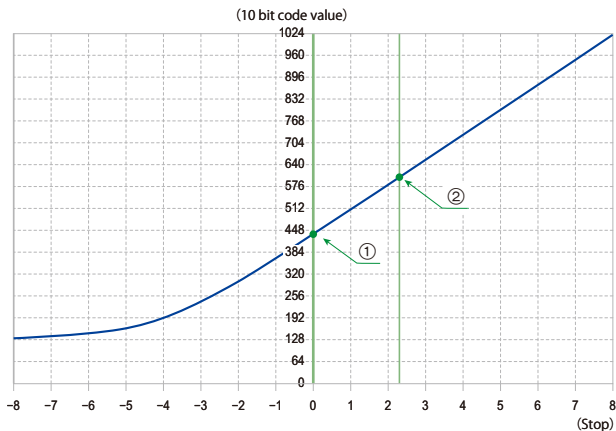

When [Photo Style] is set to [V-Log]

Reflectance ratio (%)	IRE (%)	Stop	10 bit code value	12 bit code value
0	7.3	—	128	512
① 18	42	0.0	433	1732
② 90	61	2.3	602	2408

- When luminance is to be displayed by “Stop” units, this camera calculates IRE 42 % to “0 Stop”.



- Luminance can be checked by “Stop” units:

[⚙️] → [📷] → [Luminance Spot Meter] (→ 266)

[⚙️] → [📷] → [Zebra Pattern] (→ 267)

[V-Log View Assist]

When [Photo Style] is set to [V-Log], the recording screen and images output via HDMI will darken. Using [V-Log View Assist] means you can show images with LUT data applied on the monitor/viewfinder and output them via HDMI.

 ⇒  ⇒  ⇒ Select [V-Log View Assist]

[Read LUT File]	Reads LUT data from the card.
[LUT Select]	Selects the LUT data to be applied from among the preset ([Vlog_709]) and registered LUT data.
[LUT View Assist (Monitor)]	Displays the images with LUT data applied on the monitor/viewfinder of the camera.
[LUT View Assist (HDMI)]	Applies LUT data to images output over HDMI.









- When applying the LUT data, [LUT] is displayed on the recording screen.
- Up to 4 LUT data files can be registered.

❖ Reading LUT Files



- The following LUT data can be used:
 - The “.vlt” format, which meets the requirements specified in the “VARICAM 3DLUT REFERENCE MANUAL Rev.1.0”
 - File names consisting of up to 8 alphanumeric characters (excluding extension)
- Save the LUT data with a file extension of “.vlt” in the root directory of the card (the folder opened when the card is opened on a PC).

- 1 Insert a card on which LUT data is saved into the camera.
- 2 Select [Read LUT File].
 -  ⇒ [] ⇒ [] ⇒ [V-Log View Assist] ⇒ [Read LUT File] ⇒ [Card Slot 1]/[Card Slot 2]
- 3 Press ▲▼ to select the LUT data to read and then press  or  .
- 4 Press ▲▼ to select the location to register the data, and then press  or  .
 - When registered items are selected, they will be overwritten.

HLG Videos

iA P A S M  S&Q



Record videos with the wide dynamic range of the HLG format. You can record in very bright light where overexposure can occur or in dark areas where underexposure can occur, maintaining the rich yet subtle colors you can see with your naked eye.



You can view the video that you record by outputting via HDMI to devices (TVs, etc.) that support the HLG format, or playing back directly on supporting devices.

- "HLG (Hybrid Log Gamma)" is an international standard (ITU-R BT.2100) HDR format.

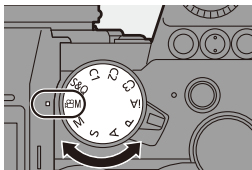
1 Set the mode dial to [S&Q].



2 Set [Rec. File Format] to [MP4] or [MOV].

-  →  →  → [Rec. File Format] → [MP4]/[MOV]

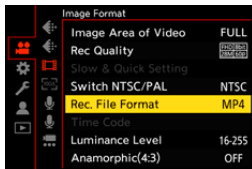

3 Select a recording quality with which you can record HLG video.

- **MENU/SET** → [] → [] → [Rec Quality]

- Items available for recording with HLG video are indicated as [HLG available].
- Recording qualities with which you can record HLG video: → 287

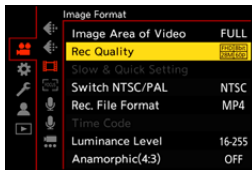

4 Set [Photo Style] to [Like2100(HLG)].

- **MENU/SET** → [] → [] → [Photo Style] → [Like2100(HLG)]

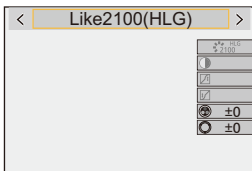

- The monitor and viewfinder on this camera do not support display of HLG format images. With [Monitor] in [HLG View Assist] in the [Custom] ([Monitor / Display (Video)]) menu, you can display the images converted for monitoring on the monitor/viewfinder of this camera. (→ 282)



- HLG images are shown dark on devices that do not support the HLG format. With [HDMI] in [HLG View Assist] in the [Custom] ([Monitor / Display (Video)]) menu, you can set the conversion method for images displayed for monitoring. (→ 282)

❖ ISO Sensitivity When [Like2100(HLG)] Is Set

The lower limit of available ISO sensitivities will become [400].

[HLG View Assist]

At recording or playback of [HLG Photo] and HLG video, this displays images with converted color gamut and brightness on the camera monitor/viewfinder, or outputs these over HDMI.

 ⇒ [] ⇒ [] ⇒ [HLG View Assist] ⇒ [Monitor] or [HDMI]

[AUTO]*	Converts images before outputting them via HDMI while applying the effect of [MODE2]. This conversion setting works only when the camera is connected to a device that does not support HDR (HLG format).
[MODE1]	Converts with an emphasis on bright areas such as sky. • [MODE1] is displayed on the recording screen.
[MODE2]	Converts with an emphasis on the brightness of a main subject. • [MODE2] is displayed on the recording screen.
[OFF]	Displays without converting color gamut and brightness. • HLG images appear darker on devices that do not support the HLG format.

* Can only be set while [HDMI] is selected.

Anamorphic Recording

iA P A S M S&Q



This camera can record video with a resolution of 4K-A (anamorphic (4:3) video) that is compatible with anamorphic recording with an aspect ratio of 4:3.

Along with the normal 16:9 video aspect ratio, you can select the recording quality suited to anamorphic recording.

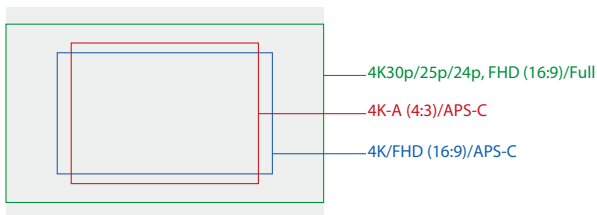

- The above shows some of the recording qualities available when a full-frame lens is attached.
Refer to page [250](#) for details about 16:9 recording quality.

During anamorphic recording, it is also possible to display desqueezed images and the angle of view when cropping after desqueeze editing. It is also possible to switch to an image stabilizer that suits anamorphic recording.

- This camera is not compatible with desqueeze editing of video recorded with anamorphic recording. Use compatible software.
- Refer to page [182](#) for information about image stabilizers suited to anamorphic recording.

[Anamorphic(4:3)]

iA P A S M  S&Q



You can record video with an aspect ratio of 4:3 and 4K-A resolution compatible with anamorphic recording.

1 Set the mode dial to [].

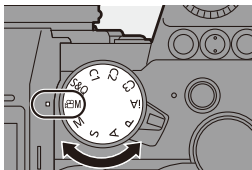

2 Set the image quality for [Anamorphic(4:3)].

•  → [] → [] →
[Anamorphic(4:3)]

- [Rec. File Format] changes to [MOV].

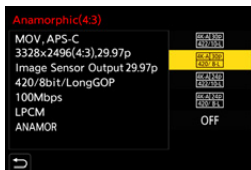

❖ Setting Items ([Anamorphic(4:3)])

- Audio format: LPCM (2ch)

- (A) Recording frame rate
- (B) Bit rate (Mbps)
- (C) Video compression format (**HEVC**: H.265/HEVC, **AVC**: H.264/MPEG-4 AVC)

[Switch NTSC/PAL]: [NTSC]					
[Rec Quality]	Resolution	YUV/bit	(A)	(B)	(C)
[4K-A/30p/422/10-L]*	3328×2496	4:2:2/10 bit	29.97p	150	AVC
[4K-A/30p/420/8-L]	3328×2496	4:2:0/8 bit	29.97p	100	AVC
[4K-A/24p/422/10-L]*	3328×2496	4:2:2/10 bit	23.98p	150	AVC
[4K-A/24p/420/8-L]	3328×2496	4:2:0/8 bit	23.98p	100	AVC
[OFF]	—				

[Switch NTSC/PAL]: [PAL]					
[Rec Quality]	Resolution	YUV/bit	(A)	(B)	(C)
[4K-A/50p/420/10-L]*	3328×2496	4:2:0/10 bit	50.00p	200	HEVC
[4K-A/50p/420/8-L]*	3328×2496	4:2:0/8 bit	50.00p	150	AVC
[4K-A/25p/422/10-L]*	3328×2496	4:2:2/10 bit	25.00p	150	AVC
[4K-A/25p/420/8-L]	3328×2496	4:2:0/8 bit	25.00p	100	AVC
[OFF]	—				

* Recording stops when the continuous recording time exceeds 30 minutes.



- All videos will be recorded using Long GOP to compress the images.
- Use a UHS Speed Class 3 or higher card when recording.

[Anamorphic Desqueeze Display]

iA P A S M  S&Q





Display the desqueezed images suited to the magnification of the anamorphic lens on this camera.



Using the [Frame Marker], it is also possible to superimpose on display the frame of the angle of view when cropping after desqueeze editing.



1 Set the mode dial to [] or [S&Q].



2 Set [Anamorphic Desqueeze Display].



-  → [] → [] → [Anamorphic Desqueeze Display]

Settings: [] [] ([2.0×])/

[] [] ([1.8×])/



[] [] ([1.5×])/

[] [] ([1.33×])/

[] [] ([1.30×])/[OFF]

- Make settings to suit the magnification of the anamorphic lens you are using.

3 Set [Frame Marker].

-  → [] → [] → [Frame Marker]

- For details, refer to page 268.

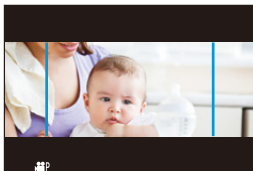

- Images output via HDMI are not desqueezed.

List of Recording Qualities That Enable Special Videos to be Recorded

S&Q : Recording qualities with which you can record Slow & Quick video

Live Crop : Recording qualities that enable use of [Live Cropping]

HLG : Recording qualities with which you can record HLG video

❖ [Rec. File Format]: [MP4]

[Switch NTSC/PAL]	[Rec Quality]	S&Q	Live Crop	HLG
[NTSC]	[4K/10bit/100M/60p]			✓
	[4K/8bit/100M/30p]	✓		
	[4K/10bit/72M/30p]			✓
	[4K/8bit/100M/24p]	✓		
	[4K/10bit/72M/24p]			✓
	[FHD/8bit/28M/60p]	✓	✓	
	[FHD/8bit/20M/30p]	✓	✓	
	[FHD/8bit/24M/24p]	✓		
[PAL]	[4K/10bit/100M/50p]			✓
	[4K/8bit/100M/25p]	✓		
	[4K/10bit/72M/25p]			✓
	[FHD/8bit/28M/50p]	✓	✓	
	[FHD/8bit/20M/25p]	✓	✓	

❖ [Rec. File Format]: [MOV]

[Switch NTSC/PAL]	[Rec Quality]	S&Q	Live Crop	HLG
[NTSC]	[4K/60p/420/10-L]			✓
	[4K/60p/420/8-L]			
	[4K/30p/422/10-L]			✓
	[4K/30p/420/8-L]			
	[4K/24p/422/10-L]			✓
	[4K/24p/420/8-L]			
	[FHD/60p/422/10-L]		✓	✓
	[FHD/60p/420/8-L]		✓	
	[FHD/30p/422/10-L]		✓	✓
	[FHD/30p/420/8-L]		✓	
	[FHD/24p/422/10-L]			✓
	[FHD/24p/420/8-L]			
[PAL]	[4K/50p/420/10-L]			✓
	[4K/50p/420/8-L]			
	[4K/25p/422/10-L]			✓
	[4K/25p/420/8-L]			
	[FHD/50p/422/10-L]		✓	✓
	[FHD/50p/420/8-L]		✓	
	[FHD/25p/422/10-L]		✓	✓
	[FHD/25p/420/8-L]		✓	

11. Connections with External Devices (Video)

HDMI Devices (HDMI Output)

iA P A S M  S&Q



You can record while outputting the camera images to an external monitor or external recorder connected with an HDMI micro cable.

- HDMI output control differs between during recording and during playback.
Refer to page 401 for HDMI output settings during playback.

Getting started:

- Turn off the camera and the external monitor/external recorder.

Connect the camera and an external monitor or external recorder with a commercially available HDMI micro cable.

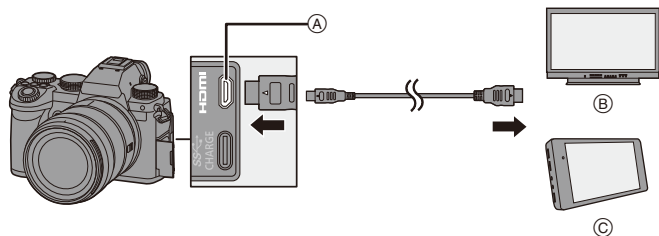

(A) [HDMI] socket (Type D)

(C) External recorder

(B) External monitor

- Check the direction of the terminals and plug in/out straight holding onto the plug.
(Inserting at an angle can deform the terminal and cause malfunction.)
- Do not connect the cable to the wrong terminals. This may cause a malfunction.



- Use a “High Speed HDMI micro cable” with the HDMI logo. Cables that do not comply with the HDMI standards will not work. “High Speed HDMI micro cable” (Type D–Type A plug, up to 2 m (6.6 feet) long)

Images Output via HDMI

The images output via HDMI differ depending on the recording mode.

❖ [M]/[S&Q] Mode

Resolution and frame rate output is according to the [Rec Quality] settings in the [Video] ([Image Format]) menu.

The YUV and bit value are output with YUV changed to 4:2:2 as shown at right.



If the connected device is not compatible with the output system, output changes to match the connected device.

Recording to card	HDMI output
4:2:2 10-bit	4:2:2 10-bit
4:2:0 10-bit	4:2:2 10-bit
4:2:0 8-bit	4:2:2 8-bit



- Anamorphic (4:3) video is output with a 16:9 aspect ratio with bands added to the images.

❖ [iA]/[P]/[A]/[S]/[M] Mode

While recording video or when [Photo/Video Preview] is set to [], output is the same as []/[S&Q] mode.

Output is with a 16:9 aspect ratio during recording standby. Resolution, frame rate, YUV, and bit value output matches the connected device.



- When set to any [Aspect Ratio] other than 16:9, bands are added to the images and they are output with a 16:9 aspect ratio.

❖ Notice Regarding HDMI Output



- It may take some time for the output method to change.
- When you use the HDMI output during recording, the image may be displayed with a time lag.
- Beep sounds, AF beep, and electronic shutter sounds are muted during HDMI output.
- When you check the image and audio from the TV connected to the camera, the microphone of the camera may pick up the sound from the speakers of the TV, producing an abnormal sound (audio feedback).
If this occurs, move the camera away from the TV or lower the volume on the TV.
- Certain setting screens are not output via HDMI.
- There is no output via HDMI while you are recording with the following functions:
 - [6K/4K PHOTO]/[Post-Focus]
- If the temperature of the camera rises, [] may be displayed, recording may stop, and some functions may become unavailable temporarily. Wait until the camera cools down.



[HDMI Rec Output]

iA P A S M  S&Q



Sets HDMI output during recording.

 →  →  → Select [HDMI Rec Output]

[Info Display]	Output the camera information display to an external device connected by HDMI.
[HDMI Recording Control]	<p>Recording start and stop control information is output to an external recorder connected by HDMI.</p> <ul style="list-style-type: none"> • [HDMI Recording Control] can be set when [HDMI Time Code Output] is set to [ON] in [] mode. • Control information is output when pressing the video rec. button or shutter button, even if the video cannot be recorded (such as when there is no card inserted into the camera). • Only compatible external devices can be controlled.
[4K/60p Bit Mode]/ [4K/50p Bit Mode]	<p>In the [] mode, setting of output bit value for images output over HDMI is possible for 4K/60p or 4K/50p video.</p> <p>[4:2:2 10bit]/[4:2:0 8bit]</p> <ul style="list-style-type: none"> • The menu name changes according to the [Switch NTSC/PAL] setting. • This works in the [] mode, when set to [Rec Quality] of 4K/60p or 4K/50p, and outputting over HDMI. • When using HDMI output for 4K/60p/4:2:2 10-bit or 4K/50p/4:2:2 10-bit images, video cannot be recorded to a card. • When using HDMI output for HLG video, during HDMI output of 4K/60p/4:2:2 10-bit or 4K/50p/4:2:2 10-bit images, from the [Video] ([Image Quality]) menu, set [Photo Style] to [Like2100(HLG)].
[Sound Output (HDMI)]	Output audio to an external device connected by HDMI.

External Microphones (Optional)

iA P A S M  S&Q





With a Stereo Shotgun Microphone (DMW-MS2: optional) or Stereo Microphone (VW-VMS10: optional), you can record higher-quality audio compared to the built-in microphone.

1 Set the [Mic Socket] that suits the device to be connected.

-  ⇒ [] ⇒ [] ⇒ [Mic Socket]

MIC  [Mic Input (Plug-in Power)]	When connecting an external microphone that requires a power supply from the camera [MIC] socket.
MIC [Mic Input]	When connecting an external microphone that does not require a power supply from the camera [MIC] socket.
LINE [Line Input]	When connecting an external audio device for line output.

- The setting will be fixed to [MIC] when a Stereo Shotgun Microphone (DMW-MS2: optional) is connected.
- When using [MIC], if you connect an external microphone that does not require power supply, the connected external microphone may malfunction. Check the device before connecting.

2 Set the camera on/off switch to [OFF].

3 Connect the camera and external microphone.

- If mounting the external microphone on the camera hot shoe (A), remove the hot shoe cover. (→ 227)

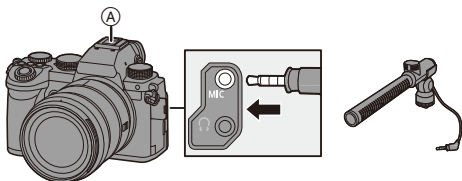

- Do not use the stereo microphone cables with the length of 3 m (9.8 feet) or more.

❖ Setting the Sound Pickup Range (DMW-MS2: Optional)

When using the Stereo Shotgun Microphone (DMW-MS2: optional), you can set the microphone sound pickup range.

1 Select [Special Mic.].

- → [] → [] → [Special Mic.]

[STEREO]	Picks up sound over a wide area.
[LENS AUTO]	Picks up sound from a range automatically set by the lens angle of view.
[SHOTGUN]	Helps prevent picking up background noise, and records sound from a specific direction.
[S.SHOTGUN]	Narrows the sound pickup range more than with [SHOTGUN].
[MANUAL]	Sets the range manually for sound pickup.

2 (When [MANUAL] is selected)

Press ◀▶ to adjust the sound pickup range and then press or



❖ Reduction of Wind Noise

This reduces wind noise when an external microphone is connected.

 ⇒ [] ⇒ [] ⇒ Select [Wind Cut]

Settings: [HIGH]/[STANDARD]/[LOW]/[OFF]



- While the external microphone is connected, [EXT] is displayed on the screen.
- When an external microphone is connected, [Sound Rec Level Disp.] automatically turns [ON], and the recording level is displayed on the screen.
- When the external microphone is attached, do not carry the camera by holding the external microphone. It may become detached.
- If noises are recorded when using the AC adaptor, use the battery.
- Setting [Wind Cut] may alter the usual sound quality.
- For details, refer to the operating instructions for the external microphone.

XLR Microphone Adaptor (Optional)

iA P A S M S&Q



By attaching an XLR Microphone Adaptor (DMW-XLR1: optional) to the camera, you can use a commercially available XLR microphone to enable the recording of superior-quality stereo audio.

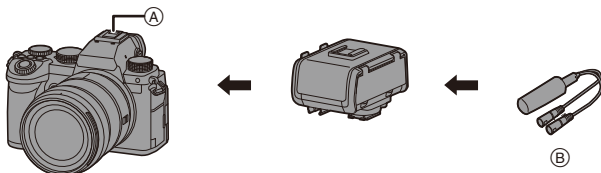

- Ⓐ Hot shoe
- Ⓑ Commercially available XLR microphone

Getting started:

- Turn off the camera, and remove the hot shoe cover. (→ [227](#))

Attach the XLR Microphone Adaptor to the hot shoe, and then turn on the camera.

- When the XLR Microphone Adaptor is attached, [XLR Mic Adaptor Setting] automatically turns [ON].

[ON]	Records audio using the XLR microphone.
[OFF]	Records audio using the built-in microphone of the camera.



- While an XLR Microphone Adaptor is attached, [XLR] is displayed on the screen.
- When [XLR Mic Adaptor Setting] is set to [ON], the following settings are fixed:
 - [Sound Rec Level Limiter]: [OFF]
 - [Wind Noise Canceller]: [OFF]
 - [Sound Output]: [REC SOUND]
- [Sound Rec Level Adj.] cannot be used when [XLR Mic Adaptor Setting] is set to [ON].
- When the XLR Microphone Adaptor is attached, [Sound Rec Level Disp.] automatically turns [ON], and the recording level is displayed on the screen.
- When the XLR Microphone Adaptor is attached, do not carry the camera by holding the XLR Microphone Adaptor. It may become detached.
- If noises are recorded when using the AC adaptor, use the battery.
- For details, refer to the operating instructions for the XLR Microphone Adaptor.

Headphones

iA P A S M  S&Q

You can record videos while monitoring their sound by connecting commercially available headphones to the camera.

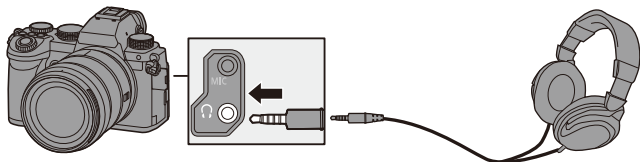

- Do not use the headphone cables with the length of 3 m (9.8 feet) or more.
- When headphones are connected, beep sounds, AF beep, and electronic shutter sounds are muted.

❖ Switching the Sound Output Method

 ⇒ [] ⇒ [] ⇒ Select [Sound Output]

[REALTIME]	Audio without time lag. It may differ from the sound recorded in videos.
[REC SOUND]	Audio to be recorded in videos. Output sound may be delayed from actual sound.





- The setting is fixed to [REC SOUND] in the following cases:
 - During output of audio via HDMI
 - When [Special Mic.] is set to [LENS AUTO], [SHOTGUN], [S.SHOTGUN], or [MANUAL]
 - When using an XLR Microphone Adaptor (DMW-XLR1: optional)

❖ Adjusting the Headphone Volume

Connect the headphones and rotate .



: Reduces the volume.





: Increases the volume.

- You can also adjust the volume by touching []/[] on the playback screen.

To adjust the volume using the menu:

❶ Select [Headphone Volume].

-  ⇒ [] ⇒ [] ⇒ [Headphone Volume]

❷ Press   to adjust the headphone volume and then press  or .

- It can be adjusted in a range of [0] to [LEVEL15].

12. Playing Back and Editing of Images

This chapter explains how to play back and delete pictures and videos. It also explains editing using [RAW Processing] (→ 312) and [Video Divide] (→ 318).



- Images recorded on devices other than this one may not be played back or edited correctly on this camera.



- For [Playback] menus other than [RAW Processing] and [Video Divide], refer to “[Playback] Menu” beginning on page 406.

Playing Back Pictures

1 Display the playback screen.

- Press [▶].

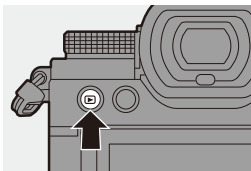

2 Select a picture.

- Select the pictures by pressing ◀▶.
- You can move continuously through images by pressing and holding ▶.
- You can also select by rotating 🌅 or ⚙️.
- You can also move through images by dragging the screen horizontally. By leaving your finger touching the left or right edge of the screen after dragging to change the image, you can continuously move through images.



(A) Card slot

3 Stop playback.

- Press the shutter button halfway.
- You can also stop playback by pressing [▶].

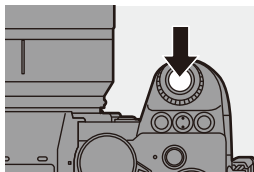



❖ Switching the Card to Display

You can switch the card displayed just by pressing [] during playback.

- You can also perform the same operation by pressing the Fn button assigned with [Card Slot Change].

For information about the Fn button, refer to page [321](#).

- 1 Press [].
- 2 Press ▲▼ to select [Card Slot 1] or [Card Slot 2] and then press  or  .

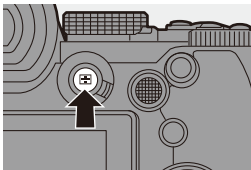

- This camera complies with the “Design rule for Camera File system” (DCF) and “Exchangeable Image File Format” (Exif) standards established by “Japan Electronics and Information Technology Industries Association” (JEITA). The camera cannot play back files that do not comply with the DCF standard. Exif is a file format for pictures which allows recording information, etc. to be added.

Playing Back Videos

1 Display the playback screen.

- Press [▶].

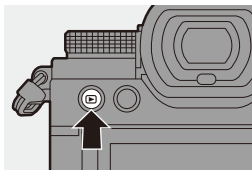

2 Select a video.

- For information about how to select images, refer to page 301.
- The [👤] video icon is displayed for a video.
- The video recording time (A) is displayed on the screen.

Example) When 8 minutes 30 seconds:
8m30s

- h: hour, m: minute, s: second

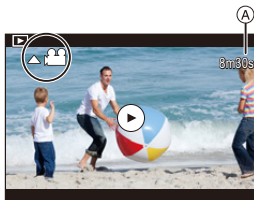

3 Play back the video.

- Press ▲.
- You can also start playback by touching [▶] at the center of the screen.

(B) Elapsed playback time



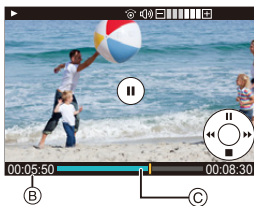

(C) Playback bar

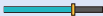

4 Stop playback.

- Press ▼.

❖ Operations During Video Playback

Button operation	Touch operation	Description of operation
▲		Plays/pauses.
▼	—	Stops.
◀	—	Performs fast-rewind playback. <ul style="list-style-type: none"> If you press ◀ again, the fast-rewind speed increases.
		Performs frame-by-frame rewinding (while paused).
▶	—	Performs fast-forward playback. <ul style="list-style-type: none"> If you press ▶ again, the fast-forward speed increases.
		Performs frame-by-frame forwarding (while paused).
—		Selects the frame to display.
 / 	<input type="text" value="Save"/>	Extracts a picture (while paused). (→ 305)
	<input type="text" value="−"/>	Reduces the volume.
	<input type="text" value="+"/>	Increases the volume.



- The camera can play back videos in MP4 and MOV formats.
- To play back videos on a PC, use the “PHOTOfunSTUDIO” software.

Extracting a Picture



Extract one frame of a video and save it as a JPEG image.

1 Pause playback at the position you wish to extract a picture.

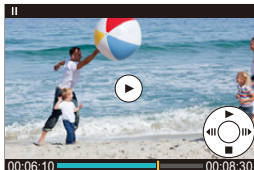
- Press ▲.
- To fine-adjust the position, press ◀▶ (rewind frame-by-frame or forward frame-by-frame).



2 Save the picture.

- Press  or .
- You can also save the picture by touching [Save].



- The picture created from the video is saved with a [FINE] picture quality. The picture is saved with a size according to the resolution of the [Rec Quality].
- The image quality of a picture created from a video may be coarser than normal.
-  is displayed on the detailed information display screen for a picture created from a video.

Switching the Display Mode





You can use features to do things like enlarge recorded images for display and switch to thumbnail display to display multiple images at once (multi-playback).

You can also switch to calendar display to show images of a selected recording date.

Enlarged Display



Playback images can be displayed enlarged (Playback Zoom).

Enlarging the playback screen.

- Rotate  to the right.
- The playback screen is enlarged in the order of 2×  4×  8×  16×.
- Rotating  to the left returns to the previous display size.
- Pictures taken with [Picture Quality] set to [RAW] cannot be displayed enlarged at 16×. (Excluding pictures recorded with the [Picture Quality] in [High Resolution Mode] set to [RAW])





❖ Operations During Enlarged Display

Button operation	Touch operation	Description of operation
	—	Enlarges/reduces the screen.
—	Pinch out/ pinch in	Enlarges/reduces the screen in small steps.
	Drag	Moves the enlarged display position.
	—	Forwards or rewinds images while maintaining the same zoom magnification and zoom position.



- You can display the point focused with AF. You can enlarge the display from that point:



[] ⇒ [] ⇒ [Magnify from AF Point] (→ 408)

Thumbnail Screen

1 Switch to thumbnail display.

- Rotate  to the left.
- The display is switched in the order of 12-image screen \rightleftarrows 30-image screen.

(A) Card

- Rotating  to the left during 30-image screen display switches to calendar display. (\rightarrow 309)
- Rotating  to the right returns to the previous display.
- You can also switch the display by touching an icon.

[]: 1-image screen



[]: 12-image screen

[]: 30-image screen

[]: Calendar (\rightarrow 309)



2 Select an image.

- Press $\blacktriangle \blacktriangledown \blacktriangleleft \blacktriangleright$ to select an image and then press  or .



- When you press [] while a thumbnail is being displayed, you can switch to the card being displayed.
- You can scroll the screen by dragging the thumbnail display up or down.



- Images indicated with [] cannot be played back.

Calendar Playback





1 Switch to calendar playback.

- Rotate  to the left.
- The display is switched in the order of thumbnail screen (12 images)
 - ⇒ Thumbnail screen (30 images)
 - ⇒ Calendar playback.









- Rotating  to the right returns to the previous display.

2 Select the recording date.

- Press    to select a date and then press  or .

3 Select an image.

- Press    to select an image and then press  or .
- Rotating  to the left returns to calendar playback.



- The card to display cannot be switched during calendar display.
- The range that the calendar can be displayed is January 2000 to December 2099.

Group Images

Images recorded with Time Lapse Shot or Stop Motion Shooting are handled as group images in the camera, and can be deleted and edited on a group basis.

(For example, if you delete a group image, all images in the group are deleted.)

You can also delete and edit each image in a group individually.

❖ Images Handled as Group Images by the Camera

	Group images saved with [6K/4K PHOTO Bulk Saving].
	Group images recorded with Focus Bracket.
	Group images recorded with Time Lapse Shot.
	Group images recorded with Stop Motion Shooting.

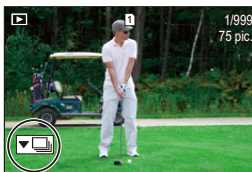





❖ Playing and Editing the Images in a Group One by One

Operations such as displaying thumbnails and deleting images are available with images in groups just as with normal playback.





- 1 Select the group image in the playback state. (→ 301)
- 2 Press ▼ to display the images in the group.
 - You can also perform the same operation by touching the group image icon.
- 3 Press ◀▶ to select an image.
 - To return to the normal playback screen, press ▼ or touch [▶▼] again.



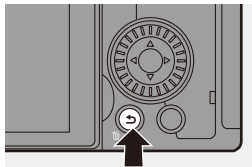





Deleting Images

-  • Images cannot be restored once they have been deleted. Carefully confirm the images before deletion.
- You can only delete the images in the card of the selected card slot.
- If you delete a group image, all images in the group are deleted.

- 1** Press [] in playback state.
- 2** Press **▲▼** to select the deletion method and then press  or .



[Delete Single]	Deletes the selected image.
[Delete Multi]	<p>Selecting and deleting multiple images.</p> <ol style="list-style-type: none"> 1 Press ▲▼◀▶ to select the image to delete and then press  or . <ul style="list-style-type: none"> • [] is displayed for the selected image. • If you press  or  again, the selection is canceled. • Up to 100 images can be selected. 2 Press [DISP.] to delete the selected image.

-  • To switch the card selected for deleting images, press [] and then select the card slot.
-  • Depending on the number of images to be deleted, it may take some time to delete them.
-  • You can set which of [Yes] and [No] is selected initially in the confirmation screen when deleting:
 - [] ⇒ [] ⇒ [Delete Confirmation] (→ 414)
- All images on the card can be deleted:
 - [] ⇒ [] ⇒ [Delete All Images] (→ 414)

[RAW Processing]

This processes pictures taken in RAW format on the camera and saves them in JPEG format.

You can also save images recorded with [HLG Photo] in the RAW format as HLG format.

1 Select [RAW Processing].

- Press **MENU/SET** → [] → [] → [RAW Processing]



2 Select the RAW image.

- Press ◀▶ to select an image and then press **MENU/SET** or .
- When group images are selected, press ▼ and then select an image in the group. Press ▼ again to return to the normal selection screen.
- The settings from the time of recording are reflected in displayed images.



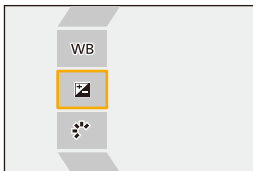

3 Select a setting item.

- Press ▲▼ to select an item and then press **MENU/SET** or .



4 Change the setting.



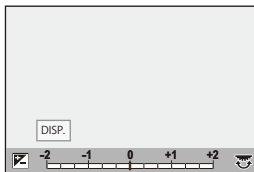

- Rotate , , or .
- The image can be enlarged/reduced by pinching out/pinching in the screen.



5 Confirm the setting.







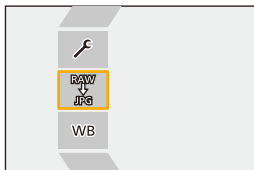



- Press  or .
- The screen of Step 3 reappears.
To set another item, repeat Steps 3 to 5.





6 Save the image.

- Press   to select [Begin Processing] and then press  or .



❖ Setting Items ([RAW Processing])

 [Begin Processing]	Saves the image.
WB [White Balance]	<p>Selects and adjusts the white balance. Selecting the item with  enables processing with the same setting as at the time of recording.</p> <ul style="list-style-type: none"> • If you press ▼ in the [White Balance] selection screen, the white balance adjustment screen appears. • If you press ▲ while [] to [] is selected, the color temperature setting screen appears.
 [Brightness correction]	<p>Corrects the brightness.</p> <ul style="list-style-type: none"> • The [Brightness correction] effect differs from the effect of exposure compensation during recording.
 [Photo Style]	<p>Selects a Photo Style. (→ 208)</p> <ul style="list-style-type: none"> • If you press [Q] while [Like709] is selected, the knee setting screen appears. (→ 260) • You cannot select a Photo Style for images recorded with [V-Log]. You cannot select [V-Log] for images not recorded with [V-Log]. • You cannot select a Photo Style other than [Cinelike D2] or [Cinelike V2] for images recorded with [Cinelike D2] or [Cinelike V2]. You cannot select [Cinelike D2] or [Cinelike V2] for images not recorded with Photo Style [Cinelike D2] or [Cinelike V2]. • When you have selected [HLG] in [File Format] in [More Settings], only [Standard(HLG)] and [Monochrome(HLG)] are available for selection.
 [i.Dynamic Range]	Selects the setting of [i.Dynamic Range].
 [Contrast]	Adjusts the contrast.
 [Highlight]	Adjusts the brightness of bright portions.
 [Shadow]	Adjusts the brightness of dark portions.

	[Saturation]/ [Color Tone]	Adjusts the saturation or color tone.
	[Hue]	Adjusts the hue.
	[Filter Effect]	Selects filter effects.
	[Grain Effect]	Selects a grain effect setting. • You cannot set this for images recorded in [High Resolution Mode].
NR	[Noise Reduction]	Sets noise reduction.
	[Sharpness]	Adjusts the sharpness.
	[More Settings]	<p>[Revert To Original]: Returns the settings to the ones from the time of recording.</p> <p>[File Format]: Selects a file format from [JPG] or [HLG]. When you select [HLG], both JPEG format and HSP format pictures are saved. (Only images recorded with [HLG Photo])</p> <p>[Color Space]: Selects a Color Space setting from [sRGB] or [AdobeRGB]. (Only when [JPG] is selected in [File Format])</p> <p>[Picture Size]: Selects the size for storing images.</p> <p>[HLG View Assist (Monitor)]/[HLG View Assist (HDMI)]: The color gamut and brightness of images recorded with [HLG Photo] can be converted for display on the monitor/viewfinder of this camera, or displayed on an HDMI device. Refer to [HLG View Assist] in the [Custom] menu for details. (→ 282)</p> <ul style="list-style-type: none"> • [HLG View Assist (Monitor)] and [HLG View Assist (HDMI)] can only be selected when [HLG] is selected in [File Format]. <p>[Destination Card Slot]: You can select the card slot to which to save images processed with RAW. When [AUTO] is selected, the image is saved to the same card slot as the RAW format image to be processed.</p>

12. Playing Back and Editing of Images

- The items that can be adjusted depend on the selected [Photo Style].

	STD. VIVID NAT FLAT LAND PORT CNE2 CNEV2	MONO LMONO LMONOD	709L	V-Log	STD. ^{HLG}	MONO ^{HLG}
WB	✓	✓	✓	✓	✓	✓
	✓	✓	✓	✓	✓	✓
	✓	✓	✓	—	✓	✓
	✓	✓	—	—	—	—
	✓	✓	—	—	✓	✓
	✓	✓	—	—	✓	✓
	✓	✓	—	—	✓	✓
 ([Saturation])	✓	—	✓	—	✓	—
 ([Color Tone])	—	✓	—	—	—	✓
	✓	—	✓	—	✓	—
	—	✓	—	—	—	✓
	—	✓	—	—	—	—
NR	✓	✓	✓	✓	✓	✓
	✓	✓	✓	✓	✓	✓

❖ Displaying a Comparison Screen

You can change a setting while checking the effect by displaying images with the applied setting value side by side.

❶ Press [DISP.] in the screen of Step 4.

- The image with the current setting (A) is displayed at the center.
- Touching the image with the current setting enlarges it.
Touching [] returns to the original display.
- A comparison screen cannot be displayed while [Noise Reduction] or [Sharpness] is selected.

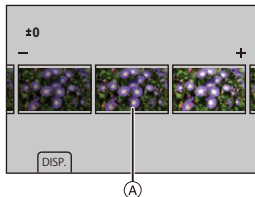

❷ Rotate , , or to change the setting.

❸ Press or to confirm the setting.





- RAW images recorded with the camera are recorded in the [L] size of [3:2]. (However, RAW images recorded with [High Resolution Mode] are recorded in the [XL] size of [3:2])
With this function, images are processed with the aspect ratio and the angle of view of [Ex. Tele Conv.] from the time of recording.
- The [White Balance] item is fixed to the setting from the time of recording for pictures recorded with multiple exposures.
- The results of RAW processing with this function and with the “SILKYPIX Developer Studio” software do not completely match.

[Video Divide]

Divide a recorded video or 6K/4K burst file into two.



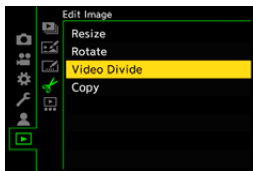

- Images cannot be returned to their original state once they have been divided. Carefully confirm the images before performing the divide operation.
- Do not remove the card or battery from the camera during the divide process. The images may be lost.

1 Select [Video Divide].

- Press  →  →  → [Video Divide]





2 Select and play the image.

- Press   to select an image and then press  or .



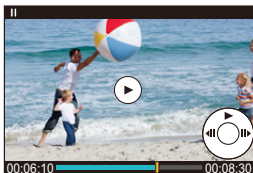

3 Pause playback at the position you wish to divide.

- Press .
- To fine-adjust the position, press   (frame-by-frame rewind or frame-by-frame forward).



4 Divide the video.

- Press  or .
- You can also divide the video by touching [Divide].



- Dividing the video at a point close to the start or end may not be possible.
- Videos with a short recording time cannot be divided.

13. Camera Customization

This chapter describes the customization function with which you can configure the camera to your preferred settings.

Change how buttons, dials, etc. on the camera are to be operated.



[Fn Button Set]

→ 321



[Dial Operation Switch Setup]

→ 330

Register the currently set information of the camera.



Custom mode

→ 337

Change menu display items.

Quick menu

→ 332

My Menu

→ 341

Import camera settings information onto another camera.

[Save/Restore Camera Setting]

→ 343



- Detailed settings for camera operations and screen display are available in the [Custom] menu. (→ 370)

Fn Buttons

You can register functions to the Fn (Function) buttons. Additionally, you can register other functions to specialized buttons such as [WB] button, in the same way as with the Fn buttons.

Different functions can be set for both during recording and playback.

❖ Fn Button Default Settings

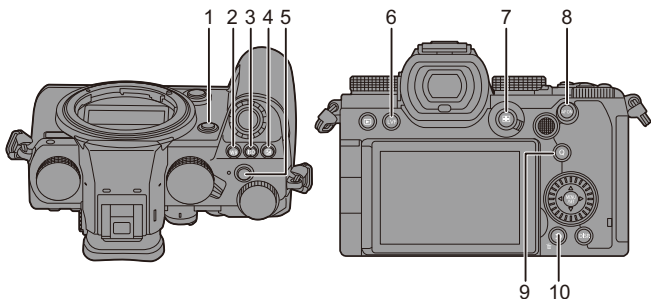

	Fn buttons	[Setting in REC mode]	[Setting in PLAY mode]
1	[Fn2]	[Preview]	[No Setting]
2	[WB]	[White Balance]	[No Setting]
3	[ISO]	[Sensitivity]	[No Setting]
4	[]	[Exposure Comp.]	[No Setting]
5	Video rec. button	[Video Record]	[Video Record]
6	[LVF]	[LVF/Monitor Switch]	[LVF/Monitor Switch]
7	[]	[AF Mode]	[Card Slot Change]
8	[AF ON]	[AF-ON]	[Rating★3]
9	[Q]	[Q.MENU]	[Send Image (Smartphone)]
10	[Fn1]/[]/[]	[Level Gauge]	<ul style="list-style-type: none"> • Cannot be used as Fn buttons during playback.

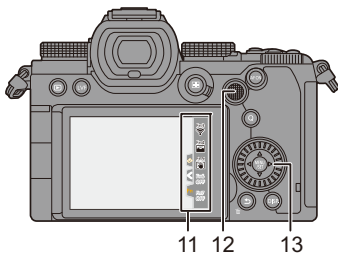



	Fn buttons	[Setting in REC mode]	[Setting in PLAY mode]
11	[Fn3]	[Wi-Fi]	
	[Fn4]	[Histogram]	
	[Fn5]	[Boost I.S. (Video)]	
	[Fn6]	[Off (Disable Press and Hold)]	
	[Fn7]	[Off (Disable Press and Hold)]	
12		[No Setting]	<ul style="list-style-type: none"> • Cannot be used as Fn buttons during playback.
13		[No Setting]	

Register Functions to the Fn Buttons



- With default settings, [Fn8] to [Fn12] on the joystick cannot be used. When using functions, set the [Joystick Setting] in the [Custom] ([Operation]) menu to [Fn]. (→ 381)

1 Select [Fn Button Set].

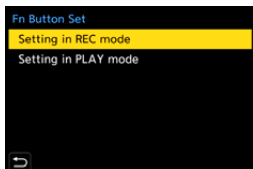
- Press **MENU/SET** → [] → [] → [Fn Button Set] → [Setting in REC mode]/[Setting in PLAY mode]



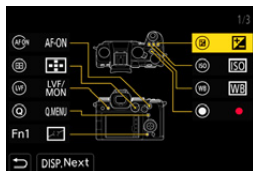

2 Select the button.

- Press **▲▼** to select the button and then press **MENU/SET** or .
- Selection is also possible by rotating  or .
- Press [DISP.] to change the page.





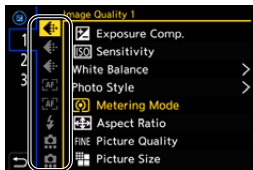

3 Find the function to register.

- Rotate  to select the sub tab where the function to register is categorized (→ 325, 328) and then press **MENU/SET** or .
- You can also select by pressing **◀** to select the sub tab, pressing **▲▼** or rotating , and then pressing **▶**.
- Switch the [1] to [3] tabs by pressing [Q].



4 Register the function.



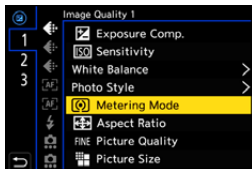

- Press ▲▼ to select a function and then press  or .
- Selection is also possible by rotating  or .
- Select items with [>] by selecting the item again.
- Depending on the button, some functions cannot be registered.



- You can also touch [Fn] on the control panel (→ 67) to display the screen in Step 2.
- You can also press and hold the Fn button (2 sec.) to display the screen in Step 4.
(This may not be displayed depending on the registered function and on the button type.)

❖ Setting Items ([Fn Button Set]/[Setting in REC mode])

[1] tab

 [Image Quality]		 [Focus/Shutter]	
[Exposure Comp.]	→ 196	[AF Mode]	→ 100
[Sensitivity]	→ 199	[AF Custom Setting(Photo)]	→ 98
[White Balance]	→ 202	[AF Custom Setting(Video)]	→ 258
[Photo Style]	→ 208	[Focus Peaking]	→ 356
[Metering Mode]	→ 184	[Focus Peaking Sensitivity]	→ 356
[Aspect Ratio]	→ 83	[1-Area AF Moving Speed]	→ 356
[Picture Quality]	→ 86	[Focus Ring Lock]	→ 374
[Picture Size]	→ 85	[AE LOCK]	→ 198
[HLG Photo]	→ 225	[AF LOCK]	→ 198
[High Resolution Mode]	→ 221	[AF/AE LOCK]	→ 198
[1 Shot Spot Metering]		[AF-ON]	→ 95
• Records with the metering mode set to [] (Spot metering) once only.		[AF-ON : Near Shift]	
[Long Exposure NR]	→ 351	• AF operates giving priority to close-up subjects.	
[Min. Shutter Speed]	→ 352	[AF-ON : Far Shift]	
[1 Shot RAW+JPG]		• AF operates giving priority to distant subjects.	
• Records a RAW image and a JPEG image simultaneously once only.		[AF-Point Scope]	→ 97
[i.Dynamic Range]	→ 353	[Focus Area Set]	
[Filter Effect]	→ 215	• Displays the AF area/MF Assist transition screen.	
[One Push AE]		 [Flash]	
• Adjusts the aperture value and shutter speed to the settings suited for the standard exposure determined by the camera.		[Flash Mode]	→ 229
[Touch AE]	→ 81	[Flash Adjust.]	→ 233
[Exposure Mode]	→ 245	[Wireless Flash Setup]	→ 236

 [Others (Photo)]	
[Drive Mode]	→ 128
[1 Shot "6K/4K PHOTO"]	
• Performs 6K/4K photo recording only once.	
[Bracketing]	→ 156

[Silent Mode]	→ 174
[Image Stabilizer]	→ 177
[Shutter Type]	→ 175
[Ex. Tele Conv.]	→ 125
[Live View Composite]	→ 162
[Post-Focus]	→ 166

[2] tab

 [Image Format]	
[Rec. File Format]	→ 249
[Rec Quality]	→ 250
[Slow & Quick Setting]	→ 270
[Time Code Display]	→ 254

 [Audio]	
[Sound Rec Level Disp.]	→ 263
[Sound Rec Level Adj.]	→ 263
[Sound Rec Level Limiter]	→ 263
[Special Mic. Directivity Adjust]	
• Sets the sound pickup range for [MANUAL] in [Special Mic.]. (→ 294)	

 [Others (Video)]	
[Image Stabilizer]	→ 179
[E-Stabilization (Video)]	→ 179
[Boost I.S. (Video)]	→ 179
[Image Area of Video]	→ 249
[Live Cropping]	→ 272

 [Operation]	
[Q.MENU]	→ 69
[Rec / Playback Switch]	
• Switches to the playback screen.	

[Video Record]	→ 240
[LVF/Monitor Switch]	→ 66
[Operation Lock]	
• A certain type of operation is disabled. Set the type of operation to be disabled in [Operation Lock Setup] (→ 378).	

[Dial Operation Switch]	→ 331
 [Monitor / Display]	
[Preview]	→ 195

[Preview Aperture Effect]	
• The aperture effect can be previewed while the Fn button is being pressed.	

[Constant Preview]	→ 383
[Level Gauge]	→ 391
[Histogram]	→ 384
[Luminance Spot Meter]	→ 266
[Frame Marker]	→ 268
[Photo Grid Line]	→ 385
[Live View Boost]	→ 386
[Monochrome Live View]	→ 392
[Night Mode]	→ 387

[LVF/Monitor Disp. Style]	
• Switches the displayed monitor or viewfinder display style.	
[Photo/Video Preview]	→ 388
[Zebra Pattern]	→ 393
[LUT View Assist (Monitor)]	→ 278
[LUT View Assist (HDMI)]	→ 278
[LUT Select]	→ 278
[HLG View Assist (Monitor)]	→ 282

[HLG View Assist (HDMI)]	→ 282
[Sheer Overlay]	→ 390
[I.S. Status Scope]	→ 390
[Waveform Monitor]	→ 264
[Anamorphic Desqueeze Display]	→ 286
 [Lens / Others]	
[Focus Ring Control]	→ 394
[Zoom Control]	→ 126

[3] tab

[Card/File]

[Destination Card Slot]

- Changes the priority of cards for recording. This can be used if [Double Card Slot Function] (→ 88) is set to [Relay Rec].

[IN/OUT]

[Wi-Fi] → 416

[Others]

[No Setting]

- The button does not work as an Fn button.

[Off (Disable Press and Hold)]









- The button does not work as an Fn button. The function registering screen is not displayed when you press and hold (2 seconds) the Fn button.

[Restore to Default]

- Restore the default settings for the Fn button. (→ 321)

❖ Setting Items ([Fn Button Set]/[Setting in PLAY mode])

[1] tab

 [Playback Mode]		 [Edit Image]	
[Magnify from AF Point]	→ 408	[Copy]	→ 413
[LUT View Assist (Monitor)]	→ 278	 [Operation]	
[HLG View Assist (Monitor)]	→ 392	[Rec / Playback Switch]	
[Anamorphic Desqueeze Display]	→ 286	• Switches to the recording screen.	
 [Process Image]		[LVF/Monitor Switch]	→ 66
[RAW Processing]	→ 312	[Video Record]	→ 240
[6K/4K PHOTO Bulk Saving]	→ 144	 [Monitor / Display]	
 [Add/Delete Info.]		[Night Mode]	→ 387
[Delete Single]	→ 311	 [Card/File]	
[Protect]	→ 411	[Card Slot Change]	→ 302
[Rating★1]	→ 411	 [IN/OUT]	
[Rating★2]	→ 411	[Wi-Fi]	→ 416
[Rating★3]	→ 411	[Send Image (Smartphone)]	→ 449
[Rating★4]	→ 411	[LUT View Assist (HDMI)]	→ 278
[Rating★5]	→ 411	[HLG View Assist (HDMI)]	→ 392

[2] tab





 [Others]	
[6K/4K Photo Play]	• Displays the screen to select pictures to save from a 6K/4K burst file.
[No Setting]	• The button does not work as an Fn button.
[Off (Disable Press and Hold)]	• The button does not work as an Fn button. The function registering screen is not displayed when you press and hold (2 seconds) the Fn button.
[Restore to Default]	• Restore the default settings for the Fn button. (→ 321)

Use the Fn Buttons

During recording, pressing the Fn buttons enables usage of the functions registered in [Setting in REC mode], and during playback, usage of the functions registered in [Setting in PLAY mode].

1 Press the Fn button.

2 Select a setting item.

- Press ◀▶ to select a setting item and then press  or .
- Selection is also possible by rotating ,  or .
- Display and selection methods of a setting item differ depending on the menu item.

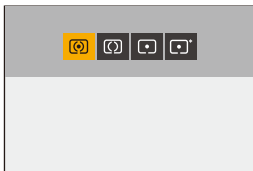

❖ Use [Fn3] to [Fn7] (Touch Icons)

During recording, you can use the Fn buttons within the Touch Tab.



- With the default settings, the Touch Tab is not displayed. Set [Touch Tab] to [ON] in [Touch Settings] in the [Custom] ([Operation]) menu. (→ 377)

1 Touch [Fn].

2 Touch one of [Fn3] to [Fn7].





[Dial Operation Switch]

This temporarily changes the functions operated with ☀️ (front dial) and 🌑 (rear dial).



Register Functions to the Dials

1 Select [Dial Operation Switch Setup].

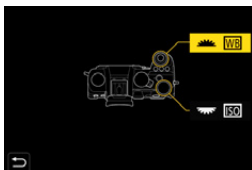
-  →  →  → [Dial Set.]
→ [Dial Operation Switch Setup] →
[☀️]/[🌑]



2 Register the function.

- Press ▲▼ to select a function and then press  or .

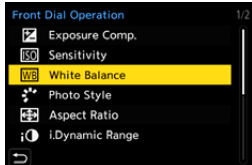

❖ Functions That Can Be Registered

[Exposure Comp.]	→ 196	[Filter Effect]	→ 215
[Sensitivity] ⁺¹	→ 199	[AF Mode]	→ 100
[White Balance] ⁺²	→ 202	[Flash Mode]	→ 229
[Photo Style]	→ 208	[Flash Adjust.]	→ 233
[Aspect Ratio]	→ 83	[6K/4K PHOTO]	→ 133
[i.Dynamic Range]	→ 353		



*1 🌑 default setting

*2 ☀️ default setting

Temporarily Change Dial Operation

1 Set [Dial Operation Switch] to the Fn button. (→ 321)

2 Switch dial operation.

- Press the Fn button set in Step 1.
- A guide will display the functions registered to  and .
- If no operations are performed, then several seconds later, the guide disappears.

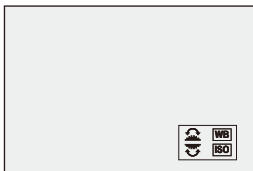

3 Set the registered function.

- Rotate  or  while the guide is displayed.

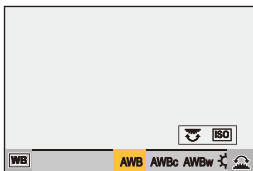

4 Confirm your selection.

- Press the shutter button halfway.

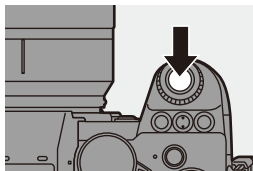

Quick Menu Customization

You can change Quick menu items depending on the recording mode. Additionally, you can change the items to display on the Quick menu and their order to suit your preferences.



For information about Quick menu operation methods, refer to page 69.

Register to the Quick Menu

Change the menus to be displayed in the Quick menu.





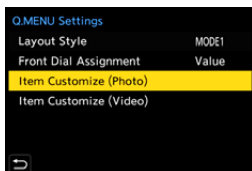

These can be set separately for [P/M]/[S&Q] mode (Video) and for other recording modes (Photo).

1 Select [Q.MENU Settings].

-  → [] → [] → [Q.MENU Settings] → [Item Customize (Photo)]/[Item Customize (Video)]











2 Select the item position (① to ⑫).

- Press    to select the position and then press  or .
- Selection is also possible by rotating .









3 Find the function to register.

- Rotate  to select the sub tab where the function to register is categorized (→ 334) and then press  or .
- You can also select by pressing  to select the sub tab, pressing   or rotating , and then pressing .
- Each press of [Q] switches between tabs [1] and [2].









4 Register menu items.

- Press   to select an item and then press  or .
- Selection is also possible by rotating  or .
- Select items with [>] by selecting the item again.







❖ Menu Items That Can Be Registered

[1] tab

 [Image Quality]		 [Others (Photo)]	
[Exposure Comp.]	→ 196	[Drive Mode]	→ 128
[Sensitivity]	→ 199	[Bracketing]	→ 156
[White Balance]	→ 202	[Silent Mode]	→ 174
[Photo Style]	→ 208	[Image Stabilizer]	→ 177
[Metering Mode]	→ 184	[Shutter Type]	→ 175
[Aspect Ratio]	→ 83	[Ex. Tele Conv.]	→ 125
[Picture Quality]	→ 86	[Post-Focus]	→ 166
[Picture Size]	→ 85	 [Image Format]	
[HLG Photo]	→ 225	[Rec. File Format]	→ 249
[Long Exposure NR]	→ 351	[Rec Quality]	→ 250
[Min. Shutter Speed]	→ 352	[Slow & Quick Setting]	→ 270
[i.Dynamic Range]	→ 353	[Time Code Display]	→ 254
[Filter Effect]	→ 215	 [Audio]	
[Exposure Mode]	→ 245	[Sound Rec Level Disp.]	→ 263
 [AF] [Focus/Shutter]		[Sound Rec Level Adj.]	→ 263
[AF Mode]	→ 100	[Sound Rec Level Limiter]	→ 263
[AF Custom Setting(Photo)]	→ 98	[Special Mic. Directivity Adjust]	
[AF Custom Setting(Video)]	→ 258	• Sets the sound pickup range for [MANUAL] in [Special Mic.]. (→ 294)	
[Focus Peaking]	→ 356	 [Others (Video)]	
[Focus Peaking Sensitivity]	→ 356	[Image Stabilizer]	→ 179
[1-Area AF Moving Speed]	→ 356	[E-Stabilization (Video)]	→ 179
 [Flash]		[Boost I.S. (Video)]	→ 179
[Flash Mode]	→ 229	[Image Area of Video]	→ 249
[Flash Adjust.]	→ 233	[Live Cropping]	→ 272
[Wireless Flash Setup]	→ 236		

[2] tab

 [Monitor / Display]	
[Constant Preview]	→ 383
[Level Gauge]	→ 391
[Histogram]	→ 384
[Luminance Spot Meter]	→ 266
[Frame Marker]	→ 268
[Photo Grid Line]	→ 385
[Live View Boost]	→ 386
[Monochrome Live View]	→ 392
[Night Mode]	→ 387
[LVF/Monitor Disp. Style]	→ 387
[Photo/Video Preview]	→ 388
[Zebra Pattern]	→ 393
[LUT View Assist (Monitor)]	→ 278
[LUT View Assist (HDMI)]	→ 401
[HLG View Assist (Monitor)]	→ 392
[HLG View Assist (HDMI)]	→ 392
[Sheer Overlay]	→ 390
[I.S. Status Scope]	→ 390
[Waveform Monitor]	→ 264
[Anamorphic Desqueeze Display]	→ 286

 [Lens / Others]	
[Focus Ring Control]	→ 394
 [Card/File]	
[Destination Card Slot]	→ 88
 [IN/OUT]	
[Wi-Fi]	→ 416
 [Others]	
[No Setting]	
• Set when not using.	

❖ Quick Menu Detailed Settings

Change the appearance of the Quick menu and the operation of  during menu display.

 ⇒ [] ⇒ [] ⇒ Select [Q.MENU Settings]

<p>[Layout Style]</p>	<p>Changes the appearance of the Quick menu. [MODE1]: Displays the live view and the menu simultaneously. [MODE2]: Displays the menu in full screen.</p>
<p>[Front Dial Assignment]</p>	<p>Changes the operation of  in the Quick menu. [Item]: Selects menu items. [Value]: Selects setting values.</p>
<p>[Item Customize (Photo)]</p>	<p>Customizes the Quick menu to display when the mode dial is set to [iA]/[P]/[A]/[S]/[M].</p>
<p>[Item Customize (Video)]</p>	<p>Customizes the Quick menu to display when the mode dial is set to [vM]/[S&Q].</p>

Custom Mode

C1 C2 C3



Recording modes and menu settings that match your preferences can be registered in Custom mode. You can use registered settings by switching the mode dial to [C1] to [C3] modes.

Register in Custom Mode

You can register the currently set information of the camera.

At the time of purchase, the default settings of the [P] mode menus are registered with all Custom modes.

1 Set to recording mode and menu settings of the state you wish to save.

2 Select [Save to Custom Mode].

- → [] → [] → [Save to Custom Mode]

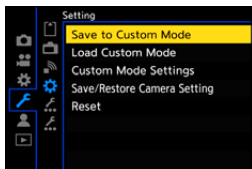

3 Register.

- Select the save-to number and then press or .
- A confirmation screen will be displayed. Press [DISP.] to change the Custom mode name.
How to enter characters (→ 415)

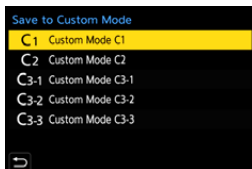

• You cannot register [iA] mode in Custom mode.



• List of settings that can be registered in Custom mode (→ 531)

❖ Custom Mode Detailed Settings

You can create additional Custom mode sets, and how long to retain temporarily changed settings details.

 ⇒ [] ⇒ [] ⇒ Select [Custom Mode Settings]



<p>[Limit No. of Custom Mode]</p>	<p>Sets the number of Custom modes that can be registered in [C3]. A maximum of 10 sets can be registered; 3 sets are available as default settings.</p>
<p>[Edit Title]</p>	<p>Changes the Custom mode name. A maximum of 22 characters can be entered. A two-byte character is treated as two characters. • How to enter characters (→ 415)</p>
<p>[How to Reload Custom Mode]</p>	<p>Sets the timing at which to return the settings that were changed temporarily while the Custom mode was being used to their registered settings. [Change Recording Mode]/[Return from Sleep Mode]/[Turn the Power ON]</p>
<p>[Select Loading Details]</p>	<p>Sets the types of settings to call up with [Load Custom Mode]. [F / SS / ISO Sensitivity]: Enables calling up of aperture value, shutter speed, and ISO sensitivity settings. [White Balance]: Enables calling up of white balance settings.</p>

Calling Up Settings

Call up registered Custom mode settings to the selected recording mode and overwrite the current settings with these.



1 Set to the mode dial to use.

2 Select [Load Custom Mode].

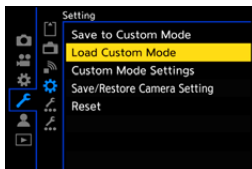
-  → [] → [] → [Load Custom Mode]



3 Select the Custom mode to call up.

- Select the Custom mode and then press  or .

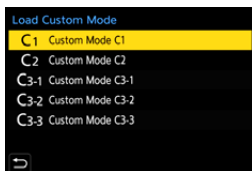



- Calling up of Custom modes is not possible between those created from [P]/[A]/[S]/[M] modes and those created from []/[S&Q] modes.

My Menu

Register frequently-used menus in My Menu.

A maximum of 23 items can be registered.

Registered menus can be called up from [] to [].

Registration in My Menu

1 Select [Add].

-  → [] → [] → [Add]

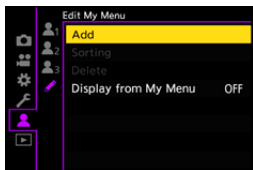



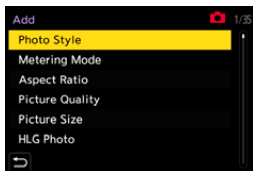

2 Register.

- Select the menu to register and then press  or .



❖ Calling up My Menu

Call up the menus registered in My Menu.

 → [] → []/[]/[] → Registered menus

❖ Edit My Menu

You can reorder the display order of My Menu, and delete unnecessary menus.

 ⇒ [] ⇒ Select []

[Add]	Selects and registers the menus to be displayed in My Menu.
[Sorting]	Changes the order of My Menu. Select the menu to change, then set the destination.
[Delete]	Deletes menus that are registered to My Menu. [Delete Item]: Selects the menu, then deletes. [Delete All]: Deletes all menus registered in My Menu.
[Display from My Menu]	Displays My Menu first when displaying a menu. [ON]: Displays My Menu. [OFF]: Displays the last-used menu.

[Save/Restore Camera Setting]

Saves the camera's settings information to the card.

Saved settings information can be loaded to the camera, letting you set the same settings on multiple cameras.



⇒ [] ⇒ [] ⇒ Select [Save/Restore Camera Setting]

[Save]	Saves the camera's settings information to the card. <ul style="list-style-type: none"> • If saving new data, then select [New File], and if overwriting an existing file, select that existing file. • When [New File] is selected, a screen to select the file name to save as is displayed. 	
	[OK]	Saves using the file name on the screen.
	[Change the file name]	Changes the file name and saves the file. <ul style="list-style-type: none"> • Available characters: alphabetic characters (upper-case), numerals, up to 8 characters • How to enter characters (→ 415)
[Load]	Loads the settings information on the card and copies it to the camera.	
[Delete]	Deletes settings information on the card.	
[Keep Settings While Format]	When formatting the card, formats the card while keeping camera settings information stored on the card.	



- Only settings information from the same model can be loaded.
- Up to 10 instances of settings information can be saved on one card.



- List of functions for which saving of settings information is possible (→ [531](#))

14. Menu Guide

Camera customization and many function settings are performed with menus on this camera. This chapter provides a list of menus and describes them in detail.

Menus explained in detail in other chapters are indicated with page numbers.

- For information about menu operation methods, refer to page [73](#).

Search the Menus

List of Menu [→ 345](#)

Learn About the Menu Functions and Default Settings

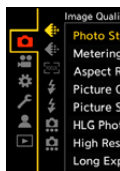

 [Photo] Menu [→ 350](#)

 [Video] Menu [→ 364](#)

 [Custom] Menu [→ 370](#)

 [Setup] Menu [→ 395](#)

 [My Menu] [→ 341](#)

 [Playback] Menu [→ 406](#)

Enter Characters

Entering Characters [→ 415](#)

















- Refer to the “17. Materials” chapter for the following lists:
 - List of Default Settings/Custom Saving/Settings Available for Copying: [→ 531](#)
 - List of Functions That Can Be Set in Each Recording Mode: [→ 545](#)













List of Menu

: Menu items common to the [Photo] menu and [Video] menu.
Their settings are synchronized.

[Photo] menu





 [Image Quality]	→ 350	 [Flash]	→ 357
[Photo Style]	 → 350	[Flash Mode]	→ 357
[Metering Mode]	 → 350	[Firing Mode]	→ 357
[Aspect Ratio]	→ 350	[Flash Adjust.]	→ 357
[Picture Quality]	→ 350	[Flash Synchro]	→ 357
[Picture Size]	→ 350	[Manual Flash Adjust.]	→ 357
[HLG Photo]	→ 350	[Auto Exposure Comp.]	→ 357
[High Resolution Mode]	→ 351	[Red-Eye Removal]	→ 357
[Long Exposure NR]	→ 351	[Wireless]	→ 357
[ISO Sensitivity (photo)]	→ 352	[Wireless Channel]	→ 357
[Min. Shutter Speed]	→ 352	[Wireless FP]	→ 358
[i.Dynamic Range]	 → 353	[Communication Light]	→ 358
[Vignetting Comp.]	 → 354	[Wireless Setup]	→ 358
[Diffraction Compensation]	 → 354	 [Others (Photo)]	→ 358
[Filter Settings]	 → 355	[Bracketing]	→ 358
 [Focus]	→ 355	[Silent Mode]	 → 358
[AF Custom Setting(Photo)]	→ 355	[Image Stabilizer]	 → 359
[AF Assist Light]	 → 355	[Burst Shot 1 Setting]	→ 359
[Focus Peaking]	 → 356	[Burst Shot 2 Setting]	→ 359
[1-Area AF Moving Speed]	 → 356	[Shutter Type]	→ 360
		[Shutter Delay]	→ 360
		[Ex. Tele Conv.]	→ 360
		[Time Lapse/Animation]	→ 360
		[Live View Composite]	→ 361
		[Self Timer]	→ 361
		[6K/4K PHOTO]	→ 361
		[Post-Focus]	→ 362
		[Multiple Exposure]	→ 362

 **[Video] menu**

 [Image Quality]	→ 364
[Exposure Mode]	→ 364
[Photo Style]	 → 364
[Metering Mode]	 → 364
[ISO Sensitivity (video)]	→ 364
[Flicker Decrease (Video)]	→ 365
[i.Dynamic Range]	 → 365
[Vignetting Comp.]	 → 354
[Diffraction Compensation]	 → 354
[Filter Settings]	 → 355
 [Image Format]	→ 366
[Image Area of Video]	→ 366
[Rec Quality]	→ 366
[Slow & Quick Setting]	→ 366
[Switch NTSC/PAL]	→ 366
[Rec. File Format]	→ 366
[Time Code]	→ 366
[Luminance Level]	→ 366
[Anamorphic(4:3)]	→ 366
 [Focus]	→ 367
[AF Custom Setting(Video)]	→ 367
[Continuous AF]	→ 367
[AF Assist Light]	 → 367
[Focus Peaking]	 → 367
[1-Area AF Moving Speed]	 → 367

 [Audio]	→ 368
[Sound Rec Level Disp.]	→ 368
[Sound Rec Level Adj.]	→ 368
[Sound Rec Level Limiter]	→ 368
[Wind Noise Canceller/]	→ 368
[Wind Cut]	→ 368
[Mic Socket]	→ 368
[Special Mic.]	→ 368
[XLR Mic Adaptor Setting]	→ 368
[Sound Output]	→ 368
[Headphone Volume]	→ 369
 [Others (Video)]	→ 369
[Silent Mode]	 → 369
[Image Stabilizer]	 → 369
[Live Cropping]	→ 369



[Custom] menu



 [Image Quality]	→ 370	[Fn Button Set]	→ 378
[Photo Style Settings]	→ 370	[WB/ISO/Expo. Button]	→ 379
[ISO Increments]	→ 370	[ISO Displayed Setting]	→ 379
[Extended ISO]	→ 371	[Exposure Comp. Disp. Setting]	→ 379
[Exposure Offset Adjust.]	→ 371	[Dial Set.]	→ 380
[Color Space]	→ 371	[Joystick Setting]	→ 381
[Exposure Comp. Reset]	→ 372	[Video Rec. Button (Remote)]	→ 381
[Auto Exposure in P/A/S/M]	→ 372	 [Monitor / Display (Photo)]	→ 382
[CreativeVideo Combined Set.]	→ 372	[Auto Review]	→ 382
 [Focus/Shutter]	→ 373	[Constant Preview]	→ 383
[Focus/Shutter Priority]	→ 373	[Histogram]	→ 384
[Focus Switching for Vert / Hor]	→ 373	[Photo Grid Line]	→ 385
[AF/AE Lock Hold]	→ 373	[Frame Marker]	→ 385
[AF+MF]	→ 373	[AF Area Display]	→ 385
[MF Assist]	→ 374	[Live View Boost]	→ 386
[MF Guide]	→ 374	[Night Mode]	→ 387
[Focus Ring Lock]	→ 374	[LVF/Monitor Disp. Set]	→ 387
[Show/Hide AF Mode]	→ 375	[Expo.Meter]	→ 388
[Pinpoint AF Setting]	→ 375	[Focal Length]	→ 388
[AF-Point Scope Setting]	→ 376	[Photo/Video Preview]	→ 388
[Shutter AF]	→ 376	[Photos/Videos Remaining]	→ 389
[Half-Press Shutter]	→ 376	[Blinking Highlights]	→ 389
[Quick AF]	→ 376	[Sheer Overlay]	→ 390
[Eye Sensor AF]	→ 376	[I.S. Status Scope]	→ 390
[Looped Focus Frame]	→ 377	[Level Gauge]	→ 391
[AFC Start Point (225-Area)]	→ 377	[Luminance Spot Meter]	→ 391
 [Operation]	→ 377	[Framing Outline]	→ 391
[Q.MENU Settings]	→ 377	[Show/Hide Monitor Layout]	→ 391
[Touch Settings]	→ 377		
[Operation Lock Setup]	→ 378		



[Custom] menu (Continued)

 [Monitor / Display (Video)]	→ 392
[V-Log View Assist]	→ 392
[HLG View Assist]	→ 392
[Anamorphic Desqueeze Display]	→ 392
[Monochrome Live View]	→ 392
[Center Marker]	→ 393
[Zebra Pattern]	→ 393
[Waveform Monitor]	→ 393
[Red REC Frame Indicator]	→ 393

[Setup] menu

 [Card/File]	→ 395
[Card Format]	→ 395
[Double Card Slot Function]	→ 395
[Folder / File Settings]	→ 395
[File Number Reset]	→ 395
[Copyright Information]	→ 395
 [Monitor / Display]	→ 396
[Power Save Mode]	→ 396
[Monitor Frame Rate]	→ 396
[LVF Frame Rate]	→ 397
[Monitor Settings]/[Viewfinder]	→ 397
[Monitor Backlight]/ [LVF Luminance]	→ 398
[Eye Sensor]	→ 398
[Level Gauge Adjust.]	→ 398

 [IN/OUT]	→ 393
[HDMI Rec Output]	→ 393
 [Lens / Others]	→ 394
[Lens Focus Resume]	→ 394
[Lens Fn Button Setting]	→ 394
[Focus Ring Control]	→ 394



 [IN/OUT]	→ 399
[Beep]	→ 399
[Headphone Volume]	→ 399
[Wi-Fi]	→ 399
[Bluetooth]	→ 400
[USB]	→ 400
[Battery Use Priority]	→ 401
[TV Connection]	→ 401
[Wireless Connection Light]	→ 402
 [Setting]	→ 403
[Save to Custom Mode]	→ 403
[Load Custom Mode]	→ 403
[Custom Mode Settings]	→ 403
[Save/Restore Camera Setting]	→ 403
[Reset]	→ 403

 **[Setup] menu (Continued)**

 [Others]	→ 404
[Clock Set]	→ 404
[Time Zone]	→ 404
[Pixel Refresh]	→ 404



[Sensor Cleaning]	→ 404
[Language]	→ 405
[Firmware Version]	→ 405
[Online Manual]	→ 405
[Approved Regulations]	→ 405

 **[My Menu]**

 [Page 1]	→ 341
 [Page 2]	→ 341
 [Page 3]	→ 341

 [Edit My Menu]	→ 342
[Add]	→ 342
[Sorting]	→ 342
[Delete]	→ 342
[Display from My Menu]	→ 342

 **[Playback] menu**

 [Playback Mode]	→ 407
[Playback Mode]	→ 407
[Slide Show]	→ 407
[Rotate Disp.]	→ 407
[Picture Sort]	→ 408
[Magnify from AF Point]	→ 408
[LUT View Assist (Monitor)]	→ 408
[HLG View Assist (Monitor)]	→ 409
[Anamorphic Desqueeze Display]	→ 409
 [Process Image]	→ 410
[RAW Processing]	→ 410
[6K/4K PHOTO Bulk Saving]	→ 410
[6K/4K PHOTO Noise Reduction]	→ 410
[Time Lapse Video]	→ 410
[Stop Motion Video]	→ 410

 [Add/Delete Info.]	→ 411
[Protect]	→ 411
[Rating]	→ 411
 [Edit Image]	→ 412
[Resize]	→ 412
[Rotate]	→ 412
[Video Divide]	→ 412
[Copy]	→ 413
 [Others]	→ 414
[Delete Confirmation]	→ 414
[Delete All Images]	→ 414



[Photo] Menu



Menu items common to the [Photo] menu and [Video] menu.
Their settings are synchronized.

▶: Default settings







[Photo] menu → [Image Quality]

 [Photo Style]	▶[Standard]/[Vivid]/[Natural]/[Flat]/[Landscape]/ [Portrait]/[Monochrome]/[L.Monochrome]/ [L.Monochrome D]/[Cinelike D2]/[Cinelike V2]/ [Like709]/[V-Log]/[Standard(HLG)]/ [Monochrome(HLG)]/[MY PHOTO STYLE 1] to [MY PHOTO STYLE 10]	→ 208
	You can select the finishing settings of images to suit your subjects and expression styles.	
 [Metering Mode]	▶[☉]/[☁]/[☀]/[☀']	→ 184
	Type of optical measurement to measure brightness can be changed.	
[Aspect Ratio]	[4:3]/▶[3:2]/[16:9]/[1:1]/[65:24]/[2:1]	→ 83
	You can select the image aspect ratio.	
[Picture Quality]	▶[FINE]/[STD.]/[RAW+ FINE]/[RAW+STD.]/[RAW]	→ 86
	Set the compression rate used for storing pictures.	
[Picture Size]	▶[L]/[M]/[S]	→ 85
	Sets the picture's image size.	
[HLG Photo]	[Full-Res.]/[4K-Res.]/▶[OFF]	→ 225
	Records an HLG format picture with a wide dynamic range.	



 [Photo] menu →  [Image Quality]

[High Resolution Mode]	[Start]		→ 221
	[Picture Size]	▶[XL]/[LL]	
	[Picture Quality]	▶[COMBINED]/[FINE]/ [RAW+FINE]/[RAW]	
	[Simul Record Normal Shot]	▶[ON]/[OFF]	
	[Shutter Delay]	[30 SEC] to [1/8 SEC] (▶[2 SEC])/[Off]	
	[Motion Blur Processing]	▶[MODE1]/[MODE2]	
	Merges pictures with a high resolution from multiple recorded images.		
[Long Exposure NR]	▶[ON]/[OFF]		—
	 <p>The camera automatically removes noise generated when recording images with a slow shutter speed.</p> <ul style="list-style-type: none"> Recording is not possible during noise reduction. When the following functions are being used, [Long Exposure NR] is not available: <ul style="list-style-type: none"> Video recording/[6K/4K PHOTO]/[Post-Focus] [ELEC.] (Excluding [ELEC.+NR])/[Silent Mode] 		





 **[Photo] menu** →  **[Image Quality]**

[ISO Sensitivity (photo)]	[ISO Auto Lower Limit Setting]	▶[100] to [25600]	—
	[ISO Auto Upper Limit Setting]	▶[AUTO]/[200] to [51200]	
	  <p>Sets the lower and upper limits for ISO sensitivity when ISO sensitivity is set to [AUTO].</p> <ul style="list-style-type: none"> When the following function is being used, [ISO Sensitivity (photo)] is not available: <ul style="list-style-type: none"> – [Live View Composite] 		
[Min. Shutter Speed]	▶[AUTO]/[1/8000] to [1/1]		—
	  <p>Sets the minimum shutter speed when the ISO sensitivity is set to [AUTO].</p> <ul style="list-style-type: none"> The shutter speed may become slower than the set value in recording situations where correct exposure cannot be achieved. 		

 [Photo] menu →  [Image Quality]

 [i.Dynamic Range]	[AUTO]/[HIGH]/[STANDARD]/[LOW]▶[OFF]	—
	<div data-bbox="326 266 637 304" style="border: 1px solid black; padding: 2px; display: flex; justify-content: space-around; margin-bottom: 10px;"> iA P A S M  S&Q </div> <p>Contrast and exposure are compensated when the brightness difference between the background and subject is great.</p> <ul style="list-style-type: none"> • Compensation effect may not be achieved depending on the recording conditions. • When the following functions are being used, [i.Dynamic Range] is not available: <ul style="list-style-type: none"> – [Like709]/[V-Log]/[Standard(HLG)]/[Monochrome(HLG)]/[Like2100(HLG)] ([Photo Style]) – [Filter Settings] – [Live View Composite] 	



 [Photo] menu →  [Image Quality]



 [Vignetting Comp.]	<p>▶[ON]/[OFF]</p>  <p>When the screen periphery darkens as a result of the lens characteristics, you can record pictures with the brightness of the screen periphery corrected.</p> <ul style="list-style-type: none"> • Compensation effect may not be achieved depending on the recording conditions. • Noise in the periphery of the picture may stand out with higher ISO sensitivity. • When the following function is being used, [Vignetting Comp.] in the [Photo] ([Image Quality]) menu is not available: <ul style="list-style-type: none"> – [Ex. Tele Conv.] • When the following functions are being used, [Vignetting Comp.] in the [Video] ([Image Quality]) menu is not available: <ul style="list-style-type: none"> – [APS-C]*/[PIXEL/PIXEL] ([Image Area of Video]) <p>* Only when using a full-frame lens</p>	—
 [Diffraction Compensation]	<p>[AUTO]/▶[OFF]</p>  <p>The camera raises the image resolution by correcting the blurriness caused by diffraction when the aperture is closed.</p> <ul style="list-style-type: none"> • Compensation effect may not be achieved depending on the recording conditions. • Noise may stand out with higher ISO sensitivity. 	—











 [Photo] menu →  [Image Quality]



 [Filter Settings]	[Filter Effect]	[ON]/▶[OFF]/[SET]	→ 215
	[Simultaneous Record w/o Filter]	[ON]/▶[OFF]	
	This mode records with additional image effects (filters).		







 [Photo] menu →  [Focus]



[AF Custom Setting(Photo)]	▶[Set 1]/[Set 2]/[Set 3]/[Set 4]	→ 98
	Select features of AF operation when recording using [AFC] that are appropriate for the subject and scene.	
 [AF Assist Light]	▶[ON]/[OFF]	—
	 <p>When recording in low light conditions, the AF assist light turns on when you press the shutter button halfway, making it easier for the camera to focus.</p> <ul style="list-style-type: none"> The effective range of the AF assist light is different depending on the lens used. <ul style="list-style-type: none"> When the interchangeable lens (S-R2060) is attached and at wide-angle end: Approx. 1.0 m (3.3 feet) to 3.0 m (9.8 feet) Remove the lens hood. The AF assist light may be greatly blocked, and it may become harder to focus when a lens with large diameter is used. 	

 [Photo] menu →  [Focus]

  [Focus Peaking]	▶[ON]/[OFF]	—				
	<table border="1"> <tr> <td>[SET]</td> <td>[Focus Peaking Sensitivity]</td> </tr> <tr> <td></td> <td>[Display Color]</td> </tr> <tr> <td></td> <td>[Display While AFS]</td> </tr> </table> <p>    </p> <p>During MF operation, in-focus portions (portions on the screen with clear outlines) are highlighted with color.</p> <ul style="list-style-type: none"> • If the [Focus Peaking Sensitivity] is adjusted to the negative direction, portions to be highlighted are reduced, allowing you to achieve a more precise focus. • With [Display Color], you can set the display color of the in-focus portion. • When [Display While AFS] is set to [ON], the Focus Peaking display is also possible when the shutter button is pressed halfway in the [AFS] focus mode. • You can display the Touch Tab (→ 377) and then touch [PEAK] in [] to switch [ON]/[OFF]. • When [Rough Monochrome] of [Filter Settings] is being used, [Focus Peaking] is not available. • When [Live View Boost] is being used, [Focus Peaking] is not available. 		[SET]	[Focus Peaking Sensitivity]		[Display Color]
[SET]	[Focus Peaking Sensitivity]					
	[Display Color]					
	[Display While AFS]					
  [1-Area AF Moving Speed]	▶[FAST]/[NORMAL]	—				
	<p>    </p> <p>Sets the speed when moving a single AF area.</p>					





 [Photo] menu →  [Flash]

[Flash Mode]	▶[]/[]/[ S]/[ S [Ⓞ]]/[]	→ 229
	Sets the flash mode.	
[Firing Mode]	▶[TTL]/[MANUAL]	→ 232
	You can select whether to set the flash output automatically or manually.	
[Flash Adjust.]	[−3 EV] to [+3 EV] (▶[±0 EV])	→ 233
	When [Firing Mode] is set to [TTL], you can adjust the flash output.	
[Flash Synchro]	▶[1ST]/[2ND]	→ 234
	Sets the flash mode to Second Curtain Synchro.	
[Manual Flash Adjust.]	[1/128] to ▶[1/1]	→ 232
	When [Firing Mode] is set to [MANUAL], you can set the flash output.	
[Auto Exposure Comp.]	[ON]/▶[OFF]	→ 235
	Automatically adjust the flash output in conjunction with the exposure compensation value.	
[Red-Eye Removal]	[ON]/▶[OFF]	→ 231
	When [Flash Mode] is set to [] or [], the camera automatically detects red-eye and corrects image data.	
[Wireless]	[ON]/▶[OFF]	→ 237
	Enables recording using a wireless flash.	
[Wireless Channel]	▶[1CH]/[2CH]/[3CH]/[4CH]	→ 237
	Sets the channel to use when recording with a wireless flash.	

















 **[Photo] menu** →  **[Flash]**

[Wireless FP]	[ON]▶[OFF]		→ 239
	Uses FP firing for an external flash when recording with a wireless flash.		
[Communication Light]	▶[HIGH]/[STANDARD]/[LOW]		→ 239
	Set the strength of communication light.		
[Wireless Setup]	[External Flash]	[Firing Mode]/[Flash Adjust.]/[Manual Flash Adjust.]	→ 238
	[A Group]/[B Group]/[C Group]	[Firing Mode]/[Flash Adjust.]/[Manual Flash Adjust.]	
	Sets details for wireless flash recording.		

 **[Photo] menu** →  **[Others (Photo)]**

[Bracketing]	[Bracketing Type]	[]/[]/[FOCUS]/[WB ]/[WB ]▶[OFF]	→ 156
	[More Settings]		
	You can take multiple pictures while automatically adjusting a setting.		
 [Silent Mode]	[ON]▶[OFF]		→ 174
	Disables all operation sounds and light output at once.		

 [Photo] menu →  [Others (Photo)]

 [Image Stabilizer]	[Operation Mode]	▶ [] / [] / [] / [] / [OFF]	→ 177
	[Body(B.I.S.) / Lens(O.I.S.)]	[] / ▶ []	
	[When to Activate]	[ALWAYS] / ▶ [HALF-SHUTTER]	
	[E-Stabilization (Video)]	[ON] / ▶ [OFF]	
	[Boost I.S. (Video)]	[ON] / ▶ [OFF]	
	[Anamorphic (Video)]	[] / [] / [] / [] / [] / ▶ [OFF]	
	[Focal Length Set]	[0.1 mm] to [1000.0 mm] (▶ [35.0 mm])	
Configures image stabilizer settings.			
[Burst Shot 1 Setting]	[] / ▶ [H]/[M]/[L]	→ 129 → 133	
	Sets the burst recording operation of the drive mode [].		
[Burst Shot 2 Setting]	▶ [] / [H]/[M]/[L]	→ 129 → 133	
	Sets the burst recording operation of the drive mode [].		



 [Photo] menu →  [Others (Photo)]

[Shutter Type]	[AUTO]▶[MECH.]/[EFC]/[ELEC.]/[ELEC.+NR]	→ 175
	Selects the shutter type to use for taking pictures.	
[Shutter Delay]	[8SEC]/[4SEC]/[2SEC]/[1SEC]▶[OFF]	—
	 <p>To reduce camera shake and shutter-induced blur, the shutter is released after the specified time has passed since the shutter button was pressed.</p> <ul style="list-style-type: none"> • When the following functions are being used, [Shutter Delay] is not available: <ul style="list-style-type: none"> – Video recording/[6K/4K PHOTO]/[Post-Focus] – [High Resolution Mode] – [Live View Composite] 	
[Ex. Tele Conv.]	[ZOOM]/[TELE CONV.]▶[OFF]	→ 125
	You can take pictures that are further enlarged beyond what is available with the optical zoom, without any deterioration in image quality.	
[Time Lapse/ Animation]	[Mode] ▶[Time Lapse Shot]	→ 145 → 149
	[Stop Motion Animation]	
	Time Lapse Shot automatically starts/stops recording at a set recording interval. Stop Motion Animation enables you to take pictures while moving the subject little by little.	

 [Photo] menu →  [Others (Photo)]

[Live View Composite]	[Start]		→ 162
	[Shutter Delay]	[8 SEC]/[4 SEC]/[2 SEC]/ [1 SEC]/▶[OFF]	
	Images are recorded over several times and only the parts that change to become brighter form part of the composition.		
[Self Timer]	▶[10]/[10]/[2]		→ 154
	Sets the self-timer duration.		
[6K/4K PHOTO]	[Picture Size / Burst Speed]	▶[6K 18M]/[4K H 8M]/[4K 8M]	→ 133
	[Rec Method]	▶[6K/4K Burst]/[6K/4K Burst(S/S)]/[6K/4K Pre-Burst]	
	[Pre-Burst Recording]	[ON]/▶[OFF]	
	Sets 6K/4K photos. You can save pictures extracted from a burst file taken using high-speed burst.		

 [Photo] menu →  [Others (Photo)]

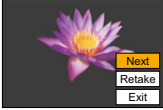
[Post-Focus]	<p>[6K 18M]/[4K 8M]▶[OFF]</p> <p>Taking burst pictures with the same image quality as 6K/4K photos while automatically changing the focus point.</p> <p>You can select the focus point for the picture to save after recording.</p>	→ 166				
[Multiple Exposure]	<p>[Start]</p> <table border="1" data-bbox="319 474 860 555"> <tr> <td>[Auto Gain]</td> <td>▶[ON]/[OFF]</td> </tr> <tr> <td>[Overlay]</td> <td>[ON]▶[OFF]</td> </tr> </table> <p> </p> <p>You can apply an effect equivalent to four exposures on a single image.</p> <p>[Start]: Starts exposure for multiple exposures.</p> <p>[Auto Gain]: Automatically adjusts brightness in accordance with image count.</p> <p>[Overlay]: Allows multiple exposure for recorded RAW images. After selecting [Start], a selection screen for images to stack is displayed.</p> <ul style="list-style-type: none"> • After selecting [Start], pressing the shutter button fully starts multiple exposure. • Preview is displayed for each recording, and the following operations are available: <ul style="list-style-type: none"> – [Next] (You can also perform the same operation by pressing the shutter button halfway.) – [Retake] – [Exit]: Records the picture, and finishes multiple exposure recording. <div data-bbox="629 1074 854 1224" style="text-align: right;">  </div>	[Auto Gain]	▶[ON]/[OFF]	[Overlay]	[ON]▶[OFF]	—
[Auto Gain]	▶[ON]/[OFF]					
[Overlay]	[ON]▶[OFF]					

 [Photo] menu →  [Others (Photo)]

**[Multiple Exposure]
(Continued)**

- To finish multiple exposure recording before starting the recording, press [Q] on the recording screen.
- Recording information for the last-recorded image will be saved as recording information for images recorded with multiple exposures.
- [Overlay] can be set only for RAW images recorded with the camera.
- For RAW images recorded using the following functions, [Overlay] cannot be set:
 - [65:24]/[2:1] ([Aspect Ratio])
 - [HLG Photo]
 - [High Resolution Mode]
- When the following functions are being used, [Multiple Exposure] is not available:
 - [Time Lapse Shot]
 - [Stop Motion Animation]
 - [High Resolution Mode]
 - [Filter Settings]
 - [Live View Composite]
 - HDMI output
- When using APS-C lenses, [Multiple Exposure] is not available.

—



[Video] Menu





: Menu items common to the [Photo] menu and [Video] menu. Their settings are synchronized.

▶: Default settings

[Video] menu → [Image Quality]



[Exposure Mode]	▶[P]/[A]/[S]/[M]	→ 245	
	Sets the exposure mode to use in [M]/[S&Q] mode.		
 [Photo Style]	▶[Standard]/[Vivid]/[Natural]/[Flat]/[Landscape]/ [Portrait]/[Monochrome]/[L.Monochrome]/ [L.Monochrome D]/[Cinelike D2]/[Cinelike V2]/ [Like709]/[V-Log]/[Standard(HLG)]/ [Monochrome(HLG)]/[Like2100(HLG)]/[MY PHOTO STYLE 1] to [MY PHOTO STYLE 10]	→ 208	
	You can select the finishing settings of images to suit your subjects and expression styles.		
 [Metering Mode]	▶///	→ 184	
[ISO Sensitivity (video)]	[ISO Auto Lower Limit Setting]	▶[100] to [25600]	→ 262
	[ISO Auto Upper Limit Setting]	▶[AUTO]/[200] to [51200]	
	Sets the lower and upper limits for ISO sensitivity when ISO sensitivity is set to [AUTO].		



 [Video] menu →  [Image Quality]



[Flicker Decrease (Video)]	[1/50]/[1/60]/[1/100]/[1/120]▶[OFF]		—
	 <p>The shutter speed can be fixed to reduce the flicker or striping in the video.</p> <ul style="list-style-type: none"> This can be set when [Auto Exposure in P/A/S/M] is [ON]. 		
 [i.Dynamic Range]	[AUTO]/[HIGH]/[STANDARD]/[LOW]▶[OFF]		→ 353
 [Vignetting Comp.]	▶[ON]/[OFF]		→ 354
 [Diffraction Compensation]	[AUTO]▶[OFF]		→ 354
 [Filter Settings]	[Filter Effect]	[ON]▶[OFF]/[SET]	→ 215
	[Simultaneous Record w/o Filter]	[ON]▶[OFF]	
	This mode records with additional image effects (filters).		

 **[Video] menu** →  **[Image Format]**



[Image Area of Video]	▶[FULL]/[APS-C]/[PIXEL/PIXEL]		→ 249
	Sets the image area during video recording.		
[Rec Quality]	Sets the video recording image quality.		→ 250
[Slow & Quick Setting]	[1fps] to [180fps] (▶[30fps])		→ 270
	Varies the recording frame rate to record slow motion video and quick motion video.		
[Switch NTSC/PAL]	▶[NTSC]/[PAL]		→ 248
	The image qualities you can select in [Rec Quality] are switched to the image qualities with the frame rate to suit the NTSC/PAL TV broadcast system.		
[Rec. File Format]	▶[MP4]/[MOV]		→ 249
	Sets the video recording file format.		
[Time Code]	[Time Code Display]	[ON]/▶[OFF]	→ 254
	[Count Up]	▶[REC RUN]/[FREE RUN]	
	[Time Code Value]	[Reset]	
		[Manual Input]	
		[Current Time]	
	[Time Code Mode]	▶[DF]/[NDF]	
	[HDMI Time Code Output]	[ON]/▶[OFF]	
Sets the recording, display, and output of the time code.			
[Luminance Level]	[0-255]/[16-235]/▶[16-255]		→ 259
	You can set the luminance range to suit the purpose of video recording.		
[Anamorphic(4:3)]	Sets the image quality of anamorphic (4:3) videos.		→ 284

 [Video] menu →  [Focus]

[AF Custom Setting(Video)]	[ON]▶[OFF]		→ 258
	[SET]	[AF Speed] [AF Sensitivity]	
	You can fine-adjust the focusing method for video recording using [Continuous AF].		
[Continuous AF]	▶[MODE1]/[MODE2]/[OFF]		→ 256
	You can select how to set the focus in AF when recording videos.		
 [AF Assist Light]	▶[ON]/[OFF]		→ 355
	When recording in low light conditions, the AF assist light turns on when you press the shutter button halfway, making it easier for the camera to focus.		
 [Focus Peaking]	▶[ON]/[OFF]		→ 356
	[SET]	[Focus Peaking Sensitivity] [Display Color] [Display While AFS]	
	During MF operation, in-focus portions (portions on the screen with clear outlines) are highlighted with color.		
 [1-Area AF Moving Speed]	▶[FAST]/[NORMAL]		→ 356
	Sets the speed when moving a single AF area.		













 [Video] menu →  [Audio]

[Sound Rec Level Disp.]	▶[ON]/▶[OFF]	→ 263
	The sound recording level is displayed on the recording screen.	
[Sound Rec Level Adj.]	[MUTE]/[- 12dB] to [+6dB] (▶[0dB])	→ 263
	Manually adjust the sound recording level.	
[Sound Rec Level Limiter]	▶[ON]/[OFF]	→ 263
	The sound recording level is adjusted automatically to minimize sound distortion (crackling noise).	
[Wind Noise Canceller]	[HIGH]/▶[STANDARD]/[OFF]	→ 263
	This reduces the wind noise coming into the built-in microphone while maintaining sound quality.	
[Wind Cut]	[HIGH]/[STANDARD]/[LOW]/▶[OFF]	→ 295
	This reduces wind noise when an external microphone is connected.	
[Mic Socket]	▶[MIC]▼/[MIC]/[LINE]	→ 293
	Sets the [MIC] socket input method that suits the device to be connected.	
[Special Mic.]	▶[STEREO]/[LENS AUTO]/[SHOTGUN]/[S.SHOTGUN]/[MANUAL]	→ 294
	Sets the sound pickup range when using the Stereo Shotgun Microphone (DMW-MS2: optional).	
[XLR Mic Adaptor Setting]	▶[ON]/[OFF]	→ 296
	Enables recording from the XLR Microphone Adaptor (DMW-XLR1: optional).	
[Sound Output]	▶[REALTIME]/[REC SOUND]	→ 298
	Sets the audio output method when headphones are connected.	

 [Video] menu →  [Audio]

[Headphone Volume]	[0] to [LEVEL15] (▶[LEVEL3])	→ 299
	Adjusts the volume when headphones are connected.	

 [Video] menu →  [Others (Video)]

 [Silent Mode]	[ON]▶[OFF]	→ 174	
	Disables all operation sounds and light output at once.		
 [Image Stabilizer]	[Operation Mode]	▶[]/[] /[]/[OFF]	→ 177
	[Body(B.I.S.) / Lens(O.I.S.)]	[]▶[]	
	[When to Activate]	[ALWAYS]/ ▶[HALF-SHUTTER]	
	[E-Stabilization (Video)]	[ON]▶[OFF]	
	[Boost I.S. (Video)]	[ON]▶[OFF]	
	[Anamorphic (Video)]	A2.0 A1.8 A1.5 []/[]/[]/ A1.33 A1.30 []/[]▶[OFF]	
	[Focal Length Set]	[0.1 mm] to [1000.0 mm] (▶[35.0 mm])	
	Configures image stabilizer settings.		
[Live Cropping]	[40SEC]/[20SEC]▶[OFF]	→ 272	
	By cropping a part of the range displayed in the live view, it is possible to record FHD video that incorporates panning and zooming with the camera staying in a fixed position.		



[Custom] Menu

▶: Default settings













[Custom] menu →  [Image Quality]

[Photo Style Settings]	[Show/Hide Photo Style]	[Vivid]/[Natural]/[Flat]/[Landscape]/[Portrait]/[L.Monochrome]/[L.Monochrome D]/[Cinelike D2]/[Cinelike V2]/[Like709]/[V-Log]/[Like2100(HLG)]/[MY PHOTO STYLE 1] to [MY PHOTO STYLE 10]
	Sets Photo Style items to be displayed on the menu.	
	[My Photo Style Settings]	[Add Effects] [Load Preset Setting]
	Enables detailed image quality adjustment settings for My Photo Style. [Add Effects]: Enables [Sensitivity] and [White Balance] settings in image quality adjustment. [Load Preset Setting]: Sets the timing at which image quality adjustment values changed in My Photo Style are returned to their registered state.	
	[Reset Photo Style]	Returns details changed in [Photo Style] and [Photo Style Settings] to their default settings.
[ISO Increments]	▶[1/3 EV]/[1 EV]	
	Changes the intervals between ISO sensitivity adjustment values.	

 [Custom] menu →  [Image Quality]

[Extended ISO]	[ON]▶[OFF]	
[Exposure Offset Adjust.]	[Multi Metering]	[− 1EV] to [+ 1EV] (▶[±0EV])
	[Center Weighted]	[− 1EV] to [+ 1EV] (▶[±0EV])
	[Spot]	[− 1EV] to [+ 1EV] (▶[±0EV])
	[Highlight Weighted]	[− 1EV] to [+ 1EV] (▶[±0EV])
	<p>Adjusts the exposure level that is the standard exposure for each setting item of [Metering Mode].</p> <p>Adds the adjustment value from this function to the exposure compensation value (→ 196) when recording.</p> <ul style="list-style-type: none"> • For video recording, [6K/4K PHOTO], and [Post-Focus], it is not possible to add an adjustment value of a range that exceeds ±3 EV. 	
[Color Space]	▶[sRGB]/[AdobeRGB]	
	<p>This sets the method for correcting the color reproduction of the recorded images on the screens of a PC or on a device such as a printer.</p> <p>[sRGB]: This is widely used in PCs and similar devices.</p> <p>[AdobeRGB]: AdobeRGB is mainly used for business purposes such as professional printing because it has a greater range of reproducible colors than sRGB.</p> <ul style="list-style-type: none"> • Set to [sRGB] if you are not very familiar with AdobeRGB. • When the following functions are being used, the setting is fixed to [sRGB]: <ul style="list-style-type: none"> – Video recording/[6K/4K PHOTO]/[Post-Focus] – [Like709]/[V-Log] ([Photo Style]) – [Filter Settings] 	



 [Custom] menu →  [Image Quality]

[Exposure Comp. Reset]	[ON]▶[OFF] This resets the exposure value when you change the recording mode or turn off the camera.	
[Auto Exposure in P/A/S/M]	▶[ON]/[OFF] Selects the setting method for aperture value, shutter speed, and ISO sensitivity for the video being recorded in the [P]/[A]/[S]/[M] modes. [ON]: Records with values set automatically by the camera. [OFF]: Records with manually set values.	
[CreativeVideo Combined Set.]	[F/SS/ISO/Exposure Comp.]	▶ []/[]
	[White Balance]	▶ []/[]
	[Photo Style]	▶ []/[]
	[Metering Mode]	▶ []/[]
	[AF Mode]	▶ []/[]
	Content set in [ M]/[S&Q] mode can be separated from when taking pictures. • For details, refer to page 247 .	

 [Custom] menu ➔  [Focus/Shutter]

	[AFS]	▶[FOCUS]/[BALANCE]/[RELEASE]
	[AFC]	[FOCUS]/▶[BALANCE]/[RELEASE]
[Focus/Shutter Priority]	<p>This sets whether to give priority to focus or shutter release during AF.</p> <p>[FOCUS]: Disables recording when focus is not achieved.</p> <p>[BALANCE]: Performs recording while controlling the balance between focusing and shutter release timing.</p> <p>[RELEASE]: Enables recording even when focus is not achieved.</p>	
[Focus Switching for Vert / Hor]	[ON]/▶[OFF]	
	<p>This stores separate AF area positions (MF positions for MF Assist) for when the camera is held vertically and when it is held horizontally.</p> <ul style="list-style-type: none"> • For details, refer to page 119. 	
[AF/AE Lock Hold]	[ON]/▶[OFF]	
	<p>This sets button operations for AF/AE Lock.</p> <p>Turning this [ON] maintains the lock after releasing the button until it is pressed again.</p>	
[AF+MF]	[ON]/▶[OFF]	
	<p>You can fine-adjust the focus manually during AF Lock by rotating the focus ring.</p> <ul style="list-style-type: none"> – When focus mode is [AFS]/[AFC], and the shutter button is pressed halfway – When [AF ON] is pressed – When locked using the Fn button [AF LOCK] or [AF/AE LOCK] 	

 [Custom] menu ➔  [Focus/Shutter]

	[Focus Ring]	▶[ON]/[OFF]
	[AF Mode]	▶[ON]/[OFF]
	[Press Joystick]	[ON]/▶[OFF]
	[MF Assist Display]	[FULL]/▶[PIP]
[MF Assist]	<p>This sets the display method of MF Assist (enlarged screen).</p> <p>[Focus Ring]: The screen is enlarged by focusing with the lens.</p> <p>[AF Mode]: The screen is enlarged by pressing [].</p> <p>[Press Joystick]: Press the joystick to enlarge the display. (if [Joystick Setting] is set to [D.FOCUS Movement]) (➔ 381)</p> <p>[MF Assist Display]: Sets the display method (full screen mode/windowed mode) of MF Assist (enlarged screen).</p> <ul style="list-style-type: none"> • While you are using the following functions, MF Assist will not be displayed: <ul style="list-style-type: none"> – Video recording – [6K/4K Pre-Burst] 	
[MF Guide]	[]/▶[]/[OFF]	
	<p>During MF, MF Guide, which acts as a guide to recording distance, is displayed on the screen. You can select from meters or feet for the display unit.</p>	
[Focus Ring Lock]	[ON]/▶[OFF]	
	<p>This disables the focus ring operation during MF to lock the focus.</p> <ul style="list-style-type: none"> • [MFL] is displayed on the recording screen while the focus ring is locked. 	

 [Custom] menu ➔  [Focus/Shutter]

[Show/Hide AF Mode]	[Face/Eye/Body/Animal Detect.]	▶[ON]/[OFF]
	[Tracking]	▶[ON]/[OFF]
	[225-Area]	▶[ON]/[OFF]
	[Zone (Vert./ Horz.)]	▶[ON]/[OFF]
	[Zone (Square)]	[ON]/▶[OFF]
	[Zone (Oval)]	▶[ON]/[OFF]
	[1-Area+]	▶[ON]/[OFF]
	[Pinpoint]	▶[ON]/[OFF]
	[Custom1]	[ON]/▶[OFF]
	[Custom2]	[ON]/▶[OFF]
	[Custom3]	[ON]/▶[OFF]
Sets the AF mode items to be displayed on the AF mode selection screen.		
[Pinpoint AF Setting]	[Pinpoint AF Time]	[LONG]/▶[MID]/[SHORT]
	[Pinpoint AF Display]	[FULL]/▶[PIP]
	Changes enlarged screen settings displayed when AF mode is []. [Pinpoint AF Time]: Sets the time for which the screen is enlarged when the shutter button is pressed halfway. [Pinpoint AF Display]: Sets the display method (full screen mode/windowed mode) of the enlarged screen.	

 [Custom] menu ➔  [Focus/Shutter]



[AF-Point Scope Setting]	[Keep Enlarged Display]	[ON]▶[OFF]
	[PIP Display]	[FULL]▶[PIP]
	<p>Changes the enlarged screen settings of AF-Point Scope (➔ 97).</p> <p>[Keep Enlarged Display]: Setting this to [ON] maintains the enlarged screen after pressing the Fn button until it is pressed again.</p> <p>[PIP Display]: Sets the display method (full screen mode/ windowed mode) of the enlarged screen.</p>	
[Shutter AF]	▶[ON]/[OFF]	
	This adjusts focus automatically when you press the shutter button halfway.	
[Half-Press Shutter]	[ON]▶[OFF]	
	You can release the shutter quickly by pressing the shutter button halfway.	
[Quick AF]	[ON]▶[OFF]	
	<p>When the amount of camera shake becomes small, the camera will automatically adjust the focus and focus adjustment will then be quicker when the shutter button is pressed.</p> <ul style="list-style-type: none"> • The battery will drain faster than usual. • This function is not available in the following cases: <ul style="list-style-type: none"> – In preview mode – In low light situations 	
[Eye Sensor AF]	[ON]▶[OFF]	
	<p>When looking through the viewfinder, if the eye sensor operates, then AF will function.</p> <ul style="list-style-type: none"> • [Eye Sensor AF] may not work in low light situations. 	















[Custom] menu ➔ [Focus/Shutter]



[Looped Focus Frame]	<p>[ON]▶[OFF]</p> <p>When moving the AF area or MF Assist, this enables its position to loop from one edge to the other edge of the screen.</p>
[AFC Start Point (225-Area)]	<p>[ON]▶[OFF]</p> <p>When the focus mode is set to [AFC] in the [] AF mode, you can specify which area to start [AFC].</p> <ul style="list-style-type: none"> • For details, refer to page 107.





















[Custom] menu ➔ [Operation]



[Q.MENU Settings]	[Layout Style]	▶[MODE1]/[MODE2]
	[Front Dial Assignment]	[Item]▶[Value]
	[Item Customize (Photo)]	
	[Item Customize (Video)]	
	<p>Customizes the Quick menu.</p> <ul style="list-style-type: none"> • For details, refer to page 332. 	
[Touch Settings]	[Touch Screen]	▶[ON]/[OFF]
	[Touch Tab]	[ON]▶[OFF]
	[Touch AF]	▶[AF]/[AF+AE]
	[Touch Pad AF]	[EXACT]/[OFFSET1] to [OFFSET7]/▶[OFF]
	<p>Enables touch operation on the monitor display.</p> <p>[Touch Screen]: All touch operations.</p> <p>[Touch Tab]: Operations of tabs, such as [] on the right side of the screen.</p> <p>[Touch AF]: Operation to optimize the focus ([AF]) for a touched subject. Alternatively, operation to optimize both the focus and brightness ([AF+AE]). (→ 116)</p> <p>[Touch Pad AF]: Touch pad operation during viewfinder display. (→ 118)</p>	























 [Custom] menu ➔  [Operation]



[Operation Lock Setup]	[Cursor]	▶[]/[]
	[Joystick]	▶[]/[]
	[Touch Screen]	▶[]/[]
	[Dial]	▶[]/[]
	[DISP. Button]	▶[]/[]
	<p>This sets the control functions to be disabled with the Fn button [Operation Lock]. (Only for recording screen)</p> <p>[Cursor]: Cursor buttons, [MENU/SET] button, and </p> <p>[Joystick]: Joystick</p> <p>[Touch Screen]: Touch screen</p> <p>[Dial]: , , and </p> <p>[DISP. Button]: [DISP.] button</p>	
[Fn Button Set]	[Setting in REC mode]	
	[Setting in PLAY mode]	
	<p>Registers a function to the Fn button.</p> <ul style="list-style-type: none"> • For details, refer to page 323. 	

















 [Custom] menu →  [Operation]

[WB/ISO/Expo. Button]	<p>[WHILE PRESSING]/[AFTER PRESSING1]▶[AFTER PRESSING2]</p> <p>This sets the operation to be performed when [WB] (White balance), [ISO] (ISO sensitivity) or [] (Exposure compensation) is pressed.</p> <p>[WHILE PRESSING]: Allows you to change the setting while pressing and holding the button. Release the button to confirm the settings value, and to return to the recording screen.</p> <p>[AFTER PRESSING1]: Press the button to change settings. Press the button again to confirm the settings value, and to return to the recording screen.</p> <p>[AFTER PRESSING2]: Press the button to change settings. Each press of the button switches the settings value. (Except that of exposure compensation) To confirm your selection and return to the recording screen, press the shutter button halfway.</p>
[ISO Displayed Setting]	<p>[Front/Rear Dials] ▶ [ / ] / [ / ] / [OFF/ ] / [ / ] / [ /OFF]</p> <p>This sets the operations of the dials in the setting screen for ISO sensitivity. Assigning [] lets you change [ISO Auto Upper Limit Setting].</p>
[Exposure Comp. Disp. Setting]	<p>[Cursor Buttons (Up/Down)] []▶[OFF]</p> <p>This sets the operations of the ▲▼ buttons in the exposure compensation screen. Assigning [] lets you set exposure bracketing.</p> <p>[Front/Rear Dials] ▶ [ / ] / [ / ] / [OFF/ ] / [ / ] / [ /OFF]</p> <p>This sets the operations of the dials in the exposure compensation screen. Assigning [] lets you adjust flash output.</p>

 [Custom] menu →  [Operation]

[Dial Set.]	[Assign Dial (F/SS)]	▶[SET1]/[SET2]/[SET3]/[SET4]/[SET5]				
	Sets the operations to be assigned to the dials in [P]/[A]/[S]/[M] modes.					
	P/↗: Program Shift, F: Aperture value, SS: Shutter speed					
			[P]	[A]	[S]	[M]
	[SET1]		P/↗	F	SS	F
			P/↗	F	SS	SS
	[SET2]		–	F	–	F
			P/↗	–	SS	SS
	[SET3]		–	–	SS	SS
			P/↗	F	–	F
[SET4]		–	–	–	F	
		P/↗	F	SS	SS	
[SET5]		P/↗	F	SS	F	
		–	–	–	SS	
[Rotation (F/SS)]	▶   /[ 					
Changes the rotational directions of the dials for aperture value and shutter speed adjustment.						
[Control Dial Assignment]	▶[] ([Headphone Volume])/[]/[] ([Exposure / Aperture])/[] ([Exposure Comp.])/[] ([Sensitivity])/[] ([Focus Frame Size])					
Sets the function to be assigned to  on the recording screen.						
[]/[]: In [M] mode, this assigns the operation to adjust the aperture value. In other than [M] mode, this assigns the operation of exposure compensation.						

 [Custom] menu ➔  [Operation]

[Dial Set.] (Continued)	[Exposure Comp.]	[]/[]/▶[OFF]
	Assigns exposure compensation to  or  . (Except in [M] mode)	
	• The [Assign Dial (F/SS)] setting takes priority.	
	[Dial Operation Switch Setup]	[] []
In the Fn button [Dial Operation Switch], this sets the functions to be registered temporarily to  or  . (➔ 330)		
[Rotation (Menu Operation)]	▶[]/[]/[]/[]/ []/[]/[]/[]	
Changes the rotational direction of the dials when operating menus.		
[Joystick Setting]	▶[D.FOCUS Movement]/[Fn]/[MENU]/[OFF]	
	Sets the joystick movement on the recording screen.	
	[D.FOCUS Movement]: Moves the AF area and MF Assist. (➔ 115, 120)	
	[Fn]: Operates as Fn buttons. [MENU]: Operates as  . Operations that can be performed by moving the joystick are disabled. [OFF]: Disables the joystick.	
[Video Rec. Button (Remote)]	You can register a favorite function to the video rec. button on a Shutter Remote Control (optional).	
• [Video Record] is registered in the default setting.		
• For details, refer to page 491.		

 [Custom] menu ➔  [Monitor / Display (Photo)]

	[Duration Time (photo)]	[HOLD]/[5SEC] to [0.5SEC]/▶[OFF]
	[Duration Time (6K/4K PHOTO)]	▶[HOLD]/[OFF]
	[Duration Time (Post-Focus)]	▶[HOLD]/[OFF]
	[Playback Operation Priority]	[ON]/▶[OFF]
[Auto Review]	This displays an image immediately after it is recorded.	
	[Duration Time (photo)]: Sets the Auto Review time when taking pictures.	
	[Duration Time (6K/4K PHOTO)]: Sets the Auto Review when recording 6K/4K photos.	
	[Duration Time (Post-Focus)]: Sets the Auto Review when recording with Post-Focus.	
	[Playback Operation Priority]: When this is set to [ON], you can toggle the playback screen during Auto Review, or delete pictures.	
	<ul style="list-style-type: none"> • If you set [Duration Time (photo)] to [HOLD], the image recorded stays displayed until the shutter button is pressed halfway. 	
	[Playback Operation Priority] will be fixed to [ON].	

 [Custom] menu →  [Monitor / Display (Photo)]

[Constant Preview]	[ON]▶[OFF]	
	[SET]	[Effect]
		[Preview While MF Assist]
	<p>You can always confirm the effects of aperture on the recording screen when in [A]/[M] mode.</p> <p>You can also confirm the shutter speed at the same time when in [M] mode.</p> <ul style="list-style-type: none"> • You can set the combination of the aperture effect and the shutter speed effect in [Effect]. • Preview also operates in the MF Assist screen when [Preview While MF Assist] is set to [ON]. • The preview of the shutter speed effect does not work when using a flash. 	

⚙ [Custom] menu → 📺 [Monitor / Display (Photo)]
[Histogram]
[ON]▶[OFF]

This displays the histogram.

Turning this [ON] displays the histogram transition screen.

Press ▲▼◀▶ to set the position.

- You can also move the position by dragging the histogram on the recording screen.
- A histogram is a graph that displays brightness along the horizontal axis, and the number of pixels at each brightness level on the vertical axis. By looking at the distribution of the graph, you can determine the current exposure.

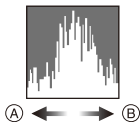







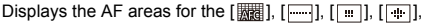

Ⓐ Dark

Ⓑ Bright

- When the recorded image and the histogram do not match each other under the following conditions, the histogram is displayed in orange:
 - During exposure compensation
 - When the flash fires
 - When the standard exposure is not achieved, such as in low light situations.
- When the following function is being used, the [Histogram] is not available:
 - [Waveform Monitor]
- The histogram is an approximation in the recording mode.







⚙ [Custom] menu → 📺 [Monitor / Display (Photo)]

[Photo Grid Line]								
	<p>Sets the grid line pattern to be displayed on the recording screen.</p> <p>When using , you can press ▲▼◀▶ to set the position.</p> <ul style="list-style-type: none"> When using , you can also drag  on the grid lines on the recording screen to move the position. 							
[Frame Marker]	<p>[ON]▶[OFF]</p> <table border="1" data-bbox="311 517 970 643"> <tbody> <tr> <td data-bbox="311 517 560 555">[SET]</td> <td data-bbox="560 517 970 555">[Frame Aspect]</td> </tr> <tr> <td></td> <td data-bbox="560 555 970 594">[Frame Color]</td> </tr> <tr> <td></td> <td data-bbox="560 594 970 643">[Frame Mask]</td> </tr> </tbody> </table> <p>A frame with the set aspect ratio is displayed on the recording screen.</p> <ul style="list-style-type: none"> For details, refer to page 268. 		[SET]	[Frame Aspect]		[Frame Color]		[Frame Mask]
[SET]	[Frame Aspect]							
	[Frame Color]							
	[Frame Mask]							
[AF Area Display]	<p>▶[ON]/[OFF]</p> <p>Displays the AF areas for the ,  to  AF modes.</p> <ul style="list-style-type: none"> AF areas are not displayed in the following cases: <ul style="list-style-type: none"> When [AFC Start Point (225-Area)] is not used during  When AF area shapes are not registered in  to  When the following functions are being used, [AF Area Display] is not available: <ul style="list-style-type: none"> Video recording [6K/4K PHOTO] 							

 [Custom] menu ➔  [Monitor / Display (Photo)]

	[MODE1]/[MODE2]▶[OFF]	
	[SET]	[P/A/S/M]▶[M]
[Live View Boost]	<p>Displays the screen brighter to make it easier to check subjects and compositions even in low-light environment.</p> <p>[MODE1]: Setting for low brightness, with priority given to a soft display.</p> <p>[MODE2]: Setting for high brightness, with priority given to image visibility.</p> <ul style="list-style-type: none"> • You can change the recording mode in which [Live View Boost] works by using [SET]. • This mode does not affect recorded images. • Noise may be more noticeable in the screen than in the recorded image. • This function does not work in the following cases: <ul style="list-style-type: none"> – When adjusting the exposure (when the shutter button is pressed halfway, for example) – When recording a video or 6K/4K photo – When using [Filter Settings] – When displaying the shutter speed effect of [Constant Preview] in the [M] mode 	

 [Custom] menu ➔  [Monitor / Display (Photo)]

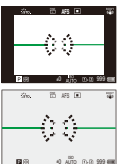
	[Monitor]	[ON]/▶[OFF]
	[LVF]	[ON]/▶[OFF]
[Night Mode]	<p>Displays the monitor and viewfinder in red. In dark environments, this reduces brightness of the screen that can make the surroundings difficult to see. You can also set the luminance of the red display.</p> <ol style="list-style-type: none"> Press ▲▼◀▶ to select [ON] on the monitor or viewfinder (LVF). Press [DISP.] to display the brightness adjustment screen. <ul style="list-style-type: none"> Display the monitor to adjust the monitor, and display the viewfinder to adjust the viewfinder. Press ◀▶ to adjust luminance and then press  or . <ul style="list-style-type: none"> This effect is not applied to images output via HDMI. 	
	[LVF/Monitor Disp. Set]	[LVF Disp. Set]
[Monitor Disp. Set]		 ▶ 
<p>Selects whether to show the live view without covering the information display, or to display over the entire screen.</p> <p>: Scales down images slightly so you can better review the composition of the images.</p> <p>: Scales images to fill the entire screen so you can see their details.</p>		
		

⚙ [Custom] menu → 📷 [Monitor / Display (Photo)]

[Expo.Meter]	[ON]▶[OFF]											
	<p>This displays the exposure meter.</p> <div data-bbox="467 309 817 420" style="border: 1px solid black; padding: 5px; margin: 10px auto; width: fit-content;"> <table style="border-collapse: collapse; text-align: center;"> <tr> <td style="border-right: 1px solid black; padding: 2px 5px;">SS</td> <td style="padding: 2px 5px;">125</td> <td style="padding: 2px 5px;">60</td> <td style="padding: 2px 5px;">30</td> <td style="padding: 2px 5px;">15</td> <td style="padding: 2px 5px;">8</td> </tr> <tr> <td style="border-right: 1px solid black; padding: 2px 5px;">F</td> <td style="padding: 2px 5px;">4.0</td> <td style="padding: 2px 5px;">5.6</td> <td style="padding: 2px 5px;">8.0</td> <td style="padding: 2px 5px;">11</td> <td></td> </tr> </table> <p style="margin-top: 5px; font-size: small;">🔑 30 F5.6</p> </div> <ul style="list-style-type: none"> • Set to [ON] to display the exposure meter when performing Program Shift, setting aperture, and setting shutter speed. • If no operations are performed for a certain period of time, the exposure meter disappears. 	SS	125	60	30	15	8	F	4.0	5.6	8.0	11
SS	125	60	30	15	8							
F	4.0	5.6	8.0	11								
[Focal Length]	▶[ON]/[OFF]											
	<p>Displays the focal length on the recording screen during zoom control.</p>											
[Photo/Video Preview]	▶[📷]/[👤]											
	<p>Switches the live view angle of view.</p> <p>[📷]: Displays the recording area according to the angle of view for picture-taking.</p> <p>[👤]: Displays the recording area according to the angle of view for video recording.</p> <ul style="list-style-type: none"> • Angle of view display is a guideline. • When the following functions are being used, [Photo/Video Preview] is fixed to [📷]: <ul style="list-style-type: none"> – [6K/4K PHOTO]/[Post-Focus] – [65:24]/[2:1] ([Aspect Ratio]) – [HLG Photo] 											

⚙️ [Custom] menu ➡️ 📺 [Monitor / Display (Photo)]

[Photos/Videos Remaining]

▶ [📷:📺]/[👤:🕒]

This will switch display between the number of recordable pictures and available recording time.

[📷:📺]: Displays the number of recordable pictures.

[👤:🕒]: Displays the available recording time for video.

- Even when this is set to [👤:🕒], the number of recordable pictures is displayed for a while after a picture is taken.
- When the following functions are being used, [Photos/Videos Remaining] is fixed to [📷:📺]:
 - [65:24]/[2:1] ([Aspect Ratio])
 - [HLG Photo]
- When the following functions are being used, [Photos/Videos Remaining] operates as [👤:🕒]:
 - [6K/4K Burst]/[6K/4K Burst(S/S)]/[Post-Focus]

[Blinking Highlights]



[ON]▶[OFF]

Overexposed areas appear blinking in black and white during Auto Review or playback.

- The display without the highlights is added to the display shown when [DISP.] is pressed in the playback screen. Use this to delete the highlight display. (→ 68)



⚙️ [Custom] menu ➡️ 📺 [Monitor / Display (Photo)]

[Sheer Overlay]	[ON]▶️[OFF]	
	[SET]	[Transparency] [Image Select] [Reset at Power Off] [Disp. Image (shutter-press)]
<p>Displays recorded pictures by overlapping on the recording screen.</p> <ul style="list-style-type: none"> • Use [Image Select] to select the pictures to be displayed. Press ◀️▶️ to select pictures and then press  or  to confirm. • If you set [Disp. Image (shutter-press)] to [OFF], [Sheer Overlay] is canceled while the shutter button is being pressed halfway or pressed fully. • When the following functions are being used, [Sheer Overlay] is not available: <ul style="list-style-type: none"> – Video recording/[6K/4K PHOTO]/[Post-Focus] 		
[I.S. Status Scope]	[ON]▶️[OFF]	
	<p>Displays a reference point (A) on the recording screen in order to let you check for camera shake.</p> <ul style="list-style-type: none"> • When the following functions are being used, [I.S. Status Scope] is not available: <ul style="list-style-type: none"> – Video recording/[6K/4K PHOTO]/[Post-Focus] 	

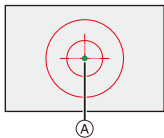

⚙️ [Custom] menu ➡️ 📺 [Monitor / Display (Photo)]

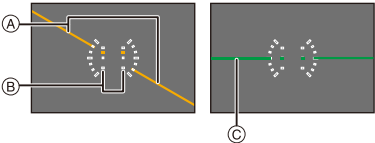
[Level Gauge]	▶[ON]/[OFF]	
	<p>Displays the level gauge which is useful in correcting camera tilt.</p>  <p>(A) Horizontal (B) Vertical (C) Green (no tilt)</p> <ul style="list-style-type: none"> • Even after correcting the tilt, there may still be an error of approx. $\pm 1^\circ$. • When the camera is tilted significantly upwards or downwards, the level gauge may not be displayed correctly. • You can adjust the level gauge and reset the adjusted values in [Level Gauge Adjust.] in the [Setup] ([Monitor / Display]) menu. (➔ 398) 	
[Luminance Spot Meter]	<p>[ON]▶[OFF]</p> <p>Specify any spot on the subject to measure the luminance over a small area.</p> <ul style="list-style-type: none"> • For details, refer to page 266. 	
[Framing Outline]	<p>[ON]▶[OFF]</p> <p>Displays the outline for the live view.</p>	
[Show/Hide Monitor Layout]	[Control Panel]	▶[ON]/[OFF]
	[Black Screen]	▶[ON]/[OFF]
<p>Displays the control panel and black screen when switching between displays using [DISP.] button. (➔ 67)</p>		

 [Custom] menu →  [Monitor / Display (Video)]

[V-Log View Assist]	[Read LUT File]	
	[LUT Select]	
	[LUT View Assist (Monitor)]	[ON]▶[OFF]
	[LUT View Assist (HDMI)]	[ON]▶[OFF]
	<p>You can show images with LUT data applied on the monitor/viewfinder, or output them via HDMI.</p> <ul style="list-style-type: none"> • For details, refer to page 278. 	
[HLG View Assist]	[Monitor]	[MODE1]▶[MODE2]/[OFF]
	[HDMI]	▶[AUTO]/[MODE1]/[MODE2]/[OFF]
	<p>At recording or playback of [HLG Photo] and HLG video, this displays images with converted color gamut and brightness on the camera monitor/viewfinder, or outputs these over HDMI.</p> <ul style="list-style-type: none"> • For details, refer to page 282. 	
[Anamorphic Desqueeze Display]	$2.0\times$, $1.8\times$, $1.5\times$, $1.33\times$, $1.30\times$ [↔]▶/[↔]▶/[↔]▶/[↔]▶/[↔]▶/[↔]▶/[OFF]	
	<p>This displays the desqueezed images suited to the magnification of the anamorphic lens on this camera.</p> <ul style="list-style-type: none"> • For details, refer to page 286. 	
[Monochrome Live View]	[ON]▶[OFF]	
	<p>You can display the recording screen in black and white.</p> <ul style="list-style-type: none"> • If you use the HDMI output during recording, the output image will not be displayed in black and white. • [Monochrome Live View] is not available when [Night Mode] is used. 	

[Custom] menu → [Monitor / Display (Video)]

[Center Marker]	[ON]▶[OFF]	
	The center of the recording screen will be displayed as [+].	
[Zebra Pattern]	[ZEBRA1]/[ZEBRA2]/[ZEBRA1+2]▶[OFF]	
	[SET]	[Zebra 1]
		[Zebra 2]
Parts that are brighter than the base value are displayed with stripes. <ul style="list-style-type: none"> • For details, refer to page 267. 		
[Waveform Monitor]	[ON]▶[OFF]	
	You can display in the recording screen a waveform. You can check detailed information about the brightness. <ul style="list-style-type: none"> • For details, refer to page 264. 	
[Red REC Frame Indicator]	[ON]▶[OFF]	
	A red frame is displayed on the recording screen that indicates that video is being recorded.	

[Custom] menu → [IN/OUT]

[HDMI Rec Output]	[Info Display]	▶[ON]/[OFF]
	[HDMI Recording Control]	[ON]▶[OFF]
	[4K/60p Bit Mode]/ [4K/50p Bit Mode]	[4:2:2 10bit]▶[4:2:0 8bit]
	[Sound Output (HDMI)]	▶[ON]/[OFF]
	Sets HDMI output during recording. <ul style="list-style-type: none"> • For details, refer to page 292. 	

 [Custom] menu ➔  [Lens / Others]

[Lens Focus Resume]	[ON]▶[OFF]			
[Lens Fn Button Setting]	<p>The camera saves the focus position when you turn it off.</p> <hr/> <p>▶[Focus Stop]/[AF Mode]/[Focus Ring Lock]/[AE LOCK]/[AF LOCK]/[AF/AE LOCK]/[AF-ON]/[AF-ON : Near Shift]/[AF-ON : Far Shift]/[AF-Point Scope]/[Focus Area Set]/[Image Stabilizer]/[Preview]/[Preview Aperture Effect]/[No Setting]/[Off (Disable Press and Hold)]/[Restore to Default]</p> <hr/> <p>Register a function to the focus button of an interchangeable lens.</p> <ul style="list-style-type: none"> • When [Focus Stop] is set, focus is fixed while the focus button is being pressed. • When using an interchangeable lens that has a switch for the image stabilizer (normal/panning), [Image Stabilizer] in [Lens Fn Button Setting] is not available. 			
[Focus Ring Control]	<p>▶[NON-LINEAR]/[LINEAR]</p> <table border="1" data-bbox="311 771 970 813"> <tr> <td data-bbox="311 771 563 813">[SET]</td> <td data-bbox="563 771 970 813">[90°] to [360°] (▶[150°])/[Maximum]</td> </tr> </table> <p>Sets the amount of movement for focusing using the focus ring. (When using supported lenses)</p> <p>[NON-LINEAR]: Focus responds by accelerating according to rotation speed of the focus ring.</p> <p>[LINEAR]: Focus responds at a constant amount according to the rotational angle of the focus ring.</p> <p>[SET]: Sets the rotational angle of the focus ring for when [LINEAR] is selected.</p>		[SET]	[90°] to [360°] (▶[150°])/[Maximum]
[SET]	[90°] to [360°] (▶[150°])/[Maximum]			



[Setup] Menu

▶: Default settings



[Setup] menu → [Card/File]

[Card Format]	[Card Slot 1]/[Card Slot 2]	
	Formats the card (initialization). <ul style="list-style-type: none"> • For details, refer to page 48. 	
[Double Card Slot Function]	[Recording Method]	▶[1]/[2]/[3]
	This sets the way recording to the card slots 1 and 2 is performed. <ul style="list-style-type: none"> • For details, refer to page 88. 	
[Folder / File Settings]	[Select Folder]/[Create a New Folder]/[File Name Setting]	
	Set the folder and file name where to save the images. <ul style="list-style-type: none"> • For details, refer to page 89. 	
[File Number Reset]	[Card Slot 1]/[Card Slot 2]	
	Resets the file number of the next recording to 0001. <ul style="list-style-type: none"> • For details, refer to page 91. 	
[Copyright Information]	[Artist]	[ON]▶[OFF]/[SET]
	[Copyright Holder]	[ON]▶[OFF]/[SET]
	[Display Copyright Info.]	
	Records the names of the artist and the copyright holder in the image Exif data. <ul style="list-style-type: none"> • You can register names from [SET] in [Artist] and [Copyright Holder]. How to enter characters (→ 415) • Up to 63 characters may be entered. • You can confirm registered copyright information in [Display Copyright Info.]. 	



 [Setup] menu →  [Monitor / Display]



[Power Save Mode]	[Sleep Mode]	[10MIN.]/▶[5MIN.]/[2MIN.]/[1MIN.]/[OFF]
	[Sleep Mode(Wi-Fi)]	▶[ON]/[OFF]
	[Auto LVF/Monitor Off]	▶[5MIN.]/[2MIN.]/[1MIN.]/[OFF]
	[Power Save LVF Shooting]	[Time to Sleep]
		[Method of Activation]
<p>This is a function to automatically turn the camera to sleep (power save) status or turn off the viewfinder/monitor if no operation is performed for a set time.</p> <ul style="list-style-type: none"> • For details, refer to page 44. 		
[Monitor Frame Rate]	[30fps]/▶[60fps]	
	<p>Sets the display speed for live view on the monitor when recording pictures.</p> <p>[30fps]: Reduces the power consumption for a longer operating time.</p> <p>[60fps]: Enables smooth display of movements.</p> <ul style="list-style-type: none"> • When the following functions are being used, [Monitor Frame Rate] is not available: <ul style="list-style-type: none"> – [6K/4K PHOTO] – HDMI output 	















 [Setup] menu →  [Monitor / Display]



<p>[LVF Frame Rate]</p>	<p>▶[60fps]/[120fps]</p> <p>Sets the display speed for live view on the viewfinder when recording pictures.</p> <p>[60fps]: Reduces the power consumption for a longer operating time.</p> <p>[120fps]: Enables smooth display of movements.</p> <ul style="list-style-type: none"> • [LVF120] is displayed on the viewfinder when it is displayed at [120fps]. • When set to [120fps], the images in the viewfinder will not be as smooth as with [60fps], but there will be no change to the images recorded. • When the following functions are being used, [LVF Frame Rate] is not available: <ul style="list-style-type: none"> – [6K/4K PHOTO] – HDMI output – While connected to Wi-Fi
<p>[Monitor Settings]/ [Viewfinder]</p>	<p>[Brightness]/[Contrast]/[Saturation]/[Red Tint]/[Blue Tint]</p> <p>This adjusts the brightness, coloring, and red or blue tints of the monitor/viewfinder.</p> <ol style="list-style-type: none"> 1 Press ▲▼ to select the setting item, and press ◀▶ to adjust. 2 Press  or  to confirm the setting. <ul style="list-style-type: none"> • It will adjust the monitor when the monitor is in use, and the viewfinder when the viewfinder is in use.









 [Setup] menu →  [Monitor / Display]



[Monitor Backlight]/ [LVF Luminance]	▶[AUTO]/[-3] to [+3]	
	<p>Adjusts monitor/viewfinder luminance.</p> <p>[AUTO]: The brightness is adjusted automatically depending on how bright it is around the camera.</p> <ul style="list-style-type: none"> • Adjusts the monitor luminance when displaying the monitor, and the viewfinder luminance when displaying the viewfinder. • When either [AUTO] is set, or the adjusted value is set to positive side, the usage period will shorten. • When [Night Mode] is being used, [Monitor Backlight]/[LVF Luminance] are not available. 	
[Eye Sensor]	[Sensitivity]	▶[HIGH]/[LOW]
	This will set the sensitivity of the eye sensor.	
	[LVF/Monitor Switch]	▶[LVF/MON AUTO] (automatic viewfinder/monitor switching)/ [LVF] (viewfinder)/ [MON] (monitor)
<p>This will set the method for switching between the viewfinder and monitor.</p> <ul style="list-style-type: none"> • If you press [LVF] to switch the display, the [LVF/Monitor Switch] setting will also switch. 		
[Level Gauge Adjust.]	[Adjust.]	
	<p>Hold the camera in a horizontal position, and press  or . The level gauge will be adjusted.</p>	
	[Level Gauge Value Reset]	
Restores the default level gauge setting.		

 [Setup] menu →  [IN/OUT]



[Beep]	[Beep Volume]	[] (High)/▶[] (Low)/[] (Off)
	[AF Beep Volume]	[] (High)/▶[] (Low)/[] (Off)
	[AF Beep Tone]	▶[] (Pattern 1)/[] (Pattern 2)/[] (Pattern 3)
	[E-Shutter Vol]	[] (High)/▶[] (Low)/[] (Off)
	[E-Shutter Tone]	▶[] (Pattern 1)/[] (Pattern 2)/[] (Pattern 3)
Sets the beep sounds, AF beep, and electronic shutter sounds.		
[Headphone Volume]	[0] to [LEVEL 15] (▶[LEVEL 3])	
	Adjusts the volume when headphones are connected. <ul style="list-style-type: none"> • This functions in tandem with [Headphone Volume] in the [Video] ([Audio]) menu. • For details, refer to page 299. 	
[Wi-Fi]	[Wi-Fi Function] (→ 416)	
	[Wi-Fi Setup] (→ 468)	



 [Setup] menu →  [IN/OUT]



[Bluetooth]	[Bluetooth] (→ 420)	
	[Send Image (Smartphone)] (→ 447)	
	[Remote Wakeup] (→ 440)	
	[Returning from Sleep Mode] (→ 434)	
	[Auto Transfer] (→ 437)	
	[Location Logging] (→ 439)	
	[Auto Clock Set] (→ 441)	
	[Wi-Fi network settings]	
<p>[Wi-Fi network settings]: Registers the Wi-Fi access point. Wireless access points used to connect the camera to Wi-Fi networks will be registered automatically.</p>		
[USB]	[USB Mode]	 [Select on connection]/  [PC(Storage)]/  [PC(Tether)]/  [PictBridge(PTP)]
	<p>This sets the communication method to be used when the USB connection cable is connected.</p> <p> [Select on connection]: Select this setting to select the USB communication system when connecting to another device.</p> <p> [PC(Storage)]: Select this setting to import images to a connected PC.</p> <p> [PC(Tether)]: Select this setting to control the camera from a PC installed with “LUMIX Tether”.</p> <p> [PictBridge(PTP)]: Select this setting when connecting to a printer that supports PictBridge.</p>	
	[USB Power Supply]	▶ [ON]/[OFF]
	<p>Provides power from the USB connection cable. (→ 41)</p> <ul style="list-style-type: none"> • Even if this item is set to [OFF], power will be supplied when the AC adaptor is connected. 	

 [Setup] menu →  [IN/OUT]

[Battery Use Priority]	[BODY]▶[BG]	
	<p>Selects which battery to use first when the batteries are installed in both the camera and the Battery Grip.</p> <ul style="list-style-type: none"> • For details, refer to page 490. 	
[TV Connection]	[HDMI Mode (Playback)]	▶[AUTO]/[4K/60p]/[4K/30p]/[1080p]/[1080i]/[720p]/[480p]
	<p>Sets the HDMI output resolution for playback.</p> <p>[AUTO]: Outputs with a resolution suited to the connected TV.</p> <ul style="list-style-type: none"> • If no image appears on the TV with [AUTO], switch to a constant setting other than [AUTO] to set a format supported by your TV. (Refer to the operating instructions for the TV.) • Depending on the TV connected, output may be with a different resolution than the setting, or it may not be possible to play back video. 	
	[LUT View Assist (HDMI)]	[ON]▶[OFF]
	<p>Images with LUT (Look-Up Table) data applied are output via HDMI when you play back videos recorded with [Photo Style] set to [V-Log].</p> <ul style="list-style-type: none"> • This is linked with [LUT View Assist (HDMI)] in [V-Log View Assist] under the [Custom] ([Monitor / Display (Video)]) menu. • For details, refer to page 278. 	
[HLG View Assist (HDMI)]	▶[AUTO]/[MODE1]/[MODE2]/[OFF]	
<p>At recording or playback of [HLG Photo] and HLG video, this converts their color gamut and brightness for display.</p> <ul style="list-style-type: none"> • This is linked with [HDMI] in [HLG View Assist] under the [Custom] ([Monitor / Display (Video)]) menu. • For details, refer to page 282. 		





 [Setup] menu →  [IN/OUT]



[TV Connection] (Continued)	[VIERA Link (CEC)]	[ON]/▶[OFF]
	<p>You can use the device remote control to operate the camera when it is connected to a VIERA Link compatible device using an HDMI micro cable.</p> <ul style="list-style-type: none"> • For details, refer to page 476. 	
	[Background Color(Playback)]	[]/▶[]
	<p>Sets the color of the bands displayed on the top and bottom or the left and right of images output on a TV or similar display.</p> <ul style="list-style-type: none"> • We recommend setting to [] to prevent burn-in on the screen of the output destination. 	
[Wireless Connection Light]	[Photo Luminance Level]	[0-255]/▶[16-255]
	<p>Sets the level of luminance when outputting pictures to TVs, etc.</p> <ul style="list-style-type: none"> • When pictures recorded with [HLG Photo] are output without converting with [HLG View Assist], they are output with the setting [64-940]. 	
[ON]/[OFF]		
[ON]/[OFF]		<p>While Wi-Fi/Bluetooth is functioning, the wireless connection light stays on/blinks.</p>





 [Setup] menu →  [Setting]

[Save to Custom Mode]	[C1]/[C2]/[C3-1] to [C3-10] You can register the currently set information of the camera. • For details, refer to page 337 .
[Load Custom Mode]	[C1]/[C2]/[C3-1] to [C3-10] Calls up registered Custom mode settings to the selected recording mode and overwrites the current settings with these. • For details, refer to page 340 .
[Custom Mode Settings]	[Limit No. of Custom Mode] [Edit Title] [How to Reload Custom Mode] [Select Loading Details] Sets the ease of use of Custom mode. • For details, refer to page 338 .
[Save/Restore Camera Setting]	[Save]/[Load]/[Delete]/[Keep Settings While Format] Saves the camera's settings information to the card. Saved settings information can be loaded to the camera, letting you set the same settings on multiple cameras. • For details, refer to page 343 .
[Reset]	Returns the camera to its default settings. • For details, refer to page 76 .

 [Setup] menu →  [Others]

[Clock Set]	<p>Sets the date and time.</p> <ul style="list-style-type: none"> • For details, refer to page 54.
[Time Zone]	<p>Sets the time zone.</p> <p>Press ◀▶ to select the time zone and then press  or  to confirm.</p> <p>(A) Current time (B) Time difference from GMT (Greenwich Mean Time)</p>  <p>• If you are using Daylight Savings [, press ▲. (The time will move forward by 1 hour.) To return to the normal time, press ▲ again.</p>
[Pixel Refresh]	<p>This optimizes the image sensor and image processing.</p> <ul style="list-style-type: none"> • The image sensor and image processing are optimized when the camera is purchased. Use this function when bright spots that do not exist in the subject get recorded. • Turn the camera off and on after the pixels are corrected.
[Sensor Cleaning]	<p>Dust reduction to blow off the debris and dust that have affixed to the front of the image sensor is performed.</p> <ul style="list-style-type: none"> • You can use this function when the dust is particularly noticeable. • Turn the camera off and on when finished.

 [Setup] menu →  [Others]

[Language]	<p>This set the language displayed on the screen.</p> <ul style="list-style-type: none"> If you set a different language by mistake, select [, ] from the menu icons to set the desired language.
[Firmware Version]	[Firmware Update]/[Software info]
	<p>You can check the firmware versions of the camera and lens.</p> <p>In addition, you can update the firmware, and display information about the camera software.</p> <p>[Firmware Update]: Updates firmware.</p> <ol style="list-style-type: none"> Download the firmware from the site on page 19. Save the firmware to the root directory of the card (the first folder that appears when you access the card on your PC), and then insert the card into the camera. Select [Firmware Update], press  or , and then select [Yes] to update the firmware. <p>[Software info]: Displays information about the camera software.</p> <ul style="list-style-type: none"> When a supported optional item (XLR Microphone Adaptor, etc.) is attached to the camera, you can also check its firmware version.
[Online Manual]	<p>[URL display]/[QR Code display]</p> <p>Displays the URL or QR code in order to download the "Owner's Manual" (PDF format).</p>
[Approved Regulations]	<p>Displays the certification number for radio regulations.</p>





[Playback] Menu

❖ How to Select an Image(s) in the [Playback] Menu

Follow the steps below when the image selection screen is displayed.









- Images are displayed separately by card slot.
- To switch the card to display, press [] and select the card slot.
- The only images you can select and edit at one time are those on a single card.

When [Single] has been selected

- 1 Press  to select the image.
- 2 Press  or  .
 - If [Set/Cancel] is displayed at the right bottom of the screen, the setting is canceled when  or  is pressed again.











When [Multi] has been selected

- 1 Press , , , or  to select the image and then press  or  (repeat).
 - The setting is canceled when  or  is pressed again.
- 2 Press [DISP.] to execute.



When [Protect] is selected

Press , , , or  to select the image, and then press  or  to set (repeat).

- The setting is canceled when  or  is pressed again.



▶: Default settings

▶ [Playback] ⇒ [Playback Mode]

[Playback Mode]	<p>▶[Normal Play]/[Picture Only]/[Video Only]/[HLG Only]/[Rating]/[6K/4K PHOTO]/[Post-Focus]</p> <p>Filters the type of images to play back.</p> <ul style="list-style-type: none"> When you have set [Rating], put a check mark in the rating level you want to display, then press [DISP.].
[Slide Show]	<p>[All]/[Picture Only]/[Video Only]/[HLG Only]/[Rating]/[6K/4K PHOTO]/[Post-Focus]</p> <p>Selects image types and plays them back at regular intervals in order.</p> <ul style="list-style-type: none"> When you have set [Rating], put a check mark in the rating level you want to display, then press [DISP.]. <p>[Start]: Starts slide show playback. [Duration]: Sets repeat playback. [Repeat]: Sets repeat playback.</p> <p>Operations during slide show</p> <p>▲:Plays/pauses. You can also perform the same operation by touching [▶] or [⏸].</p> <p>◀: Move to the previous image ▶: Move to the next image ▼: Ends the slide show ⚙️: Adjusts the volume You can also perform the same operation by touching [−] or [+].</p> <ul style="list-style-type: none"> When [Video Only] is set, [Duration] is not available.
[Rotate Disp.]	<p>▶[ON]/[OFF]</p> <p>Automatically displays pictures vertically if they were recorded when holding the camera vertically.</p>





 **[Playback]** ⇒  **[Playback Mode]**

<p>[Picture Sort]</p>	<p>[FILE NAME]▶[DATE/TIME]</p> <p>This sets the order in which the camera displays images during playback.</p> <p>[FILE NAME]: Displays images by folder name/file name. [DATE/TIME]: Displays images by recording date.</p> <ul style="list-style-type: none"> • If you insert another card, it may take some time to read all data, therefore pictures may not be displayed in the set order.
<p>[Magnify from AF Point]</p>	<p>[ON]▶[OFF]</p> <p>Displays the point focused with AF. Enlarges the AF focus location when enlarging the image.</p> <ul style="list-style-type: none"> • The center of the image is enlarged for RAW images recorded in the [High Resolution Mode] or for images that are not focused.
<p>[LUT View Assist (Monitor)]</p>	<p>[ON]▶[OFF]</p> <p>When playing back video recorded with [Photo Style] set to [V-Log], this displays the images with LUT data applied on the monitor/viewfinder.</p> <ul style="list-style-type: none"> • This functions in tandem with [LUT View Assist (Monitor)] in [V-Log View Assist] in the [Custom] ([Monitor / Display (Video)]) menu. • For details, refer to page 278.



 **[Playback]** ⇒  **[Playback Mode]**

<p>[HLG View Assist (Monitor)]</p>	<p>[MODE1] / ▶ [MODE2] / [OFF]</p> <p>At recording or playback of [HLG Photo] and HLG video, this converts their color gamut and brightness for display.</p> <ul style="list-style-type: none"> • This functions in tandem with [Monitor] in [HLG View Assist] in the [Custom] ([Monitor / Display (Video)]) menu. • For details, refer to page 282.
<p>[Anamorphic Desqueeze Display]</p>	<p>2.0x / 1.8x / 1.5x / 1.33x / 1.30x / ▶ [OFF]</p> <p>[←] / [→] / [←] / [→] / [←] / [→] / [←] / [→] / ▶ [OFF]</p> <p>This displays the desqueezed images suited to the magnification of the anamorphic lens on this camera.</p> <ul style="list-style-type: none"> • This is linked with [Anamorphic Desqueeze Display] under the [Custom] ([Monitor / Display (Video)]) menu. • For details, refer to page 286.







 **[Playback]** ➔  **[Process Image]**

[RAW Processing]	<p>Processes pictures taken in RAW format on the camera and saves them in JPEG format. In addition, RAW images recorded using [HLG Photo] can be saved in HLG format.</p> <ul style="list-style-type: none"> • For details, refer to page 312.
[6K/4K PHOTO Bulk Saving]	<p>You can save any 5 second period of pictures from a 6K/4K burst file all at once.</p> <ul style="list-style-type: none"> • For details, refer to page 144.
[6K/4K PHOTO Noise Reduction]	<p>▶[AUTO]/[OFF]</p> <p>When saving pictures, reduce the noise that occurs due to high ISO sensitivity.</p> <ul style="list-style-type: none"> • For details, refer to page 141.
[Time Lapse Video]	<p>This creates videos from group images recorded with [Time Lapse Shot].</p> <ol style="list-style-type: none"> 1 Press ◀▶ to select a [Time Lapse Shot] group and then press  or . 2 Select the options for creating a video to combine the pictures into a video. <ul style="list-style-type: none"> • For details, refer to page 152.
[Stop Motion Video]	<p>This creates videos from group images recorded with [Stop Motion Animation].</p> <ol style="list-style-type: none"> 1 Press ◀▶ to select the Stop Motion Animation group and then press  or . 2 Select the options for creating a video to combine the pictures into a video. <ul style="list-style-type: none"> • For details, refer to page 152.

 **[Playback]** ⇒  **[Add/Delete Info.]**

<p>[Protect]</p>	<p>[Single]/[Multi]/[Cancel]</p> <p>You can set protection for images so that they will not be deleted by mistake. However, if you format the card, the protected images will also be deleted.</p> <ul style="list-style-type: none"> • For information about how to select images, refer to page 406. • Be careful because the [Protect] setting may be disabled on a device other than this camera.
<p>[Rating]</p>	<p>[Single]/[Multi]/[Cancel]</p> <p>If you set any of the five different rating levels for images, you can do the following:</p> <ul style="list-style-type: none"> • Deleting all images except for those with ratings. • Play back or show a slide show of images by the rating level. • Check the rating level in the file details display in operating systems such as Windows 10, Windows 8.1, and Windows 8. (JPEG images only) <ol style="list-style-type: none"> 1 Select an image. (→ 406) 2 Press  to select a rating level (1 to 5) and then press  or . <ul style="list-style-type: none"> • When [Multi] is selected, repeat Steps 1 and 2. • To cancel the setting, set the rating level to [OFF].

 **[Playback]** ➔  **[Edit Image]**

[Resize]	<p>[Single]/[Multi]</p> <p>Reduce the picture size of JPEG images and save them as different images to enable them to be easily used for web pages or sent as email attachments.</p> <ul style="list-style-type: none"> • For information about how to select images, refer to page 406. <ul style="list-style-type: none"> – When [Single] is selected, after choosing the image, press ▲▼ to select the size, then press  or . – When [Multi] is selected, before choosing the images, press ▲▼ to select the size, then press  or . • You can set up to 100 images at once with [Multi]. • The image quality of the resized image becomes lower. • [Resize] is not available for images recorded using the following functions: <ul style="list-style-type: none"> – Video recording/[6K/4K PHOTO]/[Post-Focus] – Group images – [65:24]/[2:1] ([Aspect Ratio]) – [RAW] ([Picture Quality]) – [HLG Photo]
[Rotate]	<p>Rotate images manually in 90° steps.</p> <p>: Rotates 90° clockwise.</p> <p>: Rotates 90° counter-clockwise.</p> <ul style="list-style-type: none"> • For information about how to select images, refer to page 406.
[Video Divide]	<p>Divide a recorded video or 6K/4K burst file into two.</p> <ul style="list-style-type: none"> • For details, refer to page 318.



 **[Playback]** ⇒  **[Edit Image]**

[Copy]	[Copy Direction]	▶[1 → 2]/[2 → 1]
	[Select Copy]/[Copy All in Folder]/[Copy All in Card]	
	<p>You can copy the images in one of the cards to the other card.</p>	
	<ul style="list-style-type: none"> • Copied images will be saved in a new folder. 	
	<p>[Select Copy]: Copies selected images.</p>	
	<p>1 Select the folder containing the images to copy.</p>	
	<p>2 Select the images. (→ 406)</p>	
	<p>[Copy All in Folder]: Copies all images in a folder.</p>	
	<p>1 Select the folder to copy.</p>	
	<p>2 Check the images to be copied and then press  or  to execute copying.</p>	
	<p>[Copy All in Card]: Copies all images in the card.</p>	
	<p>Using the Fn button to copy images</p>	
	<p>If you press the Fn button with [Copy] assigned while playing back images one at a time, the image currently being played back will be copied to the other card.</p>	
	<ul style="list-style-type: none"> • Select the copy destination folder from the following options. In the case of group images, [Create a New Folder] is selected automatically. 	
	<p>[Same Folder Number as Source]: Copies to a folder with the same name as the folder of the image to be copied.</p>	
	<p>[Create a New Folder]: Creates a new folder with an incremented folder number and then copies the image to it.</p>	
	<p>[Select Folder]: Selects a folder to store the image and then copies the image to it.</p>	

 **[Playback]** ⇒  **[Edit Image]**

[Copy]
(Continued)

- You can set up to 100 images at once with [Select Copy].
- The [Protect] setting is not copied.
- Copying may take a while.
- When using the following combinations of cards, videos, 6K/4K photos, and images recorded with [Post-Focus] cannot be copied:
 - Copying from an SDXC memory card to an SD/SDHC memory card

 **[Playback]** ⇒  **[Others]**

[Delete Confirmation]

["Yes" first]/▶["No" first]

This sets which option, [Yes] or [No], will be highlighted first when the confirmation screen for deleting an image is displayed.

["Yes" first]: [Yes] is highlighted first.

["No" first]: [No] is highlighted first.

[Delete All Images]

[Card Slot 1]/[Card Slot 2]









Deleting all images in a card.

- Images cannot be restored once they have been deleted. Carefully confirm the images before deletion.
- If you select [Delete All Non-rating], all images except those with a rating set are deleted.
- [Delete All Images] can be used when [Playback Mode] is set to [Normal Play].

Entering Characters



Follow the steps below when the character entry screen is displayed.

1 Enter characters.

- Press ▲▼◀▶ to select characters and then press  or  until the character to enter is displayed.
(Repeat this)
- To repeatedly enter the same character, rotate  or  to the right to move the entry position cursor.
- If you select an item and press  or , you can perform the following operations:
 - []: Change the character type to [A] (upper case characters), [a] (lower case characters), [1] (numbers), and [&] (special characters)
 - []: Enter a blank
 - [Delete]: Delete a character
 - [<]: Move the entry position cursor to the left
 - [>]: Move the entry position cursor to the right
- When entering a password, (A) shows the number of characters you have entered and the number of characters you can enter.



2 Complete entering.

- Select [Set] and then press  or .

15. Wi-Fi/Bluetooth

This chapter explains the Wi-Fi® and Bluetooth® functions of the camera.

Remote Operations from a Smartphone



You can use the “LUMIX Sync” smartphone app for remote recording and image transfers.

→ 418

Transferring Images from This Camera



You can transfer images to another device, such as a smartphone or PC, by operating the camera.



→ 443

This document refers to both smartphones and tablets as **smartphones**.

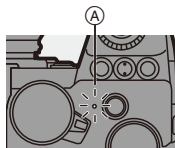
❖ Checking Operation of the Wi-Fi and Bluetooth Functions





Ⓐ Wireless connection light

Light (blue)	Monitor	Operation
Lit		The Wi-Fi function is set to on, or there is a connection.
		The Bluetooth function is set to on, or there is a connection.
Blinking		When image data is sent using a camera operation.



- Do not remove the card or battery or move to an area without any reception while sending images.
- The camera cannot be used to connect to a public wireless LAN connection.
- We strongly recommend that you set an encryption to maintain information security.
- We recommend that you use a sufficiently charged battery when sending images.
- When the remaining battery level is low, it may not be possible to connect to or maintain communication with other devices.
(A message such as [Communication error] is displayed.)
- Images may not be completely sent depending on radio wave conditions.
If the connection is terminated while sending images, images with missing parts may be sent.



- You can set so that the wireless connection light does not turn on:
[] → [] → [Wireless Connection Light] (→ [402](#))

Connecting to a Smartphone

Connect with a smartphone which has the “Panasonic LUMIX Sync” (below: “LUMIX Sync”) smartphone app installed.

Use “LUMIX Sync” for remote recording and image transfers.

Flow of connecting a smartphone

1	Install “LUMIX Sync” on your smartphone. (→ 419)	
2	Connect to a smartphone.	
	Using a smartphone that supports Bluetooth Low Energy • Bluetooth connection (→ 420)	Using a smartphone that does not support Bluetooth Low Energy • Wi-Fi connection (→ 424)
3	Operate the camera using the smartphone. (→ 430)	
	<ul style="list-style-type: none"> • [Remote shooting] (→ 431) • [Shutter Remote Control] (→ 433) • [Import images] (→ 435) • [Auto Transfer] (→ 437) • [Location Logging] (→ 439) • [Remote Wakeup] (→ 440) • [Auto Clock Set] (→ 441) • [Camera settings copy] (→ 442) 	



- You can also use the camera to transfer images to a smartphone.
For details, refer to “Sending Images from the Camera” on page 443.

Installing “LUMIX Sync”

“LUMIX Sync” is an application for smartphones provided by Panasonic.

Supported OS

Android™: Android 5 or higher

iOS: iOS 11 or higher

- 1** Connect the smartphone to a network.
- 2** (Android) Select “Google Play™ Store”.
(iOS) Select “App Store”.
- 3** Enter “LUMIX” or “panasonic lumix sync” into the search box.
- 4** Select and install the “Panasonic LUMIX Sync” .



- Use the latest version.
- Supported OSs are current as of September 2020 and are subject to change.
- Read the [Help] in the “LUMIX Sync” menu for further details on how to operate.
- The app may not operate correctly depending on your smartphone.
For information on the “LUMIX Sync”, refer to the following support site:
<https://panasonic.jp/support/global/cs/dsc/>
(English only)

Connecting to a Smartphone (Bluetooth Connection)

Follow a simple connection setup procedure (pairing) to connect to a smartphone that supports Bluetooth Low Energy.

When pairing is set up, the camera also automatically connects to the smartphone via Wi-Fi.

- For the first-time connection, pairing settings are required.

For information about connecting for the second and subsequent times, refer to page 423.



• Supported smartphones

Android™: Android 5 or higher with Bluetooth 4.0 or higher
(excluding those that do not support Bluetooth Low Energy)

iOS: iOS 11 or higher

- Turn on the Bluetooth function on the smartphone beforehand.

1 On the smartphone, start up “LUMIX Sync”.

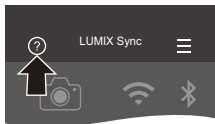

- A message regarding device (camera) registration is displayed. Select [Next].
- If you have closed the message, select [?], then register the camera using [Camera registration (pairing)].



2 Check the content in the displayed guide and select [Next] until the screen to register the camera is displayed.

Operating the camera in accordance with the smartphone guide.

3 Set the camera to Bluetooth pairing standby state.

- **MENU/SET** ⇒ [] ⇒ [] ⇒ [Bluetooth] ⇒ [Bluetooth] ⇒ [SET] ⇒ [Pairing]
- The camera enters pairing standby state and the device name **(A)** is displayed.



4 On the smartphone, select the camera's device name.

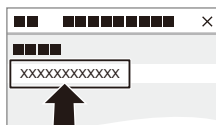

- (iOS devices) When a message to confirm the change of destination is displayed, select [Join].



5 When a message indicating that device registration is complete, select [OK].

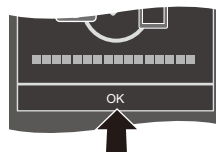

- A Bluetooth connection between the camera and the smartphone will be made.



- The paired smartphone is registered as a paired device.
- During Bluetooth connection, [] is displayed in the recording screen. When the Bluetooth function is enabled, but a connection is not established with the smartphone, [] appears translucent.
- Up to 16 smartphones can be registered. If you try to register more than 16 smartphones, the registration information will be deleted from the oldest first.

❖ End Bluetooth Connection

To terminate the Bluetooth connection, turn off the Bluetooth function of the camera.





 ⇒ [] ⇒ [] ⇒ [Bluetooth] ⇒ [Bluetooth] ⇒ Select [OFF]



- Even if you terminate the connection, the pairing information for it will not be deleted.

❖ Connecting to a Paired Smartphone

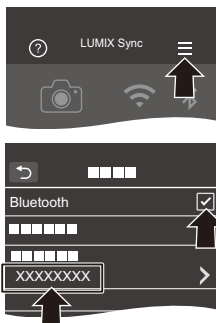

Connect paired smartphones using the following procedure.

- ❶ Enable the Bluetooth function of the camera.
 -  ⇒ [] ⇒ [] ⇒ [Bluetooth] ⇒ [Bluetooth] ⇒ [ON]
- ❷ On the smartphone, start up “LUMIX Sync”.
 - If a message is displayed indicating that the smartphone is searching for cameras, close the message.
- ❸ Select [].
- ❹ Select [Bluetooth Setup].
- ❺ Turn Bluetooth ON.
- ❻ From [Camera registered] items, select the camera’s device name.



- Even if you set up pairing with more than one smartphone, you can only connect to one smartphone at a time.
- When pairing takes some time, canceling the pairing settings on both the smartphone and camera and re-establishing the connection may result in the camera being detected correctly.

❖ Canceling Pairing

- 1 Cancel the pairing setting of the camera.
 - **MENU/SET** ⇒ [] ⇒ [] ⇒ [Bluetooth] ⇒ [Bluetooth] ⇒ [SET] ⇒ [Delete]
- 2 Select the smartphone for which to cancel the pairing.



- Also cancel the pairing setting on the smartphone.
- When [Reset] in the [Setup] ([Setting]) menu is used to reset the network settings, the information for registered devices is deleted.



Connecting to a Smartphone ([Wi-Fi connection])

Use Wi-Fi to connect the camera and a smartphone.

With default settings, simple connection with smartphones is possible without entering a password.

You can also use password authentication for enhanced connection security.

1 Set the camera to Wi-Fi connection standby status.

- **MENU/SET** ⇒ [] ⇒ [] ⇒ [Wi-Fi] ⇒ [Wi-Fi Function] ⇒ [New Connection] ⇒ [Remote Shooting & View]
- The SSID **(A)** of the camera is displayed on the screen.



- You can also perform the same operation by pressing the Fn button assigned with [Wi-Fi].
For information about the Fn button, refer to page [321](#).

- 2 In the setting menu of the smartphone, turn the Wi-Fi function ON.
- 3 Select the SSID displayed on the camera.
- 4 On the smartphone, start up “LUMIX Sync”.
- 5 (At the first connection)
Confirm the device name displayed on the camera and then select [Yes].

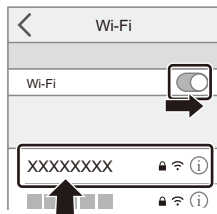

- When a device different than the one you want to connect to is displayed, the camera will automatically connect to that device if you select [Yes]. If there are other Wi-Fi connection devices nearby, we recommend using either QR code or manual password input to connect with password authentication. (→ [426](#))

❖ Using Password Authentication to Connect



You can enhance Wi-Fi connection security by using password authentication through either QR code or manual input.

Scanning QR code to connect

1 Set [Wi-Fi Password] on the camera to [ON].

- **MENU/SET** → [] → [] → [Wi-Fi] → [Wi-Fi Setup] → [Wi-Fi Password] → [ON]

2 Display the QR code **A**.

- **MENU/SET** → [] → [] → [Wi-Fi] → [Wi-Fi Function] → [New Connection] → [Remote Shooting & View]
- You can also perform the same operation by pressing the Fn button assigned with [Wi-Fi].

For information about the Fn button, refer to page 321.

- Press **MENU/SET** or  to enlarge the QR code.

3 On the smartphone, start up “LUMIX Sync”.

- If a message is displayed indicating that the smartphone is searching for cameras, close the message.

4 Select [].

5 Select [Wi-Fi connection].

6 Select [QR code].

7 Scan the QR code displayed on the screen of the camera using “LUMIX Sync”.

- (iOS devices) When a message to confirm the change of destination is displayed, select [Join].

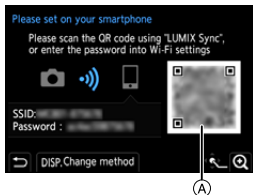

Manually entering a password to connect

- 1 Display the screen in Step 2 on page 426.
- 2 In the setting menu of the smartphone, turn the Wi-Fi function ON.

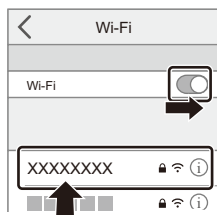

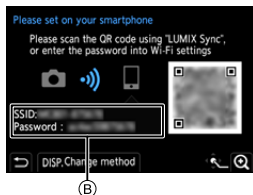

- 3 On the Wi-Fi setup screen, select the SSID (B) displayed on the camera.
- 4 (At the first connection)
Enter the password (B) displayed on the camera.
- 5 On the smartphone, start up "LUMIX Sync".





❖ Connection Methods Other Than the Default Settings

When connecting with [Via Network], or [WPS Connection] in [Direct], follow the steps below:

- 1 Display the connection method setting screen for the camera.
 -  ⇒ [] ⇒ [] ⇒ [Wi-Fi] ⇒ [Wi-Fi Function] ⇒ [New Connection] ⇒ [Remote Shooting & View]
- 2 Press [DISP.].

Connecting via network



- 1 Select [Via Network] and then press  or  .
 - Follow the connection method on page 460 to connect the camera to a wireless access point.
- 2 In the setting menu of the smartphone, turn the Wi-Fi function ON.
- 3 Connect the smartphone to the wireless access point that the camera is connected to.
- 4 On the smartphone, start up “LUMIX Sync”.

Connecting directly

- 1 Select [Direct] and then press  or  .
 - Select [WPS Connection], and follow the connection method on page 463 to connect the camera to a smartphone.
- 2 On the smartphone, start up “LUMIX Sync”.

❖ Terminating the Wi-Fi Connection

To end the Wi-Fi connection between the camera and smartphone, follow the steps below.

- 1 Press the shutter button halfway to put the camera in recording mode.
- 2 Terminate the Wi-Fi connection.
 -  ⇒ [] ⇒ [] ⇒ [Wi-Fi] ⇒ [Wi-Fi Function] ⇒ [Yes]
 - You can also perform the same operation by pressing the Fn button assigned with [Wi-Fi].
For information about the Fn button, refer to page [321](#).
- 3 On the smartphone, close the “LUMIX Sync”.







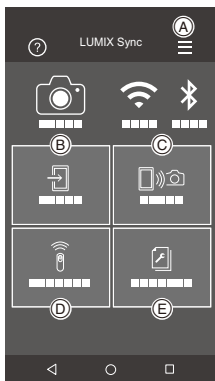

Operating the Camera with a Smartphone

This explains the functions for operating the camera from a smartphone. Functions described in this document with the (Bluetooth) symbol require a smartphone that supports Bluetooth Low Energy.

❖ Home Screen

When you start up “LUMIX Sync”, the home screen is displayed.



(A) 	App settings (→ 423, 426, 440) This allows connection settings, camera power operations, and displays Help.
(B) 	[Import images] (→ 435)
(C) 	[Remote shooting] (→ 431)
(D) 	[Shutter Remote Control] (→ 433)
(E) 	[Camera settings copy] (→ 442)

[Remote shooting]

You can use the smartphone to record from a remote location while viewing the live view images from the camera.

Getting started:

- Connect the camera to a smartphone. (→ 420, 424)
- On the smartphone, start up “LUMIX Sync”.

1 Select [📷] ([Remote shooting]) in the home screen.

- (iOS devices) When a message to confirm the change of destination is displayed, select [Join].

2 Start recording.

(A)	Takes a picture
(B)	Starts/ends the video recording

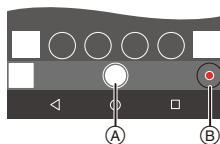

- The recorded image is saved on the camera.





- Certain features, including some settings, may not be available.

❖ Operation Method During Remote Recording

Set either the camera or the smartphone as the priority control device to be used during remote recording.

 ⇒ [] ⇒ [] ⇒ [Wi-Fi] ⇒ [Wi-Fi Setup] ⇒ Select [Priority of Remote Device]

 [Camera]	<p>Operation is possible on both the camera and the smartphone.</p> <ul style="list-style-type: none"> • The camera's dial settings, etc. cannot be changed with the smartphone.
 [Smartphone]	<p>Operation is possible only on the smartphone.</p> <ul style="list-style-type: none"> • The camera's dial settings, etc. can be changed with the smartphone. • To end remote recording, press any of the buttons on the camera to turn on the screen, and select [End].

- The default setting is [Camera].



- The setting of this function cannot be changed while the connection is active.

[Shutter Remote Control]

Bluetooth



You can use the smartphone as a remote control for the shutter.

Getting started:

- Connect the camera to a smartphone by Bluetooth. (→ 420)
- On the smartphone, start up "LUMIX Sync".

1 Select [] ([Shutter Remote Control]) in the home screen.

2 Start recording.

	Starts/ends the video recording
	Takes a picture <ul style="list-style-type: none"> • Bulb recording (→ 433)



❖ Bulb Recording

The shutter can be kept open from the start to end of recording, which is useful for recording of starry skies or night scenery.

Getting started:

- Set the camera to [M] mode. (→ 192)
- Set the camera shutter speed to [B] (Bulb). (→ 194)

1 Touch [] to start recording (keep touching, without removing your finger).

2 Remove your finger from [] to end recording.

- Slide [] in the direction of [LOCK] to record with the shutter button locked in a fully-pressed state.

(Slide [] back to its original position or press the camera shutter button to end recording)

- During [B] (Bulb) recording, if the Bluetooth connection is broken, then carry out Bluetooth connection again, then end recording from the smartphone.



❖ Shortening the Return Time from [Sleep Mode]

You can shorten the time it takes for the camera to return from [Sleep Mode] when the [Shutter Remote Control] is used.

Getting started:

- Connect the camera to a smartphone by Bluetooth. (→ 420)
- Set [Remote Wakeup] in [Bluetooth] to [ON]. (→ 440)

 → [] → [] → [Bluetooth] → Select [Returning from Sleep Mode]

	[Import / Remote Priority]	Shortens the time to return when using [Import images] or [Remote shooting].
	[Remote Shutter Priority]	Shortens the time to return when using [Shutter Remote Control].



- To use the [Shutter Remote Control] to cancel [Sleep Mode] on the camera, set [Bluetooth] in the [Setup] ([IN/OUT]) menu as follows, then connect via Bluetooth:
 - [Remote Wakeup]: [ON] (→ 440)
 - [Auto Transfer]: [OFF] (→ 437)
- The camera cannot be turned on by using [Shutter Remote Control].

[Import images]

Transfer an image stored on the card to the smartphone connected via Wi-Fi.

Getting started:

- Connect the camera to a smartphone. (→ 420, 424)
- On the smartphone, start up "LUMIX Sync".

1 Select [] ([Import images]) in the home screen.



- (iOS devices) When a message to confirm the change of destination is displayed, select [Join].

2 Select the image to transfer.

- You can switch the card displayed by touching .



3 Transfer the image.

- Select [].
- If the image is a video, you can play it back by touching [] at the center of the screen.





- When a video is played back, this has a small data size and is transmitted using “LUMIX Sync”, therefore its image quality will differ from that of the actual video recording.

Depending on the smartphone and on the usage conditions, the image quality may deteriorate or the sound may skip during video or picture playback.

- It is not possible to transfer images with file sizes exceeding 4 GB.
- Images recorded using the following functions cannot be transferred:
 - [MOV] videos
 - [6K/4K PHOTO]/[Post-Focus]
 - [HLG Photo] (HLG format pictures)

[Auto Transfer]

Bluetooth

You can automatically transfer recorded pictures to a smartphone as they are taken.

Getting started:

- Connect the camera to a smartphone by Bluetooth. (→ 420)

1 Enable [Auto Transfer] on the camera.

-  → [] → [] → [Bluetooth] → [Auto Transfer] → [ON]

- If a confirmation screen is displayed on the camera asking you to terminate the Wi-Fi connection, select [Yes] to terminate it.

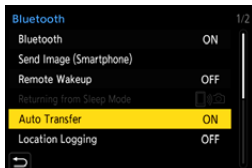

2 On the smartphone, select [Yes] (for Android devices) or [Join] (for iOS devices).

- The camera automatically makes a Wi-Fi connection.

3 Check the send settings on the camera and then press or .

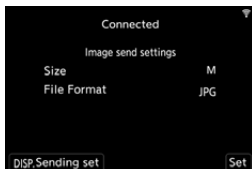

- To change the send setting, press [DISP.]. (→ 466)
- Automatic image transfer is possible when [] is displayed on the camera recording screen.



4 Record with the camera.

- [] is displayed in the recording screen of the camera while a file is being sent.

❖ To Stop the Automatic Transfer of Images

 ⇒ [] ⇒ [] ⇒ [Bluetooth] ⇒ [Auto Transfer] ⇒ Select [OFF]

- A confirmation screen is displayed, asking you to terminate the Wi-Fi connection.



- If the [Bluetooth] and [Auto Transfer] settings of the camera are [ON], the camera automatically connects to the smartphone via Wi-Fi and Bluetooth when you turn on the camera.

Start up the “LUMIX Sync” on the smartphone to connect to the camera.



- When [Auto Transfer] is set to [ON], [Wi-Fi Function] cannot be used.
- If the camera is turned off during image transfer, and the file sending is interrupted, then turn on the camera to restart the sending.
 - If the storage status of unsent files changes, then sending of files may no longer be possible.
 - If there are many unsent files, then sending of all files may not be possible.
- Images recorded with the following functions cannot be transferred automatically:
 - Video recording/[6K/4K PHOTO]/[Post-Focus]
 - [HLG Photo] (HLG format pictures)

[Location Logging]

Bluetooth

The smartphone sends its location information to the camera via Bluetooth, and the camera performs recording while writing the acquired location information.

Getting started:

- Enable the GPS function on the smartphone.
- Connect the camera to a smartphone by Bluetooth. (→ 420)

1 Enable [Location Logging] on the camera.

-  ⇒  ⇒  ⇒ [Bluetooth] ⇒ [Location Logging] ⇒ [ON]

- The camera will enter a mode where location information can be recorded and [GPS] is displayed in the recording screen of the camera.

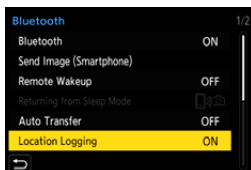

2 Record images with the camera.

- Location information will be written to the recorded images.





- When [GPS] on the recording screen appears translucent, location information cannot be acquired, therefore data cannot be written. Smartphone GPS positioning may not be possible if the smartphone is within a building, a bag, or similar. Move the smartphone to a position affording a wide view of the sky to improve positioning performance. In addition, refer to the operating instructions of your smartphone.
- Images with location information are indicated with [GPS].
- Be sure to pay special attention to the privacy, the likeness rights, etc. of the subject when you use this function. Use at your own risk.
- The smartphone drains its battery faster while acquiring location information.

[Remote Wakeup]

Bluetooth

Even when the camera is turned off, the smartphone can be used to start the camera and record images, or check the recorded images.

Getting started:

- ❶ Connect to a smartphone using Bluetooth. (→ 420)
- ❷ Enable [Remote Wakeup] on the camera.
 -  ⇒ [] ⇒ [] ⇒ [Bluetooth] ⇒ [Remote Wakeup] ⇒ [ON]
- ❸ Set the camera on/off switch to [OFF].
- ❹ On the smartphone, start up “LUMIX Sync”.

❖ Turning On the Camera

Select [Remote shooting] in the “LUMIX Sync” home screen.

- (iOS devices) When a message to confirm the change of destination is displayed, select [Join].
- The camera turns on, and automatically connects using Wi-Fi.

❖ Turning Off the Camera

- ❶ Select [] in the “LUMIX Sync” home screen.
- ❷ Select [Turn off the camera].
- ❸ Select [Power OFF].



- When [Remote Wakeup] has been set, the Bluetooth function continues to work even if the camera on/off switch is set to [OFF], so the battery will drain.

[Auto Clock Set]

Bluetooth

Synchronize the clock and the time zone setting of the camera with those of a smartphone.

Getting started:

- Connect the camera to a smartphone by Bluetooth. (→ 420)

Enable [Auto Clock Set] on the camera.

-  → [] → [] → [Bluetooth] → [Auto Clock Set] → [ON]

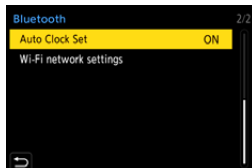

[Camera settings copy]

Bluetooth

This saves the camera's settings information to the smartphone. Saved settings information can be loaded to the camera, letting you set the same settings on multiple cameras.

Getting started:

- Connect the camera to a smartphone by Bluetooth. (→ 420)

1 Select [] ([Camera settings copy]) in the “LUMIX Sync” home screen.

2 Save or load settings information.

- Read the [Help] in the “LUMIX Sync” menu for further details on how to operate the “LUMIX Sync”.





- Only settings information from the same model can be loaded.
- When transferring settings information, a Wi-Fi connection is automatically created.
(iOS devices) When a message to confirm the change of destination is displayed, select [Join].
- You can save or load the settings information of items that are the same as those in [Save/Restore Camera Setting] under the [Setup] ([Setting]) menu. (→ 531)

Sending Images from the Camera

Operate the camera to send recorded images to a device connected by Wi-Fi.

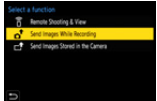
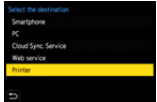
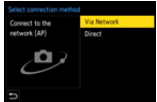
Operation flow

1	Select the sending method.	
	Select the sending method from the [Send Images While Recording] and [Send Images Stored in the Camera] camera menus.	
2	Select the destination (type of the destination device).	
	<ul style="list-style-type: none"> – [Smartphone] (→ 447) – [PC] (→ 451) – [Cloud Sync. Service] (→ 458) – [Web service] (→ 456) – [Printer] (→ 454) 	
3	Select the connection method and then connect by Wi-Fi.	
	<ul style="list-style-type: none"> – [Via Network] (→ 460) – [Direct] (→ 463) 	
4	Check the send settings.	
	Change the send settings as necessary. <ul style="list-style-type: none"> – Image send settings (→ 466) 	
5	Take pictures.	[Send Images Stored in the Camera]
	This automatically sends the recorded pictures as they are taken.	Select an image. <ul style="list-style-type: none"> – Selecting images (→ 467)

Detailed information about connection methods for each destination device is described on pages [447](#) to [459](#).

Refer to the following pages for the steps common to all devices.

- Wi-Fi connections: [Via Network] (→ [460](#))/[Direct] (→ [463](#))
- Image send settings (→ [466](#))
- Selecting images (→ [467](#))



- When recording, recording is prioritized so it will take time for sending to complete.
- If the camera is turned off, or the Wi-Fi is disconnected before sending is completed, then sending will not restart.
- You may not be able to delete files or use the [Playback] menu while sending.
- When [Auto Transfer] in [Bluetooth] is set to [ON], [Wi-Fi Function] is not available.

❖ Images That Can be Sent

Images that can be sent differ depending on the destination device.

Destination device	Images that can be sent	
	[Send Images While Recording]	[Send Images Stored in the Camera]
[Smartphone] (→ 447)	JPEG/RAW	JPEG/RAW/MP4
[PC] (→ 451)	JPEG/RAW	JPEG/RAW/MP4/MOV/ 6K/4K burst files/ Post-Focus images
[Cloud Sync. Service] (→ 458)	JPEG	JPEG/MP4
[Web service] (→ 456)	JPEG/RAW*	JPEG/RAW*/MP4
[Printer] (→ 454)	—	JPEG

* Sending is possible when the destination web service supports the sending of RAW images from this camera.

- When saving or sending RAW images to Android devices, an OS of Android 7.0 or higher is required.

Depending on the smartphone or the OS version, these may not be displayed correctly.

- It is not possible to send images with file sizes exceeding 4 GB to [Smartphone].
- 4K videos cannot be sent to [Cloud Sync. Service] and [Web service].
- It is not possible to send HLG format pictures recorded with [HLG Photo].
However, the RAW/JPEG images recorded at the same time will be sent to [Smartphone], [PC], [Cloud Sync. Service] or [Web service].



- Sending may not be possible depending on your device.
- It may not be possible to send images recorded with devices other than this camera, or images edited or processed on a PC.

❖ Fn Button Assigned with [Wi-Fi]

You can perform the following operations by pressing the Fn button assigned with [Wi-Fi] after connecting to Wi-Fi.

For information on Fn buttons, refer to page 321.

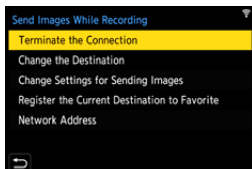

[Terminate the Connection]	Terminates the Wi-Fi connection.
[Change the Destination]	Terminates the Wi-Fi connection, and allows you to select a different Wi-Fi connection.
[Change Settings for Sending Images]	Sets the image size, file format, and other items for sending recorded images. (→ 466)
[Register the Current Destination to Favorite]	Registers the current connection destination or method so that you can easily connect with the same connection settings next time.
[Network Address]	Displays the MAC address and IP address of the camera. (→ 469)

- Depending on the Wi-Fi function being used or the connection destination, you may not be able to perform some of these operations.



[Smartphone]

Transfer recorded images to a smartphone connected using Wi-Fi.

Getting started:

- Install “LUMIX Sync” on your smartphone. (→ 419)

1 Select the method for sending the images on the camera.

- **MENU/SET** → [] → [] → [Wi-Fi] → [Wi-Fi Function] → [New Connection] → [Send Images While Recording]/[Send Images Stored in the Camera]

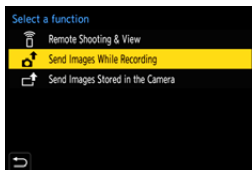

2 Set the destination to [Smartphone].

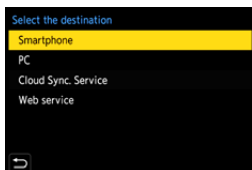



3 Connect the camera to a smartphone by Wi-Fi.

- Select [Via Network] (→ 460) or [Direct] (→ 463), and then connect.

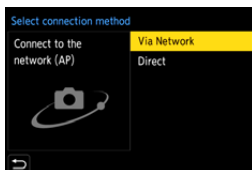
4 On the smartphone, start up “LUMIX Sync”.



5 Select the destination smartphone on the camera.

6 Check the send settings and then press  or .

- To change the send settings of images, press [DISP.]. (→ 466)

7 When [Send Images While Recording] is selected:

Take pictures.

- [] is displayed in the recording screen of the camera while a file is being sent.
- To end the connection, follow the steps below:

 ⇒ [] ⇒ [] ⇒ [Wi-Fi] ⇒ [Wi-Fi Function] ⇒ [Yes]

When [Send Images Stored in the Camera] is selected:

Select an image.

- To end the connection, select [Exit].

❖ Sending Images on the Camera to a Smartphone with Simple Operations

You can transfer pictures to a smartphone connected by Bluetooth just by pressing [Q] during playback.

You can also use the menu to connect easily.

- You can also perform the same operation by pressing the Fn button registered with [Send Image (Smartphone)].

For information about the Fn button, refer to page 321.

Getting started:

- Install “LUMIX Sync” on your smartphone. (→ 419)
- Connect the camera to a smartphone by Bluetooth. (→ 420)
- Press [▶] on the camera to display the playback screen.



Send a single image

- 1 Press ◀▶ to select the image.
- 2 Press [Q].
- 3 Select [Single Select].
 - To change the send settings of images, press [DISP.]. (→ 466)
- 4 On the smartphone, select [Yes] (for Android devices) or [Join] (for iOS devices).
 - This connects automatically using Wi-Fi.

Send multiple images

- 1 Press [Q].
- 2 Select [Multi Select].
 - To change the send settings of images, press [DISP.]. (→ 466)
- 3 Select the images and then transfer.

◀▶ : Select images



 or  : Set/Cancel



[DISP.]: Transfer
- 4 On the smartphone, select [Yes] (for Android devices) or [Join] (for iOS devices).
 - This connects automatically using Wi-Fi.



- This function is not available when [Auto Transfer] in [Bluetooth] is set to [ON].

Using the menu to transfer easily

 ⇒ [] ⇒ [] ⇒ [Bluetooth] ⇒ [Send Image (Smartphone)]
Settings: [Single Select]/[Multi Select]

- If [Single Select], press ◀▶ to select the image and then press  or  to execute.
- If [Multi Select], use the same operation as with “Send multiple images”.

[PC]

Send recorded images to the PC connected with Wi-Fi.



Supported OS

Windows: Windows 10/Windows 8.1/Windows 8

Mac: OS X v10.5 to v10.11, macOS 10.12 to macOS 10.15

Getting started:

- Turn on the PC.
- Create a destination folder for images.
- If the workgroup of the destination PC has been changed from the standard setting, change the corresponding setting of the camera in [PC Connection]. (→ [468](#))

❖ Create a Destination Folder for Images

When using Windows (Example for Windows 10)

- 1 Select the destination folder and then right-click.
- 2 Select [Properties] and then enable folder sharing.

- You can also use “PHOTOfunSTUDIO” to create folders.

For details, refer to the operating instructions for “PHOTOfunSTUDIO”.

When using Mac (Example for OS X v10.14)

- 1 Select the destination folder and then click the items in the following order.



[File] ⇒ [Get Info]

- 2 Enable folder sharing.



- Create a PC account name (up to 254 characters) and password (up to 32 characters) consisting of alphanumeric characters. A destination folder may not be created if the account name includes non-alphanumeric characters.
- When the computer name (NetBIOS name for Mac) contains a space (blank character), etc., it may not be recognized. In that case, we recommend changing the name to one consisting only of 15 or less alphanumeric characters.
- Refer to the operating instructions for your PC or Help on the OS for detailed setting procedures.

1 Select the method for sending images on the camera.

-  ⇒  ⇒  ⇒ [Wi-Fi] ⇒ [Wi-Fi Function] ⇒ [New Connection] ⇒ [Send Images While Recording]/[Send Images Stored in the Camera]

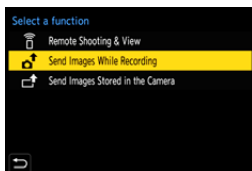

2 Set the destination to [PC].

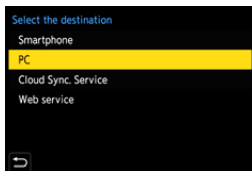

3 Connect the camera and PC by Wi-Fi.

- Select [Via Network] (→ 460) or [Direct] (→ 463), and then connect.

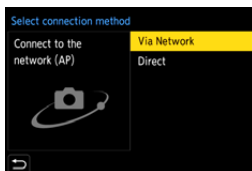

4 Enter the computer name of the PC name you want to connect to (for Mac, the NetBIOS name).

- How to enter characters (→ 415)

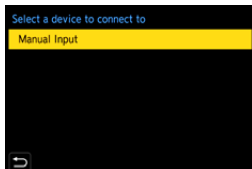

5 Select a folder for storing images.

- Folders sorted by sent date will be created in the selected folder, and images will be saved there.

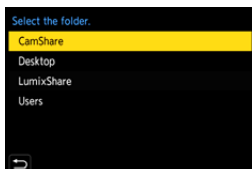

6 Check the send settings and then press or .

- To change the send setting, press [DISP.]. (→ 466)

7 When [Send Images While Recording] is selected:

Take pictures.

- [] is displayed in the recording screen of the camera while a file is being sent.
- To end the connection, follow the steps below:

 ⇒ [] ⇒ [] ⇒ [Wi-Fi] ⇒ [Wi-Fi Function] ⇒ [Yes]

When [Send Images Stored in the Camera] is selected:

Select an image.

- To end the connection, select [Exit].



-  • If the screen for a user account and password entry appears, enter the one you set on your PC.
- When the firewall of the OS, security software, etc. is enabled, connecting to the PC may not be possible.

[Printer]

You can send images to a PictBridge (wireless LAN)*-supported printer connected by Wi-Fi for printing.

* DPS over IP standard-compliant

1 Select the method for sending images on the camera.

-  ⇒ [] ⇒ [] ⇒ [Wi-Fi] ⇒ [Wi-Fi Function] ⇒ [New Connection] ⇒ [Send Images Stored in the Camera]

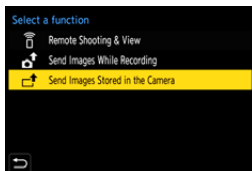

2 Set the destination to [Printer].

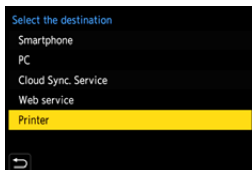

3 Connect the camera to a printer by Wi-Fi.

- Select [Via Network] (→ 460) or [Direct] (→ 463), and then connect.

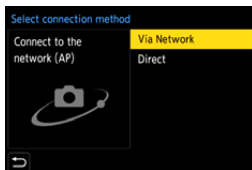

4 Select the destination printer.

5 Select and print images.

- The procedure for selecting images is the same as the one for when the USB connection cable is connected. (→ [487](#))
- To terminate the connection, press [].



- For details about PictBridge (wireless LAN-compatible) printers, contact their manufacturers.
- When [Auto Transfer] in [Bluetooth] is set to [ON], [Wi-Fi Function] is not available.



[Web service]

You can use “LUMIX CLUB” to upload recorded images to web services such as social networking sites.

Getting started:

- Register with “LUMIX CLUB”. (→ 469)
- Before sending images to a service, register that web service. (→ 471)

1 Select the method for sending images on the camera.

-  ⇒ [] ⇒ [] ⇒ [Wi-Fi] ⇒ [Wi-Fi Function] ⇒ [New Connection] ⇒ [Send Images While Recording]/[Send Images Stored in the Camera]

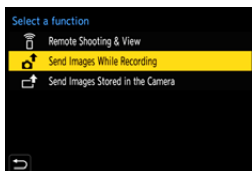

2 Set the destination to [Web service].

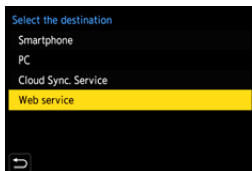

3 Connect to the web service.

- Select [Via Network] and then connect. (→ 460)

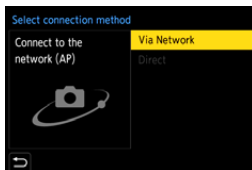

4 Select the web service.



5 Check the send settings and then press or .

- To change the send settings of images, press [DISP.]. (→ 466)

6 When [Send Images While Recording] is selected:

Take pictures.

- [] is displayed in the recording screen of the camera while a file is being sent.
- To end the connection, follow the steps below:

 ⇒ [] ⇒ [] ⇒ [Wi-Fi] ⇒ [Wi-Fi Function] ⇒ [Yes]

When [Send Images Stored in the Camera] is selected:

Select an image.

- To end the connection, select [Exit].



- If image sending fails, a report email outlining the failure will be sent to the email address registered in the “LUMIX CLUB”.
- Panasonic assumes no responsibility for any damages resulting from the leakage, loss, etc. of images uploaded on web services.
- When uploading images to a web service, do not delete images from the camera, even after they have finished sending, until you have checked that they have been properly uploaded to the web service.
Panasonic assumes no responsibility for any damages resulting from the deletion of images stored on the camera.
- Images may contain information that can be used to identify the user, such as recording dates and times, and location information. Check carefully when uploading the images to a web service.



[Cloud Sync. Service]

This camera can automatically transfer recorded images to a cloud sync service via “LUMIX CLUB” to send them to a PC or smartphone.

To use [Cloud Sync. Service] (As of September 2020)

- You need to register to the “LUMIX CLUB” (→ 469) and set up cloud synchronization to send images to a cloud folder.
To set up cloud synchronization, use “PHOTOfunSTUDIO”.
- Sent images are temporarily saved in the cloud folder. These can be synchronized with your PC, smartphone, and other devices.
- A cloud folder stores sent images for 30 days (up to 1000 images). Please note that the images will be deleted automatically in the following cases:
 - If 30 days have passed after sending (even if within 30 days of the transfer, if images have been downloaded to all specified devices, then these may be deleted)
 - If there are in excess of 1000 images (depending on the [Cloud Limit] (→ 466) setting)

1 Select the method for sending images on the camera.

-  ⇒ [] ⇒ [] ⇒ [Wi-Fi] ⇒ [Wi-Fi Function] ⇒ [New Connection] ⇒ [Send Images While Recording]/[Send Images Stored in the Camera]

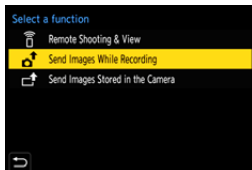

2 Set the destination to [Cloud Sync. Service].

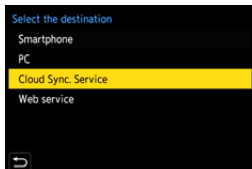

3 Connect to the cloud sync service.

- Select [Via Network] and then connect. (→ 460)

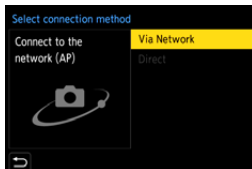





4 Check the send settings and then press or .

- To change the send settings of images, press [DISP.]. (→ 466)

5 When [Send Images While Recording] is selected:

Take pictures.

-  is displayed in the recording screen of the camera while a file is being sent.
- To end the connection, follow the steps below:

 ⇒ [] ⇒ [] ⇒ [Wi-Fi] ⇒ [Wi-Fi Function] ⇒ [Yes]

When [Send Images Stored in the Camera] is selected:

Select one or more images.

- To end the connection, select [Exit].

Wi-Fi Connections

When [New Connection] has been selected in [Wi-Fi Function] in [Wi-Fi] of the [Setup] ([IN/OUT]) menu, select the connection method from either [Via Network] or [Direct] to connect.

On the other hand, when you use [Select a destination from History] or [Select a destination from Favorite], the camera connects to the selected device with the previously-used settings.

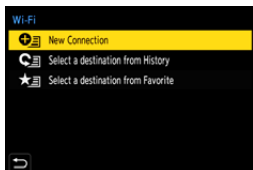

[Via Network]

Connect the camera and destination device through the wireless access point.

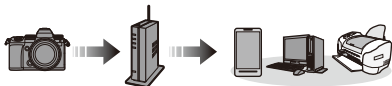

Select the method for connecting to a wireless access point.

Settings: [WPS (Push-Button)]/
 [WPS (PIN code)]/
 [From List] (→ 461)

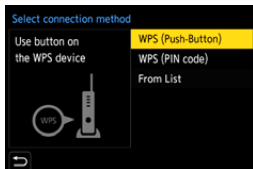

- After selecting [Via Network] once, the camera will connect to the previously-used wireless access point.
 To change the wireless access point used for connection, press [DISP.] and change the connection destination.
- Check the operating instructions and settings of the wireless access point.

❖ [WPS (Push-Button)]

Press the WPS button on the wireless access point to set up a connection.

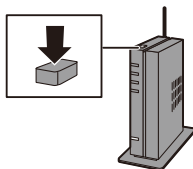

Press the wireless access point WPS button until it switches to WPS mode.

Example)



❖ [WPS (PIN code)]

Enter a PIN code into the wireless access point to set up a connection.

- ❶ On the camera screen, select the wireless access point you are connecting to.
- ❷ Enter the PIN code displayed on the camera screen into the wireless access point.
- ❸ Press  or  of the camera.

❖ [From List]

Searches for a wireless access point to use, and connects to this.



- Confirm the encryption key of the wireless access point.

- ❶ Select the wireless access point you are connecting to.
 - Press [DISP.] to run a wireless access point search again.
 - If no wireless access point is found, refer to “Connecting by Manual Input” on page 462.
- ❷ (If network authentication is encrypted) Enter the encryption key.
 - How to enter characters (→ 415)

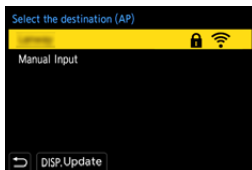

❖ Connecting by Manual Input



- Check the SSID, network authentication, encryption, and encryption key of the wireless access point you are using.

- 1 In the screen in Step 1 of “[From List]”, select [Manual Input]. (→ 461)
- 2 Enter the SSID of the wireless access point you are connecting to, and then select [Set].
 - How to enter characters (→ 415)
- 3 Select the network authentication.

[WPA2-PSK]	Supported encryption: [TKIP], [AES]
[WPA2/WPA-PSK]	
[No Encryption]	—

- 4 (When other than [No Encryption] is selected)
Enter the encryption key and then select [Set].

[Direct]

Directly connect the camera and the destination device.



Select the method for connecting with the destination device.

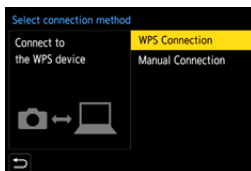

[WPS Connection]	[WPS (Push-Button)]	Press the WPS button on the destination device to connect. <ul style="list-style-type: none"> On the camera, press [DISP.] to extend the connection wait time.
	[WPS (PIN code)]	Enter the PIN code into the camera, and connect.
[Manual Connection]	Search for the camera on the destination device to connect. Enter the SSID and password displayed on the camera into the device. <ul style="list-style-type: none"> If the destination is set to [Smartphone], the password is not displayed. Select the SSID to establish a connection. (→ 424) 	





- Please also refer to the operating instructions for the device to be connected.

Connect to Wi-Fi Using Previously Saved Settings

Use the Wi-Fi connection history to connect using the same settings as previously.

1 Display the Wi-Fi connection history.

- **MENU/SET** → [] → [] → [Wi-Fi] → [Wi-Fi Function] → [Select a destination from History]/[Select a destination from Favorite]



2 Select the History item to connect to.

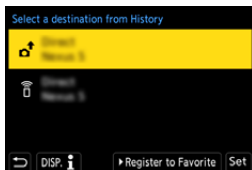

- Press [DISP.] to confirm details of the connection history.



❖ Register to Favorite

You can register the Wi-Fi connection history to Favorite.

1 Display the Wi-Fi connection history.

- **MENU/SET** → [] → [] → [Wi-Fi] → [Wi-Fi Function] → [Select a destination from History]



2 Select the History item to register and then press ►.

3 Enter a registration name and then select [Set].

- How to enter characters (→ [415](#))
- A maximum of 30 characters can be entered. A two-byte character is treated as two characters.

❖ Editing Items Registered in Favorite

1 Display items registered to Favorite.

-  → [] → [] → [Wi-Fi] → [Wi-Fi Function] → [Select a destination from Favorite]

2 Select the History item to edit in Favorite and then press ►.

[Remove from Favorite]	—
[Change the Order in Favorite]	Specify the destination location of the desired item to change the display order.
[Change the Registered Name]	Enter characters to change the registered name. <ul style="list-style-type: none"> • How to enter characters (→ 415)



- The number of items that can be saved in History is limited. Register frequently-used connection settings to Favorite.
- When [Reset] in the [Setup] ([Setting]) menu is used to reset the network settings, the content registered in History and Favorite is deleted.
- If the device you want to connect to (smartphone, etc.) is connected to a wireless access point other than the camera, you cannot connect the device to the camera using [Direct].
Change the Wi-Fi settings of the device you want to connect to so that the access point to be used is set to the camera. You can also select [New Connection] and reconnect the devices. (→ [424](#))
- It may be difficult to connect to networks to which many devices are connected. In these cases, connect using [New Connection].

Send Settings and Selecting Images

Image Send Settings

Set the size, file format, and other items for sending the image to the destination device.

- 1 After Wi-Fi connection, the send settings confirmation screen will be displayed, so press [DISP.].
- 2 Change the send settings.

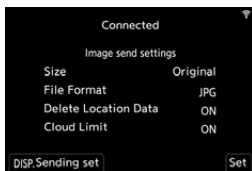



[Size]	Resize the image to send. [Original]/[Auto]/[Change] ([L], [M], [S], or [VGA]) <ul style="list-style-type: none"> The [Auto] image size changes depending on the status of the destination device. (This can be set when the destination is [Web service])
[File Format]	Sets the file format of images to send. [JPG]/[RAW+JPG]/[RAW] <ul style="list-style-type: none"> This setting is possible when the destination supports the sending of RAW images from this camera. (→ 445)
[Delete Location Data]	Select whether to delete the location information from images before sending them. <ul style="list-style-type: none"> This can be set when the destination is [Cloud Sync. Service] or [Web service]. This operation only deletes the location information from the images that are set to be sent.
[Cloud Limit]	You can select whether to send images when the cloud folder runs out of free space. [ON]: Does not send images. [OFF]: Deletes images from the oldest ones, then sends new images. <ul style="list-style-type: none"> This can be set when the destination is [Cloud Sync. Service].

Selecting Images

When sending by [Send Images Stored in the Camera], select the images using the following procedure.





- 1 Select [Single Select] or [Multi Select].
- 2 Select the image.

[Single Select] setting

- 1 Press ◀▶ to select an image.
- 2 Press  or .



[Multi Select] setting

- 1 Press ▲▼◀▶ to select an image and then press  or . (Repeat this)
 - To cancel the setting, press  or  again.
 - Images are displayed separately by card slot.
 - To switch the card to display, press [].
 - Selecting images at once is possible only for the images in a single card.
- 2 Press [DISP.] to execute.





[Wi-Fi Setup] Menu

This configures the settings required for the Wi-Fi function.
The settings cannot be changed when connected to Wi-Fi.

Displaying the [Wi-Fi Setup] menu.

-  → [] → [] → [Wi-Fi] → [Wi-Fi Setup]

[Priority of Remote Device]	This sets either the camera or the smartphone as the priority control device to be used during remote recording. (→ 432)
[Wi-Fi Password]	You can use a password to connect for enhanced security. (→ 426)
[LUMIX CLUB]	This acquires or changes the “LUMIX CLUB” login ID. (→ 470)
[PC Connection]	<p>You can set the workgroup. To send images to a PC, you need to connect to the same workgroup as the destination PC. (The default setting is “WORKGROUP”).</p> <ul style="list-style-type: none"> • To change the workgroup name, press  or  and enter the new workgroup name. How to enter characters (→ 415) • To return to the default settings, press [DISP.].
[Device Name]	<p>You can change the name (SSID) of the camera.</p> <ul style="list-style-type: none"> • To change the SSID name, press [DISP.] and enter the new SSID name. How to enter characters (→ 415) • A maximum of 32 characters can be entered.

[Wi-Fi Function Lock]	<p>To prevent incorrect operation and use of the Wi-Fi function by a third party and to protect personal information in the camera and included with images, protect the Wi-Fi function with a password.</p> <p>[Setup]: Enter any 4-digit numbers as the password.</p> <ul style="list-style-type: none"> • How to enter characters (→ 415) <p>[Cancel]: Cancel the password.</p> <ul style="list-style-type: none"> • Once a password is set, you are required to enter it each time you use the Wi-Fi function. • If you forget your password, you can use [Reset] in the [Setup] ([Setting]) menu to reset the network settings and thereby reset the password.
[Network Address]	Displays the MAC address and IP address of the camera.

“LUMIX CLUB”

Refer to the “LUMIX CLUB” site for details.

<https://lumixclub.panasonic.net/eng/c/>





- The service may be suspended due to regular maintenance or unexpected troubles, and the service contents may be changed or added, without prior notice to the users.

The service may also be stopped in whole or in part with a reasonable period of advance notice.

❖ Acquire a New Login ID from the Camera

From the camera menu, acquire a “LUMIX CLUB” login ID.

1 Follow the menu path.

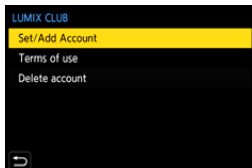

-  ⇒ [] ⇒ [] ⇒ [Wi-Fi] ⇒ [Wi-Fi Setup] ⇒ [LUMIX CLUB] ⇒ [Set/Add Account] ⇒ [New account]
- Connect to the network.
Proceed to the next page by selecting [Next].



2 Select and set the method for connecting to a wireless access point, and set. (→ 460)

- Except for the first-time connection, the camera will connect to the previously-used wireless access point.
To change the connection destination, press [DISP].
- Proceed to the next page by selecting [Next].

3 Read through the “LUMIX CLUB” terms of use and then select [Agree].

- Switch pages: ▲▼
- Zoom: Rotate  to the right (to restore: rotate  to the left)
- Move the enlarged area: ▲▼◀▶
- Cancel without registering: [] button

4 Enter a password.

- Enter any combination of 8 to 16 characters and numbers for the password.
- How to enter characters (→ 415)

5 Check the login ID and then select [OK].

- Be sure to make a note of the login ID and password.
- The login ID (12-digit number) will be displayed automatically.

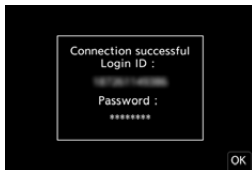

❖ Register a Web Service with “LUMIX CLUB”



- Confirm web services supported by “LUMIX CLUB” in “FAQ/Contact us” at the following site:
https://lumixclub.panasonic.net/eng/c/lumix_faqs/

Getting started:

- Make sure that you have created an account on the web service you want to use, and have the login information available.
- 1 Connect to the “LUMIX CLUB” site using a smartphone or PC.
<https://lumixclub.panasonic.net/eng/c/>
 - 2 Enter your “LUMIX CLUB” login ID and password to log in.
 - If you have not registered your email address to the “LUMIX CLUB” yet, please register it.
 - 3 Select and register the web service you want to use for web service link settings.
 - Follow the on-screen instructions to perform the registration.

❖ Confirm/Change Login ID or Password

Getting started:

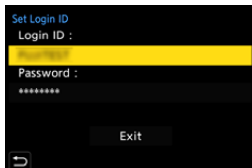

- When using the acquired login ID, check the ID and password.
- Access the “LUMIX CLUB” site from your PC to change the password.

- 1 Follow the menu path.
 - ⇒ [] ⇒ [] ⇒ [Wi-Fi] ⇒ [Wi-Fi Setup] ⇒ [LUMIX CLUB] ⇒ [Set/Add Account] ⇒ [Set Login ID]
 - The login ID and password are displayed.
 - The password is displayed as “*”.
- 2 Select the item to change.
- 3 Enter the login ID or password.
 - How to enter characters (→ 415)
- 4 Select [Exit].



❖ Checking the “LUMIX CLUB” Terms of Use

Check the details if the terms of use have been updated, for example.

 ⇒ [] ⇒ [] ⇒ [Wi-Fi] ⇒ [Wi-Fi Setup] ⇒ [LUMIX CLUB] ⇒ Select [Terms of use]



❖ Deleting Your Login ID and Closing Your “LUMIX CLUB” Account

Delete the login ID from the camera when transferring it to another party or disposing of it.

You can also close your “LUMIX CLUB” account.



- You can only change or delete the login ID acquired with the camera.

- 1 Follow the menu path.
 -  ⇒ [] ⇒ [] ⇒ [Wi-Fi] ⇒ [Wi-Fi Setup] ⇒ [LUMIX CLUB] ⇒ [Delete account]
 - A message is displayed. Select [Next].
- 2 Select [Yes] on the login ID delete confirmation screen.
 - A message is displayed. Select [Next].
- 3 Select [Yes] on the confirmation screen asking whether to close the “LUMIX CLUB” account.
 - A message is displayed. Select [Next].
 - To continue without closing the account, select [No] to delete only the login ID.
- 4 Select [OK].

16. Connecting to Other Devices

This chapter describes connections with other devices, such as TVs and PCs.

Connect using either the [HDMI] socket or the USB port on the camera. Refer to the sections below for more details about connections.



- Check the direction of the terminals and plug in/out straight holding onto the plug.
(Inserting these at an angle may cause deformation or malfunction)
- Do not connect the cable to the wrong terminals. This may cause a malfunction.

[HDMI] socket

Connect the camera and TV with a commercially available HDMI micro cable.

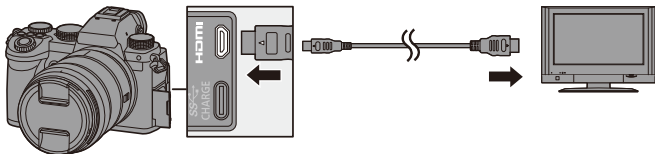

- Use a “High Speed HDMI micro cable” with the HDMI logo.
Cables that do not comply with the HDMI standards will not work.
“High Speed HDMI micro cable” (Type D–Type A plug, up to 2 m (6.6 feet) long)

USB port

Use a USB connection cable to connect the camera to a PC, recorder, or printer.

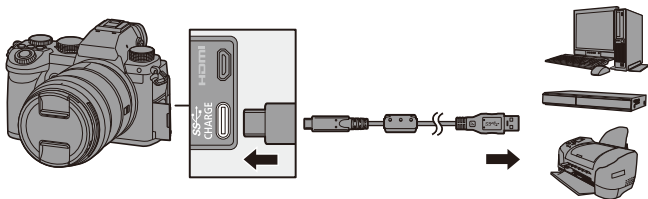

- Do not use any other USB connection cables except the supplied one.

Viewing on a TV

You can connect the camera to a TV to view recorded pictures and videos on the TV.

Getting started:

- Turn off the camera and TV.

- 1 Connect the camera and TV with a commercially available HDMI micro cable. (→ 473)**
- 2 Turn on the TV.**
- 3 Switch the TV input to HDMI input.**
- 4 Turn on the camera.**
- 5 Display the playback screen.**
 - Press [▶].
 - The recorded images are displayed on the TV. (The monitor and viewfinder of the camera will turn off.)

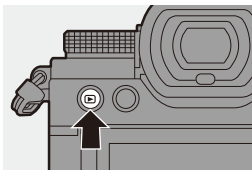



- With the default settings, pictures are output at the optimal resolution for the connected TV.

The output resolution can be changed in [HDMI Mode (Playback)]. (→ 401)

- Depending on the aspect ratio, gray bands may be displayed on the top and bottom or the left and right of images.

You can change the band color in [Background Color(Playback)] in [TV Connection] of the [Setup] ([IN/OUT]) menu. (→ 402)

- HDMI output is not possible if you connect a USB connection cable at the same time while [USB Mode] is set to [PC(Storage)] or [PictBridge(PTP)].
- If the temperature of the camera rises, [] may be displayed, recording may stop, and some functions may become unavailable temporarily. Wait until the camera cools down.
- Change the screen mode on your TV if images are displayed with the top or bottom cut off.
- Depending on the connected TV, 6K/4K burst files may not be played back correctly.
- Please also refer to the operating instructions for the TV.





Using VIERA Link

VIERA Link (HDAVI Control™) is a function that allows you to use your remote control for the Panasonic TV for easy operations when the camera has been connected to a VIERA Link compatible device using an HDMI micro cable for automatic linked operations.

(Not all operations are possible.)



- To use VIERA Link, you need to also configure the settings on the TV. For the setting procedure, refer to the operating instructions for the TV.

- ❶ Connect the camera to a Panasonic TV compatible with VIERA Link using a commercially available HDMI micro cable. (→ 473)
- ❷ Turn on the camera.
- ❸ Turn on the VIERA Link.
 -  → [] → [] → [TV Connection] → [VIERA Link (CEC)] → [ON]
- ❹ Display the playback screen.
 - Press [].
- ❺ Operate with the remote control for the TV.

Power off link

If you turn off the TV with its remote control, the camera will also turn off.

Automatic input switching

If you turn on the camera and then press [], the input of the TV automatically switches to input to which this camera is connected.

Furthermore, when the TV power is in the standby state, it turns on automatically. (When “Power on link” on the TV is set to “Set”)



- VIERA Link is a unique Panasonic function built on an HDMI control function using the standard HDMI CEC (Consumer Electronics Control) specification. Linked operations with HDMI CEC compatible devices made by other companies are not guaranteed.
- The camera supports “VIERA Link Ver.5”. “VIERA Link Ver.5” is the standard for Panasonic’s VIERA Link compatible devices. This standard is compatible with Panasonic’s conventional VIERA Link devices.
- Operation using the buttons on the camera will be limited.

Importing Images to a PC

If you connect the camera to a PC, you can copy the recorded images to the PC.

When using Windows, you can also copy using the “PHOTOfunSTUDIO” software for LUMIX.

You can also use software to perform operations such as organizing and correcting recorded images, processing RAW images, and editing videos.

(→ 480)

Copying Images to a PC

After connecting to the PC, you can copy the recorded images by dragging files and folders on this camera to the PC.



– Windows: When importing using “PHOTOfunSTUDIO”, refer to page [480](#).

– Mac: Supported by “Final Cut Pro X”.
For details on “Final Cut Pro X”, please contact Apple Inc.

- The camera can be connected to a PC running any of the following OSs which can detect mass storage devices.



Supported OS

Windows: Windows 10/Windows 8.1/Windows 8

Mac: OS X v10.5 to v10.11, macOS 10.12 to macOS 10.15

Getting started:

- Turn on the camera and PC.

- 1 Connect the camera and PC with the USB connection cable. (→ 474)**
- 2 Press ▲▼ to select [PC(Storage)] and then press  or .**
 - Windows: A drive (“LUMIX”) is displayed in [This PC].
 - Mac: A drive (“LUMIX”) is displayed on the desktop.
- 3 Drag the files and folders from the camera to the PC.**

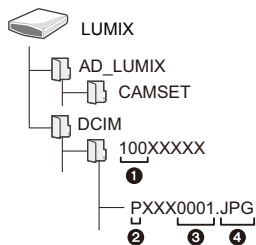

❖ Folder Structure Inside Card



CAMSET:	The camera's setup information
DCIM:	Images
① Folder number	
② Color space	P: sRGB _: AdobeRGB
③ File number	
④ JPG:	JPEG format pictures
RW2:	RAW format pictures
HSP:	HLG format pictures
MP4:	MP4 videos, 6K/4K burst files
MOV:	MOV videos

❖ Copying Images to a PC Using “PHOTOfunSTUDIO”

Getting started:

- Turn on the camera and PC.
 - Install “PHOTOfunSTUDIO” on PC. (→ 480)
- ❶ Connect the camera and PC with the USB connection cable. (→ 474)
 - ❷ Press ▲▼ to select [PC(Storage)] and then press  or .
 - ❸ Copy images to the PC using “PHOTOfunSTUDIO”.
 - Do not delete or move the copied files and folders in, for example, Windows Explorer.
Playback and editing using “PHOTOfunSTUDIO” will become no longer possible.



- If [USB Mode] is set to [PC(Storage)] in the [Setup] ([IN/OUT]) menu, the camera will be automatically connected to the PC without the [USB Mode] selection screen being displayed. (→ 400)



- Take care not to turn off the camera while images are being imported.
- After importing of the images is completed, perform the operation to safely remove the USB connection cable on the PC.
- Turn off the camera and disconnect the USB connection cable before removing the card from the camera. Otherwise, the recorded data may be damaged.

Installing Software

Install the software to perform operations such as organizing and correcting recorded images, processing RAW images, and editing videos.



- To download the software, your PC needs to be able to connect to the internet.
- Supported OSs are current as of September 2020 and are subject to change.

❖ PHOTOfunSTUDIO 10.1 PE

This software allows you to manage your images. For example, it allows you to import pictures and videos to your PC and then sort them by recording date, model name.

You can also perform operations such as writing images to a DVD, correcting images, and editing videos.

Check the following site and then download and install the software:

https://panasonic.jp/support/global/cs/soft/download/d_pfs101pe.html

(English only)

Download expiration: September 2025

Operating environment

Supported OS	Windows 10 (32-bit/64-bit) Windows 8.1 (32-bit/64-bit) • For 4K videos, videos in 10-bit format, and 6K/4K photos, a 64-bit version of the Windows 10/Windows 8.1 OS is required.
CPU	Pentium® 4 (2.8 GHz or higher)
Display	1024×768 or higher (1920×1080 or higher is recommended)
Installed memory	1 GB or more for 32-bit, 2 GB or more for 64-bit
Free hard disk space	450 MB or more for installing the software

- A high-performance PC environment is required to use the playback and editing functions for 4K videos and videos in 10-bit format or the picture cropping function for 6K/4K photos.

For details, refer to the operating instructions for “PHOTOfunSTUDIO”.

- “PHOTOfunSTUDIO” is not available for Mac.

❖ SILKYPIX Developer Studio SE

This software processes and edits RAW images.

Edited images can be saved in a format (JPEG, TIFF, etc.) that can be displayed on a PC.

Check the following site and then download and install the software:

<http://www.isl.co.jp/SILKYPIX/english/p/>

Operating environment

Supported OS	Windows	Windows 10, Windows 8.1 (64-bit recommended)
	Mac	OS X v10.10 to v10.11 macOS 10.12 to macOS 10.15

- For more information such as how to use “SILKYPIX Developer Studio”, refer to the Help or the Ichikawa Soft Laboratory’s support site.

❖ 30-Day Full Trial Version of “LoiLoScope”

This software allows you to easily edit videos.

Check the following site and then download and install the software:

<http://loilo.tv/product/20>

Operating environment

Supported OS	Windows	Windows 10, Windows 8.1, Windows 8
--------------	---------	------------------------------------



- You can download a trial version that can be used for free for 30 days.
- For more information on how to use “LoiLoScope”, refer to the “LoiLoScope” manual available for download at the site.
- “LoiLoScope” is not available for Mac.

Storing on a Recorder

By connecting the camera to a Panasonic Blu-ray disc recorder or DVD recorder, you can store the pictures and videos.

Getting started:

- Turn on the camera and recorder.
- Insert a card into card slot 1.

- 1 Connect the camera and recorder with the USB connection cable. (→ 474)**
- 2 Press ▲▼ to select [PC(Storage)] and then press  or .**
- 3 Operate the recorder to store the images.**



- If [USB Mode] is set to [PC(Storage)] in the [Setup] ([IN/OUT]) menu, the camera will be automatically connected to the recorder without the [USB Mode] selection screen being displayed. (→ 400)



- Take care not to turn off the camera while storage is in progress.
- Images such as 4K videos may not be supported depending on your recorder.
- Turn off the camera and disconnect the USB connection cable before removing the card from the camera. Otherwise, the recorded data may be damaged.
- For the storage and playback procedures, refer to the operating instructions for the recorder.

Tethered Recording

If you install the “LUMIX Tether” camera control software on your PC, you can connect the camera to the PC via USB and then control the camera from the PC and record while checking the live view on the PC screen (tethered recording).

In addition, you can output via HDMI to an external monitor or TV during tethered recording.

Installing Software

❖ “LUMIX Tether”

This software is for controlling the camera from a PC.

It allows you to change various settings and to record remotely and then save the images to the PC.

Check the following site and then download and install the software:

https://panasonic.jp/support/global/cs/soft/download/d_lumixtether.html
(English only)

Operating environment

Supported OS	Windows	Windows 10 (64-bit)
	Mac	OS X v10.11, macOS 10.12 to macOS 10.15
Interface	USB port (SuperSpeed USB (USB 3.0))	





- Supported OSs are current as of September 2020 and are subject to change.
- To download the software, your PC needs to be able to connect to the internet.
- For how to operate the software, refer to the operation guide for “LUMIX Tether”.

Operating the Camera from a PC

Getting started:

- Turn on the camera and PC.
- Install “LUMIX Tether” on PC.

- 1 Connect the camera and PC with the USB connection cable. (→ 474)**
- 2 Press ▲▼ to select [PC(Tether)] and then press  or .**
 - [] is displayed on the camera's screen.
- 3 Use “LUMIX Tether” to operate the camera from the PC.**



- If [USB Mode] is set to [PC(Tether)] in the [Setup] ([IN/OUT]) menu, the camera will be automatically connected to the PC without the [USB Mode] selection screen being displayed. (→ 400)



- The Wi-Fi/Bluetooth functions are not available while there is a PC connection with [PC(Tether)].



Printing

If you connect the camera to a printer that supports PictBridge, you can select pictures on the camera's monitor and then print them.

Getting started:

- Turn on the camera and printer.
- Set the print quality and other settings on the printer.

1 Play back the card that contains the picture you want to print.

- Press [▶].
- After pressing [⏏], press ▲▼ to select [Card Slot 1] or [Card Slot 2], and then press  or .
- The card for printing cannot be changed after connecting to the printer.

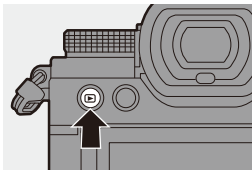





2 Connect the camera and printer with the USB connection cable. (→ 474)

3 Press ▲▼ to select [PictBridge(PTP)] and then press or .

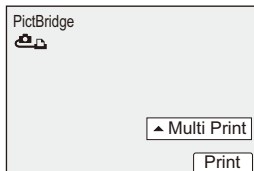
4 Press ◀▶ to select a picture and then press or .

- To print multiple pictures, press ▲, set the picture selection method, and then select pictures.



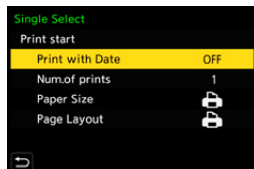

[Multi Select]	Selects the picture to print. 1 Press ▲▼◀▶ to select a picture and then press  or  . • To cancel the setting, press  or  again. 2 Press [DISP.] to end selection.
[Select All]	Prints all the stored pictures.
[Rating]	Prints all pictures with [Rating] levels from [★1] to [★5].

5 Set the print settings.



6 Start printing.

- Select [Print start] and then press  or .

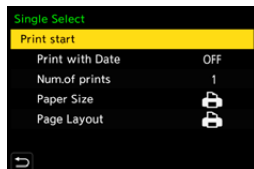



❖ Setting Items (Print Settings)

[Print start]	Starts printing.
[Print with Date]	Sets printing with date. <ul style="list-style-type: none">• If the printer does not support printing with date, the date cannot be printed.
[Num.of prints]	Sets the number of prints to be printed (up to 999).
[Paper Size]	Sets the paper size.
[Page Layout]	Sets whether to add borders and how many images to be printed on each sheet of paper.



- If [USB Mode] is set to [PictBridge(PTP)] in the [Setup] ([IN/OUT]) menu, the camera will be automatically connected to the printer without the [USB Mode] selection screen being displayed. (→ 400)



- Take care not to turn off the camera while printing is in progress.
- When connecting with the printer is not possible, set [USB Power Supply] to [OFF] and then try connecting again. (→ 400)
- Do not disconnect the USB connection cable while  (Cable disconnect prohibit icon) is displayed.
- Disconnect the USB connection cable after printing.
- Turn off the camera and disconnect the USB connection cable before removing the card from the camera. Otherwise, the recorded data may be damaged.
- To print images with paper size and layout settings not supported by the camera, set the [Paper Size] and [Page Layout] to  and then select the desired settings on the printer.
(For details, refer to the operating instructions for your printer.)
- If a yellow  is displayed, the camera is receiving an error message from the printer. Check that there is no problem with the printer.
- If the number of prints is high, the pictures may be printed in batches. In this case, the remaining number of prints indicated may differ from the number set.
- RAW images cannot be printed.
- Images recorded with the following functions cannot be printed:
 - Video recording/[6K/4K Burst]/[Post-Focus]
 - [HLG Photo]

17. Materials

Using Optional Accessories

- For information on the external flash, refer to page 227.
- For information on the external microphone, refer to page 293.
- For information on the XLR Microphone Adaptor, refer to page 296.
- Some optional accessories may not be available in some countries.

Battery Grip (Optional)

When mounted on the camera, the Battery Grip (DMW-BGS5: optional) improves ease of operation and grip when the camera is held vertically. Also, inserting a battery into the Battery Grip provides a stable supply of power even for long periods of recording.

- The Battery Grip is dust and splash resistant.

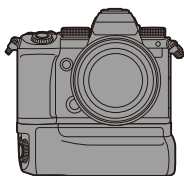



❖ Selecting Battery Usage Priority

Selects which battery to use first when the batteries are installed in both the camera and the Battery Grip.



Getting started:

- Turn the camera off, and remove the cover for the battery grip connector.

- 1 Attach the Battery Grip to the camera.
- 2 Turn on the camera.
- 3 Set the battery use priority.
 -  ⇒ [] ⇒ [] ⇒ [Battery Use Priority]

[BODY]	The battery in the camera is used first.
[BG]	The battery in the Battery Grip is used first.



- When the battery in the Battery Grip is used, [] is displayed on the monitor.
- You can register functions of your choice to the [Fn] button on the Battery Grip. (→ 321)
The [WB] button, [ISO] button, [] button, [AF ON] button, and joystick each work the same as the buttons and joystick on the camera body.
- Refer to the operating instructions for the Battery Grip for details.

Shutter Remote Control (Optional)

You can connect the Shutter Remote Control (DMW-RS2: optional) to use the camera as follows:

- Fully pressing the shutter button without camera shake
- Securing the shutter button during bulb recording and burst recording
- Start/end the video recording
- Using the functions registered in the video rec. button of the Shutter Remote Control





❖ Registering Functions to the Video Rec. Button

You can register a favorite function to the video rec. button on a Shutter Remote Control.

The functions that can be registered are the same as the functions that can be registered to the Fn buttons for recording (→ 325).

[Video Record] is registered in the default setting.



⇒ [] ⇒ [] ⇒ Select [Video Rec. Button (Remote)]

- Register functions using the same operations as [Fn Button Set]. (→ 321)



- Always use a genuine Panasonic Shutter Remote Control (DMW-RS2: optional).
- Refer to the operating instructions for the Shutter Remote Control for details.

Tripod Grip (Optional)

Attach a Tripod Grip (DMW-SHGR1: optional) to use it as a grip for recording while walking, a tripod, or a Shutter Remote Control.

- Connect the grip cable to the [REMOTE] socket on the camera.

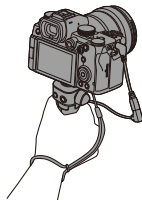

- Always use a genuine Panasonic Tripod Grip (DMW-SHGR1: optional).
- The [Video Rec. Button (Remote)] menu does not work with the Tripod Grip.
- Do not carry just by holding the hand strap when the camera is attached.
- For details, refer to the operating instructions for the Tripod Grip.

AC Adaptor (Optional)/DC Coupler (Optional)

With an AC Adaptor (DMW-AC10: optional) and DC Coupler (DMW-DCC17: optional), you can perform recording and playback without worrying about the remaining battery charge.









- Be sure to purchase both an AC Adaptor and a DC Coupler as a set. They cannot be used independently of one another.
- When the DC Coupler is being mounted, the DC coupler cover opens, so the structure ceases to be dust and splash resistant. Do not allow sand, dust and water droplets to adhere to or enter the camera. After use, confirm that no foreign objects are adhering to the DC coupler cover, then firmly close the cover.
- For details, refer to the operating instructions for the AC Adaptor and DC Coupler.

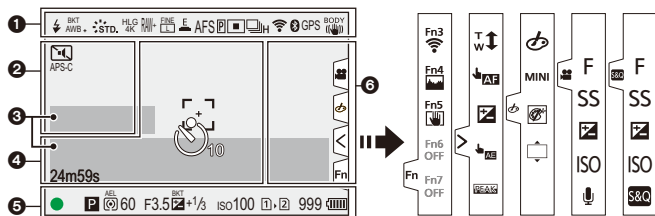





Monitor/Viewfinder Displays

- The screen is an monitor display example of when [LVF/Monitor Disp. Set] is set to .





Recording Screen











	Flash mode (→ 229)
	Flash Synchro (→ 234)/ Wireless (→ 236)
	White balance (→ 202)
	White Balance Bracket, White Balance Bracket (Color Temperature) (→ 161)
	Adjusting the white balance (→ 206)
	Photo Style (→ 208)











	Filter setting (→ 215)/ Filter effect adjustment (→ 215)
	HLG photo (→ 225)
	Picture quality (→ 86)/ Picture size (→ 85)
	Extended Tele Conversion (→ 125)
	Recording file format (→ 249)/ Recording quality (→ 250)
	Slow & Quick setting (→ 270)
	Electronic shutter (→ 175)

4

	Histogram (→ 384)
	AF area (→ 115)
+	Spot metering target (→ 184)
+	Center marker (→ 393)
	Self-timer (→ 154)
	Operation lock (→ 378)
24m59s	Elapsed recording time (→ 241)
	Image being sent (→ 437)

5















	Focus (turns green) (→ 59)/ Recording state (turns red) (→ 223, 241)
LOW 	Focus (in low light AF situations) (→ 95)
STAR 	Focus (Starlight AF) (→ 95)
	Flash adjustment (→ 233)
iA P A S M  S&Q P  P	Recording mode (→ 60)
P 	Program Shift (→ 186)
	Metering mode (→ 184)
AEL	AE Lock (→ 198)
60	Shutter speed (→ 59)
F3.5	Aperture value (→ 59)



BKT F3.5	Aperture Bracket (→ 159)
BKT  +1/3	Exposure compensation value (→ 196)
	Exposure Bracket (→ 159)
 +1	Manual Exposure Assist (→ 193)
iso100	ISO sensitivity (→ 199)
	Card access indication (turns red) (→ 241)
 	Card slot (→ 46)/Double card slot function (→ 88)
	No card
	Card full
999	Number of still images that can be taken (→ 528)
r20	Number of pictures that can be taken continuously (→ 131)
24m59s	Video recording time (→ 529)
	Battery indication (→ 42)
	Power supply (→ 41)
BG	Battery Grip (→ 490)

6

	Temperature rise warning icon (→ 505)
---	---------------------------------------

Touch Tab (→ 377)

	
	Fn button (→ 329)
	
	Touch Zoom (→ 126)
	Touch AF, Touch Shutter (→ 80)
	Exposure compensation (→ 196)
	Touch AE (→ 81)
	Focus Peaking (→ 356)
 (→ 246)	
	Type of defocus ([Miniature Effect]) (→ 218)
	One Point Color (→ 219)
	Light source position ([Sunshine]) (→ 219)
	Filter effect adjustment (→ 215)
	Filter on/off (→ 217)
MINI	Filter setting (→ 215)
F	Aperture value (→ 246)
SS	Shutter speed (→ 246)

	Exposure compensation (→ 246)
ISO	ISO sensitivity (→ 246)
	Sound recording level adjustment (→ 246)
	Slow & Quick setting (→ 246)

❖ Control Panel



1

	Recording mode (→ 60)
1/60	Shutter speed (→ 59)
F3.5	Aperture value (→ 59)
	Battery indication (→ 42)
	Power supply (→ 41)
	Battery indication (battery grip) (→ 42)
	Wi-Fi/Bluetooth connection state (→ 416)









2

	ISO sensitivity (→ 199)
	Exposure compensation value (→ 196)/ Manual Exposure Assist (→ 193)
	Flash setting (→ 233, 234, 236)/ Flash mode (→ 229)

3

	Drive mode (→ 128)/ Post-Focus (→ 166)/ High Resolution mode (→ 221)
AFS	Focus mode (→ 93, 120)
	AF mode (→ 100)
FINE	Picture quality (→ 86)
APS-C	Image area of video (→ 249)/Recording file format (→ 249)/Recording quality (→ 250)
3:2	Picture size/Aspect ratio (→ 85)
30fps	Slow & Quick setting (→ 270)
HLG OFF	HLG photo (→ 225)
Fn	Fn button settings (→ 321)

4

 STD.	Photo Style (→ 208)
AWB	White balance (→ 202)
 iOFF	i.Dynamic Range (→ 353)
	Metering mode (→ 184)
 	Card slot (→ 46)/Double card slot function (→ 88)
	No card
 	Card full
999	Number of still images that can be taken (→ 528)
r20	Number of pictures that can be taken continuously (→ 131)
R24m59s	Video recording time (→ 529)
----	No card



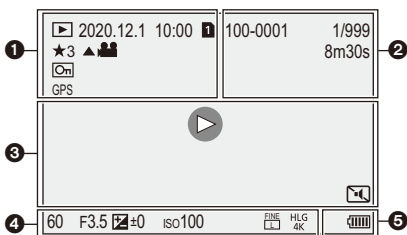





Playback Screen



	Playback mode (→ 407)
2020.12. 1 10:00	Recording date and time (→ 54)
1 2	Card slot (→ 46)
★3	Rating (→ 411)
	Video playback (→ 303)
	Protected picture (→ 411)
GPS	Location logging (→ 439)
	Obtaining information
	Cable disconnect prohibit icon (→ 489)
	Marker available (→ 141, 143)
	Reduce Rolling Shutter (→ 140)
	Saving pictures from a 6K/ 4K burst file (→ 139)
	Saving pictures from a Post-Focus image (→ 169)

100-0001	Folder/file number (→ 479)
1/999	Image number/Total number of images
9 pic.	Number of group images
8m30s	Video recording time (→ 303)
8m30s 30s	Slow & Quick video (→ 269)
MON MODE2	HLG View Assist (→ 282)
MON LUT	LUT View Assist (→ 278)



3

	Playback (video) (→ 303)
   	Group images (→ 310)
TC 00:00:00:00	Time code (→ 254)
	XLR microphone adaptor setting (→ 296)
	Wi-Fi/Bluetooth connection state (→ 416)
	Silent mode (→ 174)

4

Recording information

5

	Battery indication (→ 42)
	Power supply (→ 41)
	Battery Grip (→ 490)

Detailed information display

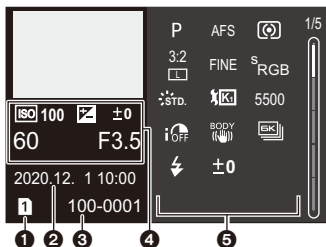

- ① Card slot (→ 46)
- ② Recording date and time (→ 54)
- ③ Folder/file number (→ 479)
- ④ Recording information (basic)
- ⑤ Recording information (advanced)

Photo Style display

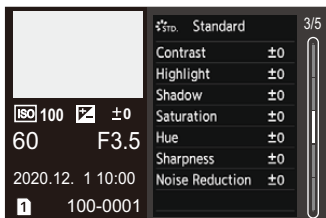

White balance display

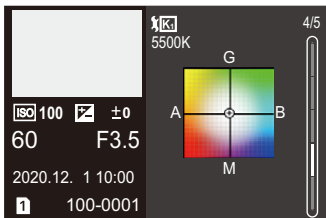

Histogram display

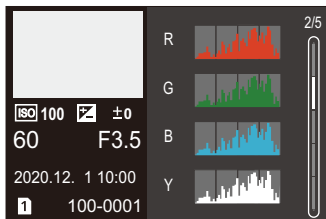

Lens information display

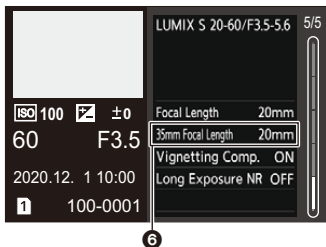

- ⑥ The focal length corresponding to the angle of view when using a full-frame lens with the [Aspect Ratio] set to [3:2]

Message Displays

Meanings of main messages displayed on the camera screen, and response methods.

❖ Card

[Memory Card Error]/[Format this card?]

- It is a format that cannot be used with the camera.
Either insert another card, or back up any necessary data before formatting. (→ 48)

[Memory Card Error]/[This memory card cannot be used]

- Use a card compatible with the camera. (→ 24)

[Insert memory card again.]/[Try another card]

- Unable to access the card. Reinsert the card.
- Insert a different card.

[Read Error]/[Write Error]/[Please check the card]

- Failure to read or write data.
Turn off the camera, reinsert the card, and then turn it on again.
- The card may be broken.
- Insert a different card.

[Recording was cancelled due to the limitation of the writing speed of the card]

- The card does not meet the writing speed requirements for recording.
Use a card of a supported Speed Class. (→ 25)
- If the recording stops even when you are using a card that meets the specified Speed Class rating, the data writing speed of the card is getting slow.
We recommend backing up data, and formatting (→ 48).

❖ Lens

[The lens is not attached properly. Do not push lens release button while lens is attached.]

- Remove the lens once, and then attach it again without pressing the lens release button. (→ 49)
Turn on the camera again, and if it is still displaying, contact the dealer.

[Lens attachment failed. Please make sure the lens is attached correctly.]

- Remove the lens from the camera body and gently wipe the contacts on the lens and the camera body using a dry cotton swab.
Attach the lens, turn on the camera again, and if it is still displaying, contact the dealer.

❖ Battery

[This battery cannot be used]

- Use a genuine Panasonic battery.
If this message is displayed even when a genuine Panasonic battery is used, contact the dealer.
- If the terminal of the battery is dirty, remove the dirt and dust from the terminal.

❖ Others

[Some pictures cannot be deleted]/[This picture cannot be deleted]

- Images that do not comply with the DCF standard cannot be deleted.
Back up any necessary data before formatting the card. (→ 48)

[A folder cannot be created]

- The maximum number of folder numbers has been reached, so new folders cannot be created.
After formatting the card, execute [File Number Reset] in the [Setup] ([Card/File]) menu. (→ 91)

[Please turn camera off and then on again]/[System Error]

- Turn off and on the camera.
If the message is displayed even when doing this several times, contact the dealer.

Troubleshooting

First, try out the following procedures (→ 505 to 515).

If the problem is not resolved, it may be improved by selecting [Reset] (→ 76) on the [Setup] ([Setting]) menu.

Power, Battery

The camera turns off automatically.

- [Power Save Mode] is enabled. (→ 44)

The battery becomes flat too quickly.

- When [6K/4K Pre-Burst] or [Pre-Burst Recording] is set, the battery drains faster. Set these settings only when recording.
- When connected to Wi-Fi, the battery drains quickly. Turn the camera off frequently such as by using [Power Save Mode] (→ 44).

Recording

Recording stops before finishing.

Cannot record.

Cannot use some functions.

- In high ambient temperatures or if the camera is used for continuous recording, the temperature of the camera will rise. To protect the camera against a rise in temperature, after [] is displayed, recording will be stopped, and the following functions will not be available for a time. Wait until the camera cools down.
 - [6K/4K PHOTO]
 - [Post-Focus]
 - Video recording
 - [AF-Point Scope]
 - HDMI output
 - Power supply

Cannot record images.

The shutter will not operate immediately when the shutter button is pressed.

- If [Focus/Shutter Priority] is set to [FOCUS], then recording will not take place until focus is achieved. (→ 373)

The recorded image is whitish.

- Images may look whitish when the lens or image sensor gets dirty with fingerprints or similar.

If the lens is dirty, turn the camera off, then wipe the lens surface with a soft, dry cloth.

For information about how to clean the image sensor, refer to page 517.

The recorded image is too bright or dark.

- Ensure AE Lock is not set where it is not appropriate. (→ 198)

Multiple images are recorded at once.

- When drive mode is set to [**I**] (Burst Shot 1) or [**II**] (Burst Shot 2), pressing and holding the shutter button will take burst pictures. (→ 128)
- When [Bracketing] is set, then pressing the shutter button records multiple images while automatically changing the settings. (→ 156)

The subject is not focused properly.

- Confirm the following details:
 - Is the subject outside of the focus range?
 - Is [Shutter AF] set to [OFF]? (→ 376)
 - Is [Focus/Shutter Priority] set to [RELEASE]? (→ 373)
 - Is AF Lock (→ 198) set where it is not appropriate?

The recorded image is blurred.

The image stabilizer is not effective.

- The shutter speed will become slower and the image stabilizer function may not work properly when recording in dark places.
In these cases, use a tripod and the self-timer when recording.

The recorded image looks rough.**Noise appears on the picture.**

- Try the following:
 - Reduce the ISO sensitivity. (→ 199)
 - Increase [Noise Reduction] of [Photo Style] to the positive direction, or adjust each item other than [Noise Reduction] to the negative direction. (→ 211)
 - Set [Long Exposure NR] to [ON]. (→ 351)

The subject appears distorted on the image.

- When a moving subject is recorded while using the following functions, the subject may appear distorted in the picture:
 - [ELEC.]
 - Video recording
 - [6K/4K PHOTO]

This is a characteristic of the CMOS sensor that is the image sensor of the camera, and is not a malfunction.

Striping or flicker may appear under lighting such as fluorescent or LED lighting.

- This is characteristic of CMOS sensors which serve as the camera's pickup sensors.
This is not a malfunction.
- When using the electronic shutter (→ 175), lowering the shutter speed may reduce the effect of the horizontal stripes.
- If flicker or horizontal stripes are noticeable when recording video, this can be mitigated by fixing the shutter speed. Either set [Flicker Decrease (Video)] (→ 365), or fix the shutter speed with the [M]/[S&Q] mode (→ 244).



Stripes appear in high ISO sensitivity.

- Stripes may appear in high ISO sensitivity or depending on the lens you use. Decrease the ISO sensitivity. (→ [199](#))

The brightness or coloring of the recorded image is different from the actual scene.

- When recording under lighting such as fluorescent or LED lighting, increasing the shutter speed may introduce slight changes to brightness or coloring. These are a result of the characteristics of the light source and do not indicate a malfunction.
- When recording subjects in extremely bright locations or recording under lighting such as fluorescent, LED, mercury, or sodium lighting, the coloring or screen brightness may change or horizontal striping may appear on the screen.

Bright spot not in subject is recorded.

- Pixels may be missing from the image sensor. Perform [Pixel Refresh]. (→ [404](#))

Video

Cannot record videos.

- When using a large capacity card, you may not be able to record for a while after turning on the camera.

Video recording stops in the middle.

- Recording video requires a card of a supported speed class. Use a compatible card. (→ 25)

In videos, abnormal clicking and buzzing sounds are recorded.

The recorded audio is very quiet.

- Depending on the recording conditions or the lens used, the sound of aperture and focus actions may be recorded in videos.
You can set the focus operation during video recording to [OFF] in [Continuous AF] (→ 256).
- Do not block the microphone hole during video recording.

An operation sound is recorded in a video.

- We recommend setting the [M]/[S&Q] mode and recording with touch operation if you are bothered about the operation sounds during recording. (→ 246)



Playback

Cannot play back.

There are no recorded pictures.

- Folders and images processed on a PC cannot be played on the camera.
We recommend using the software “PHOTOfunSTUDIO” to write images from the PC to the card.
- Some images are not displayed when the [Playback Mode] is set. Set to [Normal Play]. (→ 407)

Red part of the recorded image has changed color to black.

- When Red-Eye Removal ([] or []) is performed, red parts may be corrected to black.
We recommend recording images with the flash mode set to [] or [Red-Eye Removal] set to [OFF]. (→ 231)

Monitor/Viewfinder

The monitor/viewfinder turns off when the camera is turned on.

- If no operations are performed during the set time period, [Auto LVF/Monitor Off] (→ 44) is activated, and the monitor/viewfinder turns off.
- When an object or your hand is positioned near the eye sensor, the monitor display may switch to the viewfinder display.

It may flicker for an instant or the brightness of the screen may change significantly for an instant.

- This occurs when the shutter button is pressed halfway, or when the subject brightness changes, making the lens aperture change.
This is not a malfunction.

Unevenly bright parts or irregular colors appear on the viewfinder.

- The viewfinder of the camera is built with OLED components. Screen burn-in may occur on the screen/viewfinder when a same image is displayed for a long period of time, but it does not affect the recorded images.

Flash

The flash does not fire.

- The flash does not fire when using the following functions:
 - Video recording/[6K/4K PHOTO]/[Post-Focus]
 - [ELEC.]/[Silent Mode]/[High Resolution Mode]
 - [Filter Settings]

Wi-Fi Function

A Wi-Fi connection cannot be established.

Radio waves get disconnected.

Wireless access point is not displayed.

General tips for using a Wi-Fi connection

- Use within the communication range of the device to be connected.
- Usage near devices that utilize the 2.4 GHz frequency such as microwave ovens and cordless telephones may result in the radio wave being lost.
Use the camera at a sufficient distance from these devices.
- When the remaining battery level is low, it may not be possible to connect to or maintain communication with other devices.
(A message such as [Communication error] is displayed.)
- If you place the camera on a metal table or shelf, the radio waves may be adversely affected. In such cases, you may not be able to establish a connection.
Move the camera away from the metal surface.

Wireless access point

- Confirm that the connected wireless access point can be used.
- Confirm the radio wave conditions of the wireless access point.
 - Move the camera closer to the wireless access point.
 - Change the location and angle of the wireless access point.
- Depending on the wireless access point, the radio wave may not be displayed even though it is present.
 - Turn off and then on the wireless access point.
 - If the wireless channel of the wireless access point cannot be set automatically, manually set the channel supported by the camera.
 - If the wireless access point SSID is set not to broadcast, it may not be detected.
Enter the SSID, and then connect. (→ [462](#))
- Depending on the wireless access point, connection may be automatically disconnected after specific time has passed.
Reconnect the connection again.

Cannot connect with a wireless access point.

- The wireless access point information set on the camera is wrong.
Check the authentication type and encryption key. (→ 462)
- Radio waves from other devices may block the connection to a wireless access point.
Check the status of other devices that are connected to the wireless access point as well as the status of other wireless devices.

Wi-Fi connection on an iOS device fails.

- Follow the message displayed to allow connection to the camera.
If you still cannot connect, select the SSID of the camera on the Wi-Fi setup screen of the smartphone to connect.
If the SSID is not displayed, turn off and on the camera, then perform the Bluetooth connection settings again.

Wi-Fi connection with a smartphone is not possible.

- Change the access point to connect to in the smartphone Wi-Fi settings to the camera.

When trying to connect to a PC by Wi-Fi, this does not recognize the user name and password, and connection is not possible.

- Depending on the version of the OS, there are two types of user account (local account/Microsoft account).
Ensure you use the local account user name and password.

The PC is not recognized when I use a Wi-Fi connection.

The camera cannot be connected to the PC using the Wi-Fi function.

- At the time of purchase, this camera is set to use a workgroup name of "WORKGROUP".
If you have changed the workgroup name of the PC, this will not be recognized.
In the [Wi-Fi Setup] menu, [PC Connection], change the workgroup name of the PC to which to connect. (→ 468)
- Check that the login name and password are correctly typed.
- When the clock settings of the PC connected to the camera differs considerably from those of the camera, the camera cannot be connected to the PC depending on the OS.

It takes time to transmit an image to the web service.

Transmission of the image fails midway.

Some images cannot be transmitted.

- Is the size of the image too large?
 - Reduce the image size at [Size] (→ 466), and then send.
 - Transmit after dividing the video with [Video Divide] (→ 318).
- File format of the video that can be sent differs depending on the destination. (→ 445)

I have forgotten the password for the Wi-Fi.

- In the [Setup] ([Setting]) menu, [Reset], reset network settings. (→ 76)
However, all information set in [Wi-Fi Setup] and [Bluetooth] will also be reset.
(With the exception of [LUMIX CLUB])

TV, PC, Printer

The TV images are displayed with gray bands.

- Depending on the [Aspect Ratio], gray bands may be displayed on the top and bottom or the left and right of the images. You can change the band color in [Background Color(Playback)] in [TV Connection] of the [Setup] ([IN/OUT]) menu. (→ 402)

Images cannot be imported even when connected to a PC.

- Set the [USB Mode] of the camera to [PC(Storage)]. (→ 400)
- Turn the camera off and on.

Cannot print when the camera is connected to a printer.

- Pictures cannot be printed using a printer that does not support PictBridge.
- Set the camera's [USB Mode] to [PictBridge(PTP)]. (→ 400)

Others

When the camera is shaken, a rattling sound is heard from the camera.

- The sound is caused by the in-body stabilizer. This is not a malfunction.

There is rattling noise from the lens when the camera is turned on or off, or when the camera is swung.

There is a sound from the lens when recording.

- This is the sound of the lens moving and aperture operation. It is not a malfunction.

An unreadable language was selected by mistake.

- Reselect the language from the menu using the following procedure:

 ⇒ [] ⇒ [] ⇒ [] ⇒ Select desired language (→ 405)

The camera becomes warm.

- The camera surface and back of the monitor may become warm during use, but this does not indicate a problem with performance or quality.

Cautions for Use

❖ The Camera

Keep this unit as far away as possible from electromagnetic equipment (such as microwave ovens, TVs, video games etc.).

- If you use this unit on top of or near a TV, the pictures and/or sound on this unit may be disrupted by electromagnetic wave radiation.
- Do not use this unit near cell phones because doing so may result in noise adversely affecting the pictures and/or sound.
- Recorded data may be damaged, or pictures may be distorted, by strong magnetic fields created by speakers or large motors.
- Electromagnetic wave radiation may adversely affect this unit, disturbing the pictures and/or sound.
- If this unit is adversely affected by electromagnetic equipment and stops functioning properly, turn this unit off and remove the battery or disconnect AC adaptor. Then reinsert the battery or reconnect AC adaptor and turn this unit on.

Do not use this unit near radio transmitters or high-voltage lines.

- If you record near radio transmitters or high-voltage lines, the recorded pictures and/or sound may be adversely affected.

Always use the supplied cords and cables.

If you use optional accessories, use the cords and the cables supplied with them.

Do not extend the cords or the cables.

Do not spray the camera with insecticides or volatile chemicals.

- If the camera is sprayed with such chemicals, the body of the camera may be damaged and the surface finish may peel off.

Do not keep products made of rubber, PVC or similar materials in contact with the camera for a long period of time.

❖ Cleaning

Before cleaning the camera, remove the battery or the DC Coupler, and disconnect the power plug from the electrical outlet. Then wipe the camera with a dry, soft cloth.

- When the camera is soiled badly, it can be cleaned by wiping the dirt off with a wrung wet cloth, and then with a dry cloth.
- Do not use solvents such as benzine, thinner, alcohol, kitchen detergents, etc., to clean the camera, since it may deteriorate the external case or the coating may peel off.
- When using a chemical cloth, be sure to follow the accompanying instructions.

❖ Dirt on the Image Sensor

If dirt gets inside the mount when changing lenses, depending on the recording conditions, it may adhere to the image sensor and appear on the recorded picture.

To prevent debris or dust adhering to internal parts of the body, avoid changing the lens in a dusty environment and always fit the body cap or a lens when storing the camera.

Remove any dirt on the body cap before attaching it.

Dust reduction function

The camera has a dust reduction function that will blow off the dirt and dust that have affixed to the front of the image sensor.

If the dirt is particularly noticeable, from the [Setup] ([Others]) menu, perform [Sensor Cleaning]. (→ 404)

Removing dirt on the image sensor

The image sensor is very precise and delicate, so be sure to observe the following when you do have to clean it yourself.

- Blow dust off the surface of the image sensor using a commercially available blower. Do not blow the dust off with excessive power.
- Do not put the blower further inside than the lens mount. The blower can scratch the image sensor if it touches.
- Do not use any objects except a blower to clean the image sensor.
- If you cannot remove the dirt or dust with the blower, consult the dealer or Panasonic.

❖ Cleaning the Viewfinder

If the viewfinder becomes dirty, blow dirt off the surface of the viewfinder using a commercially available blower, then lightly wipe with a soft dry cloth.

- The eye cup cannot be removed, so make sure it does not come loose when cleaning the viewfinder.
- If the eye cup accidentally gets removed, consult the dealer or Panasonic.

❖ Monitor/Viewfinder

- Do not push hard on the monitor.
This may cause irregular coloration or malfunction.
- Extremely high precision technology is employed to produce the monitor/viewfinder screen. However there may be some dark or bright spots, or spots that light constantly (red, blue, or green) on the screen.
This is not a malfunction.
Though the monitor/viewfinder screen parts are produced with highly controlled precision technology, some pixels may be inactive or always lit.
The spots will not be recorded on images on a card.

❖ Lens

- **When using this lens, take care not to drop, bump, or apply undue force to it. Doing so may cause malfunction or damage to this lens and the digital camera.**
- Do not aim the lens at the sun or strong light sources.
The concentrated light may cause fire or damage.
- Images may be affected by dust, dirt, and soiling (water, oil, fingerprints, etc.) on the lens surface.
Before and after recording, use a blower to blow off dust and dirt from the surface of the lens, then lightly wipe with a soft dry cloth to remove soiling.
- When the camera is not being used, attach the lens cap and lens rear cap to prevent dust and dirt from adhering to or entering the camera.
- To protect the lens contact points (A), do not do the following.
These may cause a malfunction.
 - Touch the lens contact points.
 - Soil the lens contact points.
 - Place the lens with its mount surface facing down.
- To improve the dust and splash resistant performance of the interchangeable lens (S-R2060), a lens mount rubber is used in the mount.
 - The lens mount rubber will leave scuff marks on the digital camera mount, but this does not impact performance.
 - To replace the lens mount rubber, contact Panasonic.

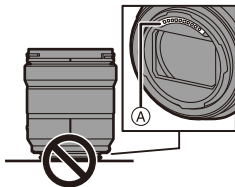

❖ Battery

The battery is a rechargeable lithium ion battery.

It is highly sensitive to temperature and humidity, and the effect on performance increases as the temperature rises or drops.

Always remove the battery after use.

- Place the removed battery in a plastic bag, etc., and keep away from metallic objects (clips, etc.) for storage or transport.

If you drop the battery accidentally, check to see if the body of the battery and the contacts are deformed.

- Damage to the camera will result if a battery with deformed contacts is inserted into the camera.

Dispose of unusable battery.

- The battery has a limited life.
- Do not throw the battery into fire because it may cause an explosion.
- The unusable battery should be discarded in accordance with battery recycling laws. Call the RBRC hotline at 1-800-822-8837 for information.

Do not allow battery terminals to come into contact with metal objects (such as necklaces, hairpins, etc.).

- This can cause short-circuiting or heat generation and you may be badly burned if you touch a battery.

❖ Charger, AC Adaptor

- The charging lights may blink under the influence of static electricity or electromagnetic wave, depending on the charging environment. This phenomenon has no effects on charging.

- If you use the AC adaptor near a radio, the radio reception may be disturbed.

Keep the AC adaptor 1 m (3.3 feet) or more away from radio.

- During usage, the AC adaptor may emit an electrical hum; this is not a malfunction.
- After use, be sure to disconnect the power plug from the electrical outlet.
(A very small amount of current is consumed if it is left connected.)
- Keep the contacts (A) of the charger and battery clean.
Wipe them with a dry cloth if they get dirty.

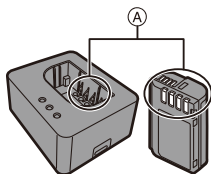

❖ Card

Do not leave the card in areas with high temperatures, direct sunlight, or areas prone to electromagnetic waves and static.

Do not bend or drop the card.

Do not subject the card to strong vibration.

- Otherwise, the card and recorded data may be damaged.
- Put the card in the card case or the storage bag after use and when storing or carrying the card.
- Do not allow dirt, water or other foreign objects to get into the contacts on the card.
Additionally, do not touch the contacts with your hands.

❖ Personal Information

Personal information is stored within the camera and in recorded images. We recommend that you enhance security by setting a Wi-Fi password and Wi-Fi function lock to protect personal information. (→ 468, 469)

- Images may contain information that can be used to identify the user, such as recording dates and times, and location information.
Confirm details carefully before uploading images to a web service.

Disclaimer

- Information including personal information may be altered or vanish due to erroneous operation, effect of static electricity, accident, malfunction, repair, or other handlings.
Please note in advance that Panasonic is not liable in any way for any direct or indirect damage from the alteration or vanishing of information or personal information.

When requesting a repair or transferring/disposing of the camera

- After making a copy of personal information, be sure to delete information, including personal information, such as wireless LAN connection settings that you have registered or saved within the camera with [Reset] (→ 76), and [Delete account] ([LUMIX CLUB]) (→ 472).
- Reset the settings to protect the personal information. (→ 76)
- Remove the card from the camera.
- Settings may return to factory default when camera is repaired.
- Please contact the dealer where you purchased the camera or Panasonic if above operations are not possible due to malfunction.

Points to remember when disposing of/transferring the memory card

Format or delete using the camera or a PC will only modify the file management information, so it will not delete the data in the card completely.

We recommend physically destroying the card or using commercially available PC data deletion software to delete the card data completely when disposing of/transferring the card.

You are responsible for handling of data on cards.

❖ When Not Using the Camera for a Long Period of Time

- Ensure you remove the battery and card from the camera.
If the battery is left in the camera, it may over-discharge, and be rendered unusable even after charging.
- Store the battery in a cool and dry place with a relatively stable temperature.
(Recommended temperature: 15 °C to 25 °C (59 °F to 77 °F); recommended humidity: 40 %RH to 60 %RH)
- If storing for a long period of time, it is recommended that the battery be charged once per year, fully drained in the camera, then removed from the camera and then stored again.
- We recommend storing the camera with a desiccant (silica gel) when you keep it in a closet or a cabinet.
- Check all the parts before recording when you have not used the camera for a long period of time.

❖ Image Data

- Recorded data may be damaged or lost if the camera breaks down due to inappropriate handling.
Panasonic will not be liable for any damage caused due to loss of recorded data.

❖ Tripod

- Make sure the tripod is stable when the camera is attached to it.
- When using a tripod, removal of the battery may not be possible.
- Care is required because tightening the screw excessively may damage the camera, or cause the rating label to come off.
- Please also refer to the operating instructions for the tripod.

❖ Shoulder Strap

- If you attach a heavy interchangeable lens to the camera body, do not carry the camera by the shoulder strap.
Hold the camera and the lens when carrying them.

❖ **Wi-Fi Function**

Use the camera as a wireless LAN device.

When using devices or computer systems that require more reliable security than wireless LAN devices, ensure that the appropriate measures are taken for safety designs and defects for the systems used.

Panasonic will not take any responsibility for any damage that arises when using the camera for any purpose other than as a wireless LAN device.

Use of the Wi-Fi function of the camera is presumed to be in countries where it is sold.

There is the risk that the camera violates the radio wave regulations if used in countries other than those where it is sold, and Panasonic takes no responsibility for any violations.

There is the risk that data sent and received via radio waves may be intercepted.

Please note that there is the risk that data sent and received via radio waves may be intercepted by a third party.

Do not use the camera in areas with magnetic fields, static electricity or interference.

- Do not use the camera in areas with magnetic fields, static electricity or interference, such as near microwave ovens.
These may cause the interruption of the radio waves.
- Using the camera near devices such as microwave ovens or cordless telephones that use the 2.4 GHz radio wave band may cause a decrease in performance in both devices.

Do not connect to the wireless network you are not authorized to use.

When using Wi-Fi, wireless networks (SSID) that you are not allowed to use may be displayed, but you should not connect to these as it may be viewed as unauthorized access.

Number of Pictures That Can Be Taken and Available Recording Time with the Battery

Listed below are the numbers of pictures that can be taken and the time lengths available for recording when the supplied battery is being used.

- The number of pictures that can be taken is according to the CIPA (Camera & Imaging Products Association) standards.
- Using a Panasonic SDHC memory card.
- Using the interchangeable lens (S-R2060).
- The values listed are approximate.

❖ Recording Pictures (When Using the Monitor)

Number of pictures that can be taken	440
---	------------

❖ Recording Pictures (When Using the Viewfinder)

Number of pictures that can be taken	470 (1500)
---	-------------------

- The numbers in parentheses indicate the values that result when [Time to Sleep] in [Power Save LVF Shooting] is set to [1SEC] and the [Power Save LVF Shooting] function works as intended.

(Based on the test conditions derived from the CIPA standard and specified by Panasonic)

❖ Recording Videos (When Using the Monitor)

[MP4] (Recording with the recording quality set to [FHD/8bit/28M/60p])

Continuous available recording time (minutes)	140
Actual available recording time (minutes)	70

[MP4] (Recording with the recording quality set to [4K/10bit/100M/60p])

Continuous available recording time (minutes)	110
Actual available recording time (minutes)	55

[MOV] (Recording with the recording quality set to [FHD/60p/420/8-L])

Continuous available recording time (minutes)	140
Actual available recording time (minutes)	70

[MOV] (Recording with the recording quality set to [4K/60p/420/10-L])

Continuous available recording time (minutes)	100
Actual available recording time (minutes)	50

- Actual available recording time is the time available for recording when repeating actions such as turning the camera on and off, starting/stopping recording, etc.

❖ Playback (When Using the Monitor)

Playback time (minutes)	280
-------------------------	-----



- The number of pictures that can be taken and the available recording time vary depending on the surrounding environment and the usage conditions. For example, these will reduce in the following case:
 - In low-temperature environments, such as on ski slopes.
- If the usage duration drops significantly even when the battery is fully charged, then the battery is at the end of its service life. Replace with a new battery.

Number of Still Images That Can Be Taken and Video Recording Time with Cards

Listed below are the numbers of pictures and the time lengths of videos that can be recorded on a card.

- The values listed are approximate.

❖ Number of Still Images That Can Be Taken

- [Aspect Ratio]: [3:2]; [Picture Quality]: [FINE]

[Picture Size]	Card capacity		
	32 GB	64 GB	128 GB
[L] (24M)	2460	4940	9780
[M] (12M)	4520	8980	17790
[S] (6M)	7940	15440	30570
[Full-Res.]*	970	1930	3830

- [Aspect Ratio]: [3:2]; [Picture Quality]: [RAW+FINE]

[Picture Size]	Card capacity		
	32 GB	64 GB	128 GB
[L] (24M)	650	1300	2580
[M] (12M)	730	1480	2930
[S] (6M)	790	1590	3150
[Full-Res.]*	460	920	1830

- * Indicates the number of pictures when [L]-size JPEG images are recorded simultaneously with [HLG Photo] set to [Full-Res.].

❖ Video Recording Time

- “h” is an abbreviation for hour, “m” for minute and “s” for second.
- Video recording time is the total time of all the videos which have been recorded.
- [Rec. File Format]: [MP4]

[Switch NTSC/PAL]: [NTSC]			
[Rec Quality]	Card capacity		
	32 GB	64 GB	128 GB
[4K/10bit/100M/60p]/ [4K/8bit/100M/30p]/[4K/8bit/100M/24p]	41m00s	1h25m	2h45m
[4K/10bit/72M/30p]/[4K/10bit/72M/24p]	58m00s	1h55m	3h55m
[FHD/8bit/28M/60p]	2h25m	4h55m	9h45m
[FHD/8bit/20M/30p]	3h15m	6h30m	13h00m
[FHD/8bit/24M/24p]	2h50m	5h40m	11h25m

[Switch NTSC/PAL]: [PAL]			
[Rec Quality]	Card capacity		
	32 GB	64 GB	128 GB
[4K/10bit/100M/50p]/[4K/8bit/100M/25p]	41m00s	1h25m	2h45m
[4K/10bit/72M/25p]	58m00s	1h55m	3h55m
[FHD/8bit/28M/50p]	2h25m	4h55m	9h45m
[FHD/8bit/20M/25p]	3h15m	6h30m	13h00m

- [Rec. File Format]: [MOV]

[Switch NTSC/PAL]: [NTSC]			
[Rec Quality]	Card capacity		
	32 GB	64 GB	128 GB
[4K/60p/420/10-L]	20m00s	42m00s	1h20m
[4K/60p/420/8-L]/[4K/30p/422/10-L]/ [4K/24p/422/10-L]/ [4K-A/30p/422/10-L]/[4K-A/24p/422/10-L]	27m00s	56m00s	1h50m
[4K/30p/420/8-L]/[4K/24p/420/8-L]/ [FHD/60p/422/10-L]/[FHD/60p/420/8-L]/ [FHD/30p/422/10-L]/[FHD/30p/420/8-L]/ [FHD/24p/422/10-L]/[FHD/24p/420/8-L]/ [4K-A/30p/420/8-L]/[4K-A/24p/420/8-L]	41m00s	1h25m	2h45m

[Switch NTSC/PAL]: [PAL]			
[Rec Quality]	Card capacity		
	32 GB	64 GB	128 GB
[4K/50p/420/10-L]/[4K-A/50p/420/10-L]	20m00s	42m00s	1h20m
[4K/50p/420/8-L]/[4K/25p/422/10-L]/ [4K-A/50p/420/8-L]/[4K-A/25p/422/10-L]	27m00s	56m00s	1h50m
[4K/25p/420/8-L]/[FHD/50p/422/10-L]/ [FHD/50p/420/8-L]/[FHD/25p/422/10-L]/ [FHD/25p/420/8-L]/[4K-A/25p/420/8-L]	41m00s	1h25m	2h45m











- Depending on the recording conditions and the type of card, number of still images that can be taken, video recording time vary.
- [9999+] is displayed on the recording screen if the remaining number of still images that can be taken is 10000 or more.
- The continuous recordable time for videos is displayed on the screen.













List of Default Settings/Custom Saving/ Settings Available for Copying











: Using [Reset], the function to return to default settings





: Using [Save to Custom Mode], the function to save settings details in the Custom mode











: Using [Save/Restore Camera Setting], the function to copy settings details











Menu		Default setting			
 [Photo]:  [Image Quality]					
[Photo Style]		[ STD.]	✓	✓	✓
[Metering Mode]		[]	✓	✓	✓
[Aspect Ratio]		[3:2]	✓	✓	✓
[Picture Quality]		[FINE]	✓	✓	✓
[Picture Size]		[L] (24M)	✓	✓	✓
[HLG Photo]		[OFF]	✓	✓	✓
[High Resolution Mode]	[Start]	—			
	[Picture Size]	[XL]	✓	✓	✓
	[Picture Quality]	[COMBINED]	✓	✓	✓
	[Simul Record Normal Shot]	[ON]	✓	✓	✓
	[Shutter Delay]	[2 SEC]	✓	✓	✓
	[Motion Blur Processing]	[MODE 1]	✓	✓	✓
[Long Exposure NR]		[ON]	✓	✓	✓
[ISO Sensitivity (photo)]	[ISO Auto Lower Limit Setting]	[100]	✓	✓	✓
	[ISO Auto Upper Limit Setting]	[AUTO]	✓	✓	✓
[Min. Shutter Speed]		[AUTO]	✓	✓	✓
[i.Dynamic Range]		[OFF]	✓	✓	✓
[Vignetting Comp.]		[ON]	✓	✓	✓
[Diffraction Compensation]		[OFF]	✓	✓	✓
[Filter Settings]	[Filter Effect]	[OFF]	✓	✓	✓
	[Simultaneous Record w/o Filter]	[OFF]	✓	✓	✓







Menu		Default setting			
 [Photo]:  [Focus]					
[AF Custom Setting(Photo)]		[Set 1]	✓	✓	✓
[AF Assist Light]		[ON]	✓	✓	✓
[Focus Peaking]	[ON]/[OFF]	[ON]	✓	✓	✓
	[SET]	—	✓	✓	✓
[1-Area AF Moving Speed]		[FAST]	✓	✓	✓
 [Photo]:  [Flash]					
[Flash Mode]			✓	✓	✓
[Firing Mode]		[TTL]	✓	✓	✓
[Flash Adjust.]		[±0 EV]	✓	✓	✓
[Flash Synchro]		[1ST]	✓	✓	✓
[Manual Flash Adjust.]		[1/1]	✓	✓	✓
[Auto Exposure Comp.]		[OFF]	✓	✓	✓
[Red-Eye Removal]		[OFF]	✓	✓	✓
[Wireless]		[OFF]	✓	✓	✓
[Wireless Channel]		[1CH]	✓	✓	✓
[Wireless FP]		[OFF]	✓	✓	✓
[Communication Light]		[HIGH]	✓	✓	✓
[Wireless Setup]		—	✓	✓	✓
 [Photo]:  [Others (Photo)]					
[Bracketing]	[Bracketing Type]	[OFF]	✓	✓	✓
	[More Settings]	—	✓	✓	✓
[Silent Mode]		[OFF]	✓	✓	✓
[Image Stabilizer]	[Operation Mode]		✓	✓	✓
	[Body(B.I.S.) / Lens(O.I.S.)]		✓	✓	✓
	[When to Activate]	[HALF-SHUTTER]	✓	✓	✓
	[E-Stabilization (Video)]	[OFF]	✓	✓	✓
	[Boost I.S. (Video)]	[OFF]	✓	✓	✓
	[Anamorphic (Video)]	[OFF]	✓	✓	✓
	[Focal Length Set]	[35.0 mm]	✓	✓	✓















Menu		Default setting			
[Burst Shot 1 Setting]		[H]	✓	✓	✓
[Burst Shot 2 Setting]		[]	✓	✓	✓
[Shutter Type]		[MECH.]	✓	✓	✓
[Shutter Delay]		[OFF]	✓	✓	✓
[Ex. Tele Conv.]		[OFF]	✓	✓	✓
[Time Lapse/ Animation]	[Mode]	[Time Lapse Shot]	✓	✓	✓
	[Shooting Interval Setting]	[ON]	✓	✓	✓
	[Start Time]	[Now]	✓	✓	✓
	[Image Count]	[1]	✓	✓	✓
	[Shooting Interval]	[1m00s]	✓	✓	✓
	[Exposure Leveling]	[OFF]	✓	✓	✓
[Live View Composite]	[Start]	—			
	[Shutter Delay]	[OFF]	✓	✓	✓
[Self Timer]		[ 10]	✓	✓	✓
[6K/4K PHOTO]	[Picture Size / Burst Speed]	[6K 18M]	✓	✓	✓
	[Rec Method]	[]	✓	✓	✓
	[Pre-Burst Recording]	[OFF]	✓	✓	✓
[Post-Focus]		[OFF]	✓	✓	✓
[Multiple Exposure]	[Start]	—			
	[Auto Gain]	[ON]	✓	✓	✓
	[Overlay]	[OFF]	✓	✓	✓
 [Video]:  [Image Quality]					
[Exposure Mode]		[P]	✓	✓	✓
[Photo Style]		[ STD.]	✓	✓	✓
[Metering Mode]		[]	✓	✓	✓
[ISO Sensitivity (video)]	[ISO Auto Lower Limit Setting]	[100]	✓	✓	✓
	[ISO Auto Upper Limit Setting]	[AUTO]	✓	✓	✓



Menu		Default setting			
[Flicker Decrease (Video)]		[OFF]	✓	✓	✓
[i.Dynamic Range]		[OFF]	✓	✓	✓
[Vignetting Comp.]		[ON]	✓	✓	✓
[Diffraction Compensation]		[OFF]	✓	✓	✓
[Filter Settings]	[Filter Effect]	[OFF]	✓	✓	✓
	[Simultaneous Record w/o Filter]	[OFF]	✓	✓	✓
 [Video]:  [Image Format]					
[Image Area of Video]		[FULL]	✓	✓	✓
[Rec Quality]	When [Switch NTSC/PAL] is set to [NTSC]: [FHD/8bit/28M/60p]		✓	✓	✓
	When [Switch NTSC/PAL] is set to [PAL]: [FHD/8bit/28M/50p]				
[Slow & Quick Setting]		[30fps]	✓	✓	✓
[Switch NTSC/PAL]		[NTSC]	✓	✓	✓
[Rec. File Format]		[MP4]	✓	✓	✓
[Time Code]	[Time Code Display]	[OFF]	✓	✓	✓
	[Count Up]	[REC RUN]	✓	✓	✓
	[Time Code Value]	—			
	[Time Code Mode]	[DF]	✓	✓	✓
	[HDMI Time Code Output]	[OFF]	✓	✓	✓
[Luminance Level]		[16-255]	✓	✓	✓
[Anamorphic(4:3)]		[OFF]	✓	✓	









Menu		Default setting			
 [Video]:  [Focus]					
[AF Custom Setting(Video)]	[ON]/[OFF]	[OFF]	✓	✓	✓
	[SET]	—	✓	✓	✓
[Continuous AF]		[MODE1]	✓	✓	✓
[AF Assist Light]		[ON]	✓	✓	✓
[Focus Peaking]	[ON]/[OFF]	[ON]	✓	✓	✓
	[SET]	—	✓	✓	✓
[1-Area AF Moving Speed]		[FAST]	✓	✓	✓
 [Video]:  [Audio]					
[Sound Rec Level Disp.]		[OFF]	✓	✓	✓
[Sound Rec Level Adj.]		[0dB]	✓	✓	✓
[Sound Rec Level Limiter]		[ON]	✓	✓	✓
[Wind Noise Canceller]		[STANDARD]	✓	✓	✓
[Wind Cut]		[OFF]	✓	✓	✓
[Mic Socket]		[MIC]	✓	✓	✓
[Special Mic.]		[STEREO]	✓	✓	✓
[XLR Mic Adaptor Setting]		[ON]	✓	✓	✓
[Sound Output]		[REALTIME]	✓	✓	✓
[Headphone Volume]		[LEVEL3]	✓		✓
 [Video]:  [Others (Video)]					
[Silent Mode]		[OFF]	✓	✓	✓
[Image Stabilizer]	[Operation Mode]	[]	✓	✓	✓
	[Body(B.I.S.) / Lens(O.I.S.)]	[]	✓	✓	✓
	[When to Activate]	[HALF-SHUTTER]	✓	✓	✓
	[E-Stabilization (Video)]	[OFF]	✓	✓	✓
	[Boost I.S. (Video)]	[OFF]	✓	✓	✓
	[Anamorphic (Video)]	[OFF]	✓	✓	✓
	[Focal Length Set]	[35.0 mm]	✓	✓	✓
[Live Cropping]		[OFF]	✓	✓	✓













Menu		Default setting			
 [Custom]:  [Image Quality]					
[Photo Style Settings]	[Show/Hide Photo Style]	—	✓	✓	✓
	[My Photo Style Settings]	—	✓	✓	✓
	[Reset Photo Style]	—			
[ISO Increments]		[1/3 EV]	✓	✓	✓
[Extended ISO]		[OFF]	✓	✓	✓
[Exposure Offset Adjust.]	[Multi Metering]	[±0EV]	✓	✓	✓
	[Center Weighted]	[±0EV]	✓	✓	✓
	[Spot]	[±0EV]	✓	✓	✓
	[Highlight Weighted]	[±0EV]	✓	✓	✓
[Color Space]		[sRGB]	✓	✓	✓
[Exposure Comp. Reset]		[OFF]	✓		✓
[Auto Exposure in P/A/S/M]		[ON]	✓	✓	✓
[CreativeVideo Combined Set.]	[F/SS/ISO/Exposure Comp.]	[]	✓	✓	✓
	[White Balance]	[]	✓	✓	✓
	[Photo Style]	[]	✓	✓	✓
	[Metering Mode]	[]	✓	✓	✓
	[AF Mode]	[]	✓	✓	✓













Menu		Default setting			
 [Custom]:  [Focus/Shutter]					
[Focus/Shutter Priority]	[AFS]	[FOCUS]	✓	✓	✓
	[AFC]	[BALANCE]	✓	✓	✓
[Focus Switching for Vert / Hor]		[OFF]	✓	✓	✓
[AF/AE Lock Hold]		[OFF]	✓	✓	✓
[AF+MF]		[OFF]	✓	✓	✓
[MF Assist]	[Focus Ring]	[ON]	✓	✓	✓
	[AF Mode]	[ON]	✓	✓	✓
	[Press Joystick]	[OFF]	✓	✓	✓
	[MF Assist Display]	[PIP]	✓	✓	✓
[MF Guide]		[]	✓	✓	✓
[Focus Ring Lock]		[OFF]	✓	✓	✓
[Show/Hide AF Mode]	[Face/Eye/Body/Animal Detect.]	[ON]	✓	✓	✓
	[Tracking]	[ON]	✓	✓	✓
	[225-Area]	[ON]	✓	✓	✓
	[Zone (Vert./ Horz.)]	[ON]	✓	✓	✓
	[Zone (Square)]	[OFF]	✓	✓	✓
	[Zone (Oval)]	[ON]	✓	✓	✓
	[1-Area+]	[ON]	✓	✓	✓
	[Pinpoint]	[ON]	✓	✓	✓
	[Custom1]	[OFF]	✓	✓	✓
	[Custom2]	[OFF]	✓	✓	✓
[Custom3]	[OFF]	✓	✓	✓	







Menu		Default setting			
[Pinpoint AF Setting]	[Pinpoint AF Time]	[MID]	✓	✓	✓
	[Pinpoint AF Display]	[PIP]	✓	✓	✓
[AF-Point Scope Setting]	[Keep Enlarged Display]	[OFF]	✓	✓	✓
	[PIP Display]	[PIP]	✓	✓	✓
[Shutter AF]		[ON]	✓	✓	✓
[Half-Press Shutter]		[OFF]	✓	✓	✓
[Quick AF]		[OFF]	✓	✓	✓
[Eye Sensor AF]		[OFF]	✓	✓	✓
[Looped Focus Frame]		[OFF]	✓	✓	✓
[AFC Start Point (225-Area)]		[OFF]	✓	✓	✓
 [Custom]:  [Operation]					
[Q.MENU Settings]	[Layout Style]	[MODE1]	✓	✓	✓
	[Front Dial Assignment]	[Value]	✓	✓	✓
	[Item Customize (Photo)]	—	✓	✓	✓
	[Item Customize (Video)]	—	✓	✓	✓
[Touch Settings]	[Touch Screen]	[ON]	✓	✓	✓
	[Touch Tab]	[OFF]	✓	✓	✓
	[Touch AF]	[AF]	✓	✓	✓
	[Touch Pad AF]	[OFF]	✓	✓	✓
[Operation Lock Setup]	[Cursor]	[	✓	✓	✓
	[Joystick]	[	✓	✓	✓
	[Touch Screen]	[	✓	✓	✓
	[Dial]	[	✓	✓	✓
	[DISP. Button]	[	✓	✓	✓
[Fn Button Set]	[Setting in REC mode]	—	✓	✓	✓
	[Setting in PLAY mode]	—	✓	✓	✓
[WB/ISO/Expo. Button]		[AFTER PRESSING2]	✓	✓	✓
[ISO Displayed Setting]	[Front/Rear Dials]	[ / 	✓	✓	✓
	[Exposure Comp. Disp. Setting]		[OFF]	✓	✓
[Exposure Comp. Disp. Setting]	[Cursor Buttons (Up/Down)]	[OFF]	✓	✓	✓
	[Front/Rear Dials]	[ / 	✓	✓	✓















Menu		Default setting			
[Dial Set.]	[Assign Dial (F/SS)]	[SET1]	✓	✓	✓
	[Rotation (F/SS)]	[ 	✓	✓	✓
	[Control Dial Assignment]	[	✓	✓	✓
	[Exposure Comp.]	[OFF]	✓	✓	✓
	[Dial Operation Switch Setup]	—	✓	✓	✓
	[Rotation (Menu Operation)]	[ 	✓	✓	✓
[Joystick Setting]	[D.FOCUS Movement]	✓	✓	✓	
[Video Rec. Button (Remote)]	[Video Record]	✓	✓	✓	
 [Custom]:  [Monitor / Display (Photo)]					
[Auto Review]	[Duration Time (photo)]	[OFF]	✓	✓	✓
	[Duration Time (6K/4K PHOTO)]	[HOLD]	✓	✓	✓
	[Duration Time (Post-Focus)]	[HOLD]	✓	✓	✓
	[Playback Operation Priority]	[OFF]	✓	✓	✓
[Constant Preview]	[ON]/[OFF]	[OFF]	✓	✓	✓
	[SET]	—	✓	✓	✓
[Histogram]		[OFF]	✓	✓	✓
[Photo Grid Line]		[OFF]	✓	✓	✓
[Frame Marker]	[ON]/[OFF]	[OFF]	✓	✓	✓
	[SET]	—	✓	✓	✓
[AF Area Display]		[ON]	✓	✓	✓
[Live View Boost]	[MODE1]/[MODE2]/[OFF]	[OFF]	✓	✓	✓
	[SET]	[M]	✓	✓	✓
[Night Mode]	[Monitor]	[OFF]	✓	✓	✓
	[LVF]	[OFF]	✓	✓	✓
[LVF/Monitor Disp. Set]	[LVF Disp. Set]	[	✓	✓	✓
	[Monitor Disp. Set]	[	✓	✓	✓

Menu		Default setting			
[Expo.Meter]		[OFF]	✓	✓	✓
[Focal Length]		[ON]	✓	✓	✓
[Photo/Video Preview]		[]	✓	✓	✓
[Photos/Videos Remaining]		[ : ]	✓	✓	✓
[Blinking Highlights]		[OFF]	✓	✓	✓
[Sheer Overlay]	[ON]/[OFF]	[OFF]	✓		
	[SET]	—	✓		
[I.S. Status Scope]		[OFF]	✓	✓	✓
[Level Gauge]		[ON]	✓	✓	✓
[Luminance Spot Meter]		[OFF]	✓	✓	✓
[Framing Outline]		[OFF]	✓	✓	✓
[Show/Hide Monitor Layout]	[Control Panel]	[ON]	✓	✓	✓
	[Black Screen]	[ON]	✓	✓	✓
 [Custom]:  [Monitor / Display (Video)]					
[V-Log View Assist]	[Read LUT File]	—			
	[LUT Select]	[Vlog_709]	✓	✓	
	[LUT View Assist (Monitor)]	[OFF]	✓	✓	
	[LUT View Assist (HDMI)]	[OFF]	✓	✓	
[HLG View Assist]	[Monitor]	[MODE2]	✓	✓	✓
	[HDMI]	[AUTO]	✓	✓	✓
[Anamorphic Desqueeze Display]		[OFF]	✓	✓	✓
[Monochrome Live View]		[OFF]	✓	✓	✓
[Center Marker]		[OFF]	✓	✓	✓
[Zebra Pattern]	[ZEBRA1]/[ZEBRA2]/ [ZEBRA1+2]/[OFF]	[OFF]	✓	✓	✓
	[SET]	—	✓	✓	✓
[Waveform Monitor]		[OFF]	✓	✓	✓
[Red REC Frame Indicator]		[OFF]	✓	✓	✓

Menu		Default setting			
 [Custom]:  [IN/OUT]					
[HDMI Rec Output]	[Info Display]	[ON]	✓	✓	✓
	[HDMI Recording Control]	[OFF]	✓	✓	✓
	[4K/60p Bit Mode]/ [4K/50p Bit Mode]	[4:2:0 8bit]	✓	✓	✓
	[Sound Output (HDMI)]	[ON]	✓	✓	✓
 [Custom]:  [Lens / Others]					
[Lens Focus Resume]		[OFF]	✓	✓	✓
[Lens Fn Button Setting]		[Focus Stop]	✓	✓	✓
[Focus Ring Control]	[NON-LINEAR]/[LINEAR]	[NON-LINEAR]	✓	✓	✓
	[SET]	[150°]	✓	✓	✓
 [Setup]:  [Card/File]					
[Card Format]		—			
[Double Card Slot Function]	[Recording Method]		✓		✓
	[Destination Card Slot]	 [1 → 2]	✓		✓
[Folder / File Settings]	[Select Folder]	—			
	[Create a New Folder]	—			
	[File Name Setting]	[Folder Number Link]	✓		✓
[File Number Reset]		—			
[Copyright Information]	[Artist]	[OFF]	✓		✓
	[Copyright Holder]	[OFF]	✓		✓
	[Display Copyright Info.]	—			
 [Setup]:  [Monitor / Display]					
[Power Save Mode]	[Sleep Mode]	[5MIN.]	✓		✓
	[Sleep Mode(Wi-Fi)]	[ON]	✓		✓
	[Auto LVF/Monitor Off]	[5MIN.]	✓		✓
	[Power Save LVF Shooting]	—	✓		✓





Menu		Default setting			
[Monitor Frame Rate]		[60fps]	✓		✓
[LVF Frame Rate]		[60fps]	✓		✓
[Monitor Settings]/[Viewfinder]		—	✓		
[Monitor Backlight]/[LVF Luminance]		[AUTO]	✓		✓
[Eye Sensor]	[Sensitivity]	[HIGH]	✓		✓
	[LVF/Monitor Switch]	[LVF/MON AUTO]	✓		✓
[Level Gauge Adjust.]	[Adjust.]	—	✓		
	[Level Gauge Value Reset]	—			
 [Setup]:  [IN/OUT]					
[Beep]	[Beep Volume]	[]	✓		✓
	[AF Beep Volume]	[]	✓		✓
	[AF Beep Tone]	[]	✓		✓
	[E-Shutter Vol]	[]	✓		✓
	[E-Shutter Tone]	[]	✓		✓
[Headphone Volume]		[LEVEL3]	✓		✓
[Wi-Fi]		—	✓		
[Bluetooth]		—	✓		
[USB]	[USB Mode]	[][Select on connection]	✓		✓
	[USB Power Supply]	[ON]	✓		✓
[Battery Use Priority]		[BG]	✓		✓
[TV Connection]	[HDMI Mode (Playback)]	[AUTO]	✓		✓
	[LUT View Assist (HDMI)]	[OFF]	✓	✓	
	[HLG View Assist (HDMI)]	[AUTO]	✓	✓	✓
	[VIERA Link (CEC)]	[OFF]	✓		✓
	[Background Color(Playback)]	[]	✓		✓
	[Photo Luminance Level]	[16-255]	✓		✓
[Wireless Connection Light]		[ON]	✓		✓



Menu		Default setting			
 [Setup]:  [Setting]					
[Save to Custom Mode]		—	✓		✓
[Load Custom Mode]		—	✓		✓
[Custom Mode Settings]	[Limit No. of Custom Mode]	[3]	✓		✓
	[Edit Title]	—	✓		✓
	[How to Reload Custom Mode]	—	✓		✓
	[Select Loading Details]	—	✓		✓
[Save/Restore Camera Setting]	[Save]	—			
	[Load]	—			
	[Delete]	—			
	[Keep Settings While Format]	[OFF]	✓		✓
[Reset]		—			
 [Setup]:  [Others]					
[Clock Set]		0:00:00 1/1/2020			
[Time Zone]		GMT – 5:00			✓
[Pixel Refresh]		—			
[Sensor Cleaning]		—			
[Language]		[ENGLISH]	✓		✓
[Firmware Version]		—			
[Online Manual]		—			
[Approved Regulations]		—			







Menu	Default setting			
 [My Menu]:  [Edit My Menu]				
[Add]	—	✓		✓
[Sorting]	—			
[Delete]	—			
[Display from My Menu]	[OFF]	✓		✓
 [Playback]:  [Playback Mode]				
[Playback Mode]	[Normal Play]	✓		✓
[Slide Show]	—	✓		✓
[Rotate Disp.]	[ON]	✓		✓
[Picture Sort]	[DATE/TIME]	✓		✓
[Magnify from AF Point]	[OFF]	✓		✓
[LUT View Assist (Monitor)]	[OFF]	✓	✓	
[HLG View Assist (Monitor)]	[MODE2]	✓	✓	✓
[Anamorphic Desqueeze Display]	[OFF]	✓	✓	✓
 [Playback]:  [Process Image]				
[RAW Processing]	—			
[6K/4K PHOTO Bulk Saving]	—			
[6K/4K PHOTO Noise Reduction]	[AUTO]	✓		✓
[Time Lapse Video]	—			
[Stop Motion Video]	—			
 [Playback]:  [Add/Delete Info.]				
[Protect]	—			
[Rating]	—			
 [Playback]:  [Edit Image]				
[Resize]	—			
[Rotate]	—			
[Video Divide]	—			
[Copy]	—			
 [Playback]:  [Others]				
[Delete Confirmation]	["No" first]	✓		✓
[Delete All Images]	—			



List of Functions That Can Be Set in Each Recording Mode

Menu		iA	P	A	S	M		S&Q
 [Photo]:  [Image Quality]								
[Photo Style]		✓	✓	✓	✓	✓		
[Metering Mode]			✓	✓	✓	✓		
[Aspect Ratio]		✓	✓	✓	✓	✓		
[Picture Quality]		✓	✓	✓	✓	✓		
[Picture Size]		✓	✓	✓	✓	✓		
[HLG Photo]			✓	✓	✓	✓		
[High Resolution Mode]	[Start]		✓	✓	✓	✓		
	[Picture Size]		✓	✓	✓	✓		
	[Picture Quality]		✓	✓	✓	✓		
	[Simul Record Normal Shot]		✓	✓	✓	✓		
	[Shutter Delay]		✓	✓	✓	✓		
[Motion Blur Processing]			✓	✓	✓	✓		
[Long Exposure NR]			✓	✓	✓	✓		
[ISO Sensitivity (photo)]	[ISO Auto Lower Limit Setting]		✓	✓	✓	✓		
	[ISO Auto Upper Limit Setting]		✓	✓	✓	✓		
[Min. Shutter Speed]			✓	✓				
[i.Dynamic Range]			✓	✓	✓	✓		
[Vignetting Comp.]			✓	✓	✓	✓		
[Diffraction Compensation]			✓	✓	✓	✓		
[Filter Settings]	[Filter Effect]		✓	✓	✓	✓		
	[Simultaneous Record w/o Filter]		✓	✓	✓	✓		
 [Photo]:  [Focus]								
[AF Custom Setting(Photo)]			✓	✓	✓	✓		
[AF Assist Light]			✓	✓	✓	✓		

Menu		iA	P	A	S	M	 M	S&Q
[Focus Peaking]	[ON]/[OFF]	✓	✓	✓	✓	✓		
	[SET]	✓	✓	✓	✓	✓		
[1-Area AF Moving Speed]		✓	✓	✓	✓	✓		
 [Photo]:  [Flash]								
[Flash Mode]		✓	✓	✓	✓	✓		
[Firing Mode]			✓	✓	✓	✓		
[Flash Adjust.]			✓	✓	✓	✓		
[Flash Synchro]			✓	✓	✓	✓		
[Manual Flash Adjust.]			✓	✓	✓	✓		
[Auto Exposure Comp.]			✓	✓	✓	✓		
[Red-Eye Removal]			✓	✓	✓	✓		
[Wireless]			✓	✓	✓	✓		
[Wireless Channel]			✓	✓	✓	✓		
[Wireless FP]			✓	✓	✓	✓		
[Communication Light]			✓	✓	✓	✓		
[Wireless Setup]			✓	✓	✓	✓		
 [Photo]:  [Others (Photo)]								
[Bracketing]	[Bracketing Type]	✓	✓	✓	✓	✓		
	[More Settings]	✓	✓	✓	✓	✓		
[Silent Mode]		✓	✓	✓	✓	✓		
[Image Stabilizer]	[Operation Mode]	✓	✓	✓	✓	✓		
	[Body(B.I.S.) / Lens(O.I.S.)]	✓	✓	✓	✓	✓		
	[When to Activate]	✓	✓	✓	✓	✓		
	[E-Stabilization (Video)]	✓	✓	✓	✓	✓		
	[Boost I.S. (Video)]	✓	✓	✓	✓	✓		
	[Anamorphic (Video)]	✓	✓	✓	✓	✓		
[Focal Length Set]		✓	✓	✓	✓	✓		

Menu		iA	P	A	S	M		S&Q
[Burst Shot 1 Setting]		✓	✓	✓	✓	✓		
[Burst Shot 2 Setting]		✓	✓	✓	✓	✓		
[Shutter Type]		✓	✓	✓	✓	✓		
[Shutter Delay]		✓	✓	✓	✓	✓		
[Ex. Tele Conv.]		✓	✓	✓	✓	✓		
[Time Lapse/Animation]		✓	✓	✓	✓	✓		
[Live View Composite]	[Start]					✓		
	[Shutter Delay]					✓		
[Self Timer]		✓	✓	✓	✓	✓		
[6K/4K PHOTO]	[Picture Size / Burst Speed]	✓	✓	✓	✓	✓		
	[Rec Method]	✓	✓	✓	✓	✓		
	[Pre-Burst Recording]	✓	✓	✓	✓	✓		
[Post-Focus]		✓	✓	✓	✓	✓		
[Multiple Exposure]	[Start]		✓	✓	✓	✓		
	[Auto Gain]		✓	✓	✓	✓		
	[Overlay]		✓	✓	✓	✓		
 [Video]:  [Image Quality]								
[Exposure Mode]							✓	✓
[Photo Style]		✓	✓	✓	✓	✓	✓	✓
[Metering Mode]			✓	✓	✓	✓	✓	✓
[ISO Sensitivity (video)]	[ISO Auto Lower Limit Setting]						✓	✓
	[ISO Auto Upper Limit Setting]						✓	✓
[Flicker Decrease (Video)]			✓	✓	✓	✓		
[i.Dynamic Range]			✓	✓	✓	✓	✓	✓
[Vignetting Comp.]			✓	✓	✓	✓	✓	
[Diffraction Compensation]			✓	✓	✓	✓	✓	✓
[Filter Settings]	[Filter Effect]		✓	✓	✓	✓	✓	
	[Simultaneous Record w/o Filter]		✓	✓	✓	✓		

Menu		iA	P	A	S	M		S&Q
 [Video]:  [Image Format]								
[Image Area of Video]		✓	✓	✓	✓	✓	✓	
[Rec Quality]		✓	✓	✓	✓	✓	✓	✓
[Slow & Quick Setting]								✓
[Switch NTSC/PAL]		✓	✓	✓	✓	✓	✓	✓
[Rec. File Format]		✓	✓	✓	✓	✓	✓	
[Time Code]	[Time Code Display]	✓	✓	✓	✓	✓	✓	
	[Count Up]	✓	✓	✓	✓	✓	✓	
	[Time Code Value]	✓	✓	✓	✓	✓	✓	
	[Time Code Mode]	✓	✓	✓	✓	✓	✓	
	[HDMI Time Code Output]						✓	
[Luminance Level]		✓	✓	✓	✓	✓	✓	✓
[Anamorphic(4:3)]							✓	
 [Video]:  [Focus]								
[AF Custom Setting(Video)]	[ON]/[OFF]	✓	✓	✓	✓	✓	✓	✓
	[SET]	✓	✓	✓	✓	✓	✓	✓
[Continuous AF]		✓	✓	✓	✓	✓	✓	✓
[AF Assist Light]			✓	✓	✓	✓	✓	✓
[Focus Peaking]	[ON]/[OFF]	✓	✓	✓	✓	✓	✓	✓
	[SET]	✓	✓	✓	✓	✓	✓	✓
[1-Area AF Moving Speed]		✓	✓	✓	✓	✓	✓	✓
 [Video]:  [Audio]								
[Sound Rec Level Disp.]		✓	✓	✓	✓	✓	✓	
[Sound Rec Level Adj.]		✓	✓	✓	✓	✓	✓	
[Sound Rec Level Limiter]		✓	✓	✓	✓	✓	✓	
[Wind Noise Canceller]		✓	✓	✓	✓	✓	✓	
[Wind Cut]		✓	✓	✓	✓	✓	✓	
[Mic Socket]		✓	✓	✓	✓	✓	✓	✓
[Special Mic.]		✓	✓	✓	✓	✓	✓	✓
[XLR Mic Adaptor Setting]		✓	✓	✓	✓	✓	✓	✓
[Sound Output]		✓	✓	✓	✓	✓	✓	✓
[Headphone Volume]		✓	✓	✓	✓	✓	✓	✓

Menu		iA	P	A	S	M		S&Q
 [Video]:  [Others (Video)]								
[Silent Mode]		✓	✓	✓	✓	✓	✓	✓
[Image Stabilizer]	[Operation Mode]	✓	✓	✓	✓	✓	✓	✓
	[Body(B.I.S.) / Lens(O.I.S.)]	✓	✓	✓	✓	✓	✓	✓
	[When to Activate]	✓	✓	✓	✓	✓		
	[E-Stabilization (Video)]	✓	✓	✓	✓	✓	✓	
	[Boost I.S. (Video)]	✓	✓	✓	✓	✓	✓	✓
	[Anamorphic (Video)]	✓	✓	✓	✓	✓	✓	✓
	[Focal Length Set]	✓	✓	✓	✓	✓	✓	✓
[Live Cropping]							✓	

Specifications

The specifications are subject to change for performance enhancement.

Digital camera body (DC-S5):

Information for your safety

Power source:	8.4 V===
Power consumption:	4.3 W (when recording with the monitor), 3.2 W (when playing back with the monitor) [When using the interchangeable lens (S-R2060)]

Type	
Type	Digital Single Lens Mirrorless camera
Recording media	SD memory card / SDHC memory card / SDXC memory card <ul style="list-style-type: none"> • Card slot 1 <ul style="list-style-type: none"> – Compliant with UHS-I/UHS-II UHS Speed Class 3 – Compliant with UHS-II Video Speed Class 90 • Card slot 2 <ul style="list-style-type: none"> – Compliant with UHS-I UHS Speed Class 3 Double slot recording function is available.
Lens mount	Leica Camera AG L-Mount
Image sensor	
Image sensor	35 mm full-frame (35.6 mm×23.8 mm) CMOS sensor, a total of 25,280,000 pixels, primary color filter
Effective number of pixels of the camera	24,200,000 pixels
Latitude	
14+ stops ([V-Log])	

Recording format for still images	
File format for still images	JPEG (DCF compliant, Exif 2.31 compliant) / RAW / HLG photo (CTA-2072 compliant)
File format for 6K/4K photos	6K photo: MP4 (H.265/HEVC, AAC (2ch)) 4K photo: MP4 (H.264/MPEG-4 AVC, AAC (2ch))
Picture size (pixels)	<p>When the aspect ratio setting is [4:3]</p> <p>[L]: 5328×4000 (3536×2656)* [M]: 3792×2848 (2560×1920)* [S]: 2688×2016 (1840×1376)* [High Resolution Mode] ([XL]): 10656×8000 [High Resolution Mode] ([LL]): 7552×5664 6K photo: 4992×3744 4K photo: 3328×2496 (3328×2496)* [HLG Photo] ([Full-Res.]): 5312×3984 [HLG Photo] ([4K-Res.]): 2880×2160 (2880×2160)*</p> <p>When the aspect ratio setting is [3:2]</p> <p>[L]: 6000×4000 (3984×2656)* [M]: 4272×2848 (2880×1920)* [S]: 3024×2016 (2064×1376)* [High Resolution Mode] ([XL]): 12000×8000 [High Resolution Mode] ([LL]): 8496×5664 6K photo: 5184×3456 4K photo: 3504×2336 (3504×2336)* [HLG Photo] ([Full-Res.]): 5984×4000 [HLG Photo] ([4K-Res.]): 3232×2160 (3232×2160)*</p> <p>When the aspect ratio setting is [16:9]</p> <p>[L]: 6000×3368 (3984×2240)* [M]: 4272×2400 (2880×1624)* [S]: 3024×1704 (1920×1080)* [High Resolution Mode] ([XL]): 12000×6736 [High Resolution Mode] ([LL]): 8496×4784 4K photo: 3840×2160 (3840×2160)* [HLG Photo] ([Full-Res.]): 5888×3312 [HLG Photo] ([4K-Res.]): 3840×2160 (3840×2160)*</p> <p>* Figures in parentheses are for APS-C lenses</p>

Picture size (pixels)	When the aspect ratio setting is [1:1] [L]: 4000×4000 (2656×2656)* [M]: 2848×2848 (1920×1920)* [S]: 2016×2016 (1376×1376)* [High Resolution Mode] ([XL]): 8000×8000 [High Resolution Mode] ([LL]): 5664×5664 4K photo: 2880×2880 (2880×2880)* [HLG Photo] ([Full-Res.]): 4000×4000 [HLG Photo] ([4K-Res.]): 2144×2144 (2144×2144)* When the aspect ratio setting is [65:24] [L]: 6000×2208 When the aspect ratio setting is [2:1] [L]: 6000×3000 * Figures in parentheses are for APS-C lenses
Image quality for pictures	Fine / Standard / RAW+Fine / RAW+Standard / RAW

Recording format for video	
Video format	MP4 (H.264/MPEG-4 AVC, H.265/HEVC) / MOV (H.264/MPEG-4 AVC, H.265/HEVC)
Audio format	MP4 AAC (2ch)
	MOV LPCM (2ch, 48 kHz/16-bit)
Image quality for video	Refer to page 250 and 285 in this document for information about resolution, recording frame rate, and other elements of recording quality.
S&Q (Slow & Quick)	[Switch NTSC/PAL]: [NTSC] When the recording quality setting is [4K/8bit/100M/30p] Frame rate: 1 fps to 60 fps When the recording quality setting is [4K/8bit/100M/24p] Frame rate: 1 fps to 60 fps When the recording quality setting is [FHD/8bit/28M/60p] Frame rate: 1 fps to 180 fps When the recording quality setting is [FHD/8bit/20M/30p] Frame rate: 1 fps to 180 fps When the recording quality setting is [FHD/8bit/24M/24p] Frame rate: 1 fps to 180 fps
	[Switch NTSC/PAL]: [PAL] When the recording quality setting is [4K/8bit/100M/25p] Frame rate: 1 fps to 60 fps When the recording quality setting is [FHD/8bit/28M/50p] Frame rate: 1 fps to 180 fps When the recording quality setting is [FHD/8bit/20M/25p] Frame rate: 1 fps to 180 fps

Viewfinder	
System	Aspect ratio 4:3, 0.39 inches, approx. 2,360,000 dots, organic EL (OLED) live view viewfinder
Field of view ratio	Approx. 100 %
Magnification	Approx. $0.74\times$ (-1.0 m^{-1} 50 mm at infinity, with aspect ratio set to [3:2])
Eye point	Approx. 20.0 mm (at -1.0 m^{-1})
Diopter adjustment range	-4.0 to $+4.0$ diopter
Eye sensor	Yes
Monitor	
System	Aspect ratio 3:2, 3.0 inches, approx. 1,840,000 dots monitor, capacitive touch screen
Field of view ratio	Approx. 100 %
Focus	
AF type	TTL type based on image detection (Contrast AF)
Focus mode	AFS / AFC / MF
AF mode	Automatic detection (Face/Eye/Body/Animal) / Tracking / 225-Area / Zone (Vertical/Horizontal) / Zone (Square) / Zone (Oval) / 1-Area+ Supplementary / 1-Area / Pinpoint / Custom1, 2, 3, Focus area selection is possible by touching or with the joystick

Exposure control	
Light metering system, Light metering mode	1728-zone metering, multi-metering / center-weighted metering / spot metering / highlight-weighted metering
Metering range	EV 0 to EV 18 (F2.0 lens, ISO100 conversion)
Exposure	Program AE (P) / Aperture-Priority AE (A) / Shutter-Priority AE (S) / Manual Exposure (M)
Exposure compensation	1/3 EV steps, ± 5 EV
ISO sensitivity (standard output sensitivity)	AUTO / 100 to 51200, When [Extended ISO] is set: AUTO / 50 to 204800, 1/3 EV steps
Image stabilizer	
Image stabilizer type	Compliant with Image sensor shift type, 5-axis stabilizer, Dual I.S.2
Image stabilizer effect	In-body image stabilizer: 5.0 stops [Focal length f=60 mm, using an interchangeable lens (S-R2060)] Dual I.S.2: 6.5 stops [Focal length f=200 mm, using an interchangeable lens (S-E70200)] (Based on the CIPA standard, Yaw/Pitch direction)
White balance	
White balance mode	AWB / AWBc / AWBw / Daylight / Cloudy / Shade / Incandescent lights / Flash / Set mode 1, 2, 3, 4 / Color temperature 1, 2, 3, 4

Shutter		
Format	Focal-plane shutter	
Shutter speed	Pictures: Mechanical shutter: Bulb (max. approx. 30 minutes), 60 seconds to 1/8000 of a second Electronic front curtain: Bulb (max. approx. 30 minutes), 60 seconds to 1/2000 of a second Electronic shutter: Bulb (max. approx. 60 seconds), 60 seconds to 1/8000 of a second Videos: 1/25* of a second to 1/16000 of a second * When [Exposure Mode] is set to [M] in Creative Video mode and focus mode is set to [MF], this can be set up to 1/2	
Flash synchronization speed	Equal to or smaller than 1/250 of a second* * The guide number decreases at 1/250 of a second, only during [S]/[M] modes	
Burst recording		
Mechanical shutter/ Electronic front curtain	High speed	7 frames/second ([AFS], [MF]) / 5 frames/second ([AFC])
	Medium speed	5 frames/second
	Low speed	2 frames/second
Electronic shutter	High speed	7 frames/second ([AFS], [MF]) / 5 frames/second ([AFC])
	Medium speed	5 frames/second
	Low speed	2 frames/second

Maximum number of frames recordable	[FINE] / [STD.]: 999 frames or more [RAW+FINE] / [RAW+STD.] / [RAW]: 24 frames or more (When recording is performed under the test conditions specified by Panasonic (Using a card in card slot 1 compatible with UHS-II))
Zoom	
Extended Tele Conversion (Picture)	Max. 2×* (when a picture size of [S] is selected.) * Max. 1.9× when using APS-C lenses
Display language	
[ENGLISH] / [DEUTSCH] / [FRANÇAIS] / [ITALIANO] / [ESPAÑOL] / [繁體中文] / [PORTUGUÊS] / [日本語]	
Microphone / Speaker	
Microphone	Stereo
Speaker	Monaural
Interface	
USB	USB Type-C™, SuperSpeed USB3.1 GEN1
[HDMI]	micro HDMI Type D
[REMOTE]	∅ 2.5 mm jack
[MIC]	∅ 3.5 mm stereo mini jack, Mic Input (Plug-in Power) / Mic Input / Line Input (Operate the menu to switch between these inputs), Standard input level: -55 dBV (Mic Input) / -10 dBV (Line Input)
Headphones	∅ 3.5 mm stereo mini jack
Splash Resistant	
Yes	

External dimensions / Mass	
External dimensions	Approx. 132.6 mm (W)×97.1 mm (H)×81.9 mm (D) (5.22" (W)×3.82" (H)×3.22" (D)) (excluding the projecting parts)
Mass (Weight)	Approx. 714 g/1.58 lb (camera body, with battery and one card) Approx. 630 g/1.39 lb (only camera body)
Operating environment	
Recommended operating temperature	0 °C to 40 °C (32 °F to 104 °F)
Permissible relative humidity	10 %RH to 80 %RH

35 mm full-frame interchangeable lens:**S-R2060 “LUMIX S 20-60 mm F3.5-5.6”**

Mount	Leica Camera AG L-Mount
Focal length	f=20 mm to 60 mm
Lens construction	11 elements in 9 groups (2 aspherical lenses, 3 ED lenses, 1 UHR lens)
Aperture type	9 diaphragm blades/Circular aperture diaphragm
Maximum aperture	F3.5 (Wide) to F5.6 (Tele)
Minimum aperture value	F22
Angle of view	94° (Wide) to 40° (Tele)
In focus distance	0.15 m (0.49 feet) to ∞ (Wide to focal length 26 mm)/ 0.4 m (1.31 feet) to ∞ (Tele) (from the focus distance reference line)
Maximum image magnification	0.43× (focal length 26 mm)
Optical Image Stabilizer	No
Filter diameter	67 mm
Maximum diameter	∅77.4 mm (3.0")
Overall length	Approx. 87.2 mm (3.4") (from the tip of the lens to the base side of the lens mount)
Mass (Weight)	Approx. 350 g (0.77 lb)
Dust and splash resistant	Yes
Recommended operating temperature	-10 °C to 40 °C (14 °F to 104 °F)
Permissible relative humidity	10 %RH to 80 %RH

Index

Numerics

1 Shot "6K/4K PHOTO"	326
1 Shot RAW+JPG	325
1 Shot Spot Metering	325
1-Area (AF)	110
1-Area AF Moving Speed	356
1-Area+ (AF)	110
225-Area (AF)	107
4K/50p Bit Mode	292, 393
4K/60p Bit Mode	292, 393
6K/4K Burst	134
6K/4K Burst (S/S)	135
6K/4K burst file	139
6K/4K PHOTO	133, 361
6K/4K PHOTO Bulk Saving	144, 410
6K/4K PHOTO Noise Reduction	141, 410
6K/4K Photo Play	328
6K/4K Pre-Burst	135

A

AC adaptor	492, 521
AF	94
AF Area Display	385
AF Assist Light	355
AF Custom Setting (Photo)	98, 355
AF Custom Setting (Video)	258, 367
AF mode	100
AF ON	95, 122
AF/AE Lock	198
AF/AE Lock Hold	373
AF+AE	117
AF+MF	373
AFC	93
AFC Start Point (225-Area)	107, 377
AF-Point Scope	97

AF-Point Scope Setting	376
AFS	93
Anamorphic (4:3)	284, 366
Anamorphic (Video)	182, 359
Anamorphic Desqueeze Display	286, 392, 409
Anamorphic recording	283
Android	419
Animal detection	103
Aperture Bracket	159
Aperture-Priority AE mode	187
Approved Regulations	405
Aspect Ratio	83, 350
Auto Clock Set	400, 441
Auto Exposure Comp.	235, 357
Auto Exposure in P/A/S/M	241, 372
Auto focus	94
Auto LVF/Monitor Off	44, 396
Auto Review	382
Auto Transfer	400, 437
Auto White Balance	203
Automatic scene detection	78
Available recording time	525
Available recording time (for video recording)	526

B

Backlight compensation	78
Battery	34, 37, 520
Battery Grip	490
Battery Use Priority	401, 490
Beep	399
Blinking Highlights	389
Bluetooth	400, 420
Boost I.S. (Video)	182, 359
Bracketing	156, 358

Bulb.....	194, 433
Burst rate	130
Burst Shot	129
Burst Shot 1 Setting	129, 133, 359
Burst Shot 2 Setting	129, 133, 359

C

Calendar screen.....	309
Card	24, 46, 88, 521
Card Access Light.....	46
Card Format.....	48, 395
Card Slot Change	302, 328
Center Marker	393
Center-weighted metering.....	184
Charge	34
Cleaning.....	517
Clock Set.....	54, 404
Cloud Limit	466
Cloud sync service	458
Color Space	371, 479
Color Tone	211
Communication Light	239, 358
Compression rate.....	86, 350
Condensation.....	20
Constant Preview	383
Continuous AF	256, 367
Contrast	211
Control dial.....	62
Control panel.....	67, 71, 497
Copy.....	413
Copyright Information.....	395
Creating a picture from a video.....	305
Creative Video Combined Set.	247, 372
Creative Video mode	244
Custom (AF).....	113
Custom menu.....	370

Custom mode	337
Custom Mode Settings	338, 403

D

DC Coupler.....	492
DCF standard	302
Delete	311
Delete All Images	414
Delete Confirmation.....	414
Delete Location Data.....	466
Delete Single	311
Destination Card Slot	88, 327
Device Name.....	468
Dial Operation Switch Setup	330, 381
Dial Setting.....	380
Diffraction Compensation	354
Diopter adjustment	65
Double Card Slot Function	88, 395
Drive mode.....	128
Dust reduction function.....	517

E

Electronic front curtain.....	175, 360
Electronic shutter.....	175, 360
Enlarged display.....	306
Entering characters	415
E-Stabilization (Video).....	179, 359
Exposure Bracket.....	159
Exposure compensation.....	196
Exposure Compensation Display Setting	379
Exposure Compensation Reset.....	372
Exposure Meter	388
Exposure Mode	245, 364
Exposure Offset Adjustment.....	371
Extended ISO	371
Extended Tele Conversion.....	125, 360

-
- External flash 227
- External microphone 293
- External monitor/external recorder 289
- Eye cup 518
- Eye Sensor 66, 398
- Eye Sensor AF 376
- F**
-
- Face/Eye/Body/Animal Detect. ... 79, 102
- File number 89, 479, 499, 501
- File Number Reset 91, 395
- Filter Effect 215, 355
- Filter Settings 215, 355
- Firing Mode 232, 357
- Firmware update 19, 405
- Firmware Version 405
- Flash 227
- Flash Adjust. 233, 357
- Flash Mode 229, 357
- Flash Synchro 234, 357
- Flicker Decrease (Video) 365
- Fn button 321, 322
- Fn Button Set 323, 378
- Focal Length 388
- Focal Length Set 183, 359
- Focus 94, 256
- Focus Area Set 325
- Focus Bracket 160
- Focus mode 93
- Focus Peaking 356
- Focus Ring Control 394
- Focus Ring Lock 374
- Focus Stacking 171
- Focus Switching for Vert/Hor ... 119, 373
- Focus/Shutter Priority 373
- Folder number 89, 91, 479, 499, 501
- Folder/File Settings 89, 395
- Forced Flash Off 229
- Frame Marker 268, 385
- Framing Outline 391
- Front dial 61
- G**
-
- Gamma setting (Photo Style) 208, 350
- Group image 310
- H**
-
- Half-Press Shutter 376
- HDAVI Control™ 476
- HDMI micro cable 289, 473, 475, 477
- HDMI Mode (Playback) 401
- HDMI output 289
- HDMI Rec Output 292, 393
- HDMI Recording Control 292, 393
- HDMI socket 289, 473
- Headphone socket 298
- Headphone Volume 299, 369, 399
- High Resolution Mode 221, 351
- Highlight 211
- Highlight-weighted metering 184
- Histogram 384
- HLG Photo 225, 350
- HLG video 280
- HLG View Assist 282, 392
- HLG View Assist (Monitor) 409
- Hot shoe cover 227
- Hue 211
- I**
-
- i.Dynamic Range 353
- I.S. Status Scope 390
- Image Area of Video 249, 366
- Image Quality 211
- Image Stabilizer 177, 359

-
- Info Display (During HDMI Output) 292, 393
- Intelligent Auto mode 77
- iOS 419
- ISO Displayed Setting 379
- ISO Increments 370
- ISO sensitivity 199
- ISO Sensitivity (photo) 352
- ISO Sensitivity (video) 262, 364
- J**
-
- Joystick 63
- Joystick Setting 381
- K**
-
- Knee 260
- L**
-
- Language 405
- Lens 23, 49, 519
- Lens Fn Button Setting 394
- Lens Focus Resume 394
- Lens hood 51
- Level Gauge 391
- Level Gauge Adjustment 398
- Live Cropping 272, 369
- Live View Boost 386
- Live View Composite 162, 361
- Load Custom Mode 340, 403
- Location Logging 400, 439
- Log recording 276
- Long Exposure NR 351
- Looped Focus Frame 377
- Low illumination AF 95
- Luminance Level 259, 366
- Luminance Spot Meter 266, 391
- LUMIX CLUB 469
- LUMIX Sync 419
- LUMIX Tether 484
- LUT View Assist 278, 392
- LUT View Assist (Monitor) 408
- LVF Frame Rate 397
- LVF Luminance 398
- LVF/Monitor Display Set 387
- LVF/Monitor Display Style 327
- LVF/Monitor Switch 398
- M**
-
- Magnify from AF Point 408
- Manual Exposure mode 192
- Manual Flash Adjust 232, 238, 357
- Manual focus 120
- Mechanical shutter 175, 360
- Metering Mode 184, 350
- MF 120
- MF Assist 374
- MF Assist Display 374
- MF Guide 374
- Mic Socket 293, 368
- Minimum Shutter Speed 352
- Monitor 53, 493
- Monitor Backlight 398
- Monitor Frame Rate 396
- Monitor Settings 397
- Monochrome Live View 392
- MOV 249, 366
- MP4 249, 366
- Multi-metering 184
- Multiple Exposure 362
- My Menu 341
- N**
-
- Network Address 469
- Night Mode 387
- Noise Reduction 212

- Number of pictures that can be taken 525
- Number of pictures that can be taken continuously 131
- Number of prints 488
- Number of still images that can be taken 528
- O**
-
- One Push AE 325
- Online Manual 405
- Operation Lock 326
- Operation Lock Setup 378
- Optical zoom 124
- P**
-
- Page Layout 488
- Paper Size 488
- PC connection 451, 468, 478, 484
- Photo Grid Line 385
- Photo menu 350
- Photo Style 208, 350
- Photo Style Settings 370
- Photo/video preview 388
- PHOTOfunSTUDIO 481
- Photos/videos remaining 389
- PictBridge 486
- Picture Quality 86, 350
- Picture Size 85, 350
- Picture Sort 408
- Pinpoint (AF) 111
- Pinpoint AF Setting 375
- Pixel Refresh 404
- Play back picture 300
- Play back video 303
- Playback 300
- Playback menu 406
- Playback Mode 407
- Post-Focus 166, 362
- Post-Recording Refinement 140
- Power Save LVF Shooting 44, 396
- Power Save Mode 44, 396
- Power supply 41
- Pre-Burst Recording 137, 361
- Preview 195
- Preview Aperture Effect 326, 394
- Print 454, 486
- Print with Date 488
- Program AE mode 185
- Program Shift 186
- Protect 411
- Q**
-
- Q.Menu Settings 332, 377
- Quick AF 376
- Quick menu 69, 332
- R**
-
- Rating 411
- RAW 86
- RAW Processing 312, 410
- Rear dial 61
- Rec Quality 250, 366
- Rec. File Format 249, 366
- Rec/Playback Switch 326, 328
- Recording distance reference 123
- Recording mode 60
- Recording videos 240
- Recording with Time Lapse Shot 145
- Red REC Frame Indicator 393
- Red-Eye Removal 231, 357
- Reduce Rolling Shutter 140
- Register to Favorite (Wi-Fi connection) 464
- Remote shooting 431

-
- Remote Wakeup 400, 440
 - Reset..... 76, 403
 - Resize412
 - Restore to default..... 327, 328
 - Returning from Sleep Mode 400, 434
 - Rotate412
 - Rotate Display.....407
- S**
-
- Saturation.....211
 - Save to Custom Mode 337, 403
 - Save/Restore Camera Setting
..... 343, 403
 - SD Speed Class.....25
 - Self-timer..... 154, 361
 - Send Image (Smartphone)
..... 400, 447, 449
 - Sending file format466
 - Sending size466
 - Sensor Cleaning404
 - Setup menu.....395
 - Shadow211
 - Sharpness.....212
 - Sheer Overlay390
 - Shoulder strap.....33
 - Show/Hide AF Mode375
 - Show/Hide Monitor Layout391
 - Shutter AF.....376
 - Shutter Delay360
 - Shutter Remote Control 433, 491
 - Shutter Type 175, 360
 - Shutter-Priority AE mode 190
 - Silent Mode 174, 358
 - Simultaneous Record w/o Filter
..... 220, 355
 - Sleep Mode..... 44, 396
 - Sleep Mode (Wi-Fi)..... 44, 396
 - Slide show 407
 - Slow & Quick mode 244, 269
 - Slow & Quick Setting..... 270, 366
 - Sound Output 298, 368
 - Sound Output (HDMI)..... 292, 393
 - Sound Rec Level Adj..... 263, 368
 - Sound Rec Level Disp..... 263, 368
 - Sound Rec Level Limiter 263, 368
 - Special Mic..... 294, 368
 - Spot metering 184
 - Starlight AF..... 95
 - Stereo Shotgun Microphone..... 293, 368
 - Stop Motion Animation 149, 360
 - Stop Motion Video 410
 - Storage (recorder)..... 483
 - Switch NTSC/PAL 248, 366
- T**
-
- Tethered Recording..... 484
 - Thumbnail screen..... 308
 - Time Code..... 254, 366
 - Time Lapse Shot 145, 360
 - Time Lapse Video 410
 - Time Zone 404
 - Touch AE..... 81
 - Touch AF..... 80, 117, 377
 - Touch Pad AF 118, 377
 - Touch screen..... 64
 - Touch Settings 377
 - Touch Shutter..... 80
 - Touch Tab 377
 - Touch Zoom 126
 - Tracking (AF)..... 79, 105
 - Tripod 523
 - Tripod Grip 492
 - TTL..... 232, 233
 - TV Connection..... 401

-
- TV playback 475
- U**
-
- UHS Speed Class 25
- USB 400
- USB connection cable
..... 35, 39, 474, 479, 480, 483, 485, 486
- USB Mode 400
- USB port 39, 474
- USB Power Supply 400
- V**
-
- Vertical orientation detection function
..... 58
- Video Divide 318, 412
- Video menu 364
- Video rec. button 240
- Video Rec. Button (Remote) 381, 491
- Video recording time 529
- Video Speed Class 25
- VIERA Link (CEC) 402, 476
- Viewfinder 65, 397, 493
- Vignetting Compensation 354
- V-Log 276
- V-Log View Assist 278, 392
- W**
-
- Waveform Monitor 264, 393
- WB/ISO/Exposure Button 379
- Web service 456
- White balance 202
- White balance adjustment 206
- White Balance Bracket 161
- White Balance Bracket
(Color Temperature) 161
- Wi-Fi 399, 416
- Wi-Fi Function 399, 416
- Wi-Fi Function Lock 469
- Wi-Fi network settings 400
- Wi-Fi Password 468
- Wi-Fi Setup menu 399, 468
- Wind Cut 295, 368
- Wind Noise Canceller 263, 368
- Wireless 237, 357
- Wireless Channel 237, 357
- Wireless Connection Light 402, 416
- Wireless flash 236
- Wireless FP 239, 358
- Wireless printing 454
- Wireless Setup 238, 358
- WPS 460, 463
- X**
-
- XLR Mic Adaptor Setting 296, 368
- XLR Microphone Adaptor 296
- Z**
-
- Zebra Pattern 267, 393
- Zone (AF) 108
- Zoom 124

Trademarks and Licenses



- L-Mount is a trademark or registered trademark of Leica Camera AG.
- SDXC Logo is a trademark of SD-3C, LLC.
- The terms HDMI and HDMI High-Definition Multimedia Interface, and the HDMI Logo are trademarks or registered trademarks of HDMI Licensing Administrator, Inc. in the United States and other countries.
- USB Type-C™ and USB-C™ are trademarks of USB Implementers Forum.
- The SuperSpeed USB Trident Logo is a registered trademark of USB Implementers Forum, Inc.
- QuickTime and the QuickTime logo are trademarks or registered trademarks of Apple Inc., used under license therefrom.
- HDAVI Control™ is a trademark of Panasonic Corporation.
- Adobe is a trademark or registered trademark of Adobe Systems Incorporated in the United States and/or other countries.
- Pentium is a trademark of Intel Corporation in the U.S. and/or other countries.
- Windows is a registered trademark or trademark of Microsoft Corporation in the United States and/or other countries.



- Final Cut Pro, Mac, OS X and macOS are trademarks of Apple Inc., registered in the U.S. and other countries.
- App Store is a service mark of Apple Inc.
- Google, Android and Google Play are trademarks of Google LLC.
- The Bluetooth® word mark and logos are registered trademarks owned by Bluetooth SIG, Inc. and any use of such marks by Panasonic Corporation is under license. Other trademarks and trade names are those of their respective owners.
- The Wi-Fi CERTIFIED™ Logo is a certification mark of Wi-Fi Alliance®.
- The Wi-Fi Protected Setup™ Logo is a certification mark of Wi-Fi Alliance®.
- "Wi-Fi®" is a registered trademarks of Wi-Fi Alliance®.
- "Wi-Fi Protected Setup™", "WPA™", and "WPA2™" are trademarks of Wi-Fi Alliance®.
- This product uses "DynaFont" from DynaComware Corporation. DynaFont is a registered trademark of DynaComware Taiwan Inc.
- QR Code is a registered trademark of DENSO WAVE INCORPORATED.
- Other names, company names, product names mentioned in this document are trademarks or registered trademarks of the companies concerned.

This product is licensed under the AVC Patent Portfolio License for the personal use of a consumer or other uses in which it does not receive remuneration to (i) encode video in compliance with the AVC Standard ("AVC Video") and/or (ii) decode AVC Video that was encoded by a consumer engaged in a personal activity and/or was obtained from a video provider licensed to provide AVC Video. No license is granted or shall be implied for any other use. Additional information may be obtained from MPEG LA, L.L.C.

See <http://www.mpegla.com>

Firmware Update

LUMIX

S5

❖ Firmware Has Been Updated

A firmware update has been made available to improve camera capabilities and to add functionality.

The subsequent sections describe functions that have been added or modified. Also refer to the “Owner’s Manual”.

- To check the firmware version of the camera, select [Firmware Version] in the [Setup] ([Others]) menu.
- For the latest information on the firmware or to download/update the firmware, visit the following support site:

<https://panasonic.jp/support/global/cs/dsc/>

(English only)

[→](#) Click here to move to the cover page of the “Owner’s Manual”.

Contents

Before Use	F-3
About Applications/Software	F-3
Firmware Ver. 2.0	F-4
Additions/Changes to AF Functions	F-4
Automatic Detection AF Has Been Added to [1-Area+]/[1-Area].....	F-4
Support for the [AF+MF] Function During Recording of Video	F-5
Additions/Changes to Video Functions.....	F-6
C4K Recording Qualities Have Been Added	F-6
Support for Vector Scope Display	F-9
[Master Pedestal Level] Has Been Added.....	F-10
[SS/Gain Operation] Has Been Added	F-11
Support for Output of RAW Video Data	F-12
Outputting RAW Video Data via HDMI.....	F-13
Notes When Outputting RAW Video Data.....	F-17
Additions/Changes to Other Functions	F-18
[L.ClassicNeo] and [L.Monochrome S] Have Been Added to [Photo Style]	F-18
[L.ClassicNeo] and [L.Monochrome S] Have Been Added to the [Photo Style] of [RAW Processing].....	F-20
[Horizontal Image Flip(Monitor)] and [Vertical Image Flip(Monitor)] Have Been Added to [LVF/Monitor Disp. Set]	F-21
Fn Buttons/Quick Menu	F-22
Added Menus.....	F-23
Firmware Ver. 2.2	F-25
[Vertical Position Info (Video)] Has Been Added	F-25
Support for the [Power Save Mode] When Using an AC Adaptor	F-25
Added Menus.....	F-26

Before Use

About Applications/Software

When you have updated the firmware for the camera, use the latest version of the application for your smartphone or the software for your PC.

“LUMIX Sync”

- Install or update the application on your smartphone.
-

“PHOTOfunSTUDIO 10.1 PE”

- Check the following site and then download and install the software:

<If already using>

https://panasonic.jp/support/global/cs/soft/download/d_pfs101pe_up.html

(English only)

<If installing for the first time>

https://panasonic.jp/support/global/cs/soft/download/d_pfs101pe.html

(English only)

“LUMIX Tether”

- Check the following site and then download and install the software:

https://panasonic.jp/support/global/cs/soft/download/d_lumixtether.html

(English only)

Firmware Ver. 2.0

Additions/Changes to AF Functions

Automatic Detection AF Has Been Added to

[1-Area+]/ [1-Area]

iA P A S M S&Q



Automatic detection is now available in the [1-Area+]/[1-Area] AF modes. When a part of a human or animal enters the [1-Area+]/[1-Area] AF area, the automatic detection AF area is indicated in yellow.

Eye detection works when a person's face is inside the AF area.

The item names have been changed from [Face/Eye/Body Detection] to [Human Detect AF], and from [Face/Eye/Body/Animal Detect.] to [Human/Animal Detect AF] accordingly.

❖ Switching of Automatic Detection

- 1 Press [] to display the AF mode selection screen.
- 2 Select [] or [] and then press **▲**.
 - Each press of **▲** switches automatic detection.
 - The automatic detection settings of [1-Area+] and [1-Area] are linked.

Automatic detection:

OFF



[Human Detect AF]:

ON



[Human/Animal Detect AF]: ON



- Only 1 human or animal can be automatically detected in the AF area.
- You cannot change the person, animal or eye being focused on during automatic detection.

Support for the [AF+MF] Function During Recording of Video



During video recording, the MF mode is engaged when you rotate the focus ring, and the AF mode is engaged when you stop rotating the focus ring.

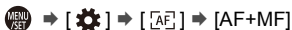

- When [Continuous AF] is set to [MODE2], the focus can be adjusted manually even during recording standby.

Additions/Changes to Video Functions

iA P A S M  S&Q



C4K Recording Qualities Have Been Added

C4K recording qualities are now supported.

 →  →  → Select [Rec Quality]

[Rec. File Format]: [MOV]

- Audio format: LPCM (2ch)

(A) Recording frame rate

(B) Bit rate (Mbps)

(C) Video compression format (**AVC**: H.264/MPEG-4 AVC)

[Switch NTSC/PAL]: [NTSC]

[Rec Quality]	Resolution	YUV/bit	(A)	(B)	(C)
[C4K/60p/420/8-L]*	4096×2160	4:2:0/8 bit	59.94p	150	AVC
[C4K/30p/422/10-L]*	4096×2160	4:2:2/10 bit	29.97p	150	AVC
[C4K/30p/420/8-L]	4096×2160	4:2:0/8 bit	29.97p	100	AVC
[C4K/24p/422/10-L]*	4096×2160	4:2:2/10 bit	23.98p	150	AVC
[C4K/24p/420/8-L]	4096×2160	4:2:0/8 bit	23.98p	100	AVC

[Switch NTSC/PAL]: [PAL]

[Rec Quality]	Resolution	YUV/bit	(A)	(B)	(C)
[C4K/50p/420/8-L]*	4096×2160	4:2:0/8 bit	50.00p	150	AVC
[C4K/25p/422/10-L]*	4096×2160	4:2:2/10 bit	25.00p	150	AVC
[C4K/25p/420/8-L]	4096×2160	4:2:0/8 bit	25.00p	100	AVC

* Recording stops when the continuous recording time exceeds 30 minutes.

- In this document, videos are indicated as follows according to their resolution:
 - C4K (4096×2160) video: **C4K video**



- All videos will be recorded using Long GOP to compress the images.
- When recording to an SD card, use a card rated at UHS Speed Class 3 or higher.
- It is not possible to set to [FULL] in the following case:
 - When [Rec Quality] is set to [C4K/60p/420/8-L] or [C4K/50p/420/8-L]
- Video cannot be recorded to cards when [Rec Quality] is set to [C4K/60p/420/8-L] or [C4K/50p/420/8-L] and 10-bit video is being output via HDMI.
- When [Rec Quality] is set to [C4K], [AF-Point Scope] is not available.
- [Resize] cannot be used on pictures created from C4K video.

❖ Available Recording Time for the Battery (When Using the Monitor)

Listed below are the time lengths available for recording that can be taken when the supplied battery is being used.

- Using a Panasonic SDHC memory card.
- Using the interchangeable lens (S-R2060).
- The values listed are approximate.
- Actual available recording time is the time available for recording when repeating actions such as turning the camera on and off, starting/stopping recording, etc.

[MOV] (Recording with the recording quality set to [C4K/60p/420/8-L])

Continuous available recording time (minutes)	110
Actual available recording time (minutes)	55

❖ Video Recording Time for Cards

Listed below are the time lengths of videos that can be recorded on a card.

- Video recording time is the total time of all the videos which have been recorded.
- The values listed are approximate.

- **[Rec. File Format]: [MOV]**



- “h” is an abbreviation for hour, “m” for minute and “s” for second.

[Switch NTSC/PAL]: [NTSC]			
[Rec Quality]	Card capacity		
	32 GB	64 GB	128 GB
[C4K/60p/420/8-L]/[C4K/30p/422/10-L]/ [C4K/24p/422/10-L]	27m00s	56m00s	1h50m
[C4K/30p/420/8-L]/[C4K/24p/420/8-L]	41m00s	1h25m	2h45m

[Switch NTSC/PAL]: [PAL]			
[Rec Quality]	Card capacity		
	32 GB	64 GB	128 GB
[C4K/50p/420/8-L]/[C4K/25p/422/10-L]	27m00s	56m00s	1h50m
[C4K/25p/420/8-L]	41m00s	1h25m	2h45m

❖ Outputting C4K Video to TVs

[C4K/60p] and [C4K/30p] have been added to [HDMI Mode (Playback)] in [TV Connection].

 ⇒  ⇒  ⇒ [TV Connection] ⇒ [HDMI Mode (Playback)] ⇒
 Select [C4K/60p]/[C4K/30p]

Support for Vector Scope Display

iA P A S M  S&Q



It is now possible to display the vector scope in the recording screen. Accordingly, [Waveform Monitor] has been changed to [WFM/Vector Scope].

 →  →  → Select [WFM/Vector Scope]

[WAVE]	Displays a waveform.
[VECTOR]	Displays the vector scope.
[OFF]	—

❖ Screen Displays (Vector Scope)

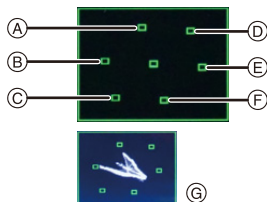

- Ⓐ R (Red)
- Ⓑ YL (Yellow)
- Ⓒ G (Green)
- Ⓓ MG (Magenta)
- Ⓔ B (Blue)
- Ⓕ CY (Cyan)
- Ⓖ Display example



- The vector scope is not output through HDMI.
- When [WFM/Vector Scope] is set, [Histogram] does not work.

[Master Pedestal Level] Has Been Added

iA P A S M  S&Q





You can adjust the black level, which serves as the reference for images.

1 Set the mode dial to [] or [S&Q].

2 Select [Master Pedestal Level].

-  → [] → [] → [Master Pedestal Level]

3 Adjust master pedestal.

- Rotate ,  or .
- Set in the range between -15 and $+15$.

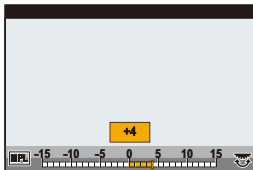

- [Master Pedestal Level] is not available when using the following function:
 - [V-Log] ([Photo Style])

[SS/Gain Operation] Has Been Added

iA P A S M  S&Q



It is now possible to set the shutter speed by angle and the gain (sensitivity) by dB units.

 ⇒ [] ⇒ [] ⇒ Select [SS/Gain Operation]

[SEC/ISO]	Displays the shutter speed in seconds and the gain in ISO.
[ANGLE/ISO]	Displays the shutter speed in degrees and the gain in ISO. <ul style="list-style-type: none"> • The angle can be set in a range between 11° and 358°.
[SEC/dB]	Displays the shutter speed in seconds and the gain in dB. <ul style="list-style-type: none"> • 0 dB is equivalent to [ISO100].

- When [SS/Gain Operation] is set to [SEC/dB], menu names change as shown below:
 - [ISO Sensitivity (video)] ⇒ [Gain Setting]
 - [ISO Auto Lower Limit Setting] ⇒ [Auto Gain Lower Limit Setting]
 - [ISO Auto Upper Limit Setting] ⇒ [Auto Gain Upper Limit Setting]
 - [Extended ISO] ⇒ [Extended Gain Setting]
 - [ISO Displayed Setting] ⇒ [Gain Displayed Setting]
- When [SS/Gain Operation] is set to [SEC/dB], the icon in the Touch Tab changes from [ISO] to [GAIN].

Support for Output of RAW Video Data

iA P A S M  S&Q

12-bit RAW Video Data with a maximum resolution of 5.9K can now be output via HDMI to a compatible external recorder.

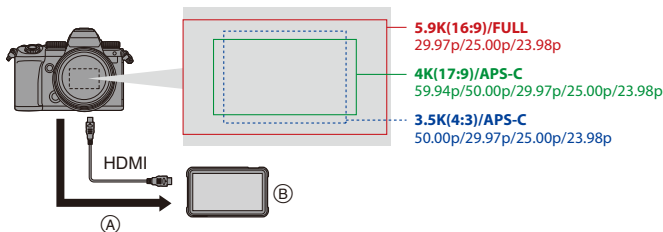

- (A) RAW Video
- (B) External recorder

- Recording of the RAW Video Data of this camera has been confirmed on the following external recorder. (As of November 2020)
 - ATOMOS Ninja V 4K HDR Monitor-Recorder (AtomOS 10.55 or higher)
 - For details, please contact ATOMOS.
- This does not guarantee all of the capabilities that the compatible external recorder may have.
- You will need compatible software to edit the RAW Video Data recorded with the external recorder. To change the coloring according to V-Log/V-Gamut when editing, download a LUT (Look-Up Table) from the support site below and load it into the software.
- Visit the following site to download LUT data or view the latest support information:
<https://panasonic.jp/support/global/cs/dsc/>
 (English only)

 • Video cannot be recorded to cards while RAW Video Data is being output via HDMI.

Outputting RAW Video Data via HDMI

[HDMI RAW Data Output] has been added to the [Video] menu. The image quality for the output images is set in either [Rec Quality] or [Anamorphic(4:3)].

Getting started:

- 1 Turn off the camera and the external recorder.
- 2 Connect the camera and the external recorder with a commercially available HDMI micro cable.
 - Use a “High Speed HDMI micro cable” with the HDMI logo. Cables that do not comply with the HDMI standards will not work. “High Speed HDMI micro cable” (Type D–Type A plug, up to 2 m (6.6 feet) long)
- 3 Turn on the camera and the external recorder.

1 Set the mode dial to [COM].

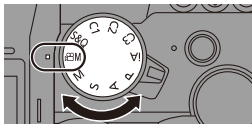

2 Set [HDMI RAW Data Output].

- **MENU/SET** → [CAMERA] → [VIDEO] → [HDMI RAW Data Output] → [ON]
- [HDMI RAW] is displayed on the recording screen.

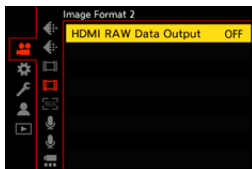

3 Select [Rec Quality].

-  →  →  → [Rec Quality]/[Anamorphic(4:3)]

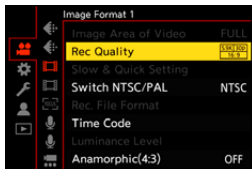

4 Set the HDMI input on the external recorder.

- When the connection is complete, images will be displayed on the screen of the external recorder.



There are differences from normal HDMI output operation.

- [HDMI Rec Output] in the [Custom] ([IN/OUT]) menu.
 - [Info Display] is not available. You cannot output the camera information display to an external recorder connected by HDMI.

❖ [Rec Quality] (When [HDMI RAW Data Output] Is Selected)

[Rec Quality]	[Switch NTSC/ PAL]	[Image Area of Video]	Resolution	Frame rate
[5.9K/30p/16:9]	[NTSC]	[FULL]	5888×3312	29.97p
[5.9K/24p/16:9]		[FULL]	5888×3312	23.98p
[4K/60p/17:9]		[APS-C]	4128×2176	59.94p
[4K/30p/17:9]		[APS-C]	4128×2176	29.97p
[4K/24p/17:9]		[APS-C]	4128×2176	23.98p
[5.9K/25p/16:9]	[PAL]	[FULL]	5888×3312	25.00p
[4K/50p/17:9]		[APS-C]	4128×2176	50.00p
[4K/25p/17:9]		[APS-C]	4128×2176	25.00p

- Bit value: 12-bit
- Audio format: LPCM (2ch)

❖ [Anamorphic(4:3)] (When [HDMI RAW Data Output] Is Selected)

[Rec Quality]	[Switch NTSC/ PAL]	[Image Area of Video]	Resolution	Frame rate
[3.5K/30p/4:3]	[NTSC]	[APS-C]	3536×2656	29.97p
[3.5K/24p/4:3]		[APS-C]	3536×2656	23.98p
[3.5K/50p/4:3]	[PAL]	[APS-C]	3536×2656	50.00p
[3.5K/25p/4:3]		[APS-C]	3536×2656	25.00p

- Bit value: 12-bit
- Audio format: LPCM (2ch)



- [Image Area of Video] is fixed to the area according to the [Rec Quality]/[Anamorphic(4:3)] setting.

❖ **Monitor/Viewfinder Display When Outputting RAW Video Data**

Images equivalent to those recorded when recording with V-Log are displayed on the monitor/viewfinder of the camera for monitoring purposes. [LUT View Assist (Monitor)] with the [Vlog_709] preset applied can be used for the [V-Log View Assist].

- The LUT for the monitor display cannot be changed.
- When you use [LUT View Assist (Monitor)], [709] is displayed on the screen and [RAW] is displayed on the screen as a [LUT View Assist (HDMI)] item.
- [Luminance Spot Meter], and [BASE/RANGE] of [Zebra Pattern] are set at "Stop" units.

(Calculated as "0 Stop"=42 % (IRE))

Notes on displayed images



- The images displayed on the camera do not affect the RAW Video Data that is output.
- The images displayed on the external recorder are images that suit the external recorder specifications. This means that there may be differences between the images displayed on the camera and the images displayed on the external recorder.
- The monitor/viewfinder of the camera shows images with the angle of view of the RAW Video Data. There may be some difference with the angle of view of the data recorded on the external recorder.

❖ [HDMI Time Code Output]/[HDMI Recording Control]



The time code of the camera can be added and output via HDMI to the external recorder.

In addition, recording can be started and stopped on the external recorder by using the video rec. button and shutter button of the camera.

❶ Set [HDMI Time Code Output] to [ON].



-  ⇒  ⇒  ⇒ [Time Code] ⇒ [HDMI Time Code Output] ⇒ [ON]

❷ Set [HDMI Recording Control] to [ON].

-  ⇒  ⇒  ⇒ [HDMI Rec Output] ⇒ [HDMI Recording Control] ⇒ [ON]
- [HDMI Recording Control] can be set when [HDMI Time Code Output] is set to [ON] in [P^{CM}M] mode.

Notes When Outputting RAW Video Data

Operation is as follows when outputting RAW Video Data:

- The lower limit of available ISO sensitivity is [640] (when [Extended ISO] is set: [320]), and the upper limit is [51200].
- [AWB], [AWBc], [AWBw] and [WB] cannot be used for white balance.
- [Photo Style] is fixed to [V-Log], and Image quality cannot be adjusted.
- [] of the AF mode is not available.
- Enlarging the display with MF Assist is not possible.
- The following functions are not available:
 - [Master Pedestal Level]
 - [i.Dynamic Range]
 - [Vignetting Comp.]
 - [Diffraction Compensation]
 - [Filter Settings]
 - [Rec. File Format]
 - [Time Code Display] ([Time Code])
 - [Luminance Level]
 - [E-Stabilization (Video)] ([Image Stabilizer])
 - [Live Cropping]

Additions/Changes to Other Functions

[L.ClassicNeo] and [L.Monochrome S] Have Been Added to [Photo Style]



[L.ClassicNeo] and [L.Monochrome S] have been added to [Photo Style].

→ /[] → [] → Select [Photo Style]

[L.ClassicNeo]	A setting for a film-like effect that has a nostalgic, soft coloring.
[L.Monochrome S]	A setting for a black and white effect with a gentle touch suited to portraits.

• When [Photo Style] is set to [L.Monochrome S], [] operates as [].

❖ [Color Noise] Has Been Added to the [Photo Style] Image Quality Adjustments

iA P A S M  S&Q















Grainy color noise can be added to pictures recorded with [L.ClassicNeo].

Settings Items (Image Quality Adjustment)

	[Color Noise]	[On]/ [Off]	Color can be added with a grainy texture.
--	----------------------	------------------------	---

- The items that you can adjust the image quality for depend on the Photo Style type.

				 ((Saturation))	 ((Color Tone))						
	✓	✓	✓	✓	—	✓	—	✓	✓*	✓	✓
	✓	✓	✓	—	✓	—	✓	✓	—	✓	✓

* Can be set when [Grain Effect] is one of [Low], [Standard], or [High].











- The effects of [Color Noise] cannot be checked on the recording screen.
- [Color Noise] is not available when using the following functions:
 - Video recording/[6K/4K PHOTO]/[Post-Focus]
 - [High Resolution Mode]









[L.ClassicNeo] and [L.Monochrome S] Have Been Added to the [Photo Style] of [RAW Processing]

[L.ClassicNeo] and [L.Monochrome S] have been added to the [Photo Style] of [RAW Processing].

Furthermore, when [L.ClassicNeo] has been set, the [Color Noise] setting item can be selected.

- The items that can be adjusted depend on the selected [Photo Style].

	WB							 ([Saturation])
 L.CLASS N	✓	✓	✓	✓	✓	✓	✓	✓
 L.MONOS	✓	✓	✓	✓	✓	✓	✓	—

	 ([Color Tone])					NR	
 L.CLASS N	—	✓	—	✓	✓*	✓	✓
 L.MONOS	✓	—	✓	✓	—	✓	✓

* Can be set when [Grain Effect] is one of [Low], [Standard], or [High].

[Horizontal Image Flip(Monitor)] and [Vertical Image Flip(Monitor)] Have Been Added to [LVF/Monitor Disp. Set]

It is now possible to set whether the screen flips or not depending on the facing or angle of the monitor during recording.

 ⇒  ⇒  ⇒ [LVF/Monitor Disp. Set] ⇒ Select [Horizontal Image Flip(Monitor)]/[Vertical Image Flip(Monitor)]

[Horizontal Image Flip(Monitor)]	[AUTO]	The screen automatically flips horizontally according to the angle to which the monitor is opened or closed.
	[ON]	The screen is flipped horizontally all the time.
	[OFF]	Screen is not flipped.
[Vertical Image Flip(Monitor)]	[AUTO]	The screen automatically flips vertically according to the angle to which the monitor is rotated.
	[ON]	The screen is flipped vertically all the time.
	[OFF]	Screen is not flipped.





- The settings for this function are not reflected in the playback screen.

FN Buttons/Quick Menu



Usage of the following functions is enabled.



FN buttons

 ⇒ [] ⇒ [] ⇒ [Fn Button Set]

[Setting in REC mode]	[1] tab	 [Image Quality]	[Photo Style] – [L.ClassicNeo] – [L.Monochrome S]
	[2] tab	 [Monitor / Display]	– [WFM/Vector Scope]

Quick menu

 ⇒ [] ⇒ [] ⇒ [Q.MENU Settings] ⇒ [Item Customize (Photo)]/
[Item Customize (Video)]

[1] tab	 [Image Quality]	[Photo Style] – [Color Noise]
[2] tab	 [Monitor / Display]	– [WFM/Vector Scope]

Added Menu











Specifications information for the menu added by the firmware update.

❖ List of Default Settings/Custom Saving/Settings Available for Copying





: Using [Reset], the function to return to default settings

: Using [Save to Custom Mode], the function to save settings details in the Custom mode

: Using [Save/Restore Camera Setting], the function to copy settings details

Menu		Default setting			
 [Video]:  [Image Quality]					
[Master Pedestal Level]		[0]	✓	✓	✓
[SS/Gain Operation]		[SEC/ISO]	✓	✓	✓
 [Video]:  [Image Format]					
[HDMI RAW Data Output]		[OFF]	✓	✓	✓
 [Custom]:  [Monitor / Display (Photo)]					
[LVF/Monitor Disp. Set]	[Horizontal Image Flip(Monitor)]	[AUTO]	✓	✓	✓
	[Vertical Image Flip(Monitor)]	[AUTO]	✓	✓	✓
 [Custom]:  [Monitor / Display (Video)]					
[WFM/Vector Scope]		[OFF]	✓	✓	✓

❖ List of Functions That Can Be Set in Each Recording Mode



Menu	iA	P	A	S	M		S&Q
 [Video]:  [Image Quality]							
[Master Pedestal Level]						✓	✓
[SS/Gain Operation]						✓	✓
 [Video]:  [Image Format]							
[HDMI RAW Data Output]						✓	

- Ninja V / ATOMOS are registered trademarks of ATOMOS Limited.

Firmware Ver. 2.2

[Vertical Position Info (Video)] Has Been Added

You can now set on the menu, whether or not to record the camera's vertical orientation information during video recording.

 ⇒ [] ⇒ [] ⇒ Select [Vertical Position Info (Video)]

[ON]	Records vertical orientation information. Videos recorded with the camera held vertically will be automatically played vertically on the PC or smartphone etc. during playback.
[OFF]	Does not record vertical orientation information.

Support for the [Power Save Mode] When Using an AC Adaptor

When using an AC adaptor (DMW-AC10: optional), it is now possible to set the [Power Save Mode].

Added Menu





Specifications information for the menu added by the firmware update.

❖ List of Default Settings/Custom Saving/Settings Available for Copying

: Using [Reset], the function to return to default settings

: Using [Save to Custom Mode], the function to save settings details in the Custom mode

: Using [Save/Restore Camera Setting], the function to copy settings details

Menu	Default settings			
 [Custom]:  [Lens / Others]				
[Vertical Position Info (Video)]	[ON]	✓	✓	✓