



LUMIX

Panasonic®

Basic Owner's Manual
Digital Camera

Model No. **DC-ZS200D**

Please read these instructions carefully before using this product, and save this manual for future use.

More detailed owner's manual is available in "Owner's Manual for advanced features (PDF format)". To read it, download it from the website. (→68)

U.S. customers only

Register online at <http://shop.panasonic.com/support/register> to receive these benefits:

- Safety Notification
- Owner Verification
- Efficient Warranty Service
- Special Offers and Promotions from Panasonic



If you have any questions, visit:

USA : <http://shop.panasonic.com/support>

Canada : www.panasonic.ca/english/support



DVQX2280ZA
M0822KZ0

**Dear Customer,
Thank you for choosing Panasonic!**

You have purchased one of the most sophisticated and reliable products on the market today. Used properly, we're sure it will bring you and your family years of enjoyment. Please take time to fill in the information below. The serial number is on the tag located on the underside of your camera. Be sure to **retain this manual** as your convenient camera information source.

Date of Purchase	Dealer Phone No.
Dealer Purchased From	Model No.
Dealer Address	Serial No.

Please note that the actual controls and components, menu items, etc. of your Digital Camera may look somewhat different from those shown in the illustrations in this Owner's Manual.

Carefully observe copyright laws.

- Recording of pre-recorded tapes or discs or other published or broadcast material for purposes other than your own private use may infringe copyright laws. Even for the purpose of private use, recording of certain material may be restricted.

For the U.S.A. and Canada only



A lithium ion battery that is recyclable powers the product you have purchased. Please call 1-800-8-BATTERY for information on how to recycle this battery.

Information for Your Safety

WARNING:

To reduce the risk of fire, electric shock or product damage,

- Do not expose this unit to rain, moisture, dripping or splashing.
- Use the recommended accessories.
- Do not remove covers.
- Do not repair this unit by yourself. Refer servicing to qualified service personnel.

The socket outlet shall be installed near the equipment and shall be easily accessible.

■ Product identification marking

Product	Location
Digital camera	Bottom

THE FOLLOWING APPLIES ONLY IN THE U.S.A.

Certification and Compliance

See Camera for the certification and compliance mark specific to that device.

- 1 Select [Wi-Fi] in the [Setup] menu**
- 2 Select [Wi-Fi Setup] in the [Wi-Fi]**
- 3 Press ▲ ▼ to select [Approved Regulations], and press [MENU/SET]**

Contains FCC ID : VPYLB1JS955

This transmitter must not be co-located or operated in conjunction with any other antenna or transmitter.

This equipment complies with FCC radiation exposure limits set forth for an uncontrolled environment and meets the FCC radio frequency (RF) Exposure Guidelines as this equipment has very low levels of RF energy.

THE FOLLOWING APPLIES ONLY IN THE U.S.A.

FCC Note:

This equipment has been tested and found to comply with the limits for a Class B digital device, pursuant to Part 15 of the FCC Rules. These limits are designed to provide reasonable protection against harmful interference in a residential installation. This equipment generates, uses, and can radiate radio frequency energy and, if not installed and used in accordance with the instructions, may cause harmful interference to radio communications. However, there is no guarantee that interference will not occur in a particular installation. If this equipment does cause harmful interference to radio or television reception, which can be determined by turning the equipment off and on, the user is encouraged to try to correct the interference by one or more of the following measures:

- Reorient or relocate the receiving antenna.
- Increase the separation between the equipment and receiver.
- Connect the equipment into an outlet on a circuit different from that to which the receiver is connected.
- Consult the dealer or an experienced radio/TV technician for help.

FCC Caution:

- Any unauthorized changes or modifications to this equipment would void the user's authority to operate this device.
- To assure continued compliance, follow the attached installation instructions and use only shielded interface cables with ferrite core when connecting to computer or peripheral devices.

This device complies with Part 15 of the FCC Rules. Operation is subject to the following two conditions: (1) This device may not cause harmful interference, and (2) this device must accept any interference received, including interference that may cause undesired operation.

Supplier's Declaration of Conformity

Trade Name: Panasonic

Model No.:DC-ZS200D

Responsible Party: Panasonic Corporation of North America
Two Riverfront Plaza, Newark, NJ 07102-5490

Support Contact: <http://shop.panasonic.com/support>

THE FOLLOWING APPLIES ONLY IN CANADA.

Certification and Compliance

See Camera for the certification and compliance mark specific to that device.

- 1 Select **[Wi-Fi]** in the **[Setup]** menu
- 2 Select **[Wi-Fi Setup]** in the **[Wi-Fi]**
- 3 Press **▲ ▼** to select **[Approved Regulations]**, and press **[MENU/SET]**

CAN ICES-003(B) / NMB-003(B)

Contains IC : 772C-LB1JS955

This device contains licence-exempt transmitter(s)/receiver(s) that comply with Innovation, Science and Economic Development Canada's licence-exempt RSS(s). Operation is subject to the following two conditions:

- (1) This device may not cause interference.
- (2) This device must accept any interference, including interference that may cause undesired operation of the device.

The available scientific evidence does not show that any health problems are associated with using low power wireless devices. There is no proof, however, that these low power wireless devices are absolutely safe. Low power Wireless devices emit low levels of radio frequency energy (RF) in the microwave range while being used. Whereas high levels of RF can produce health effects (by heating tissue), exposure of low-level RF that does not produce heating effects causes no known adverse health effects. Many studies of low-level RF exposures have not found any biological effects. Some studies have suggested that some biological effects might occur, but such findings have not been confirmed by additional research. DC-ZS200D (HMN is 1JS2204) has been tested and found to comply with ISED radiation exposure limits set forth for an uncontrolled environment and meets RSS-102 of the ISED radio frequency (RF) Exposure rules.

■ About the battery pack

CAUTION

Battery pack (Lithium ion battery pack)

- Use the specified unit to recharge the battery pack.
- Do not use the battery pack with equipment other than the specified unit.
- Do not get dirt, sand, liquids, or other foreign matter on the terminals.
- Do not touch the plug terminals (+ and -) with metal objects.
- Do not disassemble, remodel, heat or throw into fire.

If any electrolyte should come into contact with your hands or clothes, wash it off thoroughly with water.

If any electrolyte should come into contact with your eyes, never rub the eyes. Rinse eyes thoroughly with water, and then consult a doctor.

CAUTION

- Danger of explosion if battery is incorrectly replaced. Replace only with the type recommended by the manufacturer.
- When disposing of the batteries, please contact your local authorities or dealer and ask for the correct method of disposal.

- Do not heat or expose to flame.
- Do not leave the battery(ies) in a car exposed to direct sunlight for a long period of time with doors and windows closed.
- Do not expose to low air pressure at high altitudes.
- Do not expose to extremely low air pressure, as this may result in explosions or leakage of flammable liquids and gases.

Warning

Risk of fire, explosion and burns. Do not disassemble, heat above 60 °C (140 °F) or incinerate.

■ About the AC adaptor (supplied)

CAUTION!

To reduce the risk of fire, electric shock or product damage,

- Do not install or place this unit in a bookcase, built-in cabinet or in another confined space. Ensure this unit is well ventilated.

AC adaptor

This AC adaptor operates on AC between 110V and 240V.

But

- In the U.S.A. and Canada, the AC adaptor must be connected to a 120V AC power supply only.
- When connecting to an AC supply outside of the U.S.A. or Canada, use a plug adaptor to suit the AC outlet configuration.

■ Cautions for Use

- Do not use any other USB connection cables except the supplied one.
- Use a “High Speed HDMI micro cable” with the HDMI logo.
Cables that do not comply with the HDMI standards will not work.
“High Speed HDMI micro cable” (Type D - Type A plug, up to 2 m (6.6 feet) long)

Keep this unit as far away as possible from electromagnetic equipment (such as microwave ovens, TVs, video games etc.).

- If you use this unit on top of or near a TV, the pictures and/or sound on this unit may be disrupted by electromagnetic wave radiation.
- Do not use this unit near cell phones because doing so may result in noise adversely affecting the pictures and/or sound.
- Recorded data may be damaged, or pictures may be distorted, by strong magnetic fields created by speakers or large motors.
- Electromagnetic wave radiation may adversely affect this unit, disturbing the pictures and/or sound.
- If this unit is adversely affected by electromagnetic equipment and stops functioning properly, turn this unit off and remove the battery or disconnect AC adaptor. Then reinsert the battery or reconnect AC adaptor and turn this unit on.

Do not use this unit near radio transmitters or high-voltage lines.

- If you record near radio transmitters or high-voltage lines, the recorded pictures and/or sound may be adversely affected.

-
- To clean your camera, remove the battery, the DC coupler (DMW-DCC11: optional) or a card, or disconnect the power plug from the outlet, and wipe with a soft, dry cloth.
 - Do not press the monitor with excessive force.
 - Do not press the lens with excessive force.
 - Do not allow camera to come into contact with pesticides or volatile substances (can cause surface damage or coating to peel).
 - Do not keep rubber or plastic products in contact with the camera for a long period of time.
 - Do not use solvents such as benzene, thinner, alcohol, kitchen detergents, etc., to clean the camera, since it may deteriorate the external case or the coating may peel off.
 - Do not leave the camera with the lens facing the sun, as rays of light from the sun may cause it to malfunction.
 - Always use the supplied cords and cables.
 - Do not extend the supplied cord or cable.
 - While the camera is accessing the card (for an operation such as picture writing, reading, deletion, or formatting), do not turn off the camera or remove the battery, card, AC adaptor (DMW-AC10PP: optional) or DC coupler (DMW-DCC11: optional).
Furthermore, do not subject the camera to vibration, impact or static electricity.
 - The data on the card may be damaged or lost due to electromagnetic waves, static electricity or breakdown of the camera or the card. We recommend storing important data on a PC etc.
 - Do not format the card on your PC or other equipment. Format it on the camera only to ensure proper operation.
-

-
- **The battery is not charged when the camera is shipped. Charge the battery before use.**
 - **The battery is a rechargeable lithium ion battery. If the temperature is too high or too low, the operating time of the battery will become shorter.**
 - The battery becomes warm after using and during and after charging. The camera also becomes warm during use. This is not a malfunction.
 - **Do not leave any metal items (such as clips) near the contact areas of the power plug or near the batteries.**
 - Store the battery in a cool and dry place with a relatively stable temperature. (Recommended temperature: 15 °C to 25 °C (59 °F to 77 °F), Recommended humidity: 40%RH to 60%RH)
 - **Do not store the battery for a long time while fully charged.** When storing the battery for a long period of time, we recommend charging it once a year. Remove the battery from the camera and store it again after it has completely discharged.
-

How to use this manual

■ About the symbols in the text

MENU Indicates that the menu can be set by pressing [MENU/SET] button.

Steps for setting a menu item are described as follows:

MENU →  [Rec] → [Quality] → [..]

- This Owner's Manual expresses the up, down, left, and right of the cursor button as ▲ ▼ ◀ ▶.

Recording mode:   **P** **A** **S** **M**   **SCN** 

- In Recording modes that show icons in black, you can select and execute indicated menus and functions.

 (Custom Mode) has different functions depending on the recording mode that is registered.

Contents

■ Information for Your Safety	3	Playback	
Preparations/Basics		■ Viewing your pictures	40
■ Before use	12	Menu	
■ Standard accessories	13	■ Menu list	44
■ Names and Functions of Main Parts	14	Wi-Fi/Bluetooth	
■ Quick Start Guide	16	■ What you can do with the Wi-Fi®/Bluetooth® function	48
Inserting the battery and/or SD memory card (optional)	16	■ Operating the camera by connecting it to a smartphone	50
Charging the battery	17	Others	
Setting the clock	19	■ Downloading software	57
Formatting the card (initialization)	20	■ List of monitor/viewfinder displays	58
[LVF] button (Recording pictures using the viewfinder) ...	20	■ Q&A	
Mode dial (Select the recording mode)	21	Troubleshooting	61
Holding the camera	22	■ Specifications	63
Shutter button (Taking pictures)	22	■ Digital Camera Accessory System	67
■ Basic operations	23	■ Reading the Owner's Manual (PDF format)	68
■ Setting the menu	27	■ Limited Warranty (ONLY FOR U.S.A.)	69
Recording		■ Limited Warranty (ONLY FOR CANADA)	73
■ Taking pictures with automatic settings (Intelligent Auto Mode)	28		
■ Recording with the 4K Photo function	29		
■ Adjusting the focus after recording ([Post Focus] / [Focus Stacking])	33		
■ Recording Motion Picture/ 4K Motion Picture	36		

Before use

■ Camera handling

Keep the camera away from excessive vibration, force, or pressure.

- Avoid using the camera under the following conditions, which may damage the lens, monitor, viewfinder, or camera body. This may also cause the camera to malfunction or prevent recording.
 - Dropping or hitting the camera against a hard surface
 - Sitting down with the camera in your pants pocket or forcing it into a full bag
 - Adding accessories to the camera strap
 - Pushing with excessive force on the lens or monitor

The camera is not dust resistant, splash resistant, or waterproof.

Avoid using the camera in places with excessive dust or sand, or where water can come into contact with the camera.

■ Condensation (When the lens, the monitor, or viewfinder, is fogged up)





- Condensation may occur when the camera is exposed to sudden changes of temperature or humidity. Avoid these conditions, which may make the lens, monitor, or viewfinder dirty, cause mold, or damage the camera.
- If condensation does occur, turn off the camera and wait about two hours before using it. Once the camera adjusts to the surrounding temperature, the fogging will clear naturally.

■ When in use

- Do not keep objects that may be influenced magnetically close to the speaker.
 - Magnetized objects such as bank cards, commuter passes, watches, may be adversely affected by the magnetic influence of the speaker.

Standard accessories

Check that all the accessories are supplied before using the camera. Part numbers are as of August 2022. These may be subject to change.

<input type="checkbox"/> Battery pack DMW-BLG10PP <ul style="list-style-type: none"> • Charge the battery before use. • Battery pack is indicated as battery pack or battery in the text. 	<input type="checkbox"/> USB connection cable K1HY04YY0106 
<input type="checkbox"/> AC adaptor SAE0012A 	<input type="checkbox"/> Hand strap VFC4297 

- **Cards are optional.** (SD Memory Card, SDHC Memory Card and SDXC Memory Card are indicated as card in the text.)
 - This unit is compatible with UHS-I UHS Speed Class 3 standard SDHC/SDXC memory cards.
 - The following SD standard-based cards can be used.
 SD Memory Card (512 MB to 2 GB)/SDHC Memory Card (4 GB to 32 GB)/SDXC Memory Card (48 GB to 128 GB)
 - Depending on recording conditions, the required card differs.

(For U.S.A. only)

- If accessories are lost, customers can visit us at <http://shop.panasonic.com/support> for further information about obtaining replacement parts.



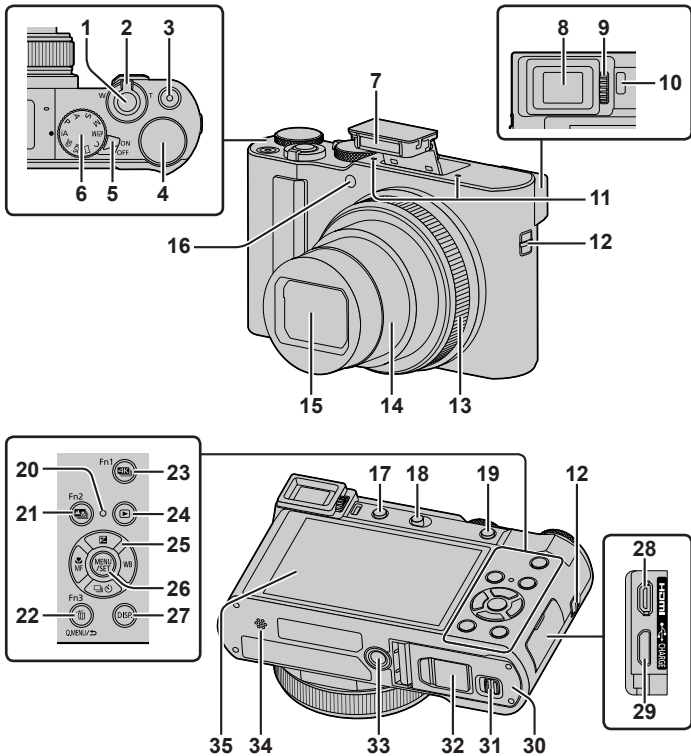

(For Canada only)

- If any accessories are lost, customers in Canada should visit our support page at www.panasonic.ca/english/support for further information about obtaining replacement parts.
- Please dispose of all packaging appropriately.
- The illustrations and screens in this manual may differ from the actual product.

Names and Functions of Main Parts



- 1 Shutter button (→22)
 - 2 Zoom lever (→23)
 - 3 Motion picture button (→36)
 - 4 Rear dial (→25)
 - 5 Camera [ON/OFF] switch (→19)
 - 6 Mode dial (→21)
 - 7 Flash (→22)
 - 8 Viewfinder (→20)
 - 9 Diopter adjustment dial (→20)
 - 10 Eye sensor (→20)
 - 11 Stereo microphone
 - 12 Strap eyelet

- To prevent dropping, be sure to attach the supplied strap and fit it to your wrist.
 - 13 Control ring (→25)
 - 14 Lens barrel
 - 15 Lens
 - 16 Self-timer indicator / AF Assist Lamp
 - 17 [LVF] button (→20) / [Fn4] button (→26)
 - 18 Flash open lever
 - The flash opens, and recording with the flash becomes possible.
 - 19 [AF/AE LOCK] button
 - You can take pictures by locking the focus and/or exposure.
 - 20 Charging lamp (→17, 18) / WIRELESS connection lamp (→49)
 - 21  ([Post Focus]) button (→33) / [Fn2] button (→26)
 - 22  (Delete) button (→40) / [Q.MENU/⏏] (Cancel) button / [Fn3] button (→26)
 - You can easily call some of the menu items and set them during recording.
 - 23  (4K photo mode) button (→29) / [Fn1] button (→26)
 - 24  (Playback) button (→40)
 - 25 Cursor button (→24)
 - 26 [MENU/SET] button
 - Confirmation of setting contents, etc., is performed.
 - 27 [DISP.] button
 - Use this to change display.
 - 28 [HDMI] socket
 - You can view pictures on a TV screen by connecting your camera to your TV with the HDMI micro cable.
 - 29 [USB/CHARGE] socket (→17)
 - 30 Card/Battery door (→16)
 - 31 Release lever (→16)
 - 32 DC coupler cover (→67)
 - 33 Tripod mount
 - Do not attach this unit to tripods that have screws with a length of 5.5 mm (0.22 inch) or more. Doing so may damage this unit or the unit may not be secured properly on the tripod.
 - 34 Speaker
 - 35 Touch screen (→26) / monitor (→58)
- Always use a genuine Panasonic AC adaptor (DMW-AC10PP: optional). (→67)
When using an AC adaptor, ensure that the Panasonic DC coupler (DMW-DCC11: optional) and AC adaptor (DMW-AC10PP: optional) are used.

Function buttons [Fn5] to [Fn9] are touch icons.

They can be displayed by touching the  tab on the recording screen.

Quick Start Guide

Inserting the battery and/or SD memory card (optional)

Make sure that the camera is turned off.

1 Slide the release lever (A) to the [OPEN] position and open the card/battery door

2 Insert the battery and card, making sure that their orientation is correct

- Battery: Insert the battery all the way firmly and check that it is locked by lever (B).
- Card: Insert the card all the way firmly until it clicks. Do not touch the terminal.

3 Close the door

Slide the release lever to the [LOCK] position.

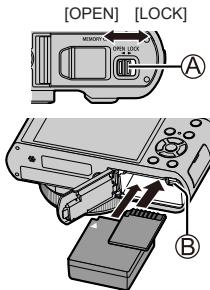

■ To remove

• To remove battery

Move lever (B) in direction of arrow.

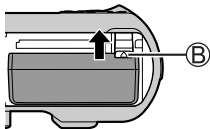

• To remove card

Press the center of the card.

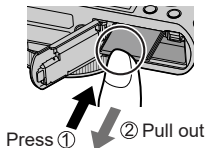

- Always use genuine Panasonic batteries (DMW-BLG10PP).
- If you use other batteries, we cannot guarantee the quality of this product.
- Keep the memory card out of reach of children to prevent swallowing.

Charging the battery

- The battery that can be used with this unit is **DMW-BLG10PP**.
- We recommend charging in a location where the ambient temperature is between 10 °C and 30 °C (50 °F to 86 °F).

Insert the battery into the camera.
Make sure that the camera is turned off.

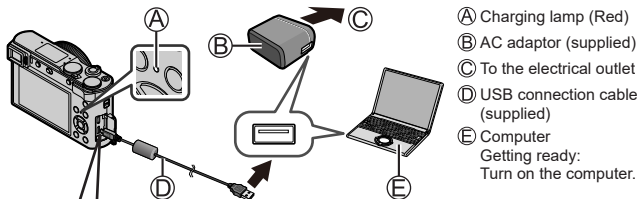

- Ⓐ Charging lamp (Red)
- Ⓑ AC adaptor (supplied)
- Ⓒ To the electrical outlet
- Ⓓ USB connection cable (supplied)
- Ⓔ Computer
Getting ready:
Turn on the computer.

Ⓕ [USB/CHARGE] socket

- This terminal is located at the bottom when the camera is in an upright position.

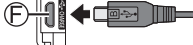

- Always check the direction of the socket, and hold the plug straight to insert or remove it. (If the cable is inserted in the wrong direction, the socket could become deformed and cause faulty operation.) Also, do not insert into the wrong socket. Doing so may cause damage to this unit.

Charging from the power outlet

Connect the AC adaptor (supplied) and this camera with the USB connection cable (supplied), and insert the AC adaptor (supplied) into the power outlet.

Charging from a computer

Connect the computer and this camera with the USB connection cable (supplied).

■ Charging lamp indications (Red)

On: Charging in progress

Off: Charging complete (After charging stops, disconnect the camera from the electrical outlet or your computer.)

Flashing: Charging error (→61)

■ Charging time

When using the AC adaptor (supplied)	Approx. 190 min.
--------------------------------------	------------------

- **The charging time indicated above is the time required for charging in case when the battery is completely used up. The time required for charging differs depending on conditions of battery usage. Charging takes longer in cases when temperatures are either high or low and when the battery has not been used for a long period of time.**
- The time required for charging through the computer varies depending on the power supply capacity of the computer.
- Do not use any other USB connection cables except the supplied one.
- Do not use any other AC adaptors except the supplied one.

Setting the clock

The clock is not set when the camera is shipped.

1 Turn the camera on

2 Press [MENU/SET]

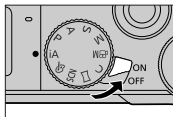

3 Press ▲▼ to select the language and press [MENU/SET]

- The [Please set the clock] message appears.

4 Press [MENU/SET]

5 Press ◀▶ to select the items (year, month, day, hour, minute), and press ▲▼ to set

6 Press [MENU/SET]

7 When [The clock setting has been completed.] is displayed, press [MENU/SET]

8 When [Please set the home area] is displayed, press [MENU/SET]

9 Press ◀▶ to set your home area and press [MENU/SET]

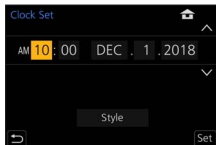

Formatting the card (initialization)

Format the card before recording a picture with this unit.

Since data cannot be recovered after formatting, make sure to back up necessary data in advance.

MENU →  **[Setup]** → **[Format]**

[LVF] button (Recording pictures using the viewfinder)

1 Press [LVF] (A) button

- Ⓐ [LVF] button
- Ⓑ Eye Sensor
- Ⓒ Diopter adjustment dial

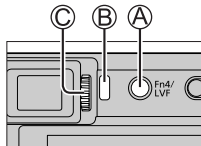

Automatic switching between
viewfinder and monitor



Viewfinder display



Monitor display



■ Automatic switching between viewfinder and monitor

The eye sensor (Ⓑ) automatically switches the display to viewfinder when your eye or an object moves close to the viewfinder. When the eye or object moves away from the viewfinder, the camera returns to monitor display.

■ About diopter adjustment

Rotate the diopter adjustment dial (Ⓒ) to adjust until you are able to clearly see the characters displayed in the viewfinder.





- If [LVF Display Speed] is set to [ECO 30fps] when the viewfinder is used, the camera can be operated for a longer period since battery drainage is reduced.

Mode dial (Select the recording mode)

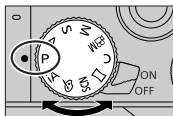
1 Set to the desired recording mode

- Rotate the mode dial slowly to select the desired mode.
- When you set the mode dial to [iA], the camera automatically optimizes the main settings.



iA	 Intelligent Auto Mode (→28)
	 Intelligent Auto Plus Mode (→28)
P	Program AE Mode Take pictures with automatic shutter speed and aperture value settings.
A	Aperture-Priority AE Mode Determine aperture, then take pictures.
S	Shutter-Priority AE Mode Determine shutter speed, then take pictures.
M	Manual Exposure Mode Determine aperture and shutter speed, then take pictures.
 M	Creative Video Mode Determine aperture, shutter speed and ISO sensitivity, then record motion pictures. • You cannot take still pictures.
C	Custom Mode Take pictures using pre-registered settings.
	Panorama Shot Mode Take panorama pictures.
SCN	Scene Guide Mode Take pictures that match the scene being recorded.
	Creative Control Mode Take pictures by selecting your preferred picture effect.

Holding the camera

- Do not block the flash, AF Assist Lamp, microphone, or speaker with your fingers or other objects.

- Ⓐ AF Assist Lamp
- Ⓑ Flash
- Ⓒ Microphone
- Ⓓ Speaker

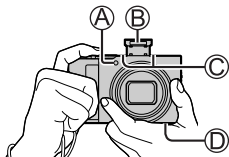

Shutter button (Taking pictures)

1 Press the shutter button halfway (press lightly) to focus on the subject



- Ⓐ Aperture value
- Ⓑ Shutter speed
- Ⓒ Focus display (Green)
(When focus is aligned: illuminated
When focus is not aligned: flashing)

- If the aperture value and shutter speed are shown in red and flashing, you do not have the appropriate exposure, unless you are using the flash.

2 Press the shutter button fully (push the button all the way), and take the picture



- Pictures can be taken only when the image is correctly focused as long as the [Focus/Release Priority] is set to [FOCUS].

■ Estimated number of recordable pictures

1450: When [Aspect Ratio] is set to [3:2], [Quality] is set to [📷], [Picture Size] is set to [L] (20M), and using a card of 16 GB

■ Check the picture you have taken

Press the [▶] (Playback) button. (→40)

Basic operations

Zoom lever (Use zoom)

Optical Zoom:

You can zoom in without degrading the picture quality.

Maximum magnification: 15x

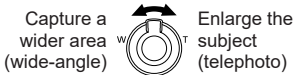

Extended optical zoom:

This function works when picture sizes with [EX] have been selected in [Picture Size]. Extended optical zoom allows you to zoom in using a higher zoom ratio than optical zoom, without degrading the picture quality.

Maximum magnification: 30x*1

*1 Including the optical zoom ratio. The maximum zoom ratio varies depending on the picture size.

[i.Zoom]:

Set the [i.Zoom] in the [Rec] menu to [ON].

You can use the camera's intelligent resolution technology to increase the zoom ratio up to 2x*2 higher than the original zoom ratio with limited deterioration of picture quality.

*2 Up to 1.5x the original zoom ratio when [Picture Size] is set to [S]

[Digital Zoom]:

Set the [Digital Zoom] in the [Rec] menu to [ON].

Zoom 4x further than Optical/Extended optical zoom. When [Digital Zoom] is used simultaneously with [i.Zoom], you can increase the combined zoom ratio up to 4x.

Note that, with Digital Zoom, enlarging will decrease picture quality.

- When [Monitor Display Speed] is set to [ECO 30fps], Digital Zoom is not available (setting at the time of purchase).
- When [LVF Display Speed] is set to [ECO 30fps], Digital Zoom is not available.

Cursor button

Selection of items or setting of values etc., is performed.

You can perform the following operations while recording. (Some items or settings cannot be selected depending on the mode or display style the camera is in.)





(Exposure compensation) (▲)

- Corrects the exposure when there is a backlight or when the subject is too dark or too bright.

(White balance) (▶)



- Adjusts to the color of white which is closest to what is seen by the eye in accordance with the light source.

(Drive mode) (▼)

-  ([Burst])*
 - Records in succession while the shutter button is pressed.
-  ([4K PHOTO])* (→29)
-  ([Post Focus])* (→33)
-  ([Self Timer])*

* To cancel drive mode, select  ([Single]) or  ([Off]).

(Focus mode) (◀)

- [AF]
 - Focus is set automatically when the shutter button is pressed halfway.
-  ([AF Macro])
 - You can take pictures of a subject as close as 3 cm (0.098 feet) from the lens by rotating the zoom lever upmost to Wide.
-  ([Macro Zoom])
 - Use this setting to get close to the subject and then further enlarge when taking the picture. You can take a picture with the Digital Zoom up to 3x while maintaining the distance to the subject for the extreme Wide position (3 cm (0.098 feet)).
- [MF]
 - Manual focus is convenient when you want to lock the focus to take pictures or when it is difficult to adjust focus using auto focus.

Control ring/Rear dial

You can use the control ring (A)/rear dial (B) to change the settings for recording.



Following are the pre-assigned settings.

Mode dial	Control ring*1	Rear dial
iA	Step Zoom	—
P	Program Shift	
A	Aperture adjustment	
S	Shutter speed adjustment	
M	Aperture adjustment*2	Shutter speed adjustment*2
M	Aperture adjustment*3 / Shutter speed adjustment*3	
□ / ↻	Picture effects change	
SCN	Aperture adjustment*4 / Shutter speed adjustment*5	

*1 When Manual Focus is set, the control ring is assigned to focus adjustment.

*2 Press **▲** to switch between shutter speed adjustment and aperture adjustment.

*3 When [Exposure Mode] is set to [A], [S], or [M], you can change the aperture value and shutter speed in the same way as when the mode dial is set to [A], [S], or [M].

*4 The operation is possible only when the Scene Guide Mode is set to [Appetizing Food].

*5 The operation is possible only when the Scene Guide Mode is set to [Artistic Nightscape].

- You can change to your preferred settings using [Ring/Dial Set] (→46) from the [Custom] ([Operation]) menu.

Function buttons

- [Fn1] to [Fn4] are buttons on the camera.
- Function buttons [Fn5] to [Fn9] are touch icons. They can be displayed by touching the [Fn] tab on the recording screen.
- You can assign frequently-used functions to particular buttons or icons with [Fn Button Set] (→46) in [Custom] ([Operation]) menu.

Touch screen (Touch operations)

Touch

To touch and release the touch screen.



Drag

To touch and slide your finger across the touch screen.



Pinch (spread/pinch)

On the touch screen, spread (pinch out) your 2 fingers to zoom in, and pinch (pinch in) your 2 fingers to zoom out.

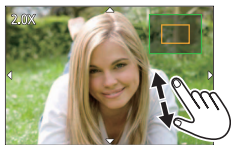

Setting the menu

1 Press [MENU/SET] to bring up the menu

2 Switch the menu type

- ① Press ◀
- ② Press ▲▼ to select a tab such as [🔧]
- ③ Press [MENU/SET]



■ Menu types (→44)

- 📷 [Rec]
 - 🔧 [Setup]
 - 👤 [Motion Picture]
 - 👤 [My Menu]
 - ⚙️ [Custom]
 - ▶️ [Playback]
- Menus to be displayed in each recording mode

3 Press ▲▼ to select the menu item and press [MENU/SET]

4 Press ▲▼ to select the setting and press [MENU/SET]

- The setting methods vary depending on the menu item.

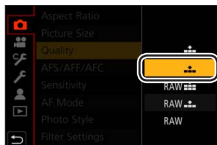

5 Press [Q.MENU/↵] button repeatedly until the recording or playback screen reappears

- During recording, the menu screen can also be exited by pressing the shutter button halfway.
- The menu items that cannot be set are grayed out. In some setting conditions, the reason the setting is disabled is displayed when you press [MENU/SET] if you select a grayed-out menu item.

Recording with the 4K Photo function





Recording mode: **P** **A** **S** **M** **SCN**

You can take burst pictures of approximately 8 million pixels with a burst rate of 30 fps. You can select and save a frame from the burst file.

- To record pictures, use a UHS Speed Class 3 card.

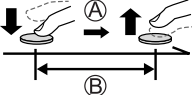
1 Press [**4K**] button

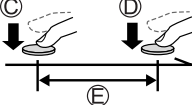
2 Press ◀▶ to select the recording method and press [MENU/SET]

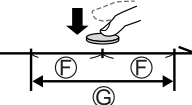



 [4K Burst]	<p>For capturing the best shot of a fast-moving subject</p> <p>Burst recording is performed while the shutter button is pressed and held.</p> <ul style="list-style-type: none"> • Recording will start approximately 0.5 seconds after you press the shutter button fully. Therefore, press the button fully slightly in advance. <p>Ⓐ Press and hold Ⓑ Recording is performed</p> 
 [4K Burst(S/S)] "S/S" is an abbreviation of "Start/Stop".	<p>For capturing unpredictable photo opportunities</p> <p>Burst recording starts when the shutter button is pressed and stops when pressed again.</p> <p>Ⓒ Start (First) Ⓓ Stop (Second) Ⓔ Recording is performed</p> 
 [4K Pre-Burst]	<p>For recording as needed whenever a photo opportunity arises</p> <p>Burst recording is performed for approximately 1 second before and after the moment that the shutter button is pressed.</p> <p>Ⓕ Approximately 1 second Ⓖ Recording is performed</p> 

3 Press the shutter button to perform recording

- When you press the [Fn1] button while recording, you can add a marker. (Up to 40 markers for each recording.) When selecting and saving pictures from a 4K burst file, you can skip to the positions where you added markers. ([4K Burst(S/S)] only)
- Burst pictures are saved as a single 4K burst file in the MP4 format.
- When [Auto Review] is enabled, the picture selection screen will be displayed automatically.

■ To cancel the 4K Photo functions

In step 2, select [].

- If the surrounding temperature is high or 4K photos are recorded continuously, [] may be displayed and recording may be stopped halfway through. Wait until the camera cools down.
- **When [] ([4K Pre-Burst]) is set, the battery drains faster and the camera temperature rises. (to protect itself, the camera may switch to [] ([4K Burst]))**
Select [] ([4K Pre-Burst]) only when recording.
- Recording stops when the continuous recording time exceeds 15 minutes. When using an SDHC memory card, files are split into smaller picture files for recording and playback if the file size exceeds 4 GB. (You can continue to record pictures without interruption.)
If using an SDXC memory card, you can record pictures in a single file even if the size is greater than 4 GB.
- When recording, the angle of view becomes narrower.
- When you perform [Light Composition] or [Sequence Composition], we recommend using a tripod and taking pictures remotely by connecting the camera to a smartphone to prevent camera shake. (→55)

Selecting pictures from 4K burst file and saving

1 Select a picture with the [⏮/4K/⏭] on the playback screen, and press ▲

- In the case of recording with [⏮/4K/⏭] ([4K Pre-Burst]), proceed to the step 3.



2 Drag the slide bar to perform rough scene selection

- When [⏮/→/↔] is touched, the marker operation screen appears. (→32)



3 Drag to select the frame you want to save as a picture

- To continuously rewind/forward the scene or frame-by-frame, touch and hold [◀]/[▶].



4 Touch [⏮/PHOTO/⏭] to save the picture

- The selected picture will be saved as a new picture in the JPEG format separate from the 4K burst file.
- If you use [4K PHOTO Bulk Saving] (→47) in the [Playback] menu, you can bulk save 5 seconds' worth of 4K recording.

■ Marker

When selecting and saving pictures from a 4K burst file, you can select pictures easily by skipping between marked positions.

■ Skips to the marked positions

When [**⏮**→**⏪**] is touched, the marker operation screen appears. You can use **◀▶** to skip to a marked position to select a picture.

Touch [**⏭**→**⏩**] to return to the original operation.

White marker: This is manually set during recording or playback.

Green marker: This is automatically set by the camera during recording.
(Auto Marking function*1)

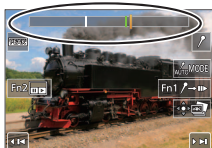

Marker operation screen

*1 The camera automatically sets markers on scenes in which a face or the movement of a subject is detected. (Up to 10 markers are displayed for each file.)
(Example: At the scene when a vehicle passes by, a balloon bursts, or a person turns around)

- In the following cases, markers may not be set by the Auto Marking function depending on the recording conditions and the status of subjects.
 - The camera is moving because of panning or jitter
 - The movement of a subject is slow/small, or the subject is small
 - A face is not facing front

■ Switches a marker to be displayed

① Touch [**4K/1080**MODE]

- [Auto]
- [Motion Priority]
- [Face Priority]
- [Off]*2

*2 Displays manually set markers only

Adjusting the focus after recording

([Post Focus] / [Focus Stacking])

Recording mode:   **P** **A** **S** **M**   **SCN** 

You can record 4K burst pictures while changing the focus point and then select a focus point after recording. This function is best for non-moving subjects.

- To record pictures, use a UHS Speed Class 3 card.
- We recommend using a tripod to perform [Focus Stacking].

1 Press [] button

2 Press ◀▶ to select [ON] and press [MENU/SET]

3 Determine the composition and press the shutter button halfway



- Auto Focus activates and automatically detects the focus point on the screen.
- If there is no focus point on the screen, the Focus indicator (A) blinks and you cannot record.

From halfway pressing the shutter button to completion of recording

- Do not change the distance to subject or the composition.

4 Press the shutter button fully to start recording



- The focus point changes automatically while recording. When the recording progress bar (B) disappears, recording automatically ends.
- The data will be saved as a single file in the MP4 format.
- If [Auto Review] is set, a screen will automatically appear that lets you select the focus point. (→34)

■ Canceling [Post Focus]

Select [OFF] in step 2.

- If the surrounding temperature is high or [Post Focus] recording is performed continuously, [▲] may be displayed and recording may be stopped halfway through. Wait until the camera cools down.
- During recording, the angle of view will be narrower.

Select the focus point and save the picture ([Post Focus])

1 On the playback screen, select the image with the [] icon and press ▲



2 Touch the focus point

- If there are no pictures with the focus on the selected point, a red frame will be displayed, and pictures cannot be saved.
- The edge of the screen cannot be selected.
- To switch to the [Focus Stacking] operations screen, touch []. (→35)
- To highlight in-focus portion with color, touch [PEAK].
- To enlarge the display, touch [Q].
- You can make fine adjustments to the focus by dragging the slide bar during enlarged display. (The same operation can be performed using ◀▶.)

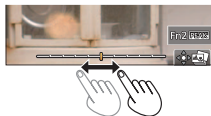

3 Touch [] to save the picture

- The selected picture will be saved as a new separate file in the JPEG format.

Select the focus range to combine and create a single picture ([Focus Stacking])

- 1 Touch [] on screen in step 2 of “Select the focus point and save the picture ([Post Focus])” (→34)
- 2 Choose a stacking method and touch it

[Auto Merging]	Automatically select photos suitable for stacking and combine them into one picture. <ul style="list-style-type: none"> • Choose by giving preference to near-focus pictures. • Perform the focus stacking and save the picture.
[Range Merging]	Combine the pictures with the selected focus position into one picture.

(When selecting [Range Merging])

3 Touch the focus point

- Select positions at two or more points.
- Focus points between the selected two positions will be selected.
- Positions that cannot be selected, or that would produce an unnatural result will be grayed out.

- Touch a position again to deselect it.

4 Touch [] to combine and save the picture

- The picture will be saved in JPEG format.

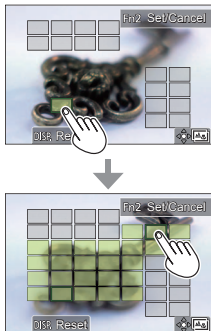

- Only pictures taken using [Post Focus] on this camera are eligible for [Focus Stacking].

Recording Motion Picture/4K Motion Picture

Recording mode:   **P** **A** **S** **M**   

You can record full high-definition quality images that comply with the AVCHD standard, as well as motion pictures or 4K motion pictures recorded in MP4.

1 Press the motion picture button to start recording

- (A) Elapsed recording time
- (B) Remaining recording time
- (C) Recording (flashes red)

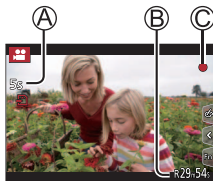

- Recording of motion picture appropriate for each motion picture mode is possible.
- Immediately release the motion picture button after pressing it.
- If you press the shutter button down fully, you can take still pictures while recording motion pictures. (Except for in Creative Video Mode)

2 Press the motion picture button again to end recording

- To record 4K motion pictures, use a UHS Speed Class 3 card.
- When you record 4K motion pictures, the angle of view will be narrower than motion pictures of other sizes.
- To ensure highly accurate focus, 4K motion pictures are recorded at reduced Auto Focus speeds. It may be difficult to focus on the subject with Auto Focus, but this is not a malfunction.
- **With recording in a quiet environment, the sound of aperture, focus and other actions may be recorded in motion pictures. This is not a malfunction.**
The focus operation during recording of motion pictures can be set to [OFF] in [Continuous AF].
- If the surrounding temperature is high, or a motion picture is recorded continuously, [] is displayed and recording may be stopped halfway through. Wait until the camera cools down.

■ Setting the format, picture size and recording frame rate

MENU →  **[Motion Picture]** → **[Rec Format]**

Settings: **[AVCHD]** / **[MP4]**

MENU →  **[Motion Picture]** → **[Rec Quality]**

When [AVCHD] is selected:

[FHD/28M/60p]*1 / [FHD/17M/60i] / [FHD/24M/30p] / [FHD/24M/24p]

- **[AVCHD] motion pictures:**

Files are split into smaller motion picture files for recording when the file size exceeds 4 GB.

- **Motion pictures with [Rec Quality] setting of [FHD/28M/60p]/[FHD/17M/60i] in [AVCHD]:**

Recording stops when the continuous recording time exceeds 29 minutes and 59 seconds.

When [MP4] is selected:

[4K/100M/30p]*2 / [4K/100M/24p]*2 / [FHD/28M/60p] / [FHD/20M/30p] / [HD/10M/30p]

- **MP4 motion pictures with a [Rec Quality] size of [FHD] or [HD]:**

Files are split into smaller motion picture files for recording and playback when the file size exceeds 4 GB. (You can continue to record motion pictures without interruption.)

- **Motion pictures with [Rec Quality] setting of [FHD/28M/60p] in [MP4]:**

Recording stops when the continuous recording time exceeds 29 minutes and 59 seconds.

- **MP4 motion pictures with a [Rec Quality] size of [4K]:**

Recording stops when the continuous recording time exceeds 15 minutes.

When using an SDHC memory card, files are split into smaller motion picture files for recording and playback if the file size exceeds 4 GB. (You can continue to record motion pictures without interruption.)

If using an SDXC memory card, you can record a motion picture in a single file even if the size is greater than 4 GB.

*1 AVCHD Progressive

*2 4K motion pictures

[4K Live Cropping]

By cropping your motion picture down from the 4K angle of view to Full High Definition, you can record a motion picture that pans and zooms in/out while leaving the camera in a fixed position.

- Hold the camera firmly in place while recording.
- A motion picture will be recorded at [FHD/20M/30p] under [MP4].



Pan



Zoom in

- When you want to zoom in/out, set different angles of view for the cropping start and end frames. For example, to zoom in, set a larger angle of view for the start frame and a smaller angle of view for the end frame.

1 Set mode dial to [CAM]

2 Set the menu

MENU → **CM** [Creative Video] → [4K Live Cropping]

Settings: [40SEC] / [20SEC] / [OFF]

3 Set the crop start frame and press [MENU/SET] to set

- Set the crop end frame as well.
- When making settings for the first time, a crop start frame of size 1920×1080 is displayed.
- Move the frame by touching it or using the cursor button. You can adjust the frame size by pinching out/pinching in or rotating the rear dial.

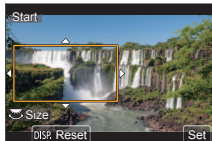

4 Press the motion picture button (or the shutter button) to start recording

- (A) Elapsed recording time
- (B) Set operating time

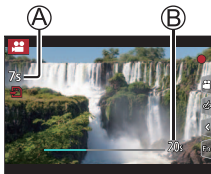

- Immediately release the motion picture button (or the shutter button) after pressing it.
- When the set operating time has elapsed, recording automatically ends. To end recording midway, press the motion picture button (or the shutter button) again.

■ Changing the position and size of a crop frame

Press [Fn3] button while the recording screen is displayed, and perform step 3.

■ To cancel [4K Live Cropping] recording

Set [OFF] in step 2.

- The angle of view narrows.
- Focus is adjusted and fixed in the crop start frame.
- [Continuous AF] is set to [OFF].
- [Metering Mode] will be [(☉)] (Multi Metering).
- You cannot zoom in/out during [4K Live Cropping] recording.

Viewing your pictures

1 Press [▶] (Playback) button

2 Press ◀▶ to select a picture to be displayed

- When you press and hold ◀▶, the pictures are displayed one after another.

■ Ending Playback

Press [▶] (Playback) button again or press the shutter button halfway.

- The playback screen appears if the camera is turned on while pressing [▶] (Playback) button.
- When [Lens Retraction] is set to [ON], the lens barrel is retracted after approx. 15 seconds as the camera is switched to the playback screen from the recording screen.

■ Viewing motion pictures

This unit was designed to play motion pictures using the AVCHD and MP4 formats.

- Motion pictures are displayed with the motion picture icon ([🎬]).

① Press ▲ to start playback

- If you press [MENU/SET] during a pause, you can create a picture from a motion picture.



■ Deleting pictures

Deleted pictures cannot be recovered.

- ① Press [🗑️] button to delete displayed picture
- ② Use ▲ to select [Delete Single] and press [MENU/SET]

[Light Composition]

Select multiple frames from 4K burst files that you wish to combine. Parts of the image that are brighter than the preceding frame will be superimposed on the preceding frame to combine the frames into one picture.



MENU → **▶** [**Playback**] → [**Light Composition**]

1 Use **◀▶** to select the 4K burst files and press [**MENU/SET**]

2 Choose the combining method and press [**MENU/SET**]

■ [Composite Merging]: Selecting frames to combine

① Drag the slide bar or use **▲▼◀▶** to select the frames to combine

② Press [**MENU/SET**]

- The selected frames are remembered, and the display goes to the preview screen.

- Use **▲▼** to select items and press [**MENU/SET**] to perform the following operations.

- [Next]: Lets you select more frames for combining.

- [Reselect]: Discards the frame selected immediately before and lets you select a different image.

③ Repeat steps ① - ② to select more frames to combine (up to 40 frames)

④ Press **▼** to select [Save] and press [**MENU/SET**]



■ **[Range Merging]: Selecting a range to combine**

- ① Select the frame of the first picture and then press [MENU/SET]
 - The selection method is the same as in step ① of [Composite Merging] setting.
- ② Select the frame of the last picture and then press [MENU/SET]

3 Select [Yes] at the confirmation screen and press [MENU/SET]

- The picture will be saved in JPEG format.

■ **[Sequence Composition]**

Select multiple frames from a 4K burst file to create a sequence composition of a moving subject into one picture.

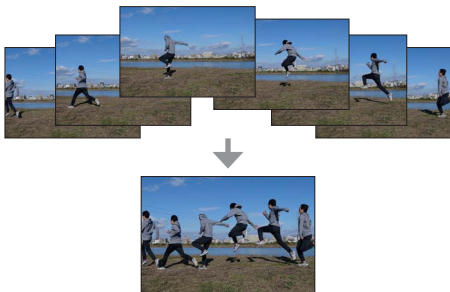

- We recommend using a tripod to take pictures for Sequence Composition.

[MENU] → [▶] [Playback] → [Sequence Composition]

1 Use ◀▶ to select the 4K burst files and press [MENU/SET]**2 Select frames to combine**

Select the frames so that the moving subject will not overlap on the preceding or subsequent frames. (The sequence composition may not be created properly if the subject overlaps.)

① Drag the slide bar or use ▲▼◀▶ to select the frames to combine

② Press [MENU/SET]

- The selected frames are remembered, and the display goes to the preview screen.

- Use ▲▼ to select items and press [MENU/SET] to perform the following operations.

- [Next]: Lets you select more frames for combining.

- [Reselect]: Discards the frame selected immediately before and lets you select a different image.

③ Repeat steps ① - ② to select more frames to combine (from 3 to 40 frames)

④ Press ▼ to select [Save] and press [MENU/SET]

**3 Select [Yes] at the confirmation screen and press [MENU/SET]**

- The picture will be saved in JPEG format.

Menu list

- You can display an explanation on the menu by pressing the [DISP.] button while you select a menu item or setting. (→27)



Menus to be displayed in each recording mode

iA iA⁺ [Intelligent Auto]

[Intelligent Auto Mode]

[iHandheld Night Shot]

[iHDR]

M [Creative Video]

[Exposure Mode]

[High Speed Video]

[4K Live Cropping]

C [Custom Mode]

You can select your preferred custom setting from [Set1], [Set2], and [Set3].

S [Panorama Shot]

[Direction]

[Picture Size]

SCN [Scene Guide]

[Scene Switch]

CC [Creative Control]

[Filter Effect]

[Simultaneous Record w/o Filter]

 [Rec]		
[Aspect Ratio]	[i.Dynamic]*	[Digital Zoom]*
[Picture Size]	[i.Resolution]*	[Burst Rate]
[Quality]	[Flash]	[4K PHOTO]
[AFS/AFF/AFC]*	[Red-Eye Removal]	[Self Timer]
[Sensitivity]*	[ISO Auto Upper Limit (Photo)]	[Time Lapse Shot]
[AF Mode]*	[Min. Shtr Speed]	[Stop Motion Animation]
[Photo Style]*	[Long Shtr NR]	[Silent Mode]
[Filter Settings]*	[Diffraction Compensation]*	[Shutter Type]
[Color Space]	[Stabilizer]*	[Bracket]
[Metering Mode]*	[i.Zoom]*	[HDR]
[Highlight Shadow]*		[Multi Exp.]

* The menu items are common for both [Rec] and [Motion Picture] menus. (Common menu items are indicated in the [Rec] menu list only)

 [Motion Picture]		
[Rec Format]	[Continuous AF]	[Level Shot]
[Rec Quality]	[ISO Auto Upper Limit (Video)]	[Wind Noise Canceller]
[Snap Movie]	[Flkr Decrease]	[Zoom Mic]

 [Custom] [Exposure]

[ISO Increments]	[Extended ISO]	[Exposure Comp. Reset]
[Exposure Comp. Disp. Setting]		

 [Focus / Release Shutter]

[AF/AE Lock]	[Pinpoint AF Setting]	[Loop Movement Focus Frame]
[AF/AE Lock Hold]	[AF Assist Lamp]	[AF Area Display]
[Shutter AF]	[Direct Focus Area]	[AF+MF]
[Half Press Release]	[Focus/Release Priority]	[MF Assist]
[Quick AF]	[Focus Switching for Vert / Hor]	[MF Assist Display]
[Eye Sensor AF]		

 [Operation]

[Fn Button Set]	[Operation Lock Setting]	[Zoom lever]
[Q.MENU]	[Touch Settings]	
[Ring/Dial Set]	[Dial Guide]	

 [Monitor / Display]

[Auto Review]	[Guide Line]	[MF Guide]
[Monochrome Live View]	[Center Marker]	[LVF/Monitor Disp. Set]
[Constant Preview]	[Highlight]	[Rec Area]
[Peaking]	[Zebra Pattern]	[Remaining Disp.]
[Histogram]	[Expo.Meter]	[Menu Guide]

 [Lens / Others]

[Lens Position Resume]	[Self Timer Auto Off]	[Profile Setup]
[Lens Retraction]	[Face Recog.]	

 [Setup]

[Cust.Set Mem.]	[Monitor Display Speed]	[Version Disp.]
[Clock Set]	[LVF Display Speed]	[Folder / File Settings]
[World Time]	[Monitor Display]/ [Viewfinder]	[No.Reset]
[Travel Date]	[Monitor Luminance]	[Reset]
[Wi-Fi]	[m/ft]	[Reset Network Settings]
[Bluetooth]	[Eye Sensor]	[Level Gauge Adjust.]
[Wireless Connection Lamp]	[USB Mode]	[Demo Mode]
[Beep]	[TV Connection]	[Format]
[Economy]	[Language]	

 [My Menu]

[My Menu Setting]

You can register frequently used menus.

 [Playback]

[Slide Show]	[4K PHOTO Bulk Saving]	[Rotate]
[Playback Mode]	[Light Composition]	[Video Divide]
[Protect]	[Sequence Composition]	[Time Lapse Video]
[Rating]	[Clear Retouch]	[Stop Motion Video]
[Title Edit]	[Text Stamp]	[Rotate Disp.]
[Face Rec Edit]	[Resize]	[Picture Sort]
[RAW Processing]	[Cropping]	

What you can do with the Wi-Fi®/Bluetooth® function

Operating the camera by connecting it to a smartphone

- Operating the shutter button of the camera using a smartphone (remote recording) (→55)
- Playing back or saving images stored on the camera (→56)
- Combining motion pictures recorded with Snap Movie according to your preference on a smartphone

Expanding the scope of applications by connecting the camera to a smartphone compatible with Bluetooth Low Energy

- Pairing (connection setup) (→51)
- Turning on/off the camera with a smartphone (→54)
- [B] (Bulb) recording
- Transferring recorded images to a smartphone automatically
- Writing location information of a smartphone on a recorded image
- Synchronizing the camera's clock with a smartphone

Displaying still pictures on a TV

Wireless printing

Sending pictures to AV device

Sending pictures to a PC

- This manual uses the term "smartphone" for both smartphones and tablets unless it is necessary to distinguish between them.
- For details, refer to "Owner's manual for advanced features (PDF format)".

■ Lighting of the WIRELESS connection lamp (Blue)

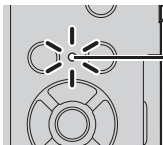

Lit: When the Wi-Fi/Bluetooth function is ON or connected
 Blinking: When sending picture data

- In [Wireless Connection Lamp] in the [Setup] menu, you can set the lamp so that it will not light/flash.

■ [Wi-Fi] button

In this Owner's manual, a function button to which [Wi-Fi] is assigned is referred to as the [Wi-Fi] button. (At the time of purchase, [Wi-Fi] is assigned to [Fn5] in recording mode, and [Fn1] in playback mode.)

- For details on the function button, refer to (→26)

To start up the Wi-Fi function (When in recording mode):

① Touch [Fn]



② Touch [Fn5]



- The camera cannot be used to connect to a public wireless LAN connection.

Operating the camera by connecting it to a smartphone

Installing the smartphone app “Panasonic Image App”

• Supported OS

Android™: Android 4.4 or later

(Android 5.0 or higher is required to use the Bluetooth function)

iOS: iOS 9.3 or later

(The Bluetooth function cannot be used with the iPad 2)

- ① Connect your device to a network
- ② (Android) Select “Google Play™ Store”
(iOS) Select “App Store”
- ③ Enter “Panasonic Image App” or “LUMIX” into the search box
- ④ Select “Panasonic Image App” and install it



- Use the latest version.
- Supported OS versions as of August 2022. Supported OS versions may be changed without prior notice.
- The service may not be able to be used properly depending on the type of smartphone being used.
For the latest information on the “Image App”, refer to the support site below.
<https://panasonic.jp/support/global/cs/dsc/>
(This site is available in English only.)
- When downloading the app on a mobile phone network, high packet communication fees may be incurred depending on the details of your contract.
- For details about the operating procedure, etc., refer to [Help] in the “Image App” menu.
- When you operate the “Image App” on the smartphone that is connected to the camera via Wi-Fi, [Help] in the “Image App” may not be displayed depending on the smartphone. In this case, after terminating the connection to the camera, reconnect the smartphone to a mobile phone network or to a Wi-Fi router, and then display [Help] in the “Image App”.
- Some of the screens and information provided in this document may be different depending on the supported operating system and “Image App” version.

Connecting the camera to a smartphone compatible with Bluetooth Low Energy

You can connect the camera to a smartphone via a Bluetooth connection.

• Supported smartphones

Android: Android 5.0 or higher equipped with Bluetooth 4.0 or higher
(excluding those that do not support Bluetooth low energy)

iOS: iOS 9.3 or higher (excluding the iPad 2)

First-time connection

You need to set up pairing (connection) for the first time only. When pairing is set up, a Wi-Fi connection is made automatically.

(On the camera)



- The camera enters pairing standby mode and displays its device name.

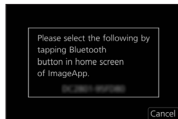

(On your smartphone)

1 Start “Image App”

- If a message is displayed indicating that the smartphone is searching for cameras, close the message.

2 Select [Bluetooth]

3 Turn on the Bluetooth

4 Select the device name displayed on the camera’s screen from the [Camera enable to be registered] list

- Bluetooth connection between the camera and the smartphone will be made. (For Android devices) A Wi-Fi connection will be made by selecting [Connection].

If you are using an Android device, follow the steps up to here to complete the setup.

Proceed to the steps below only if you are using an iOS device.

- If [Wi-Fi Password] (→53) is set to [OFF] on the camera, select [Wi-Fi Setup]. (At the time of purchase, [Wi-Fi Password] is set to [OFF])
- If [Wi-Fi Password] is set to [ON] on the camera, you need to install the profile.
 - ① Install the profile
 - If the smartphone is locked with a passcode, enter the passcode to unlock the smartphone.
 - ② Exit the browser

5 Turn on the Wi-Fi function in the setting menu

6 On the Wi-Fi setting screen, select the SSID displayed on the camera (The device name selected in step 4)

- If the SSID is not displayed, it may be displayed after the Wi-Fi function is turned off and on.
- When you need to change the connected device, follow the on-screen message to change the setting.

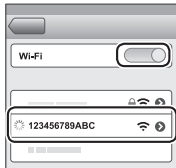

7 Start “Image App”

- The paired smartphone will be registered as a paired device after connected via Wi-Fi.
- To make a connection with the paired smartphone for the second and subsequent times, enable the Bluetooth function of the camera and set the Bluetooth for “Image App” on your smartphone to ON. Then, select a camera (device name) to be connected from the [Camera registered] list.
- [🔒] is displayed on the recording screen when a Bluetooth device is connected. If the Bluetooth function is enabled, but the smartphone is not connected, the displayed [🔒] is semi-transparent.
- When it takes time to set up pairing between a smartphone and a camera, delete the pairing information of both devices and register them again. This may enable the devices to be recognised properly.

Connecting the camera to a smartphone that does not support for Bluetooth Low Energy

You can easily establish a Wi-Fi connection on this unit without entering a password on your smartphone.

(On the camera)

MENU →  **[Setup]** → **[Wi-Fi]** → **[Wi-Fi Function]** → **[New Connection]**
→ **[Remote Shooting & View]**

- The information required for directly connecting your smartphone to this unit (SSID (A)) is displayed.
- You can also display the information by pressing the function button that [Wi-Fi] function is assigned.



(On your smartphone)

- 1 Turn on the Wi-Fi function in the setting menu
- 2 Select the SSID displayed on the screen of the camera
- 3 Start “Image App”

- When the connection confirmation screen appears on the camera, select [Yes] and press [MENU/SET]. (Only when making a connection for the first time.)

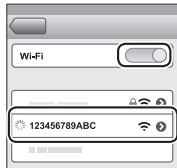

[Wi-Fi Password] is set to [OFF] at the time of purchase. When you start a Wi-Fi connection, be sure to verify that the device displayed on the camera's connection confirmation screen is really the device you want to connect to. Even if the wrong device is displayed, you will still be connected to it if you select “Yes”. If there seem to be other Wi-Fi enabled devices in the vicinity, we recommend that you set [Wi-Fi Password] to [ON]. For details, refer to “Owner’s manual for advanced features (PDF format)”.

Closing the Wi-Fi connection

1 Set the camera to Recording Mode

- Press the shutter button halfway to return to recording mode.

2 Select the camera's menu items to terminate the Wi-Fi connection

MENU →  [Setup] → [Wi-Fi]
→ [Wi-Fi Function] → [Yes]

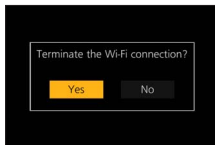

3 On the smartphone, close "Image App"

Turning on/off the camera with a smartphone

Wireless connectivity required: Bluetooth Wi-Fi

This function allows you to turn on the camera from a distant location and take pictures or view images on the camera even when it is in your bag.

1 Make a Bluetooth connection to the smartphone (→51)

2 Select the camera's menu

MENU →  [Setup] → [Bluetooth] → [Remote Wakeup] → [ON]

3 Set the Camera [ON/OFF] switch to [OFF]

4 On the smartphone, start up the "Image App", and set the Bluetooth function to a state in which a connection can be made (standby state)

5 Operate the smartphone

① Select []

② Select [Remote operation]



- The camera automatically turns on, allowing it to make a Wi-Fi connection automatically.

(iOS devices) Depending on the connection status of the smartphone, you may need to change the connected device on the Wi-Fi setup screen. Follow the on-screen message on the smartphone to change the setting.

■ Turning off the camera with the smartphone

① Select []

② Select [ OFF]

- When [Remote Wakeup] is set to [ON], the Bluetooth function continues to operate even after the camera is turned off, thus causing the battery to drain.

Operating the shutter button of the camera using a smartphone (remote recording)

Wireless connectivity required: Wi-Fi

1 Connect to a smartphone (→50)

2 Operate the smartphone

If the camera is already connected to the smartphone via Bluetooth, select [] → [Remote operation].

(iOS devices) When you need to change the connected device on the Wi-Fi setup screen, follow the on-screen message to change the setting.

① Select []

② Take pictures



- The recorded images are saved in the camera.
- Some settings are not available.

Using the smartphone to operate the shutter button via a Bluetooth connection only

Wireless connectivity required: **Bluetooth**

1 Make a Bluetooth connection to the smartphone (→51)

2 Operate the smartphone

① Select []

② Select [Shutter Remote Control]

③ Take pictures

- [Shutter Remote Control] is available only when the Camera [ON/OFF] switch is set to [ON].



Playing back or saving images stored on the camera

Wireless connectivity required: **Wi-Fi**

1 Connect to a smartphone (→50)

2 Operate the smartphone

If the camera is already connected to the smartphone via Bluetooth, select [] → [Remote operation].

(iOS devices) When you need to change the connected device on the Wi-Fi setup screen, follow the on-screen message to change the setting.

① Select []

- You can switch a device of pictures to be displayed using the icon at the top left on the screen. Select [LUMIX] to display a picture saved in the camera.

(Playing back a picture)

② When the picture is touched, it is played back at a larger size

(Saving pictures)

③ Press and hold the picture and drag it



Downloading software

Download and install software to edit and play back images with a PC.

- To download the software, your PC must be connected to the Internet.
- It may take time to download the software in some communication environments.

PHOTOfunSTUDIO 10.0 AE (Windows® 10 / 8.1)

You can capture still pictures or motion pictures to your PC, or organize captured pictures by categorizing by recording date, model name of the digital camera used to record, etc. You can also correct still pictures, edit motion pictures, or write to DVD.

The software is available for download until the end of August 2027.

https://panasonic.jp/support/global/cs/soft/download/d_pfs10ae.html

- For details about information such as the operating environment or operating method, refer to the “Owner’s manual for advanced features (PDF format)” or the operating instructions of “PHOTOfunSTUDIO” (PDF format).

SILKYPIX Developer Studio SE (Windows® 11 / 10 / 8.1, macOS 10.13 - macOS 10.15, macOS 11, macOS 12)

This software develops and edits RAW file pictures. Edited pictures can be saved in a file format such as JPEG or TIFF that can be displayed on a PC, etc.

<http://www.isi.co.jp/SILKYPIX/english/p/>

- For details on the operating environment and how to use the SILKYPIX Developer Studio, refer to the “Help” or the Ichikawa Soft Laboratory’s support website.

List of monitor/viewfinder displays

- The following images are examples of when the display screen is set to [] (monitor style) in the monitor.



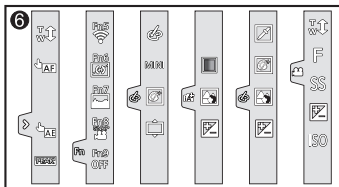
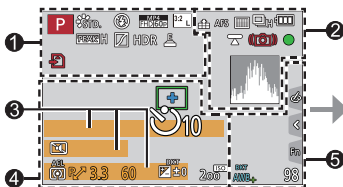















In recording



1	P	Recording mode (→21)
	C 1	Custom Set
	STD.	[Photo Style]
	Flash	Flash setting
	MP4 FHD/60p	[Rec Format]/ [Rec Quality]
	SNAP 4SEC	[Snap Movie]
	3:2 L	[Aspect Ratio]/ [Picture Size]
	STD.	Image size (Panorama Shot Mode)
	Filter+	Picture effect (Filter) adjustment display
	EXPS	Types of picture effects (Filter)
	Card	Card (displayed only during recording)

XXhXXmXXs	Elapsed recording time*1
Camera icon	Simultaneous recording indicator (When taking still pictures while recording a motion picture)
LVF/MON AUTO	Automatic switching between viewfinder and monitor (→20)
PEAK H	[Peaking]
Highlight Shadow icon	[Highlight Shadow]
HDR	[HDR]/[iHDR]
Multi Exp. icon	[Multi Exp.]
E	Electronic shutter
Overheat icon	Overheat indicator (→30, 34, 36)







2

	[Quality]
120fps	[High Speed Video]
AFS	[AFS/AFF/AFC]/MF
BKT AFS	Focus Bracket
	[AF Mode]
	[Pull Focus] ([Snap Movie])
	[Face Recog.]
AFL	AF Lock
	Burst
	[4K PHOTO] (→29)
	[Post Focus] (→33)
	[Self Timer]
	Battery indicator
AF 	Macro recording (→24)
	[Level Shot]
	[Stabilizer]
	Jitter alert
	Focus (Lights green.) (→22)/ Recording state (Flashes red.) (→36)
	Focus (Under low illumination)
	Focus (Starlight AF)
	Wi-Fi connection status
	Bluetooth connection status (→52)
GPS	Location Logging
	Histogram

3

	Name*2
	Travel elapsed days*3
	Age in years/months*2
	Location*3
	Current date/time*3
	Travel destination setting*3: 
	Exposure meter
	Zoom (→23)

4

	AF area
+	Spot metering target
+	[Center Marker]
	[Self Timer]
	[Zoom Mic]
	[Silent Mode]
AEL	AE Lock
	[Metering Mode]
	Program Shift
3.3	Aperture value
BKT 3.3	Aperture Bracket
60	Shutter speed
	Exposure compensation
	Exposure Bracket
	Brightness (exposure)
	Manual Exposure Assist
200 ^{ISO}	ISO sensitivity

5

	[Dial Guide]
AWBc	White Balance
BKT AWB+	White Balance Bracket
	White Balance Fine Adjustment
	Coloring
98	Number of recordable pictures
r20	Maximum number of pictures that can be taken continuously
RXXmXXs	Available recording time*1

6

Touch tab

	Touch zoom
	Touch Shutter
	Touch AF
	[Touch AE]
	[Peaking]

	Function buttons (→26)
	Coloring
	Defocus control function
	Brightness (exposure)
	Type of defocus ([Miniature Effect])
	[One Point Color]
	[Sunshine]
	Picture effect (Filter) adjustment display
	Picture effects ON or OFF
MINI	Picture effects (Filter)
F	Aperture value
SS	Shutter speed
ISO	ISO sensitivity

*1 [h], [m] and [s] indicate "hour", "minute" and "second".

*2 This is displayed for about 5 seconds when the camera is turned on if the [Profile Setup] setting is set.

*3 This is displayed for about 5 seconds when the camera is turned on, after setting the clock and after switching from Playback Mode to Recording mode.

- The information displayed, such as histograms, magnifications, and numeric values, are only for the purpose of reference.

Q&A Troubleshooting

- Performing [Reset] in the [Setup] menu may resolve the issue.
- Further information is provided in the “Owner’s manual for advanced features (PDF format)”. Check it together with the information in this section.

The charging lamp blinks.

- Charging is being performed in a place with extremely high or low temperature.
→ **Reconnect the USB connection cable (supplied) and retry charging in a place where ambient temperature is 10 °C to 30 °C (50 °F to 86 °F) (temperature conditions also apply to the battery itself).**
- Charging is not possible if the power supply capacity of the computer is low.

Focus not aligned correctly.

- Subject outside of focus range.
- [Focus/Release Priority] is set to [RELEASE]. (→46)
- [Shutter AF] is set to [OFF]. (→46)
- AF Lock is set inappropriately.
- If there are fingerprints or dirt on the lens, the focus may be set to the lens and not the subject.

Subject appears skewed in pictures.

- If you take a picture of a moving subject in the electronic shutter mode, motion picture recording mode, or 4K photo recording mode, the subject in the picture may be skewed in some cases. This is characteristic of MOS sensors which serve as the camera’s pickup sensors. This is not a malfunction.

No flash emitted.

- The flash becomes unavailable in the following cases.
 - The flash is closed.
 - Flash set to  (Forced Flash Off).
- Set [Shutter Type] to [AUTO] or [MSHTR]. (→45)
- Set [Silent Mode] to [OFF]. (→45)

Striping or flicker may appear under lighting such as fluorescent lighting and LED lighting fixture.

- This is characteristic of MOS sensors which serve as the camera's pickup sensors. This is not a malfunction.
- If you are taking still pictures using the electronic shutter, the striping may be reduced by setting a slower shutter speed.
- When noticeable flicker or striping is seen under lighting such as a fluorescent or LED lighting fixture in the motion picture recording mode, you can reduce the flicker or striping by setting up [Flkr Decrease] (→45) and fixing the shutter speed. It is possible to select a shutter speed from [1/50], [1/60], [1/100], or [1/120]. You can set the shutter speed manually in the Creative Video Mode. (→21)

A Wi-Fi connection cannot be established. Radio waves get disconnected.

- Use within the communication range of the wireless LAN network.
- If any device, such as microwave oven, cordless phone, etc., that uses 2.4 GHz frequency are used nearby this unit simultaneously, radio waves may get interrupted.
→ Use them sufficiently away from the device.
- When the battery indicator is flashing red, the connection with other equipment may not start or the connection may be disrupted. (A message such as [Communication error] is displayed.)
- When this unit is placed on a metal table or shelf, the connection may not be established easily because the camera is affected by radio waves. Use the camera away from metal surfaces.

The lens makes a clicking noise.

- When the camera is turned on or off, the lens is moved, or an aperture operation is performed, such a noise may be heard. This is not a malfunction.
- When the brightness changes after a zooming operation or moving the camera, the lens may make a noise while adjusting the aperture. This is not a malfunction.

Specifications

Digital Camera: Information for your safety

Power Source	DC 8.4 V (8.4 V ---)
Power Consumption	1.9 W (When recording with monitor) 2.8 W (When recording with viewfinder) 1.6 W (When playing back with monitor) 1.6 W (When playing back with viewfinder)
Camera effective pixels	20,100,000 pixels
Image sensor	1" MOS sensor, total pixel number 20,900,000 pixels Primary color filter
Lens	Optical 15x zoom f=8.8 mm to 132 mm (35 mm film camera equivalent: 24 mm to 360 mm) Max. Wide: F3.3 to F8.0 Max. Tele: F6.4 to F8.0
Image Stabilizer	Optical method
Focus range	AF: 50 cm (1.6 feet) (Max. Wide)/ 1 m (3.3 feet) (Max. Tele) to ∞ AF Macro/MF/Intelligent Auto/Motion picture: 3 cm (0.098 feet) (Max. Wide)/ 1 m (3.3 feet) (Max. Tele) to ∞
Shutter system	Electronic shutter + Mechanical shutter
Minimum Illumination	Approx. 10 lx (when i-Low light is used, the shutter speed is 1/30th of a second)

Shutter speed	<p>Still picture: [T] (Time) (Max. approx. 120 seconds)*, 60 seconds to 1/2000th of a second (When the mechanical shutter is used), 1 second to 1/16000th of a second (When the electronic shutter is used) * [B] (Bulb) recording is available when using [Shutter Remote Control] (via Bluetooth connection).</p> <p>Motion picture: 1/25th of a second to 1/16000th of a second (When [FHD/24M/24p] is set in [AVCHD], or [4K/100M/24p] is set in [MP4]), 1/2 second to 1/16000th of a second (When [Exposure Mode] is set to [M] in Creative Video Mode and [MF] is selected), 1/30th of a second to 1/16000th of a second (Other than the above)</p>
Exposure (AE)	<p>Program AE (P)/Aperture-priority AE (A)/ Shutter-priority AE (S)/Manual exposure (M) Exposure Compensation (1/3 EV steps, -5 EV to +5 EV)</p>
Metering Mode	Multiple/Center weighted/Spot
Monitor	<p>3.0" TFT LCD (3:2) (Approx. 1,843,200 dots) (field of view ratio about 100%) Touch screen</p>
Viewfinder	<p>0.21" Color LCD Live Viewfinder (3:2) (Approx. 2,330,000 dots equivalent) (field of view ratio about 100%) [Magnification approx. 1.45x, 0.53x (35 mm film camera equivalent), with 50 mm lens at infinity; -1.0 m⁻¹] (with diopter adjustment -4.0 to +3.0 diopter)</p>
Flash	<p>Built-in pop up flash AUTO, AUTO/Red-Eye Reduction, Forced ON, Forced ON/Red-Eye Reduction, Slow Sync., Slow Sync./Red-Eye Reduction, Forced OFF</p>

Microphones	Stereo
Speaker	Monaural
Recording media	SD Memory Card/SDHC Memory Card*/ SDXC Memory Card* * UHS-I UHS Speed Class 3
Recording file format	
Still picture	RAW/JPEG (based on Design rule for Camera File system, based on Exif 2.31 standard)
4K Photo	MP4 (H.264/MPEG-4 AVC, AAC (2ch))
Motion picture	AVCHD Progressive/AVCHD/MP4
Audio compression format	AVCHD: Dolby Audio™ (2 ch) MP4: AAC (2 ch)
Interface	
[HDMI]	Micro HDMI Type D
[USB/CHARGE]	USB 2.0 (High Speed)/USB 2.0 Micro-B
Dimensions	Approx. 111.2 mm (W) × 66.4 mm (H) × 45.2 mm (D) [4.38" (W) × 2.61" (H) × 1.78" (D)] (excluding the projection part)
Mass (weight)	With card and battery: Approx. 340 g (0.75 lb) Excluding card and battery: Approx. 298 g (0.66 lb)
Operating temperature	0 °C to 40 °C (32 °F to 104 °F)
Operating humidity	10%RH to 80%RH
Language select	[ENGLISH] / [DEUTSCH] / [FRANÇAIS] / [ESPAÑOL] / [PORTUGUÊS] / [ITALIANO] / [繁體中文] / [日本語]

■ Wireless transmitter

Wireless LAN

Compliance standard	IEEE 802.11b/g/n (standard wireless LAN protocol)
Frequency range used (central frequency)	2412 MHz to 2462 MHz (1 to 11 ch)
Encryption method	Wi-Fi compliant WPA™/WPA2™
Access method	Infrastructure mode

Bluetooth function

Compliance standard	Bluetooth Ver. 4.2 (Bluetooth low energy (BLE))
Frequency range used (central frequency)	2402 MHz to 2480 MHz

■ AC adaptor

(Panasonic SAE0012A): Information for your safety

Input:	110 V – 240 V ~ 50/60 Hz 0.2 A
Output:	5 V === 1.0 A

■ Battery pack (lithium-ion)

(Panasonic DMW-BLG10PP): Information for your safety

Voltage/capacity:	7.2 V/1025 mAh
--------------------------	----------------

The symbols on this product (including the accessories) represent the following:

~	AC
===	DC
	Class II equipment (The construction of the product is double-insulated.)

Specifications are subject to change without notice.

Digital Camera Accessory System

Description	Accessory#
Battery pack	DMW-BLG10
Battery charger	DMW-BTC12
AC adaptor*	DMW-AC10
DC coupler*	DMW-DCC11

* The AC adaptor (optional) can only be used with the designated Panasonic DC coupler (optional). The AC adaptor (optional) cannot be used by itself. When using an AC adaptor (optional), use the AC cable supplied with the AC adaptor.

- Part numbers are as of August 2022. These may be subject to change.
- Some optional accessories may not be available in some countries.
- (For U.S.A. only)
To order optional accessories please visit <http://shop.panasonic.com> or your local Photo Specialty Dealer.

This product incorporates the following software:

- (1) the software developed independently by or for Panasonic,
- (2) the software owned by third party and licensed to Panasonic,
- (3) the software licensed under the GNU General Public License, Version 2.0 (GPL V2.0),
- (4) the software licensed under the GNU LESSER General Public License, Version 2.1 (LGPL V2.1), and/or
- (5) open source software other than the software licensed under the GPL V2.0 and/or LGPL V2.1.

The software categorized as (3) - (5) are distributed in the hope that it will be useful, but WITHOUT ANY WARRANTY, without even the implied warranty of MERCHANTABILITY or FITNESS FOR A PARTICULAR PURPOSE. Please refer to the detailed terms and conditions thereof displayed by selecting [MENU/SET] → [Setup] → [Version Disp.] → [Software info]. At least three (3) years from delivery of this product, Panasonic will give to any third party who contacts us at the contact information provided below, for a charge no more than our cost of physically performing source code distribution, a complete machine-readable copy of the corresponding source code covered under GPL V2.0 or LGPL V2.1, as well as the respective copyright notice thereof.

Contact Information: oss-cd-request@gg.jp.panasonic.com

The source code and the copyright notice are also available for free in our website below.
<https://panasonic.net/cns/oss/index.html>

Reading the Owner's Manual (PDF format)

More detailed operating instructions are available in "Owner's Manual for advanced features (PDF format)". To read it, download it from the website.

<https://panasonic.jp/support/dsc/oi/TZ200D/index.html>



- Click the desired language.
- You will need Adobe Reader to browse or print the Owner's Manual (PDF format). You can download and install a version of Adobe Reader that you can use with your OS from the following website. (As of August 2022)
<http://www.adobe.com/products/acrobat/readstep2.html>

Limited Warranty (ONLY FOR U.S.A.)

Panasonic Products Limited Warranty

Limited Warranty Coverage (For USA Only)

If your product does not work properly because of a defect in materials or workmanship, Panasonic Corporation of North America (referred to as “the warrantor”) will, for the length of the period indicated on the chart below, which starts with the date of original purchase (“warranty period”), at its option either (a) repair your product with new or refurbished parts, (b) replace it with a new or a refurbished equivalent value product, or (c) refund your purchase price. The decision to repair, replace or refund will be made by the warrantor.

Product or Part Name	Parts	Labor
Digital Camera	1 Year	1 Year
All included Accessories (Except Non-Rechargeable Batteries)	90 Days	Not Applicable
Only Non-Rechargeable Batteries	10 Days	Not Applicable

During the “Labor” warranty period there will be no charge for labor. During the “Parts” warranty period, there will be no charge for parts. This Limited Warranty excludes both parts and labor for non-rechargeable batteries, antennas, and cosmetic parts (cabinet). This warranty only applies to products purchased and serviced in the United States. This warranty is extended only to the original purchaser of a new product which was not sold “as is”.

Mail-In Service--Online Repair Request

Online Repair Request

To submit a new repair request and for quick repair status visit our Web Site at <http://shop.panasonic.com/support>.

When shipping the unit, carefully pack, include all supplied accessories listed in the Owner's Manual, and send it prepaid, adequately insured and packed well in a carton box. When shipping Lithium Ion batteries please visit our Web Site at <http://shop.panasonic.com/support> as Panasonic is committed to providing the most up to date information. Include a letter detailing the complaint, a return address and provide a daytime phone number where you can be reached. A valid registered receipt is required under the Limited Warranty.

IF REPAIR IS NEEDED DURING THE WARRANTY PERIOD, THE PURCHASER WILL BE REQUIRED TO FURNISH A SALES RECEIPT/PROOF OF PURCHASE INDICATING DATE OF PURCHASE, AMOUNT PAID AND PLACE OF PURCHASE. CUSTOMER WILL BE CHARGED FOR THE REPAIR OF ANY UNIT RECEIVED WITHOUT SUCH PROOF OF PURCHASE.

Limited Warranty Limits and Exclusions

This warranty ONLY COVERS failures due to defects in materials or workmanship, and DOES NOT COVER normal wear and tear or cosmetic damage. The warranty ALSO DOES NOT COVER damages which occurred in shipment, or failures which are caused by products not supplied by the warrantor, or failures which result from accidents, misuse, abuse, neglect, mishandling, misapplication, alteration, faulty installation, set-up adjustments, misadjustment of consumer controls, improper maintenance, power line surge, lightning damage, modification, introduction of sand, humidity or liquids, or rental use of the product, or service by anyone other than a Factory Service Center or other Authorized Servicer, or damage that is attributable to acts of God.

THERE ARE NO EXPRESS WARRANTIES EXCEPT AS LISTED UNDER “LIMITED WARRANTY COVERAGE”.

THE WARRANTOR IS NOT LIABLE FOR INCIDENTAL OR CONSEQUENTIAL DAMAGES RESULTING FROM THE USE OF THIS PRODUCT, OR ARISING OUT OF ANY BREACH OF THIS WARRANTY.

(As examples, this excludes damages for lost time, travel to and from the servicer, loss of or damage to media or images, data or other memory or recorded content. The items listed are not exclusive, but for illustration only.)

ALL EXPRESS AND IMPLIED WARRANTIES, INCLUDING THE WARRANTY OF MERCHANTABILITY, ARE LIMITED TO THE PERIOD OF THE LIMITED WARRANTY.

Some states do not allow the exclusion or limitation of incidental or consequential damages, or limitations on how long an implied warranty lasts, so the exclusions may not apply to you.

This warranty gives you specific legal rights and you may also have other rights which vary from state to state. If a problem with this product develops during or after the warranty period, you may contact your dealer or Service Center. If the problem is not handled to your satisfaction, then write to:

Panasonic Corporation of North America
Consumer Affairs Department 8th Fl.
Two Riverfront Plaza
Newark NJ 07102-5490

PARTS AND SERVICE, WHICH ARE NOT COVERED BY THIS LIMITED WARRANTY, ARE YOUR RESPONSIBILITY.

Product registration is not mandatory. Failure to complete the form does not affect the consumer's warranty rights.

Shop **Accessories!**

for all your Panasonic gear

Go to

<http://shop.panasonic.com/support>

Get everything you need to get the most out of your Panasonic products
Accessories & Parts for your Camera, Phone, A/V products, TV,
Computers & Networking, Personal Care, Home Appliances, Headphones,
Batteries, Backup Chargers & more...

Customer Services Directory

For Product Information, Operating Assistance, Parts, Owner's Manuals,
Dealer and Service info go to <http://shop.panasonic.com/support>

For the hearing or speech impaired TTY: 1- 877-833-8855

As of November 2021

Limited Warranty (ONLY FOR CANADA)

Panasonic Canada Inc.

5770 Ambler Drive, Mississauga, Ontario L4W 2T3

PANASONIC PRODUCT – LIMITED WARRANTY

Panasonic Canada Inc. warrants this product to be free from defects in material and workmanship under normal use and for a period as stated below from the date of original purchase agrees to, at its option either (a) repair your product with new or refurbished parts, (b) replace it with a new or a refurbished equivalent value product, or (c) refund your purchase price. The decision to repair, replace or refund will be made by Panasonic Canada Inc.

Digital Camera	One (1) year, parts and labour
Digital Camera Peripherals	One (1) year, parts and labour
Digital Camera Accessories	Ninety (90) days, parts and labour

This warranty is given only to the original purchaser, or the person for whom it was purchased as a gift, of a Panasonic brand product mentioned above sold by an authorized Panasonic dealer in Canada and purchased and used in Canada, which product was not sold “as is”, and which product was delivered to you in new condition in the original packaging.

**IN ORDER TO BE ELIGIBLE TO RECEIVE WARRANTY SERVICE
HEREUNDER, A PURCHASE RECEIPT OR OTHER PROOF OF DATE
OF ORIGINAL PURCHASE, SHOWING AMOUNT PAID AND PLACE OF
PURCHASE IS REQUIRED**

LIMITATIONS AND EXCLUSIONS

This warranty **ONLY COVERS** failures due to defects in materials or workmanship, and **DOES NOT COVER** normal wear and tear or cosmetic damage. The warranty **ALSO DOES NOT COVER** damages which occurred in shipment, or failures which are caused by products not supplied by Panasonic Canada Inc., or failures which result from accidents, misuse, abuse, neglect, mishandling, misapplication, alteration, faulty installation, set-up adjustments, misadjustment of consumer controls, improper maintenance, improper batteries, power line surge, lightning damage, modification, introduction of sand, humidity or liquids, or rental use of the product, or service by anyone other than a Authorized Servicer, or damage that is attributable to acts of God.

Dry cell batteries, printer ink cartridge and paper are also excluded from coverage under this warranty.

Rechargeable batteries are warranted for ninety (90) days from date of original purchase.

THIS EXPRESS, LIMITED WARRANTY IS IN LIEU OF ALL OTHER WARRANTIES, EXPRESS OR IMPLIED, INCLUDING ANY IMPLIED WARRANTIES OF MERCHANTABILITY AND FITNESS FOR A PARTICULAR PURPOSE. IN NO EVENT WILL PANASONIC CANADA INC. BE LIABLE FOR ANY SPECIAL, INDIRECT OR CONSEQUENTIAL DAMAGES RESULTING FROM THE USE OF THIS PRODUCT OR ARISING OUT OF ANY BREACH OF ANY EXPRESS OR IMPLIED WARRANTY. (As examples, this warranty excludes damages for lost time, travel to and from the Authorized Servicer, loss of or damage to media or images, data or other memory or recorded content. This list of items is not exhaustive, but for illustration only.)

In certain instances, some jurisdictions do not allow the exclusion or limitation of incidental or consequential damages, or the exclusion of implied warranties, so the above limitations and exclusions may not be applicable. This warranty gives you specific legal rights and you may have other rights which vary depending on your province or territory.

WARRANTY SERVICE

For product operation, repairs and information assistance, please visit our Support page:

www.panasonic.ca/english/support

- SDXC Logo is a trademark of SD-3C, LLC.
- The terms HDMI and HDMI High-Definition Multimedia Interface, and the HDMI Logo are trademarks or registered trademarks of HDMI Licensing Administrator, Inc. in the United States and other countries.
- HDAVI Control™ is a trademark of Panasonic Holdings Corporation.
- “AVCHD”, “AVCHD Progressive” and the “AVCHD Progressive” logo are trademarks of Panasonic Holdings Corporation and Sony Corporation.
- Manufactured under license from Dolby Laboratories. Dolby, Dolby Audio, and the double-D symbol are trademarks of Dolby Laboratories Licensing Corporation.
- Adobe is a trademark or registered trademark of Adobe Systems Incorporated in the United States and/or other countries.
- Pentium is a trademark of Intel Corporation in the U.S. and/or other countries.
- Windows is either registered trademark or trademark of Microsoft Corporation in the United States and/or other countries.
- iMovie, Mac, OS X and macOS are trademarks of Apple Inc., registered in the U.S. and other countries.
- iPad, iPhone, iPod, and iPod touch are trademarks of Apple Inc., registered in the U.S. and other countries.
- App Store is a service mark of Apple Inc.
- Google, Android and Google Play are trademarks of Google LLC.
- The Bluetooth® word mark and logos are registered trademarks owned by Bluetooth SIG, Inc. and any use of such marks by Panasonic Holdings Corporation is under license. Other trademarks and trade names are those of their respective owners.
- The Wi-Fi CERTIFIED™ Logo is a registered trademark of Wi-Fi Alliance®.
- The Wi-Fi Protected Setup™ Logo is a registered trademark of Wi-Fi Alliance®.
- “Wi-Fi®” is a registered trademark of Wi-Fi Alliance®.
- “Wi-Fi Protected Setup™”, “WPA™”, and “WPA2™” are trademarks of Wi-Fi Alliance®.
- QR Code is a registered trademark of DENSO WAVE INCORPORATED.
- This product uses “DynaFont” from DynaComware Corporation. DynaFont is a registered trademark of DynaComware Taiwan Inc.
- Other names, company names, and product names mentioned in these instructions are trademarks or registered trademarks of the companies concerned.



Panasonic Corporation of North America

Two Riverfront Plaza, Newark, NJ 07102-5490

<http://shop.panasonic.com>

Panasonic Canada Inc.

5770 Ambler Drive

Mississauga, Ontario

L4W 2T3

www.panasonic.com

© Panasonic Entertainment & Communication Co., Ltd. 2022

Printed in China