

Operating Instructions  
High Definition Plasma Television  
Manual de instrucciones  
Televisor de plasma de alta definición



Model No. **TH-42PX75U**  
Número de modelo **TH-50PX75U**

## Quick Start Guide

(See page 6)

## Guía de inicio rápido

(vea la página 6)

### Customer's Record

The model number and serial number of this product can be found on its back cover. You should note this serial number in the space provided below and retain this book, plus your purchase receipt, as a permanent record of your purchase to aid in identification in the event of theft or loss, and for Warranty Service purposes.

Model Number \_\_\_\_\_ Serial Number \_\_\_\_\_

### Anotación del cliente

El modelo y el número de serie de este producto se encuentran en su panel posterior. Deberá anotarlos en el espacio provisto a continuación y guardar este manual, más el recibo de su compra, como prueba permanente de su adquisición, para que le sirva de ayuda al identificarlo en el caso de que le sea sustraído o lo pierda, y también para disponer de los servicios que le ofrece la garantía.

Modelo \_\_\_\_\_ Número de serie \_\_\_\_\_

- For assistance (U.S.A.), please call:  
**1-888-VIEW-PTV (843-9788)**  
or visit us at [www.panasonic.com/contactinfo](http://www.panasonic.com/contactinfo)
- For assistance (Puerto Rico), please call:  
**787-750-4300**  
or visit us at [www.panasonic.com](http://www.panasonic.com)
- For assistance (Canada), please call:  
**1-800-561-5505**  
or visit us at [www.panasonic.ca](http://www.panasonic.ca)

- Para solicitar ayuda (EE.UU.), llame al:  
**1-888-VIEW-PTV (843-9788)**  
ó visítenos en [www.panasonic.com/contactinfo](http://www.panasonic.com/contactinfo)
- Para solicitar ayuda (Puerto Rico), llame al:  
**787-750-4300**  
ó visítenos en [www.panasonic.com](http://www.panasonic.com)



**Panasonic Consumer Electronics Company,**  
**Division of Panasonic Corporation of North America**  
One Panasonic Way, Secaucus  
New Jersey 07094 U.S.A.

**Panasonic Puerto Rico, Inc.**  
Ave. 65 de Infantería, Km. 9.5  
San Gabriel Industrial Park  
Carolina, Puerto Rico 00985

**Panasonic Canada Inc.**  
5770 Ambler Drive  
Mississauga, Ontario  
L4W 2T3 CANADA



**English**

Please read these instructions before operating your set and retain them for future reference. The images shown in this manual are for illustrative purposes only.

**Español**

Lea estas instrucciones antes de utilizar su televisor y guárdelas para consultarlas en el futuro. Las imágenes mostradas en este manual tienen solamente fines ilustrativos.

Turn your own living room into a movie theater!  
Experience an amazing level of multimedia excitement



# Contents

Please read before using the unit

- Safety Precautions..... 4
- Notes..... 5

## Quick Start Guide

- Accessories/Optional Accessory ... 6
- To Prevent TV from falling over ... 8
- Before Connection ..... 10
- Basic Connection ..... 11
- Identifying Controls ..... 17
- First Time Setup ..... 18

## Enjoy your TV!

### Basic Features



- Watching TV..... 20
- Viewing from SD Card ..... 22
- Watching Videos and DVDs..... 24



## Advanced Features

- How to Use Menu Functions  
(picture, sound quality, etc.)..... 26
- EZ Sync™ "HDAVI Control™"..... 30
- Lock ..... 32
- Editing and Setting Channels ..... 34
- Input Labels/Monitor out/Closed Caption..... 36
- Using Timer ..... 38
- Recommended AV Connections ..... 40

## FAQs, etc.

- Ratings List for Lock ..... 42
- Technical Information ..... 43
- Maintenance ..... 46
- Specifications..... 47
- FAQ ..... 48
- Limited Warranty (for U.S.A.)..... 50
- Customer Services Directory (for U. S. A.)..... 51
- Limited Warranty (for Canada)..... 52

 SDHC Logo is a trademark.	 GalleryPlayer and the GalleryPlayer Logo are trademarks of GalleryPlayer, Inc.	<p align="center"><b>EZ Sync™</b></p> <p align="center">EZ Sync™ is a trademark of Matsushita Electric Industrial Co., Ltd.</p>
<p align="center"><b>HDMI™</b> HIGH-DEFINITION MULTIMEDIA INTERFACE</p> <p>HDMI, the HDMI logo and High-Definition Multimedia Interface are trademarks or registered trademarks of HDMI Licensing LLC.</p>		<p align="center"><b>HDAVI Control™</b></p> <p align="center">HDAVI Control™ is a trademark of Matsushita Electric Industrial Co., Ltd.</p>

	
<p align="center">Manufactured under license from Dolby Laboratories. DOLBY and the double-D symbol are trademarks of Dolby Laboratories.</p>	



# Safety Precautions

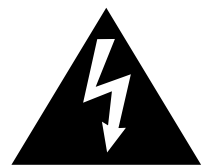

**CAUTION**  
**RISK OF ELECTRIC SHOCK**  
**DO NOT OPEN**



The lightning flash with arrowhead within a triangle is intended to tell the user that parts inside the product are a risk of electric shock to persons.



The exclamation point within a triangle is intended to tell the user that important operating and servicing instructions are in the papers with the appliance.

**WARNING:** To reduce the risk of electric shock, do not remove cover or back. No user-serviceable parts inside. Refer servicing to qualified service personnel.

**WARNING:** To reduce the risk of fire or electric shock, do not expose this apparatus to rain or moisture. Do not place liquid containers (flower vase, cups, cosmetics, etc.) above the set (including on shelves above, etc.).

## Important Safety Instructions

- 1) Read these instructions.
- 2) Keep these instructions.
- 3) Heed all warnings.
- 4) Follow all instructions.
- 5) Do not use this apparatus near water.
- 6) Clean only with dry cloth.
- 7) Do not block any ventilation openings. Install in accordance with the manufacturer's instructions.
- 8) Do not install near any heat sources such as radiators, heat registers, stoves, or other apparatus (including amplifiers) that produce heat.
- 9) Do not defeat the safety purpose of the polarized or grounding-type plug. A polarized plug has two blades with one wider than the other. A grounding type plug has two blades and a third grounding prong. The wide blade or the third prong are provided for your safety. If the provided plug does not fit into your outlet, consult an electrician for replacement of the obsolete outlet.
- 10) Protect the power cord from being walked on or pinched particularly at plugs, convenience receptacles, and the point where they exit from the apparatus.
- 11) Only use attachments / accessories specified by the manufacturer.
- 12) Use only with the cart, stand, tripod, bracket, or table specified by the manufacturer, or sold with the apparatus. When a cart is used, use caution when moving the cart / apparatus combination to avoid injury from tip-over.
- 13) Unplug this apparatus during lightning storms or when unused for long periods of time.
- 14) Refer all servicing to qualified service personnel. Servicing is required when the apparatus has been damaged in any way, such as power-supply cord or plug is damaged, liquid has been spilled or objects have fallen into the apparatus, the apparatus has been exposed to rain or moisture, does not operate normally, or has been dropped.
- 15) To prevent electric shock, ensure the grounding pin on the AC cord power plug is securely connected.



## FCC STATEMENT

This equipment has been tested and found to comply with the limits for an Other Class B digital device, pursuant to Part 15 of the FCC Rules. These limits are designed to provide reasonable protection against harmful interference in a residential installation. This equipment generates, uses and can radiate radio frequency energy and, if not installed and used in accordance with the instructions, may cause harmful interference to radio communications. However, there is no guarantee that interference will not occur in a particular installation. If this equipment does cause harmful interference to radio or television reception, which can be determined by turning the equipment off and on, the user is encouraged to try to correct the interference by one or more of the following measures:

- Reorient or relocate the receiving antenna.
- Increase the separation between the equipment and receiver.
- Connect the equipment into an outlet on a circuit different from that to which the receiver is connected.
- Consult the Panasonic Service Center or an experienced radio/TV technician for help.

### FCC Caution:

To assure continued compliance, use only shielded interface cables when connecting TV to peripheral devices. Any changes or modifications not expressly approved by responsible party may cause harmful interference and could void the user's authority to operate this device.

Responsible Party: Panasonic Corporation of North America  
One Panasonic Way, Secaucus, NJ 07094  
Contact Source: Panasonic Consumer Electronics Company  
1-888-VIEW-PTV (843-9788)  
email: consumerproducts@panasonic.com

### CANADIAN NOTICE:

For Model TH-42PX75U, TH-50PX75U  
This Class B digital apparatus complies with Canadian ICES-003.

## WARNING/CAUTION

### WARNING

**SMALL PARTS CAN PRESENT CHOKING HAZARD IF ACCIDENTALLY SWALLOWED. KEEP SMALL PARTS AWAY FROM YOUNG CHILDREN. DISCARD UNNEEDED SMALL PARTS AND OTHER OBJECTS, INCLUDING PACKAGING MATERIALS AND PLASTIC BAGS/SHEETS TO PREVENT THEM FROM BEING PLAYED WITH BY YOUNG CHILDREN, CREATING THE POTENTIAL RISK OF SUFFOCATION.**

### Set up

- Do not place the Plasma TV on sloped or unstable surfaces.
- The Plasma TV may fall off or tip over.
- Do not place any objects on top of the Plasma TV.
- If water spills onto the Plasma TV or foreign objects get inside it, a short-circuit may occur which could result in fire or electric shock. If any foreign objects get inside the Plasma TV, please consult an Authorized Service Center.

This Plasma TV is for use only with the following optional accessories. Use with any other type of optional accessories may cause instability which could result in the possibility of injury.

(All of the following accessories are manufactured by Matsushita Electric Industrial Co., Ltd.)

- Wall-hanging bracket (Vertical) TY-WK42PV3U
- Wall-hanging bracket (Angled) TY-WK42PR2U  
TY-WK42PR3U

### Always be sure to ask a qualified technician to carry out set-up.

- Two or more people are required to install and remove the television. If two people are not present, the television may be dropped, and personal injury may result.
- Transporting the unit with its display panel facing upright or downward may cause damage to the internal circuitry.

### AC Power Supply Cord

The Plasma TV is designed to operate on 120 V AC, 60 Hz. Securely insert the power cord plug as far as it will go.

- If the plug is not fully inserted, heat may be generated which could cause fire. If the plug is damaged or the wall socket plate is loose, they should not be used.
- The included power cord is for use with this unit only. Do not use any power cord other than that provided with this TV.
- Doing so may cause fire or electric shocks.
- Do not handle the power cord plug with wet hands.
- Doing so may cause electric shocks.
- Do not do anything that might damage the power cable. When disconnecting the power cable, hold the plug, not the cable.
- Do not make any modifications to, place heavy objects on, place near hot objects, heat, bend, twist or forcefully pull the power cable. Doing so may cause damage to the power cable which can cause fire or electric shock. If damage to the cable is suspected, have it repaired at an Authorized Service Center.

### If problems occur during use

If a problem occurs (such as no picture or no sound), or if smoke or an abnormal odor is detected from the Plasma TV, unplug the power cord immediately.

- Continued use of the TV under these conditions might cause fire or permanent damage to the unit. Have the TV evaluated at an Authorized Service Center. Servicing of the TV by any unauthorized personnel is strongly discouraged due to its high voltage dangerous nature.

If water or foreign objects get inside the Plasma TV, if the Plasma TV is dropped, or if the cabinet becomes damaged, disconnect the power cord plug immediately.

- A short may occur, which could cause fire. Contact an Authorized Service Center for any repairs that need to be made.

### CAUTION

Do not cover the ventilation holes.

- Doing so may cause the Plasma TV to overheat, which can cause fire or damage to the Plasma TV.

If using the pedestal, leave a space of 3 15/16" (10 cm) or more at the top, left and right, 2 3/8" (6 cm) or more at the bottom, and 2 3/4" (7 cm) or more at the rear.

### When using the Plasma TV

Be sure to disconnect all cables before moving the Plasma TV.

- Moving the TV with its cables attached might damage the cables which, in turn, can cause fire or electric shock.

Disconnect the power plug from the wall outlet as a safety precaution before carrying out any cleaning.

- Electric shocks can result if this is not done.

Clean the power cable regularly to prevent it from becoming dusty.

- Built-up dust on the power cord plug can increase humidity which might damage the insulation and cause fire. Unplug the cord from the wall outlet and clean it with a dry cloth.

This Plasma TV radiates infrared rays; therefore, it may affect other infrared communication equipment.

Install your infrared sensor in a place away from direct or reflected light from your Plasma TV.

Do not climb up onto the television or use it as a step. (Young children should be made particularly aware of this caution.)

- If the unit falls over or becomes damaged through misuse, injury may result.

The TV will still consume some power as long as the power cord is inserted into the wall outlet.

# Notes

### Do not display a still picture for a long time

This causes the image to remain on the plasma screen ("Image retention"). This is not considered a malfunction and is not covered by the warranty.



To prevent "Image retention", the screen saver is automatically activated after a few minutes if no signals are sent or no operations are performed. (p. 49)

### Typical still images

- Channel number and other logos
- Image displayed in 4:3 mode
- SD Card photo
- Video game
- Computer image

### Setup

- Do not place the unit where it's exposed to sunlight or other bright light (including reflections).
- Use of some types of fluorescent lighting may reduce the remote control's transmission range.

# Accessories/Optional Accessory

✓ Check you have all the items shown.

## Accessories

- Remote Control Transmitter  
● N2QAYB000103
- Batteries for the Remote Control Transmitter (2)  
● AA Battery
- Antenna Adapter  
● F-Type for 5C-2V
- Cable clamer (2)
- AC cord
- Pedestal  
● TBL2AX00161 (TH-42PX75U)  
● TBL2AX00171 (TH-50PX75U)
- Operating Instructions
- Product Registration Card (U.S.A.)
- Quick Setup Guide (For viewing HD programming)
- Customer Care Plan Card (U.S.A.)

## Installing remote's batteries

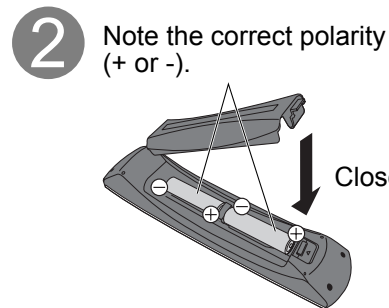
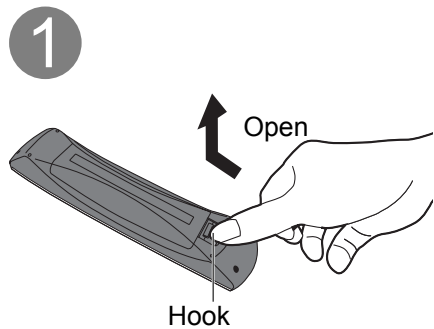

### Caution

- Incorrect installation may cause battery leakage and corrosion, resulting in damage to the remote control.
- Do not mix old and new batteries.
- Do not mix different battery types (such as alkaline and manganese batteries).
- Do not use rechargeable (Ni-Cd) batteries.
- Do not burn or break batteries.

## Optional Accessory

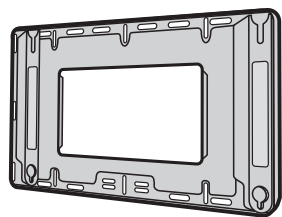

**Wall-hanging bracket**  
(vertical)  
● TY-WK42PV3U

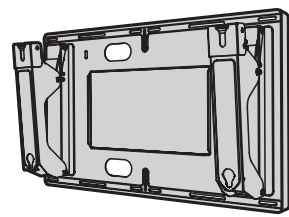

(angle)  
● TY-WK42PR2U  
● TY-WK42PR3U

### Note

- In order to maintain the TV's performance and safety, be absolutely sure to ask your dealer or a licensed contractor to secure the wall-hanging brackets.
- Carefully read the instructions accompanying the plasma TV stand or pedestal, and be absolutely sure to take steps to prevent the TV from tipping over.
- Handle the TV carefully during installation since subjecting it to impact or other forces may cause its paneling to crack.

## Attaching the pedestal to TV

### Assembling the pedestal

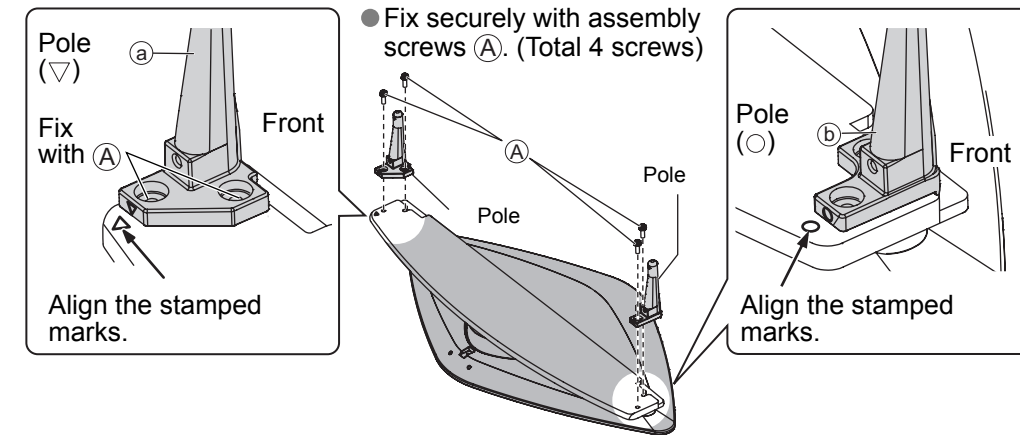

### Set-up

- Carry out work on a horizontal and level surface.

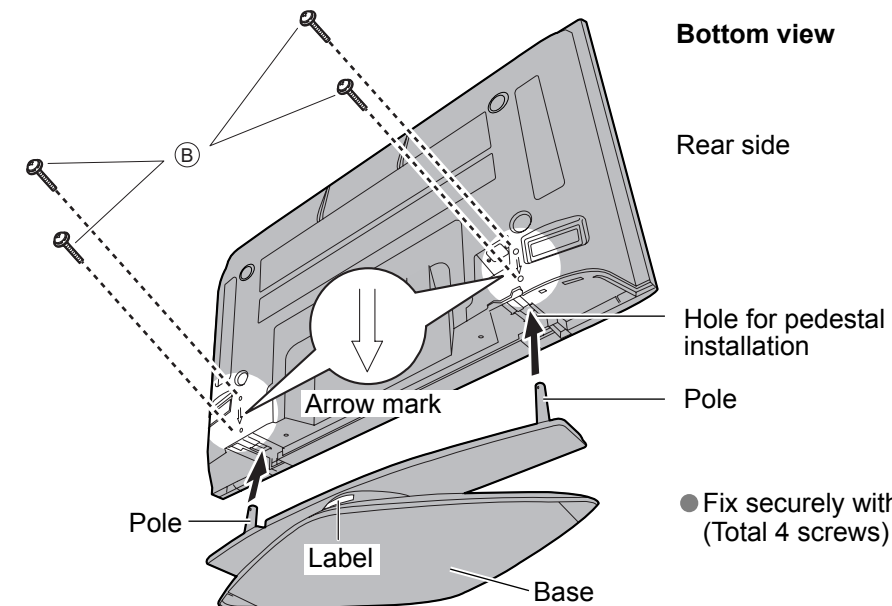

## Accessories

Assembly screw  
(4 of each)

(A) M5 x 16

(B) M5 x 30

Pole (2)

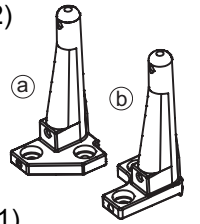

Base (1)

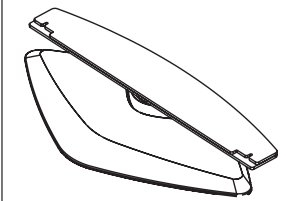

### Warning

**Do not disassemble or modify the pedestal.**

- Otherwise the TV may fall over and become damaged, and personal injury may result.

### Caution

**Do not use any television or displays other than those given in this Operating Instructions.**

- Otherwise the TV may fall over and become damaged, and personal injury may result.

**Do not use the pedestal if it becomes warped or physically damaged.**

- If you use the pedestal while it is physically damaged, personal injury may result. Contact your nearest Panasonic Dealer immediately.

**During set-up, make sure that all screws are securely tightened.**

- If sufficient care is not taken to ensure screws are properly tightened during assembly, the pedestal will not be strong enough to support the TV, and it might fall over and become damaged, and personal injury may result.

**Use the accessory fall-prevention brackets to secure the TV.**

- If the TV is knocked or children climb onto the pedestal with the TV installed, the TV may fall over and personal injury may result.



# To Prevent TV from falling over

- The TV must be fastened to both a base and a wall.

## Securing to a base

- Fix pedestal and base together with band.

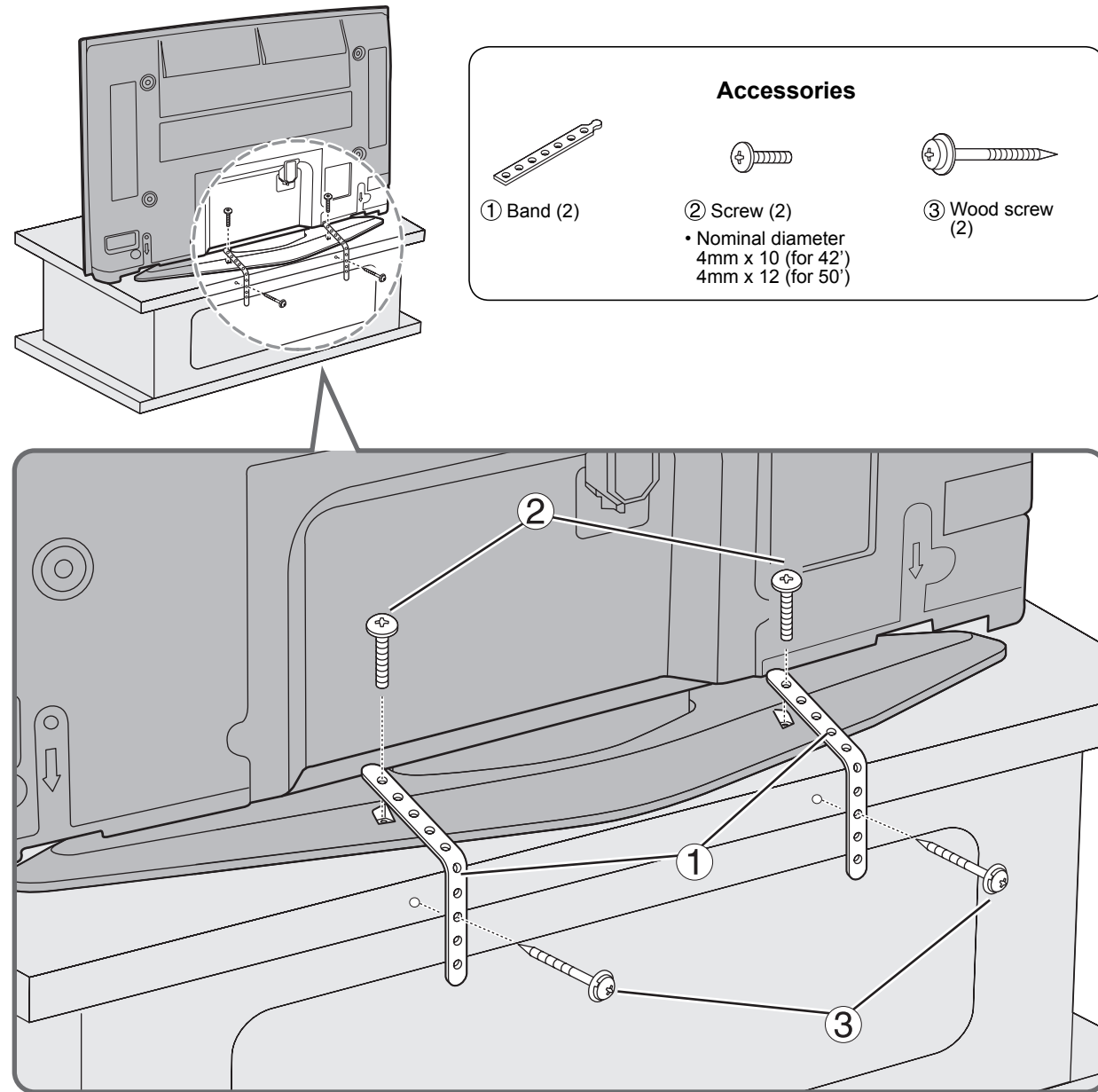

## Securing to a wall

- Fix to wall or post with strong commercial wire or chain.

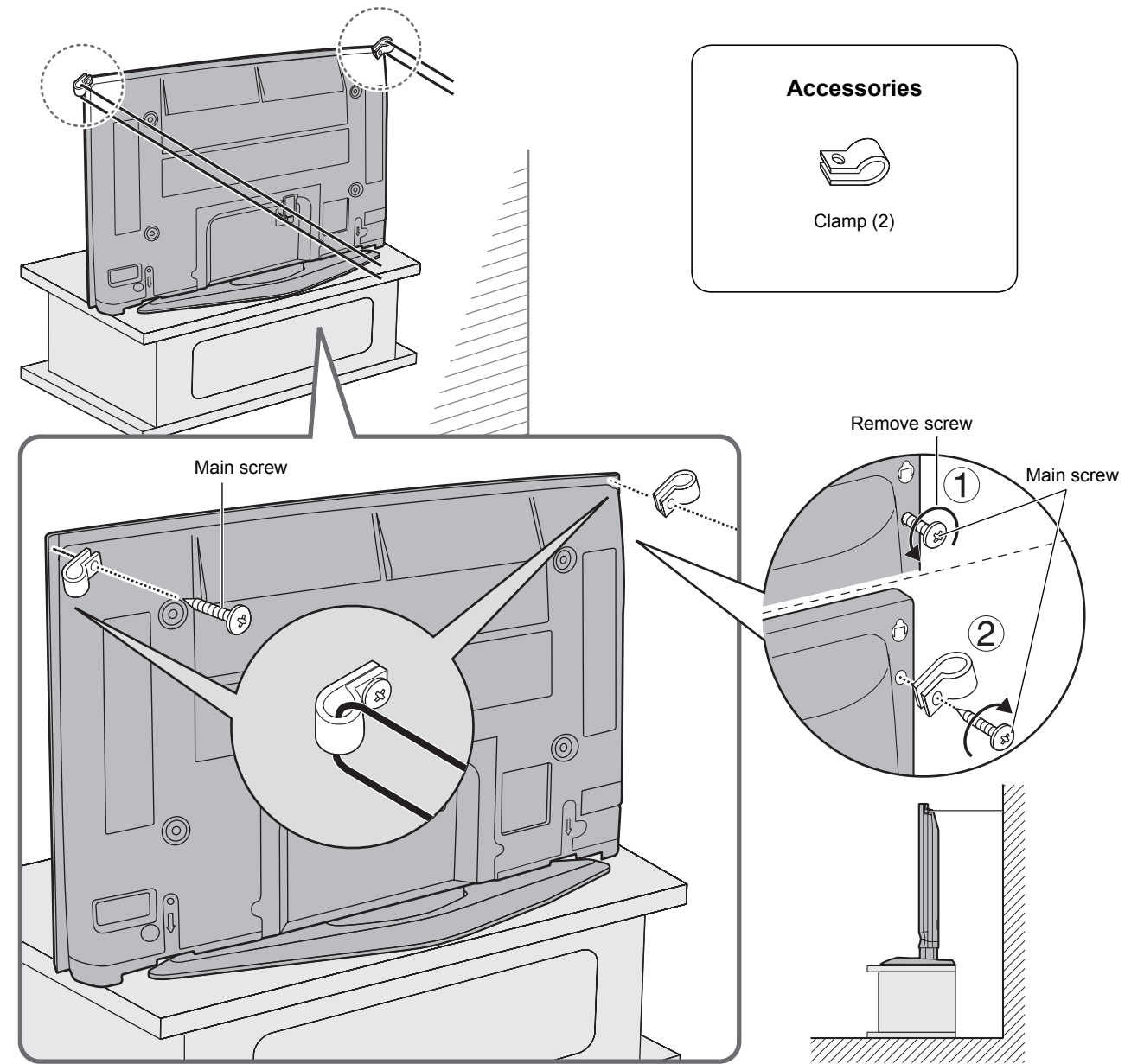

# Before Connection

## Connected Equipment Introduction (Signal source)

### ■ Watching TV

- VHF/UHF Antenna
  - NTSC (National Television System Committee): Conventional broadcasting
  - ATSC (Advanced Television Systems Committee): Digital TV Standards include digital high-definition television (HDTV), standard-definition television (SDTV), data broadcasting, multi-channel surround-sound audio and interactive television.
- Cable Box/Cable
  - You need to subscribe to a cable TV service to enjoy viewing their programming.
  - You can enjoy high-definition programming by subscribing to a high-definition cable box. The connection can be done with the use of HDMI or Component Video cable.

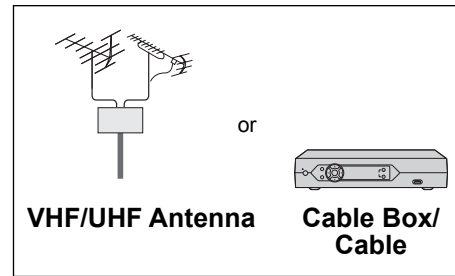

### ■ Recording/playing back with DVD recorder or VCR

- DVD Recorder
  - This source has higher resolution through interlace or progressive signal. Connection can be done with the use of Component Video or HDMI cable.
- VCR
  - Connection can be done with the use of an RF cable and Composite Video/S Video cable.

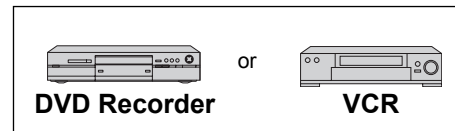

### ■ Watching Satellite

- You can enjoy high-definition programming by subscribing to high-definition satellite source. Connection can be done with the use of HDMI or Component Video cable.

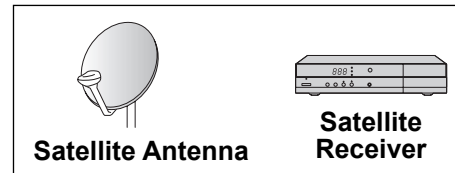

### ■ Enjoying Home theater and DVD recorder with HDMI connection

- Home theater and DVD Recorder
  - HDMI connection enables you to enjoy higher quality audio and video with a single cable.

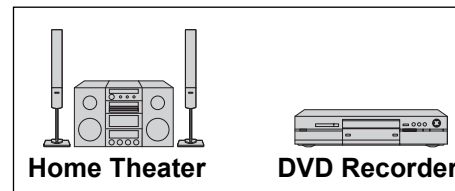

#### Note

- If your Panasonic DVD Recorder is compatible with EZ Sync (HDAVI control 2), you can operate your Panasonic DVD Recorder with this TV's remote control (p. 25 EZ Sync™).
- All cables and external equipment shown in this book are not supplied with the TV.
- For the details of the external equipment's connections, please refer to the operating manuals of the equipment.

## Reference of connection

### ■ Antenna terminal

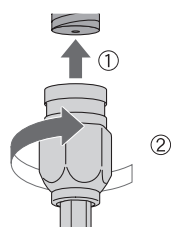

- Firmly tighten by hand.

### ■ Pin terminals

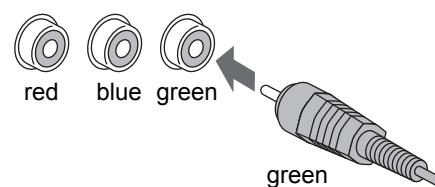

- Match colors of plugs and terminals.
- Insert firmly.

### ■ HDMI terminal

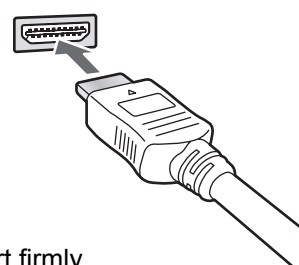

- Insert firmly.

# Basic Connection

## Example 1

## Connecting Antenna (To watch TV)

TV

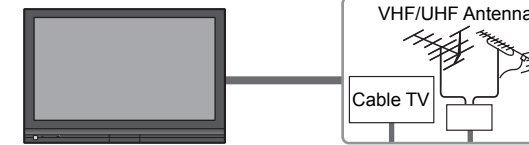

## To connect antenna terminals

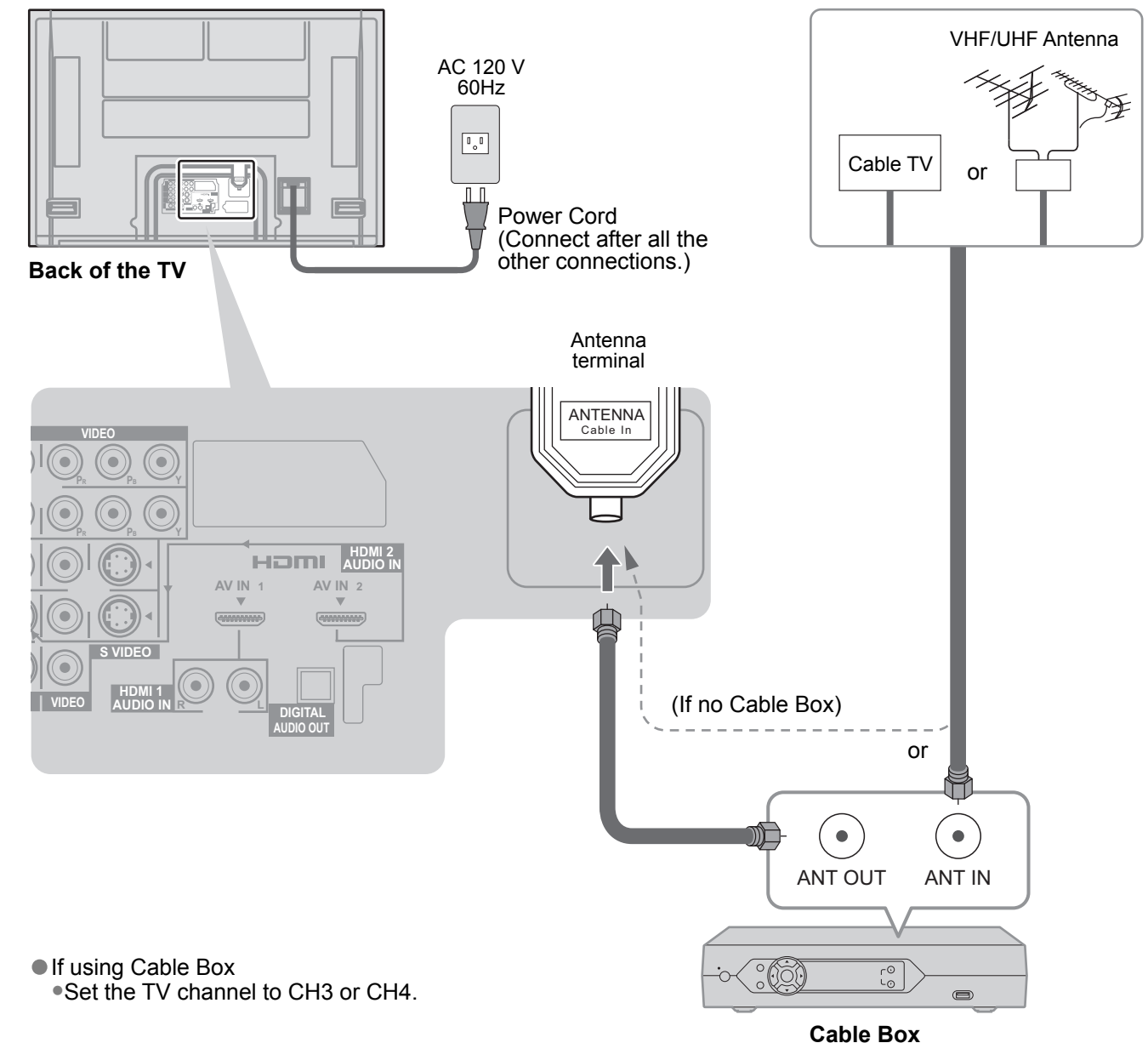

- If using Cable Box
  - Set the TV channel to CH3 or CH4.

#### Note

- When disconnecting the power cord, be absolutely sure to disconnect the power cord plug at the wall outlet first.
- For additional assistance, visit us at: [www.panasonic.com](http://www.panasonic.com)  
[www.panasonic.ca](http://www.panasonic.ca)



# Basic Connection (Continued)

## Example 2 Connecting DVD recorder (VCR) (To record/playback)

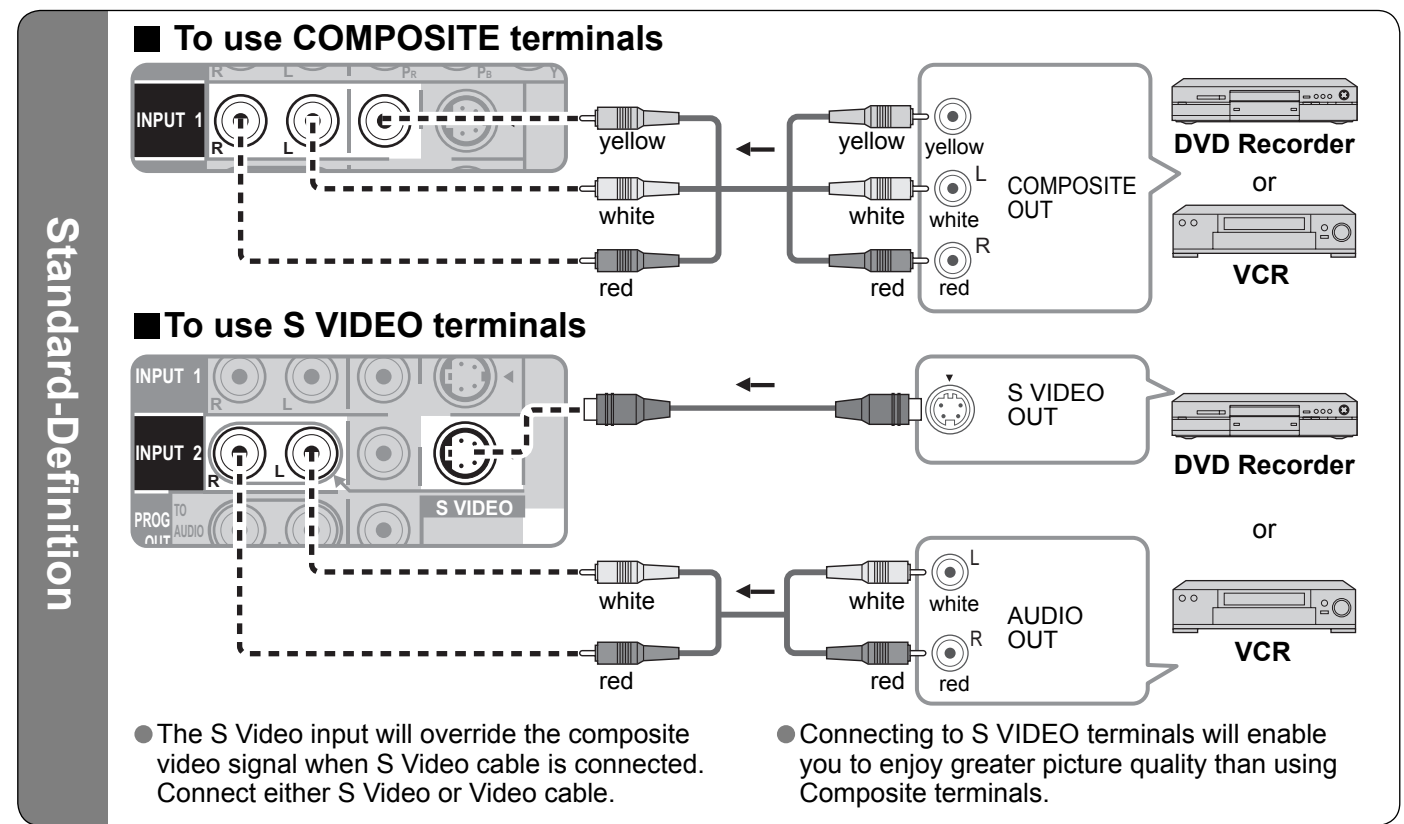
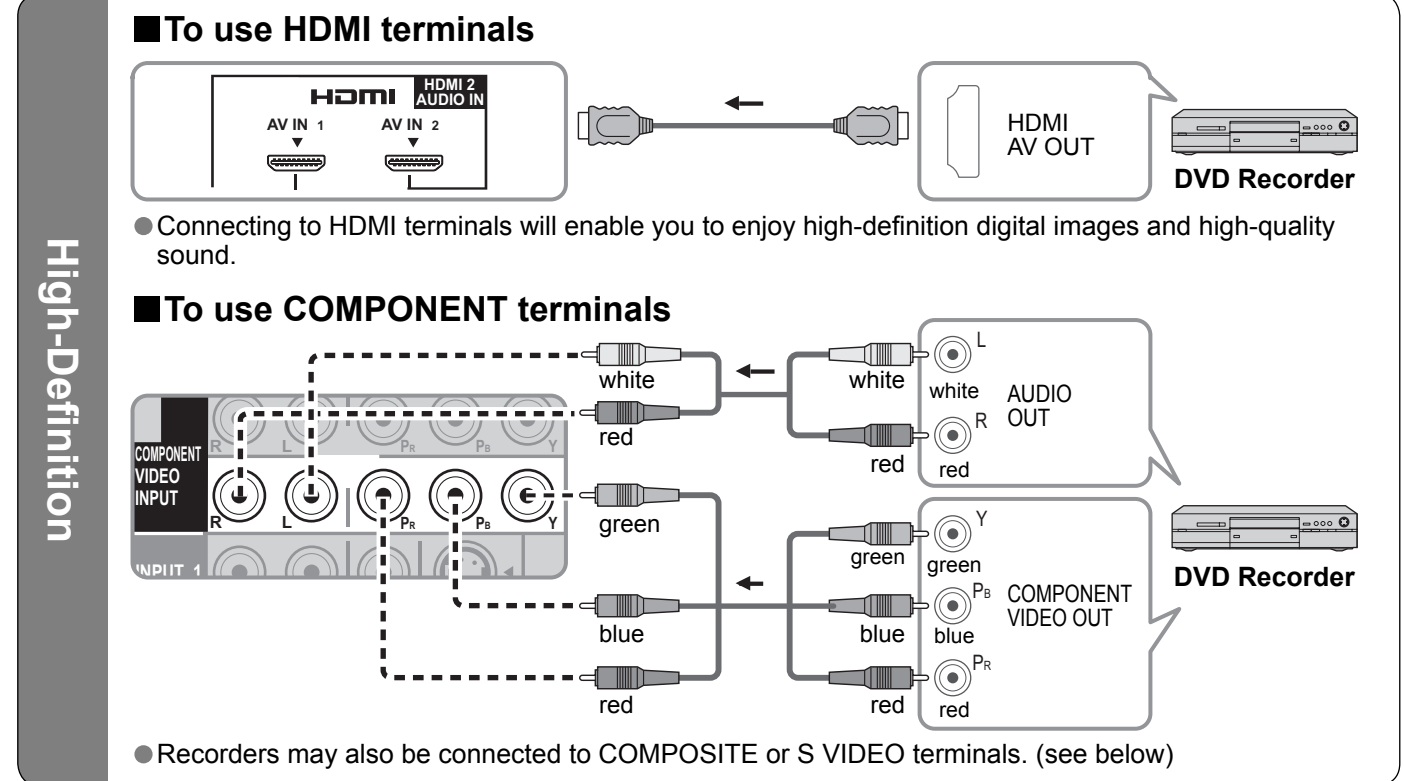
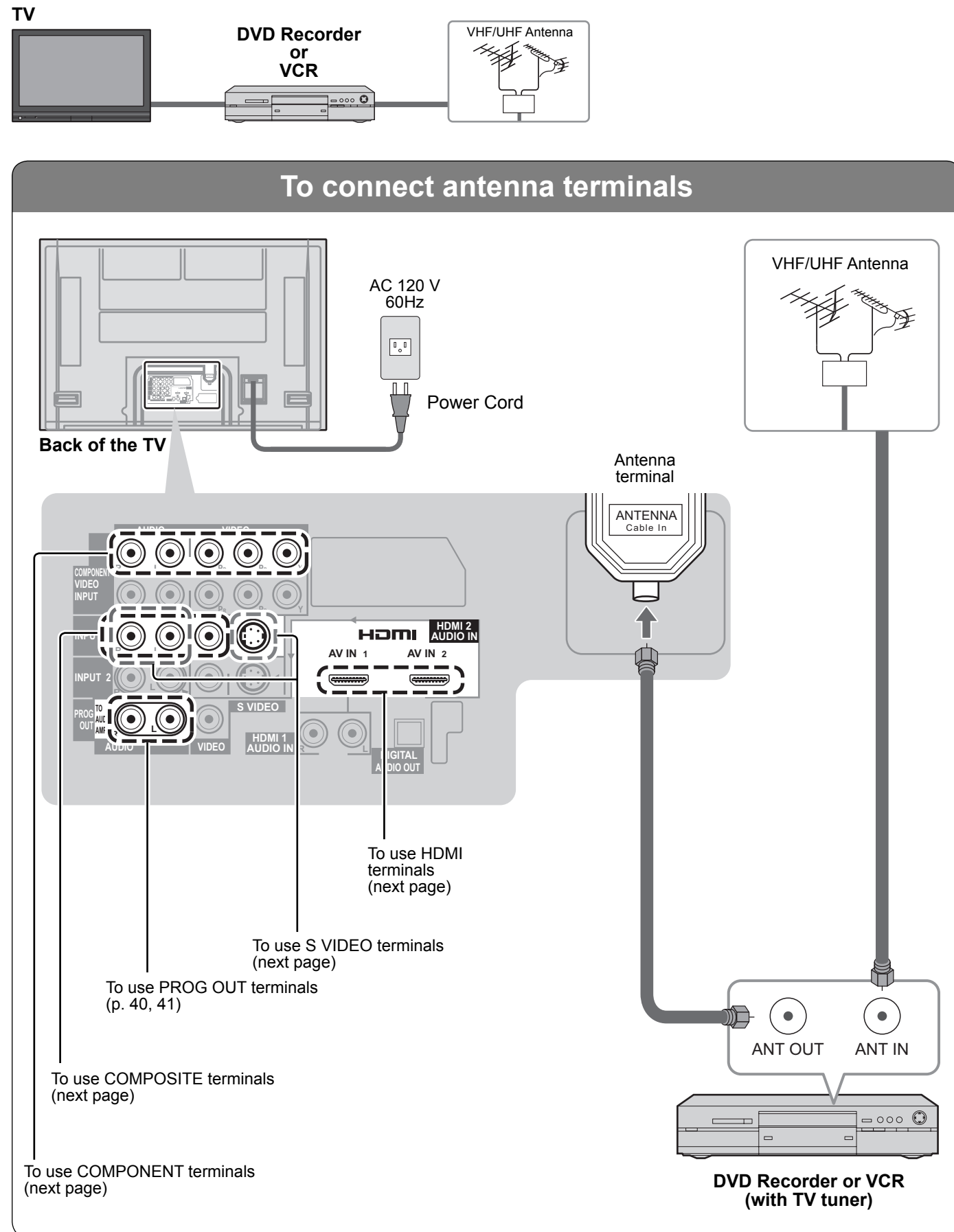

**Note**

- Some programs contain a copyright protection signal to prevent recording.
- When the copyright protection program is displayed, do not connect the other TV monitor through a VCR. Video signals fed through VCRs may be affected by copyright protection systems and the picture will be distorted on the other TV monitor.

# Basic Connection (Continued)

## Example 3 Connecting DVD recorder (VCR) and satellite receiver

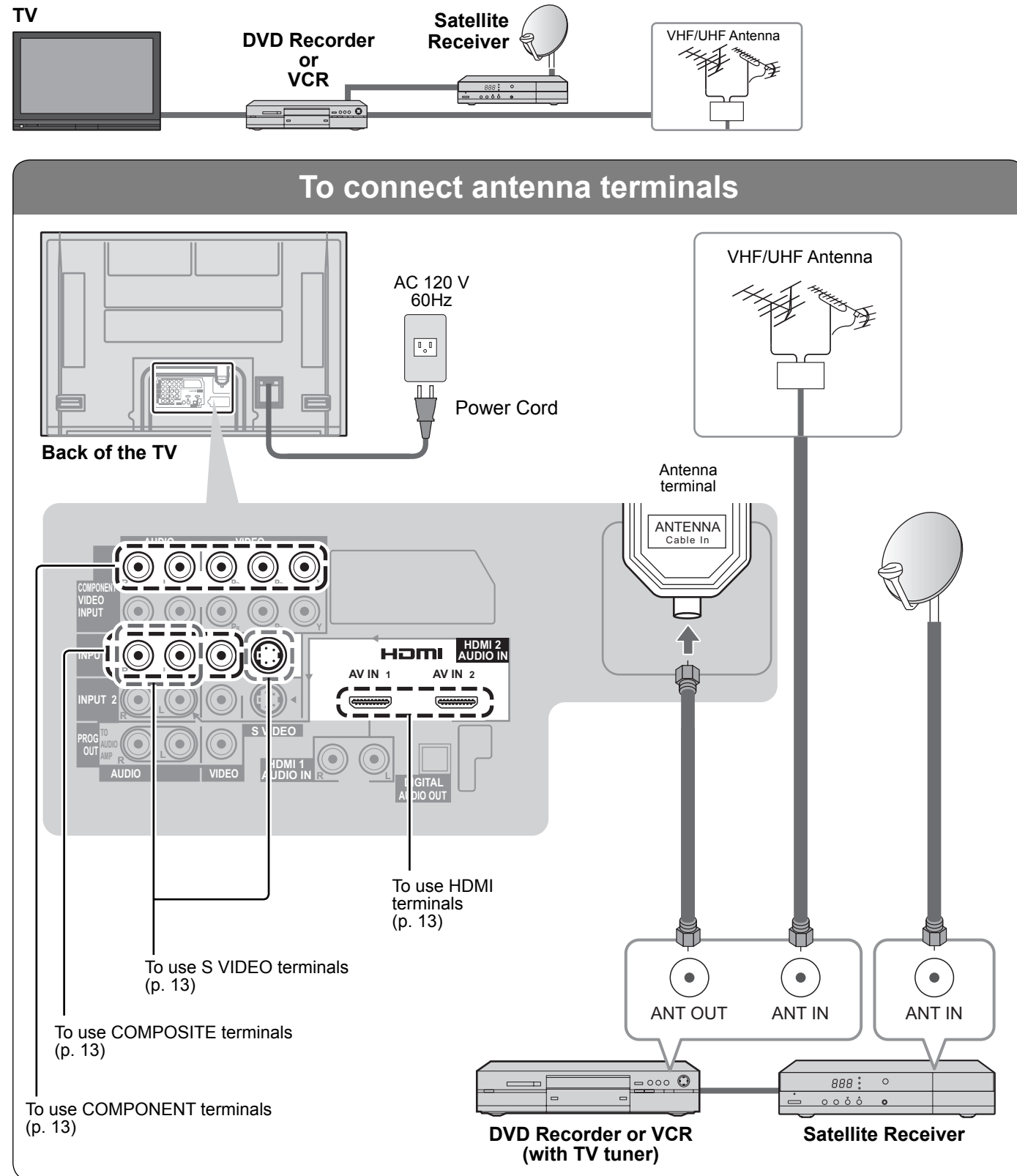

### Connecting TV and DVD recorder (VCR)

Connect in the same way as on p. 13.

#### ■ To use HDMI terminals

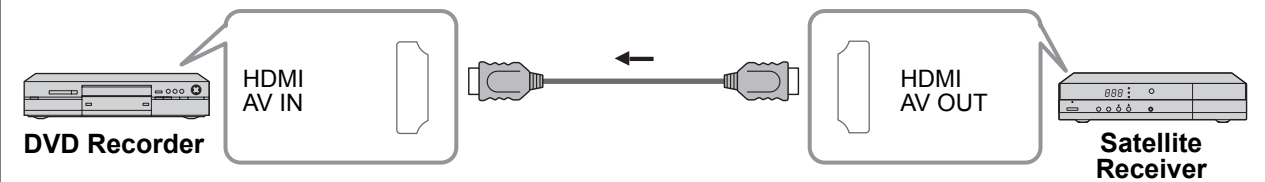

● Connecting to HDMI terminals will enable you to enjoy high-definition digital images and high-quality sound.

#### ■ To use COMPONENT terminals

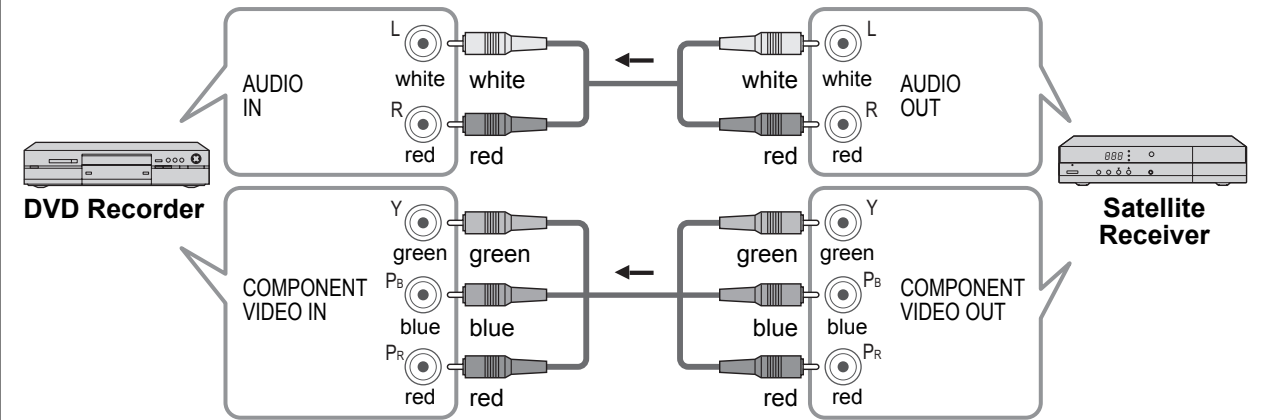

● Satellite Receiver may also be connected to COMPOSITE or S VIDEO terminals. (see below)

#### ■ To use COMPOSITE terminals

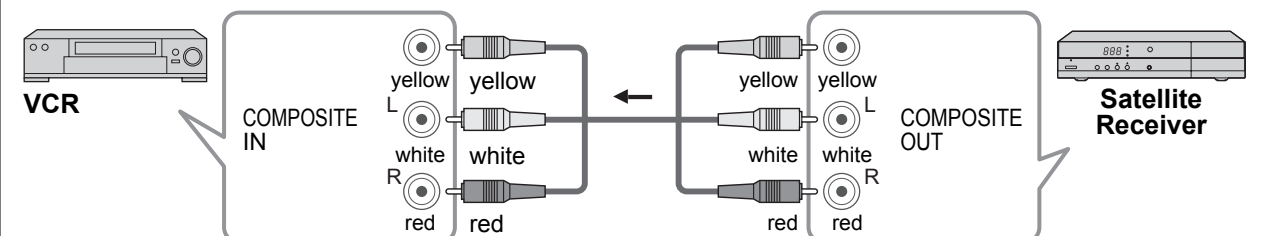

#### ■ To use S VIDEO terminals

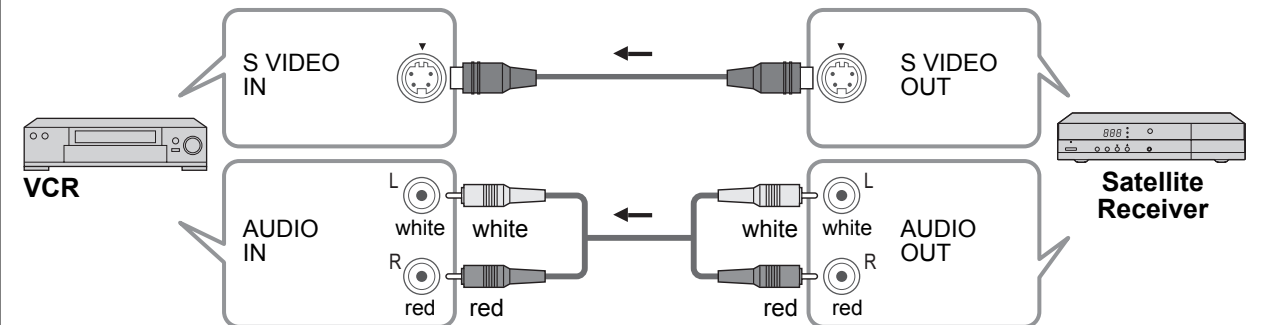

● The S Video input will override the composite video signal when S Video cable is connected. Connect either S Video or Video cable.

● Connecting to S VIDEO terminals will enable you to enjoy greater picture quality than using Composite terminals.



# Basic Connection (Continued)

## Example 4 Connecting Home Theater and DVD recorder

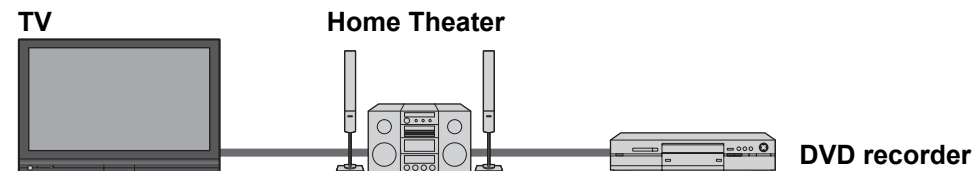

### To connect HDMI terminals

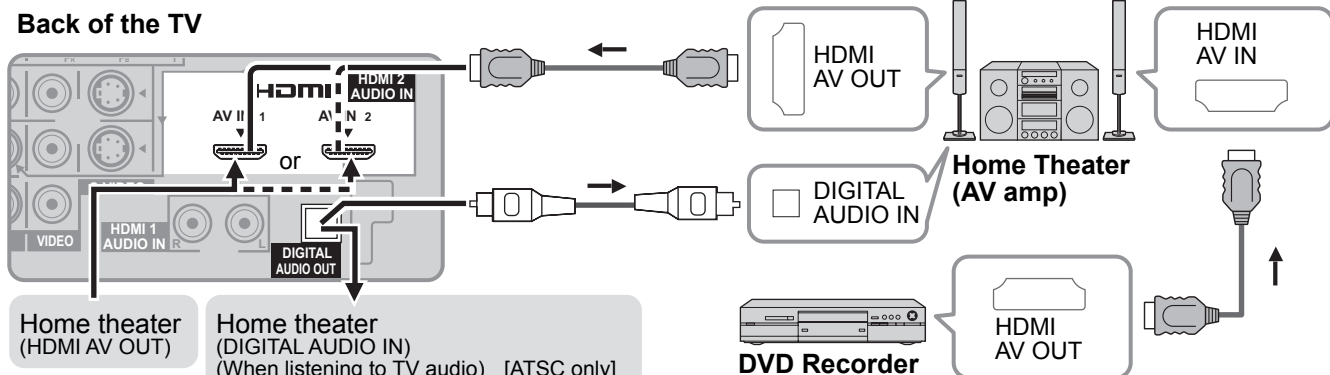

#### Note

- It is recommended that you use Panasonic's HDMI cable. (P. 30)
- When Using the COMPONENT VIDEO OUT terminals or the S VIDEO OUT terminal, refer to p. 15 "To use COMPONENT terminals" or "To use S VIDEO terminals".
- If you connect RAM theater or Player theater with HDMI cable, use audio cable instead of the optical digital audio cable. (p. 41)

### Cable Binding Instructions

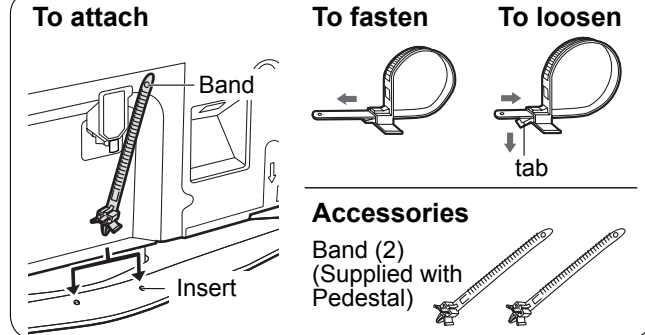
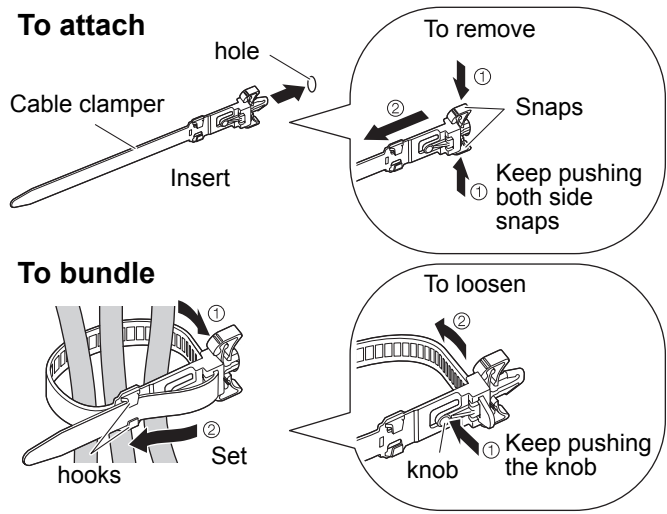
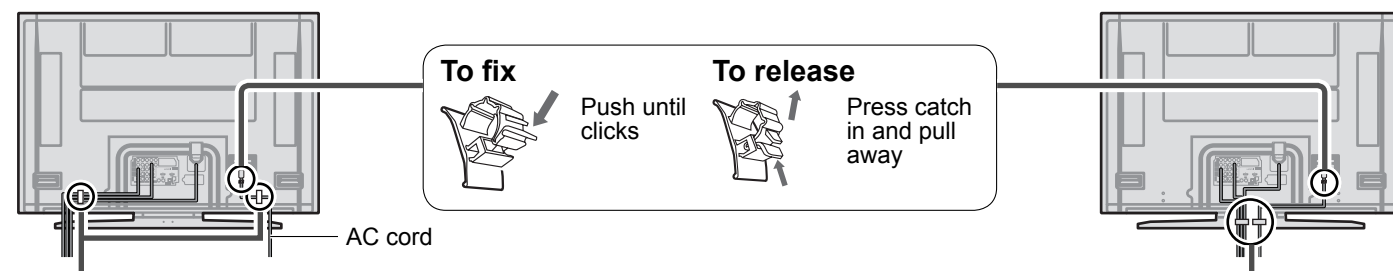

- Do not bundle the RF cable and AC cord together (could cause distorted image).
- Fix cables with Cable clamer and Band as necessary.
- When using the options, follow the option's assembly manual to fix cables.

# Identifying Controls

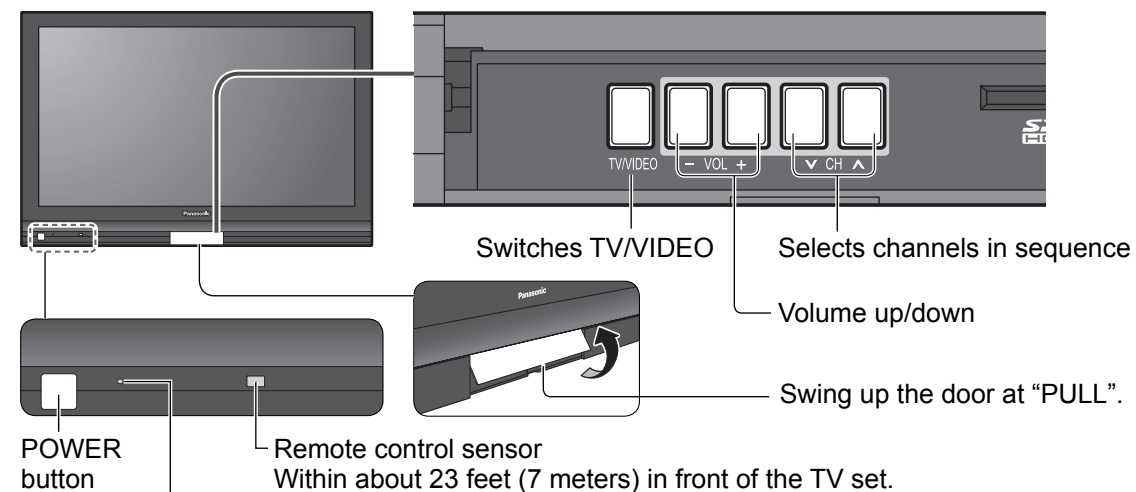

#### Note

- The TV consumes a limited amount of power as long as the power cord is inserted into the wall outlet.

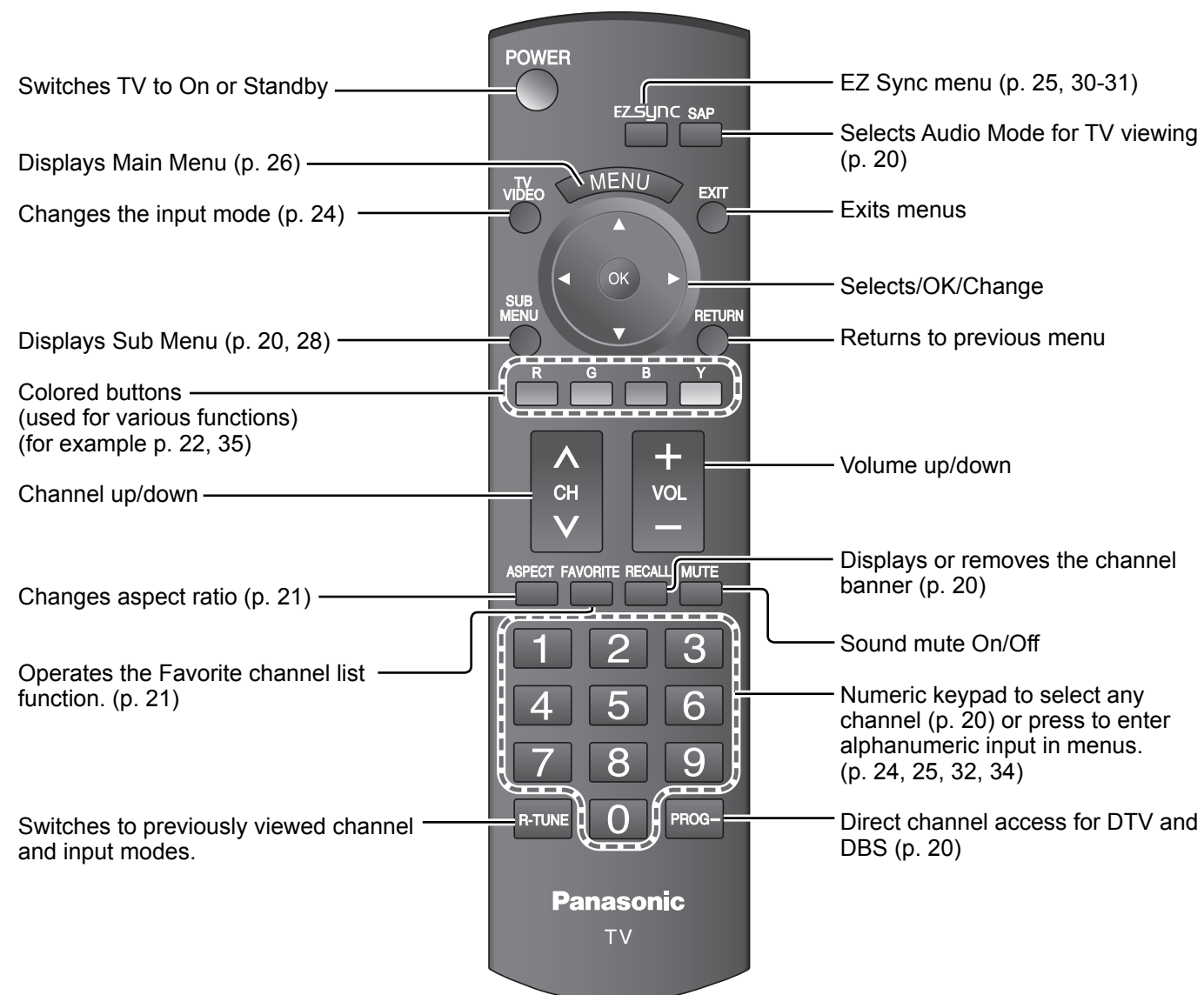

# First Time Setup

"First time setup" is displayed only when the TV is turned on for the first time after the power cord is inserted into a wall outlet and when "Auto power on" (p. 28-29) is set to "No".

## 1 Turn the TV On with the POWER button

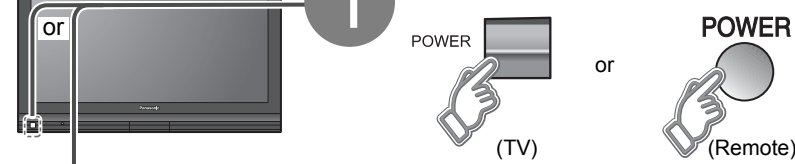

## 2 Select your language

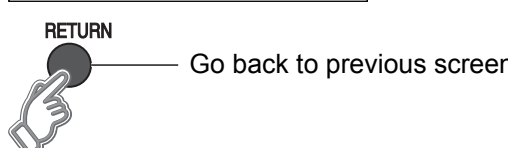
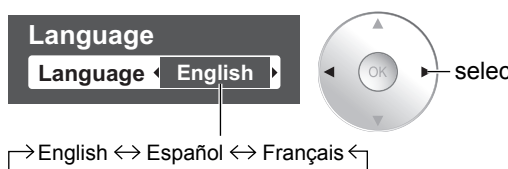
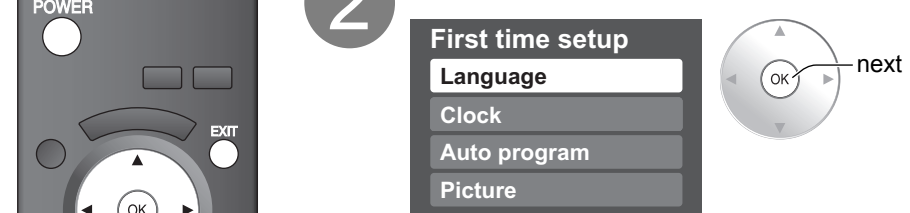

## 3 Adjust the clock

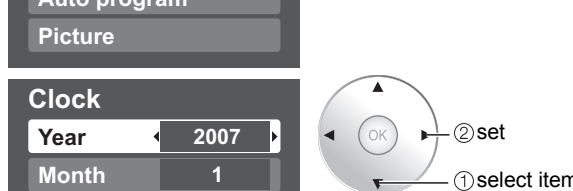
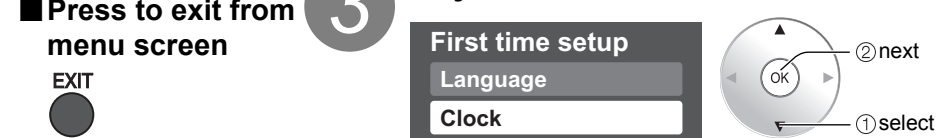

Year: Select the year  
 Month: Select the month  
 Day: Select the day  
 Hour: Adjust the hour  
 Minute: Adjust the minute

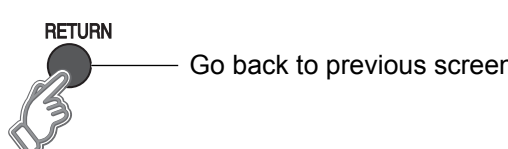

■ Press to exit from menu screen  
 EXIT

■ Press to return to previous screen  
 RETURN

**Note**  
 ● To change setting (Language/Clock/Auto program/Picture) later, go to Menu screen (p. 26, 28)

## 4 Auto channel setup

① Select "Auto program"

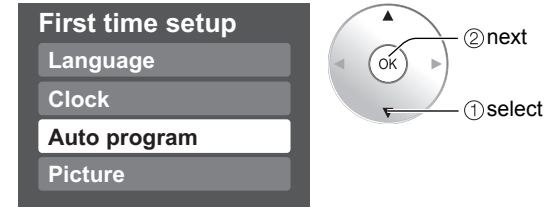

② Select "ANT in"

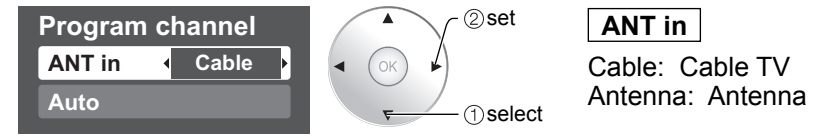

③ Select "Auto"



④ Select scanning mode (ALL channels/Analog only/Digital only)

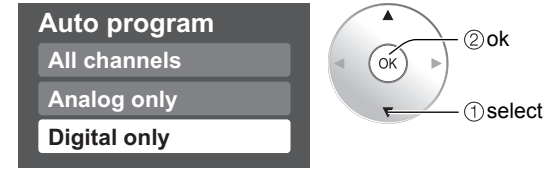

Start scanning the channels

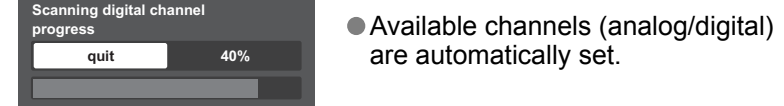

● Available channels (analog/digital) are automatically set.  
 All channels: Scans digital and analog channels  
 Analog only: Scans Analog channels only  
 Digital only: Scans Digital channels only

⑤ Confirm registered channels

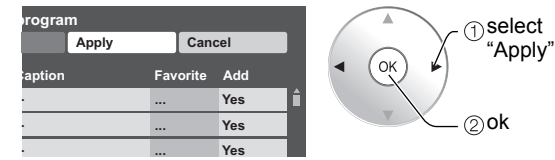

● If OK is not pressed after selecting "Apply", the channels will not be saved.  
 ● If you perform scanning more than twice, previously saved channels are erased.

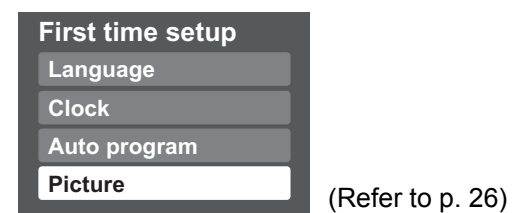

■ Press to exit from menu screen  
 EXIT

**Note**  
 ● About broadcasting systems  
**Analog (NTSC):** traditional TV programming  
**Digital (ATSC):** new programming that allows you to view more channels featuring high-quality video and sound



# Watching TV

Connect the TV to a cable box/cable, set-top-box, satellite box, or antenna cable (p. 10-15)

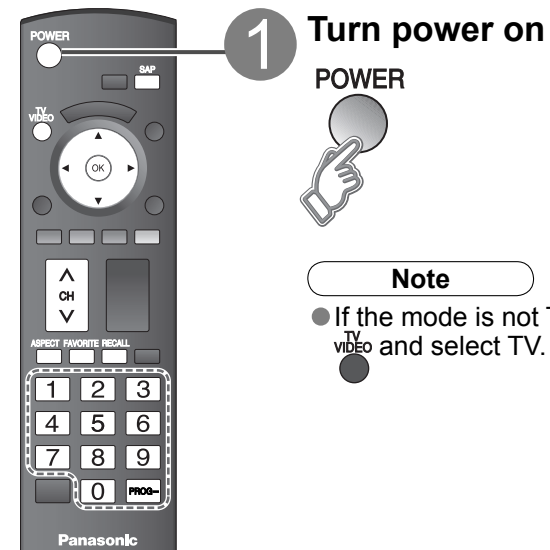

**1 Turn power on**  
POWER



**Note**

- If the mode is not TV, press VIDEO and select TV. (p. 24)

**2 Select a channel number**

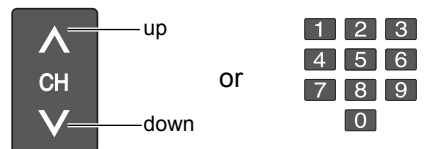

■ **To directly input the digital channel number**

When tuning to a digital channel, press the button to enter the minor number in a compound channel number.

example: CH15-1: **1** **5** **PROG-** **1**

■ **Other Useful Functions** (Operate after 2)

**Listen with SAP (Secondary Audio Program)**

■ **Selects Audio Mode for watching TV**

**SAP**

- **Digital mode**  
Press SAP to select the next audio track (if available) when receiving a digital channel.  
Audio track 1 of 2 (English)
- **Analog mode**  
Press SAP to select the desired audio mode.  
• Each press of SAP will change the audio mode. (Stereo/SAP/Mono)

---

**Display the SUB MENU**

■ **Press SUB MENU to show sub menu screen.** (p. 28)  
This menu consists of shortcuts to convenient functions.

**SUB MENU**

---

**Information Recall**

■ **Displays or removes the channel banner.**

**RECALL**

Channel: 15-2 ABC-HD THE NEWS 12:30 pm  
 Station identifier SAP indication Signal resolution Picture mode Sleep timer remaining time  
 Closed caption Rating Level Aspect ratio

**Change aspect ratio**

■ **Press ASPECT to cycle through the aspect modes.** (p. 43)

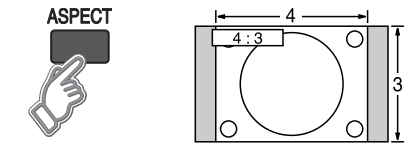

- 480i, 480p: FULL/JUST/4:3/ZOOM
- 1080p, 1080i, 720p: FULL/H-FILL/JUST/4:3/ZOOM

**Call up a favorite channel**



■ **FAVORITE**

Channel numbers registered in Favorite are displayed on the favorite tune screen. Select the desired broadcast station with the cursor or use number buttons. (see below)

**Note**

- Reselect "Cable" or "Antenna" in "ANT in" of "Program channel" to switch the signal reception between cable TV and antenna. (p. 19, 35)
- The channel number and volume level remain the same even after the TV is turned off.

**Set Favorite Feature**

**1** Display the SUB MENU.

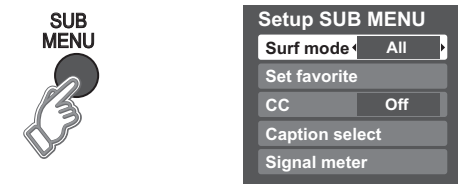

**2** Setup SUB MENU  
Surf mode All  
Set favorite  
CC Off  
Caption select  
Signal meter

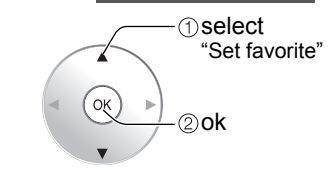

Set favorite 1/3  
1 ---  
2 ---  
3 ---  
4 ---

- Press FAVORITE repeatedly to change between pages (1/3, 2/3, 3/3, or exit).

**3** select  
ok

Press ▲▼ to highlight a position on the list. Then, press OK to save the displayed channel in that position.  
• You can also use the NUMBER buttons (1-9 and 0) to select a list number (1-9 and 0). By doing so, the displayed channel will be saved on that list number without pressing OK.

● **To delete a favorite channel**

A saved channel can be removed from the list by holding down OK while its position is highlighted.

● **To change the page**

Pressing ◀ changes the page backward.

Pressing ▶ changes the page forward.

**Use Favorite Feature**

**1** FAVORITE

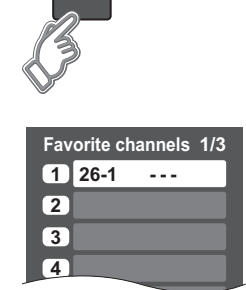

Press FAVORITE.  
• Press FAVORITE repeatedly to change between pages (1/3, 2/3, 3/3, or exit).

**2** select

Press ▲▼ or a Numbered key (1-9 and 0) to highlight a channel on the list.  
• Selecting a channel number from the list with the number button will display the channel directly.

**3** ok

Press OK to display the highlighted channel.

# Viewing from SD Card

You can view photos taken with a digital camera or digital video camera and saved on a SD card.  
(Media other than SD Cards may not be reproduced properly.)

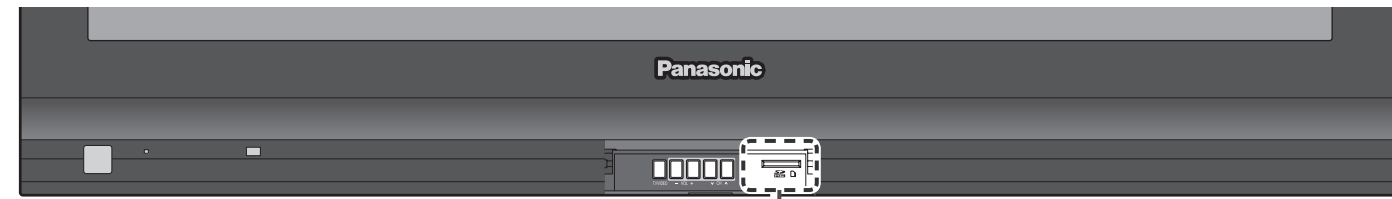

### SD Card

- Insert the card
  - Label surface
  - Push until a click is heard
- Remove the card
  - Press in lightly on SD Card, then release.
- Compliant card type (maximum capacity): SDHC Card (4 GB), SD Card (2 GB), miniSD Card (1 GB) (requiring miniSD Card adapter)

- 1 Insert the SD Card**
  - For cautions and details on SD Cards (p. 44)
- 2 Display menu**
  - Press **MENU** → Select "Memory card"
- 3 Select the data to be viewed**
  - Thumbnail view
  - Navigation area
  - Present status (While reading the data)
  - Selected picture information is displayed.
    - No.:** Image number or file name is displayed.
    - Date:** Date of recording is displayed.
    - Pixel:** Display resolution is displayed.
  - Total number of images

**Note**

- Depending on the JPEG format, "Information" contents may not be displayed correctly. Refer to p. 44 (Data format for SD card browsing) for details.

**Press to exit from menu screen**  
EXIT

**Press to return to the previous screen**  
RETURN

Navigation area controls:  
 Rotate: Rotate 90 degrees (counter-clockwise) / Rotate 90 degrees (clockwise)  
 Prev./Next: To previous photo / To next photo  
 RETURN: To display/hide Navigation area

## 4 View

Displays one at a time

Navigation area

- Rotate 90 degrees (counter-clockwise)
- To next photo
- Rotate 90 degrees (clockwise)
- To previous photo
- To display/hide Navigation area → RECALL

### To change the view (slide show mode, adjusting images, etc.)

#### ■ To watch photos in slide show mode

In 4

Press **R** → Press **MENU** → Press **OK** (select "JPEG setup") → Press **OK** (select "JPEG setup")

**JPEG menu**  
Picture  
JPEG setup

**JPEG setup**  
Disp. time 5  
Repeat On

<b>Disp. time</b>	You can set how many seconds each image is displayed in Slide show mode. (1-10/15/20/30/45/60/120 sec)
<b>Repeat</b>	Turn the slide show Repeat function On or Off.

**Note**

- For large image sizes, the display time will be longer than the number of seconds set.
- To stop in mid-cycle → Press RETURN

#### ■ To adjust picture

When MENU is pressed, the "JPEG menu" is displayed.

In 3

Press **MENU** → Press **OK** (select "Picture") → Press **OK** (select "Picture")

**JPEG menu**  
Picture  
JPEG setup  
Select OK RETURN

**Picture** 1/2  
Normal Set  
Picture mode Vivid  
Picture 0  
Brightness 0  
Color 0  
Tint 0  
Sharpness 0

Picture menu (p. 26)

### Viewing from a GalleryPlayer SD Card

You can view high-definition art and photography purchased on or downloaded to an SD card. GalleryPlayer provides pre-loaded SD cards with copy-protected imagery and images for download to your computer that can be saved on an SD card for display on your television.



# Watching Videos and DVDs

If you have some equipment connected to the TV, you can watch videos and DVDs on the TV's screen.

## Input Select

You can select the external equipment to access.

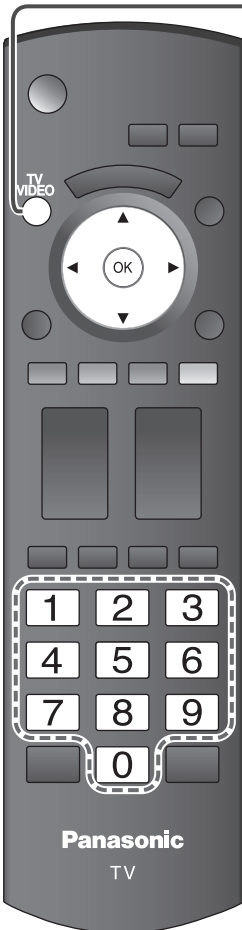

**1** With the connected equipment turned On  
**Display the Input select menu**

**2** **Select the input mode**

Input select	
1	TV
2	Component 1
3	Component 2
4	HDMI 1
5	HDMI 2
6	Video 1
7	Video 2

Press corresponding NUMBER button on the remote control to select the input of your choice.

or

① select  
② enter

Select the input of your choice, then press OK.

- During the selection, if no action is taken for several seconds, the "Input select" menu disappears.
- The terminal and label of the connected equipment is indicated. To label each of the inputs please refer to p. 36-37.

(example)

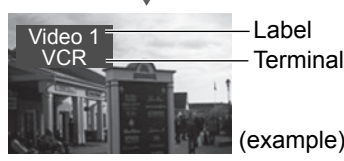

**3** **Operate the connected equipment using the remote control supplied with the equipment.**

**Note**

- For details, see the manual of the equipment.

■ To return to TV  
TV VIDEO → 1

## EZ Sync™

If you connect equipment that has "HDAVI Control 2" function to a TV with HDMI cable, you can enjoy using more convenient functions. For details, "EZ Sync Control" on p. 30-31.



**1** **Display EZ Sync menu**

**2** **Select the equipment**

EZ SYNC	
DVD recorder	
Home theater	
HD camcorder	
Speaker output	
TV	

① select  
② enter

**3** **Operate**

You can operate the selected equipment with the TV's remote control. Follow the menu of the equipment and enjoy watching. For the remote control operations, refer to p. 31.

**Note**

- For details, see the manual of the equipment or ask your local dealer.

■ To return to TV  
TV VIDEO → 1

# How to Use Menu Functions

Various menus allow you to make settings for the picture, sound, and other functions so that you can enjoy watching TV in your own way.

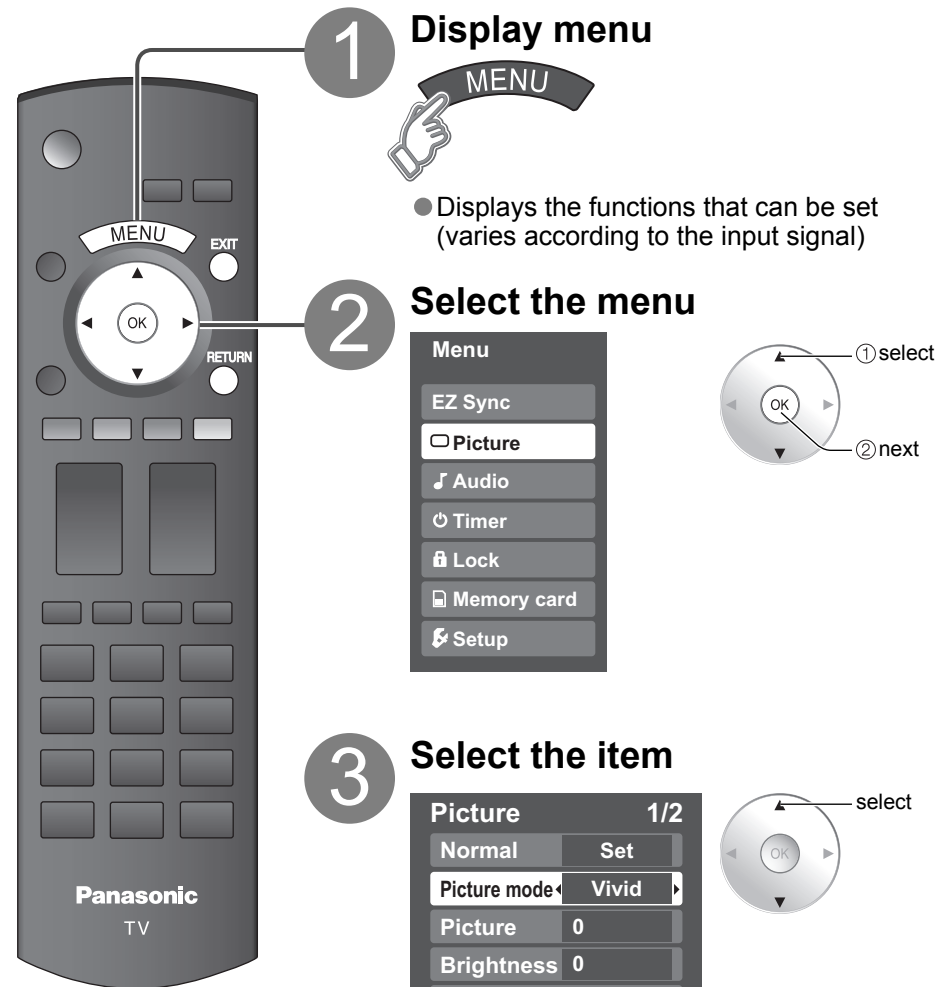

## 1 Display menu

● Displays the functions that can be set (varies according to the input signal)

## 2 Select the menu

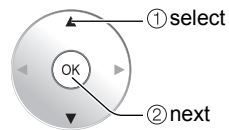
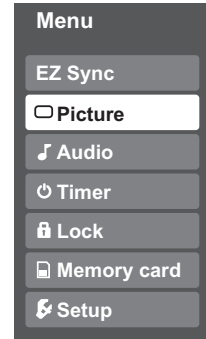

## 3 Select the item

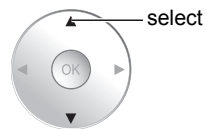
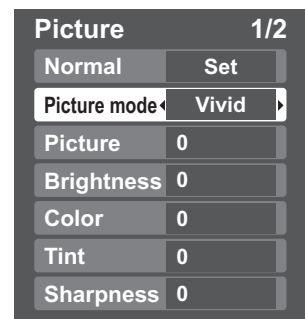

## 4 Adjust or select

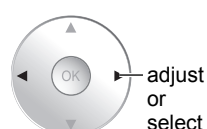
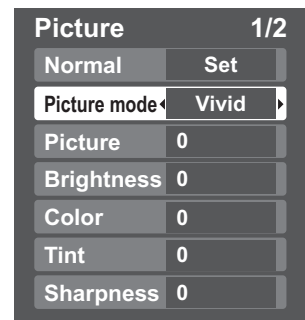

■ Press to exit from menu screen

EXIT

■ Press to return to the previous screen

RETURN

### Menu list

Menu	Item		
EZ Sync	DVD recorder, Home theater, HD camcorder, Speaker output		
	Normal		
Picture	Picture mode		
	Picture, Brightness, Color, Tint, Sharpness		
	Color temp.		
	Color mgmt.		
	Zoom adjust		
	Other adjust	Video NR	
		3D Y/C filter	
		Color matrix	
		MPEG NR	
		Black level	
Audio	Normal		
	Bass		
	Treble		
	Balance		
	Other adjust	AI sound	
		Surround	
		Speaker output	
		HDMI 1 in HDMI 2 in	
		Audio leveler	
	Timer	Sleep, Timer 1-5	
Lock			
Memory Card	Memory card		

Adjustments/Configurations (alternatives)	
<b>[DVD recorder/Home theater/HD camcorder]</b> Select equipment to access and operate. (p.30-31) <b>[Speaker output]</b> Select audio output. (Home theater/TV) (p. 30-31) ● EZ Sync menu is accessible directly by pressing the EZ Sync button on the remote control. → EZ SYNC (p. 25)	
Resets all picture adjustments to factory default settings except for "Other adjust" (Set/No)	Normal Set
Basic picture mode (Vivid/Standard/Cinema/Custom) (p. 45)	Picture mode Vivid
Adjusts color, brightness, etc. for each picture mode to suit your taste	Picture +20 Tint 0 Brightness 0 Sharpness 0 Color 0
Selects level of warm colors (red) and cool colors (blue) (Cool/Normal/Warm)	Color temp. Cool
On: Enhances green and blue color reproduction, especially outdoor scenes. (On/Off)	Color mgmt. On
Adjusts vertical alignment and size when aspect setting is "ZOOM" (p. 43)	Zoom adjust
Reduces noise, commonly called snow. Leave it off when receiving a strong signal. (Off/On)	Video NR Off
Minimizes noise and cross-color in the picture. (On/Off)	3D Y/C filter Off
Selects image resolution of component-connected devices (HD/SD) ● SD: Standard Definition HD: High Definition ● Only 480p signal accepted; regular TV (NTSC) is not available.	Color matrix SD
Reduces noise of specific digital signals of DVD, STB, etc. (On/Off)	MPEG NR Off
Selects Dark or Light. Valid only for external input signals. (Dark/Light)	Black level Light
Resets Bass, Treble and Balance adjustments to factory default settings. (Set/No)	Normal Set
Increases or decreases the bass response.	Bass +4
Increases or decreases the treble response.	Treble 0
Emphasizes the left / right speaker volume.	Balance 0
Equalizes overall volume levels across all channels and external inputs. (On/Off)	AI sound On
Enhances audio response when listening to stereo. (On/Off)	Surround Off
Switches to "Off" when using external speakers (On/Off) ● "AI sound", "Surround", and "Audio leveler" do not work if "Off" is selected	Speaker output On
Selects according to the signal when HDMI is connected (Auto/Digital/Analog) ● Auto: Automatically selects Analog / Digital signal	HDMI1 in Auto HDMI2 in Auto
Minimizes volume disparity after switching to external inputs	Audio leveler 0
The TV can automatically turn On/Off at the designated date and time (p. 38)	Sleep 60
Locks the channels and programs (p. 32)	
Displays SD card data (p. 22-23)	Memory card

● In AV mode, the Audio menu and Setup menu give a fewer options.

● How to Use Menu Functions (picture, sound quality, etc.)

Advanced

# How to Use Menu Functions

Various menus allow you to make settings for the picture, sound, and other functions so that you can enjoy watching TV in the way best suited for you.



**1 Display menu**  
 ● Displays the functions that can be set (varies according to the input signal)

**2 Select "Setup"**

**3 Select the item**

■ Press to exit from menu screen



■ Press to return to the previous screen

**1 Display Sub Menu**

**2 Select the item**

## ■ Menu list

Menu	Item		
Setup	Surf mode		
	Language		
	Clock		
	Program channel		
	External devices	Input labels	
		Monitor out	
	CC		
	EZ Sync setting	EZ Sync	
		Power off link	
		Power on link	
Default speakers			
Other adjust	Auto power on		
	Side bar		
	No signal shut-off		
	No action shut-off		
About			
Reset			

## ■ Sub menu list

Menu	Item	
Setup SUB MENU	Surf mode	All
	Set favorite	
	CC	Off
	Caption select	
	Signal meter	

## (Continued)

Adjustments/Configurations (alternatives)		
Sets the mode to select the channel with Channel up/down button ( <b>Favorite/All</b> ) ● Favorite: Only channels registered as FAVORITE (p. 35)	Surf mode	All
Selects the screen menu language (p. 18)	Language	
Adjusts the clock (p. 18)	Clock	
Sets channels (p. 34)	Program channel	
Selects the terminal and label of the external equipment (p. 36)		
<b>[Comp.1/Comp.2/HDMI 1/HDMI 2/Video 1/Video 2]</b> To prevent howling and image oscillation, stops output of the pictures and audio specified in this menu. (p. 36) ( <b>On/Off</b> )		
Displays subtitles (Closed Caption) (p. 36)	CC	
Controls equipment connected to HDMI terminals (p. 30) ( <b>On/Off</b> ) ● "Power off link", "Power on link", and "Default speakers" cannot be selected if "Off" is set.	EZ Sync	On
Sets "Power off link" of HDMI connection equipment (p. 30) ( <b>Set/No</b> )	Power off link	Set
Sets "Power on link" of HDMI connection equipment (p. 30) ( <b>Set/No</b> )	Power on link	Set
Selects the default speakers (p. 30) ( <b>TV/Theater</b> )	Default speakers	TV
Turns TV On automatically when the cable box or a connected device is turned On ( <b>No/Set</b> ) ● The "Sleep" timer, "On / Off timer", and "First time setup" will not function if "Auto power on" is set. (p. 38)	Auto power on	No
Increases the brightness of the side bar ( <b>Mid/Off/Bright/Dark</b> ) (4:3 mode only) The recommended setting is "Bright" to prevent panel "Image retention". (p. 45)	Side bar	Bright
To conserve energy, the TV automatically turns off when NO SIGNAL continues more than 10 minutes. ( <b>Set/No</b> ) <b>Note</b> ● Not in use when setting "Auto power on", "On/Off Timer", "Lock", "SD Mode", or Digital channel. ● "No signal shut-off was activated" will be displayed for about 10 seconds when the TV is turned on for the first time after turning the power off by "No signal shut-off". ● The on-screen display will flash 3, 2 and 1 to indicate the last three (3) remaining minutes prior to the shut-off.	No signal shut-off	Set
To conserve energy, the TV automatically turns off when no operation of remote or front panel key continues more than 3 hours. ( <b>No/Set</b> ) <b>Note</b> ● Not in use when setting "Auto power on" or "On/Off Timer". ● "No action shut-off was activated" will be displayed for about 10 seconds when the TV is turned on for the first time after turning the power off by "No action shut off". ● The on-screen display will flash 3, 2 and 1 to indicate the last three (3) remaining minutes prior to the shut-off.	No action shut-off	No
Displays TV version and software license.	About	
Performing Reset will clear all items set with Setup, such as channel settings. (p. 34)	Reset	

Adjustments/Configurations (alternatives)		
Sets the mode to select the channel with Channel up/down button ( <b>Favorite/All</b> )		
Sets favorite channels. (p. 21)		
Displays Closed Caption. (p. 36-37)		
Changes the station identifier. (p. 34-35)		
Checks the signal strength if interference or freezing occurs on a digital image. (p. 34-35)		

● How to Use Menu Functions (picture, sound quality, etc.)

Advanced



# EZ Sync™ “HDAVI Control™”\*

\* Simultaneously control all Panasonic “HDAVI Control” equipped components using one button on one remote.

Enjoy additional HDMI Inter-Operability with Panasonic products which have “HDAVI Control” function. This TV supports “HDAVI Control 2” function.

Connections to some Panasonic equipment (DVD Recorder DIGA, HD Camcorder, RAM theater, Player theater, Amplifier, etc.) with HDMI cables allow you to interface automatically.

The equipment with “HDAVI Control” function enables the following operations:

Automatic Input Switching, Power on link, Power off link and Speaker control (p. 31).

In addition, the equipment with “HDAVI Control 2” function enables the following operation:

EZ Sync Control only with TV’s remote control (for “HDAVI Control 2”) (p. 31).

EZ Sync “HDAVI Control”, based on the control functions provided by HDMI which is an industry standard known as HDMI CEC (Consumer Electronics Control), is a unique function that we have developed and added. As such, its operation with other manufacturers’ equipment that supports HDMI CEC cannot be guaranteed.

■ For the first time / When adding new equipment, reconnecting the equipment or changing the setup.

After the connection turn the equipment on and then switch the TV on.

Select the input mode to HDMI 1 or HDMI 2 (p. 24), and make sure that an image is displayed correctly.

● This function needs an HDMI compliant (fully wired) cable. Non-HDMI-compliant cables cannot be utilized.

It is recommended that you use Panasonic’s HDMI cable.

Recommended part number:

RP-CDHG15 (4.9 ft/1.5 m), RP-CDHG30 (9.8 ft/3.0 m), RP-CDHG50 (16.4 ft/5.0 m)

**1 Display menu**  
Press the MENU button.

**2 Select “Setup”**  
Use the directional pad to select Setup in the Menu screen.

**3 Select “EZ Sync setting”**  
Use the directional pad to select EZ Sync setting in the Setup screen.

**4 Select “EZ Sync”**  
Use the directional pad to select EZ Sync in the EZ Sync setting screen.

**5 Select “On”**  
Use the directional pad to select On in the EZ Sync setting screen.

■ Press to exit from menu screen  
EXIT

■ Press to return to the previous screen  
RETURN

● If no HDMI equipment is connected or standard HDMI equipment (non- “EZ Sync”) is used, set to “Off”.

## Automatic Input Switching

## Speaker control

## EZ Sync Control only with TV’s remote control (for “HDAVI Control 2”)

## Power on link

## Power off link

## Default speakers

## One-touch theater playback

At the start of the DIGA, Player theater, or RAM theater playback, the TV’s input automatically switches to the input based on the playback equipment.

● For the RAM theater, the speakers automatically switch to the theater system.

If using the DIGA operation, the TV’s input automatically switches to the DIGA and DIGA menu is displayed.

You can select Home theater, or TV speakers for audio output.

Control theater speakers with the TV’s remote control.

This function is available only when Panasonic Amplifier or Player theater is connected.

① Press EZ SYNC

② Select “Speaker output”

③ Select “Home theater” or “TV”

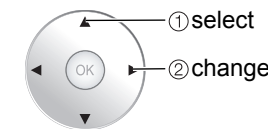
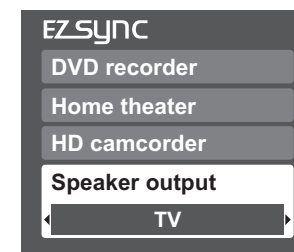

■ Home theater: Adjustment for equipment

Volume up / down → + VOL

Mute → MUTE

● The sound of TV is muted.

● When the equipment is turned off, TV speakers become active.

● Selecting “Home theater” turns the equipment on automatically if it is in standby mode.

■ TV: The TV speakers are active.

In the EZ Sync menu, you can select an HDMI connected Panasonic equipment and access it quickly. Continue using your TV’s remote control to operate the equipment, pointing it at the TV.

① Press EZ SYNC

② Select the equipment you want to access.

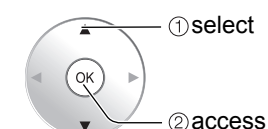

You can select available items only.

■ Available TV’s remote control buttons

	Move the cursor/Select
	Set/Access
	Return to the previous menu
	Display the Functions menu on the equipment
	Available when the purpose of the keys are displayed on screen

③ Operate the equipment with the TV’s remote control, pointing it at the TV.

● To operate the equipment, read the manual of the equipment.

When “Set” is selected (p. 29), TV is turned on automatically and switches to the appropriate HDMI input whenever EZ Sync compatible equipment is initially turned on and Play mode is selected.

When “Set” is selected (p. 29) and the TV is turned off, all connected EZ Sync compatible equipment is also automatically turned off.

● DIGA (Panasonic DVD Recorder) will not turn off if it is still in rec mode.

**Caution:** The TV remains on even if the EZ Sync compatible equipment is turned off.

“TV” is the default setting. To set the Home Theater system as default speakers, change the default speakers setting from “TV” to “Theater”. Sound will be output from the Home Theater whenever the TV is powered on.

If the “ONE TOUCH PLAY” key is pressed on the remote control for Panasonic Home Theater system, the following sequence of operations is performed automatically.

① Home Theater power switches On, and playback begins.

② TV power switches On, and the playback screen is displayed.

③ Audio is muted on the TV and switches to the theater system.

# Lock

You can lock specified channels or shows to prevent children from watching objectionable content.

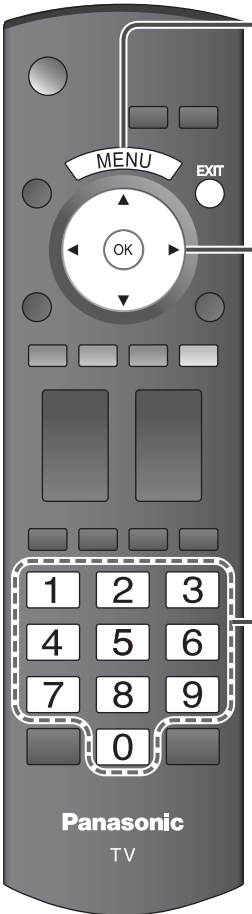

- Display menu**  
Press the **MENU** button.
- Select "Lock"**  
You will be asked to enter your password each time you display the Lock menu.  
  - ① select
  - ② next
- Input your 4-digit password**  
A 4-digit code must be entered to view a blocked program or change rating settings.  
  - If it is the first time to enter the password, enter the code twice in order to register it.
- Select the Lock mode**  
  - Off: Unlocks all the lock setting of "Channel", "Game" and "Program".
  - All: Locks all the inputs regardless of the lock setting of "Channel", "Game" and "Program".
  - Custom: Locks specified inputs of "Channel", "Game" and "Program".
- Select the item**  
  - "Channel", "Game" and "Program" will grey out unless "Custom" is selected in "Mode".
- Set**

**Caution**  
● Make a note of your password in case you forget it. (If you have forgotten your password, consult your local dealer.)

**Note**  
● When you select a locked channel, a message will be displayed that allows you to view the channel if you input your password.

## ■ To select the channel or the rating of the program to be locked

### Channel lock

Select up to 7 (1-7) channels to be blocked. These channels will be blocked regardless of the program rating.

- Select "Mode" and set to "Custom"**
- Select channel to lock.**

● To lock/unlock all channels:  
Select "Mode" and set to "All" or "Off".  
All: Locks all channels  
Off: Unlocks all channels

### Game lock

Locks Channel 3, Channel 4 and external inputs.  
**Select "Game" in ⑤ and set to "On".**

On: Locks  
Off: Unlocks

### Program lock

**■ To set a rating level**  
"V-chip" technology enables restricted shows to be locked according to TV ratings.

- Select "Mode" and set to "On".**
- Select the rating category you wish to follow**
- Select the rating to be locked**

Example of "MPAA" (U.S. movie ratings)

NR	No rating
G	General Audience: All ages admitted
PG	Parental Guidance Suggested
PG-13	Parents Strongly Cautioned: Inappropriate for children under 13
R	Restricted: Under 17 requires accompanying parent or adult guardian
NC-17	No one 17 and under admitted
X	Adults only

● To get other information (p. 42)

**■ To disable recording of the locked program**  
→ Select "Monitor out" and set to "On".

On: Turns on the monitor terminal output for programs that have been set to "Blocked."  
Off: Turns off the monitor terminal output for programs that have been set to "Blocked."

### Change password

**■ To change the password**

- In ④, select "Change password" and press OK
- Input the new 4-digit password twice

**Note**

- This television is designed to support the "Downloadable U.S. Region Rating System" when available. (Available only in U.S.A.)
- The Off rating is independent of other ratings.
- When placing a block on a specific-age-based-rating level, the Off rating and any other more restrictive ratings will also be blocked.

# Editing and Setting Channels

The current channel settings can be changed according to your needs and reception conditions.

- 1 Display menu**  
Press the **MENU** button.
- 2 Select "Setup"**  
Use the directional pad to move the cursor to **Setup** and press **OK** to select it.
- 3 Select "Program channel"**  
Use the directional pad to move the cursor to **Program channel** and press **OK** to select it.
- 4 Select the function**  
Use the directional pad to move the cursor to the desired function (Auto, Manual, or Signal meter) and press **OK** to select it.
- 5 Set**

■ Press to exit from menu screen  
**EXIT**

■ To reset the settings of setup menu

- 1 Select "Reset" in Setup menu (3) and press OK
- 2 Input your 4-digit password with number buttons
- 3 Select "YES" on the confirmation screen and press OK

**Auto**  
Set automatically

**Manual**  
Set manually

**Signal meter**  
Check signal strength

Automatically searches and adds active channels to memory.

- 1 Select "ANT in"** → Select Cable or Antenna (p. 19)
- 2 Select "Auto"**  
Use the directional pad to move the cursor to **Auto** and press **OK** to select it.
- 3 Select scanning mode** (p. 19)  
Use the directional pad to move the cursor to the desired scanning mode (All channels, Analog only, or Digital only) and press **OK** to select it.

Settings are made automatically

- After completing the setting, select "Apply". (see below 5).
- All previously saved channels are erased.

Use this procedure when changing setting of receiving channels or changing the channel display. Also, use to add or skip channels from channel list manually.

- 1 Select "Edit"**  
Use the directional pad to move the cursor to **Edit** and press **OK** to select it.
- 2 Select the item to be edited**  
Use the directional pad to move the cursor to the item to be edited (Caption, Favorite, or Add) and press **OK** to select it.

- **Caption:** Changes the station identifier
- **Favorite:** Registers channel to Favorite List
- **Add:** Adds or skips channels

Go back to previous page (R) / Proceed to next page (G)

- 3 Edit**
  - **Caption**  
Caption select  
Caption detail  
Apply Cancel  
Select the station identifier. Rename (maximum 7 characters available)
  - **Favorite**  
Set favorite 1/3  
1 26-1 ---  
Select the number
  - **Add**  
Press OK to select "Yes (add)" or "No (skip)" → **RETURN**
- 4 Move cursor to channel number**  
Use the directional pad to move the cursor to the channel number and press **OK** to tune to the channel.
- 5 Select "Apply"**  
Use the directional pad to move the cursor to **Apply** and press **OK** to select it.

To cancel the Edit

Use the directional pad to move the cursor to **Cancel** and press **OK** to select it.

Changes will be lost. Continue?  
Yes No  
Press **OK** to select "Yes" (returns to "Program channel")

Check the signal strength if interference is found or freezing occurs on a digital image.

**Signal meter**  
Channel 1-1  
Signal strength  
Current 30%  
Peak level 45%

Use the directional pad to move the cursor to the channel number and press **OK** to change channel.

Signal intensity

- If the signal is weak, check the antenna. If no problem is found, consult your local dealer.

**Note**

- Not available if "Cable" is selected in "ANT in" (see above).
- Effective only for digital antenna channels.

● If "Lock" (p. 32) is activated and "Auto", "Manual" or "Signal meter" is selected, "Enter password." will be displayed.



# Input Labels/Monitor out/

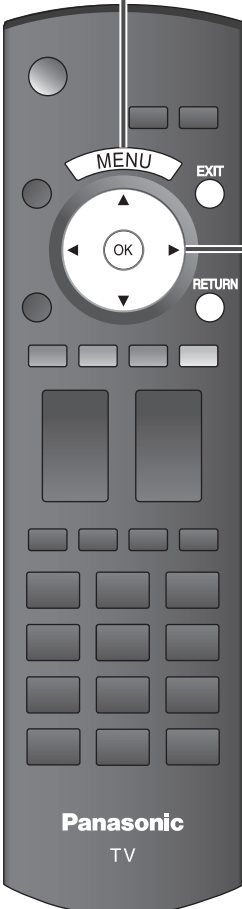

**1 Display menu**  
MENU

**2 Select "Setup"**  
Menu  
EZ Sync  
Picture  
Audio  
Timer  
Lock  
Memory card  
Setup

**3 Select "External devices" or "CC"**  
Setup 1/2  
Surf mode  
All  
Language  
Clock  
Program channel  
External devices  
CC

**4 (External devices) Select "Input Labels" or "Monitor out"**  
External devices  
Input labels  
Monitor out

**5 Set**

■ Press to exit from menu screen  
EXIT

## Input labels

Display labels of external devices

## Monitor out

Stop output the picture and audio

## CC

Display Closed Caption

# Closed Caption

Devices connected to external input terminals can be labeled for easier identification during input selection. (In selecting input mode from p. 24 ②)

### ■ Select the terminal and label of the external equipment

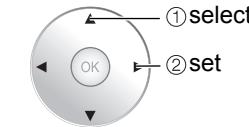
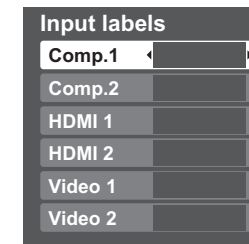

- Terminals: Comp.1-2/HDMI 1-2/Video1-2
- Label: SKIP\*/VCR/DVD/CABLE/DBS/PVR/GAME/AUX/[BLANK]
- \* If "SKIP" is selected, the TV/VIDEO button press will skip its input.

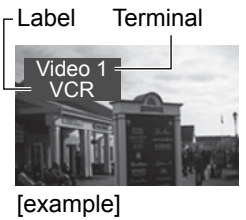

To prevent howling and image oscillation, stops output of the pictures and audio specified in this menu. (p. 28)

### ■ Select the terminal and set "Off"

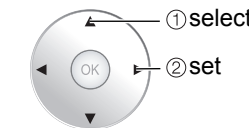
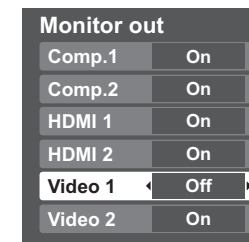

- Select "Off" to stop output of picture and audio. (Video 1/Video 2)
- Comp.1/Comp.2/HDMI 1/HDMI 2 cannot output video signals regardless of "Monitor out" setting. When equipment (STB, DVD, etc.) is connected to HDMI or COMPONENT terminals, only audio signals can be obtained. From the output terminals, no video signals can be passed.

The television includes a built-in decoder that is capable of providing a text display of the audio. The program being viewed must be transmitting Closed Caption (CC) information. (p. 43)

### ■ Select the item and set

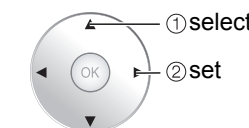
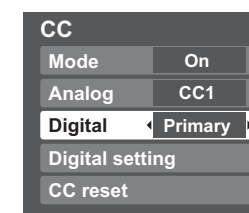

- Mode** Select "On" (when not using, select "Off").
- Analog** (Choose the Closed Caption service of Analog broadcasting.)  
CC1-4: Information related to pictures (Appears at bottom of screen)  
T1-4: Textual information (Appears over entire screen)
- Digital** (The Digital Closed Caption menu lets you configure the way you choose to view the digital captioning.)

- The settings in "Analog" or "Digital" depend on the broadcaster.

- Select the setting.  
● "Primary", "Second.", "Service 3", "Service 4", "Service 5", "Service 6"

### ■ To make more in-depth display settings in digital programs

- ① Select "Digital setting" and press OK
- ② Select the item and set

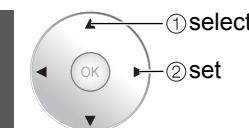
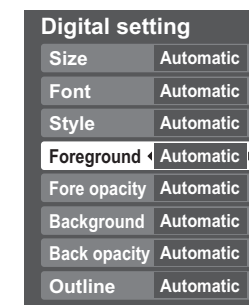

- Size: Text size
- Font: Text font
- Style: Text style (Raised, Depressed, etc.)
- Foreground: Color of text
- Fore opacity: Opacity of text
- Background: Color of text box
- Back opacity: Opacity of text box
- Outline: Outline color of text (Identify the setting options on the screen.)

### ■ To reset the settings

- Select "CC reset" and press OK

# Using Timer

The TV can automatically turn On/Off at the designated date and time.

- The Clock must be set before On time/Off time settings. (p. 18)
- The "Sleep" timer and "On / Off timer" will not function if "Auto power on" (p. 29) is set.

**1 Display menu**

**2 Select "Timer"**

**3 Select the timer to set**

■ Press to exit from menu screen



■ Press to return to the previous screen



- Sleep** Turns Off automatically
- Timer 1** Turns On/Off automatically (5 timers can be set.)
- Timer 5**

## 4 Set the timer

### ■ To set "Sleep" (Off Timer)

Set to shut the unit off after a pre-selected amount of time.

● 0/30/60/90 (minutes)

### ■ To set "Timer 1-5" (On/Off Timer)

Select the item and set

**Channel** Select the channel

**Day** Select the day

SUN/MON/TUE/WED/THU/FRI/SAT  
(displays the nearest future date)  
MON-FRI/SAT-SUN/DAILY/EVR SUN/EVR MON/  
EVR TUE/EVR WED/EVR THU/EVR FRI/ EVR SAT

**On time** The time to turn On

**Off time** The time to turn Off

**Set** Timer setting (On/Off)

#### Note

- The TV automatically turns Off after 90 minutes when turned On by the Timer. This operation will be cancelled if the Off time is selected or if a key is pressed.

# Recommended AV Connections

These diagrams show our recommendations for how to connect the TV unit to your various equipment. For other connections, consult the instructions of each piece of equipment and the specifications (p. 47). For additional assistance, please visit our website at: [www.panasonic.com](http://www.panasonic.com) [www.panasonic.ca](http://www.panasonic.ca)

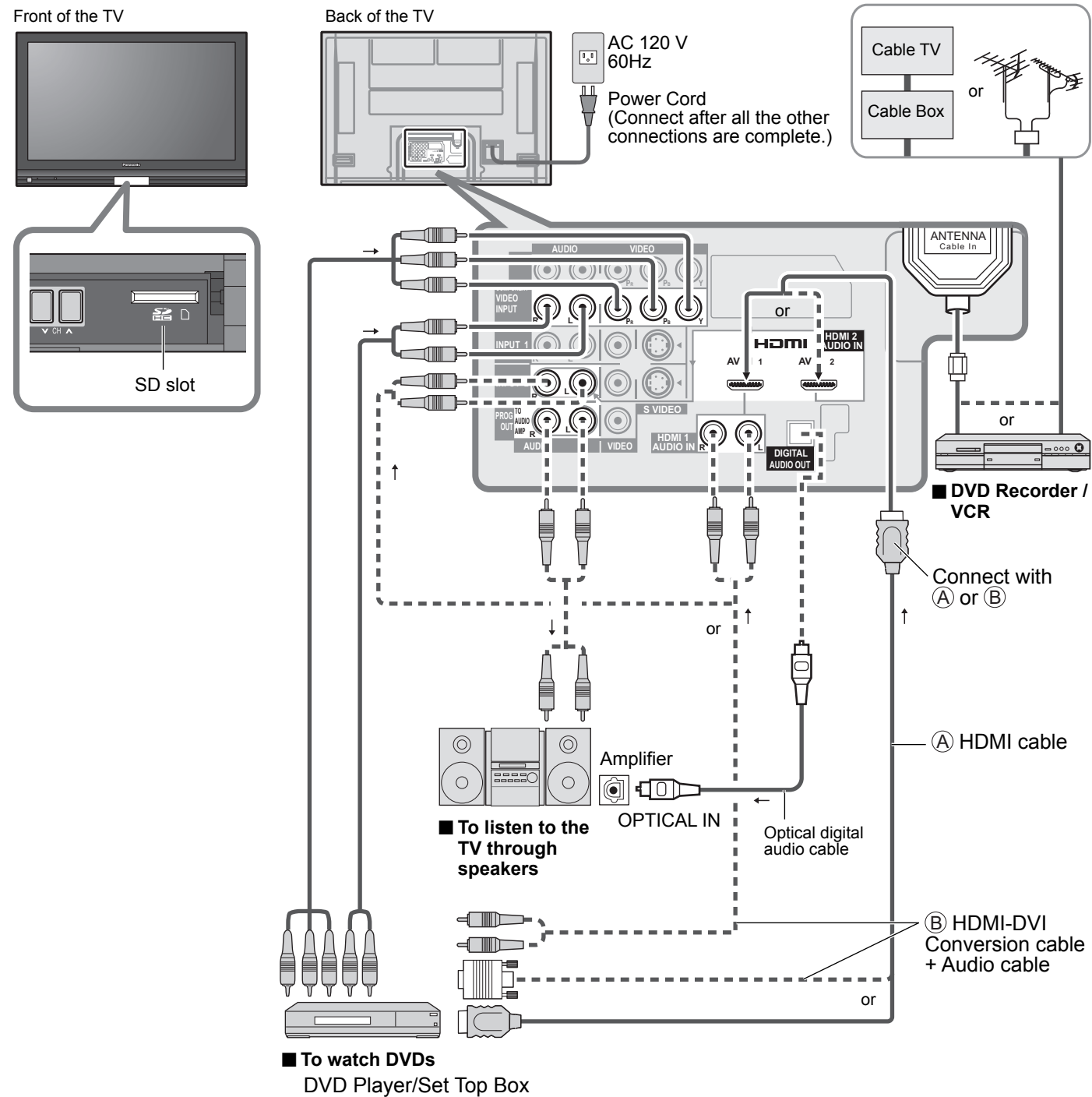

## Note

- The picture and audio input signals connected to a terminal specified in "Monitor out" (p. 36) cannot be output from "PROG OUT" terminals. However, audio output can be obtained from "DIGITAL AUDIO OUT" terminal.
- To prevent howling and image oscillation, set the "Monitor out" setting when connecting the VCR with loop-connection. (p. 28, 36)
- When equipment (STB, DVD, etc.) is connected to HDMI or COMPONENT terminals, only audio signals can be obtained. From the output terminals, no video signals can be passed.
- When receiving digital channel signals, all digital formats are down-converted to composite NTSC video to be output through the PROG OUT terminals.

## EZ Sync™ Connections

Follow the connection diagrams below for HDAVI control of a single AV piece of equipment such as a Panasonic DIGA-DVD recorder, RAM theater, or Player theater system. Refer to page 30-31 for Setup Menu settings and additional control information.

If connection (or setting) of equipment compatible with HDAVI control is changed, switch the power of this unit Off then On again while the power of all equipment is On (so that the unit can correctly recognize the connected equipment) and check that DIGA, RAM theater, and Player theater playback operate.

## Note

- Optional HDMI and/or optical cables are not provided.
- HDMI 1 is recommended. When connecting to HDMI 2, set the input mode to HDMI 2 (p. 24) initially before connecting to HDMI 2. After connection, confirm the HDMI control functions (p. 30-31).

### ■ Connecting this unit to the DIGA, RAM theater, or Player theater

- For DIGA: Connect with HDMI cable
- For RAM theater and Player theater: Connect with the HDMI and audio cables. If audio cable is not connected, you cannot listen to the TV program through the theater system.

### ■ Connecting this unit to a DVD recorder and AV amp

When using an "EZ Sync" audio-video amplifier and a compatible DIGA recorder, use a daisy chain connection as shown below.

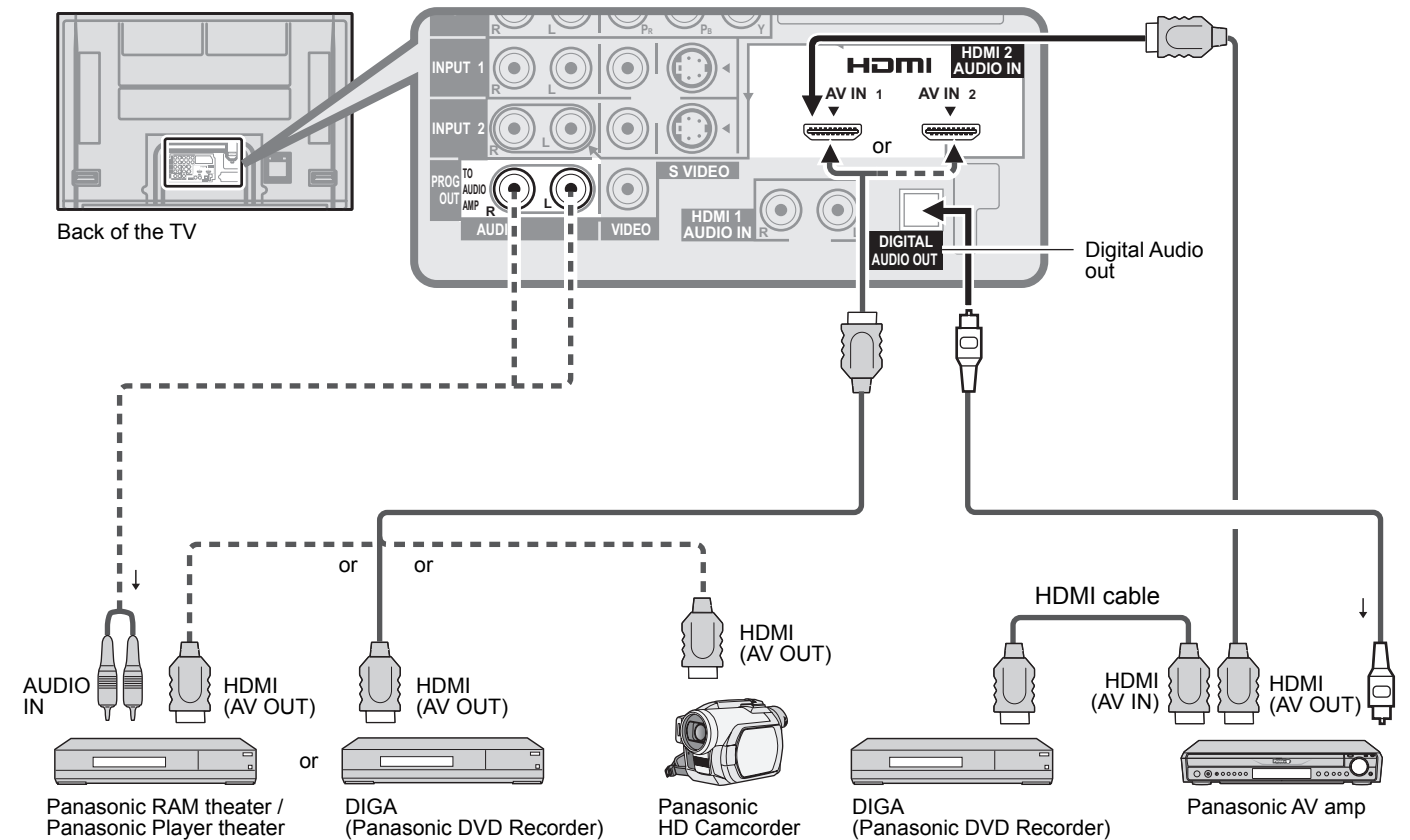

- One AV amp and one DIGA recorder can be operated with this unit.
- Be sure to connect the AV amp between this unit and the DIGA recorder.

### ■ Setting of this unit after connection

After making connections as shown above, set "EZ Sync" (under "EZ Sync setting") to "On" using the Setup menu. (p. 30-31).

## Note

- Individual HDMI equipment may require additional menu settings specific to each model. Please refer to their respective operating instruction manuals.
- When audio from other equipment connected to this unit via HDMI is output using "DIGITAL AUDIO OUT" of this unit, the system switches to 2CH audio. (When connecting to an AV amp via HDMI, you can enjoy higher sound quality.)



# Ratings List for Lock

“V-chip” technology enables you to lock channels or shows according to standard ratings set by the entertainment industry. (p. 33)

## U.S. MOVIE RATINGS (MPAA)

NR	NO RATING (NOT RATED) AND NA (NOT APPLICABLE) PROGRAMS. Movie has not been rated or rating does not apply.
G	GENERAL AUDIENCES. All ages admitted.
PG	PARENTAL GUIDANCE SUGGESTED. Some material may not be suitable for children.
PG-13	PARENTS STRONGLY CAUTIONED. Some material may be inappropriate for children under 13.
R	RESTRICTED. Under 17 requires accompanying parent or adult guardian.
NC-17	NO ONE 17 AND UNDER ADMITTED.
X	ADULTS ONLY.

## U.S. TV PROGRAMS RATINGS (U. S. TV)

Age-based Group	Age-based Ratings	Possible Content Selections	Description
NR (Not Rated)	TV-NR	● Viewable ● Blocked	Not Rated.
Youth	TV-Y	● Viewable ● Blocked	All children. The themes and elements in this program are specifically designed for a very young audience, including children from ages 2-6.
	TV-Y7	● FV Blocked ● Viewable ● Blocked	Directed to older children. Themes and elements in this program may include mild physical or comedic violence, or may frighten children under the age of 7.
Guidance	TV-G	● Viewable ● Blocked	General audience. It contains little or no violence, no strong language, and little or no sexual dialogue or situations.
	TV-PG	● D,L,S,V (all selected) ● Any combination of D, L, S, V	Parental guidance suggested. The program may contain infrequent coarse language, limited violence, some suggestive sexual dialogue and situations.
	TV-14	● D,L,S,V (all selected) ● Any combination of D, L, S, V	Parents strongly cautioned. This program may contain sophisticated themes, sexual content, strong language and more intense violence.
	TV-MA	● L,S,V (all selected) ● Any combination of L, S, V	Mature audiences only. This program may contain mature themes, profane language, graphic violence, and explicit sexual content.

FV: Fantasy/Cartoon Violence V: Violence S: Sex L: Offensive Language D: Dialogue with sexual content.

## CANADIAN ENGLISH RATINGS (C. E. L. R.)

E	Exempt - Exempt programming includes: news, sports, documentaries and other information programming, talk shows, music videos, and variety programming.
C	Programming intended for children under age 8. No offensive language, nudity or sexual content.
C8+	Programming generally considered acceptable for children 8 years and over. No profanity, nudity or sexual content.
G	General programming, suitable for all audiences.
PG	Parental Guidance suggested. Some material may not be suitable for children.
14+	Programming contains themes or content which may not be suitable for viewers under the age of 14. Parents are strongly cautioned to exercise discretion in permitting viewing by pre-teens and early teens.
18+	18+ years old. Programming restricted to adults. Contains constant violence or scenes of extreme violence.

## CANADIAN FRENCH RATINGS (C. F. L. R.)

E	Exempt - Exempt programming.
G	General - Programming intended for audience of all ages. Contains no violence, or the violence content is minimal or is depicted appropriately.
8 ans+	8+ General - Not recommended for young children. Programming intended for a broad audience but contains light or occasional violence. Adult supervision recommended.
13 ans+	Programming may not be suitable for children under the age of 13 - Contains either a few violent scenes or one or more sufficiently violent scenes to affect them. Adult supervision strongly suggested.
16 ans+	Programming may not be suitable for children under the age of 16 - Contains frequent scenes of violence or intense violence.
18 ans+	Programming restricted to adults. Contains constant violence or scenes of extreme violence.

### Caution

● The V-Chip system that is used in this set is capable of blocking “NR” programs (non rated, not applicable and none) as per FCC Rules Section 15.120(e)(2). If the option of blocking “NR” programs is chosen “unexpected and possibly confusing results may occur, and you may not receive emergency bulletins or any of the following types of programming.”

- Emergency Bulletins (Such as EAS messages, weather warnings and others)
- Locally originated programming • News • Political • Public Service Announcements • Religious • Sports • Weather

# Technical Information

## Closed Caption (CC)

- For viewing Closed Caption of digital broadcasting, set the aspect ratio to FULL. (If viewing with H-FILL, JUST, ZOOM or 4:3, characters will be cut off.)
- The Closed Caption is not displayed when you use HDMI connection.
- If analog connected equipment is used for displaying or recording, Closed Caption (CC) should be set On/Off on the connected equipment. The CC mode setting of the TV will not affect the analog input. If a digital program is being output in analog format, the CC data will also be output in analog format. If digital connected equipment is used for input, CC should be set On on either the connected equipment or the TV. If CC is set On on both the connected equipment and the TV, captions from each unit will overlap.

## Aspect Ratio

Lets you choose the aspect depending on the format of the received signal and your preference. (p. 21) (e.g.: in case of 4:3 image)

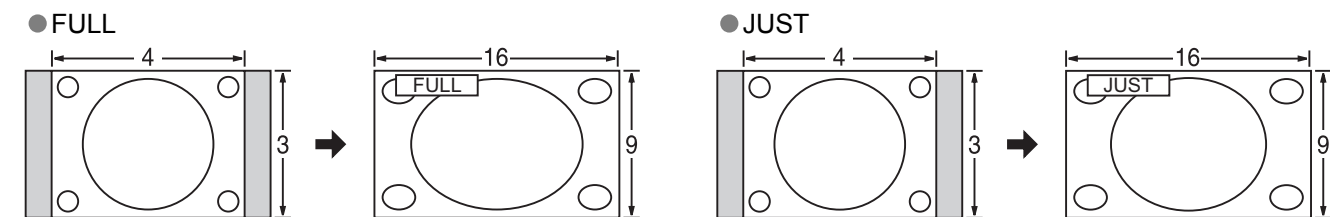

● **FULL**  
Enlarges the 4:3 image horizontally to the screen's side edges. (Recommended for anamorphic picture)

● **JUST**  
Stretches to justify the 4:3 image to the four corners of the screen. (Recommended for normal TV broadcast)

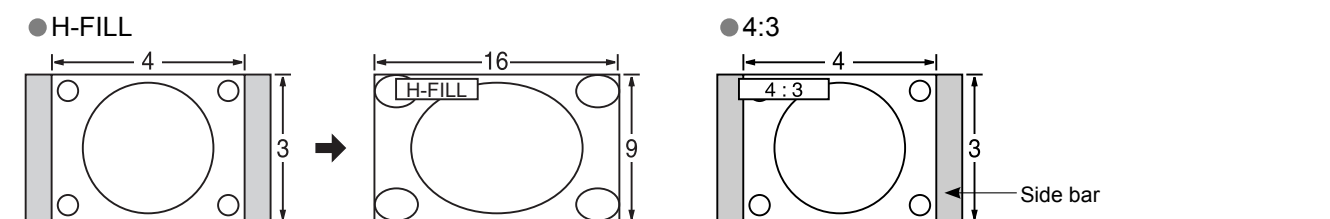

● **H-FILL**  
Enlarges the 4:3 image horizontally to the screen's side edges. The side edges of the image are cut off.

● **4:3**  
Standard (Note that “Image retention” of the side bar may occur from displaying it for a long time.)

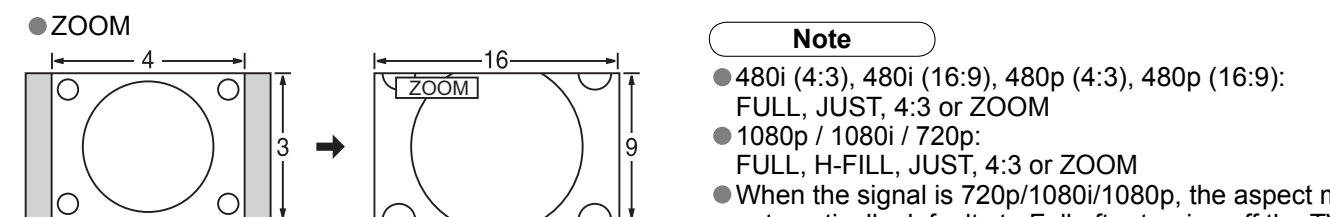

● **ZOOM**  
Enlarges the 4:3 image to the entire screen. (Recommended for Letter Box)

### Note

- 480i (4:3), 480i (16:9), 480p (4:3), 480p (16:9): FULL, JUST, 4:3 or ZOOM
- 1080p / 1080i / 720p: FULL, H-FILL, JUST, 4:3 or ZOOM
- When the signal is 720p/1080i/1080p, the aspect mode automatically defaults to Full after turning off the TV, after changing input mode, or after changed signal resolution other than 720p/1080i/1080p.

### Zoom adjust

Vertical image position and size can be adjusted in “ZOOM”.

- ① Select “Zoom adjust” on the “Picture” menu. (p. 26-27)
- ② V-position: Vertical position adjustment
- ③ V-size: Vertical size adjustment



- To reset the aspect ratio → (OK)

# Technical Information (Continued)

## Data format for SD Card browsing

Photo: Still images recorded with digital still cameras compatible with JPEG files of DCF\* and EXIF\*\* standards  
 Data format: Baseline JPEG (Sub-sampling: 4:4:4, 4:2:2 or 4:2:0)  
 Max. number of files: 9,999  
 Image resolution: 160 x 120 to 10,000,000

\* DCF (Design rule for camera file system): A Japan Electronics and Information Technology Industries Association's standard

\*\* EXIF (Exchangeable Image File Format)

### Caution

- A JPEG image modified with a PC may not be displayed.
- Partly degraded files might be displayed at a reduced resolution.

### Note

- Folder structure viewed in PC

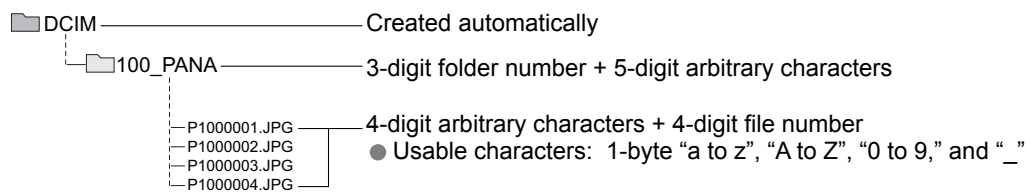

- The folder and file names may be different depending on the digital camera used.
- For the suitable SD Memory Cards, please confirm the latest information on the following website.  
<http://panasonic.co.jp/pavc/global/cs> (This site is in English only)

## SD Card warning messages

Message	Meaning
Is memory card in?	● The card is not inserted.
No file	● The card has no data or this type of data is not supported.
Cannot read file	<ul style="list-style-type: none"> <li>● The file is broken or unreadable.</li> <li>● The TV does not support the format.</li> </ul>

## GalleryPlayer warning messages

Cannot display image due to incorrect ID data.	<ul style="list-style-type: none"> <li>● There is a problem with decoder of your TV.</li> <li>● If this message appears, please contact Panasonic Service Center for assistance.                      Refer to page 51 (Customer Services Directory), page 52 (Limited Warranty)</li> </ul>
Cannot display image on SD card.	<ul style="list-style-type: none"> <li>● There is a problem with the data.                      Check the data inside the SD card.</li> </ul>

## Cautions in handling SD Card:

- Do not remove the card while the unit is accessing data (this can damage card or unit).
- Do not touch the terminals on the back of the card.
- Do not subject the card to a high pressure or impact.
- Insert the card in the correct direction (otherwise, card may be damaged).
- Electrical interference, static electricity, or erroneous operation may damage the data or card.
- Back up the recorded data at regular intervals in case of deteriorated or damaged data or erratic operation of the unit. (Panasonic is not liable for any deterioration or damage of recorded data.)

## DIGITAL AUDIO OUT terminals

You can enjoy your home theater by connecting a Dolby Digital (5.1 channel) decoder and "Multi Channel" amplifier to the DIGITAL AUDIO OUT terminals.

### Caution

- Depending on your DVD player and DVD-Audio software the copyright protection function may operate and disable optical output.
- External speakers cannot be connected directly to PROG OUT terminals.
- When an ATSC channel is selected, the output from the DIGITAL AUDIO OUT jack will be Dolby Digital. When an NTSC channel is selected, the output will be PCM.

## EZ Sync™ "HDAVI Control™"

HDMI connections to some Panasonic equipment allow you to interface automatically. (p. 30)

- This function may not work normally depending on the equipment condition.
- The equipment can be operated by other remote controls with this function on even if TV is in Standby mode.
- Image or sound may not be available for the first few seconds when the playback starts.
- Image or sound may not be available for the first few seconds when Input mode is switched.
- Volume function will be displayed when adjusting the volume of the equipment.
- If you connect the same kind of equipment at once (for example: one DIGA to HDMI 1 / another DIGA to HDMI 2), EZ Sync™ is available for the terminal with the smaller number.
- If you connect the equipment that has "HDAVI Control 2" function to the TV with HDMI cable, the sound from DIGITAL AUDIO OUT terminal can be output as multi channel surround.

## HDMI connection

HDMI (high-definition multimedia interface) allows you to enjoy high-definition digital images and high-quality sound by connecting the TV unit and the devices.

HDMI-compatible equipment (\*1) with an HDMI or DVI output terminal, such as a set-top box or a DVD player, can be connected to the HDMI connector using an HDMI compliant (fully wired) cable.

- HDMI is the world's first complete digital consumer AV interface complying with a non-compression standard.
- If the external equipment has only a DVI output, connect to the HDMI terminal via a DVI to HDMI adapter cable (\*2).
- When the DVI to HDMI adapter cable is used, connect the audio cable to the audio input terminal.
- Audio settings can be made on the "HDMI 1 in" or "HDMI 2 in" menu screen. (p. 26)  
 Applicable audio signal sampling frequencies (L.PCM): 48 kHz, 44.1 kHz, 32 kHz

(\*1): The HDMI logo is displayed on an HDMI-compliant device.

(\*2): Enquire at your local digital equipment retailer shop.

### Caution

- Use with a PC is not assumed.
- All signals are reformatted before being displayed on the screen.
- If the connected device has an aspect adjustment function, set the aspect ratio to "16:9".
- This HDMI connector is "type A".
- These HDMI connectors are compatible with HDCP (High-Bandwidth Digital Content Protection) copyright protection.
- A device having no digital output terminal may be connected to the input terminal of either "COMPONENT", "S VIDEO", or "VIDEO" to receive analog signals.
- The HDMI input terminal can be used with only the following image signals: 480i, 480p, 720p, 1080i and 1080p.  
 Match the output setting of the digital device.
- For details of the applicable HDMI signals, see below.

## Input signals that can be displayed

\* Mark: Applicable input signal for Component (Y, Pb, Pr) and HDMI

	horizontal frequency (kHz)	vertical frequency (Hz)	COMPONENT	HDMI
525 (480) / 60i	15.73	59.94	*	*
525 (480) / 60p	31.47	59.94	*	*
750 (720) / 60p	45.00	59.94	*	*
1,125 (1,080) / 60i	33.75	59.94	*	*
1,125 (1,080) / 60p	67.43	59.94		*
1,125 (1,080) / 60p	67.50	60.00		*

### Note

- Signals other than those shown above may not be displayed properly.
- The above signals are reformatted for optimal viewing on your display.

## Side Bar

Do not display a picture in 4:3 mode for an extended period, as this can cause "Image retention" to remain on either or both sides of the display field.

To reduce the risk of such "Image retention", change the brightness of the side bars.

- The side bar may flash (alternate black/white) depending on the picture. Using Cinema mode will reduce such flashing (See below).

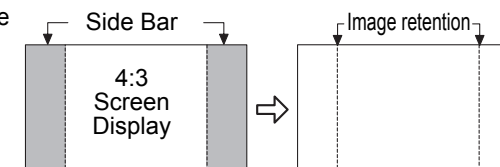

## Picture mode

- Vivid (default): Provides enhanced picture contrast and sharpness for viewing in a well-lit room.
- Standard: Recommended for normal viewing conditions with subdued room lighting.
- Cinema: For watching movies in a darkened room. It provides a soft, film-like picture.
- Custom (Photo): Customizes each item according to your taste.  
 Photo is displayed in Jpeg menu.

# Maintenance

First, unplug the Power cord plug from the wall outlet.

## Display panel

The front of the display panel has been specially treated. Wipe the panel surface gently using only a cleaning cloth or a soft, lint-free cloth.

- If the surface is particularly dirty, soak a soft, lint-free cloth in diluted neutral detergent (1 part detergent diluted by 100 times the amount of water) and then wring the cloth to remove excess liquid. Use this cloth to wipe the surface of the display panel, then wipe it evenly with a dry cloth of the same type until the surface is dry.
- Do not scratch or hit the surface of the panel with fingernails or other hard objects. Furthermore, avoid contact with volatile substances such as insect sprays, solvents, and thinner; otherwise, the quality of the surface may be adversely affected.

## Cabinet

If the cabinet becomes dirty, wipe it with a soft, dry cloth.

- If the cabinet is particularly dirty, soak the cloth in a weak detergent solution and then wring the cloth dry. Use this cloth to wipe the cabinet and then wipe it dry with a dry cloth.
- Do not allow any detergent to come into direct contact with the surface of the Plasma TV. If water droplets get inside the unit, operating problems may result.
- Avoid contact with volatile substances such as insect sprays, solvents, and thinner; otherwise, the quality of the cabinet surface may be adversely affected or the coating may peel off. Furthermore, do not leave it for long periods in contact with articles made from rubber or PVC.

## Pedestal

- **Cleaning**  
Wipe the surfaces with a soft, dry cloth. If the unit is particularly dirty, clean it using a cloth soaked with water to which a small amount of neutral detergent has been added and then wipe with a dry cloth. Do not use products such as solvents, thinner, or household wax for cleaning, as they can damage the surface coating. (If using a chemically-treated cloth, follow the instructions supplied with the cloth.)
- Do not attach sticky tape or labels, as they can make the surface of the pedestal dirty. Do not allow long-term contact with rubber, vinyl products, or the like. (Doing so will cause deterioration.)

# Specifications

		TH-42PX75U	TH-50PX75U
<b>Power Source</b>		AC 120 V, 60 Hz	
<b>Power Consumption</b>	<b>Maximum</b>	387 W	499 W
	<b>Standby condition</b>	0.2 W	0.2 W
<b>Plasma Display panel</b>	<b>Drive method</b>	AC type	
	<b>Aspect Ratio</b>	16:9	
	<b>Visible screen size (W × H × Diagonal)</b> <b>(No. of pixels)</b>	106 cm 36.3" × 20.3" × 41.6" (922 mm × 518 mm × 1,057 mm)	127 cm 43.5" × 24.4" × 49.9" (1,106 mm × 622 mm × 1,269 mm)
<b>Sound</b>	<b>Audio Output</b>	20 W [ 10 W + 10 W ] ( 10 % THD )	
	<b>Channel Capability (Digital/Analog)</b>	VHF/ UHF: 2 - 69, CATV: 1 - 135	
<b>Operating Conditions</b>		Temperature: 32 °F – 104 °F (0 °C – 40 °C) Humidity: 20 % – 80 % RH (non-condensing)	
<b>Connection Terminals</b>	<b>INPUT 1-2</b>	VIDEO: RCA PIN Type × 1 1.0 V [p-p] (75 Ω) S-VIDEO: Mini DIN 4-pin Y: 1.0 V [p-p] (75 Ω) C: 0.286 V [p-p] (75 Ω) AUDIO L-R: RCA PIN Type × 2 0.5 V [rms]	
	<b>COMPONENT VIDEO INPUT 1-2</b>	Y: 1.0 V [p-p] (including synchronization) PB, PR: ±0.35 V [p-p] AUDIO L-R: RCA PIN Type × 2 0.5 V [rms]	
	<b>HDMI 1-2</b>	TYPE A Connector × 2 ● This TV supports "HDAVI Control 2" function.	
	<b>AUDIO IN</b>	AUDIO L-R: RCA PIN Type × 2 0.5 V [rms]	
	<b>Card slot</b>	SD CARD slot × 1	
	<b>AV PROG. OUT</b>	VIDEO: RCA PIN Type × 1 1.0 V [p-p] (75 Ω) AUDIO L-R: RCA PIN Type × 2 0.5 V [rms]	
	<b>DIGITAL AUDIO OUT</b>	PCM / Dolby Digital, Fiber Optic	
<b>FEATURES</b>		3D Y/C FILTER CLOSED CAPTION V-Chip Photo Viewer HDAVI Control 2	
<b>Dimensions (W × H × D)</b>	<b>Including pedestal</b>	40.2" × 28.7" × 13.0" (1,020 mm × 727 mm × 330 mm)	47.7" × 33.2" × 14.6" (1,210 mm × 841 mm × 369 mm)
	<b>TV Set only</b>	40.2" × 26.8" × 3.8" (1,020 mm × 680 mm × 97 mm)	47.7" × 31.3" × 3.8" (1,210 mm × 793 mm × 97 mm)
<b>Mass</b>	<b>Including pedestal</b>	75.0 lb. (34 kg)	99.2 lb. (45 kg)
	<b>TV Set only</b>	59.6 lb. (27 kg)	83.8 lb. (38 kg)

[TH-42PX75U]

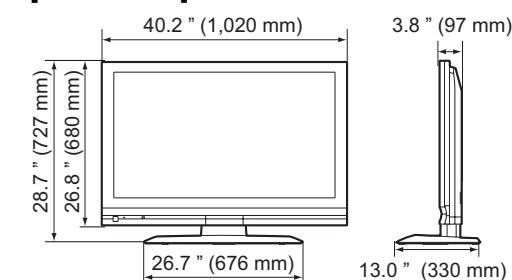

[TH-50PX75U]

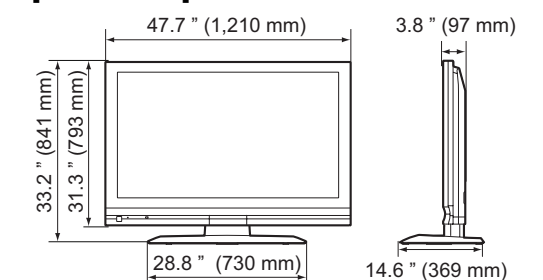

### Note

- Design and Specifications are subject to change without notice. Weight and Dimensions shown are approximate.



# FAQ

Before requesting service or assistance, please follow these simple guides to resolve the problem.  
 If the problem still persists, please contact your local Panasonic dealer or Panasonic Service Center for assistance.  
 For details (p. 51, 52)  
 For additional assistance, please contact us via the website at:  
[www.panasonic.com/contactinfo](http://www.panasonic.com/contactinfo)  
[www.panasonic.ca](http://www.panasonic.ca)

## White spots or shadow images (noise)

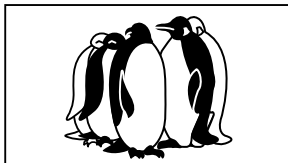

- Check the position, direction, and connection of the aerial.

## Interference or frozen digital channels (intermittent sound)

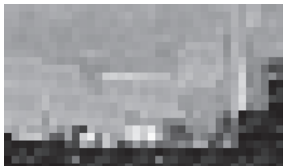

- Change the direction of antenna for digital channels.
- Check "Signal meter" (p. 35). If the signal is weak, check the antenna and consult your local dealer.

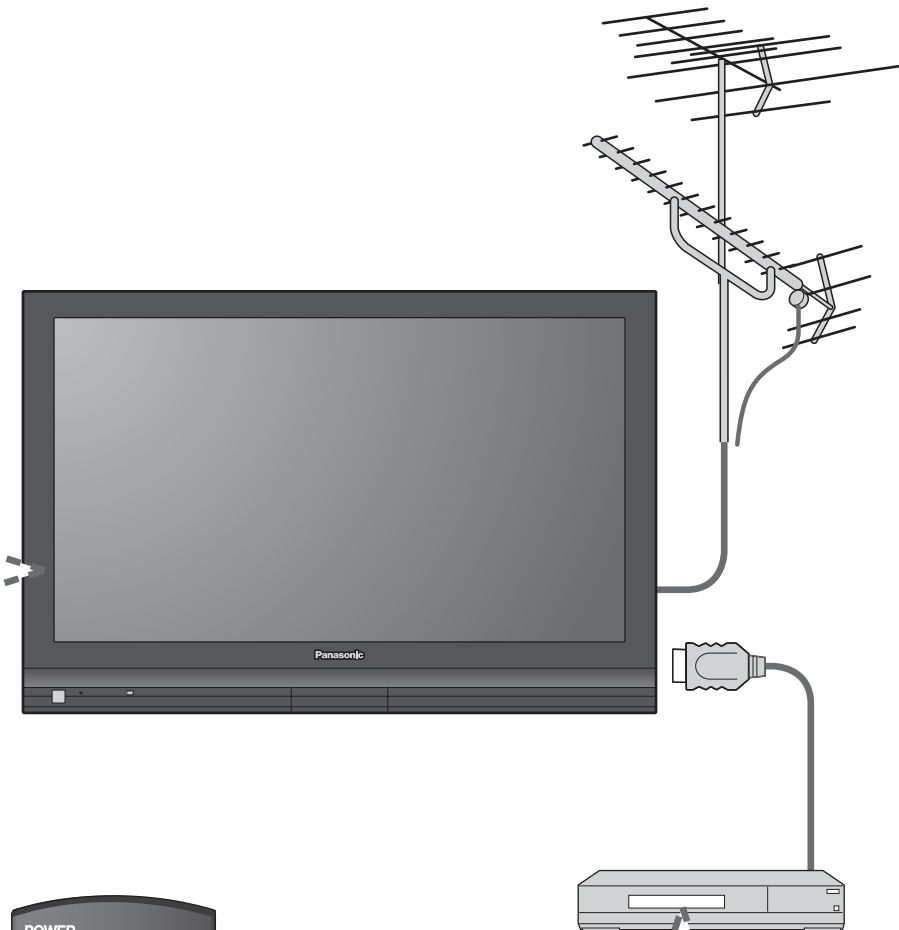

## Pictures from external equipment are distorted when the unit is connected via HDMI

- Is the HDMI cable connected properly? (p. 40-41)
- Turn Off the TV unit and equipment, then turn them On again.
- Check an input signal from the equipment. (p. 45)
- Use equipment compliant with EIA/CEA-861/861B.

## The remote control does not work

- Are the batteries installed correctly? (p. 6)
- Has the battery run down?

If there is a problem with your TV, please refer to the table below to determine the symptoms, then carry out the suggested check. If this does not solve the problem, please contact your local Panasonic dealer, quoting the model number and serial number (both found on the rear of the TV).

	Problem	Actions
Screen	"Press any key to return" moves on the screen	<ul style="list-style-type: none"> <li>● The function to prevent "Image retention" is activated. (Not a faulty symptom)</li> <li>● The screen saver is activated if the TV unit is not operated for a certain time in SD mode.</li> <li>● "Image retention" (p. 5)</li> </ul>
	One spot remains dark	<ul style="list-style-type: none"> <li>● A pixel or luminescent spot can occasionally be missing in plasma displays. (Not a faulty symptom)</li> </ul>
	Chaotic image, noisy	<ul style="list-style-type: none"> <li>● Check nearby electrical products (car, motorcycle, fluorescent lamp).</li> </ul>
	No image can be displayed	<ul style="list-style-type: none"> <li>● Check Picture menu (p. 26)</li> </ul>
	Only spots are displayed instead of images	<ul style="list-style-type: none"> <li>● Check the channel settings. (p. 34)</li> <li>● Check the antenna cables.</li> </ul>
	Neither image nor sound is produced	<ul style="list-style-type: none"> <li>● Is the AC power cord plugged into the outlet?</li> <li>● Is the TV unit turned On?</li> <li>● Check Picture menu (p. 26) and volume.</li> </ul>
Sound	Black Box appears	<ul style="list-style-type: none"> <li>● Change settings of Closed Caption (CC). (p. 36)</li> </ul>
	No sound is produced	<ul style="list-style-type: none"> <li>● Are the speakers' cables connected correctly? (p. 40)</li> <li>● Is "Sound Mute" active? (p. 17)</li> <li>● Is the volume set to the minimum?</li> <li>● Is "Speaker output" set to "Off"? (p. 26)</li> <li>● Change "SAP" settings. (p. 20)</li> <li>● Check "HDMI 1 in" or "HDMI 2 in" settings. (p. 26)</li> </ul>
	Sound is unusual	<ul style="list-style-type: none"> <li>● Set "SAP" setting to "Stereo" or "Mono."</li> <li>● Check the HDMI device connected to the unit.</li> <li>● Set the audio setting of the HDMI device to "Linear PCM."</li> <li>● If digital sound connection has a problem, select analog sound connection.</li> </ul>

# Limited Warranty (for U.S.A.)

PANASONIC CONSUMER ELECTRONICS COMPANY,  
DIVISION OF  
PANASONIC CORPORATION OF NORTH AMERICA  
One Panasonic Way  
Secaucus, New Jersey 07094

PANASONIC SALES COMPANY,  
DIVISION OF  
PANASONIC PUERTO RICO, INC.  
Ave. 65 de Infantería, Km. 9.5  
San Gabriel Industrial Park  
Carolina, Puerto Rico 00985

## Panasonic Color Television Limited Warranty

### Limited Warranty Coverage

If your product does not work properly because of a defect in materials or workmanship, Panasonic Consumer Electronics Company or Panasonic Puerto Rico, Inc. (collectively referred to as "the warrantor") will, for the length of the period indicated on the chart below, which starts with the date of original purchase ("Limited Warranty period"), at its option either (a) repair your product with new or refurbished parts, or (b) replace it with a new or a refurbished product. The decision to repair or replace will be made by the warrantor.

CATEGORIES	ALL PARTS EXCEPT GLASS PANEL OR CRT	LABOR	GLASS PANEL OR CRT	GLASS PANEL OR CRT LABOR	SERVICE
PLASMA DISPLAY	1 (ONE) YEAR	1 (ONE) YEAR	GLASS PANEL - 2 (TWO) YEARS	1 (ONE) YEAR	IN-HOME OR CARRY-IN

During the "Labor" Limited Warranty period there will be no charge for labor. During the "Parts" Limited Warranty period, there will be no charge for parts.

You must carry-in your product or arrange for in-home service during the Limited Warranty period. If non-rechargeable batteries are included, they are not warranted. This Limited Warranty only applies to products purchased and serviced in the United States or Puerto Rico. This Limited Warranty is extended only to the original purchaser and only covers product purchased as new. A purchase receipt or other proof of the original purchase date is required for Limited Warranty service.

### In-Home or Carry-in Service

For In-Home or Carry-In Service in the United States call 1-888-VIEW-PTV(1-888-843-9788).  
For assistance in Puerto Rico call Panasonic Puerto Rico, Inc. (787)-750-4300 or fax (787)-768-2910.

In-Home service requires clear, complete and easy access to the product by the authorized servicer and does not include removal or re-installation of an installed product. It is possible that certain in-home repairs will not be completed in-home, but will require that the product, or parts of the product, be removed for shop diagnosis and/or repair and then returned.

### Limited Warranty Limits And Exclusions

This Limited Warranty ONLY COVERS failures due to defects in materials or workmanship, and DOES NOT COVER normal wear and tear or cosmetic damage, nor does it cover markings or retained images on the picture tube resulting from viewing fixed images (including, among other things, letterbox pictures on standard 4:3 screen TV's, or non-expanded standard 4:3 pictures on wide screen TV's, or onscreen data in a stationary and fixed location). The Limited Warranty ALSO DOES NOT COVER damages which occurred in shipment, or failures which are caused by products not supplied by the warrantor, or failures which result from accidents, misuse, abuse, neglect, bug infestation, mishandling, misapplication, alteration, faulty installation, set-up adjustments, misadjustment of consumer controls, improper maintenance, power line surge, lightning damage, modification, or commercial use (such as in a hotel, office, restaurant, or other business), rental use of the product, service by anyone other than a Factory Service Center or other Authorized Servicer, or damage that is attributable to acts of God.

**THERE ARE NO EXPRESS WARRANTIES EXCEPT AS LISTED UNDER "LIMITED WARRANTY COVERAGE". THE WARRANTOR IS NOT LIABLE FOR INCIDENTAL OR CONSEQUENTIAL DAMAGES RESULTING FROM THE USE OF THIS PRODUCT, OR ARISING OUT OF ANY BREACH OF THIS LIMITED WARRANTY.** (As examples, this excludes damages for lost time, cost of having someone remove or re-install an installed unit if applicable, or travel to and from the servicer. The items listed are not exclusive, but are for illustration only.) **ALL EXPRESS AND IMPLIED WARRANTIES, INCLUDING THE LIMITED WARRANTY OF MERCHANTABILITY, ARE LIMITED TO THE PERIOD OF THE LIMITED WARRANTY.**

Some states do not allow the exclusion or limitation of incidental or consequential damages, or limitations on how long an implied Limited Warranty lasts, so the exclusions may not apply to you.

This Limited Warranty gives you specific legal rights and you may also have others rights which vary from state to state. If a problem with this product develops during or after the Limited Warranty period, you may contact your dealer or Service Center. If the problem is not handled to your satisfaction, then write to the warrantor's Consumer Affairs Department at the addresses listed for the warrantor.

**PARTS AND SERVICE (INCLUDING COST OF AN IN-HOME SERVICE CALL, WHERE APPLICABLE) WHICH ARE NOT COVERED BY THIS LIMITED WARRANTY ARE YOUR RESPONSIBILITY.**

# Customer Services Directory (for U.S.A.)

## Customer Services Directory

Obtain Product Information and Operating Assistance; locate your nearest Dealer or Service Center; purchase Parts and Accessories; or make Customer Service and Literature requests by visiting our Web Site at:

<http://www.panasonic.com/consumersupport>

or, contact us via the web at:

<http://www.panasonic.com/contactinfo>

You may also contact us directly at:

1-888-VIEW-PTV (843-9788)

Monday-Friday 9 am-9 pm; Saturday-Sunday 10 am-7 pm, EST.

■ For hearing or speech impaired TTY users, TTY: 1-877-833-8855

## Accessory Purchases

Purchase Parts, Accessories and Instruction Books on line for all Panasonic Products by visiting our Web Site at:

<http://www.pstc.panasonic.com>

or, send your request by E-mail to:

[npcparts@us.panasonic.com](mailto:npcparts@us.panasonic.com)

You may also contact us directly at:

1-800-332-5368 (Phone) 1-800-237-9080 (Fax Only) (Monday - Friday 9 am to 8 pm, EST.)

Panasonic Service and Technology Company

20421 84th Avenue South,

Kent, WA 98032

(We Accept Visa, MasterCard, Discover Card, American Express, and Personal Checks)

■ For hearing or speech impaired TTY users, TTY: 1-866-605-1277

## Service in Puerto Rico

Panasonic Puerto Rico, Inc.

Ave. 65 de Infantería, Km. 9.5, San Gabriel Industrial Park,

Carolina, Puerto Rico 00985

Phone (787)750-4300, Fax (787)768-2910

