

Panasonic[®]

Model No.
TC-55CX400U

Owner's Manual

55" Class 4K2K

LED UHD TV

(54.6 inches measured diagonally)

For assistance (U.S.A./Puerto Rico), please call:

1-844-246-0582

www.panasonic.com/support



Register online at
www.panasonic.com/register
(U.S. customers only)

This product incorporates the following software:

- (1) the software developed independently by or for Panasonic Corporation,
- (2) the software owned by third party and licensed to Panasonic Corporation,
- (3) the software licensed under the GNU General Public License, Version 2.0 (GPL V2.0),
- (4) the software licensed under the GNU LESSER General Public License, Version 2.1 (LGPL V2.1), and/or
- (5) open source software other than the software licensed under the GPL V2.0 and/or LGPL V2.1.

The software categorized as (3) - (5) are distributed in the hope that it will be useful, but WITHOUT ANY WARRANTY, without even the implied warranty of MERCHANTABILITY or FITNESS FOR A PARTICULAR PURPOSE. Please refer to the detailed terms and conditions thereof [shown in the Player Settings menu.]

1 displayed by selecting [Setup] > [Tablet Information] > [Legal Information] > [Open Source License] from the Home screen

2 shown in the Player Settings menu

At least three (3) years from delivery of this product, Panasonic will give to any third party who contacts us at the contact information provided below, for a charge no more than our cost of physically performing source code distribution, a complete machine-readable copy of the corresponding source code covered under GPL V2.0, LGPL V2.1 or the other licenses with the obligation to do so, as well as the respective copyright notice thereof.

Contact Information: HYPERLINK "mailto:oss-cd-request@gg.jp.panasonic.com" oss-cd-request@gg.jp.panasonic.com

The source code and the copyright notice are also available for free in our website below.

<http://panasonic.net/avc/oss/index.html>

"PlayReady" is a trademark registered by Microsoft. Please be aware of the following.

(a) This product contains technology subject to certain intellectual property rights of Microsoft. Use or distribution of this technology outside of this product is prohibited without the appropriate license(s) from Microsoft.

(b) Content owners use Microsoft PlayReady™ content access technology to protect their intellectual property, including copyrighted content. This device uses PlayReady technology to access PlayReady-protected content and/or WMDRM-protected content. If the device fails to properly enforce restrictions on content usage, content owners may require Microsoft to revoke the device's ability to consume PlayReady-protected content. Revocation should not affect unprotected content or content protected by other content access technologies. Content owners may require you to upgrade PlayReady to access their content. If you decline an upgrade, you will not be able to access content that requires the upgrade.



The terms HDMI and HDMI High-Definition Multimedia Interface, and the HDMI logo are trademarks or registered trademarks of HDMI Licensing LLC in the United States and other countries.



Manufactured under license from Dolby Laboratories. Dolby and the double-D symbol are trademarks of Dolby Laboratories.

Contents

- Safety Precautions4
- Accessories/Optional Accessories8
- Connections11
- Identifying Controls15
- First Time Setup17
- Customizing TV Settings18
- Frequently Asked Questions (FAQ)27
- Care and Cleaning28
- Specifications29
- Limited Warranty
(for U.S.A.).....30

Safety Precautions

Note to CATV System Installer

This reminder is provided to direct the CATV system installer's attention to Article 820-40 of the NEC that provides guidelines for proper grounding and, in particular, specifies that the cable ground shall be connected to the grounding system of the building, as close to the point of cable entry as practical.

Secure Ventilation

Slots and openings in the cabinet and the back or bottom are provided for ventilation, and to ensure reliable operation of the LCD TV and to protect it from overheating. These openings must not be blocked or covered. There should be at least 4 inches (10 cm) of space around the TV. The openings should never be blocked by placing the LCD TV on a bed, sofa, rug or other similar surface. This LCD TV should not be placed in a built-in installation such as a bookcase unless proper ventilation is provided.

Important Safety Instructions (TV set)

1. Read these instructions.
2. Keep these instructions.
3. Heed all warnings.
4. Follow all instructions.
5. Do not use this apparatus near water.
6. Clean only with dry cloth.
7. Do not block any ventilation openings. Install in accordance with the manufacturer's instructions.
8. Do not install near any heat sources such as radiators, heat registers, stoves or other apparatus (including amplifiers) that produce heat.
9. Do not defeat the safety purpose of the polarized or grounding-type plug. A polarized plug has two blades with one wider than the other. A grounding type plug has two blades and a third grounding prong. The wide blade or the third prong are provided for your safety. If the provided plug does not fit into your outlet, consult an electrician for replacement of the obsolete outlet.
10. Protect the power cord from being walked on or pinched particularly at plugs, convenience receptacles, and the point where they exit from the apparatus.
11. Only use attachments / accessories specified by the manufacturer.
12. Use only with the cart, stand, tripod, bracket or table specified by the manufacturer, or sold with the apparatus. When a cart is used, use caution when moving the cart / apparatus combination to avoid injury from tip-over.
13. Unplug this apparatus during lightning storms or when unused for long periods of time.
14. Refer all servicing to qualified service personnel. Servicing is required when the apparatus has been damaged in any way, such as power-supply cord or plug is damaged, liquid has been spilled or objects have fallen into the apparatus, the apparatus has been exposed to rain or moisture, does not operate normally, or has been dropped.
15. Please keep the unit in a well-ventilated environment.
16. **WARNING:** To reduce the risk of fire or electric shock, do not expose this apparatus to rain or moisture. The apparatus should not be exposed to dripping or splashing. Objects filled with liquids, such as vases should not be placed on apparatus.
17. **WARNING:** The batteries shall not be exposed to excessive heat such as sunshine, fire or the like.
18. **CAUTION:** The Power switch on this unit will not completely shut off all power from AC outlet. Since the power cord serves as the main disconnect device for the unit, you will need to unplug it from the AC outlet to shut down all power. Therefore, make sure the unit has been installed so that the power cord can be easily unplugged from AC outlet in case of an accident. To avoid fire hazard, the power cord should also be unplugged from the AC outlet when left unused for a long period of time (for example, when on vacation).
19. **WARNING:** To reduce the risk of electric shock, do not remove cover (or back) as there are no user-serviceable parts inside. Refer servicing to qualified personnel.



This lightning flash with arrowhead symbol within an equilateral triangle is intended to alert the user to the presence of non-insulated "dangerous voltage" within the product's enclosure that may be of sufficient magnitude to constitute a risk of electric shock.



The exclamation point within an equilateral triangle is intended to alert the user to the presence of important operating and maintenance instructions in the literature accompanying the appliance.



This equipment is a Class II or double insulated electrical appliance. It has been designed in such a way that it does not require a safety connection to electrical earth.



This product contains electrical or electronic materials. The presence of these materials may, if not disposed of properly, have potential adverse effects on the environment and human health. Presence of this label on the product means it should not be disposed of as unsorted waste and must be collected separately. As a consumer, you are responsible for ensuring that this product is disposed of properly.

20. Operate only from the type of power source indicated on the marking label. If you are not sure of the type of power supplied to your home, consult your television dealer or local power company.
21. Follow all warnings and instructions marked on the LCD TV.
22. Never push objects of any kind into this LCD TV through cabinet slots as they may touch dangerous voltage points or short out parts that could result in a fire or electric shock. Never spill liquid of any kind on the LCD TV.

23. If an outside antenna is connected to the television equipment, be sure the antenna system is grounded so as to provide some protection against voltage surges and built up static charges. In the U.S. Section 810-21 of the National Electrical Code provides information with respect to proper grounding of the mast and supporting structure, grounding of the lead-in wire to an antenna discharge unit, size of grounding conductors, location of antenna discharge unit, connection to grounding electrodes, and requirements for the grounding electrode.

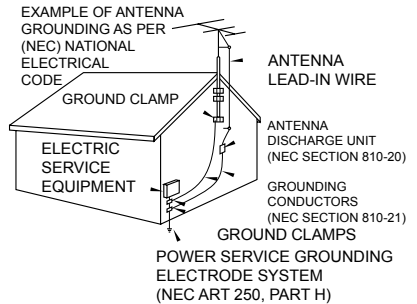

24. An outside antenna system should not be located in the vicinity of overhead power lines, other electric light, power circuits, or where it can fall into such power lines or circuits. When installing an outside antenna system, extreme care should be taken to keep from touching such power lines or circuits as contact with them might be fatal.

25. Unplug this LCD TV from the wall outlet and refer servicing to qualified service personnel under the following conditions:
 - a. When the power cord or plug is damaged or frayed.
 - b. If liquid has been spilled into the LCD TV.
 - c. If the LCD TV has been exposed to rain or water.
 - d. If the LCD TV does not operate normally by following the operating instructions.

Adjust only those controls that are covered by the operating instructions as improper adjustment of other controls may result in damage and will often require extensive work by a qualified technician to restore the LCD TV to normal operation.

- e. If the LCD TV has been dropped or the cabinet has been damaged.
 - f. When the LCD TV exhibits a distinct change in performance - this indicates a need for service.
26. When replacement parts are required, be sure the service technician uses replacement parts specified by the manufacturer that have the same characteristics as the original parts. Unauthorized substitutions may result in fire, electric shock, or other hazards.

27. **WARNING: SMALL PARTS CAN PRESENT CHOKING HAZARD IF ACCIDENTALLY SWALLOWED. KEEP SMALL PARTS AWAY FROM YOUNG CHILDREN. DISCARD UNNEEDED SMALL PARTS AND OTHER OBJECTS, INCLUDING PACKAGING MATERIALS AND PLASTIC BAGS/SHEETS TO PREVENT THEM FROM BEING PLAYED WITH BY YOUNG CHILDREN, CREATING THE POTENTIAL RISK OF SUFFOCATION.**

28. **WARNING: DO NOT USE THIS TV NEAR ANY AUTOMATIC CONTROL DEVICES SUCH AS AUTOMATIC DOORS OR FIRE ALARMS. RADIO WAVES FROM THIS TV MAY INTERFERE WITH THE AUTOMATIC CONTROL DEVICES AND CAUSE ACCIDENTS DUE TO THE MALFUNCTION.**

29. **WARNING: KEEP THIS TV AWAY AT LEAST 9 INCHES (22 CM) FROM THE LOCATION WHERE A CARDIAC PACEMAKER IS IMPLANTED. RADIO WAVES FROM THIS TV MAY INTERFERE WITH THE OPERATION OF THE PACEMAKER**

30. **CAUTION: TO PREVENT ELECTRIC SHOCK, DO NOT USE THIS PLUG WITH A RECEPTACLE OR OTHER OUTLET UNLESS THE BLADES CAN BE FULLY INSERTED TO PREVENT BLADE EXPOSURE.**

31. **CAUTION: USE WITH OTHER STAND MAY RESULT IN INSTABILITY POSSIBLY CAUSING INJURY.**

32. **CAUTION: DANGER OF EXPLOSION IF BATTERY IS INCORRECTLY REPLACED. REPLACE ONLY WITH THE SAME OR EQUIVALENT TYPE.**

33. **WARNING: To prevent fire ignition, keep candles or other open flames away from this product at all times.**

34. **WARNING: Do not place this TV in any medical institutions or locations with medical devices. Radio waves from this TV may interfere with medical devices and cause accidents due to the malfunction.**

FCC and IC STATEMENT

FCC Caution:

To assure continued compliance, follow the attached installation instructions and use only shielded interface cables when connecting to peripheral devices. Any changes or modifications not expressly approved by Panasonic Corp. of North America could void the user's authority to operate this device.

<Only for wireless LAN if capable of transmission in the 2.400 ~ 2.4835 GHz frequency band>

This product is restricted to indoor use due to its operation in the 2.400 to 2.4835 GHz frequency range. FCC and IC require this product to be used indoors for the frequency range 2.400 to 2.4835 GHz to reduce the potential for harmful interference to co-channel Mobile Satellite systems. These radar stations can cause interference with and/or damage this product.

Responsible Party:	Panasonic Corporation of North America Two Riverfront Plaza, Newark, NJ 07102-5490
Contact Source:	Panasonic Consumer Electronics Company 1-844-246-0582 www.panasonic.com/support

FCC STATEMENT

This device complies with Part 15 of the FCC Rules. Operation is subject to the following two conditions:

- (1) This device may not cause harmful interference, and
- (2) This device must accept any interference received, including interference that may cause undesired operation.

Changes or modifications not expressly approved by the party responsible for compliance could void the user's authority to operate the equipment.

NOTE: This equipment has been tested and found to comply with the limits for a Class B digital device, pursuant to Part 15 of the FCC Rules. These limits are designed to provide reasonable protection against harmful interference in a residential installation.

This equipment generates uses and can radiate radio frequency energy and, if not installed and used in accordance with the instructions, may cause harmful interference to radio communications. However, there is no guarantee that interference will not occur in a particular installation. If this equipment does cause harmful interference to radio or television reception, which can be determined by turning the equipment off and on, the user is encouraged to try to correct the interference by one or more of the following measures:

Reorient or relocate the receiving antenna.

Increase the separation between the equipment and receiver.

Connect the equipment into an outlet on a circuit different from that to which the receiver is connected.

Consult the dealer or an experienced radio/TV technician for help.

FCC Radiation Exposure Statement

This equipment complies with FCC radiation exposure limits set forth for an uncontrolled environment. This equipment should be installed and operated with minimum distance 20cm between the radiator & your body.

CEA CHILD SAFETY NOTICES

WARNING

Flat panel displays are not always supported on the proper stands or installed according to the manufacturer's recommendations. Flat panel displays that are inappropriately situated on dressers, bookcases, shelves, desks, speakers, chests, or carts may fall over and may cause personal injury or even death.

The consumer electronics industry (of which Panasonic is a member) is committed to making home entertainment enjoyable and safe. To prevent personal injury or death, be sure to follow the following safety guidelines:

TUNE INTO SAFETY:

- One size does NOT fit all. Follow the manufacturer's recommendations for the safe installation and use of your flat panel display.
- Carefully read and understand all enclosed instructions for proper use of this product.
- Don't allow children to climb on or play with furniture and television sets.
- Don't place flat panel displays on furniture that can easily be used as steps, such as a chest of drawers.
- Remember that children can become excited while watching a program, especially on "larger than life" flat panel displays. Care should be taken to install the display where it cannot be pushed, pulled over, or knocked down.
- Care should be taken to route all cords and cables connected to the flat panel display so that they cannot be pulled or grabbed by curious children.

WALL MOUNTING: IF YOU DECIDE TO WALL MOUNT YOUR FLAT PANEL DISPLAY, ALWAYS:

- Use a mount that has been recommended by the display manufacturer and/or listed by an independent laboratory (such as UL, CSA, ETL).
- Follow all instructions supplied by the display and wall mount manufacturers.
- If you have any doubts about your ability to safely install your flat panel display, contact your retailer about professional installation.
- Make sure the wall where you are mounting the display is appropriate. Some wall mounts are not designed to be mounted to walls with steel studs or old cinder block construction. If you are unsure, contact a professional installer.
- A minimum of two people are required for installation. Flat panel displays can be heavy.

Panasonic recommends that a qualified installer perform the wall-mount installation. See page 8.

The American Academy of Pediatrics discourages media viewing for children younger than two years. For more details, see www.aap.org.



■ About built-in wireless LAN

- To use the built-in wireless LAN, using an access point is recommended.
- To use the built-in wireless LAN in the access point mode, up to 7 devices are connectable. But the transfer rate will vary according to communication environment or connected equipments.
- Do not use the built-in wireless LAN to connect to any wireless network (SSID*) for which you do not have usage rights. Such networks may be listed as a result of searches. However, using them may be regarded as illegal access. (If it does not support WPS, the encryption key of the Access point is required when configuring settings.)
- Follow the instructions on the Access point setup screen and configure the appropriate security settings. For more details on setting of Access point, please refer to operating manual for the Access point.
- We recommend using 11n (2.4 GHz) for the wireless system between the built-in wireless LAN and Access point. Communication is also possible with 11a, 11b, and 11g, but the communication speed may be slower.
- If the wireless system of the Access point is changed, devices that could connect by wireless LAN may no longer be able to connect.
- Data transmitted and received over radio waves may be intercepted and monitored.
- Keep the TV away from the following devices as much as possible: Wireless LAN, microwaves, and other devices that use 2.400 GHz and 2.4835 GHz signals. Otherwise, the TV failures such as malfunction may occur due to the radio wave interference.
- When noises occur due to the electricity, etc., the TV might stop operating for the protection of the devices. In this case, turn the TV Off with power On / Off switch, then turn it On again.

*1 SSID is a name for identifying a particular wireless network for transmission.

Accessories/Optional Accessories

Accessories

Check that all the following items have been included with your TV

Remote Control
● NZQYAB001013



Owner's Manual

Batteries (2)
● AAA Battery



Quick Start Guide

Pedestals
● Assembly

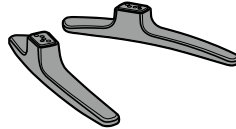

Warranty Card

Screws
● M4 x 38

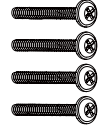

Optional Accessories

Please contact your nearest Panasonic dealer to purchase the recommended optional accessories. For additional details, please refer to the optional accessories installation manual.

Wall-hanging bracket Please contact a professional installer to purchase the recommended UL qualified wall-hanging bracket. For additional details, please refer to the wall-hanging bracket installation manual.

Back of the TV

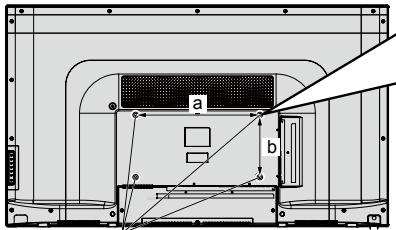

Holes for wall-hanging bracket installation
(for 55")
a: 15.7" (400 mm)
b: 7.9" (200 mm)

Screws for attaching the TV to the wall-hanging bracket
(not supplied with the TV)

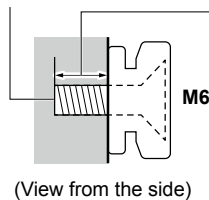

Depth of screw:
(for 55")
Minimum: 0.24" (6.0 mm)
Maximum: 0.31" (8.0 mm)

(View from the side)

Warning

- Always be sure to ask a qualified technician to carry out set-up.
- Do not mount the unit directly below ceiling lights (such as spotlights, floodlights or halogen lights) that typically give off high heat. Doing so may warp or damage plastic cabinet parts.
- Take care when fixing wall brackets to the wall. Always ensure that there are no electrical cables or pipes in the wall before hanging bracket.
- To prevent fall and injury, remove the TV from its fixed wall position when it is no longer in use.
- Incorrect wall-hanging bracket or incorrect fitting may cause equipment to fall, resulting in injury and product damage.
- Panasonic disclaims liability for any damage or injury arising from incorrect wall-hanging bracket, incorrect fitting or otherwise failure to follow the above instructions.

Attaching the Pedestals to TV

(A) Assembly screws

(bottom) (4)



M4 x 38

(B) Pedestal (R)

(55")

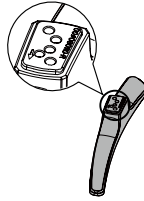

(C) Pedestal (L)

(55")

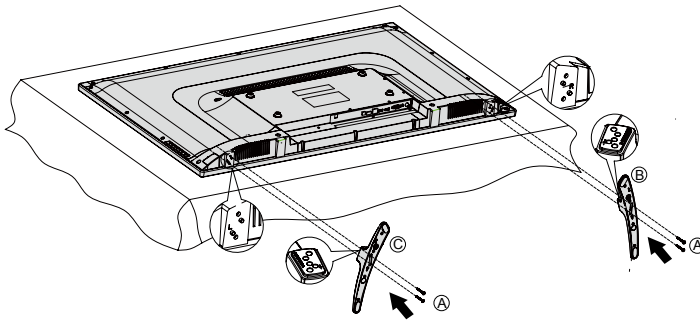

Attaching the pedestals(For 55")

Be sure to attach the pedestals in the following way.

1. Lay the TV face down on a flat, cushioned surface to avoid damaging or scratching.
2. Attach the pedestals (B) (C) to the TV with four assembly screws (A) provided.

Removing the pedestals from the TV

1. Remove the assembly screws (A) from the TV.
2. Lift the TV from the pedestals (B) (C) .

Warning

Do not disassemble or modify the pedestal.

- Otherwise, the TV may fall over and become damaged, and personal injury may result.

Caution

Do not use any pedestal other than that provided with this TV.

- Otherwise, the TV may fall over and become damaged, and personal injury may result.

Do not use the pedestal if it becomes warped or physically damaged.

- If you use the pedestal when it is physically damaged, personal injury may result. Contact your nearest Panasonic Dealer immediately.

During set-up, make sure that all screws are securely tightened.

- If sufficient care is not taken to ensure screws are properly tightened during assembly, the pedestal will not be strong enough to support the TV, and it might fall over and become damaged, and personal injury may result.

When removing the pedestal, do not remove the pedestal by any methods other than the specified procedure.

- Otherwise, the TV and/or pedestal may fall over and become damaged, and personal injury may result.

Installing the Remote's Batteries

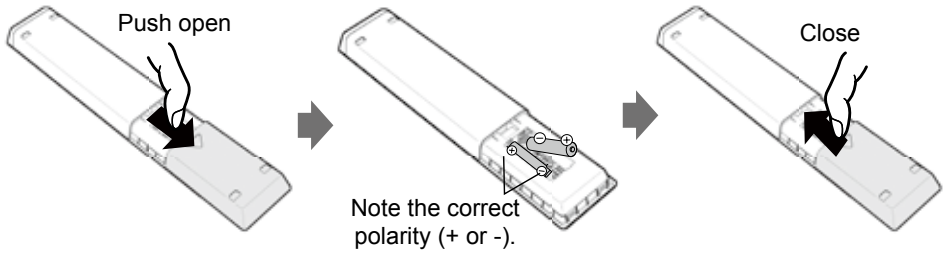

- 1 Open the battery cover.
- 2 Insert two "AAA" size batteries (supplied with the product).
 - Place the batteries with their terminals corresponding to the (+) and (-) indications in the battery compartment.
- 3 Close the battery cover

Caution

- Incorrect installation may cause battery leakage and corrosion, resulting in damage to the remote control.
 - Do not mix old and new batteries.
 - Do not mix different battery types (such as alkaline and manganese batteries).
 - Do not use rechargeable batteries.
- Do not burn or break batteries.

Connections

Connection Panels

Back of the TV

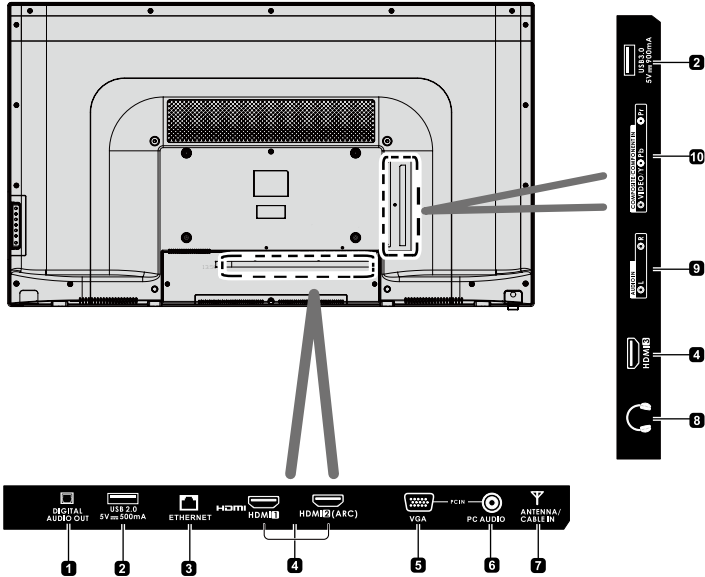

1. DIGITAL AUDIO OUT

Connect to the audio socket on the digital audio system.

2. USB Port

Connect to a USB storage device to play compatible audio and photo files. (USB mode)

3. ETHERNET

Wired Network connection port.

4. HDMI Inputs

Connect to a High-Definition (HD) signal output device.

5. VGA Input

Connect to a computer or other devices with a VGA interface.

6. PC AUDIO Input

Connect to a computer audio output.

7. ANTENNA/CABLE IN

Connect to the antenna.

8. Headphone Socket

Connect to the Headphones.

9. AUDIO IN

Connect to the composite VIDEO and AUDIO (L/R) input sockets on external video devices.

10. YPbPr/VIDEO

Connect to AV devices with component (Y/Pb/Pr) video and audio input sockets. COMPONENT&VIDEO share with AUDIO IN(L/R).
Composite video broadcast signal input (Video is shared with Y)

Antenna or Cable Connection

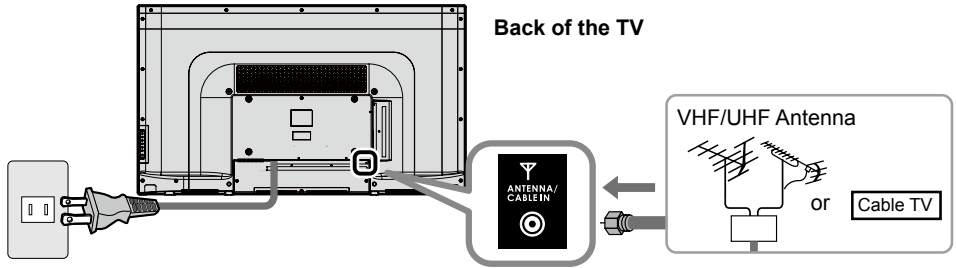

Power Cord

Connect after all other connections have been made.

VHF/UHF Antenna

- NTSC (National Television System Committee): Analog television system
- ATSC (Advanced Television Systems Committee): Digital TV Standards include digital high-definition television (HDTV), standard-definition television (SDTV), data broadcasting, multi-channel surround sound audio and interactive television.

Cable

- You need to subscribe to a cable TV service to enjoy viewing their programming.
- You may need to connect the TV to a Cable box to receive all available channels. Check with your Cable service provider.
- A high-definition connection can be made using an HDMI or Component Video cable to a Cable box. (p. 13)

Note

- When using a Cable box, external equipments and video cables shown in this manual are not supplied with the TV.
- For additional assistance, visit us at: www.panasonic.com/help

AV Cable Connection



(A) To use HDMI terminals
(Set-top-box / DVD recorder / Blu-ray Disc player / Camcorder / etc.)

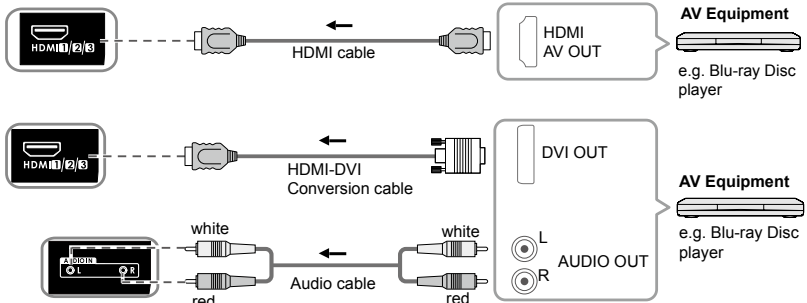

(B) To use COMPONENT terminals
(DVD recorder / Blu-ray Disc player / etc.)

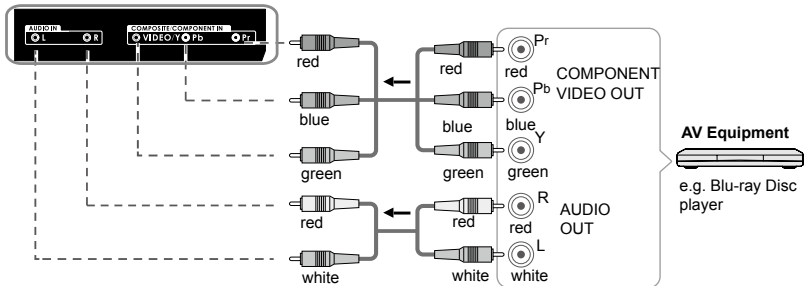

(C) To use COMPOSITE terminals
(Camcorder / Game system / DVD recorder / etc.)

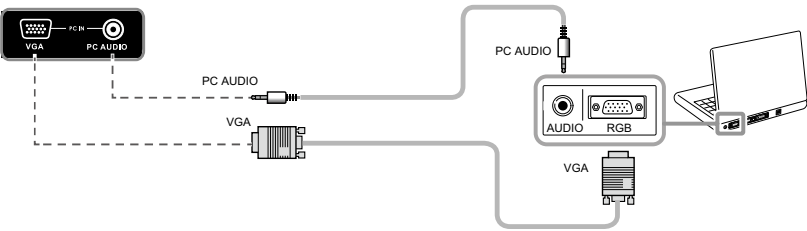
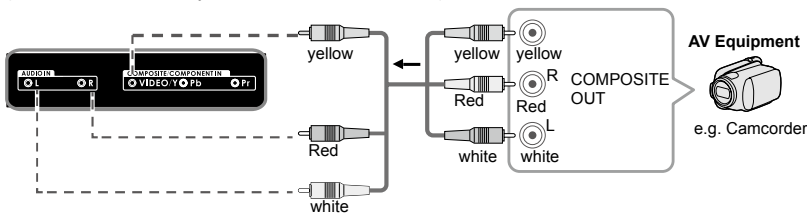

Note

- The Green terminal is shared for both the COMPONENT and COMPOSITE (VIDEO IN) connection. When using COMPOSITE (VIDEO IN) connection, the Yellow connector (Video) should be inserted into Green connection.

Audio Connection

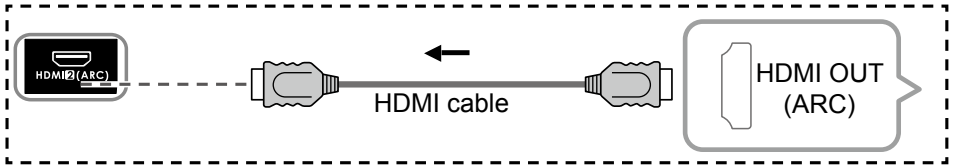
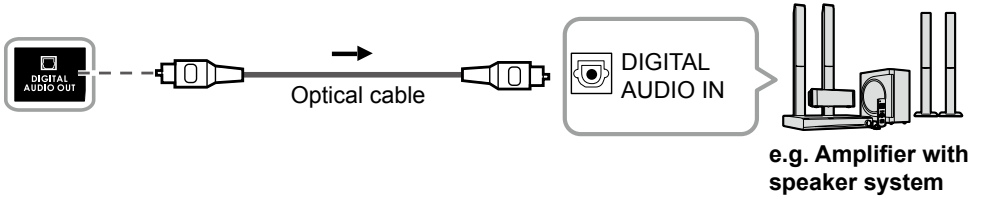

HDMI connection is available if connected audio equipment has ARC (Audio Return Channel) function.

Panasonic does not guarantee operation and performance of peripheral devices made by other manufacturers; and we disclaim any liability or damage arising from operation and/or performance from usage of such other maker's peripheral devices.

Identifying Controls

TV Controls/ Indicators

Front of the TV

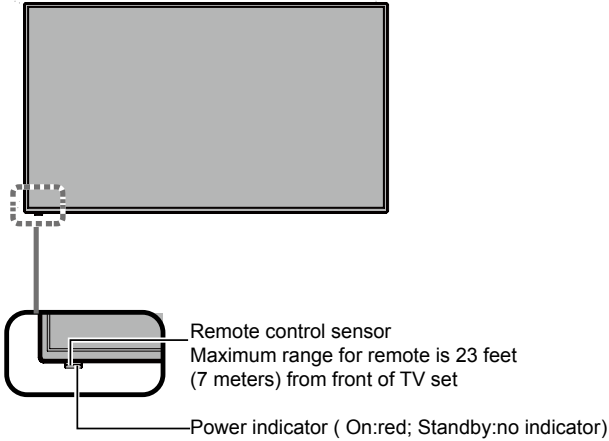

Back of the TV

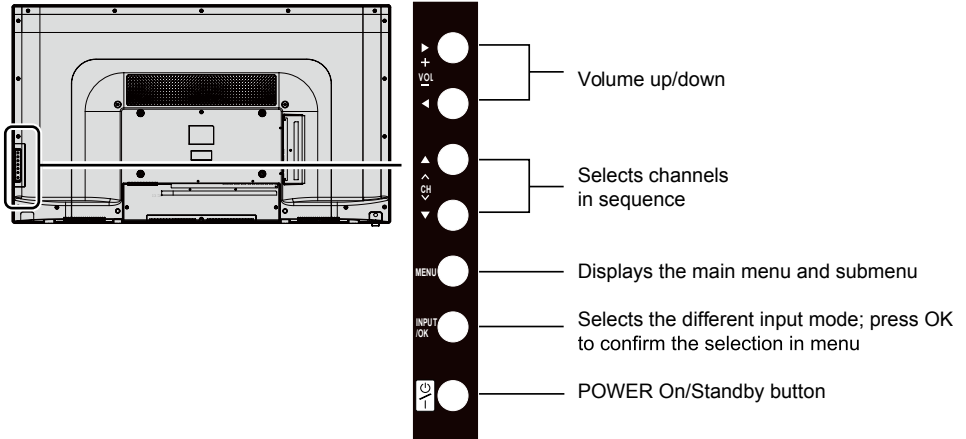

Note

- The TV consumes a small amount of electric energy even when turned off.
- Do not place any objects between the remote control and sensor.

Remote Control

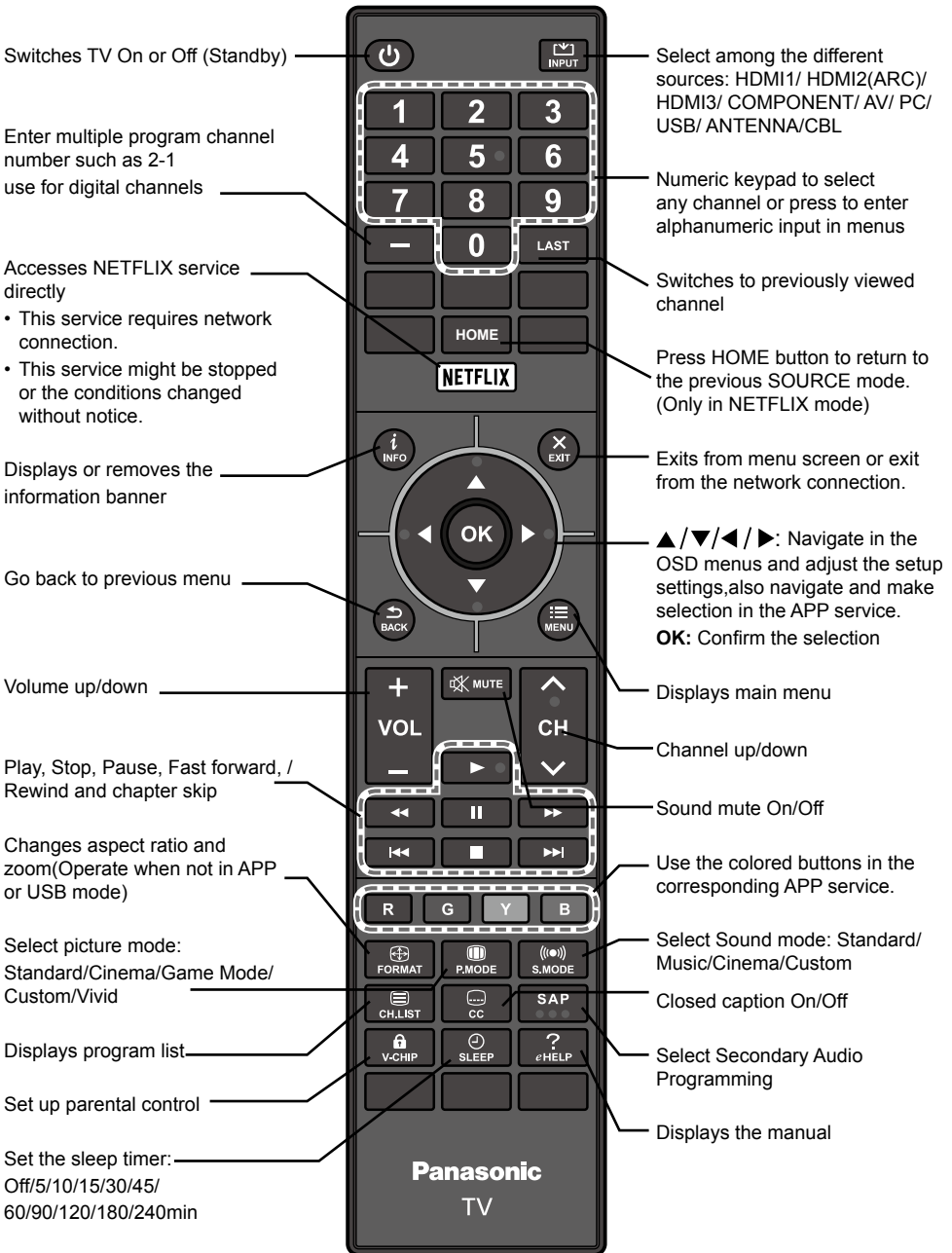

First Time Setup

Connect the power cord to the power socket after you have completed all the physical connections. Turn the TV on with the **POWER** button on the right back of TV or on the remote, then the red LED indicator will illuminate.



The first time you turn the TV on, it will start the Setup Wizard. Use the **▲/▼/◀/▶** navigation buttons to make a selection. Press **OK** to confirm and continue. Select **↶** to go back to the previous step. To repeat the First Time Setup, Initialize the TV by doing Factory Reset (p. 25).

Input Source

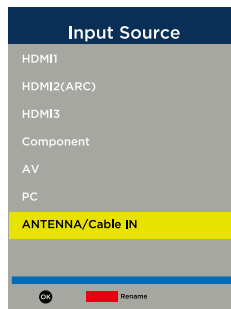

For your convenience, you can rename the inputs to easily remember the connected devices. To rename: select the input source that you want to rename, then press **RED** button on the remote control, a new screen will pop up on the left. Use **▲/▼** buttons to select the desired one and press **OK** to rename.

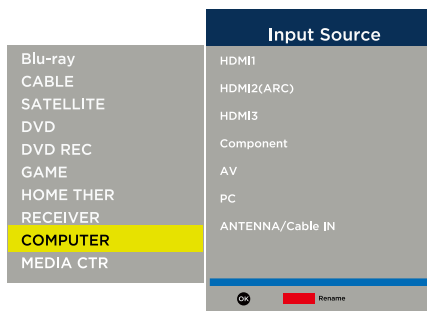

Customizing TV Settings

STREAMING



Press the **MENU** button to directly enter the main interface. The default setting is **STREAMING**. Press **OK** or **▶** button to enter APP section. Use **◀/▶** buttons to navigate and select the desired App, and press **OK** button to enter. Press **BACK** button to exit **STREAMING**.

NETFLIX	Enjoy TV shows & movies streamed instantly over the Internet.
YouTube	YouTube your way on the best screen in your house.
VUDU	Discover, watch and collect the latest movies and TV shows in high quality 1080p. Free to sign up. No subscriptions, late fees or commitments.
Toongoggles	A subscription video on-demand platform that offers animated, fun and educational cartoons, engaging games and songs from all over the world and in many different languages to children.
Pandora	Free personalized radio that offers effortless and endless music enjoyment and discovery. Just start with the name of one of your favorite artists, songs, genres or composers and Pandora will do the rest. It's easy to create personalized stations that play only music you'll love.
AccuWeather	Displays the current weather conditions and the temperature anywhere in the world in centigrade or Fahrenheit.

INPUT SOURCE



Press **▲/▼** buttons to select **INPUT SOURCE**, and use **OK** or **▶** button to enter. Then press **◀/▶** buttons to navigate and select the different input source among: **HDMI1/ HDMI2(ARC)/ HDMI3/ COMPONENT/ AV/ PC/ USB/ ANTENNA/CBL** and press **OK** button to confirm. Press **BACK** button to exit **INPUT SOURCE**.

MEDIA



Press ▲/▼ buttons to select **MEDIA**, and use **OK** or ► button to enter. Then press ▲/▼ button to navigate and select the desired PHOTOS or MUSIC option and press **OK** button to confirm. Press **BACK** button to exit **MEDIA**.

VIEWING PHOTOS

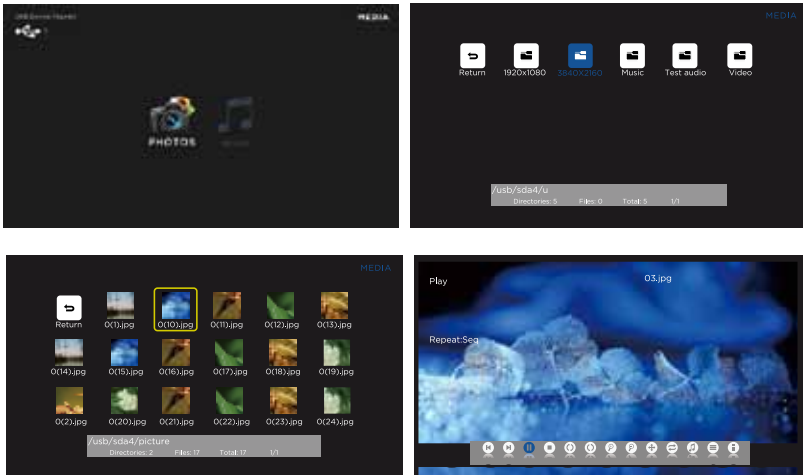

When selecting **PHOTOS**, press **OK** button to select the disk type to enter. Then use ▲/▼/◀/▶ buttons to navigate in the picture folder and select the desired photo, press ► button to display the photo. Press **MENU** button to display the function bar to set the picture playing.

Note: File format supported: **JPEG**.

LISTENING TO MUSIC

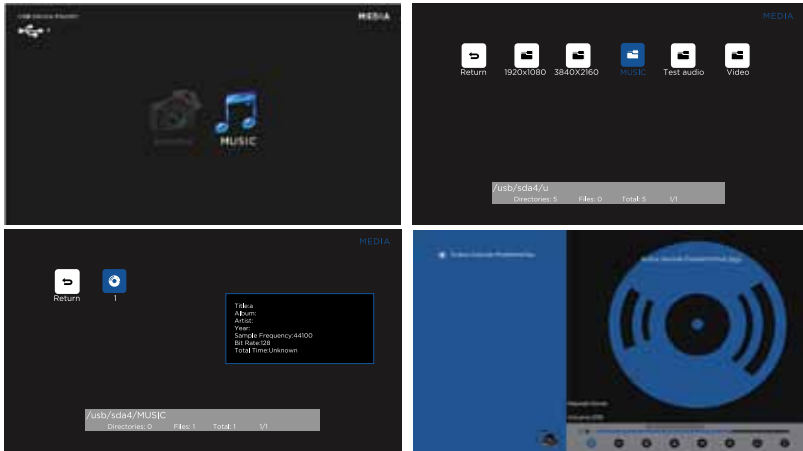

When selecting **MUSIC**, press **OK** button to select the disk type to enter. Then press **▲/▼/◀/▶** buttons to navigate in the music folder and select the desired music, then a subscreen will pop up. Press **▶** button to display the photo. Press **MENU** button to display the function bar to set the music playing.

Note: File format supported: **MP3**.

SETUP



Press **▲/▼** buttons to select **SETUP**, and then use **OK** or **▶** button to enter. Then press **◀/▶** button to navigate and select the desired setting among **PICTURE**, **SOUND**, **NETWORK**, **ANT/CBL**, **PARENTAL CONTROL** and **SYSTEM**, and press **OK** button to confirm. Press **BACK** button to exit **SETUP**.

PICTURE

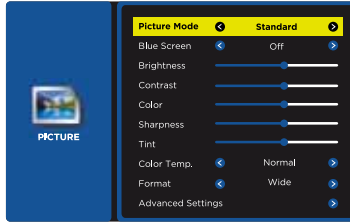

Press ◀/▶ buttons to select **PICTURE** menu and then press **OK** button to enter. Use ▲/▼ buttons to select the following picture options and then use ◀/▶ buttons to set each option's setting.

Picture Mode	Cycle among picture mode: Standard/Cinema/Game Mode(in HDMI or VGA mode)/Custom/Vivid. Alternative: you may press the P.MODE button to select the picture mode directly.
Blue Screen	Allow the blue background to turn On/Off during weak or no signal conditions.
Brightness	Increase or decrease the amount of white in the picture.
Contrast	Adjust the difference between light and dark levels in the pictures.
Color	Control the color intensity.
Sharpness	Adjust the level of crispness in the edges between light and dark areas of the picture.
Tint	Adjust the balance between red and green levels.
Color Temp.	Cycle among color temperatures: Cool/Normal/Warm.
Format	Adjust the Standard/Wide/Wide Zoom/Zoom/Just Scan(only HDMI).
Advanced Settings	Adjust the following advanced settings: Color Space: Color Mode: Standard/Dynamic/Custom. Color: In Custom mode, cycle among Cyan/Magenta/Yellow/Red/Green/Blue. Hue/Saturation/Brightness: Adjust the settings in Custom mode. Reset: Reset the settings in color space. White Balance: Adjust Red Gain/Green Gain/Blue Gain/Red Offset/ Green Offset/Blue Offset/Reset. MEMC: An algorithm employing motion estimation and motion compensation, for reducing motion blur in fast moving videos.For best response time in Game mode, MEMC should be OFF. Dynamic Luminance: Turn On/Off the dynamic luminance. Noise Reduction: Set the noise reduction among Medium/Strong/Off/Weak.

SOUND

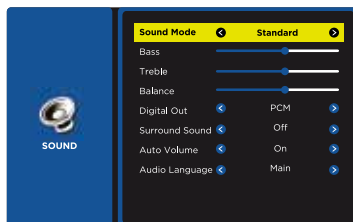

Press ◀/▶ buttons to select **SOUND** menu and then press **OK** button to enter. Use ▲/▼ buttons to select the following sound options and then use ◀/▶ buttons to set each option's setting.

Sound Mode	Allow the selection of an audio-enhancement technique: Standard/Music/Cinema/Custom. Alternative: you may press the S.MODE button to select the sound mode directly.
Bass	Control the relative intensity of lower-pitched sounds.
Treble	Control the relative intensity of higher-pitched sounds.
Balance	Adjust the relative volume of the speaker in a multiple speaker system.
Digital Out	Select the digital audio output mode between RAW/PCM.
Surround Sound	Select surround sound between Virtual or Off.
Auto Volume	Volume levels are automatically controlled by turning On/Off.
Audio Language	Select audio language among: Main/1/2.

NETWORK

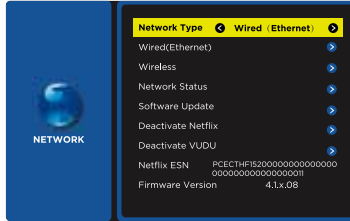

Press ◀/▶ buttons to select **NETWORK** menu and then press **OK** button to enter. Use ▲/▼ buttons to select the following network options and then set each option's setting.

Network Type	Select two types of network: Wired(Ethernet) or Wireless.
Wired(Ethernet)	Connect the Ethernet to the TV: Auto Get IP/Manual Get IP.
Wireless	Connect the TV to the wireless network through searching the available Wi-Fi.
Network Status	Display the current information of network status: Subnet Mask/ Gateway/DNS Server IP address /MAC ADDR.
Software Update	Upgrade the TV software through the network.
Deactivate Netflix	Deactivate Netflix and clear the account information.
Deactivate Vudu	Deactivate Vudu and clear the account information.
Netflix ESN	Electronic Serial Number
Firmware Version	display the firmware version.

ANTENNA / CABLE

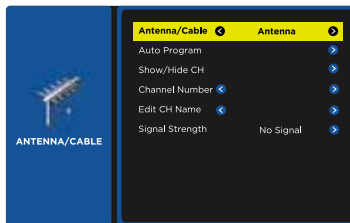

Press ◀/▶ buttons to select **ANTENNA / CABLE** menu and then press **OK** button to enter. Use ▲/▼ buttons to select the following antenna options and set each option's setting.

Note: The ANTENNA / CABLE is available only when you choose the ANTENNA/CBL mode in Input source firstly.

Antenna/Cable	Select antenna type between Antenna and Cable.
Auto Program	select to search the available channels automatically.
Show/Hide CH	Show/Hide the selected channel.
Channel Number	Display the current channel number.
Edit CH Name	Edit the selected channel number.
Signal Strength	Display the current signal strength.

Note: Some Cable service providers require the use of a Cable box to receive all available channels. Check with your Cable service provider.

PARENTAL CONTROL

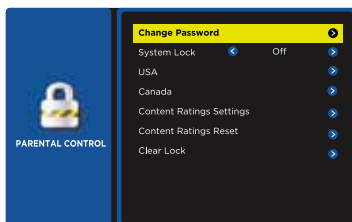

Press ◀/▶ buttons to select **PARENTAL CONTROL** menu and then press **OK** button to enter. Use the 0-9 buttons to input 4-digit password to enter the LOCK menu. (Note: the default password is "0000".) Use ▲/▼ buttons to select the following lock options and set each option's setting.

Note: The **PARENTAL CONTROL** is available only when you choose the ANTENNA/CBL mode in Input source firstly.

Change Password	Use 0-9 buttons to input the old password and then input the new 4-digit password. Re-enter new password for confirmation.	
System Lock	Select to turn On/Off system lock. The following options (USA, Canada, Content Ratings Settings and Content Ratings Reset) will only be accessible when you turn the system lock on.	
USA	TV	Set the TV Rating: TV-Y, TV-Y7, TV-G, TV-PG, TV-14 and TV-MA.
	MPAA	Select MPAA rating : N/A,G, PG, PG-13, R, NC-17,or X.
Canada	Canada English	Select MPAA rating for English-speaking Canada : E, C, C8+, G, PG, 14+, 18+.
	Canada French	Select MPAA rating for Quebec Canada : E, G, 8 ans+, 13 ans+, 16 ans+, 18 ans+.
Content Ratings Settings	Set the content ratings.	
Content Ratings Reset	Reset the content ratings.	
Clear Lock	Clear all lock settings.	

SYSTEM

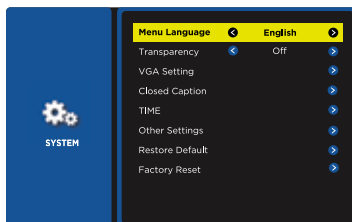

Press ◀/▶ buttons to select **SYSTEM** menu and then press **OK** button to enter. Use ▲/▼ buttons to select the following system options and set each option's setting.

Transparency	Select to turn On/Off menu transparency function.	
VGA Setting	Set the VGA setting: H-POS, V-POS, Clock, Phase or Auto. (VGA source mode only)	
Closed Caption	CC Mode	Select CC mode : Off, On or CC on Mute.
	Basic Selection	Basic Selection: CC1, CC2, CC3, CC4, Text1, Text2, Text3, Text4.
	Advanced Selection	Advanced Selection: Service1, Service2, Service3, Service4, Service5, and Service6.
	Option	Options: Mode, Font, Size, Edge Effect, Edge Color, Text Color, Background Color, Text Opacity, Background Opacity.
TIME	Adjust the time settings: Sleep Timer: Select a period of time after which the TV automatically switches to standby mode: Off/5/10/.../180/240 min. Alternative: Press the SLEEP button repeatedly to select the number of minutes directly. Time Zone: Eastern/ Central/ Mountain/ Pacific/ Alaska/ Hawaii/ Newfoundland/ Atlantic. Daylight Saving Time: Select to turn On/Off daylight saving time.	
Other Settings	Set other settings: HDMI EDID: select the HDMI version: HDMI 2.0/HDMI 1.4. HDMI Link: set the following settings: HDMI Link Control : Turn On/Off the HDMI Link Control (HDMI-CEC), When the HDMI Link Control is set to On, the following options can be adjusted: Device Power Off : On/Off TV Power On : On/Off Audio Receiver: On/Off HDMI Link Device List: Displays a list of connected HDMI devices that can be controlled via HDMI Link.	
Restore Default	Restore the TV to the default settings before the user's adjusting.	
Factory Reset	Initialize to the factory default settings.	



Press ▲/▼ buttons to select **SUPPORT**, and then use **OK** or ► button to jump to eHELP, then press **OK** button to enter. Use ▲/▼ buttons to select eHELP or Open Source Notices and press **OK** to access.

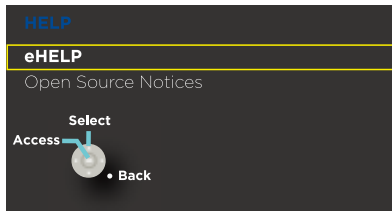

eHELP: Select eHELP and press **OK** button to enter, and then use ▲/▼/◀/▶ buttons to view the built-in user manual.



Open Source Notices: displays the notices of open source.

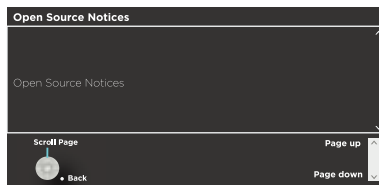

Frequently Asked Questions (FAQ)

Questions	Answers
Why doesn't the remote control work?	<ul style="list-style-type: none">● Check that the batteries are fresh, are of the same type and are installed with the correct polarity (+ & -).● To operate other devices, such as changing channels when using Cable or Satellite boxes, or operating non-Panasonic Blu-ray players, use the remote supplied with the device.
Why is there no picture or just a blue, black or snowy screen being displayed?	<ul style="list-style-type: none">● Ensure that the power cord is plugged in and the TV is turned on (front red LED light should be on, not blinking)● Press the INPUT button on the remote to select the correct input source.● Ensure all connections are correct and secure.● When using external video source, such as a Cable/Satellite box or DVD player, ensure that the device is on and functioning correctly.● Press MENU on the TV's remote control. If the menu is displayed, then the TV is working; recheck above steps.
Why does my picture quality not look like it is in High Definition?	<ul style="list-style-type: none">● Press INFO button on remote to confirm type of signal being received. HD signal should be 720p, 1080i or 1080p.● Select a High Definition channel from HD source (Cable, Satellite, Fiber optic or antenna).● HD channels sometimes broadcast non-HD content.● Ensure that HD source (HD box, Blu-ray player, etc.) is connected to TV via either HDMI or Component cable and set to output HD video signal.
Why did the network connection fail?	<ul style="list-style-type: none">● If connection fails, contact your Internet service provider or router/modem manufacturer to check for firewall, content filter or proxy settings that may block TV from accessing the Internet.
How can I hear the TV's sound through my Home Theater?	<ul style="list-style-type: none">● If your Home Theater has an HDMI-ARC Out, then connect it to the TV's HDMI 2 (ARC) input using an HDMI cable.● If HDMI-ARC is not available, then connect the TV's DIGITAL AUDIO OUT to the Home Theater using an optical cable or connect to the headphone jack.

Care and Cleaning

First, unplug the power cord plug from the wall outlet.

Display panel

The front of the display panel has been specially treated. Wipe the panel surface gently using only a cleaning cloth or a soft, lint-free cloth.

- If the surface is particularly dirty after cleaning up the dust, soak a soft, lint-free cloth in diluted, mild liquid dish soap (1 part mild liquid dish soap diluted by 100 times the amount of water), and then wring the cloth to remove excess liquid. Use this cloth to wipe the surface of the display panel, then wipe it evenly with a dry cloth of the same type until the surface is dry.
- Do not scratch or hit the surface of the panel with fingernails or other hard objects. Furthermore, avoid contact with volatile substances such as insect sprays, solvents, and thinner; otherwise, the quality of the surface may be adversely affected.

Cabinet

If the cabinet becomes dirty, wipe it with a soft, dry cloth.

- If the cabinet is particularly dirty, soak the cloth in diluted, mild liquid dish soap and then wring the cloth dry. Use this cloth to wipe the cabinet and then wipe it dry with a dry cloth.
- Do not allow any mild liquid dish soap to come into direct contact with the surface of the TV. If water droplets get inside the unit, operating problems may result.
- Avoid contact with volatile substances such as insect sprays, solvents, and thinner; otherwise, the quality of the cabinet surface may be adversely affected or the coating may peel off.
- Do not let articles made from rubber or PVC be in contact with the TV for long periods of time.

Pedestal

Cleaning

- Wipe the surfaces with a soft, dry cloth. If the unit is particularly dirty, clean it using a cloth soaked with water to which a small amount of mild liquid dish soap has been added and then wipe with a dry cloth. Do not use products such as solvents, thinner, or household wax for cleaning, as they can damage the surface coating.
Note: If using a chemically-treated cloth, follow the instructions supplied with the cloth.
- Do not attach sticky tape or labels, as they can make the surface of the pedestal dirty. Do not allow long-term contact with rubber, vinyl products, or the like. (Doing so will cause deterioration.)

Power cord plug

Wipe the plug with a dry cloth at regular intervals.

Note: Moisture and dust can lead to fire or electrical shock.

Specifications

		TC-55CX400U
Power Source		AC 120 V, 60 Hz
Power Consumption (Rated power / Standby power)		190 W / 0.5 W
Display Panel	Panel System	LCD panel (LED backlight)
	Screen size	55 " class (54.6 inches measured diagonally)
	W × H × Diagonal	47.6 " × 26.8 " × 54.6 " (1209.6 mm × 680.4 mm × 1387.8 mm)
	Number of pixels	3840 × 2160
Speaker Output		20 W [10 W + 10 W] (10 % THD)
Channel Capability (Digital/Analog)		VHF/ UHF: 2 - 69, CATV: 1 - 135
Operating Conditions		Temperature: 32 °F - 95 °F (0 °C - 35 °C) Humidity: 20 % - 80 % RH (non-condensing)
Connection Terminal	VIDEO IN	RCA PIN (VIDEO, AUDIO-L, AUDIO-R)
	COMPONENT IN	RCA PIN (VIDEO/Y, Pb, Pr, AUDIO-L, AUDIO-R)
	HDMI IN 1/2/3	TYPE A Connector
	USB 2.0	USB2.0 Type A connector DC 5V, Max. 500mA
	USB 3.0	USB3.0 Type A connector DC 5V, Max. 900mA
	DIGITAL AUDIO OUT	PCM / Dolby Digital, Fiber Optic
	OTHERS	ETHERNET (10BASE-T/100BASE-TX)
Dimensions	Including pedestal (W × H × D)	49 " × 30.2 " × 11.1 " (1244.4 mm × 767 mm × 282.15 mm)
	TV Set only (W × H × D)	49 " × 28.6 " × 3.26 " (1244.4 mm × 726.7 mm × 82.8 mm)
Mass	Including pedestal	36 lb. (16.3 kg) NET
	TV Set only	35 lb. (15.9 kg) NET

		Wireless LAN
Standard Compliance and Frequency Range *1, *2		IEEE 802.11b/g/n : 2.400 GHz - 2.4835 GHz
Security		WPA2-PSK (TKIP/AES) WPA-PSK (TKIP/AES) WEP (64bit/128bit)

*1 The frequency and channel differ depending on the country.

*2 802.11b/g/n CH1 ~ CH11 only use for United States and Canada.

Note

- Design and Specifications are subject to change without notice. Mass and Dimensions shown are approximate.

Limited Warranty (for U.S.A.)

Panasonic Television Limited Warranty

Limited Warranty Coverage

If your product does not work properly because of a defect in materials or workmanship, Panasonic Corporation of North America (referred to as "the warrantor") will, for the length of the period indicated on the chart below, which starts with the date of original purchase ("Limited Warranty period"), at its option either (a) repair your product with new or refurbished parts, (b) replace it with a new or a refurbished equivalent value product, or (c) refund your purchase price. The decision to repair, replace or refund will be made by the warrantor.

TV CATEGORIES	PARTS	LABOR	SERVICE
Up to 50" (diagonal)	1 (ONE) YEAR	1 (ONE) YEAR	Carry-In
51" (diagonal) and larger			On-Site

During the "Labor" Limited Warranty period there will be no charge for labor. During the "Parts" Limited Warranty period, there will be no charge for parts.

You must carry-in your product or arrange for on-site service during the Limited Warranty period. If non-rechargeable batteries are included, they are not warranted. This Limited Warranty only applies to products purchased and serviced in the United States. This Limited Warranty is extended only to the original purchaser of a new product which was not sold "as is". A purchase receipt or other proof of the original purchase date is required for Limited Warranty service.

On-Site, Carry-In or Mail-In Service

To submit a new repair request and for quick repair status visit our Web Site at www.shop.panasonic.com/support.

On-site service where applicable requires clear, complete and easy access to the product by the authorized servicer and does not include removal or re-installation of an installed product. It is possible that certain on-site repairs will not be completed on-site, but will require that the product or parts of the product, at the servicer's discretion be removed for shop diagnosis and/or repair and then returned.

When shipping the unit, carefully pack, include all accessories, and send it prepaid, adequately insured and preferably in the original carton. When shipping Lithium Ion batteries please visit our Web Site at www.panasonic.com/BatteryHandling as Panasonic is committed to providing the most up to date information. Include a letter detailing the complaint, a return address and provide a daytime phone number where you can be reached. A valid registered receipt is required under the Limited Warranty.

Limited Warranty Limits and Exclusions

This Limited Warranty ONLY COVERS failures due to defects in materials or workmanship, and DOES NOT COVER normal wear and tear or cosmetic damage, nor does it cover markings or retained images on the glass panel resulting from viewing fixed images (including, among other things, non-expanded standard 4:3 pictures on wide screen TVs, or onscreen data in a stationary and fixed location such as network logos, video games and banners). The Limited Warranty ALSO DOES NOT COVER damages which occurred in shipment, or failures which are caused by products not supplied by the warrantor, or failures which result from accidents, misuse, abuse, neglect, bug infestation, mishandling, misapplication, alteration, faulty installation, set-up adjustments, maladjustment of consumer controls, improper maintenance, power line surge, lightning damage, modification, or commercial use (such as in a hotel, office, restaurant, or other business), rental use of the product, service by anyone other than a Factory Service Center or other Authorized Servicer, or damage that is attributable to acts of God.

THERE ARE NO EXPRESS WARRANTIES EXCEPT AS LISTED UNDER "LIMITED WARRANTY COVERAGE". THE WARRANTOR IS NOT LIABLE FOR INCIDENTAL OR CONSEQUENTIAL DAMAGES RESULTING FROM THE USE OF THIS PRODUCT, OR ARISING OUT OF ANY BREACH OF THIS LIMITED WARRANTY. (As examples, this excludes damages for lost time, cost of having someone remove or re-install an installed unit if applicable, or travel to and from the servicer. The items listed are not exclusive, but are for illustration only.) **ALL EXPRESS AND IMPLIED WARRANTIES, INCLUDING THE LIMITED WARRANTY OF MERCHANTABILITY, ARE LIMITED TO THE PERIOD OF THE LIMITED WARRANTY.**

Some states do not allow the exclusion or limitation of incidental or consequential damages, or limitations on how long an implied Limited Warranty lasts, so the exclusions may not apply to you.

This Limited Warranty gives you specific legal rights and you may also have others rights which vary from state to state. If a problem with this product develops during or after the Limited Warranty period, you may contact your dealer or Service Center. If the problem is not handled to your satisfaction, then write to:

Consumer Affairs Department
Panasonic Corporation of North America
661 Independence Pkwy
Chesapeake, VA 23320

PARTS AND SERVICE (INCLUDING COST OF AN ON-SITE SERVICE CALL, WHERE APPLICABLE) WHICH ARE NOT COVERED BY THIS LIMITED WARRANTY ARE YOUR RESPONSIBILITY.

Shop Accessories!

for all your Panasonic gear

Go to

www.shop.panasonic.com/support

Get everything you need to get the most out of
your Panasonic products

Accessories & Parts for your Camera, Phone, A/V
products, TV, Computers & Networking, Personal
Care, Home Appliances, Headphones, Batteries,
Backup Chargers & more...

Customer Services Directory

For Product Information, Operating Assistance,
Parts, Owner's Manuals, Dealer and Service info
go to www.shop.panasonic.com/support

For the hearing or speech impaired TTY: 1- 877-833-8855

USA Only: Disposal may be regulated in your community due to environmental considerations. For disposal or recycling information, please visit Panasonic website:
<http://www.panasonic.com/environmental>
or call 1-888-769-0149.

Sólo Estados Unidos: La disposición puede estar regulada en su comunidad debido a consideraciones ambientales. Para información sobre la disposición o reciclaje, por favor visite la página web de
Panasonic: <http://www.panasonic.com/environmental>
o llame al 1-888-769-0149.

Customer's Record

The model number and serial number of this product can be found on its back cover. You should note this serial number in the space provided below and retain this book, plus your purchase receipt, as a permanent record of your purchase to aid in identification in the event of theft or loss, and for Warranty Service purposes.

Model Number

Serial Number

Anotación del cliente

El modelo y el número de serie de este producto se encuentran en su panel posterior. Deberá anotarlos en el espacio provisto a continuación y guardar este manual, más el recibo de su compra, como prueba permanente de su adquisición, para que le sirva de ayuda al identificarlo en el caso de que le sea sustraído o lo pierda, y también para disponer de los servicios que le ofrece la garantía.

Modelo

Número de serie

Panasonic Corporation of North America

Two Riverfront Plaza

Newark, NJ 07102-5490 U.S.A.

© 2015 Panasonic Corporation of North America. All Rights Reserved.
© 2015 Panasonic Corporation of North America. Todos los Derechos Reservados.

Printed in China
Impreso en China
M0213-0