

USA Only: Disposal may be regulated in your community due to environmental considerations. For disposal or recycling information, please visit Panasonic website:

<http://www.panasonic.com/environmental>  
or call 1-888-769-0149.

Sólo Estados Unidos: La disposición puede estar regulada en su comunidad debido a consideraciones ambientales. Para información sobre la disposición o reciclaje, por favor visite la página web de Panasonic: <http://www.panasonic.com/environmental> o llame al 1-888-769-0149.

### Customer's Record

The model number and serial number of this product can be found on its back cover. You should note this serial number in the space provided below and retain this book, plus your purchase receipt, as a permanent record of your purchase to aid in identification in the event of theft or loss, and for Warranty Service purposes.

Model Number \_\_\_\_\_

Serial Number \_\_\_\_\_

### Anotación del cliente

El modelo y el número de serie de este producto se encuentran en su panel posterior. Deberá anotarlos en el espacio provisto a continuación y guardar este manual, más el recibo de su compra, como prueba permanente de su adquisición, para que le sirva de ayuda al identificarlo en el caso de que le sea sustraído o lo pierda, y también para disponer de los servicios que le ofrece la garantía.

Modelo \_\_\_\_\_

Número de serie \_\_\_\_\_

### Panasonic Corporation of North America

Two Riverfront Plaza, Newark,  
NJ 07102-5490 U.S.A.

# Panasonic®

Model No.  
**TC-50AS650UE**

## Owner's Manual

50" Class 1080p LED LCD TV  
(49.5 inches measured diagonally)

# VIERA

For assistance (U.S.A.), please visit:  
[www.panasonic.com/support](http://www.panasonic.com/support)

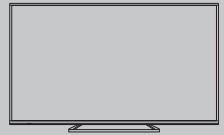

Built-in Manual

Register online at  
[www.panasonic.com/register](http://www.panasonic.com/register)  
(U.S. customers only)

English

Español

Thank you for purchasing this Panasonic product.  
Please read these instructions before operating your set and retain them for future  
reference. The images shown in this manual are for illustrative purposes only.



TQB2AA0749

**This product incorporates the following software:**

- (1) the software developed independently by or for Panasonic Corporation,
- (2) the software owned by third party and licensed to Panasonic Corporation,
- (3) the software licensed under the GNU LESSER GENERAL PUBLIC LICENSE Version 2.1 (LGPL V2.1) and/or,
- (4) open sourced software other than the software licensed under the LGPL V2.1.

The software categorized as (3) and (4) are distributed in the hope that it will be useful, but WITHOUT ANY WARRANTY, without even the implied warranty of MERCHANTABILITY or FITNESS FOR A PARTICULAR PURPOSE. Please refer to the detailed terms and conditions thereof shown in the "Software License" menu on this product.

At least three (3) years from delivery of this product, Panasonic will give to any third party who contacts us at the contact information provided below, for a charge no more than our cost of physically performing source code distribution, a complete machine-readable copy of the corresponding source code covered under LGPL V2.1 or the other licenses with the obligation to do so, as well as the respective copyright notice thereof.

Contact Information: [cdrequest@unipf.jp](mailto:cdrequest@unipf.jp)

The source code and the copyright notice are also available for free in our website below.

<http://www.unipf.jp/dl/DTV14U/>

---

"PlayReady" is a trademark registered by Microsoft. Please be aware of the following.

(a) This product contains technology subject to certain intellectual property rights of Microsoft. Use or distribution of this technology outside of this product is prohibited without the appropriate license(s) from Microsoft.

(b) Content owners use Microsoft PlayReady™ content access technology to protect their intellectual property, including copyrighted content. This device uses PlayReady technology to access PlayReady-protected content and/or WMDRM-protected content. If the device fails to properly enforce restrictions on content usage, content owners may require Microsoft to revoke the device's ability to consume PlayReady-protected content. Revocation should not affect unprotected content or content protected by other content access technologies.

Content owners may require you to upgrade PlayReady to access their content.

If you decline an upgrade, you will not be able to access content that requires the upgrade.

## Contents

### Please read before using the unit

Safety Precautions .....	4
Accessories/Optional accessories .....	8
Connections .....	11
Identifying Controls .....	14
First Time Setup .....	18
Operations .....	19
Viewing 3D images on TV .....	20
Using eHELP (Built-in Manual) .....	21
Frequently Asked Questions (FAQ) .....	22
Care and Cleaning .....	23
Specifications .....	24
Limited Warranty (for U.S.A.) .....	26
Customer Services Directory (for U.S.A.) .....	27



Energy Star is a joint program of the US Environmental Protection Agency and the U.S. Department of Energy. It is administered in Canada by Natural Resources Canada (NRC) through the Office of Energy Efficiency (OEE). This program is helping to protect the environment and save money through energy efficient products and practices. This product qualifies for ENERGY STAR in the "Home Use" setting and this is the setting in which energy savings will be achieved. Any modifications to the "Home Use" setting or other factory default settings could result in greater energy consumption beyond levels that meet ENERGY STAR qualifications.

VIERA Link™ and HDAVI Control™ are trademarks of Panasonic Corporation.

HDMI, the HDMI Logo, and High-Definition Multimedia Interface are trademarks or registered trademarks of HDMI Licensing LLC in the United States and other countries.

Manufactured under license from Dolby Laboratories. Dolby and the double-D symbol are trademarks of Dolby Laboratories.

For DTS patents, see <http://patents.dts.com>. Manufactured under license from DTS Licensing Limited. DTS, the Symbol, & DTS and the Symbol together are registered trademarks, and DTS 2.0+Digital Out is a trademark of DTS, Inc. © DTS, Inc. All Rights Reserved.

DLNA®, the DLNA Logo and DLNA CERTIFIED™ are trademarks, service marks, or certification marks of the Digital Living Network Alliance.

Skype is a trade mark of Skype Limited.

Windows is a registered trademark of Microsoft Corporation in the United States and other countries.

Mac is a trademark of Apple Inc.

SDXC Logo is a trademark of SD-3C, LLC.

"AVCHD", "AVCHD 3D" and "AVCHD Progressive" are trademarks of Panasonic Corporation and Sony Corporation.

The Bluetooth® word mark and logos are registered trademarks owned by Bluetooth SIG, Inc. and any use of

such marks by Panasonic Corporation is under license. Other trademarks and trade names are those of their respective owners.

"RealD 3D" is a trademark of RealD.

Speech Powered by Dragon

2002-2014 Nuance Communications, Inc. All rights reserved.

© 2013 CSR plc and its group companies.

The aptX® mark and the aptX logo are trade marks of CSR plc or one of its group companies and may be registered in one or more jurisdictions.

This product is licensed under the AVC patent portfolio license for the personal and non-commercial use of a consumer to (i) encode video in compliance with the AVC Standard ("AVC Video") and/or (ii) decode AVC Video that was encoded by a consumer engaged in a personal and non-commercial activity and/or was obtained from a video provider licensed to provide AVC Video. No license is granted or shall be implied for any other use. Additional information may be obtained from MPEG LA, LLC.

See <http://www.mpegla.com>.



- Logo information on p. 25.



# Safety Precautions

**CAUTION**

**RISK OF ELECTRIC SHOCK  
DO NOT OPEN**

**WARNING:** To reduce the risk of electric shock, do not remove cover or back. No user-serviceable parts inside. Refer servicing to qualified service personnel.

 The lightning flash with arrowhead within a triangle is intended to tell the user that parts inside the product are a risk of electric shock to persons.

 The exclamation point within a triangle is intended to tell the user that important operating and servicing instructions are in the papers with the appliance.

## Note to CATV System Installer

This reminder is provided to direct the CATV system installer's attention to Article 820-40 of the NEC that provides guidelines for proper grounding and, in particular, specifies that the cable ground shall be connected to the grounding system of the building, as close to the point of cable entry as practical.

## Secure Ventilation

Slots and openings in the cabinet and the back or bottom are provided for ventilation, and to ensure reliable operation of the TV and to protect it from overheating. These openings must not be blocked or covered. There should be at least 4 inches (10 cm) of space around the TV. The openings should never be blocked by placing the TV on a bed, sofa, rug or other similar surface. This TV should not be placed in a built-in installation such as a bookcase unless proper ventilation is provided.

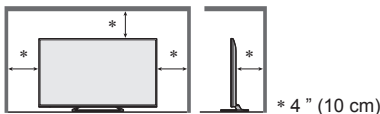

## Important Safety Instructions (TV set)

- 1) Read these instructions.
- 2) Keep these instructions.
- 3) Heed all warnings.
- 4) Follow all instructions.
- 5) Do not use this apparatus near water.
- 6) Clean only with dry cloth.
- 7) Do not block any ventilation openings. Install in

accordance with the manufacturer's instructions.

- 8) Do not install near any heat sources such as radiators, heat registers, stoves or other apparatus (including amplifiers) that produce heat.
- 9) Do not defeat the safety purpose of the polarized or grounding-type plug. A polarized plug has two blades with one wider than the other. A grounding type plug has two blades and a third grounding prong. The wide blade or the third prong are provided for your safety. If the provided plug does not fit into your outlet, consult an electrician for replacement of the obsolete outlet.
- 10) Protect the power cord from being walked on or pinched particularly at plugs, convenience receptacles, and the point where they exit from the apparatus.
- 11) Only use attachments / accessories specified by the manufacturer.
- 12) Use only with the cart, stand, tripod, bracket or table specified by the manufacturer, or sold with the apparatus. When a cart is used, use caution when moving the cart / apparatus combination to avoid injury from tip-over. 
- 13) Unplug this apparatus during lightning storms or when unused for long periods of time.
- 14) Refer all servicing to qualified service personnel. Servicing is required when the apparatus has been damaged in any way, such as power-supply cord or plug is damaged, liquid has been spilled or objects have fallen into the apparatus, the apparatus has been exposed to rain or moisture, does not operate normally, or has been dropped.
- 15) Operate only from the type of power source indicated on the marking label. If you are not sure of the type of power supplied to your home, consult your television dealer or local power company.
- 16) Follow all warnings and instructions marked on the TV.
- 17) Never push objects of any kind into this TV through cabinet slots as they may touch dangerous voltage points or short out parts that could result in a fire or electric shock. Never spill liquid of any kind on the TV.
- 18) If an outside antenna is connected to the television equipment, be sure the antenna system is grounded so as to provide some protection against voltage surges and built up static charges. In the U.S. Section 810-21 of the National Electrical Code provides information with respect to proper grounding of the mast and supporting structure, grounding of the lead-in wire to an antenna discharge unit, size of grounding conductors, location of antenna discharge unit, connection to grounding electrodes, and requirements for the grounding electrode.

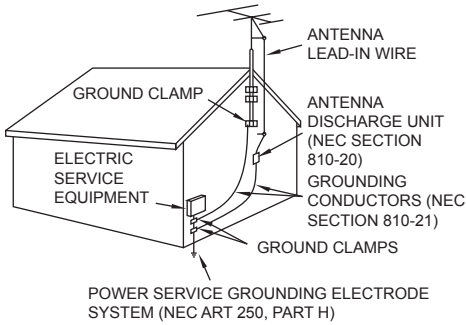

19) An outside antenna system should not be located in the vicinity of overhead power lines, other electric light, power circuits, or where it can fall into such power lines or circuits. When installing an outside antenna system, extreme care should be taken to keep from touching such power lines or circuits as contact with them might be fatal.

20) Unplug this TV from the wall outlet and refer servicing to qualified service personnel under the following conditions:

- a. When the power cord or plug is damaged or frayed.
- b. If liquid has been spilled into the TV.
- c. If the TV has been exposed to rain or water.
- d. If the TV does not operate normally by following the operating instructions.

Adjust only those controls that are covered by the operating instructions as improper adjustment of other controls may result in damage and will often require extensive work by a qualified technician to restore the TV to normal operation.

- e. If the TV has been dropped or the cabinet has been damaged.
- f. When the TV exhibits a distinct change in performance - this indicates a need for service.

21) When replacement parts are required, be sure the service technician uses replacement parts specified by the manufacturer that have the same characteristics as the original parts. Unauthorized substitutions may result in fire, electric shock, or other hazards.

22) **WARNING:**

**TO REDUCE THE RISK OF FIRE OR ELECTRIC SHOCK, DO NOT EXPOSE THIS APPARATUS TO RAIN, MOISTURE, DRIPPING OR SPLASHING.**

**DO NOT PLACE LIQUID CONTAINERS (FLOWER VASES, CUPS, COSMETICS, ETC.) ABOVE THE SET (INCLUDING ON SHELVES ABOVE, ETC.).**

23) **WARNING:**

**SMALL PARTS CAN PRESENT CHOKING**

**HAZARD IF ACCIDENTALLY SWALLOWED. KEEP SMALL PARTS AWAY FROM YOUNG CHILDREN.**

**DISCARD UNNEEDED SMALL PARTS AND OTHER OBJECTS, INCLUDING PACKAGING MATERIALS AND PLASTIC BAGS/SHEETS TO PREVENT THEM FROM BEING PLAYED WITH BY YOUNG CHILDREN, CREATING THE POTENTIAL RISK OF SUFFOCATION.**

24) **WARNING:**

**To prevent the spread of fire, keep candles or other open flames away from this product at all times.**



25) **WARNING:**

**Do not place this TV in any medical institutions or locations with medical devices.**

Radio waves from this TV may interfere with the medical devices and cause accidents due to the malfunction.

26) **WARNING:**

**Do not use this TV near any automatic control devices such as automatic doors or fire alarms.**

Radio waves from this TV may interfere with the automatic control devices and cause accidents due to the malfunction.

27) **WARNING:**

**Keep this TV away at least 9 inches (22 cm) from the location where a cardiac pacemaker is implanted.**

Radio waves from this TV may interfere with the operation of the pacemaker.

28) **CAUTION:**

The Power switch on this unit will not completely shut off all power from AC outlet. Since the power cord serves as the main disconnect device for the unit, you will need to unplug it from the AC outlet to shut down all power.

Therefore, make sure the unit has been installed so that the power cord can be easily unplugged from AC outlet in case of an accident. To avoid fire hazard, the power cord should also be unplugged from the AC outlet when left unused for a long period of time (for example, when on vacation).

29) **CAUTION:**

**TO PREVENT ELECTRIC SHOCK, DO NOT USE THIS PLUG WITH A RECEPTACLE OR OTHER OUTLET UNLESS THE BLADES CAN BE FULLY INSERTED TO PREVENT BLADE EXPOSURE.**

30) **CAUTION:**

**USE WITH OTHER STAND MAY RESULT IN INSTABILITY POSSIBLY CAUSING INJURY.**

31) **CAUTION:**

**DANGER OF EXPLOSION IF BATTERY IS INCORRECTLY REPLACED. REPLACE ONLY WITH THE SAME OR EQUIVALENT TYPE.**

## WARNING/CAUTION (3D Eyewear)

### WARNING

#### ■ Disassembly

- Do not disassemble or modify the 3D Eyewear.

### CAUTION

#### ■ 3D Eyewear

- Handle the tips of the frame carefully when putting on the 3D Eyewear as inserting the tip of the frame into the eye may cause injury.
- Be careful not to close the hinge section of the 3D Eyewear on your finger.

Doing so may result in injury.

- Provide supervision when children are using this product.

#### ■ Use of 3D Eyewear

- Parents/guardians should monitor children's viewing habits to avoid their prolonged use without rest periods.
- In commercial application and public viewing, someone in authority should convey the precautions and monitor the user of the 3D Eyewear.
- Use only the 3D Eyewear recommended for this TV.
- Only use the 3D Eyewear for its intended 3D content viewing purpose.
- Do not move around while wearing the 3D Eyewear.

The surrounding area appears dark, which may result in falling or other accidents that may cause injury.

- Inspect the 3D Eyewear for damage before each use.

#### ■ Viewing of 3D Images

- In the event that you experience dizziness, nausea, or other discomfort while viewing 3D images, discontinue use and rest your eyes.

When you set the effect by using "3D adjustment", take into account that the vision of 3D images varies among different individuals.

- Do not use if the 3D Eyewear is cracked or broken.
- Content for 3D viewing includes commercially available Blu-ray discs, 3D broadcasts, etc.
- When preparing your own 3D content, ensure that it is properly produced.

## FCC and IC STATEMENT

This equipment has been tested and found to comply with the limits for an Other Class B digital device, pursuant to Part 15 of the FCC Rules. These limits are designed to provide reasonable protection against harmful interference in a residential installation. This equipment generates, uses and can radiate radio frequency energy and, if not installed and used in accordance with the instructions, may cause harmful interference to radio communications. However, there is no guarantee that interference will not occur in a particular installation. If this equipment does cause harmful interference to radio or television reception, which can be determined by turning the equipment off and on, the user is encouraged to try to correct the interference by one or more of the following measures:

- Reorient or relocate the receiving antenna.
- Increase the separation between the equipment and receiver.
- Connect the equipment into an outlet on a circuit different from that to which the receiver is connected.
- Consult the Panasonic Service Center or an experienced radio/TV technician for help.

#### FCC Caution:

To assure continued compliance, follow the attached installation instructions and use only shielded interface cables when connecting to peripheral devices. Any changes or modifications not expressly approved by Panasonic Corp. of North America could void the user's authority to operate this device.

#### FCC and Industry Canada (IC) RF Exposure Warning:

- This TV is provided with two built-in transmitters: (1) Wireless LAN Adapter with FCC ID: NKR-P75/ IC ID: 4441A-P75; and (2) Bluetooth Adapter with FCC ID: NKR-P705/IC ID: 4441A-P705.
- These transmitters comply with FCC and IC radiation exposure limits set forth for an uncontrolled environment for mobile use with minimum 8 inches (20 cm) spacing requirement between transmitters and all person's body (excluding extremities of hands, wrist and feet) during wireless modes of operation.
- This TV may also be provided with a Touch Pad Controller approved under FCC ID: MG3-0602309/ IC ID: 2575A-0602309.
- Other third-party wireless transmitters should not be used as they have not been RF exposure evaluated for use with this TV and may not comply with RF exposure requirements.

<Only for wireless LAN if capable of transmission in the 5.15 ~ 5.25 GHz frequency band>

This product is restricted to indoor use due to its operation in the 5.15 to 5.25 GHz frequency range.

FCC and IC require this product to be used indoors for the frequency range 5.15 to 5.25 GHz to reduce the potential for harmful interference to co-channel Mobile Satellite systems. High power radars are allocated as primary users of the 5.25 to 5.35 GHz and 5.65 to 5.85

GHz bands. These radar stations can cause interference with and/or damage this product.

Responsible Party:

Panasonic Corporation of North America  
Two Riverfront Plaza, Newark, NJ 07102-5490

Support Contact:

<http://www.panasonic.com/contactinfo>

This device complies with Part 15 of the FCC Rules and all applicable IC RSS standards.

Operation is subject to the following two conditions:

- (1) This device may not cause harmful interference, and
- (2) this device must accept any interference received, including interference that may cause undesired operation.

### **WARNING**

Flat panel displays are not always supported on the proper stands or installed according to the manufacturer's recommendations. Flat panel displays that are inappropriately situated on dressers, bookcases, shelves, desks, speakers, chests, or carts may fall over and may cause personal injury or even death.

The Consumer Electronics Association (CEA), of which Panasonic is a member, is committed to making home entertainment enjoyable and safe. To prevent personal injury or death, be sure to follow these following safety guidelines:

### **CEA CHILD SAFETY NOTICE**

#### **THE CONSUMER ELECTRONICS INDUSTRY CARES**

- Manufacturers, retailers and the rest of the consumer electronics industry are committed to making home entertainment safe and enjoyable.
- As you enjoy your television, please note that all televisions – new and old- must be supported on proper stands or installed according to the manufacturer's recommendations. Televisions that are inappropriately situated on dressers, bookcases, shelves, desks, speakers, chests, carts, etc., may fall over, resulting in injury.

#### **TUNE IN TO SAFETY**

- ALWAYS follow the manufacturer's recommendations for the safe installation of your television.
- ALWAYS read and follow all instructions for proper use of your television.
- NEVER allow children to climb on or play on the television or the furniture on which the television is placed.
- NEVER place the television on furniture that can easily be used as steps, such as a chest of drawers.
- ALWAYS install the television where it cannot be pushed, pulled over or knocked down.
- ALWAYS route cords and cables connected to the television so that they cannot be tripped over, pulled or grabbed.

### **WALL OR CEILING MOUNT YOUR TELEVISION**

- ALWAYS contact your retailer about professional installation if you have any doubts about your ability to safely mount your television.
- ALWAYS use a mount that has been recommended by the television manufacturer and has a safety certification by an independent laboratory (such as UL, CSA, ETL).
- ALWAYS follow all instructions supplied by the television and mount manufacturers.
- ALWAYS make sure that the wall or ceiling where you are mounting the television is appropriate. Some mounts are not designed to be mounted to walls and ceilings with steel studs or cinder block construction. If you are unsure, contact a professional installer.
- Televisions can be heavy. A minimum of two people is required for a wall or ceiling mount installation.

### **MOVING AN OLDER TELEVISION TO A NEW PLACE IN YOUR HOME**

- Many new television buyers move their older CRT televisions into a secondary room after the purchase of a flat-panel television. Special care should be made in the placement of older CRT televisions.
- ALWAYS place your older CRT television on furniture that is sturdy and appropriate for its size and weight.
- NEVER place your older CRT television on a dresser where children may be tempted to use the drawers to climb.
- ALWAYS make sure your older CRT television does not hang over the edge of your furniture.

**Panasonic recommends that a qualified installer perform the wall-mount installation. See page 25.**



**The American Academy of Pediatrics discourages media viewing for children younger than two years. For more details, see [www.aap.org](http://www.aap.org).**

#### **NOTE:**

This equipment is designed to operate in North America and other countries where the broadcasting system and AC house current are exactly the same as in North America.



# Accessories/ Optional accessories

## Accessories

Check that all the following items have been included with your TV

Remote Control

- N2QAYB000925



Touch Pad Controller

- N2QBYA000004

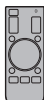

Batteries

- AA Battery (2)  
(For Remote Control)
- AAA Battery (2)  
(For Touch Pad Controller)



Power cord



Pedestal

- Assembly (p. 9)

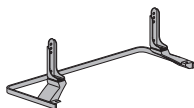

3D Eyewear (2)



Owner's Manual

Quick start guide

Child safety sheet

Product Registration Card (U.S.A.)

## Optional Accessories

Please contact your nearest Panasonic dealer to purchase the recommended optional accessories. For additional details, please refer to the optional accessories installation manual.

- Product information (Model No. and release date etc.) is subject to change without notice.
- For more information  
(USA/Canada) <http://www.panasonic.com>  
(Global reference) <http://panasonic.net/viera>

### Communication Camera

- TY-CC20W
  - This camera can be used in the video communication tool.
  - For details, read the manual for the Communication Camera.



### 3D Eyewear

- TY-EP3D20U  
(1 pack includes 2 eyewears)
  - Use Panasonic 3D Eyewear supporting passive 3D system technology.



## Attaching the pedestal to TV

### (A) Assembly screws

(Black) (4)



M5 × 15

### (B) Assembly screws

(Black) (4)



M4 × 12

### (C) Bracket (2)



### (D) Base

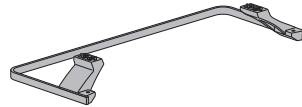

## ■ Attaching the pedestal

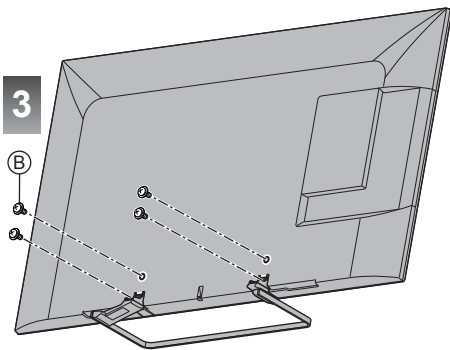
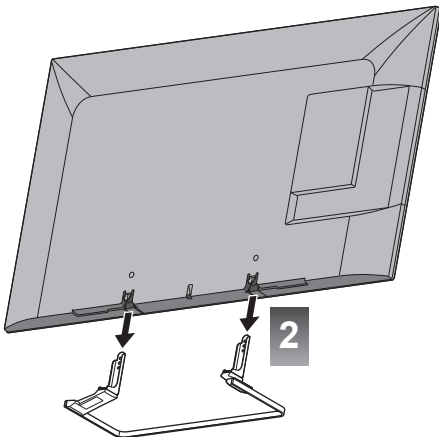
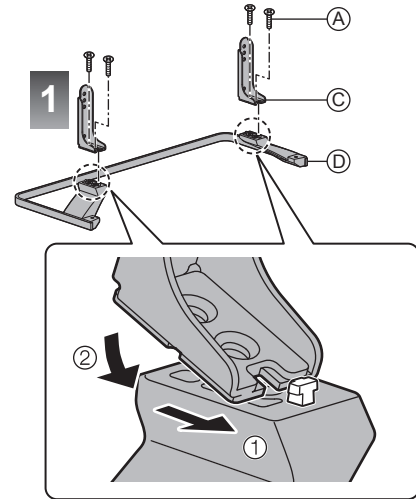

## Removing the pedestal from the TV

Be sure to remove the pedestal in the following way when using the wall-hanging bracket or repacking the TV.

- 1 Remove the assembly screw ⑥ from the TV.
- 2 Lift the TV from the pedestal.
- 3 Remove the assembly screws ① from the bracket.

### Warning

#### Do not disassemble or modify the pedestal.

- Otherwise, the TV may fall over and become damaged, and personal injury may result.

### Caution

#### Do not use any pedestal other than that provided with this TV.

- Otherwise, the TV may fall over and become damaged, and personal injury may result.

#### Do not use the pedestal if it becomes warped or physically damaged.

- If you use the pedestal when it is physically damaged, personal injury may result. Contact your nearest Panasonic Dealer immediately.

#### During set-up, make sure that all screws are securely tightened.

- If sufficient care is not taken to ensure screws are properly tightened during assembly, the pedestal will not be strong enough to support the TV, and it might fall over and become damaged, and personal injury may result.

#### When removing the pedestal, do not remove the pedestal by any methods other than the specified procedure. (p. 10)

- Otherwise, the TV and/or pedestal may fall over and become damaged, and personal injury may result.

## ■ Moving the TV

Before moving the TV, disconnect all cables.

- Move the TV with at least two people.

# Connections

Please refer to eHELP (p. 21) for other connections (VIERA Link connection etc.).

## Connection Panels

Back of the TV

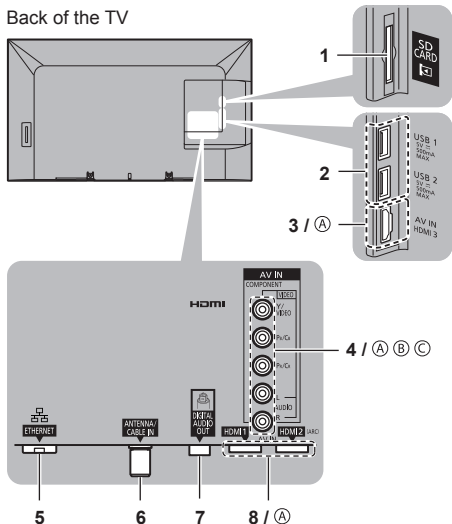

- 1 SD Card slot
- 2 USB1/2
- 3 HDMI3
- 4 Component/Video terminal
- 5 Ethernet connector
- 6 Antenna cable in
- 7 Digital audio out
- 8 HDMI1/2
  - For (A), (B), (C) connections, please refer to p. 12

### VHF/UHF Antenna

- NTSC (National Television System Committee): Analog television system
- ATSC (Advanced Television Systems Committee): Digital TV Standards include digital high-definition television (HDTV), standard-definition television (SDTV), data broadcasting, multi-channel surround sound audio and interactive television.

## Power cord connection

Back of the TV

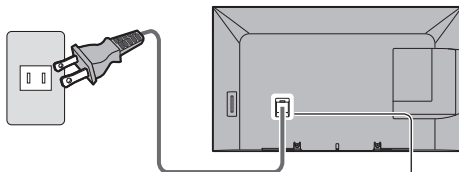

### Power Cord

Connect after all other connections have been made.



**Insert the power cord plug (included) firmly into place.**

Important:

- Disconnect the power cord plug from the wall out first.
- The included power cord is for use with this unit only.

## Antenna connection

Back of the TV

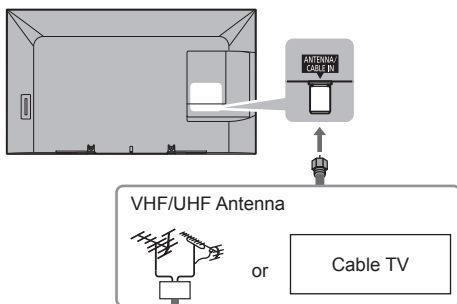

### Cable

- You need to subscribe to a cable TV service to enjoy viewing their programming.
- A high-definition connection can be made using an HDMI or Component Video cable. (p. 12)

### Note

- When using a Cable box, external equipment and video cables shown in this manual are not supplied with the TV.
- For additional assistance, visit us at:  
[www.panasonic.com/support](http://www.panasonic.com/support)  
[www.panasonic.ca/english/support](http://www.panasonic.ca/english/support)

## AV cable connection

### A To use HDMI terminals (for best HD picture)

(Set-top-box / DVD recorder / Blu-ray Disc player / Camcorder / etc.)

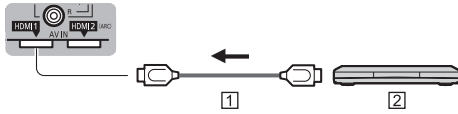

- 1 HDMI cable
- 2 AV Equipment (e.g. Blu-ray Disc player)

### For devices with DVI output

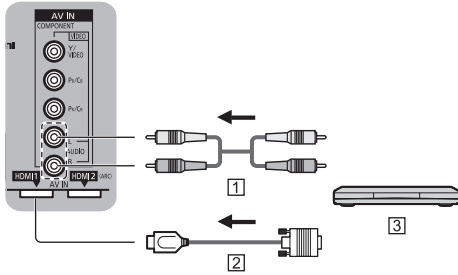

- 1 Audio cable
- 2 HDMI-DVI Conversion cable
- 3 AV Equipment (e.g. Blu-ray Disc player)

### B To use COMPONENT terminals

(DVD recorder / Blu-ray Disc player / etc.)

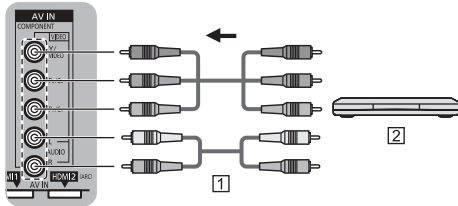

- 1 Component cable
- 2 AV Equipment (e.g. Blu-ray Disc player)

### C To use COMPOSITE terminals (for SD picture)

(Camcorder / Game system / DVD recorder / etc.)

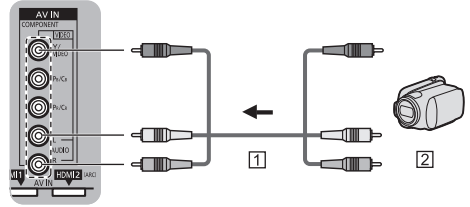

- 1 VIDEO cable
- 2 AV Equipment (e.g. Camcorder)

#### Note

- In some cases, it is not possible to connect depending on the type of cable or equipment.
- The Green terminal is shared for both the COMPONENT and COMPOSITE (VIDEO IN) connection. When using COMPOSITE (VIDEO IN) connection, the Yellow connector (VIDEO) should be inserted into Green connection.

## Network connection

- To enable the network service functions, you need to connect the TV to a broadband network environment. If you do not have any broadband network services, please consult your retailer for assistance.
- Prepare the Internet environment for wired connection or wireless connection.

### ■ Wired connection

TV

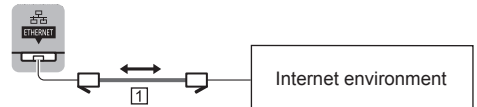

- 1 LAN cable (Shielded)

### ■ Wireless connection



- 1 Built-in wireless LAN
- 2 Access point

## ■ About built-in wireless LAN/Bluetooth

- To use the built-in wireless LAN, using an access point is recommended.
- To use the built-in wireless LAN in the access point mode, up to 7 devices are connectable. But the transfer rate will vary according to communication environment or connected equipments.
- Do not use the built-in wireless LAN to connect to any wireless network (SSID\*1) for which you do not have usage rights. Such networks may be listed as a result of searches. However, using them may be regarded as illegal access.
- Check that the Access point supports WPS\*2.  
(If it does not support WPS, the encryption key of the Access point is required when configuring settings.)

- Follow the instructions on the Access point setup screen and configure the appropriate security settings.

For more details on setting of Access point, please refer to operating manual for the Access point.

- We recommend using 11n (5 GHz) for the wireless system between the built-in wireless LAN and Access point.

Communication is also possible with 11a, 11b, and 11g, but the communication speed may be slower.

- If the wireless system of the Access point is changed, devices that could connect by wireless LAN may no longer be able to connect.
- Data transmitted and received over radio waves may be intercepted and monitored.
- Keep the TV away from the following devices as much as possible:

Wireless LAN, microwaves, and other devices that use 2.4 GHz and 5 GHz signals. Otherwise, the TV failures such as malfunction may occur due to the radio wave interference.

- When noises occur due to the static electricity, etc., the TV might stop operating for the protection of the devices. In this case, turn the TV Off with power On / Off switch, then turn it On again.

\*1 SSID is a name for identifying a particular wireless network for transmission.

\*2 WPS: Wi-Fi Protected Setup

## Audio connection

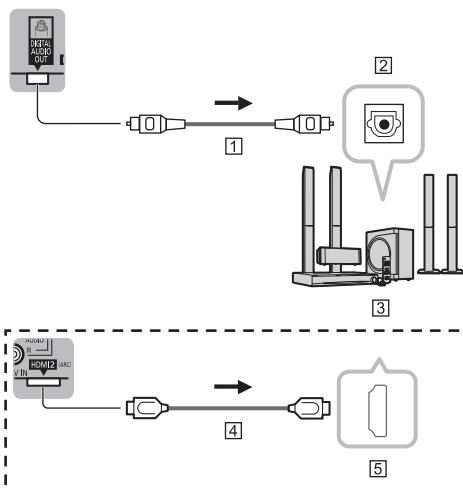

- ① Optical cable
- ② DIGITAL AUDIO IN
- ③ e.g. Amplifier with speaker system
- ④ HDMI cable
- ⑤ HDMI OUT (ARC)

HDMI connection is available if connected audio equipment has ARC (Audio Return Channel) function.

- Please refer to eHELP (p. 21) for more details.

# Identifying Controls

## TV controls/indicators

Front of the TV

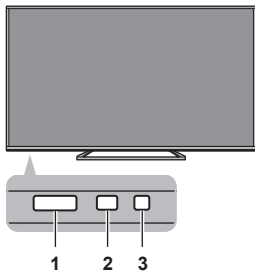

- 1 Remote Control sensor  
Maximum range for remote is 23 feet (7 meters) from front of TV set.
- 2 C.A.T.S. (Contrast Automatic Tracking System)
- 3 Power indicator (On: red, Off: no light)

Back of the TV

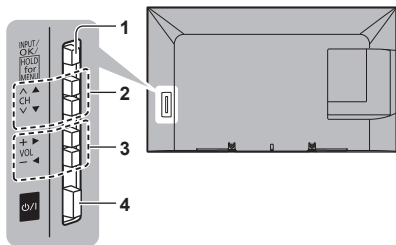

- 1 Changes the input mode  
Selects Menu and Submenu entries  
(Press and hold down for MENU function)
  - 2 Selects channels in sequence
  - 3 Volume up/down
  - 4 POWER button
- An image of the control panel is displayed on the screen while in use.

### Note



- The TV consumes a small amount of electric energy even when turned off.
- Do not place any objects between the TV remote control sensor and remote control.

Panasonic does not guarantee operation and performance of peripheral devices made by other manufacturers; and we disclaim any liability or damage arising from operation and/or performance from usage of such other maker's peripheral devices.

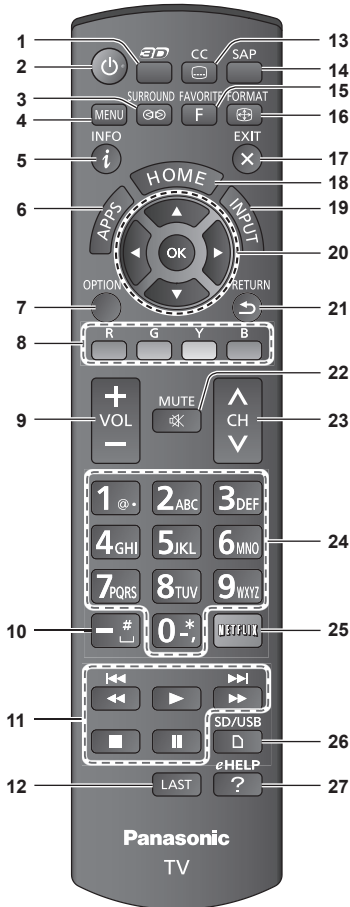
## Remote Control



- 1 Displays 3D settings
- 2 Switches TV On or Off (Standby)
- 3 Switches surround sound setting
- 4 Displays Menu
- 5 Displays or removes the information banner
- 6 Displays Apps (application) list
- 7 Displays Option Menu for special functions (when available)
- 8 Colored buttons (used for various functions)
- 9 Volume up/down
- 10 Use for digital channels
- 11 External equipment operations
- \* Functions are switched depending on connected external equipment and operation.
- 12 Switches to previously viewed channel or input

 : Press and hold to skip backward/forward.

- 13 Closed caption On/Off
- 14 Selects Secondary Audio Programming
- 15 Operates the Favorite channel list function
- 16 Changes aspect ratio and zoom
- 17 Returns to Home Screen
- 18 Displays Home Screen
- 19 Selects source to watch
- 20 Selects/OK/Change
- 21 Go back to previous menu
- 22 Sound mute On/Off
- 23 Channel up/down, when viewing from ANT/Cable source
- 24 Numeric keypad to select any channel or press to enter alphanumeric input in menus
- 25 Accesses NETFLIX service directly
  - This service requires an Internet connection.
  - This service might be stopped or the conditions changed without notice.
- 26 Viewing from external media
- 27 Displays eHELP (built-in manual) (p. 21)



## Touch Pad Controller

The Touch Pad Controller is designed to facilitate TV operations, such as when accessing Home Screen or the Browser with the Touch Pad and free pointing system. It also covers other TV operations as a Remote Control.

- Touch Pad Controller must be paired with the TV prior to operation. (Pairing to this TV with Bluetooth wireless technology.)

### ■ Parts names and functions

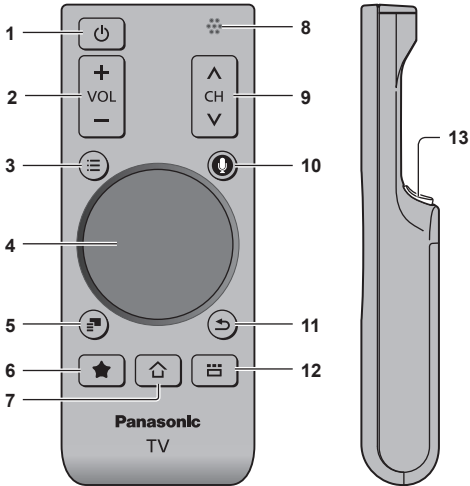

- 1 Power button
- 2 Volume up/down
- 3 Menu (Displays Menu)
- 4 Touch Pad
- 5 Option menu (Displays Option menu)
- 6 My button (Register your favorite contents)
- 7 HOME (Displays Home Screen)
- 8 Microphone
- 9 Channel up/down
- 10 To use microphone
- 11 RETURN
- 12 Apps (Displays Apps list)
- 13 OK
  - The Touch Pad Controller must be pointed toward the TV to turn on the power. (Only the Power-on switch works at first.)
  - The TV can be paired with one Touch Pad Controller only.
  - Please refer to eHELP (p. 21) for more information about My button.
  - About Voice Control:  
It is recommended to speak within about 6 inches (15 cm) from microphone of Touch Pad Controller when using Voice Control function. (Please refer to eHELP (p. 21) for Voice Control function.)
  - Transmission Range:

Use the Touch Pad Controller within the range of 10.5 ft (3.2 m) from front surface of the TV. The range may be shortened if there are any obstacles or can be affected by the surrounding environment or building structure.

### ■ Pairing Touch Pad Controller

- 1 Insert the batteries in the Touch Pad Controller.
- 2 Hold the Touch Pad Controller within 1.6 ft. (50 cm) of the TV.
- 3 Operate touch pad or press any button other than Power button to start pairing.
- 4 Please complete the pairing by checking the status in the pairing guide on the screen.
  - You can also pair the Touch Pad Controller. (Press MENU > Setup > Touch Pad settings)

### ■ Operating Touch Pad Controller

#### Touch Pad operations



Tap:

Tap center of the pad to "OK".

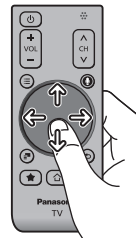

Swipe:

Slide your finger to swipe.

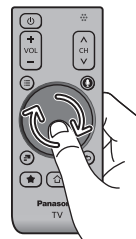

Trace the fringe to scroll.

- Some operations differ depending on the application.

## Installing the remote's batteries

### ■ Remote Control

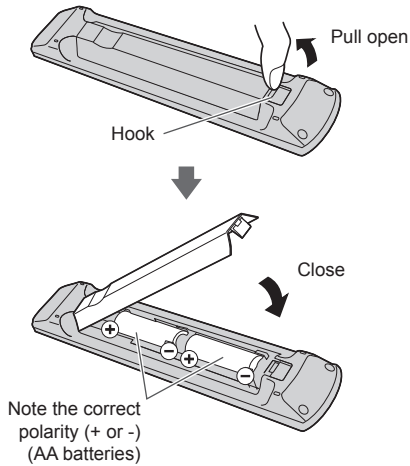

### ■ Touch Pad Controller

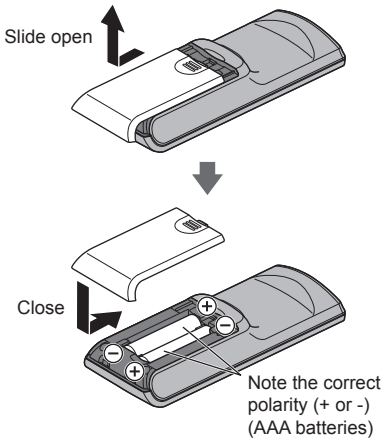

#### Warning

- Do not allow children to handle remote control batteries.
  - As with any small object, remote control batteries can be swallowed by young children.

#### Caution

- Incorrect installation may cause battery leakage and corrosion, resulting in damage to the remote control.
  - Do not mix old and new batteries.
  - Do not mix different battery types (such as alkaline and manganese batteries).
  - Do not use rechargeable (Ni-Cd) batteries.
- Do not burn or break batteries.

# First Time Setup

The first time setup screen is displayed only when the TV is turned on for the first time, after the power cord is inserted into a wall outlet.

## 1 Turn the TV on with the POWER button

(TV)

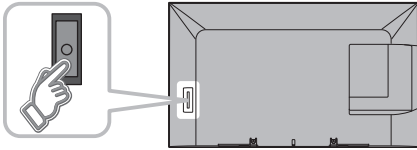

or

(Remote)

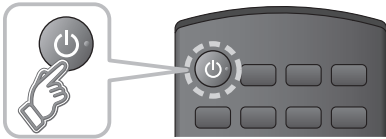

## 2 Setup the following items

- **Select your language**
- **Select your country**
- **Select your viewing mode**  
(Be sure to select "Home Use")

If you select "Store Demonstration" by mistake, confirmation screen will be displayed.

To display the "Set viewing mode" screen again in order to select "Home Use", perform one of the following actions:

- Press and hold down the rear POWER button for at least five seconds.
  - Unplug the power cord for 30 seconds and then plug it in again.
- **Configure Network connection**  
Follow the instructions on screen to complete the Network connection.
  - **ANT/Cable setup**  
Set up based on how your TV programming is connected. Select "Yes" if you are connected to a Cable, Satellite or Fiber Optic box. Select "No" if you are connected to the Antenna/Cable In with a coaxial wire into the screw-on connector. In this case you will need to scan for channels that are available in your area.
  - **Adjust the Clock**  
Select the clock mode and adjust other settings.  
When "Auto" is selected, clock will be set automatically according to Time zone and DST. The TV must be connected to the Internet to use this feature.

- **Complete first time setup**  
Completion screen is displayed.

## 3 Select type of Home Screen

The "Tutorial" for "my Home Screen" starts.

Follow the instruction of the "Tutorial" to select desired "Home Screen".

Example: Home Screen Selection



Example: Lifestyle Screen



- "Home Screen" is displayed as the start-up screen when the TV is turned on or the HOME button is pressed.

# Operations

## Turn power on

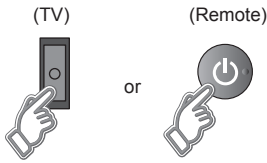

The last viewed Home Screen is displayed each time the TV is turned on.

Example: Lifestyle Screen



Example: Selected content screen



- To return to "Home Screen" at any time.



- You can customize "Home Screen" and display desired information, access specific features easily, select the default "Home Screen", etc. For details, follow the on-screen instructions or refer to the eHELP (Using my Home Screen > my Home Screen > Settings).

## Watching TV

### Select the TV viewer from "Home Screen"



To watch TV via a Cable box, Satellite receiver, or any other source (DVD, DVR, gaming device, etc.), press the INPUT button and select the appropriate input.

## To access each feature

### Access "Apps list" and select a feature

Example: Apps list



- Apps are the applications (features) of the TV.
- For operations of each feature and the setup of "Apps list", follow the on-screen instructions or refer to the eHELP (Using my Home Screen > Using Apps list).

# Viewing 3D images on TV

## Using Precautions

### ■ Cautions during viewing

- Wear the 3D Eyewear correctly. 3D images will not be correctly visible if the 3D Eyewear is worn upside down or back-to-front.

### ■ For comfortable viewing

- View from at least the recommended distance (3 times the effective height of the screen),

Recommended Distance:

For a 50-inch television, 6.23 ft (1.9 m) or more

When the top and bottom area of the screen are blackened, such as when playing movies, view the screen at a distance 3 times further than the height of the actual image. (That makes the viewing distance closer than above recommended distance.)

- Stop using the 3D Eyewear immediately if your skin feels unusual. In rare cases, the paint or materials used in the 3D Eyewear may cause an allergic reaction.
- Stop using the 3D Eyewear immediately if you experience any redness, pain, or itching on the nose or temples. Prolonged use may cause such symptoms due to excess pressure, which may result in the user feeling unwell.

## Viewing 3D images

Using the television menu controls, set so that 3D images are shown.

- You can watch 3D images in the following cases:
  - When a 3D image supporting Blu-ray Disc is played on a 3D image supporting player/recorder connected using a HDMI cable to a 3D image supporting television.
  - 3D image supported broadcast (program)
  - 3D Photo, 3D Movie taken by LUMIX/Camcorder

## 1 Put on the 3D Eyewear

## 2 View

When the TV receives a 3D signal, it also tries to detect the 3D mode (format). 3D images are automatically displayed according to the signal.

If the 3D images are not displayed correctly or the images cause discomfort, the images can be adjusted by "3D format select" or "3D settings".

## Change the view 3D ↔ 2D

- Simply switches 3D ↔ 2D images (Auto mode)

(example)

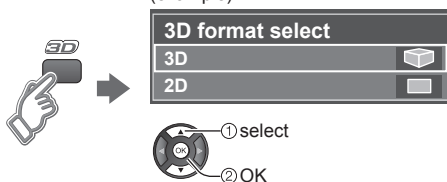

-  → Switches to Manual mode

# Using eHELP (Built-in Manual)

eHELP is a built-in manual that explains how to easily operate the TV's features. Press the eHELP button to access the guide.

## 1 Display eHELP

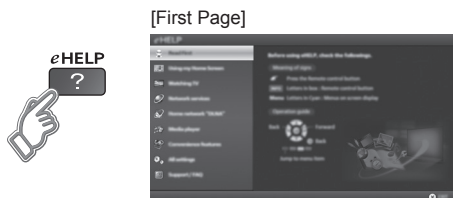

When you enter eHELP again after exiting, the confirmation screen is displayed while the TV is turned on. You can select "First Page" or "Last Page".

## 2 Select the desired page from the menu

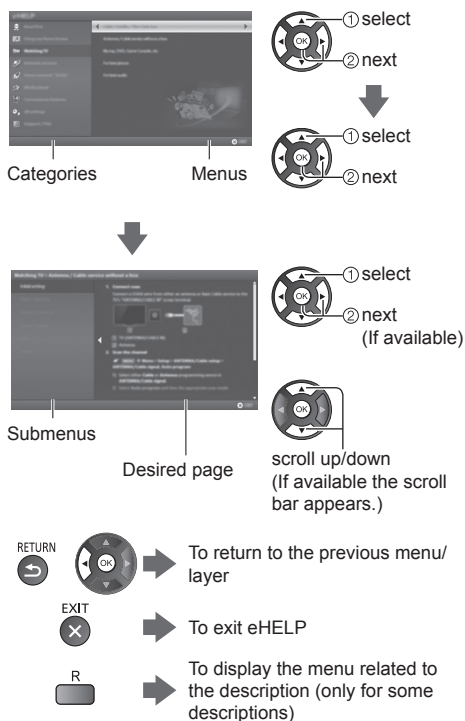

# Frequently Asked Questions (FAQ)

---

## How can I confirm that my TV is working properly?

---

- The TV has a built-in Self Test. On the remote control, press MENU and scroll down and select HELP to access the TV SELF TEST. Run the test and follow the on screen instructions.

## Why doesn't the remote control work?

---

- Check that the batteries are fresh, are of the same type and are installed with the correct polarity (+ & -).
- To operate other devices, such as changing channels when using Cable or Satellite boxes, or operating non-Panasonic Blu-ray players, use the remote supplied with the device.

## Why is there no picture or just a blue, black or snowy screen being displayed?

---

- Ensure that the power cord is plugged in and the TV is turned on (front red LED light should be on, not blinking).
- Press the INPUT button on the remote to select the correct input source.
- Ensure all connections are correct and secure.
- When using external video source, such as a Cable/Satellite box or DVD player, ensure that the device is on and functioning correctly.
- Press MENU on the TV's remote control. If the menu is displayed, then the TV is working; recheck above steps.

## The display panel moves slightly and clattered sound is heard when it is pushed with a finger.

---

- There is a little gap around the panel to prevent damage to the panel. This is not a malfunction.

## Why is the screen blank and the power indicator blinking?

---

- The TV has gone into shutdown mode to protect itself. Try unplugging it for a few minutes and connecting it again. If there was a temporary power surge on the AC line it may now be OK. If the blinking returns, visit [www.panasonic.com/support](http://www.panasonic.com/support) (U.S.A.) or [www.panasonic.ca/english/support](http://www.panasonic.ca/english/support) (Canada).

## Why doesn't the Touch Pad Controller work?

---

- Check that the batteries are fresh, are of the same

- type and are installed with the correct polarity (+ & -).
- Check if the controller is paired with the TV. (p. 16)
- Check if the pairing range is within 1.6 ft (50 cm).
- Check if the Touch Pad Controller is pointed toward the TV to turn on the power.

# Care and Cleaning

## First, unplug the power cord plug from the wall outlet.

### Display panel

The front of the display panel has been specially treated. Wipe the panel surface gently using only a cleaning cloth or a soft, lint-free cloth.

- If the surface is particularly dirty after cleaning up the dust, soak a soft, lint-free cloth in diluted, mild liquid dish soap (1 part mild liquid dish soap diluted by 100 times the amount of water), and then wring the cloth to remove excess liquid. Use this cloth to wipe the surface of the display panel, then wipe it evenly with a dry cloth of the same type until the surface is dry.
- Do not scratch or hit the surface of the panel with fingernails or other hard objects. Furthermore, avoid contact with volatile substances such as insect sprays, solvents, and thinner; otherwise, the quality of the surface may be adversely affected.

### Cabinet

If the cabinet becomes dirty, wipe it with a soft, dry cloth.

- If the cabinet is particularly dirty, soak the cloth in diluted, mild liquid dish soap and then wring the cloth dry. Use this cloth to wipe the cabinet and then wipe it dry with a dry cloth.
- Do not allow any mild liquid dish soap to come into direct contact with the surface of the TV. If water droplets get inside the unit, operating problems may result.
- Avoid contact with volatile substances such as insect sprays, solvents, and thinner; otherwise, the quality of the cabinet surface may be adversely affected or the coating may peel off.
- Do not let articles made from rubber or PVC be in contact with the TV for long periods of time.

### Pedestal

#### Cleaning

- Wipe the surfaces with a soft, dry cloth. If the unit is particularly dirty, clean it using a cloth soaked with water to which a small amount of mild liquid dish soap has been added and then wipe with a dry cloth. Do not use products such as solvents, thinner, or household wax for cleaning, as they can damage the surface coating.

Note: If using a chemically-treated cloth, follow the instructions supplied with the cloth.

- Do not attach sticky tape or labels, as they can make the surface of the pedestal dirty. Do not allow long-term contact with rubber, vinyl products, or the like. (Doing so will cause deterioration.)

### Power cord plug

Wipe the plug with a dry cloth at regular intervals.

Note: Moisture and dust can lead to fire or electrical shock.

### 3D Eyewear

- Clean using a soft, dry cloth.
- Wiping the 3D Eyewear with a soft cloth that is covered in dust or dirt may scratch the eyewear. Shake off any dust from the cloth before use.
- Do not use benzene, thinner, or wax on the 3D Eyewear, as doing so may cause the paint to peel off.
- Avoid storing the 3D Eyewear in hot or highly humid locations.



# Specifications

## Display Panel

### Panel System

LCD panel with LED backlight

### Screen size

50" class (49.5 inches measured diagonally)

### W × H × Diagonal

43.1" × 24.2" × 49.5"  
(1,096 mm × 616 mm × 1,257 mm)

### Number of pixels

1,920 × 1,080

## Speaker Output

20 W [10 W + 10 W]

## Channel Capability (Digital/Analog)

VHF/ UHF: 2 - 69, CATV: 1 - 135

## Operating Conditions

Temperature: 32 °F - 95 °F (0 °C - 35 °C)

Humidity: 20 % - 80 % RH (non-condensing)

## Connection Terminals

### VIDEO IN

RCA PIN (VIDEO, AUDIO-L, AUDIO-R)

### COMPONENT IN

RCA PIN (Y, PB/CB, PR/CR, AUDIO-L, AUDIO-R)

### HDMI IN 1/2/3

Type A connector  
(supports "HDMI Control 5" function)

### USB 1/2

Type A connector  
DC 5 V, Max. 500 mA [Hi-Speed USB (USB 2.0)]

### DIGITAL AUDIO OUT

PCM / Dolby Digital / DTS, Fiber Optic

### OTHERS

SD Card slot, ETHERNET (10BASE-T/100BASE-TX)

## Dimensions

### Including pedestal (W × H × D)

44.5" × 27.7" × 8.5"  
(1,130 mm × 703 mm × 214 mm)

### TV Set only (W × H × D)

44.5" × 25.9" × 2.2"  
(1,130 mm × 658 mm × 54 mm)

## Mass

### Including pedestal

34.2 lb. (15.5 kg) NET

### TV Set only

32.0 lb. (14.5 kg) NET

## Wireless LAN

### Standard Compliance and Frequency Range \*1, \*2

IEEE 802.11a/n: 5.15 GHz - 5.35 GHz,  
5.47 GHz - 5.85 GHz

IEEE 802.11b/g/n: 2.400 GHz - 2.4835 GHz

### Security

WPA2-PSK (TKIP/AES)

WPA-PSK (TKIP/AES)

WEP (64bit/128bit)

\*1 The frequency and channel differ depending on the country.

\*2 802.11b/g/n CH1 ~ CH11 only use for United States and Canada.

## Bluetooth

### Standard Compliance

Bluetooth® 3.0

### Frequency Range

2.402 GHz - 2.480 GHz

### Note

- Design and Specifications are subject to change without notice. Mass and Dimensions shown are approximate.
- For information about the power source and power consumption, refer to the nameplate on the rear enclosure.
- Use Panasonic 3D Eyewear supporting passive 3D system technology.
- Touch Pad Controller uses Bluetooth wireless technology.

## ■ When using the wall-hanging bracket

Please contact a professional installer to purchase the recommended UL qualified wall-hanging bracket. For additional details, please refer to the wall-hanging bracket installation manual.

Back of the TV

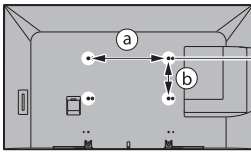

a 15.7" (400 mm)

b 7.9" (200 mm)

Holes for wall-hanging  
bracket installation

(View from the side)

**Diameter of screw: M6**

**Depth of screw**

**Minimum: 0.35" (9.0 mm)**

**Maximum: 0.71" (18.0 mm)**

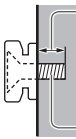

Screws for attaching the TV to the wall-hanging bracket (not supplied with the TV)

### Warning

- Always be sure to ask a qualified technician to carry out set-up.
- Do not mount the unit directly below ceiling lights (such as spotlights, floodlights or halogen lights) that typically give off high heat. Doing so may warp or damage plastic cabinet parts.
- Take care when fixing wall brackets to the wall. Always ensure that there are no electrical cables or pipes in the wall before hanging bracket.
- To prevent fall and injury, remove the TV from its fixed wall position when it is no longer in use.
- Incorrect wall-hanging bracket or incorrect fitting may cause equipment to fall, resulting in injury and product damage.
- Panasonic disclaims liability for any damage or injury arising from incorrect wall-hanging bracket, incorrect fitting or otherwise failure to follow the above instructions.



# Limited Warranty (for U.S.A.)

## Panasonic Television Limited Warranty

### Limited Warranty Coverage

If your product does not work properly because of a defect in materials or workmanship, Panasonic Corporation of North America (referred to as "the warrantor") will, for the length of the period indicated on the chart below, which starts with the date of original purchase ("Limited Warranty period"), at its option either (a) repair your product with new or refurbished parts, (b) replace it with a new or a refurbished equivalent value product, or (c) refund your purchase price. The decision to repair, replace or refund will be made by the warrantor.

TV CATEGORIES	PARTS	LABOR	SERVICE
Up to 42" (diagonal)	1 (ONE) YEAR	1 (ONE) YEAR	Carry-In
46" (diagonal) and larger			On-Site
3D Eyewear (Passive - non battery operated)	90 (NINETY) Days	Not Applicable	Mail in

During the "Labor" Limited Warranty period there will be no charge for labor. During the "Parts" Limited Warranty period, there will be no charge for parts.

You must carry-in your product or arrange for on-site service during the Limited Warranty period. If non-rechargeable batteries are included, they are not warranted. This Limited Warranty only applies to products purchased and serviced in the United States. This Limited Warranty is extended only to the original purchaser of a new product which was not sold "as is". A purchase receipt or other proof of the original purchase date is required for Limited Warranty service.

### On-Site, Carry-In or Mail-In Service

To submit a new repair request and for quick repair status visit our Web Site at [www.panasonic.com/repair](http://www.panasonic.com/repair).

On-site service where applicable requires clear, complete and easy access to the product by the authorized servicer and does not include removal or re-installation of an installed product. It is possible that certain on-site repairs will not be completed on-site, but will require that the product or parts of the product, at the servicer's discretion be removed for shop diagnosis and/or repair and then returned.

When shipping the unit, carefully pack, include all accessories, and send it prepaid, adequately insured and preferably in the original carton. When shipping Lithium Ion batteries please visit our Web Site at [www.panasonic.com/BatteryHandling](http://www.panasonic.com/BatteryHandling) as Panasonic is committed to providing the most up to date information. Include a letter detailing the complaint, a return address and provide a daytime phone number where you can be reached. A valid registered receipt is required under the Limited Warranty.

### Limited Warranty Limits And Exclusions

This Limited Warranty ONLY COVERS failures due to defects in materials or workmanship, and DOES NOT COVER normal wear and tear or cosmetic damage, nor does it cover markings or retained images on the glass panel resulting from viewing fixed images (including, among other things, non-expanded standard 4:3 pictures on wide screen TVs, or onscreen data in a stationary and fixed location such as network logos, video games and banners). The Limited Warranty ALSO DOES NOT COVER damages which occurred in shipment, or failures which are caused by products not supplied by the warrantor, or failures which result from accidents, misuse, abuse, neglect, bug infestation, mishandling, misapplication, alteration, faulty installation, set-up adjustments, misadjustment of consumer controls, improper maintenance, power line surge, lightning damage, modification, or commercial use (such as in a hotel, office, restaurant, or other business), rental use of the product, service by anyone other than a Factory Service Center or other Authorized Servicer, or damage that is attributable to acts of God.

**THERE ARE NO EXPRESS WARRANTIES EXCEPT AS LISTED UNDER "LIMITED WARRANTY COVERAGE". THE WARRANTOR IS NOT LIABLE FOR INCIDENTAL OR CONSEQUENTIAL DAMAGES RESULTING FROM THE USE OF THIS PRODUCT, OR ARISING OUT OF ANY BREACH OF THIS LIMITED WARRANTY.** (As examples, this excludes damages for lost time, cost of having someone remove or re-install an installed unit if applicable, or travel to and from the servicer. The items listed are not exclusive, but are for illustration only.) **ALL EXPRESS AND IMPLIED WARRANTIES, INCLUDING THE LIMITED WARRANTY OF MERCHANTABILITY, ARE LIMITED TO THE PERIOD OF THE LIMITED WARRANTY.**

Some states do not allow the exclusion or limitation of incidental or consequential damages, or limitations on how long an implied Limited Warranty lasts, so the exclusions may not apply to you.

This Limited Warranty gives you specific legal rights and you may also have others rights which vary from state to state. If a problem with this product develops during or after the Limited Warranty period, you may contact your dealer or Service Center. If the problem is not handled to your satisfaction, then write to the warrantor's Consumer Affairs Department at the addresses listed for the warrantor.

**PARTS AND SERVICE (INCLUDING COST OF AN ON-SITE SERVICE CALL, WHERE APPLICABLE) WHICH ARE NOT COVERED BY THIS LIMITED WARRANTY ARE YOUR RESPONSIBILITY.**

# Customer Services Directory (for U.S.A.)

---

## Customer Services Directory

Obtain Product Information and Operating Assistance, locate your nearest Dealer or Service Center, purchase Parts and Accessories, or make Customer Service and Literature requests by visiting our Web Site at:

<http://www.panasonic.com/support>

or, contact us via the web at:

<http://www.panasonic.com/contactinfo>

■ For hearing or speech impaired TTY users, TTY: 1-877-833-8855

## Accessory Purchases

Purchase Parts, Accessories and Owner's Manual on line for all Panasonic Products by visiting our Web Site at:

<http://www.pstc.panasonic.com>

or, send your request by E-mail to:

[npcparts@us.panasonic.com](mailto:npcparts@us.panasonic.com)

You may also contact us directly at:

1-800-237-9080 (Fax Only) (Monday - Friday 9 am to 9 pm, EST.)

### **Panasonic National Parts Center**

20421 84th Avenue South,

Kent, WA 98032

(We Accept Visa, MasterCard, Discover Card, and American Express)

■ For hearing or speech impaired TTY users, TTY: 1-866-605-1277