

Panasonic®

Model No.
TC-32C400C

Owner's Manual
32" Class 720p LED TV*
(31.5 inches measured diagonally)

VIERA

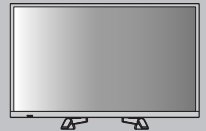

* Panel with LED backlight

Thank you for purchasing this Panasonic product.
Please read these instructions before operating your set and retain them for future reference. The images shown in this manual are for illustrative purposes only.

English



TQB3ACSKUL

Contents

Safety Precautions	4
Setting Up the TV	7
Connecting the TV	9
First Time Setup	11
Operating the TV	12
Watching External Inputs	14
Favorite Channels	14
Using Media Player	15
Using the Menu Functions	17
Auto Program	21
Manual Program	21
Input Labels	22
Ratings List for Parental Control	22
Additional Information	24
Maintenance	26
Troubleshooting	27
Specifications	29
Limited Warranty (for Canada)	30

Illustrations shown may be different between models and countries.

This product incorporates the following software:

- (1) the software licensed under the GNU General Public License, Version 2.0 (GPL V2.0) and/or,
- (2) open sourced software other than the software licensed under the GPL.

The software categorized as (1) - (2) are distributed in the hope that it will be useful, but WITHOUT ANY WARRANTY, without even the implied warranty of MERCHANTABILITY or FITNESS FOR A PARTICULAR PURPOSE. Please refer to the detailed terms and conditions thereof shown in the "License" menu on this product.

At least three (3) years from delivery of this product, Panasonic Corporation will give to any third party who contacts us at the contact information provided below, for a charge no more than our cost of physically performing source code distribution, a complete machine-readable copy of the corresponding source code covered under GPL V2.0 or the other licenses with the obligation to do so, as well as the respective copyright notice thereof.

Contact Information: cdrequest@unipf.jp

The source code and the copyright notice are also available for free in our website below.

<http://www.unipf.jp/dl/DTV13UM/>

Panasonic does not guarantee operation and performance of peripheral devices made by other manufacturers; and we disclaim any liability or damage arising from operation and/or performance from usage of such other maker's peripheral devices.



This mark shows that the construction of the product is double-insulated.



This mark indicates the product operates under AC voltage.



HDMI, the HDMI Logo, and High-Definition Multimedia Interface are trademarks or registered trademarks of HDMI Licensing LLC in the United States and other countries.



Manufactured under license from Dolby Laboratories. Dolby and the double-D symbol are trademarks of Dolby Laboratories.



Safety Precautions

	CAUTION RISK OF ELECTRIC SHOCK DO NOT OPEN	
WARNING: To reduce the risk of electric shock, do not remove cover or back. No user-serviceable parts inside. Refer servicing to qualified service personnel.		



The lightning flash with arrowhead within a triangle is intended to tell the user that parts inside the product are a risk of electric shock to persons.



The exclamation point within a triangle is intended to tell the user that important operating and servicing instructions are in the papers with the appliance.

Note to CATV System Installer

This reminder is provided to direct the CATV system installer's attention to Article 820-40 of the NEC that provides guidelines for proper grounding and, in particular, specifies that the cable ground shall be connected to the grounding system of the building, as close to the point of cable entry as practical.

Secure Ventilation

Slots and openings in the cabinet and the back or bottom are provided for ventilation, and to ensure reliable operation of the TV and to protect it from overheating. These openings must not be blocked or covered. There should be at least 4 inches (10 cm) of space around the TV. The openings should never be blocked by placing the TV on a bed, sofa, rug or other similar surface. This TV should not be placed in a built-in installation such as a bookcase unless proper ventilation is provided.

Important Safety Instructions (TV set)

- 1) Read these instructions.
- 2) Keep these instructions.
- 3) Heed all warnings.
- 4) Follow all instructions.
- 5) Do not use this apparatus near water.
- 6) Clean only with dry cloth.
- 7) Do not block any ventilation openings. Install in accordance with the manufacturer's instructions.

- 8) Do not install near any heat sources such as radiators, heat registers, stoves or other apparatus (including amplifiers) that produce heat.
- 9) Do not defeat the safety purpose of the polarized or grounding-type plug. A polarized plug has two blades with one wider than the other. A grounding type plug has two blades and a third grounding prong. The wide blade or the third prong are provided for your safety. If the provided plug does not fit into your outlet, consult an electrician for replacement of the obsolete outlet.

- 10) Protect the power cord from being walked on or pinched particularly at plugs, convenience receptacles, and the point where they exit from the apparatus.

- 11) Only use attachments / accessories specified by the manufacturer.

- 12) Use only with the cart, stand, tripod, bracket or table specified by the manufacturer, or sold with the apparatus. When a cart is used, use caution when moving the cart / apparatus combination to avoid injury from tip-over.



- 13) Unplug this apparatus during lightning storms or when unused for long periods of time.

- 14) Refer all servicing to qualified service personnel. Servicing is required when the apparatus has been damaged in any way, such as power-supply cord or plug is damaged, liquid has been spilled or objects have fallen into the apparatus, the apparatus has been exposed to rain or moisture, does not operate normally, or has been dropped.

- 15) Operate only from the type of power source indicated on the marking label. If you are not sure of the type of power supplied to your home, consult your television dealer or local power company.

- 16) Follow all warnings and instructions marked on the TV.

- 17) Never push objects of any kind into this TV through cabinet slots as they may touch dangerous voltage points or short out parts that could result in a fire or electric shock. Never spill liquid of any kind on the TV.

- 18) If an outside antenna is connected to the television equipment, be sure the antenna system is grounded so as to provide some protection against voltage surges and built up static charges. In the U.S. Section 810-21 of the National Electrical Code provides information with respect to proper grounding of the mast and supporting structure, grounding of the lead-in wire to an antenna discharge unit, size of grounding conductors, location of antenna discharge unit, connection to grounding electrodes, and requirements for the grounding electrode.

EXAMPLE OF ANTENNA GROUNDING AS PER (NEC) NATIONAL ELECTRICAL CODE

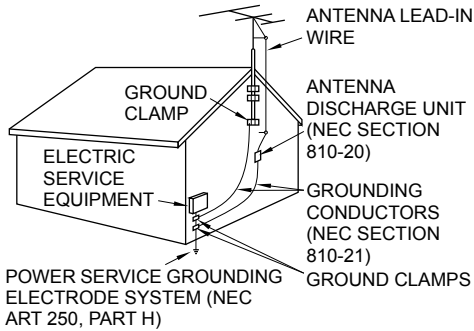

19) An outside antenna system should not be located in the vicinity of overhead power lines, other electric light, power circuits, or where it can fall into such power lines or circuits. When installing an outside antenna system, extreme care should be taken to keep from touching such power lines or circuits as contact with them might be fatal.

20) Unplug this TV from the wall outlet and refer servicing to qualified service personnel under the following conditions:

- When the power cord or plug is damaged or frayed.
- If liquid has been spilled into the TV.
- If the TV has been exposed to rain or water.
- If the TV does not operate normally by following the operating instructions.

Adjust only those controls that are covered by the operating instructions as improper adjustment of other controls may result in damage and will often require extensive work by a qualified technician to restore the TV to normal operation.

- If the TV has been dropped or the cabinet has been damaged.
- When the TV exhibits a distinct change in performance - this indicates a need for service.

21) When replacement parts are required, be sure the service technician uses replacement parts specified by the manufacturer that have the same characteristics as the original parts. Unauthorized substitutions may result in fire, electric shock, or other hazards.

22) **WARNING:**

TO REDUCE THE RISK OF FIRE OR ELECTRIC SHOCK, DO NOT EXPOSE THIS APPARATUS TO RAIN, MOISTURE, DRIPPING OR SPLASHING.

DO NOT PLACE LIQUID CONTAINERS (FLOWER VASES, CUPS, COSMETICS, ETC.) ABOVE THE SET (INCLUDING ON SHELVES ABOVE, ETC.).

23) **WARNING:**

SMALL PARTS CAN PRESENT CHOKING HAZARD IF ACCIDENTALLY SWALLOWED. KEEP SMALL PARTS AWAY FROM YOUNG CHILDREN. DISCARD UNNEEDED SMALL PARTS AND OTHER OBJECTS, INCLUDING PACKAGING MATERIALS AND PLASTIC BAGS/SHEETS TO PREVENT THEM FROM BEING PLAYED WITH BY YOUNG CHILDREN, CREATING THE POTENTIAL RISK OF SUFFOCATION.

24) **WARNING:**

To prevent the spread of fire, keep candles or other open flames away from this product at all times.



25) **WARNING:**

Do not place this TV in any medical institutions or locations with medical devices.

Radio waves from this TV may interfere with the medical devices and cause accidents due to the malfunction.

26) **WARNING:**

Do not use this TV near any automatic control devices such as automatic doors or fire alarms.

Radio waves from this TV may interfere with the automatic control devices and cause accidents due to the malfunction.

27) **WARNING:**

Keep this TV away at least 9 inches (22 cm) from the location where a cardiac pacemaker is implanted.

Radio waves from this TV may interfere with the operation of the pacemaker.

28) **CAUTION:**

The Power switch on this unit will not completely shut off all power from AC outlet. Since the power cord serves as the main disconnect device for the unit, you will need to unplug it from the AC outlet to shut down all power.

Therefore, make sure the unit has been installed so that the power cord can be easily unplugged from AC outlet in case of an accident. To avoid fire hazard, the power cord should also be unplugged from the AC outlet when left unused for a long period of time (for example, when on vacation).

29) **CAUTION:**

TO PREVENT ELECTRIC SHOCK, DO NOT USE THIS PLUG WITH A RECEPTACLE OR OTHER OUTLET UNLESS THE BLADES CAN BE FULLY INSERTED TO PREVENT BLADE EXPOSURE.

30) **CAUTION:**

USE WITH OTHER STAND MAY RESULT IN INSTABILITY POSSIBLY CAUSING INJURY.

31) **CAUTION:**

DANGER OF EXPLOSION IF BATTERY IS INCORRECTLY REPLACED. REPLACE ONLY WITH THE SAME OR EQUIVALENT TYPE.

FCC and IC STATEMENT

This equipment has been tested and found to comply with the limits for an Other Class B digital device, pursuant to Part 15 of the FCC Rules. These limits are designed to provide reasonable protection against harmful interference in a residential installation. This equipment generates, uses and can radiate radio frequency energy and, if not installed and used in accordance with the instructions, may cause harmful interference to radio communications. However, there is no guarantee that interference will not occur in a particular installation. If this equipment does cause harmful interference to radio or television reception, which can be determined by turning the equipment off and on, the user is encouraged to try to correct the interference by one or more of the following measures:

- Reorient or relocate the receiving antenna.
- Increase the separation between the equipment and receiver.
- Connect the equipment into an outlet on a circuit different from that to which the receiver is connected.
- Consult the Panasonic Service Center or an experienced radio/TV technician for help.

WARNING

Flat panel displays are not always supported on the proper stands or installed according to the manufacturer's recommendations. Flat panel displays that are inappropriately situated on dressers, bookcases, shelves, desks, speakers, chests, or carts may fall over and may cause personal injury or even death.

The Consumer Electronics Association (CEA), of which Panasonic is a member, is committed to making home entertainment enjoyable and safe. To prevent personal injury or death, be sure to follow these following safety guidelines:

CEA CHILD SAFETY NOTICE

THE CONSUMER ELECTRONICS INDUSTRY CARES

- Manufacturers, retailers and the rest of the consumer electronics industry are committed to making home entertainment safe and enjoyable.
- As you enjoy your television, please note that all televisions – new and old- must be supported on proper stands or installed according to the manufacturer's recommendations. Televisions that are inappropriately situated on dressers, bookcases, shelves, desks, speakers, chests, carts, etc., may fall over, resulting in injury.

TUNE IN TO SAFETY

- ALWAYS follow the manufacturer's recommendations for the safe installation of your television.
- ALWAYS read and follow all instructions for proper use of your television.
- NEVER allow children to climb on or play on the television or the furniture on which the television is placed.

- NEVER place the television on furniture that can easily be used as steps, such as a chest of drawers.
- ALWAYS install the television where it cannot be pushed, pulled over or knocked down.
- ALWAYS route cords and cables connected to the television so that they cannot be tripped over, pulled or grabbed.

WALL OR CEILING MOUNT YOUR TELEVISION

- ALWAYS contact your retailer about professional installation if you have any doubts about your ability to safely mount your television.
- ALWAYS use a mount that has been recommended by the television manufacturer and has a safety certification by an independent laboratory (such as UL, CSA, ETL).
- ALWAYS follow all instructions supplied by the television and mount manufacturers.
- ALWAYS make sure that the wall or ceiling where you are mounting the television is appropriate. Some mounts are not designed to be mounted to walls and ceilings with steel studs or cinder block construction. If you are unsure, contact a professional installer.
- Televisions can be heavy. A minimum of two people is required for a wall or ceiling mount installation.

MOVING AN OLDER TELEVISION TO A NEW PLACE IN YOUR HOME

- Many new television buyers move their older CRT televisions into a secondary room after the purchase of a flat-panel television. Special care should be made in the placement of older CRT televisions.
- ALWAYS place your older CRT television on furniture that is sturdy and appropriate for its size and weight.
- NEVER place your older CRT television on a dresser where children may be tempted to use the drawers to climb.
- ALWAYS make sure your older CRT television does not hang over the edge of your furniture.

Panasonic recommends that a qualified installer perform the wall-mount installation. See page 8.



The American Academy of Pediatrics discourages media viewing for children younger than two years. For more details, see www.aap.org.

Setting Up the TV

Supplied accessories

Check that all the following items have been included with your TV

Remote Control

• N2QAYB000820



Batteries (2)

• AA Battery

• Installation ➔ (p. 7)



Power cord

• Connection ➔ (p. 9)

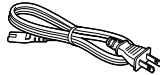

Pedestal

• Assembly screws

A  (M4 × 18) × 4

B  (M4 × 15) × 4

• Bracket

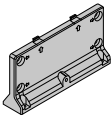

• Base

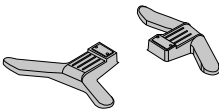

Owner's Manual

Quick start guide

Child safety sheet

Installing the remote's batteries

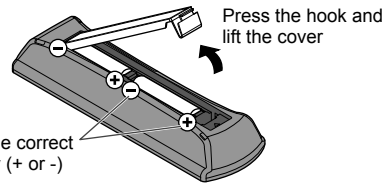

Caution

- Incorrect installation may cause battery leakage and corrosion, resulting in damage to the remote control.
 - Do not mix old and new batteries.
 - Do not mix different battery types (such as alkaline and manganese batteries).
 - Do not use rechargeable (Ni-Cd) batteries.
- Do not burn or break batteries.

Attaching the pedestal to TV

Warning

Do not disassemble or modify the pedestal.

- Otherwise, the TV may fall over and become damaged, and personal injury may result.

Caution

Do not use any pedestal other than that provided with this TV.

- Otherwise, the TV may fall over and become damaged, and personal injury may result.

Do not use the pedestal if it becomes warped or physically damaged.

- If you use the pedestal when it is physically damaged, personal injury may result. Contact your nearest Panasonic Dealer immediately.

During set-up, make sure that all screws are securely tightened.

- If sufficient care is not taken to ensure screws are properly tightened during assembly, the pedestal will not be strong enough to support the TV, and it might fall over and become damaged, and personal injury may result.

When removing the pedestal, do not remove the pedestal by any methods other than the specified procedure. ➔ (p. 8)

- Otherwise, the TV and/or pedestal may fall over and become damaged, and personal injury may result.

1 Assemble the pedestal

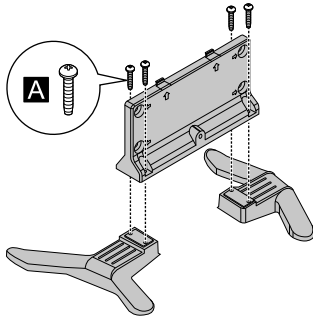

2 Attach the TV to the pedestal

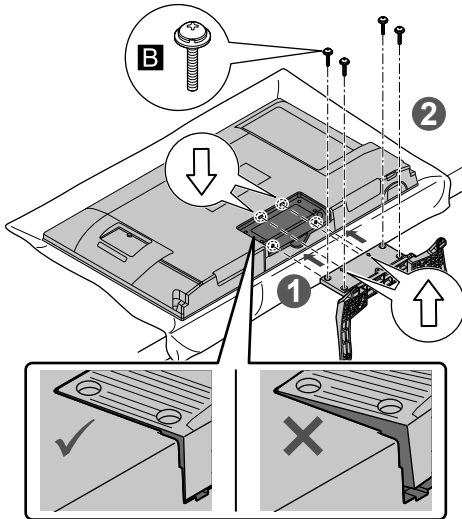

Removing the pedestal from the TV

Be sure to remove the pedestal in the following way when using the wall-hanging bracket or repacking the TV.

- 1 Lay the TV on a foam mat or thick soft cloth on a table.
- 2 Remove the assembly screws **B** from the TV.
- 3 Pull out the pedestal from the TV.
- 4 Remove the assembly screws **A** from the bracket.

Wall mounting the TV (optional)

Please contact a professional installer to purchase the recommended UL qualified wall-hanging bracket. For additional details, please refer to the wall-hanging bracket installation manual.

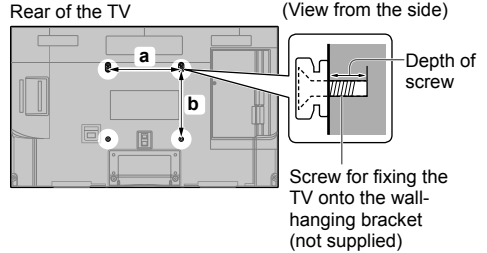

■ Holes for wall-hanging bracket installation

a: 7.9" (200 mm)

b: 7.9" (200 mm)

■ Screw specification

Type: M4

Depth of screw:

Minimum: 0.36" (9 mm)

Maximum: 0.55" (14 mm)

Warning

- Always be sure to ask a qualified technician to carry out set-up.
- Do not mount the unit directly below ceiling lights (such as spotlights, floodlights or halogen lights) that typically give off high heat. Doing so may warp or damage plastic cabinet parts.
- Take care when fixing wall brackets to the wall. Always ensure that there are no electrical cables or pipes in the wall before hanging bracket.
- To prevent fall and injury, remove the TV from its fixed wall position when it is no longer in use.
- Incorrect wall-hanging bracket or incorrect fitting may cause equipment to fall, resulting in injury and product damage.
- Panasonic disclaims liability for any damage or injury arising from incorrect wall-hanging bracket, incorrect fitting or otherwise failure to follow the above instructions.

Connecting the TV

Terminals

Rear of the TV

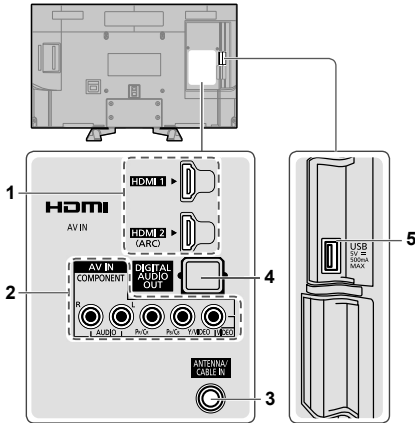

- 1 HDMI 1 - 2
- 2 AV IN
- 3 ANTENNA/CABLE IN
- 4 DIGITAL AUDIO OUT
- 5 USB port

Connections

Antenna or cable and power cord connection

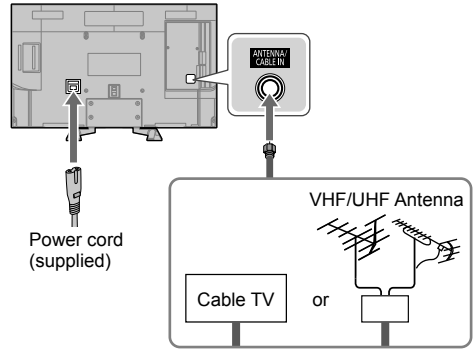

Insert the power cord plug (included) firmly into place.

Important:

- Disconnect the power cord plug from the wall outlet first.
- The included power cord is for use with this unit only.

VHF/UHF Antenna

- NTSC (National Television System Committee): Analog television system
- ATSC (Advanced Television Systems Committee): Digital TV Standards include digital high-definition television (HDTV), standard-definition television (SDTV), data broadcasting, multi-channel surround sound audio and interactive television.

Cable

- You need to subscribe to a cable TV service to enjoy viewing their programming.
- You may need to subscribe to a high-definition (HD) cable service to enjoy HD programming. The connection for high-definition can be done with the use of an HDMI or Component Video cable (p. 10).

Note

- When using a Cable box, external equipment and video cables shown in this manual are not supplied with the TV.
- When disconnecting the power cord, be absolutely sure to disconnect the power cord plug from the wall outlet first.

- If the antenna is placed in the wrong location, interference might happen.

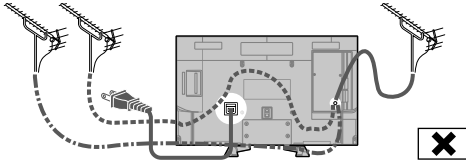
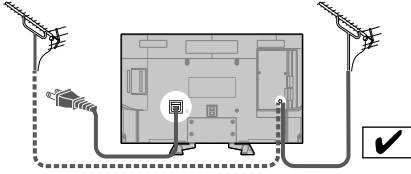

AV / Game equipment

■ Using HDMI terminal

(Set-top-box / DVD recorder / Blu-ray Disc player / Camcorder / etc.)

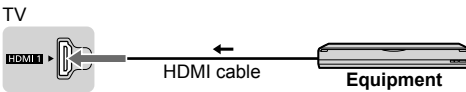

- You can also make similar connection via HDMI 2.
- If you are using HDMI-DVI conversion cable, connect as shown below:

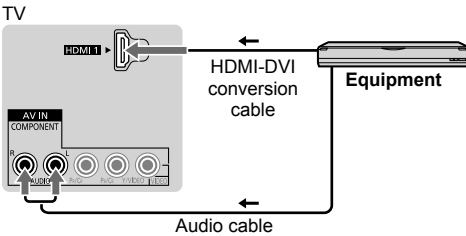

■ Using COMPONENT terminals

(DVD recorder / Blu-ray Disc player / etc.)

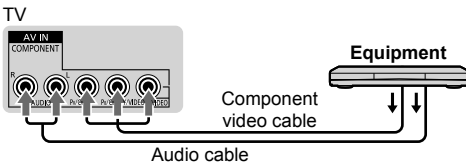

■ Using COMPOSITE terminals

(Camcorder / Game system / DVD recorder / etc.)

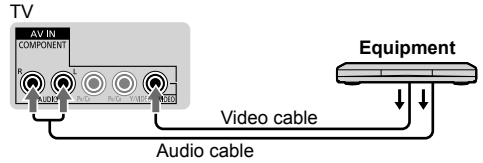

Speaker system

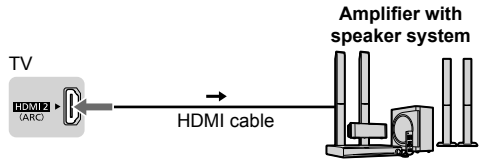

- Use HDMI 2 for connecting an amplifier that has ARC (Audio Return Channel) function. As for an amplifier without ARC function, use DIGITAL AUDIO OUT.
- To enjoy the sound from the external equipment in multi-channel sound (e.g. Dolby Digital 5.1ch), connect the equipment to the amplifier. For the connections, read the manuals of the equipment and amplifier.

First Time Setup

When you first turn on the TV, a series of steps will pop-up to guide you to setup your TV.

- These steps are not necessary if the setup has been completed by your local dealer.

1 Plug the power cord into the socket outlet

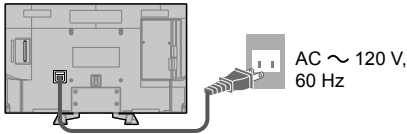

2 Turn the TV on with the POWER button

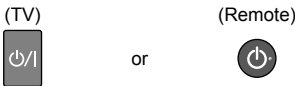

3 Select your language

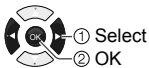
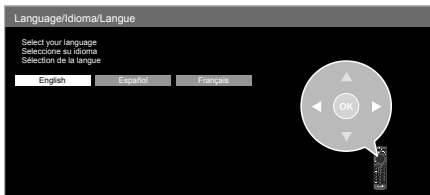

4 Select [Home use]

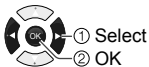

- [Store demonstration] is for shop display.
- To display the [Set viewing mode] screen again as shown above and select [Home use], perform [Reset to defaults] in the [Setup] menu (p. 20). If you perform [Reset to defaults], please do not unplug the AC Cord while the TV is being reset.

5 Select ANTENNA/Cable setup method

Do you use a Cable, Satellite or Fiber Optic box with this TV?

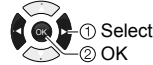
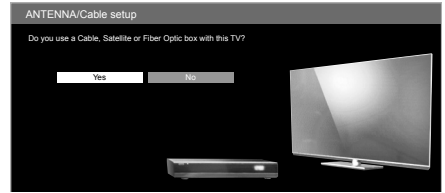

If you select [Yes], select the wiring method used to connect your box to the TV.

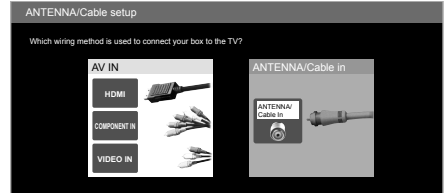

If you select [No], select the signal type.

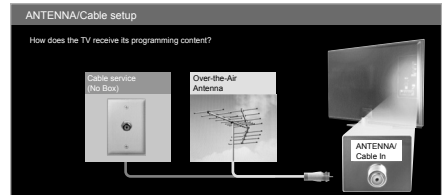

6 Select [Auto program] and start scanning

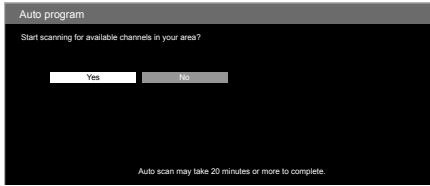

Scanning in progress...

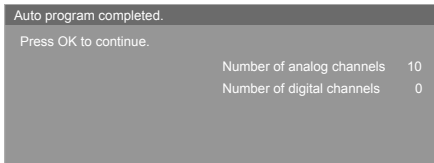
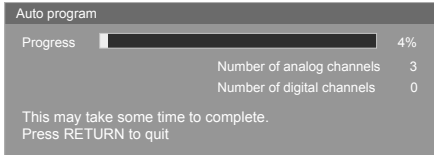

First Time Setup completes when scanning is done.

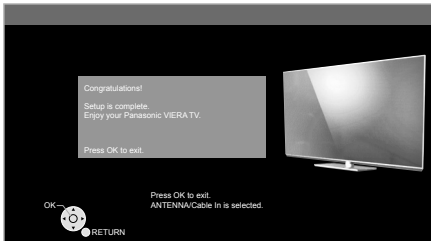

To watch TV via a Cable box, Satellite receiver, or any other source (DVD, DVR, gaming device, etc.), press the **INPUT** button and select the appropriate input (p. 14).

Note

- If you turn off the TV by pulling out the power cord before completing "First Time Setup", "First Time Setup" will launch again when you next turn on the TV. On the other hand, if you turn off the TV with the **POWER** button on the TV or remote control, this procedure will not launch again on your next power on.
- You can repeat "First Time Setup" by selecting [Reset to defaults] in the [Setup] menu (p. 20).
- After "First Time Setup", you can change [Language] from the [Setup] menu (p. 20) or retune the TV using [Auto program] or [Manual program] (p. 21).

Operating the TV

Using the TV controls

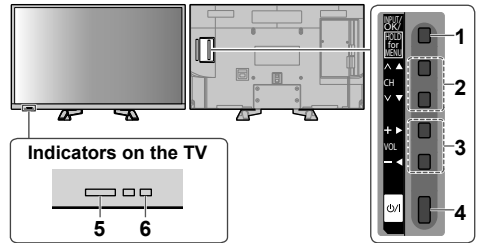

1 Changes the input mode
Chooses Menu and Submenu entries
Press and hold for 3 seconds for MENU function

- Press again and hold for 3 seconds to return to the previous screen from submenus / exit from main menu page.

2 Selects channels in sequence
Makes selections or adjustments when in the menu system

3 Volume Up / Down
Makes selections or adjustments when in the menu system.

4 Power button

- Switches TV On or Off (Standby).
- To completely turn off the TV, remove the power plug from the wall socket.

5 Remote control signal receiver

- Remote control sensor range is about 23 feet (7 meters) in front of the TV set.

6 Power LED

- On: Red
- Off: No light
- The TV consumes a small amount of electric energy even when turned off.

Note

- Do not place any objects between the TV remote control signal receiver and remote control.

Using the remote control

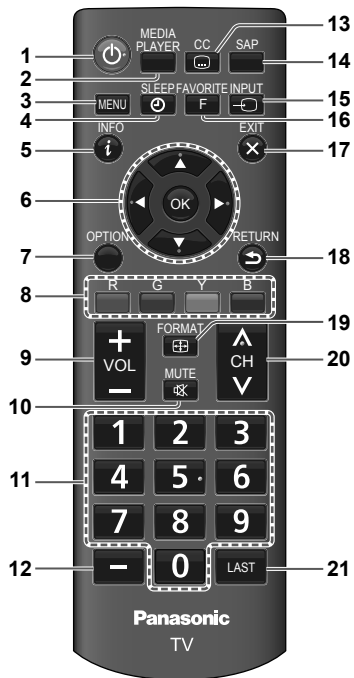

- 1 Switches TV On or Off (Standby)
- 2 MEDIA PLAYER → (p. 15)
- 3 Displays the menu screen → (p. 17)
- 4 Sets the sleep timer
 - [Off / 15 / 30 / 60 / 90 minutes]
 - After the set time elapsed, the TV will turn to standby automatically.
- 5 Displays/hides information and channel banner → (p. 24).
- 6 Select / OK / Change
- 7 Displays [Options menu]

(only available when the TV input is "Antenna/Cable")

 - [Channel surf mode]: Specify favorites or type of channels to view. [All / Favorite / Digital only / Analog only]
 - [Signal meter]: Check the signal strength if interference is found or freezing occurs on a digital image.
- 8 Colored buttons
 - Performs multiple operations which correspond to the operation guide displayed on the menu screen.
- 9 Volume Up / Down
- 10 Sound Mute On / Off
- 11 Numeric keypad to select channel

12 Selects digital channel number

- Example: CH15-1: **1 5 - 1**

13 Selects Closed Caption mode

- Digital TV: [Off / Service 1-6]
- Analog TV: [Off / CC1-4 / TEXT1-4]
- The selected mode is only set for the program you are watching at the moment.
- Closed Caption is not available when watching TV with a Cable or Satellite box connected via HDMI.
- Contact your Cable or Satellite operator for instructions on enabling CC with their box.
- Closed Caption settings are memorized in [Closed caption] of [Setup] menu → (p. 20).

14 Selects the Audio mode for watching TV

- Digital mode: Selects next Audio track (if available) when receiving a digital channel.
- Analog mode: Selects the desired Audio mode [Stereo / SAP / Mono]
- Not available when watching TV with a Cable or Satellite box connected via HDMI.
- To set desired Audio for all channels → "[Audio language]" (p. 19).

15 Input mode selection

- Display [Input select] screen (p. 14) or press repeatedly to select the input mode.

16 Operates the Favorite channel list function → (p. 14)

17 Exits to TV viewing screen

18 Returns to the previous menu / page

19 Changes aspect ratio and zoom

- Press repeatedly to select the mode. [FULL] / [4:3] / [JUST] / [ZOOM] / [H-FILL] → (p. 24)

20 Channel Up / Down

- When viewing from ANTENNA/Cable source

21 Returns to the last viewed channel or input

About operation guide

When operating the TV with the remote control, follow the operation guide available at the bottom of the screen to perform the operation you want.

Example: [Input select]

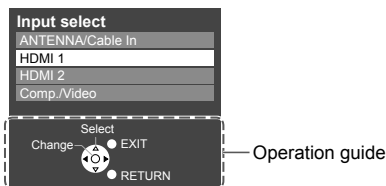

Referring to the operation guide:

- To select the input



- To change to the selected mode



- To return to the previous screen



- To exit the menu



Watching External Inputs

1 Connect the external equipment

➔ (p. 10)

2 Display the [Input select] menu, then select the input of the connected equipment

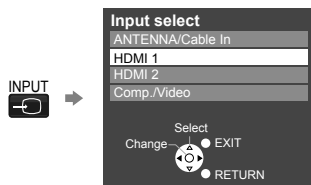

Note

- You can label or skip each input mode
➔ "Input Labels" (p. 22)

Favorite Channels

You can add your favorite channels in the [Favorite list] for easy channel selection.

Creating Favorite list

1 While viewing the channel that you want to set, display [Favorite list]

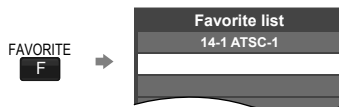

2 Select an empty slot and register the channel



Note

- You can set up to 10 channels as Favorite.
- You cannot save a new channel in a used slot. If you want to change your Favorite channel, first delete the existing channel (➔ below), then save the new channel in the empty slot.

■ To watch a Favorite channel

While [Favorite list] is displayed:



Note

- When watching a Favorite channel, the icon "♥" is displayed on the channel banner (p. 24).

■ To delete a Favorite channel

While [Favorite list] is displayed:

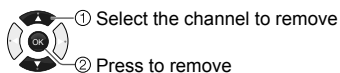

Using Media Player

Media Player allows you to enjoy photo or music recorded on a USB Flash Memory.

- During the operation, audio signal is output from DIGITAL AUDIO OUT and HDMI 2 (ARC function) terminals. To use HDMI 2 with ARC function, connect an amplifier that has ARC function and set to use theater speakers.
- The picture may not appear correctly on this TV depending on the digital cameras used.
- Display may take some time when there are many files and folders in the USB Flash Memory.
- Partly degraded files might be displayed at a reduced resolution.
- The folder and file names may be different depending on the digital camera used.

Inserting / Removing the USB Flash Memory

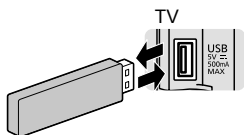

- Insert or remove straight and completely.

Starting Media Player

1 Insert the USB Flash Memory
→ (p. 15)

2 Start Media Player



3 Select the mode



[Photos]: Displays the thumbnail of all photos in the USB Flash Memory.

[Music]: Displays the thumbnail of music folders in the USB Flash Memory.

[Media select]

Switching between modes

When you are in the thumbnail view of any mode, you can change to the other mode by accessing the [Media select] screen.

B

[Info]

Information panel



Displays data information (file name, date, size, etc.)

- Information differs depending on selected data.

[Options menu]

Displays setup menu for each mode.



- Photos : Slideshow settings → (p. 16)

- Music : Music options → (p. 16)

Photo mode



Operation guide

: Error display

Follow the operation guide to perform available operations in Photo mode.

To display / hide the operation guide during [Single view] and [Slideshow]



[Single view]

Enters single view mode to view photo one at a time

[Slideshow]

Views all photos in the slideshow mode

[View select]

Toggles between thumbnail view and folder view

1 Display the view selection in the thumbnail view**2** Select the sort type

[Folders]: Displays the thumbnail grouped by folder.

[Slideshow settings]**OPTION**

● Contains items to set up the slideshow.

■ [Transition effect]

Effect for photo switching during slideshow **[None / Dissolve / Wipe → / Wipe ← / Wipe ↑ / Wipe ↓ / Box in / Box out / Random]**

■ [Photo size]

Photo size for Single view and Slideshow **[Zoom / Normal]**

- Depending on the original photo size, [Zoom] may not work.

■ [Display interval]

Interval for each image to be displayed in the slideshow **[5 / 10 / 15 / 30 / 60 / 90 / 120 seconds]**

■ [Repeat]

Slideshow repeat **[Off / On]**

■ [Background music]

Background music during photo viewing **[Off / Type 1 / Type 2 / Type 3]**

Note

- Picture quality may suffer depending on the slideshow settings.
- Picture setting may not work depending on the slideshow settings.

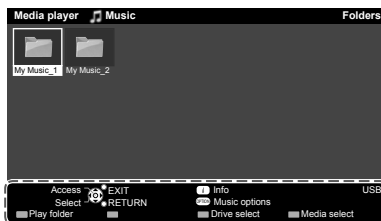
Music mode

Operation guide

Follow the operation guide to perform available operations in Music mode.

To display / hide the operation guide during playback

**[Play folder]**

Plays all music in the selected folder.

- To playback the selected file only

**[Music options]**

Lets you set up the play mode.

■ [Repeat]

[Off]: Repeat off

[One]: Playback repeat on the selected one file

[Folder]: Playback repeat within the selected folder

Other settings

You can adjust some settings for picture and audio using the TV menu functions. For details, refer to the [Picture] and [Sound] menus in **“Using the Menu Functions”** ➔ (p. 17 - 18).

Note

- Some items are grayed out to indicate that these items are not available. Availability depends on the contents you are enjoying.

Using the Menu Functions

1 Display the menu

MENU

Example:

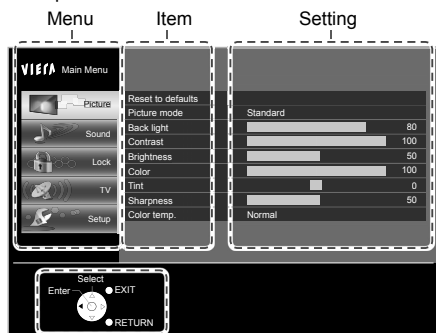

Operation guide

2 Select the menu



3 Select an item, then change the setting

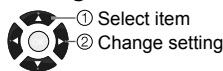

Some items have submenus, press **OK** or **right cursor** to enter the submenu.

Example:

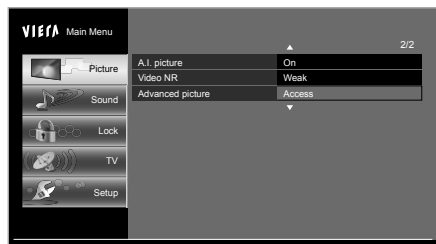

Note

Some menus/items are grayed out depending on the input signal or condition. For example, [3:2 pulldown] in the [Picture] menu will be grayed out if the input signal is not 1080i (HD) or you are viewing photos, etc.

Picture

[Reset to defaults]

Resets all picture adjustments to factory default settings.

- Press **OK** to proceed.

[Picture mode]

Sets the picture mode for each input.

[Vivid]: Provides enhanced picture contrast and sharpness for viewing in a well-lit room.

[Standard]: Recommended for normal viewing conditions with subdued room lighting.

[Cinema]: For watching movies in a darkened room. It provides a soft, film-like picture.

[Game]: For playing video games.

- Progressive input format is recommended to be used when Game Mode is selected.

[Custom (Photo)]: Customizes each item according to your preference. [Photo] is displayed in JPEG menu (full screen).

[Back light]

Adjusts the luminance of the back light.

[Contrast], [Brightness], [Color], [Tint], [Sharpness]

Adjusts these items for each picture mode to suit your preferences.

[Color temp.]

Selects a choice of Cool (blue), Normal, or Warm (red) color. **[Cool / Normal / Warm]**

[A.I. picture]

Controls dark areas without affecting the black level or brightness in the overall picture. **[Off / On]**

[Video NR]

Reduces noise, commonly called snow. Leave it off when receiving a strong signal. **[Off / Weak / Medium / Strong]**

[Advanced picture]

■ [3D Y/C filter]

Minimizes noise and cross-color in the picture. **[Off / On]**

- Available during Analog TV and composite video input only.

■ [Color matrix]

Selects image resolution of component-connected devices. **[SD / HD]**

- SD: Standard-Definition
- HD: High-Definition
- Only used with 480p video signal.

■ [Black level]

Adjusts the black level. Valid only for external input signals. **[Dark / Light]**

■ [MPEG NR]

Reduces picture noise in MPEG-compressed video.

[Off / On]

- For Digital TV only and except for [Game] in [Picture mode].

■ [3:2 pulldown]

Adjusts the picture recorded in 24 fps for optimum quality. [Off / Auto]

■ [Aspect adjustments]

- **[Screen format]:** Changes the format (aspect ratio) depending on the format of received signal (p. 24).
[FULL / 4:3 / JUST / ZOOM / H-FILL]
- **[HD size]:** Selects the scanning area with High-definition signal. [Size 1 / Size 2]
 - [Size 1]: Scanning 95 % (select [Size 1] if noise is generated on the edges of the screen).
 - [Size 2]: Scanning 100 %
 - Available when the input signal is HD.
- **[H size]:** Adjusts the horizontal display range to reduce noise of both side edges of an image.
[Size 1 / Size 2]
 - Available when the input signal is SD.
 - [Size 2]: Adjusts the image size according to the aspect mode to reduce noise (p. 24).
- **[Zoom adjustments]:** Adjusts vertical image position and size. [V-position / V-size]
 - [V-position]: Vertical position adjustment
 - [V-size]: Vertical size adjustment
 - Available when aspect setting is [Zoom].

Note

Some menus/items are grayed out depending on the input signal or condition. For example, [3:2 pulldown] will be grayed out if the input signal is not 1080i (HD) or you are viewing photos, etc.

Sound

[Reset to defaults]

Resets all audio adjustments to factory default settings.

- Press **OK** to proceed.

[Sound mode]

Sets your favorite sound mode.

[Music]*1: Improves sound quality for watching music videos, etc.

[Speech]*1: Improves sound quality for watching news, drama, etc.

[User]*2: Adjusts the sounds manually by using the equalizer.

*1 In [Music] and [Speech] modes, you can adjust the [Bass] and [Treble] settings, and those settings will be stored for each mode.

*2 When you select [User] mode, [Equalizer] is active instead of [Bass] and [Treble].

[Bass] / [Treble]

Adjusts the level of bass/treble effect respectively.

[Equalizer]

Adjusts the frequency level to suit your favorite sound quality

- Available when [Sound mode] is set to [User].
- Select the frequency and change the frequency level by using the cursor buttons.
- To enhance the bass sound, raise the level of the lower frequency. To enhance the treble sound, raise the level of the higher frequency.
- To reset the levels of each frequency to the default settings, select [Reset to Defaults] by using the cursor button, and then press **OK**.

[Balance]

Adjusts the left / right speaker volume.

[Surround]

Enhances audio left / right response when listening to stereo. [Off / On]

[TV speakers]

Lets you switch the TV speaker off/on when using external speakers. [Off / On]

- When you set to [Off], [Surround], [Bass], [Treble] and [Balance] are not available.

[Digital audio out]

Selects the initial setting for digital audio output signal from DIGITAL AUDIO OUT and HDMI 2 (ARC function) terminals.

[Auto]: Dolby Digital is output as Dolby Digital Bitstream. MPEG is output as PCM.

[PCM]: Digital output signal is fixed to PCM.

- When the TV receives NTSC signal, the output is PCM.
- For Digital TV.

[Audio input]

Selects to fit the input signal.

■ [HDMI1-2 in]

[Digital]: When sound is carried via the HDMI cable connection.

[Analog]: When sound is not carried via the HDMI-DVI adaptor cable connection.

Lock

You will be asked to enter your password each time you display the [Lock] menu.

[Password]

Input your 4-digit password.

- Enter "1234" for the first time. This is the default password.
- To change the password ➔ "[Change password]" (p. 19)
- Make a note of your password in case you would forget it. If you have forgotten your password, consult your local dealer.
- When you select a locked channel, a message will be displayed that allows you to view the channel after you input your password.

[Mode]

Selects lock mode.

[Custom]: Locks specified settings of [Channel], [Program] and [Inputs].

[Off]: Unlocks all the Lock settings of [Channel], [Program] and [Inputs].

[All]: Locks all the inputs regardless of the Lock settings of [Channel], [Program] and [Inputs].

[Channel]

Selects channel to lock.

- The selected channels will be blocked regardless of the program rating.

[Program]

Sets rating level.

[Mode]: Sets program lock status. **[Off / On]**

- "V-chip" technology enables restricted shows to lock according to TV ratings.
- [On]: Sets each rating level (U.S.TV Ratings, U.S. Movie Ratings, C.E.L.R., C.F.L.R.)

[U.S. TV ratings]: U.S. TV program ratings.

[U.S. Movie ratings]: U.S. movie ratings.

[Canadian English ratings]: Canadian English ratings.

[Canadian French ratings]: Canadian French ratings.

- For more information about ratings ➔ (p. 22).

[Inputs]

Locks external inputs accordingly. **[HDMI 1-2 / Comp./Video]**

[Change password]

Changes the password.

- Input the new 4-digit password, then input again to confirm.

Note

- This TV is designed to support the "Downloadable U.S. Region Rating System" when available (available only in the U.S.A.).
- The Off rating is independent of other ratings.
- When placing a lock on a specific-age-based-rating level, the Off rating and any other more restrictive ratings will also be blocked.

TV

[ANTENNA/Cable signal]

Selects the input for [Auto program] (p. 21) and [Manual program] (p. 21). **[Antenna / Cable]**

[Auto program] ➔ (p. 21)

[Manual program] ➔ (p. 21)

[MTS]

Selects the Audio mode for watching TV.

[Mono / Stereo / SAP]

[Audio language]

Selects the language for TV programs. **[English / Spanish / French]**

- Set [Audio language] to preferred language for all broadcast channels.
- Language selection using the **SAP** button on the remote control (p. 13) is temporary (channel changes according to [Audio language] setting).

[Preferred audio type]

Narration settings for impaired users.

[Main audio / Hearing impaired / Visually impaired]

- [Hearing impaired]: Activates closed captioning when available on broadcasts.
- [Visually impaired]: Activates the narration soundtrack when available on broadcasts.
- For Digital TV only

Setup

[Language]

Changes language for on-screen displays. **[English / Español / Français]**

[Timer set]

■ [Sleep timer]

Sets the period after which the TV will turn off automatically. **[Off / 15 / 30 / 60 / 90 minutes]**

■ [No signal for 10 minutes]

To conserve energy, the TV automatically turns off when NO SIGNAL and NO OPERATION continue for more than 10 minutes. **[Stay on / Power TV off]**

- The on-screen display will pop-up 3, 2, and 1 (minutes) to indicate the last three (3) remaining minutes prior to the shut-off.

■ [No activity for 3 hours]

To conserve energy, the TV automatically turns off when no operation of remote control and TV buttons continue for more than 3 hours.

[Stay on / Power TV off]

- The on-screen display will pop-up 3, 2, and 1 (minutes) to indicate the last three (3) remaining minutes prior to the shut-off.

[Closed caption]

This TV includes a built-in decoder that is capable of providing a text display of the audio. The program being viewed must be transmitting Closed Caption (CC) information ➔ (p. 26).

The settings in "Analog" or "Digital" depend on the broadcaster.

■ [Analog closed caption]

Selects the Closed Caption service of Analog broadcasting. **[Off / CC1-4 / TEXT1-4]**

- [CC1-4]: Information related to pictures (appears at the bottom of the screen).
- [TEXT1-4]: Textual information (appears over the entire screen).

■ [Digital closed caption]

Lets you configure the way you choose to view the digital captioning. **[Off / Service 1-6]**

■ [Digital setting]

Sets display settings in digital program.

[Caption style: Auto]: The default settings are displayed.

[Caption style: Custom]: You can personalize below items to your preference:

- Font size
- Font style
- Font color
- Font opacity
- Background color
- Background opacity
- Outline color
- Outline opacity

[Input labels] ➔ (p. 22)

[HDMI control]

■ [CEC function]

Sets how the TV responds when you operate an HDMI connected equipment. **[Off / On]**

- [On]: The TV will automatically switch to the appropriate HDMI input whenever an HDMI connected equipment is initially turned on and the Play mode is selected.

■ [Power off link]

Sets how an HDMI connected equipment responds when you turn off the TV. **[No / Yes]**

- [Yes]: When the TV is turned off, all HDMI connected equipment is also automatically turned off.
 - A Panasonic DVD Recorder will not turn off if it is still in Rec mode.
 - The TV remains on even if the HDMI connected equipment is turned off.

[About]

Displays TV version and software license.

[Reset to defaults]

Performing reset will clear all settings made in the [Setup] menu, such as channel settings.

After reset, "First Time Setup" will launch when you next power on the TV (p. 11).

Auto Program

This function lets you retune and add all available channels to the channel list automatically.

Before performing this function, be sure to set [ANTENNA/Cable signal] to the input you want to tune.

Note

- This function is only available in TV mode.
- How to navigate the menu → (p. 17)

1 Display the menu

MENU

2 Select [TV], then select [Auto program]

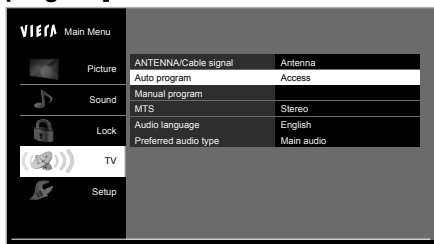

Scanning starts.



- The TV automatically searches and adds available channels to the memory.
- After the scan is completed, all previously saved channels will be erased.

To cancel scanning process

RETURN



Manual Program

This function lets you add or remove channels from the channel list.

Before performing this function, be sure to set [ANTENNA/Cable signal] to the input you want to edit.

Note

- This function is only available in TV mode.
- How to navigate the menu → (p. 17)

1 Display the menu

MENU

2 Select [TV], then select [Manual program]

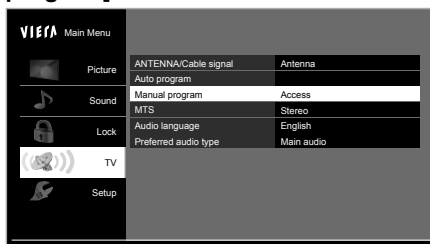

3 Select the channel you want to set/remove from the channel list

2	Analog	<input checked="" type="checkbox"/>
3	Analog	<input checked="" type="checkbox"/>
4	Analog	<input checked="" type="checkbox"/>
5	Analog	<input checked="" type="checkbox"/>
6	Analog	<input checked="" type="checkbox"/>
7	Analog	<input checked="" type="checkbox"/>
8	Analog	<input checked="" type="checkbox"/>
9	Analog	<input checked="" type="checkbox"/>
10	Analog	<input checked="" type="checkbox"/>

: channel will be removed from the channel list
(You cannot select the channel using **CH up/down** button.)

: channel will remain on the channel list

To change channel list pages

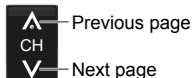

Input Labels

You can label the terminal with the type of equipment connected to it. This makes selecting the correct input easier (Input select ➔ p. 14).

You can also skip any unused terminal with this feature.

Note

- How to navigate the menu ➔ (p. 17)

1 Display the menu

MENU

2 Select [Setup], then select [Input labels]

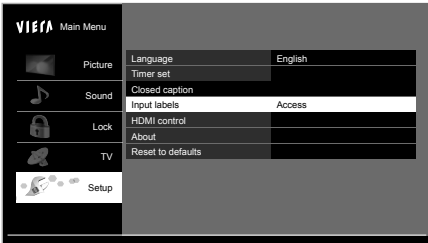

3 Select an input terminal and set

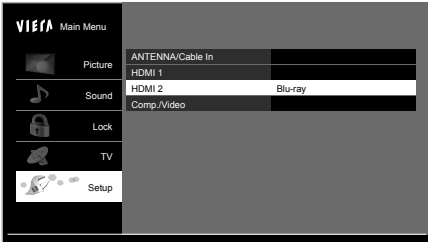

- The labels you set will be displayed in the [Input select] screen (p. 14).
- If [Not used] is selected, you cannot select the input.

Ratings List for Parental Control

“V-chip” technology enables you to lock channels or shows according to standard ratings set by the entertainment industry.

U.S. TV programs ratings [U.S. TV ratings]

NR (Not Rated)

■ TV-NR

Not Rated.

Possible content selections:

- Viewable
- Blocked

Youth

■ TV-Y

All children. The themes and elements in this program are specifically designed for a very young audience, including children from ages 2-6.

Possible content selections:

- Viewable
- Blocked

■ TV-Y7

Directed to older children. Themes and elements in this program may include mild physical or comedic violence, or may frighten children under the age of 7.

Possible content selections:

- FV blocked
- Viewable
- Blocked

Guidance

■ TV-G

General audience. It contains little or no violence, no strong language, and little or no sexual dialogue or situations.

Possible content selections:

- Viewable
- Blocked

■ TV-PG

Parental guidance suggested. The program may contain infrequent coarse language, limited violence, some suggestive sexual dialogue and situations.

Possible content selections:

- D, L, S, V (all selected)
- Any combination of D, L, S, V

■ TV-14

Parents strongly cautioned. This program may contain sophisticated themes, sexual content, strong language and more intense violence.

Possible content selections:

- D, L, S, V (all selected)
- Any combination of D, L, S, V

■ TV-MA

Mature audiences only. This program may contain mature themes, profane language, graphic violence, and explicit sexual content.

Possible content selections:

- L, S, V (all selected)
- Any combination of L, S, V

FV: Fantasy/Cartoon Violence

V: Violence

S: Sex

L: Offensive Language

D: Dialogue with sexual content

[U.S. Movie ratings]

■ NR

NO RATING (NOT RATED) AND NA (NOT APPLICABLE) PROGRAMS. Movie which has not been rated or where rating does not apply.

■ G

GENERAL AUDIENCES. All ages admitted.

■ PG

PARENTAL GUIDANCE SUGGESTED. Some material may not be suitable for children.

■ PG-13

PARENTS STRONGLY CAUTIONED. Some material may be inappropriate for children under 13.

■ R

RESTRICTED. Under 17 requires accompanying parent or adult guardian.

■ NC-17

NO ONE 17 AND UNDER ADMITTED.

■ X

ADULTS ONLY.

CANADIAN ENGLISH RATINGS [C. E. L. R.]

■ E

Exempt - Exempt programming includes: news, sports, documentaries and other information programming, talk shows, music videos, and variety programming.

■ C

Programming intended for children under age 8. No offensive language, nudity or sexual content.

■ C8+

Programming generally considered acceptable for children 8 years and over. No profanity, nudity or sexual content.

■ G

General programming, suitable for all audiences.

■ PG

Parental Guidance suggested. Some material may not be suitable for children.

■ 14+

Programming contains themes or content which may not be suitable for viewers under the age of 14. Parents are strongly cautioned to exercise discretion in permitting viewing by pre-teens and early teens.

■ 18+

18+ years old. Programming restricted to adults. Contains constant violence or scenes of extreme violence.

CANADIAN FRENCH RATINGS [C. F. L. R.]

■ E

Exempt - Exempt programming.

■ G

General - Programming intended for audience of all ages. Contains no violence, or the violence content is minimal or is depicted appropriately.

■ 8 ans+

8+ General - Not recommended for young children. Programming intended for a broad audience but contains light or occasional violence. Adult supervision recommended.

■ 13 ans+

Programming may not be suitable for children under the age of 13 - Contains either a few violent scenes or one or more sufficiently violent scenes to affect them. Adult supervision strongly suggested.

■ 16 ans+

Programming may not be suitable for children under the age of 16 - Contains frequent scenes of violence or intense violence.

■ 18 ans+

Programming restricted to adults. Contains constant violence or scenes of extreme violence.

Caution

- The V-Chip system that is used in this set is capable of blocking "NR" programs (non rated, not applicable and none) as per FCC Rules Section 15.120(e)(2). If the option of blocking "NR" programs is chosen "unexpected and possibly confusing results may occur, and you may not receive emergency bulletins or any of the following types of programming:"
 - Locally originated programming
 - News
 - Political
 - Public Service Announcements
 - Religious
 - Sports
 - Weather

Additional Information

Channel banner

Channel banner is available when watching programs via the Antenna/Cable input.

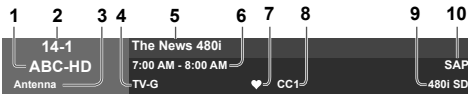

- 1 Station identifier
- 2 Channel
- 3 Input signal
- 4 Rating level
- 5 Program
- 6 Program duration
- 7 Favorite channel
- 8 Closed caption
- 9 Signal resolution
- 10 Audio mode available

Format (aspect ratio)

■ [FULL]

Displays a 4:3 image enlarged horizontally to fit the screen.

- Recommended for anamorphic picture.

■ [4:3]

Displays the image at the standard 4:3 without distortion.

- Note that "Image retention" of the side bar may occur from displaying it for a long time.

■ [JUST]

Stretches to justify the 4:3 image to the four corners of the screen.

- Recommended for normal TV broadcast.

■ [ZOOM]

Enlarges the 4:3 image to the entire screen.

- Recommended for Letter Box.

■ [H-FILL]

Enlarges the 4:3 image horizontally to the side edges of the screen. The side edges of the image are cut off.

Note

- Options available for:
 - 480i, 480p: [FULL / 4:3 / JUST / ZOOM]
 - 1080p, 1080i, 720p: [FULL / 4:3 / JUST / ZOOM / H-FILL]
- Some contents, such as film-based movies, are available in extra-wide format. Top and bottom bars are unavoidable.

[H size]

- For aspect ratio 4:3:

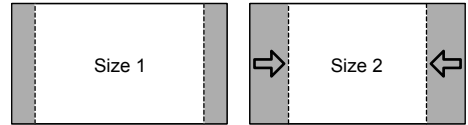

- [Size 2]: The width will be decreased on both sides to reduce noise.

- For aspect ratio FULL/JUST (H-FILL/ZOOM):

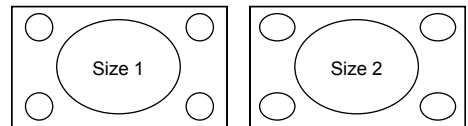

- [Size 2]: The width will be increased on both sides to reduce noise.

Input signal that can be displayed

Signal name	COMPONENT	HDMI
525 (480) / 60i, 60p	○	○
750 (720) / 60p	○	○
1,125 (1,080) / 60i	○	○
1,125 (1,080) / 60p, 24p		○

○ : Applicable input signal

- Signals other than above may not be displayed properly.
- The above signals are reformatted for optimal viewing on your display.

Supported file format in Media Player

Media	Compatible format
Photo	<ul style="list-style-type: none">• JPEG files (DCF and EXIF standards) <p>Sub-sampling: 4:4:4, 4:2:2 and 4:2:0</p> <p>Image resolution:</p> <ul style="list-style-type: none">• Baseline JPEG: 15,360 (W) × 8,640 (H)• Progressive JPEG: 1,920 (W) × 1,440 (H)
Music	<ul style="list-style-type: none">• MP3 files (MPEG Audio Layer-3)

Note

- Even if these conditions are fulfilled, some files may not play depending on how they are encoded.
- The folder and file names may be different depending on the digital camera used.
- Connected devices may become unusable with this TV if the file or folder names are changed.
- Do not use two-byte characters or other special codes for data.

USB Connections

■ USB Flash Memory

Format: FAT16, FAT32

Compliance:

Supports only USB1.1 or USB2.0 standard.

Maximum USB capacity supported is 16GB.

USB Hub or card adapter is not supported.

Note

- Data modified with a PC may not be displayed.
- Do not remove the device while the TV is accessing data. Otherwise this can damage the device or TV.
- Do not touch the pins on the device.
- Insert the device in the correct direction. Otherwise this can damage the device or TV.
- Electrical interference, static electricity, or erroneous operation may damage the data or device. Panasonic is not liable for any deterioration or damage of data or device during operations with the TV.
- It is recommended to connect the USB Flash Memory directly to the TV's USB port.
- Some USB devices or USB HUB may not be used with this TV.
- You cannot connect any devices by using USB card reader.
- Additional information for USB devices may be on the following website. (English only)

<http://panasonic.jp/support/global/cs/tv/>

HDMI connection

This TV incorporates HDMI™ technology. HDMI (high-definition multimedia interface) is the world's first complete digital consumer AV interface complying with a non-compression standard.

HDMI allows you to enjoy high-definition digital images and high-quality sound by connecting the TV and the equipment.

■ Applicable HDMI features

- Input audio signal:
2ch Linear PCM (sampling frequencies - 48 kHz, 44.1 kHz, 32 kHz)
- Input video signal:
➔ **"Input signal that can be displayed"** (p. 24)
Match the output setting of the digital equipment.
- Audio Return Channel* (HDMI 2 terminal only)

■ DVI connection

If the external equipment has only a DVI output, connect to the HDMI terminal via a DVI to HDMI adaptor cable. When the DVI to HDMI adaptor cable is used, connect the audio cable to the audio input terminal (use AV audio terminals).

Note

- Audio settings can be made on [HDMI1-2 in] in the [Sound] menu.
- All signals are reformatted before being displayed on the screen.
- If the connected device has an aspect adjustment function, set the aspect ratio to "16:9".
- These HDMI connectors are "type A".
- These HDMI connectors are compatible with HDCP (High-Bandwidth Digital Content Protection) copyright protection.
- Equipment having no digital output terminal may be connected to the input terminal of COMPONENT or VIDEO to receive analogue signals.

* Audio Return Channel (ARC) is a function to send digital sound signals via an HDMI cable.

DIGITAL AUDIO OUT terminal

You can enjoy your Home theater by connecting a Dolby Digital (5.1 channel) decoder and "Multi Channel" amplifier to the DIGITAL AUDIO OUT terminals.

Caution

- Depending on your DVD player and DVD-Audio software, the copyright protection function may operate and disable optical output.

Closed Caption (CC)

- For viewing the CC of digital broadcasting, set the aspect to [FULL]. (If viewing with [H-FILL], [JUST], [ZOOM] or [4:3]; characters might be cut off).
- The CC can be displayed on the TV only when the receiver (such as a Cable box or satellite receiver) has the CC set to "On" within the device itself. Check with your Cable or Satellite provider for instructions.
- If the CC is set to "On" on both the receiver and TV when the signal is 480i (except for the HDMI connection), the CC may overlap on the TV.
- If a digital program is being output in analog format, the CC data will also be output in analog format.
- If the recorder or output monitor is connected to the TV, the CC needs to be set up on the recorder or output monitor.

Maintenance

First, unplug the power cord plug from the wall outlet.

Power cord plug

Wipe the plug with a dry cloth at regular intervals. (Moisture and dust can lead to fire or electrical shock.)

Display panel

The front of the display panel has been specially treated. Wipe the panel surface gently, using only a cleaning cloth or a soft, lint-free cloth.

- If the surface is particularly dirty, soak a soft, lint-free cloth in diluted, mild liquid dish soap (1 part mild liquid dish soap diluted by 100 times the amount of water) and then wring the cloth to remove excess liquid. Use this cloth to wipe the surface of the display panel, then wipe it evenly with a dry cloth of the same type until the surface is dry.
- Do not scratch or hit the surface of the panel with fingernails or other hard objects. Furthermore, avoid contact with volatile substances such as insect sprays, solvents, and thinner; otherwise, the quality of the surface may be adversely affected.

Cabinet

If the cabinet becomes dirty, wipe it with a soft, dry cloth.

- If the cabinet is particularly dirty, soak the cloth in diluted, mild liquid dish soap and then wring the cloth dry. Use this cloth to wipe the cabinet and then wipe it dry with a dry cloth.
- Do not allow any mild liquid dish soap to come into direct contact with the surface of the TV. If water droplets get inside the unit, operating problems may result.
- Avoid contact with volatile substances such as insect sprays, solvents, and thinner; otherwise, the quality of the cabinet surface may be adversely affected or the coating may peel off.
- Do not let articles made from rubber or PVC be in contact with the TV for long periods of time.

Pedestal

- Wipe the surfaces with a soft, dry cloth. If the unit is particularly dirty, clean it using a cloth soaked with water to which a small amount of mild liquid dish soap has been added and then wipe with a dry cloth. Do not use products such as solvents, thinner, or household wax for cleaning, as they can damage the surface coating. (If using a chemically-treated cloth, follow the instructions supplied with the cloth.)
- Do not attach sticky tape or labels, as they can make the surface of the pedestal dirty. Do not allow long-term contact with rubber, vinyl products, or the like. (Doing so will cause deterioration.)

Troubleshooting

Before requesting service or assistance, please follow these simple guides to resolve the problem.

If an error message appears, follow the message's instructions.

If the problem still persists, please contact your local Panasonic dealer for assistance.

Picture

Why is there no picture or just a blue, black or snowy screen being displayed?

- Check if the power cord is plugged in and the TV is turned on (front red LED light should be on; not blinking).
- Press the **INPUT** button on the remote control to select the correct input source.
- Ensure all connections are correct and secure.
- When using external video source, such as a Cable/Satellite box or DVD player, check that the device is on and functioning correctly.
- Press **MENU** on the remote control. If the menu is displayed, then the TV is working; recheck above steps.

Why doesn't the picture look like it is in High-Definition?

- Press **INFO** on the remote control to confirm the type of signal being received. HD signal should be 720p, 1080i or 1080p.
- Select a High-Definition channel from your HD source (Cable, Satellite or fiber optic service). HD channels sometimes broadcast non-HD content.
- Ensure that your HD source (HD box, Blu-ray player, etc.) is connected to the TV with an HDMI or COMPONENT cable and set to output an HD video signal.

Why do black bars appear on the top and bottom and/or sides of the screen?

- Change the format (aspect ratio) of the picture by pressing **FORMAT** on the remote control (p. 13).
- Check the aspect settings on your external video source, such as Cable/Satellite box, DVD/Blu-ray Disc player, etc.
Note: Some content, such as film-based movies, are available in extra-wide format. Top and bottom bars are unavoidable.

Why is the picture snowy when [ANTENNA/Cable In] is selected?

- When using a cable service (without a box), check that all connections are secure.
- When using a cable or satellite box, change the connection to COMPOSITE, COMPONENT or HDMI (p. 10).
- If you're using an antenna, then check that connections are secure. Change the position or direction of the antenna and check the [Signal meter] (p. 13).

Why is the picture chaotic and/or torn and/or with a buzz in the speakers?

- Check if electrical products such as kitchen appliances, fluorescent lights or light dimmers are nearby. They may interfere with the TV's picture.
- Try viewing a picture from another device, such as a DVD player or a game console, to narrow down the source of the problem.

Why is the screen blank and the power indicator blinking?

- The TV has gone into shutdown mode to protect itself. Try unplugging it for a few minutes and connecting it again. If there was a temporary power surge on the AC line it may now be OK. If the blinking returns, please contact your local Panasonic dealer or Panasonic Service Center for assistance (p. 30).

Why do some small spots on the screen remain bright or dark?

- The TV panel is made up of a few million pixels and is produced with advanced technology through an intricate process. Sometimes a few pixels may be bright or dark. These pixels do not indicate a defective panel and will have no impact on the performance of the TV.

Sound

Why is there no sound coming from the TV?

- Make sure the volume is up and MUTE is off.
- Check that the correct SAP (Secondary Audio Program) is selected by pressing **SAP** on the remote control (p. 13).
- If the TV is connected to a Home Theater via optical cable, then: Check the connection, the audio system is on, the correct input is selected.
- Check [HDMI1-2 in] analog/digital audio settings (p. 18).

Why is the sound unusual, distorted, low volume or in another language?

- Check that the correct SAP (Secondary Audio Program) is selected by pressing **SAP** on the remote control (p. 13).
- Check that all connections of external equipment connected to the TV are secure.
- When using Cable or Satellite box, check the device's audio settings (example: try changing the box's Audio Range to "narrow").

Why is there a clicking, ticking or buzzing sound coming from the TV unit?

- When TV power is turned on or shut off there are electrical components that make a click sound. This is normal.
- Changes in the temperature and humidity of the room may cause thermal expansion and contraction that can produce sounds. This is not a sign of faulty operation or a malfunction.

Why does the CC button not display Closed Caption?

- When viewing TV via an HDMI connected device, such as a Cable or Satellite box, CC must be enabled at the device.
- Closed Caption is available only at supported TV programming.

Why do parts of the TV become hot?

- The main unit radiates heat and some of the parts may become hot. Even if the temperature of parts of the front, top and rear panels has risen, these temperature rises do not cause any problems in terms of performance or quality.
- Ensure good ventilation.
- Do not block the ventilation holes of the TV and do not place the TV on top of other equipment.

Why doesn't the Remote Control work?

- Check that the batteries are fresh, are of the same type and are installed with the correct polarity (+ and -).
- To operate other devices, such as changing channels when using Cable or Satellite boxes or operating non-Panasonic Blu-ray players, use the remote control of the devices.

Specifications

Power Source

AC 120 V, 60 Hz

Power Consumption (Rated power / Standby power)

53 W / 0.20 W

Display Panel

Panel System

Panel with LED backlight

Screen size

32" class (31.5 inches measured diagonally)

W × H × Diagonal

15.7" × 15.4" × 31.5"
(397.68 mm × 392.26 mm × 800.4 mm)

Number of pixels

1,366 × 768

Speaker Output

20 W [10 W + 10 W] (10 % THD)

Channel Capability (Digital/Analog)

VHF/ UHF: 2 - 69, CATV: 1 - 135

Operating Conditions

Temperature: 32 °F - 95 °F (0 °C - 35 °C)

Humidity: 20 % - 80 % RH (non-condensing)

Connection Terminals

VIDEO IN

RCA PIN (VIDEO, AUDIO-L, AUDIO-R)

COMPONENT IN

RCA PIN (Y, P_B, P_R, AUDIO-L, AUDIO-R)

HDMI IN 1/2

TYPE A Connector

USB

USB2.0 Type A connector
DC 5V, Max. 500mA

DIGITAL AUDIO OUT

PCM / Dolby Digital, Fiber Optic

Dimensions

Including pedestal (W × H × D)

28.9" × 19" × 7.8"
(734 mm × 481 mm × 198 mm)

TV set only (W × H × D)

28.9" × 17.2" × 2.8"
(734 mm × 437 mm × 69 mm)

Mass

Including pedestal

13.3 lb. (6 kg) NET

TV set only

12.2 lb. (5.5 kg) NET

Note

- Design and Specifications are subject to change without notice. Mass and Dimensions shown are approximate.

Limited Warranty (for Canada)

Panasonic Canada Inc.
5770 Ambler Drive, Mississauga, Ontario L4W 2T3

PANASONIC PRODUCT – LIMITED WARRANTY

Panasonic Canada Inc. warrants this product to be free from defects in material and workmanship under normal use and for a period as stated below from the date of original purchase agrees to, at its option either (a) repair your product with new or refurbished parts, (b) replace it with a new or a refurbished equivalent value product, or (c) refund your purchase price. The decision to repair, replace or refund will be made by Panasonic Canada Inc.

TV (50" & over)	In-home service	One (1) year, parts (including panel) and labour.
TV (under 50")	Carry-in service	One (1) year, parts (including panel) and labour.

In-home Service will be carried out only to locations accessible by roads and within 50 km of an authorized Panasonic service facility.

In-home service requires clear, complete and easy access to the product by the Authorized Servicer and does not include removal or re-installation of an installed product. If removal is required to service the product, it will be at the discretion of the Servicer and in no event will Panasonic Canada Inc. or the Servicer be liable for any special, indirect or consequential damages.

This warranty is given only to the original purchaser, or the person for whom it was purchased as a gift, of a Panasonic brand product mentioned above sold by an authorized Panasonic dealer in Canada and purchased and used in Canada, which product was not sold "as is", and which product was delivered to you in new condition in the original packaging.

IN ORDER TO BE ELIGIBLE TO RECEIVE WARRANTY SERVICE HEREUNDER, A PURCHASE RECEIPT OR OTHER PROOF OF DATE OF ORIGINAL PURCHASE, SHOWING AMOUNT PAID AND PLACE OF PURCHASE IS REQUIRED

LIMITATIONS AND EXCLUSIONS

This warranty ONLY COVERS failures due to defects in materials or workmanship, and DOES NOT COVER normal wear and tear or cosmetic damage. The warranty ALSO DOES NOT COVER damages which occurred in shipment, or failures which are caused by products not supplied by Panasonic Canada Inc., or failures which result from accidents, misuse, abuse, neglect, mishandling, misapplication, alteration, faulty installation, set-up adjustments, misadjustment of consumer controls, improper maintenance, power line surge, lightning damage, modification, introduction of sand, humidity or liquids, commercial use such as hotel, office, restaurant, or other business or rental use of the product, or service by anyone other than a Authorized Servicer, or damage that is attributable to acts of God. Dry cell batteries are also excluded from coverage under this warranty.

THIS EXPRESS, LIMITED WARRANTY IS IN LIEU OF ALL OTHER WARRANTIES, EXPRESS OR IMPLIED, INCLUDING ANY IMPLIED WARRANTIES OF MERCHANTABILITY AND FITNESS FOR A PARTICULAR PURPOSE. IN NO EVENT WILL PANASONIC CANADA INC. BE LIABLE FOR ANY SPECIAL, INDIRECT OR CONSEQUENTIAL DAMAGES RESULTING FROM THE USE OF THIS PRODUCT OR ARISING OUT OF ANY BREACH OF ANY EXPRESS OR IMPLIED WARRANTY.

(As examples, this warranty excludes damages for lost time, travel to and from the Authorized Servicer, loss of or damage to media or images, data or other memory or recorded content. This list of items is not exhaustive, but for illustration only.)

In certain instances, some jurisdictions do not allow the exclusion or limitation of incidental or consequential damages, or the exclusion of implied warranties, so the above limitations and exclusions may not be applicable. This warranty gives you specific legal rights and you may have other rights which vary depending on your province or territory.

WARRANTY SERVICE

For product operation, repairs and information assistance, please visit our Support page on:

www.panasonic.ca/english/support

IF YOU SHIP THE PRODUCT TO A SERVICENTRE

Carefully pack and send prepaid, adequately insured and preferably in the original carton.
Include details of the defect claimed, and proof of date of original purchase.

Note

Customer's Record

The model number and serial number of this product may be found on its rear panel. You should note this serial number in the space provided below and retain this book, plus your purchase receipt, as a permanent record of your purchase to aid in identification in the event of theft or loss, and for Warranty Service purposes.

Model Number _____**Serial Number** _____**Consignation du numéro de série**

Les numéros de modèle et de série de ce produit se trouvent sur sa face arrière. Notez ce numéro de série dans l'espace réservé à cet effet ci-dessous et conservez ce manuel et votre facture comme preuve de votre achat, pour aider à identifier l'appareil en cas de perte ou de vol et pour recours à la garantie.

Modèle _____**Numéro de série** _____

Panasonic Corporation of North America
Two Riverfront Plaza, Newark,
NJ 07102-5490 U.S.A.

Panasonic Canada Inc.
5770 Ambler Drive
Mississauga, Ontario
L4W 2T3 CANADA