

Technics[®]

Owner's Manual

Network Audio Player

ST-C700

Music is borderless and timeless,
touching people's hearts across cultures and generations.
Each day the discovery of a truly emotive experience
from an unencountered sound awaits.
Let us take you on your journey to rediscover music.

Rediscover Music™

Technics

Thank you for purchasing this product.
Please read these instructions carefully before using this product, and save this manual for future use.

If you have any questions, visit:

U.S.A.: www.panasonic.com/support

Canada: www.panasonic.ca/english/support

Register online at www.panasonic.com/register (U.S. customers only)

■ Features of this unit

This unit offers the following features:

Digital Noise Isolation Architecture

Since most digital content storage media are intended for use with PCs, they are not designed with consideration for low noise, which is critical to pure audio reproduction. To overcome this challenge, this unit employs a thorough measure against jitter and outstanding noise blocking technology for each of its interfaces, delivering clear sound.

Virtual Battery Operation

Virtual Battery Operation prevents power supply noise, a factor that causes “turbidity” in sound, from mixing into the audio signal. The result is an improvement in sound localization performance and spatial expression.

Ultra Low Distortion Oversampling Digital Filter

High-precision oversampling eliminates distortion and enhances the sound quality of music sources, thus reproducing sound rich with spatial expression.

■ Recommended devices

We recommend using Technics devices (optional) for superior audio quality.

Product name	Model number
Speaker System	SB-C700
Compact Disc Player	SL-C700*
Stereo Integrated Amplifier	SU-C700

* This product is set to be released in July 2015.

IMPORTANT SAFETY INSTRUCTIONS

Read these operating instructions carefully before using the unit. Follow the safety instructions on the unit and the applicable safety instructions listed below. Keep these operating instructions handy for future reference.

- 1 Read these instructions.
- 2 Keep these instructions.
- 3 Heed all warnings.
- 4 Follow all instructions.
- 5 Do not use this apparatus near water.
- 6 Clean only with dry cloth.
- 7 Do not block any ventilation openings. Install in accordance with the manufacturer's instructions.
- 8 Do not install near any heat sources such as radiators, heat registers, stoves, or other apparatus (including amplifiers) that produce heat.
- 9 Do not defeat the safety purpose of the polarized or grounding-type plug. A polarized plug has two blades with one wider than the other. A grounding-type plug has two blades and a third grounding prong. The wide blade or the third prong are provided for your safety. If the provided plug does not fit into your outlet, consult an electrician for replacement of the obsolete outlet.
- 10 Protect the power cord from being walked on or pinched particularly at plugs, convenience receptacles, and the point where they exit from the apparatus.
- 11 Only use attachments/accessories specified by the manufacturer.
- 12 Use only with the cart, stand, tripod, bracket, or table specified by the manufacturer, or sold with the apparatus. When a cart is used, use caution when moving the cart/apparatus combination to avoid injury from tip-over.
- 13 Unplug this apparatus during lightning storms or when unused for long periods of time.
- 14 Refer all servicing to qualified service personnel. Servicing is required when the apparatus has been damaged in any way, such as power-supply cord or plug is damaged, liquid has been spilled or objects have fallen into the apparatus, the apparatus has been exposed to rain or moisture, does not operate normally, or has been dropped.



	CAUTION RISK OF ELECTRIC SHOCK DO NOT OPEN	
<p>CAUTION : TO REDUCE THE RISK OF ELECTRIC SHOCK, DO NOT REMOVE SCREWS. NO USER-SERVICEABLE PARTS INSIDE. REFER SERVICING TO QUALIFIED SERVICE PERSONNEL.</p>		



The lightning flash with arrowhead symbol, within an equilateral triangle, is intended to alert the user to the presence of uninsulated "dangerous voltage" within the product's enclosure that may be of sufficient magnitude to constitute a risk of electric shock to persons.



The exclamation point within an equilateral triangle is intended to alert the user to the presence of important operating and maintenance (servicing) instructions in the literature accompanying the appliance.

Conforms to UL STD 60065.
Certified to CAN/CSA STD C22.2 No.60065.

Product Identification Marking is located on the rear panel of the unit.

THE FOLLOWING APPLIES IN THE U.S.A. AND CANADA

This device complies with Part 15 of FCC Rules and RSS-Gen of IC Rules. Operation is subject to the following two conditions:

- (1) This device may not cause interference, and
- (2) this device must accept any interference, including interference that may cause undesired operation of this device.

FCC ID: ACJ-ST-C700
IC: 216A-STC700

This transmitter must not be co-located or operated in conjunction with any other antenna or transmitter.

This equipment complies with FCC/IC radiation exposure limits set forth for an uncontrolled environment and meets the FCC radio frequency (RF) Exposure Guidelines in Supplement C to OET65 and RSS-102 of the IC radio frequency (RF) Exposure rules. This equipment has very low levels of RF energy that is deemed to comply without maximum permissive exposure evaluation (MPE). But it is desirable that it should be installed and operated keeping the radiator at least 20 cm (7 7/8") or more away from person's body (excluding extremities: hands, wrists, feet and ankles).

THE FOLLOWING APPLIES ONLY IN THE U.S.A.

FCC Note:

This equipment has been tested and found to comply with the limits for a Class B digital device, pursuant to Part 15 of the FCC Rules. These limits are designed to provide reasonable protection against harmful interference in a residential installation. This equipment generates, uses and can radiate radio frequency energy and, if not installed and used in accordance with the instructions, may cause harmful interference to radio communications. However, there is no guarantee that interference will not occur in a particular installation. If this equipment does cause harmful interference to radio or television reception, which can be determined by turning the equipment off and on, the user is encouraged to try to correct the interference by one or more of the following measures:

- Reorient or relocate the receiving antenna.
- Increase the separation between the equipment and receiver.
- Connect the equipment into an outlet on a circuit different from that to which the receiver is connected.
- Consult the dealer or an experienced radio/TV technician for help.

FCC Caution: To assure continued compliance, follow the attached installation instructions and use only shielded interface cables when connecting to peripheral devices.

Any unauthorized changes or modifications to this equipment would void the user's authority to operate this device.

This device complies with Part 15 of the FCC Rules.

Operation is subject to the following two conditions:

- (1) This device may not cause harmful interference, and
- (2) this device must accept any interference received, including interference that may cause undesired operation.

Declaration of Conformity

Trade Name: Technics

Model No.: ST-C700

Responsible Party:

Panasonic Corporation of North America

Two Riverfront Plaza, Newark, NJ 07102-5490

Support Contact: <http://www.panasonic.com/contactinfo>



THE FOLLOWING APPLIES ONLY IN CANADA

CAN ICES-3(B)/NMB-3(B)

WARNING

Unit

- To reduce the risk of fire, electric shock or product damage,
 - Do not expose this unit to rain, moisture, dripping or splashing.
 - Do not place objects filled with liquids, such as vases, on this unit.
 - Use only the recommended accessories.
 - Do not remove covers.
 - Do not repair this unit by yourself. Refer servicing to qualified service personnel.
 - Do not place heavy items on this unit.

AC power supply cord

- The power plug is the disconnecting device. Install this unit so that the power plug can be unplugged from the socket outlet immediately.

CAUTION

Unit

- Do not place sources of naked flames, such as lighted candles, on this unit.

Placement

- To reduce the risk of fire, electric shock or product damage,
 - Do not install or place this unit in a bookcase, built-in cabinet or in another confined space. Ensure this unit is well ventilated.
 - Do not obstruct this unit's ventilation openings with newspapers, tablecloths, curtains, and similar items.
- Keep your speakers at least 10 mm (3/8") away from the system for proper ventilation.
- Do not lift or carry this unit by holding any of its levers. Doing so may cause this unit to fall, resulting in personal injury or malfunction of this unit.

Battery

- Danger of explosion if battery is incorrectly replaced. Replace only with the type recommended by the manufacturer.
- Mishandling of batteries can cause electrolyte leakage and may cause a fire.
 - Remove the battery if you do not intend to use the remote control for a long period of time. Store in a cool, dark place.
 - Do not heat or expose to flame.
 - Do not leave the battery(ies) in a car exposed to direct sunlight for a long period of time with doors and windows closed.
 - Do not take apart or short circuit.
 - Do not recharge alkaline or manganese batteries.
 - Do not use batteries if the covering has been peeled off.
 - Do not mix old and new batteries or different types at the same time.
- When disposing of the batteries, please contact your local authorities or dealer and ask for the correct method of disposal.



Information on Disposal in other Countries outside the European Union

This symbol is only valid in the European Union. If you wish to discard this product, please contact your local authorities or dealer and ask for the correct method of disposal.

Table of contents

IMPORTANT SAFETY INSTRUCTIONS	5	Using PC, etc.	17
Accessories	6	Using Bluetooth®	18
Control reference guide	7	Sound adjustment	20
Getting started	9	Others	21
HOME menu and basic operations	11	Troubleshooting	23
Network settings	12	Unit care	26
Playing back music files on the DLNA server	13	Specifications	27
Using iPhone/iPad/iPod	14	Limited Warranty (ONLY FOR U.S.A.)	31
Using AirPlay	15	Limited Warranty (ONLY FOR CANADA)	32
Using USB device	15		

About descriptions in this Owner's Manual

- Pages to be referred to are indicated as "⇒ ○○".
- The illustrations shown may differ from your unit.
- Unless otherwise indicated, operations are described using the remote control.

Accessories

- 1 AC power supply cord**
(K2CB2YY00098)

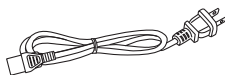

- 1 System connection cable**
(K2KYYYYY00233)



- 1 Remote control**
(N2QAYA000096)



- 2 Batteries for remote control**



- 1 Coaxial digital cable**
(K2KYYYYY00251)



(ONLY FOR CANADA)

The enclosed Canadian French label sheet corresponds to the English display on the unit.



- Product numbers provided in this Owner's Manual are correct as of December 2014. These may be subject to change.
- Do not use AC power supply cord with other equipment.

■ Using the remote control

Insert the battery so the terminals (+ and -) match those in the remote control.
Point it at the remote control signal sensor on this unit. (⇒ 7)

- Keep the batteries out of reach of children to prevent swallowing.

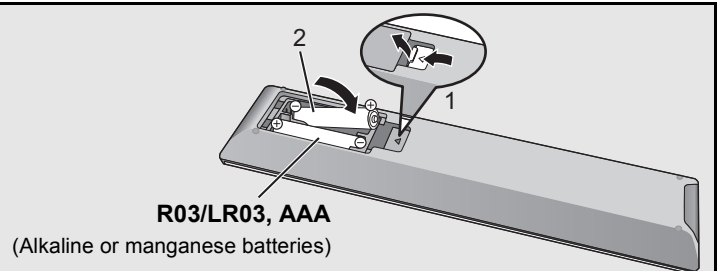

Control reference guide

This unit

■ Front

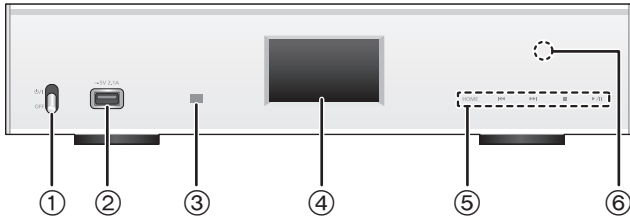

- ① **Power switch lever**
Turn on/off this unit.
 - The remote control do not operate when the power switch lever is in the lowered position.
- ② **Port for iPhone/iPad/iPod and USB devices (⇒ 14, 15)**
- ③ **Remote control signal sensor**
Distance: Within approx. 7 m (23 ft) directly in front
Angle: Approx. 30° left and right
- ④ **Display**
- ⑤ **Basic control switches**
These switches work just by touching the marks. Each time you touch the switch, there will be a beep sound. (⇒ 11)
 - When playback information is not shown on the display (except in NFC registration standby mode (⇒ 18)), you can perform the following operations on the touch panel:

⏮	▲ (Up)
⏭	▼ (Down)
▶/⏸	OK (OK)
■	RETURN (Return)
HOME (Touch and hold)	MENU (Enter menu)

- ⑥ **NFC touch area (⇒ 18)**
The NFC touch area sheet is attached to this area at the time of purchase.

■ Rear

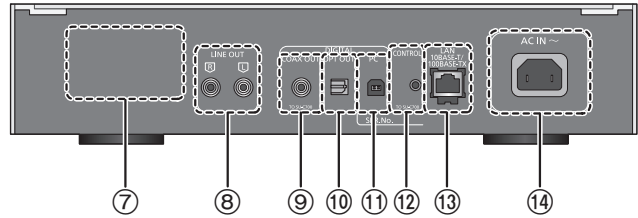

- ⑦ **Product identification marking**
The model number is indicated.
- ⑧ **Analog audio output terminal [LINE OUT] (⇒ 9)**
- ⑨ **Digital audio output terminal [COAX OUT] (⇒ 9)**
- ⑩ **Digital audio output terminal [OPT OUT] (⇒ 9)**
- ⑪ **Digital audio input terminal [PC] (⇒ 17)**
For connecting to a PC, etc.
- ⑫ **System terminal [CONTROL] (⇒ 9)**
- ⑬ **LAN port [LAN] (⇒ 12)**
- ⑭ **AC IN terminal [AC IN ~] (⇒ 10)**

Remote control

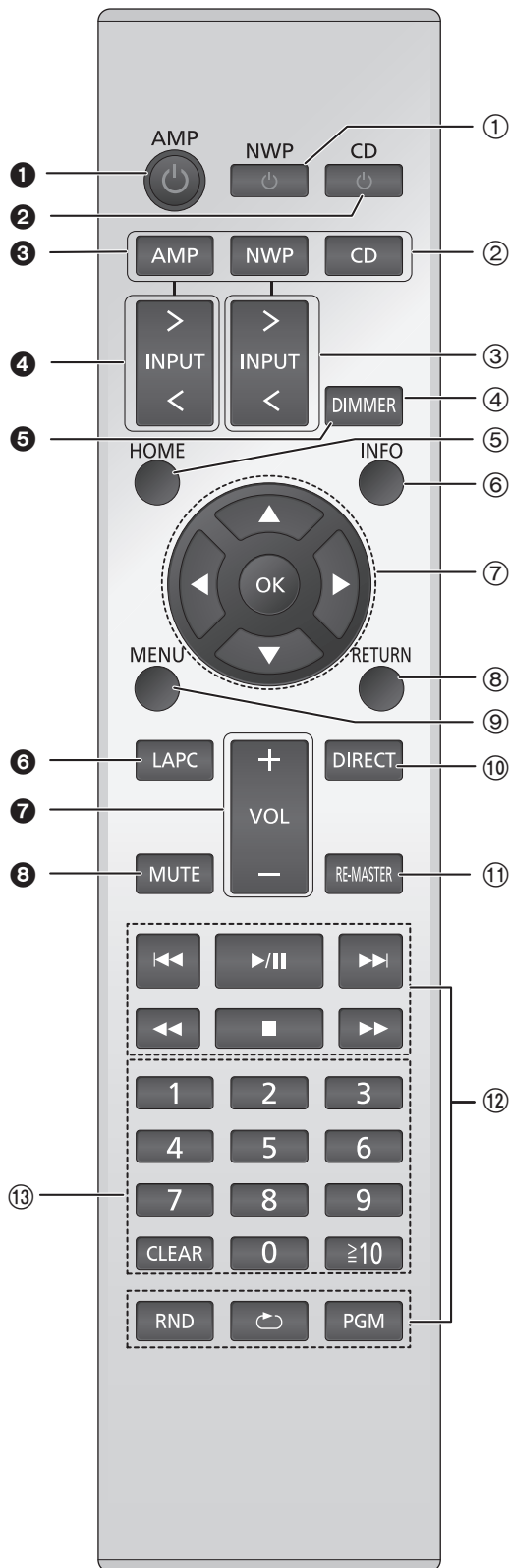

■ Buttons that work for this unit

- ① **[NWP $\text{\textcircled{P}}$]: Standby/on switch**
Press to switch the unit from on to standby mode or vice versa. In standby mode, the unit is still consuming a small amount of power.
 - The remote control do not operate when the power switch lever is in the lowered position.
- ② **[AMP]/[NWP]/[CD]: Select the device to be operated**
- ③ **[> INPUT <]: Select the input source**
- ④ **[DIMMER]: Adjust the brightness of the display, etc. (⇒ 11)**
- ⑤ **[HOME]: Display HOME menu (⇒ 11)**
- ⑥ **[INFO]: View content information**
Press this button to display the track, artist, and album names, file type, sampling frequency, and other information.
- ⑦ **[▲, ▼, ◀, ▶]/[OK]: Selection/OK**
- ⑧ **[RETURN]: Return to the previous display**
- ⑨ **[MENU]: Enter menu (⇒ 18, 19, 21)**
- ⑩ **[DIRECT]: Turn on/off Direct mode (⇒ 20)**
- ⑪ **[RE-MASTER]: Turn on/off Re-master (⇒ 20)**
- ⑫ **Basic playback control buttons**
- ⑬ **Numeric buttons, etc.**
 - To select a 2-digit number
Example:
16: [≥10] → [1] → [6]
 - To select a 4-digit number
Example:
1234: [≥10] → [≥10] → [≥10] → [1] → [2] → [3] → [4]
 - [CLEAR]: Clear the entered value.

■ Buttons that work for the SU-C700/SL-C700

The remote control of this unit also works for the SU-C700/SL-C700. For information on the operations of the SU-C700/SL-C700, please also refer to their operating instructions.

- ① Standby/on switch for the SU-C700
- ② Standby/on switch for the SL-C700
- ③ Select the device to be operated
- ④ Select the input source of the SU-C700
- ⑤ Adjust the brightness of the display, etc.
- ⑥ Measure the characteristics of the amplifier and correct its output
- ⑦ Adjust the volume
- ⑧ Mute the sound

Getting started

- Turn off all equipment before connection and read the appropriate operating instructions.
- Do not connect the AC power supply cord until all other connections are complete.
- Insert the plugs of the cables to be connected all the way in.
- Do not bend cables at sharp angles.

System control connection to an SU-C700

- You can output digital audio signals from this unit and play back music.
- You can automatically link this unit with the SU-C700 and operate them easily with the remote control. (⇒ 23)

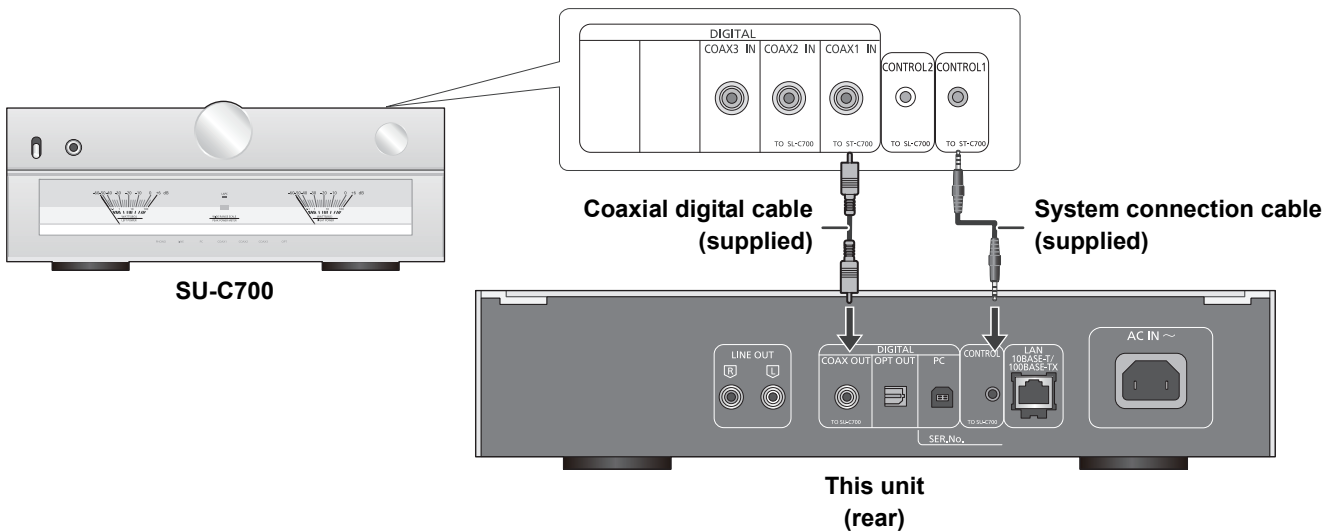

- Do not use any other system connection cables or coaxial digital cables except the supplied one.
- Connect the system connection cable to the system terminal [CONTROL1] of the SU-C700.
- Connect the coaxial digital cable to the digital audio input terminal [COAX1 IN] of the SU-C700.

Connecting to an amplifier and a D/A converter

You can output analog or digital audio signals from this unit and play back music files.

e.g.,

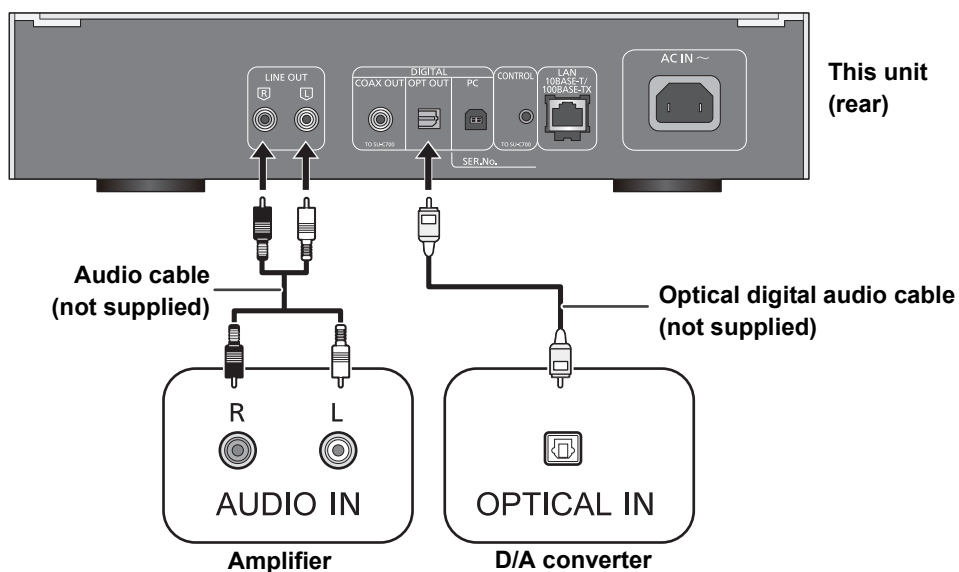

AC power supply cord connection

Connect only after all other connections are completed.

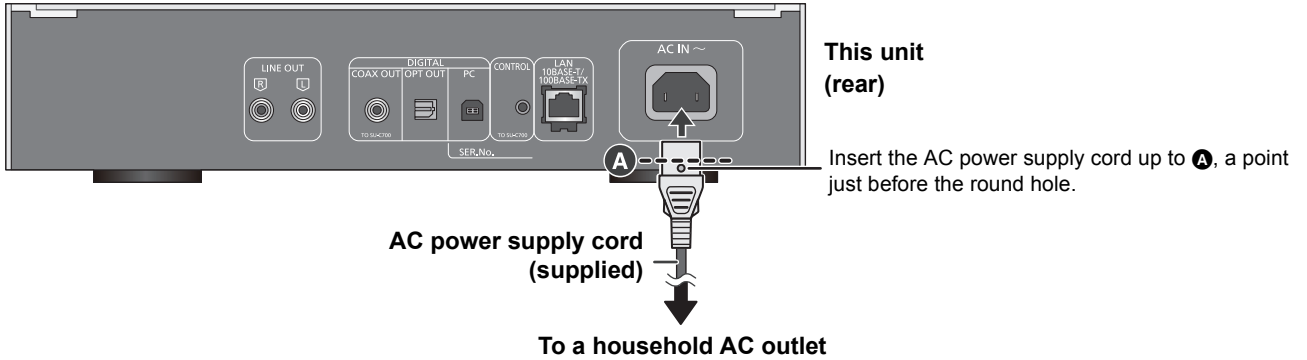

- This unit consumes a small amount of AC power (⇒ 27) even the power switch lever is in the [OFF] position. Remove the plug from the main electrical outlet if you will not be using the unit for an extended period of time. Place the unit so the plug can be easily removed.

HOME menu and basic operations

Major functions of this unit can be operated from the HOME menu.

Preparation

- Prepare the music that you want to play back.
- Turn on the connected device (amplifier, etc.) and lower its volume.

- 1 Raise the power switch lever of this unit to the [⏻/⏻] position.
- 2 Press [NWP].
- 3 Press [HOME].



- 4 Press [▲, ▼] to select an item and then press [OK].
 - If there are any other items, repeat this step.

LAN	Connects this unit to a network and plays back music over it. (⇒ 13)
USB	Plays back music stored on a USB device or an iPhone/iPad/iPod. (⇒ 14, 15, 16)
PC	Plays back music stored on a PC, etc. (⇒ 17)
Bluetooth	Connects this unit to a Bluetooth® device and plays back music stored on it. (⇒ 18, 19)
SETUP	(⇒ 11, 12, 20, 21, 22, 23)

- 5 Start play.

■ To display HOME menu

Press [HOME].

Adjusting the volume

Adjust the volume of the connected device (amplifier, etc.).

Display brightness

The brightness of this unit's display and the basic control switches can be changed.

Press [DIMMER] repeatedly.



- When the display is turned off, it will light up only when you operate this unit. Before the display turns off again, "Display Off" will be displayed for a few seconds.

Operation sound setting

You can turn the beep sound on/off.

- The factory default is "On".

- 1 Press [NWP].
- 2 Press [HOME].
- 3 Press [▲, ▼] repeatedly to select "SETUP" and then press [OK].
- 4 Press [▲, ▼] repeatedly to select "Beep" and then press [OK].
- 5 Press [▲, ▼] to select "On"/"Off" and then press [OK].

Operations using the dedicated app "Technics Music App"

If you install the dedicated app "Technics Music App" (free of charge) on your tablet/smartphone, you can control this unit and the SU-C700 using a wide variety of functions.

For details, visit:

www.technics.com/support/

Network settings

You can stream music from an iOS device (iPhone/iPad/iPod), an Android™ device or a PC (Mac/Windows) to this unit by using the AirPlay or DLNA feature. (⇒ 13, 15)

To use these features, this unit must join the same network as the AirPlay compatible device or the DLNA compatible device.

Wired LAN connection

Normally, just connecting a LAN cable will complete the setup.

**This unit
(rear)**

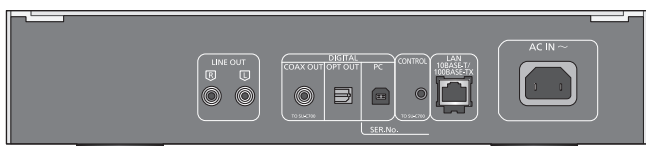

Broadband router, etc.

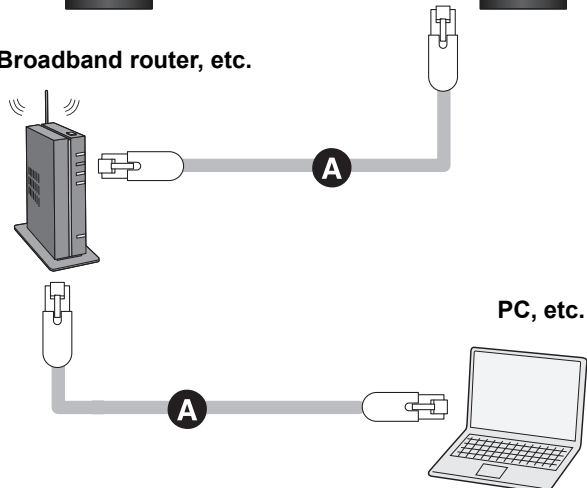

A: LAN cable (not supplied)

- 1 Disconnect the AC power supply cord.
- 2 Connect this unit to a broadband router, etc. using a LAN cable.
- 3 Connect the AC power supply cord to this unit, and raise the power switch lever to the [⏻/⏻] position. (⇒ 10)

To make network-related settings

You can change this unit's name on the network (Friendly Name), and use specific IP address, subnet mask, default gateway, primary DNS, etc.

• Do not play back music while changing these settings.

- 1 Press [NWP].
- 2 Press [HOME].
- 3 Press [▲, ▼] repeatedly to select "SETUP" and then press [OK].
- 4 Press [▲, ▼] repeatedly to select "Network" and then press [OK].
- 5 Select and input the details.
- 6 Press [OK] to apply the settings.
- 7 Press [RETURN] repeatedly to exit the settings.
- 8 Press [NWP ⏻] to turn the unit to standby mode.
 - Wait until "Please Wait" disappears.
- 9 Perform "Wired LAN connection". (⇒ left)



- Use category 7 or above straight LAN cables (STP) when connecting to peripheral devices.
- Inserting any cable other than a LAN cable in the LAN port can damage the unit.
- If you try to change the network settings immediately after turning on this unit, it may take some time until the network setup screen is displayed.

Playing back music files on the DLNA server

You can share music files stored in the DLNA Certified media server (PC, smartphone, etc.) connected to your home network, and enjoy the contents with this unit.

- About supported format, refer to “File format” (⇒ 29)

Preparation

- Complete the network settings. (⇒ 12)
- Connect the device to be used to the same network as this unit.
- Add the contents and folder to the libraries of the Windows Media® player 11 or 12, or a smartphone, etc.
 - Playlist of Windows Media® player can play back only the contents that are stored in the libraries.
 - To use Windows Media® Player for streaming, you need to configure it in advance.

Playing back content stored on the DLNA server by controlling it from this unit

You can play back music stored on the DLNA server on this unit (DMP—Digital Media Player) by controlling the DLNA server with this unit.

- 1 Press [NWP].
- 2 Press [> INPUT <] below [NWP] repeatedly to select “LAN”.
 - The server selection screen will be displayed.
- 3 Press [▲, ▼] to select a DLNA server on the network, and then press [OK].
 - The folder/content selection screen will be displayed.
 - Folders/content may be displayed in different order from the order on the server, depending on its specifications.
- 4 Press [▲, ▼] to select an item and then press [OK].
 - If there are any other items, repeat this step.

Operations on the remote control

Stop	Press [■].
Pause	Press [▶/]. • Press again to restart play.
Skip	Press [◀◀] or [▶▶] to skip track. • If you press either of these buttons during pause, playback will restart.
Search	During play or pause, press and hold [◀◀] or [▶▶]. • On the unit: press and hold [◀◀] or [▶▶].

■ Random repeat playback

Press [RND].

Each time you press the button:

On	All tracks in a folder are repeated randomly. • “RND ↻” is displayed.
Off	Turns off random repeat mode.

■ Repeat playback

Press [↻].

Each time you press the button:

1-Track	Only plays the selected track. • “1 ↻” is displayed.
All	All tracks in a folder are repeated. • “↻” is displayed.
Off	Turns off repeat mode.

Playing back content stored on the DLNA server by controlling it from a DMC

By controlling a DMC (Digital Media Controller) compatible device, you can play back music stored on the DLNA server on this unit (DMR—Digital Media Renderer).

- 1 Raise the power switch lever of this unit to the [⏻/⏻] position.
- 2 Operate the DMC compatible device and connect to this unit.
 - The device name of this unit will be displayed as “Technics ST-C700 _ _ _ _ _”^{*1, 2}.
 - For details on how to use DMC compatible devices, refer to the operating instructions of the devices or the software.



- You cannot use random repeat playback in combination with other playback modes.
- When you operate DMC, playback of other audio sources will stop and DLNA output will have priority.
- Depending on the contents and the connected equipment, operations or playback may not be possible.

*1 “_” stands for a digit that is unique to each set.

*2 The device name can be changed from “To make network-related settings”. (⇒ 12)

Using iPhone/iPad/iPod

Connect your iPhone/iPad/iPod, and you can play back music stored on iPhone/iPad/iPod or charge iPhone/iPad/iPod.

Compatible iPhone/iPad/iPod

iPhone 6 Plus / iPhone 6 / iPhone 5s / iPhone 5c / iPhone 5 / iPhone 4s / iPhone 4 / iPhone 3GS / iPhone 3G
iPad Air / iPad (3rd and 4th generation) / iPad 2 / iPad / iPad mini 2 / iPad mini
iPod touch (2nd through 5th generation)
iPod nano (3rd through 7th generation)

(as of November 2014)



- Compatibility depends on the software version. Update your iPhone/iPad/iPod to the latest software before using it with this unit.
- Please be aware that Panasonic accepts no responsibility for the loss of data and/or information.
- Do not connect the following models to the port:
 - iPod classic, iPod [4th (color display), and 5th (video) generation], iPod nano (1st generation)
 Unexpected behavior may occur.
- Operation results may vary depending on the iPhone/iPad/iPod models or the iOS version.

Connecting an iPhone/iPad/iPod

When connecting an iPhone/iPad/iPod, use the dedicated USB cable (not supplied).

e.g.,

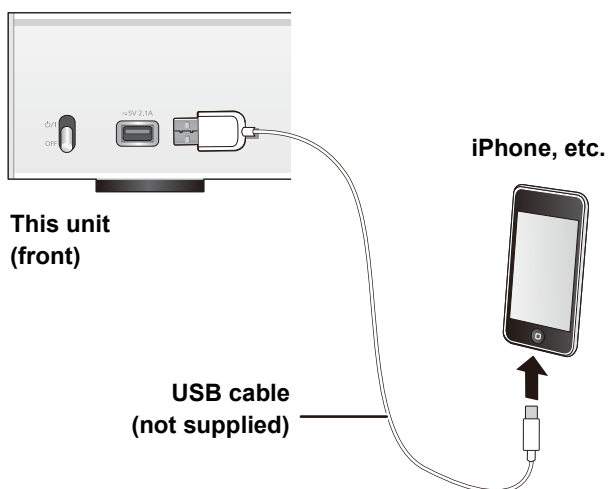

Listening to music stored on an iPhone/iPad/iPod

- 1 Connect iPhone/iPad/iPod to the unit.
- 2 Press [NWP].
- 3 Press [> INPUT <] below [NWP] repeatedly to select "USB".
- 4 Start play.

Operations on the remote control

Stop	Press [■].
Pause	Press [▶/]. • Press again to restart play.
Skip	Press [◀◀] or [▶▶] to skip track.
Search	During play or pause, press and hold [◀◀] or [▶▶]. • On the unit: press and hold [◀◀] or [▶▶].



- It may be necessary to select the album, artist, etc. on the iPhone/iPad/iPod.
- Depending on the iPhone/iPad/iPod models, operations on the remote control may not be possible.

Charging an iPhone/iPad/iPod

During unit on, charging starts when an iPhone/iPad/iPod is connected to this unit.

- Charging is not possible when this unit is turned off.
- Make sure the unit is turned on when you start charging.
 - When charging an iPhone/iPad/iPod whose battery is depleted, do not turn this unit to standby mode until the iPhone/iPad/iPod becomes operational.
- Check the iPhone/iPad/iPod to see if the battery is fully charged. Once fully charged, remove the iPhone/iPad/iPod.
- Charging stops when the battery is fully charged. The battery will deplete naturally.

Using AirPlay

AirPlay works with iPhone, iPad, and iPod touch with iOS 4.3.3 or later, Mac with OS X Mountain Lion or later, and PC with iTunes 10.2.2 or later.

Listening to music with AirPlay

Preparation

- Complete the network settings. (⇒ 12)
- Connect the iOS device or PC to the same network as this unit.

1 **iOS device** : Start the “Music” (or iPod) app.
PC : Start “iTunes”.

2 Select “Technics ST-C700 _ _ _ _ _”^{*1, 2} from the AirPlay  icon.
 • Check the volume settings before starting the playback.
 (When AirPlay is used for the first time, the volume may be output at the maximum setting.)

3 Start play.
 • The playback will start with a slight delay.

Operations on the remote control

Stop	Press [■].
Pause	Press [▶/]. • Press again to restart play.
Skip	Press [◀◀] or [▶▶] to skip track.



- Playback of other audio sources will stop and AirPlay output will have priority.
- With some iOS and iTunes versions, it may not be possible to restart the AirPlay playback if the selector is changed or the unit is turned off, during the AirPlay playback.
 In this case, select a different device from the AirPlay icon of the Music app or iTunes and then re-select this unit as the output speakers.
- AirPlay will not work when playing back videos on iTunes.

*1 “_” stands for a digit that is unique to each set.

*2 The device name can be changed from “To make network-related settings”. (⇒ 12)

Using USB device

You can play back music stored on a USB device.

- This unit does not guarantee connection with all USB devices.
- FAT16 and FAT32 file systems are supported.
- This unit supports USB 2.0 high speed.
- USB devices may not be recognized by this unit when connected using the following:
 - a USB hub
 - a USB extension cable
- It is not possible to use USB card reader/writers.
- This unit cannot record music to a USB device.
- About supported format, refer to “File format” (⇒ 29)

Listening to music stored on a USB device

1 Connect a USB device to the unit.

e.g.,

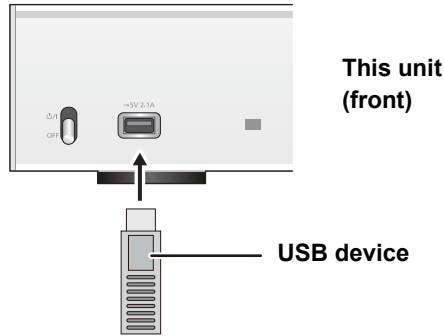

2 Press [NWP].

3 Press [> INPUT <] below [NWP] repeatedly to select “USB”.

4 Press [▲, ▼] to select an item and then press [OK].
 • If there are any other items, repeat this step.

Operations on the remote control

Stop	Press [■].
Pause	Press [▶/]. • Press again to restart play.
Skip	Press [◀◀] or [▶▶] to skip track. • If you press either of these buttons during pause, playback will restart.
Search	During play or pause, press and hold [◀◀] or [▶▶]. • On the unit: press and hold [◀◀] or [▶▶]. • This operation may not be available for some formats.

■ Random repeat playback

Press [RND].



Each time you press the button:

On	All tracks in a folder are repeated randomly. • "RND  " is displayed.
Off	Turns off random repeat mode.

■ Repeat playback

Press [].

Each time you press the button:

1-Track	Only plays the selected track. • "1  " is displayed.
All	All tracks in a folder are repeated. • "  " is displayed.
Off	Turns off repeat mode.







- You cannot use random repeat playback in combination with other playback modes.
- You can use repeat playback in combination with program playback.

Program playback





This function allows you to program up to 24 tracks.

Preparation

- It is not possible to program tracks by moving folders. Move all the tracks you want to program to a single folder in advance.

- 1 Press [PGM] in the stop mode.
 - "Program Mode" screen will be displayed.
- 2 Press [OK] to display the programming screen.
- 3 Press [, ] to select the desired track.
- 4 Press [OK].
 - Do steps 3 through 4 again to program other tracks.
- 5 Press [, ] to start playback.
 - To return to the "Program Mode" screen, press [].

Operations on the remote control

Stop	Press []. • Programed content is maintained.
Check the programed order	Press [ , ] in the stop mode. • To return to the "Program Mode" screen, press [RETURN].
Add tracks	Do steps 3 through 4 in the stop mode.
Clear the last track	Press [CLEAR] in the stop mode. • It is not possible to select and clear the desired programed track.
Cancel program mode	① Press [PGM] in the stop mode. • "Program Clear" is shown. ② Press [ , ] to select "Yes" and then press [OK]. • The program memory will be cleared.



- Programed content is maintained as long as the input source is set to "USB".
- The program memory will be cleared:
 - When the USB device is disconnected.
 - When the unit is turned to standby or off mode.
- You can use program playback in combination with repeat playback.

Using PC, etc.

You can connect the digital audio input terminal [PC] and a PC, etc. with a USB cable and play back music on the PC, etc. with this unit.

- About supported format, refer to “File format” (⇒ 29)

Connecting to a PC

Before connecting to a PC, follow the steps below.

- Refer to the following for the recommend OS versions for your PC:

- Windows Vista, Windows 7, Windows 8, Windows 8.1
- OS X 10.7, 10.8, 10.9, 10.10

- ① Download and install the dedicated driver to the PC. (Only for Windows OS)

Download and install the driver from the website below.
www.technics.com/support/

- ② Download and install the dedicated app “Technics Audio Player” (free of charge) on your PC. (Common to both Windows OS and OS X)

Download and install the app from the website below.

www.technics.com/support/

(as of November 2014)

Listening to audio from a PC, etc.

- 1 Disconnect the AC power supply cord.
- 2 Connect this unit and a PC, etc.

e.g.,

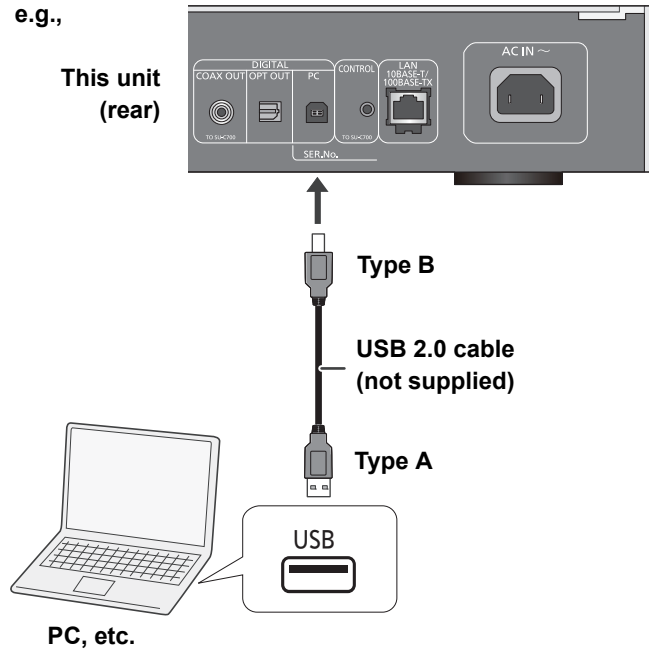

- 3 Connect the AC power supply cord to this unit, and raise the power switch lever to the [⏻/|] position. (⇒ 10)
- 4 Press [NWP].
- 5 Press [> INPUT <] below [NWP] repeatedly to select “PC”.
- 6 Operate the PC, etc. for playback.

Using Bluetooth®

You can listen to the sound from the Bluetooth® audio device from this unit wirelessly.

- Refer to the operating instructions of the Bluetooth® device for details.
- If you intend to use an NFC (Near Field Communication)-compatible Bluetooth® device, proceed to “Connecting by NFC”.

Connecting via Bluetooth® menu

Preparation

- Turn on the Bluetooth® feature of the device and place the device near this unit.

- 1 Press [NWP].
- 2 Press [➤ INPUT <] below [NWP] repeatedly to select “Bluetooth”.
- 3 Press [MENU].
- 4 Press [▲, ▼] repeatedly to select “Pairing” and then press [OK].
- 5 Press [▲, ▼] to select “Yes” and then press [OK].
 - “Pairing” is indicated on the display.
- 6 Select “ST-C700” from the Bluetooth® device’s Bluetooth® menu.
 - The name of the connected device is indicated on the display.



- If prompted for the passkey, input “0000”.
- You can register up to 8 devices with this unit. If a 9th device is paired, the device that has not been used the longest will be replaced.

Connecting by NFC

For NFC-compatible Bluetooth® devices (Android™ devices with version 4.1 or later) only

With the touch of an NFC (Near Field Communication)-compatible Bluetooth® device to this unit, you can complete a series of steps from registering a Bluetooth® device to connecting it to this unit.

Preparation

- Turn on the NFC feature of the device.

- 1 Press [NWP].
- 2 Press [➤ INPUT <] below [NWP] repeatedly to select “Bluetooth”.
- 3 Press [MENU].
- 4 Press [▲, ▼] repeatedly to select “NFC” and then press [OK].
- 5 Press [▲, ▼] to select “Yes” and then press [OK].
- 6 Touch and hold your device on the NFC touch area of this unit within 20 seconds. (⇒ 7)
 - Do not move the Bluetooth® device until it displays a message or reacts in some way. Once the Bluetooth® device has reacted, move the device away from this unit.
 - When the connection of the Bluetooth® device is complete, the name of the connected device is indicated on the display.
 - The location of the NFC touch area differs depending on the device. When a connection cannot be established even if your Bluetooth® device has touched the NFC touch area of this unit, change the position of the device.



- If you connect another NFC-compatible Bluetooth® device, the previously connected device will be disconnected automatically.
- When the connection is established, playback may start automatically depending on the type of device being used.
- Connecting by NFC may not work properly depending on the type of device being used.
- Do not make an NFC connection in any other way than instructed in the Owner’s Manual. Doing so may cause malfunction.

Listening to music stored on a Bluetooth® device

- 1 Press [NWP].
- 2 Press [> INPUT <] below [NWP] repeatedly to select “Bluetooth”.
 - “Ready” is indicated on the display.
 - If you press [▶/||], this unit will try and connect to the last connected Bluetooth® device.
 - “Linking” is indicated on the display.
- 3 Select “ST-C700” from the Bluetooth® device’s Bluetooth® menu.
 - The name of the connected device is indicated on the display.
- 4 Start playback on the Bluetooth® device.

Operations on the remote control

Stop	Press [■].
Pause	Press [▶/]. • Press again to restart play.
Skip	Press [◀◀] or [▶▶] to skip track.
Search	During play or pause, press and hold [◀◀] or [▶▶]. • On the unit: press and hold [◀◀] or [▶▶].



- This unit can only be connected to one device at a time.
- To use this unit’s remote control with a Bluetooth® device, the Bluetooth® device must support AVRCP (Audio Video Remote Control Profile).
Depending on the status of the device, some controls may not work.

Bluetooth® transmission mode

You can change the transmission mode to prioritize transmission quality or sound quality.

- 1 Press [NWP].
- 2 Press [> INPUT <] below [NWP] repeatedly to select “Bluetooth”.
 - If a Bluetooth® device is already connected, disconnect it.
- 3 Press [MENU].
- 4 Press [▲, ▼] repeatedly to select “Link Mode” and then press [OK].
- 5 Press [▲, ▼] to select the mode and then press [OK].

Mode 1	Emphasis on connectivity
Mode 2	Emphasis on sound quality (default)



- Select “Mode 1” if the sound is interrupted.

Disconnecting a Bluetooth® device

- 1 Press [NWP].
- 2 Press [MENU].
- 3 Press [▲, ▼] repeatedly to select “Disconnect?” and then press [OK].
- 4 Press [▲, ▼] to select “Yes” and then press [OK].



- The Bluetooth® device will be disconnected if a different audio source is selected.

Sound adjustment

The following sound effects can be added to the audio output.

Listening to more natural-sounding audio (Re-master)

Re-mastering expands the playback band and achieves a higher bit depth to reproduce natural and expansive sound close to original music.

- The factory default is “Off”.

- 1 Press [NWP].
- 2 Press [RE-MASTER] to select “On”/“Off”.

Direct mode

This unit can transmit input signals without performing digital signal processing (DSP). This enables faithful and high quality reproduction of original sound.

- The factory default is “Off”.

- 1 Press [NWP].
- 2 Press [DIRECT] to select “On”/“Off”.

Setting the sampling frequency

You can set an upper limit on the output sampling frequency range. Please note that the range that can be processed differs depending on the amplifier or D/A converter. For details, refer to the operating instructions of the connected device.

- The factory default is “32kHz-192kHz”.

Preparation

- Set “Digital Output” to “On”.

- 1 Press [NWP].
- 2 Press [HOME].
- 3 Press [▲, ▼] repeatedly to select “SETUP” and then press [OK].
- 4 Press [▲, ▼] repeatedly to select “D.Output fs” and then press [OK].
- 5 Press [▲, ▼] to select an item and then press [OK].
 - You can select a sampling frequency of 96 kHz or 192 kHz.

Disabling audio output

Disabling the audio output of unused terminals minimizes noise and allows playback in higher audio quality.

- The factory default is “On”.

- 1 Press [NWP].
- 2 Press [HOME].
- 3 Press [▲, ▼] repeatedly to select “SETUP” and then press [OK].

To disable the digital audio output:

Press [▲, ▼] repeatedly to select “Digital Output” and then press [OK].

To disable the analog audio output:

Press [▲, ▼] repeatedly to select “Analog Output” and then press [OK].

- 4 Press [▲, ▼] to select “Off” and then press [OK].
 - To enable the output again, select “On”.



- Depending on the music source that you play back, the applied setting may be less effective.
- Depending on the music source that you play back, it may not be possible to achieve the desired audio quality and sound field effect. In such cases, turn off this function.
- Both Re-master and Direct mode cannot be set to “On”.
- When “Digital Output” and “Analog Output” are set to “Off”, no sound will be output.
- It may take some time to output audio when you have adjusted the audio quality.

Others

Sleep timer

The sleep timer can switch the unit to standby mode after a set time.

- 1 Press [NWP].
- 2 Press [MENU].
- 3 Press [▲, ▼] repeatedly to select “SLEEP” and then press [OK].
- 4 Press [▲, ▼] to set the time (in minutes) and then press [OK].

“30 minutes” ↔ “60 minutes” ↔ “90 minutes” ↔ “120 minutes”
↗ “Off” ↖

Auto off function

This unit is designed to conserve its power consumption and save energy. The unit will turn to standby mode automatically if there is no sound and it is not being used for approximately 20 minutes.

- The factory default is “On”.

To cancel this function

- 1 Press [NWP].
- 2 Press [HOME].
- 3 Press [▲, ▼] repeatedly to select “SETUP” and then press [OK].
- 4 Press [▲, ▼] repeatedly to select “AUTO OFF” and then press [OK].
- 5 Press [▲, ▼] to select “Off” and then press [OK].



- The auto off function works unless you turn it off, even if you turn off and on this unit.
- If “Network Standby” is set to “On”, this function will also be set to “On”. To change the setting, set “Network Standby” to “Off”. (⇒ 21)

Network standby

This unit can turn on automatically from standby mode when this unit is selected as the AirPlay/DLNA player.

- The factory default is “Off”.

- 1 Press [NWP].
- 2 Press [HOME].
- 3 Press [▲, ▼] repeatedly to select “SETUP” and then press [OK].
- 4 Press [▲, ▼] repeatedly to select “Network Standby” and then press [OK].
- 5 Press [▲, ▼] to select “On” and then press [OK].



- If this function is set to “On” the standby power consumption will increase.

Language

Select English or French for the display.

- The factory default is “English”.

- 1 Press [NWP].
- 2 Press [HOME].
- 3 Press [▲, ▼] repeatedly to select “SETUP” and then press [OK].
- 4 Press [▲, ▼] repeatedly to select “Language” and then press [OK].
- 5 Press [▲, ▼] to select “English”/“Français” and then press [OK].

Firmware updates

Occasionally, Panasonic may release updated firmware for this unit that may add or improve the way a feature operates. These updates are available free of charge.

Preparation

- Connect this unit to the network. (⇒ 12)
 - Make sure that the network is connected to the Internet.

- 1 Press [NWP].
- 2 Press [HOME].
- 3 Press [▲, ▼] repeatedly to select “SETUP” and then press [OK].
- 4 Press [▲, ▼] repeatedly to select “F/W Update” and then press [OK].
- 5 Press [▲, ▼] to select “Yes” and then press [OK].

Do not disconnect the AC power supply cord or lower the power switch lever to the [OFF] position while one of the following messages is displayed.

“Linking” or “Updating”

- During the update process, no other operations can be performed.

- When the update has finished successfully, “Success” is displayed.

- 6 Disconnect the AC power supply cord and reconnect it after 3 minutes.



- If there are no updates, “No Need” is displayed after step 5.
- Downloading will require several minutes. It may take longer or may not work properly depending on the connection environment.

■ Checking the firmware version

- 1 Press [NWP].
- 2 Press [HOME].
- 3 Press [▲, ▼] repeatedly to select “SETUP” and then press [OK].
- 4 Press [▲, ▼] repeatedly to select “F/W Version” and then press [OK].
 - Press [OK] to exit.

Remote control code

When other equipment responds to the supplied remote control, change the remote control code.

- The factory default is “Mode 1”.

Point the remote control at this unit, and press and hold [OK] and the numeric button for at least 4 seconds.

- When the remote control code is changed, the new code will appear on the display for a few seconds.

[OK] + [1]	Set the code to “Mode 1”
------------	--------------------------

[OK] + [2]	Set the code to “Mode 2”
------------	--------------------------



- When the SU-C700/SL-C700 is connected via the system control function, change its remote control code as well as the remote control code for this unit.

Changing the character encoding

You can change the character encoding of track names, artist names and other information when they are not displayed as they should be.

- The factory default is “Type 1(日本)”.

- 1 Press [NWP].
- 2 Press [HOME].
- 3 Press [▲, ▼] repeatedly to select “SETUP” and then press [OK].
- 4 Press [▲, ▼] repeatedly to select “E Asian Character” and then press [OK].
- 5 Press [▲, ▼] to select “Type 1(日本)”/“Type 2(简体字)” and then press [OK].

Type 1(日本)	Priority is given to Japanese.
--------------	--------------------------------

Type 2(简体字)	Priority is given to Chinese (Simplified).
---------------	--

Troubleshooting

Using the system control function

You can automatically link this unit with the SU-C700 and operate them easily with the remote control.

Preparation

- ① Connect this unit and the SU-C700 with a system connection cable and a coaxial digital cable. (⇒ 9)
- ② Set the power switch lever of this unit and the SU-C700 to the [⏻/⏻] position.

■ Switching this unit and the SU-C700 to on/standby simultaneously

- If you point the remote control at this unit and press [NWP ⏻] when this unit and the SU-C700 are in standby mode, this unit and the SU-C700 will be turned on simultaneously.
- When both this unit and the SU-C700 are turned on and the input source of the SU-C700 is set to “COAX1”, you can set them to automatically enter standby mode using the sleep-timer. (⇒ 21)

■ Switching the SU-C700’s input source automatically

When you perform an operation such as playback on this unit, the input source of the SU-C700 will be automatically switched to “COAX1”.

■ Adjusting Bass/Middle/Treble

You can adjust the tone of the SU-C700 with this unit. Each tonal range (Bass/Middle/Treble) can be adjusted.

- 1 Press [NWP].
- 2 Press [HOME].
- 3 Press [▲, ▼] repeatedly to select “SETUP” and then press [OK].
- 4 Press [▲, ▼] repeatedly to select “Tone Control” and then press [OK].
- 5 Press [▲, ▼] to select “On (adjustment)” and then press [OK].
- 6 Press [▲, ▼] to select “BASS” (Bass), “MID” (Middle) or “TREBLE” (Treble).
- 7 Press [◀, ▶] to adjust the level and then press [OK].
 - Each level can be adjusted between “-10” and “+10”.



- For information on the operations of the SU-C700, please also refer to its operating instructions.

Before requesting service, make the following checks. If you are uncertain about some of the check points, or if the solutions indicated in the following guide does not resolve the issue, then consult your dealer for instructions.

Heat buildup of this unit.

- This unit becomes warm when used for a long time. This is not a malfunction.

Do you have the latest firmware installed?

- Panasonic is constantly improving the unit’s firmware to ensure that our customers are enjoying the latest technology. (⇒ 22)

To return all settings to the factory defaults

When the following situations occur, reset the memory:

- There is no response when buttons are pressed.
- You want to clear and reset the memory contents.

- ① Press [NWP].
- ② Press [HOME].
- ③ Press [▲, ▼] repeatedly to select “SETUP” and then press [OK].
- ④ Press [▲, ▼] repeatedly to select “Initialization” and then press [OK].
- ⑤ Press [▲, ▼] to select “Yes” and then press [OK].
- ⑥ Press [▲, ▼] to select “Yes” and then press [OK] again.

General

A “humming” sound can be heard during playback.

- An AC power supply cord or fluorescent light is near the cables. Keep other appliances and cords away from the cables of this unit.

No sound.

- Check the volume of the connected device (amplifier, etc.).
- Check to see if the cable connections to the input and output terminals are incorrect. If this is the case, turn off this unit and reconnect the cables correctly.
- Check to see if the correct input source is selected.
- Insert the plugs of the cables to be connected all the way in.
- When “Digital Output” and “Analog Output” are set to “Off”, no sound will be output. Change the setting of the output terminal to be used to “On”. (⇒ 20)
- Playback of multi-channel content is not supported.

The sound is interrupted.

- Depending on your environment, the audio may be interrupted during playback. Check the operating instructions of the connected device and the connection to the device.

Playback does not start.

- Depending on your environment or connected devices, it may take some time.

The system control function is not working.

- Connect the system connection cable to the system terminal [CONTROL1] of the SU-C700.
- Connect the coaxial digital cable to the digital audio input terminal [COAX1 IN] of the SU-C700.

The unit turns off automatically.

- Is the auto off function turned on? (⇒ 21)
- If the SU-C700 is connected to this unit via the system control function, this unit may automatically enter standby mode when the SU-C700 enters standby mode. (⇒ 9, 23)

AirPlay/DLNA**Cannot connect to the network.**

- Confirm the network connection and settings. (⇒ 12)

Cannot connect to the unit.

- Make sure that the multicast function on the wireless router is enabled.
- Make sure that the device and the unit are connected to the same network. (⇒ 12)
- Reconnect the compatible device to the network and then connect to this unit again.
- Set “Network Standby” to “Off” (⇒ 21), turn this unit off and on, and then connect to this unit again.

Playback does not start.**The sound is interrupted.**

- Simultaneous use with other 2.4 GHz devices, such as microwaves, cordless telephones, etc., may result in connection interruptions.
Increase the distance between the wireless router and these devices.
- If several wireless devices are simultaneously using the same wireless network as this unit, try turning off the other devices or reducing their wireless network usage.
- If the playback stops, check the playback status on the device.

iPhone/iPad/iPod**Cannot operate.**

- Select “USB” as the input source.
- Check that the iPhone/iPad/iPod is connected properly.
- Connect the iPhone/iPad/iPod again or try to restart the iPhone/iPad/iPod.
- The battery of the iPhone/iPad/iPod is depleted. Charge the iPhone/iPad/iPod, and then operate again.

iPhone/iPad/iPod does not charge.

- Make sure the unit is turned on when you start charging.
 - When charging an iPhone/iPad/iPod whose battery is depleted, do not turn this unit to standby mode until the iPhone/iPad/iPod becomes operational.

USB**The USB drive or its contents cannot be read.**

- The USB drive format or its contents is/are not compatible with the unit. (⇒ 29)

No response when [▶/||] is pressed.

- Disconnect the USB device and then reconnect it. Alternatively, turn the unit off and on again.

Slow operation of the USB flash drive.

- Large file size or high memory USB flash drive takes longer time to read.

PC**The PC does not recognize this unit.**

- Check your operating environment. (⇒ 17)
- Restart the PC, turn off and on this unit, and then reconnect the USB cable.
- Use another USB port of the connected PC.
- Install the dedicated driver if using a PC with Windows.

Cannot find music files stored on the PC.

- When you play back music files over a network, those that are not registered to its network server are not displayed. For details, refer to the operating instructions for your server.

Bluetooth®

Pairing cannot be completed.

- Check the Bluetooth® device condition.

The device cannot be connected.

- The pairing of the device was unsuccessful or the registration has been replaced. Try re-pairing the device.
- This unit might be connected to a different device. Disconnect the other device and try re-pairing the device.

The device is connected, but audio cannot be heard through this unit.

- For some built-in Bluetooth® devices, you have to set the audio output to “ST-C700” manually. Read the operating instructions for the device for details.

NFC is not working.

- Make sure the NFC feature of the device are turned on.
- When you try again, change the angle at which the Bluetooth® device touches the NFC touch area.
- Turn on the NFC feature of this unit when you connect a device using NFC. (⇒ 18)

Remote control

The remote control does not work properly.

- To avoid interference, please do not put any objects in front of signal sensor. (⇒ 7)
- Change the remote control code if other products react to this remote control. (⇒ 22)
- If the SU-C700/SL-C700 is selected for the device to be operated, press [NWP] and retry the operation. (⇒ 8)

Pressing [DIMMER] changes the display, the light and the indicator brightness of the SU-C700/SL-C700.

- [DIMMER] works for the SU-C700/SL-C700 as well as this unit. Turn off the device that you want to maintain the brightness level of, and press [DIMMER].

Messages

The following messages or service numbers may appear on the unit's display.

“AUTO OFF”

- The unit has been left unused for about 20 minutes and will enter standby mode within a minute. Press any button to cancel it.

“Checking Connection”

- The unit is checking the connected iPhone/iPad/iPod or a USB device.

“Download Error”

- The firmware download has failed. Press any button to exit. Please try again later.
- The server cannot be found. Press any button to exit. Make sure that the network is connected to the Internet.

“Empty”

- The selected folder is empty. Move tracks into the folder and retry the operation.
- The server is not found on the network. Check to see if the server is connected to the same network as this unit, and retry the connection to this unit. (⇒ 13)

“Error”

- Incorrect operation is performed. Read the instructions and try again.

“F□□” (“□” stands for a number.)

- There is a problem with this unit.
 - Is the volume extremely high?
If so, lower the volume.
 - Is this unit placed in an extremely hot place?
If so, move this unit to a cooler place and wait a few moments and then try to turn it on again.If the problem persists, write down the displayed number, disconnect the AC power supply cord and consult your dealer.

“No Network Connection”

- This unit is not connected to the network. Check the network connection. (⇒ 12)

Unit care

Pull out the AC power supply cord from the outlet before maintenance. Clean this unit with a soft cloth.

- When dirt is heavy, wring a wet cloth tightly to wipe the dirt, and then wipe it with a soft cloth.
- Do not use solvents including benzene, thinner, alcohol, kitchen detergent, a chemical wiper, etc. This might cause the exterior case to be deformed or the coating to come off.

“Not Conditional”

- The function you have tried to use is not available with the current settings. Check the steps and settings.

“PGM Full”

- The number of programmed tracks is more than 24.

“Please Wait”

- This is displayed, for example, when this unit is turned on/off. (For up to 1 minute and 30 seconds)

“Remote □” (“□” stands for a number.)

- The remote control and this unit are using different codes. Change the code on the remote control.
 - When “Remote 1” is displayed, press and hold [OK] and [1] for at least 4 seconds.
 - When “Remote 2” is displayed, press and hold [OK] and [2] for at least 4 seconds.

“Searching”

- The unit is checking the DLNA server on the network.

“Unlocked”

- “PC” is selected, but a PC is not connected. Check the connection with the PC. (⇒ 17)
- Audio signals, such as sampling frequency components, are not input correctly.
 - About supported format, refer to “File format” (⇒ 29)

“USB Over Current Error”

- The iPhone/iPad/iPod or USB device is drawing too much power. Disconnect the iPhone/iPad/iPod or USB device and turn the unit off and on again.

“Hub Device Not Supported”

“Unrecognizable Device”

“Unsupported”

“Unsupported USB Device”

- You have connected an iPhone/iPad/iPod or USB device that is not supported.
 - If the iPhone/iPad/iPod is compatible, turn it on and connect it correctly.
- The format of the file on the iPhone/iPad/iPod or USB device is not supported.
 - About supported format, refer to “File format” (⇒ 29)

Specifications

■ GENERAL

Power supply	AC 120 V, 60 Hz
Power consumption	26 W
Power consumption in standby mode*1	
(When "Network Standby" is off)	Approx. 0.2 W
(When "Network Standby" is on)	Approx. 4 W
Power consumption in off mode	Approx. 0.2 W
Dimensions (W×H×D)	340 mm×78 mm×295 mm (13 3/8"×3 1/16"×11 5/8")
Mass (Weight)	Approx. 4.0 kg (8.8 lbs)
Operating temperature range	0 °C to +40 °C (+32 °F to +104 °F)
Operating humidity range	35 % to 80 % RH (no condensation)

■ TERMINALS SECTION

Analog output	
LINE OUT	Pin jack
Digital output	
Optical digital output	Optical terminal
Coaxial digital output	Pin jack
System port	
System control	∅3.5 mm (1/8") jack
USB	
Front USB	Type A connector
Support memory capacity	2 TB (max)
Maximum number of folders (albums)	800
Maximum number of files (songs)	8000
File system	FAT16, FAT32
USB port power	DC OUT 5 V 2.1 A (max)
PC	
Rear USB	Type B connector
Ethernet interface	
LAN	10 Base-T/100 Base-TX

■ FORMAT SECTION

USB-A	
USB Standard	USB 2.0 high-speed
USB Mass Storage class	
USB-B	
USB Standard	USB 2.0 high-speed
USB Audio Class specification	USB Audio Class 2.0, Asynchronous mode
DSD control mode	ASIO Native mode, DoP mode DSD64/DSD128 playback

■ ANALOG OUTPUT SECTION

Channel	2 ch
Output level	
LINE OUT	2.0 Vrms
Frequency response	2 Hz to 90 kHz (−3 dB)
THD+N	0.0012 % (1 kHz, 0 dB)
S/N	112 dB (IHF-A)
Dynamic range	112 dB (IHF-A)

■ BLUETOOTH®/NFC SECTION

Bluetooth®	
Bluetooth® system specification	Bluetooth® Ver.3.0
Wireless equipment classification	Class 2 (2.5 mW)
Supported profiles	A2DP/AVRCP
Supported codec	aptX® Low Latency, AAC, SBC
Frequency band	2.4 GHz band FH-SS
Operating distance	About 10 m (33 ft) Line of sight*2



- Specifications are subject to change without notice.
- Mass and dimensions are approximate.

*1 When the iPhone/iPad/iPod is not charging

*2 Prospective communication distance

Measurement environment: Temperature 25 °C (77 °F) / Height 1.0 m (3.3 ft)
Measure in "Mode 1"

■ File format

This unit supports the following file formats.

- This unit does not support the playback of copy-protected music files.
- Playback of all files in formats supported by this unit is not guaranteed.
- Playback of a file in a format not supported by this unit may cause choppy audio or noise. In such cases, check to see if this unit supports the file format.
- This unit does not support VBR (Variable Bit Rate) playback.
- Some of the connected devices (servers) may be capable of converting files in formats not supported by this unit and output them. For details, refer to the operating instructions for your server.
- File information (sampling frequency, etc.) shown by this unit and playback software may differ from each other.

USB-A

File format	Extension	Sampling frequency	Bit rate Number of quantization bits
MP3	.mp3	32/44.1/48 kHz	16 kbps to 320 kbps
AAC	.m4a/.aac	32/44.1/48/88.2/96 kHz	16 kbps to 320 kbps
WMA	.wma	32/44.1/48 kHz	16 kbps to 320 kbps
WAV	.wav	32/44.1/48/88.2/96/176.4/192 kHz	16/24 bit
FLAC	.flac	32/44.1/48/88.2/96/176.4/192 kHz	16/24 bit
AIFF	.aiff	32/44.1/48/88.2/96/176.4/192 kHz	16/24 bit
ALAC	.m4a	32/44.1/48/88.2/96 kHz	16/24 bit
DSD	.dff/.dsf	2.8224/5.6448 MHz	

PC (USB-B)*1

File format	Extension	Sampling frequency	Bit rate Number of quantization bits
LPCM		32/44.1/48/88.2/96/176.4/192 kHz	16/24/32 bit
DSD	.dff/.dsf	2.8224/5.6448 MHz	

LAN (DLNA)*2

File format	Extension	Sampling frequency	Bit rate Number of quantization bits
MP3	.mp3	32/44.1/48 kHz	16 kbps to 320 kbps
AAC	.m4a/.aac	32/44.1/48/88.2/96 kHz	16 kbps to 320 kbps
WMA	.wma	32/44.1/48 kHz	16 kbps to 320 kbps
WAV	.wav	32/44.1/48/88.2/96/176.4/192 kHz	16/24 bit
FLAC	.flac	32/44.1/48/88.2/96/176.4/192 kHz	16/24 bit
AIFF	.aiff	32/44.1/48/88.2/96/176.4/192 kHz	16/24 bit
ALAC	.m4a	32/44.1/48/88.2/96 kHz	16/24 bit
DSD	.dff/.dsf	2.8224/5.6448 MHz	

*1 If you download and install the dedicated app, you can play back files in wide-ranging formats. (⇒ 17)
For details, refer to the operating instructions of the app.

*2 Whether or not each music file can be played back over your network is determined by the network server even if the format of the file is listed above. For example, if you are using Windows Media® Player 11, not all music files on the PC are playable. You can play back only those added to the library of Windows Media® Player 11.

■ About Bluetooth®

Panasonic bears no responsibility for data and/or information that is compromised during a wireless transmission.

Frequency band used

- This system uses the 2.4 GHz frequency band.

Certification of this device

- This system conforms to frequency restrictions and has received certification based on frequency laws. Thus, a wireless permit is not necessary.
- The actions below are punishable by law in some countries:
 - Taking apart or modifying the system.
 - Removing specification indications.

Restrictions of use

- Wireless transmission and/or usage with all Bluetooth® equipped devices is not guaranteed.
- All devices must conform to standards set by Bluetooth SIG, Inc.
- Depending on the specifications and settings of a device, it can fail to connect or some operations can be different.
- This system supports Bluetooth® security features. But depending on the operating environment and/or settings, this security is possibly not sufficient. Transmit data wirelessly to this system with caution.
- This system cannot transmit data to a Bluetooth® device.

Range of use

- Use this device at a maximum range of 10 m (33 ft). The range can decrease depending on the environment, obstacles or interference.

Interference from other devices

- This system may not function properly and troubles such as noise and sound jumps may arise due to radio wave interference if this system is located too close to other Bluetooth® devices or the devices that use the 2.4 GHz band.
- This system may not function properly if radio waves from a nearby broadcasting station, etc. is too strong.

Intended usage

- This system is for normal, general use only.
- Do not use this system near an equipment or in an environment that is sensitive to radio frequency interference (example: airports, hospitals, laboratories, etc).





“Made for iPod”, “Made for iPhone”, and “Made for iPad” mean that an electronic accessory has been designed to connect specifically to iPod, iPhone, or iPad, respectively, and has been certified by the developer to meet Apple performance standards. Apple is not responsible for the operation of this device or its compliance with safety and regulatory standards. Please note that the use of this accessory with iPod, iPhone, or iPad may affect wireless performance. AirPlay, iPad, iPhone, iPod, iPod nano, and iPod touch are trademarks of Apple Inc., registered in the U.S. and other countries. iPad Air and iPad mini are trademarks of Apple Inc.

Mac and OS X are trademarks of Apple Inc., registered in the U.S. and other countries.

Android is a trademark of Google Inc.

aptX® software is copyright CSR plc or its group companies. All rights reserved. The aptX® mark and the aptX logo are trademarks of CSR plc or one of its group companies and may be registered in one or more jurisdictions.

The Bluetooth® word mark and logos are registered trademarks owned by the Bluetooth SIG, Inc. and any use of such marks by Panasonic Corporation is under license. Other trademarks and trade names are those of their respective owners.

DLNA, the DLNA Logo and DLNA CERTIFIED are trademarks, service marks, or certification marks of the Digital Living Network Alliance.

“Direct Stream Digital”, DSD and their logos are trademarks of Sony Corporation.

MPEG Layer-3 audio coding technology licensed from Fraunhofer IIS and Thomson.

Windows and Windows Vista are either registered trademarks or trademarks of Microsoft Corporation in the United States and/or other countries.

Windows Media and the Windows logo are trademarks or registered trademarks of Microsoft Corporation in the United States and/or other countries. This product is protected by certain intellectual property rights of Microsoft Corporation and third parties. Use or distribution of such technology outside of this product is prohibited without a license from Microsoft or an authorized Microsoft subsidiary and third parties.

FLAC Decoder
Copyright (C) 2000, 2001, 2002, 2003, 2004, 2005, 2006, 2007, 2008, 2009 Josh Coalson
Redistribution and use in source and binary forms, with or without modification, are permitted provided that the following conditions are met:

- Redistributions of source code must retain the above copyright notice, this list of conditions and the following disclaimer.
- Redistributions in binary form must reproduce the above copyright notice, this list of conditions and the following disclaimer in the documentation and/or other materials provided with the distribution.
- Neither the name of the Xiph.org Foundation nor the names of its contributors may be used to endorse or promote products derived from this software without specific prior written permission.

THIS SOFTWARE IS PROVIDED BY THE COPYRIGHT HOLDERS AND CONTRIBUTORS “AS IS” AND ANY EXPRESS OR IMPLIED WARRANTIES, INCLUDING, BUT NOT LIMITED TO, THE IMPLIED WARRANTIES OF MERCHANTABILITY AND FITNESS FOR A PARTICULAR PURPOSE ARE DISCLAIMED. IN NO EVENT SHALL THE FOUNDATION OR CONTRIBUTORS BE LIABLE FOR ANY DIRECT, INDIRECT, INCIDENTAL, SPECIAL, EXEMPLARY, OR CONSEQUENTIAL DAMAGES (INCLUDING, BUT NOT LIMITED TO, PROCUREMENT OF SUBSTITUTE GOODS OR SERVICES; LOSS OF USE, DATA, OR PROFITS; OR BUSINESS INTERRUPTION) HOWEVER CAUSED AND ON ANY THEORY OF LIABILITY, WHETHER IN CONTRACT, STRICT LIABILITY, OR TORT (INCLUDING NEGLIGENCE OR OTHERWISE) ARISING IN ANY WAY OUT OF THE USE OF THIS SOFTWARE, EVEN IF ADVISED OF THE POSSIBILITY OF SUCH DAMAGE.

Limited Warranty (ONLY FOR U.S.A.)

Technics Products – Limited Warranty

Limited Warranty Coverage (For USA Only)

If your product does not work properly because of a defect in materials or workmanship, Panasonic Corporation of North America (referred to as “the warrantor”) will, for the length of the period indicated on the chart below, which starts with the date of original purchase (“warranty period”), at its option either (a) repair your product with new or refurbished parts, (b) replace it with a new or a refurbished equivalent value product, or (c) refund your purchase price. The decision to repair, replace or refund will be made by the warrantor.

Product or Part Name	Parts	Labor
Technics Stereo Integrated Amp	3 (three) years	3 (three) years
Technics Network Audio Player		
Technics Speaker System		
Technics Compact Disc Player	2 (two) years	2 (two) years

During the “Labor” warranty period there will be no charge for labor. During the “Parts” warranty period, there will be no charge for parts. This Limited Warranty excludes both parts and labor for non-rechargeable batteries, antennas, and cosmetic parts (cabinet). This warranty only applies to products purchased and serviced in the United States. This warranty is extended only to the original purchaser of a new product which was not sold “as is”.

Mail-In Service--Online Repair Request

Online Repair Request

To submit a new repair request and for quick repair status visit our Web Site at www.panasonic.com/support.

When shipping the unit, carefully pack, include all supplied accessories listed in the Owner’s Manual, and send it prepaid, adequately insured and packed well in a carton box. When shipping Lithium Ion batteries please visit our Web Site at www.panasonic.com/BatteryHandling as Panasonic is committed to providing the most up to date information. Include a letter detailing the complaint, a return address and provide a daytime phone number where you can be reached. A valid registered receipt is required under the Limited Warranty.

IF REPAIR IS NEEDED DURING THE WARRANTY PERIOD, THE PURCHASER WILL BE REQUIRED TO FURNISH A SALES RECEIPT/PROOF OF PURCHASE INDICATING DATE OF PURCHASE, AMOUNT PAID AND PLACE OF PURCHASE. CUSTOMER WILL BE CHARGED FOR THE REPAIR OF ANY UNIT RECEIVED WITHOUT SUCH PROOF OF PURCHASE.

Limited Warranty Limits and Exclusions

This warranty ONLY COVERS failures due to defects in materials or workmanship, and DOES NOT COVER normal wear and tear or cosmetic damage. The warranty ALSO DOES NOT COVER damages which occurred in shipment, or failures which are caused by products not supplied by the warrantor, or failures which result from accidents, misuse, abuse, neglect, mishandling, misapplication, alteration, faulty installation, set-up adjustments, misadjustment of consumer controls, improper maintenance, power line surge, lightning damage, modification, introduction of sand, humidity or liquids, commercial use such as hotel, office, restaurant, or other business or rental use of the product, or service by anyone other than a Factory Service Center or other Authorized Servicer, or damage that is attributable to acts of God.

THERE ARE NO EXPRESS WARRANTIES EXCEPT AS LISTED UNDER “LIMITED WARRANTY COVERAGE”.

THE WARRANTOR IS NOT LIABLE FOR INCIDENTAL OR CONSEQUENTIAL DAMAGES RESULTING FROM THE USE OF THIS PRODUCT, OR ARISING OUT OF ANY BREACH OF THIS WARRANTY.

(As examples, this excludes damages for lost time, travel to and from the servicer, loss of or damage to media or images, data or other memory or recorded content. The items listed are not exclusive, but for illustration only.) ALL EXPRESS AND IMPLIED WARRANTIES, INCLUDING THE WARRANTY OF MERCHANTABILITY, ARE LIMITED TO THE PERIOD OF THE LIMITED WARRANTY.

Some states do not allow the exclusion or limitation of incidental or consequential damages, or limitations on how long an implied warranty lasts, so the exclusions may not apply to you.

This warranty gives you specific legal rights and you may also have other rights which vary from state to state. If a problem with this product develops during or after the warranty period, you may contact your dealer or Service Center. If the problem is not handled to your satisfaction, then write to:

Consumer Affairs Department
Panasonic Corporation of North America
661 Independence Pkwy
Chesapeake, VA 23320

PARTS AND SERVICE, WHICH ARE NOT COVERED BY THIS LIMITED WARRANTY, ARE YOUR RESPONSIBILITY.

Shop Accessories!

for all your Technics gear

Go to

www.panasonic.com/accessories

Get everything you need to get the most out of your Technics products

Accessories & Parts for your Camera, Phone, A/V products, TV, Computers & Networking, Personal Care, Home Appliances, Headphones, Batteries, Backup Chargers & more...

Customer Services Directory

For Product Information, Operating Assistance, Parts, Owner’s Manuals, Dealer and Service info go to www.panasonic.com/support

For the hearing or speech impaired TTY: 1- 877-833-8855

As of October 2014

The model number and serial number of this product can be found on either the back or the bottom of the unit. Please note them in the space provided below and keep for future reference.

MODEL NUMBER ST-C700

SERIAL NUMBER _____

User memo:

DATE OF PURCHASE _____

DEALER NAME _____

DEALER ADDRESS _____

TELEPHONE NUMBER _____

Limited Warranty (ONLY FOR CANADA)

Panasonic Canada Inc.

5770 Ambler Drive, Mississauga, Ontario L4W 2T3

TECHNICS PRODUCT – LIMITED WARRANTY

Panasonic Canada Inc. warrants this product to be free from defects in material and workmanship under normal use and for a period as stated below from the date of original purchase agrees to, at its option either (a) repair your product with new or refurbished parts, (b) replace it with a new or a refurbished equivalent value product, or (c) refund your purchase price. The decision to repair, replace or refund will be made by Panasonic Canada Inc.

Technics Stereo Integrated Amp	3 (three) years parts and labour
Technics Network Audio Player	3 (three) years parts and labour
Technics Speaker System	3 (three) years parts and labour
Technics Compact Disc Player	2 (two) years parts and labour

This warranty is given only to the original purchaser, or the person for whom it was purchased as a gift, of a Technics brand product mentioned above sold by an authorized Panasonic dealer in Canada and purchased and used in Canada, which product was not sold "as is", and which product was delivered to you in new condition in the original packaging.

IN ORDER TO BE ELIGIBLE TO RECEIVE WARRANTY SERVICE HEREUNDER, A PURCHASE RECEIPT OR OTHER PROOF OF DATE OF ORIGINAL PURCHASE, SHOWING AMOUNT PAID AND PLACE OF PURCHASE IS REQUIRED

LIMITATIONS AND EXCLUSIONS

This warranty ONLY COVERS failures due to defects in materials or workmanship, and DOES NOT COVER normal wear and tear or cosmetic damage. The warranty ALSO DOES NOT COVER damages which occurred in shipment, or failures which are caused by products not supplied by Panasonic Canada Inc., or failures which result from accidents, misuse, abuse, neglect, mishandling, misapplication, alteration, faulty installation, set-up adjustments, misadjustment of consumer controls, improper maintenance, power line surge, lightning damage, modification, introduction of sand, humidity or liquids, commercial use such as hotel, office, restaurant, or other business or rental use of the product, or service by anyone other than an Authorized Servicer, or damage that is attributable to acts of God.

Dry cell batteries are also excluded from coverage under this warranty.

THIS EXPRESS, LIMITED WARRANTY IS IN LIEU OF ALL OTHER WARRANTIES, EXPRESS OR IMPLIED, INCLUDING ANY IMPLIED WARRANTIES OF MERCHANTABILITY AND FITNESS FOR A PARTICULAR PURPOSE. IN NO EVENT WILL PANASONIC CANADA INC. BE LIABLE FOR ANY SPECIAL, INDIRECT OR CONSEQUENTIAL DAMAGES RESULTING FROM THE USE OF THIS PRODUCT OR ARISING OUT OF ANY BREACH OF ANY EXPRESS OR IMPLIED WARRANTY. (As examples, this warranty excludes damages for lost time, travel to and from the Authorized Servicer, loss of or damage to media or images, data or other memory or recorded content. This list of items is not exhaustive, but for illustration only.)

In certain instances, some jurisdictions do not allow the exclusion or limitation of incidental or consequential damages, or the exclusion of implied warranties, so the above limitations and exclusions may not be applicable. This warranty gives you specific legal rights and you may have other rights which vary depending on your province or territory.

WARRANTY SERVICE

For product operation, repairs and information assistance, please visit our Support page on:

www.panasonic.ca/english/support

IF YOU SHIP THE PRODUCT TO A SERVICENTRE

Carefully pack and send prepaid, adequately insured and preferably in the original carton.
Include details of the defect claimed, and proof of date of original purchase.

Panasonic Corporation of North America

Two Riverfront Plaza, Newark, NJ 07102-5490

<http://www.panasonic.com>

Panasonic Canada Inc.

5770 Ambler Drive,
Mississauga, Ontario,
L4W 2T3

www.panasonic.com

Ⓔ