

Panasonic®

Owner's Manual

Digital Wireless Stereo Earphones

Model No. **RP-HJE120B**



If you have any questions, visit:

In the U.S.A.:
<http://shop.panasonic.com/support>
In Canada:
www.panasonic.ca/english/support

Pour toute question, visitez :

www.panasonic.ca/french/support

For U.S.A. only /

Pour les É.-U. seulement

The warranty can be found on "Basic Owner's Manual".

Register online at

<http://shop.panasonic.com/support>
(U.S. customers only)

For Canada only / Pour le Canada seulement

The warranty can be found on "Basic Owner's Manual".

La garantie se trouve dans le
« Manuel d'utilisation Fonctions de base ».

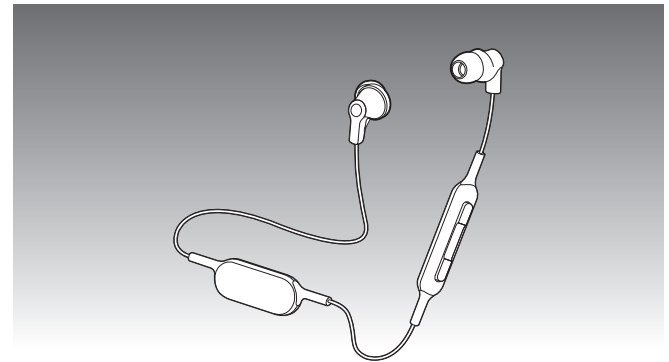

PP

TQBM0049-1

Accessories

Dear customer

Thank you for purchasing this product.
Please read these instructions carefully before using this product, and save this manual for future use.

Table of contents

Before use

Accessories	2
Safety precautions	3
Part names	4

Preparation

Charging	4
Turning the power on/off	5
Connecting a Bluetooth® device	5
How to wear the earphones	6

Operation

Listening to music	6
Making a phone call	7
Useful functions	7

Other

Restoring to the factory settings	7
Maintenance	8
Copyright, etc.	8
About Bluetooth®	8
Troubleshooting guide	9
Specifications	10
Useful information	10
To remove the battery when disposing of this unit	11

Please check and identify the supplied accessories.

Only for U.S.A.:

To order accessories, refer to “Limited Warranty” on “Basic Owner’s Manual”.

Only for Canada:

To order accessories, contact the dealer from whom you have made your purchase.

- 1 USB charging cord



- 1 Earpieces set (L, S)



- M-size earpieces are attached at the time of purchase.

Safety precautions

■ Unit

- Avoid using or placing this unit near sources of heat.
- Do not use while operating a motorized vehicle. It may create a traffic hazard and is illegal in many areas.
- Do not listen with this unit at high volume in places where you need to hear sounds from the surrounding environment for safety, such as at railroad crossings, and construction sites.

■ Earpieces

- Keep the earpieces out of reach of children to prevent swallowing.
- Securely attach the earpieces. If they are left in the ears after coming off, injury or sickness may be caused.

■ Allergies

- Discontinue use if you experience discomfort with the earphones or any other parts that directly contact your skin.
- Continued use may cause rashes or other allergic reactions.

■ USB

- Do not use any other USB charging cords except the supplied one.

Caution: Use only the supplied USB charging cord when connecting to a computer.

THE FOLLOWING APPLIES ONLY IN THE U.S.A. AND CANADA.

This device complies with Part 15 of FCC Rules and Industry Canada's licence-exempt RSSs. Operation is subject to the following two conditions: (1) this device may not cause interference, and (2) this device must accept any interference, including interference that may cause undesired operation of this device.

FCC ID : ACJ-RP-HJE120B

Model : RP-HJE120B

IC : 216A-HJE120B

This transmitter must not be co-located or operated in conjunction with any other antenna or transmitter.

This equipment complies with FCC/IC radiation exposure limits set forth for an uncontrolled environment and meets the FCC radio frequency (RF) Exposure Guidelines and RSS-102 of the IC radio frequency (RF) Exposure rules. This equipment has very low levels of RF energy that is deemed to comply without testing of specific absorption ratio (SAR).

THE FOLLOWING APPLIES ONLY IN THE U.S.A.

FCC Note:

This equipment has been tested and found to comply with the limits for a Class B digital device, pursuant to Part 15 of the FCC Rules.

These limits are designed to provide reasonable protection against harmful interference in a residential installation. This equipment generates, uses, and can radiate radio frequency energy and, if not installed and used in accordance with the instructions, may cause harmful interference to radio communications. However, there is no guarantee that interference will not occur in a particular installation. If this equipment does cause harmful interference to radio or television reception, which can be determined by turning the equipment off and on, the user is encouraged to try to correct the interference by one or more of the following measures:

- Reorient or relocate the receiving antenna.
- Increase the separation between the equipment and receiver.
- Connect the equipment into an outlet on a circuit different from that to which the receiver is connected.
- Consult the dealer or an experienced radio/TV technician for help.

Any unauthorized changes or modifications to this equipment would void the user's authority to operate this device.

This device complies with Part 15 of the FCC Rules. Operation is subject to the following two conditions: (1) This device may not cause harmful interference, and (2) this device must accept any interference received, including interference that may cause undesired operation.

Responsible Party: Panasonic Corporation of North America
Two Riverfront Plaza, Newark, NJ 07102-5490

Support Contact: <http://shop.panasonic.com/support>

FCC CAUTION

Any changes or modifications not expressly approved by the party responsible for compliance could void the user's authority to operate this equipment.

Operation is subject to the following two conditions:

(1) This device may not cause harmful interference, and (2) this device must accept any interference received, including interference that may cause undesired operation.

THE FOLLOWING APPLIES ONLY IN CANADA.

CAN ICES-3(B)/NMB-3(B)

Part names

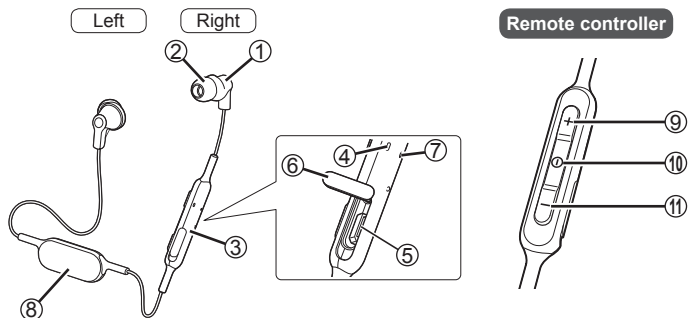

① Earphone

② Earpiece

③ Remote controller

④ LED indicator light*

- The number of blinks or color notifies the status of the unit.
(* hereafter referred to as "LED")

⑤ Charging terminal (DC IN)

- Open the USB lid and connect the USB charging cord (supplied) to this terminal when charging. (See "Charging")

■ Note

- Excessive sound pressure from earphones and headphones can cause hearing loss.
- Listening at full volume for long periods may damage the user's ears.
- Do not use any other USB charging cords except the supplied one.
- When using the unit, do not cover the remote controller with the palm of your hand. The Bluetooth® connection may be blocked.

To avoid product damage, do not expose this product to rain, sweat, water or other liquids.

⑥ USB lid

⑦ Microphone

⑧ Battery case

- (Please remove the battery when disposing of this product. → P. 11)

⑨ Volume + / Next

⑩ Power / Pairing / Play / Pause / Call ①

⑪ Volume - / Previous

Charging

The rechargeable battery (installed in the unit) is not charged initially. Charge the battery before using the unit.

1 Connect this unit to a computer using the USB charging cord

- Within approximately 3 seconds after the connection is established, the LED on the remote controller will light in red.
- The LED lights in red when charging is in progress. When charging is completed, the LED will go out.
- Charging will take approximately 1.5 hours from empty state to fully charged. (Quick charging time for 60 minutes operation: Approx. 20 minutes)

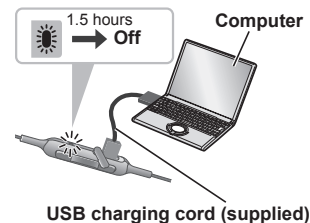

2 Close the charging terminal cover securely

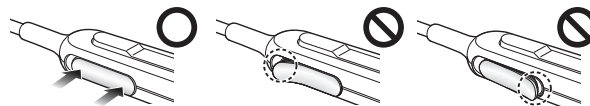

■ Do not touch the charging terminal with wet hand

- If sweat or liquid is attached to the charging terminal, malfunction may occur.

■ Note

- The Bluetooth® feature cannot be used when this unit is connected to a computer using the USB charging cord.
- Charge in a room temperature of between 10 °C and 35 °C (50 °F and 95 °F).
- If PC used for charging enters "sleep mode", charging may not take place.

The product illustrations may differ from the actual product.

Turning the power on/off

1 Press and hold the power of this unit for approx. 3 seconds until the LED (blue) blinks

- A beep will sound, and the LED (blue) on the remote controller will blink slowly.

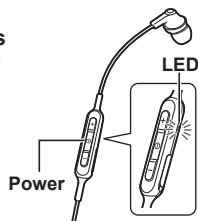

To turn the power off

- Press and hold  for approximately 3 seconds. A beep will sound and the power will be turned off.

■ Note

- When the unit is not operated for approximately 5 minutes, the power will automatically turn off. (See “Auto power off” (→ P. 7))

Connecting a Bluetooth® device

Preparation

- Place the Bluetooth® device within approx. 1 m (3.3 feet) from the unit.
- Check the device operation using its operation instructions as required.

Pairing (Registration) this unit with the Bluetooth® device for connection

1 Press and hold the power button of this unit until the LED blinks

When pairing a device for the first time : approx. 3 seconds
When pairing a second or subsequent devices : approx. 5 seconds

- The unit starts to search for the Bluetooth® device for connection, and the LED will blink in blue and red alternately.

2 Turn on the power of the Bluetooth® unit, and enable the Bluetooth® function

3 Select “RP-HJE120B” from the Bluetooth® device’s menu

- The MAC address “□□□□□□” (“□” stands for a character that is unique to each set.) may be displayed before “RP-HJE120B” is displayed.
- If prompted for a passkey, input the passkey “0000 (four zeros)” of this unit.

4 Check the connection with the Bluetooth® device on the unit

- The LED will blink in blue and red alternately until the connection with the device is completed. When an electronic sound beeps and the LED (blue) blinks twice every approx. 2 seconds, pairing (registration) is completed. (Connection established)

(Ex.)

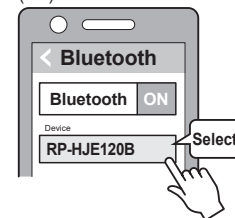

■ Note

- If connection to a device is not established within approximately 5 minutes, the unit will be turned off. Perform pairing again.
- You can pair up to 8 Bluetooth® devices with this unit. If a 9th device is paired, the device with the oldest connection will be replaced. To use it, perform pairing again.

Connecting a paired Bluetooth® device

1 Turn on the unit

- Press and hold the power button of this unit for approx. 3 seconds until the LED (blue) blinks.
- A beep will sound, and the LED (blue) will blink slowly.

2 Perform steps 2 and 3 of “Pairing (Registration) this unit with the Bluetooth® device for connection” (→ P. 5)

- When the LED (blue) blinks twice every approx. 2 seconds, pairing (registration) is completed. (Connection established)

■ Note

- This unit remembers the device lastly connected. Connection may be automatically established after step 1 (see above).
- If connection to a device is not established within approximately 5 minutes, the unit will be turned off. Perform pairing again. (→ P. 5)

How to wear the earphones

The left earphone has the marking point as shown in the illustration.



■ Attention

- M-size earpieces are attached at the time of purchase. If they are not the right size, replace them with S or L-size earpieces (supplied).

Listening to music

If the Bluetooth® compatible device supports the “A2DP” and “AVRCP” Bluetooth® profiles, music can be played back with remote control operations on the unit.

- **A2DP** (Advanced Audio Distribution Profile): Transmits audio to the unit.
- **AVRCP** (Audio/Video Remote Control Profile): Allows remote control of the device using the unit.

1 Connect the Bluetooth® device and the unit (→ P. 5)

2 Select and play the music on the Bluetooth® device

- The selected music is output to the earphones of the unit.

Operating time of battery

Battery type	Operating time
Rechargeable battery (installed in the unit)	Approx. 4 hours 20 minutes

Operating time may be less depending on the operating conditions.

■ Attention

- The unit might leak sound depending on the volume level.
- When the volume is increased to near maximum level, music may sound distorted. Decrease the volume until the distortion is cleared.

Remote controlling

You can control the Bluetooth® device using the unit.

- Depending on Bluetooth® devices, some functions below do not work, or work differently via operation of the unit.

(Operation example)

Play / Pause / Call		
①	Press	Play / Pause / Call
	Press twice quickly	Reject the incoming call / Switch the calling device

Previous / Next / Volume		
+	Press	Increase the volume
	Press and hold	Forward to the start of next track
-	Press	Decrease the volume
	Press and hold	Return to the start of current track

Remote controller

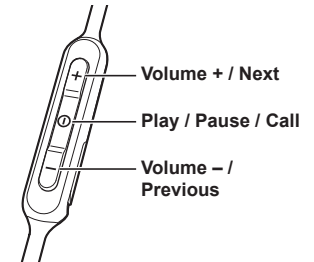

■ Note

- The volume can be adjusted in 15 levels.
- When the maximum or minimum volume is reached, a beep will sound.
- “Increase/Decrease the volume” function is not available while pause.

Making a phone call

With Bluetooth® enabled phones (cell phones or smartphones) that support the “HSP” or “HFP” Bluetooth® profile, you can use the unit for phone calls.

• HSP (Headset Profile):

This profile can be used to receive monaural sounds and establish two-way communication using the microphone on the unit.

• HFP (Hands-Free Profile):

In addition to the HSP functions, this profile has the incoming and outgoing calls function.

1 Connect the Bluetooth® enabled phone and unit

2 When answering an incoming call

Press **⓪** on the unit and answer the call

- During an incoming call, ringtone will sound from the earphones and the LED will blink.
- (HFP only) To reject the incoming call, press **⓪** twice quickly until the ringtone stops.

Remote controller

Call

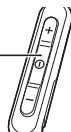

When making an outgoing call

Make an outgoing call on the Bluetooth® enabled phone

- Also refer to the operating manual for the Bluetooth® enabled phone.

(Checking and operation steps on the unit are explained below)

- During an outgoing call, ringtone will sound from the earphones and the LED will blink.
- To cancel the outgoing call, press **⓪**. A beep will sound.

3 Start talking

- The LED will repeatedly blink 2 times during a call.
- The volume can be adjusted during a phone call. For setting instructions, see “Remote controlling”. (→ P. 6)

4 Press **⓪** to end the phone call

- A beep will sound.

■ Note

- There may be instances when hands free setting needs to be done on the Bluetooth® enabled phone.
- Depending on the Bluetooth® enabled phone, you may hear incoming and outgoing call ringtones of the phone from the unit.
- (HFP only) Press **⓪** twice quickly on the unit. The calling device will be switched between the Bluetooth® enabled phone and the unit.

Useful functions

Resetting the unit

This unit can be reset when all operations are rejected. To reset the unit, push **⓪** button for 10 seconds. All the previous operations will be canceled. (The pairing device information will not be deleted.)

Auto power off

If the unit is silent for approximately 5 minutes and operations for Bluetooth® devices are idle during that period, a beep will sound and the power will be automatically turned off.

LED indicator light

When the battery level is low during use of the unit, the blue blinking LED on the remote controller will change to red. A beep will sound every 1 minute. When the battery runs out, the power will turn off.

Restoring to the factory settings

When you want to delete all pairing device information, etc., you can restore the unit to the factory settings (original settings upon purchase). Charge the battery before restoring the unit.

1 Turn the power off, and press and hold **⓪** for approximately 5 seconds

- Start searching for Bluetooth® devices to connect.

2 Press and hold + and - for 5 seconds or more simultaneously while searching

- The LED will blink fast in blue. The unit will restore to the factory settings.

■ Attention

- When pairing a device again, delete the registering information (Device: “RP-HJE120B”) from the Bluetooth® device’s menu, and register this unit with the Bluetooth® device again. (→ P. 5)

Maintenance

Clean this unit with a dry and soft cloth.

- Do not use solvents including benzene, thinner, alcohol, kitchen detergent, a chemical wiper, etc. This might cause the exterior case to be deformed or the coating to come off.

Keeping the battery performance

- During the long period of disuse, full charge this unit once every 6 months to keep the battery performance.

Copyright, etc.

- The Bluetooth® word mark and logos are registered trademarks owned by Bluetooth SIG, Inc. and any use of such marks by Panasonic Corporation is under license. Other trademarks and trade names are those of their respective owners.
- Other system names and product names appearing in this document are in general the registered trademarks or trademarks of the respective developer companies. Note that the ™ mark and ® mark do not appear in this document.

The serial number of this product can be found on the tag.

Please note them in the space provided below and keep for future reference.

MODEL NUMBER **RP-HJE120B**

SERIAL NUMBER _____

User memo:

DATE OF PURCHASE _____

DEALER NAME _____

DEALER ADDRESS _____

TELEPHONE NUMBER _____

About Bluetooth®

Panasonic bears no responsibility for data and/or information that is compromised during a wireless transmission.

■ Frequency band used

This unit uses the 2.4 GHz frequency band.

■ Certification of this unit

- This unit conforms to frequency restrictions and has received certification based on frequency laws. Thus, a wireless permit is not necessary.
- The actions below are punishable by law in some countries:
 - Taking apart/modifying the unit.
 - Removing specification indications.

■ Restrictions of use

- Wireless transmission and/or usage with all Bluetooth® equipped devices is not guaranteed.
- All devices must conform to standards set by Bluetooth SIG, Inc.
- Depending on the specifications and settings of a device, it can fail to connect or some operations can be different.
- This system supports Bluetooth® security features. But depending on the operating environment and/or settings, this security may not be sufficient. Transmit data wirelessly to this system with caution.
- This system cannot transmit data to a Bluetooth® device.

■ Range of use

Use this unit at a maximum range of 10 m (33 feet).

The range can decrease depending on the environment, obstacles or interference.

■ Interference from other devices

- This unit may not function properly and troubles such as noise and sound jumps may arise due to radio wave interference if this unit is located too close to other Bluetooth® devices or the devices that use the 2.4 GHz band.
- This unit may not function properly if radio waves from a nearby broadcasting station, etc. is too strong.

■ Intended usage

- This unit is for normal, general use only.
- Do not use this system near an equipment or in an environment that is sensitive to radio frequency interference (example: airports, hospitals, laboratories, etc.).

Troubleshooting guide

Before requesting service, make the following checks. If you are in doubt about some of the check points, or if the remedies indicated in the chart do not solve the problem, refer to "Customer Services Directory" on "Basic Owner's Manual" if you reside in the U.S.A., or refer to "CONTACT INFORMATION" on "Basic Owner's Manual" if you reside in Canada.

General

The unit does not respond

- Push **⏻** button for 10 seconds. The unit will be reset.
(The pairing device information will not be deleted.)

Power supply and charging

If you are having difficulty charging the unit

- Make sure the computer is turned on and is not on standby or sleep mode.
- Is the USB port you are currently using working properly? If your computer has other USB ports, unplug the connector from its current port and plug it into one of the other ports.
- If the steps mentioned above are not applicable, unplug the USB charging cord and plug it in again.
- If the charge time and operating time become shortened, the battery may have run down. (Number of charging times of the installed battery: Approximately 300.)

Charging takes longer

- Charge in a room temperature of between 10 °C and 35 °C (50 °F and 95 °F).

LED does not light during charging

- Is the USB charging cord (supplied) connected firmly to the USB terminal of the computer? (→ P. 4)

The power does not turn on

- Is the unit being charged? The power cannot be turned on during charging.
(→ P. 4)

Bluetooth® device connection

The device cannot be connected

- Delete the pairing information for this unit from the Bluetooth® device, then pair them again. (→ P. 5)

Sound and audio volume

No sound

- Make sure that the unit and the Bluetooth® device are connected correctly.
(→ P. 5)
- Check if music is playing on the Bluetooth® device.
- Make sure that the unit is turned on and the volume is not set too low.
- Pair and connect the Bluetooth® device and the unit again. (→ P. 5)

Low volume

- Increase the volume of the unit. (→ P. 6)
- Increase the volume on the Bluetooth® device.

Sound from the device is cut off / Sound quality is bad

- Sound may be disrupted if signals are blocked. Do not fully cover this unit with the palm of your hand, etc.
- The device may be out of the 10 m (33 feet) communication range. Move the device closer to this unit.
- Remove any obstacle between this unit and the device.
- Switch off any wireless LAN device when not in use.
- A communication problem may arise if the battery is not fully charged. Charge the unit. (→ P. 4)

Phone calls

You cannot hear the other person

- Make sure that the unit and the Bluetooth® enabled phone are turned on.
- Check if the unit and the Bluetooth® enabled phone are connected. (→ P. 5)
- Check the audio settings of the Bluetooth® enabled phone. Switch the calling device to the unit if it is set to the Bluetooth® enabled phone. (→ P. 5)
- If the volume of the other person's voice is too low, increase the volume of both the unit and the Bluetooth® enabled phone.

Specifications

■ General

Power supply	DC 5 V, 0.6 W (Internal battery: 3.7 V (Li-polymer 90 mAh))
Operating time*1	Approx. 4 hours 20 minutes
Charging time*2 (25 °C (77 °F))	Approx. 90 minutes
Charging temperature range	10 °C to 35 °C (50 °F to 95 °F)
Operating temperature range	0 °C to 40 °C (32 °F to 104 °F)
Operating humidity range	35%RH to 80%RH (no condensation)
Mass (Weight)	Approx. 12 g (0.4 oz)

*1 It may be shorter depending on the operating conditions.

*2 Time taken to recharge from empty to full.

■ Bluetooth® section

Bluetooth® system specification	Ver. 4.1
Wireless equipment classification	Class 2 (2.5 mW)
Frequency band	2402 MHz to 2480 MHz
Max RF power	4 dBm (EIRP)
Supported profiles	A2DP, AVRCP, HSP, HFP
Supported codec	SBC
Operating distance	Up to 10 m (33 ft.)

■ Speaker section

Driver units	9 mm (3/8 in.)
--------------	----------------

■ Terminal section

DC IN	DC 5 V, 0.6 W
-------	---------------

■ Microphone section

Type	Mono
------	------

■ Accessory section

USB charging cord	0.1 m (0.3 ft.)
Earpieces set	L, S

● Specifications are subject to change without notice.

Useful information (For Latin American Countries Only)

Customer Service

Customer Service Directory

Obtain products information and operative assistant; localize the closer distributor or Service Center; buy spare parts and accessories by our Web Site to Latin American:

COUNTRY	WEB SITE	CONTACT CENTER
Panama	www.panasonic.com/pa/soporte/	800-7262
Colombia	www.panasonic.com/co/soporte/	01-8000-947262
Ecuador	www.panasonic.com/ec/soporte/	1-800-726276
Costa Rica	www.panasonic.com/cr/soporte/	800-7262737
El Salvador	www.panasonic.com/sv/soporte/	800-7262
Guatemala	www.panasonic.com/gt/soporte/	1-801-811-7262
Uruguay	www.panasonic.com/uy/soporte/	0-800-7262
Paraguay	www.panasonic.com/uy/soporte/	0-800-11-7262
Chile	www.panasonic.com/cl/soporte/	800-390-602 022-797-5000
Peru	www.panasonic.com/pe/soporte/	0800-00726
Venezuela	www.panasonic.com/ve/soporte/	800-7262-800
Mexico	www.panasonic.com/mx/soporte/	01800-847-7262 55-5000-1200
Argentina	www.panasonic.com/ar/soporte/	0800-333-7262 0810-321-7262
Dominican Republic	www.panasonic.com/do/soporte/	809-200-8000

To remove the battery when disposing of this unit

1

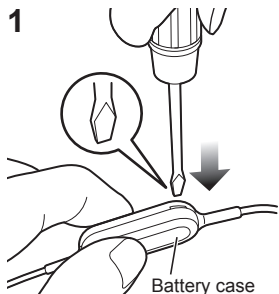

2

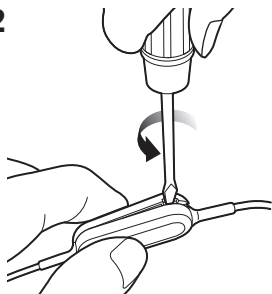

3

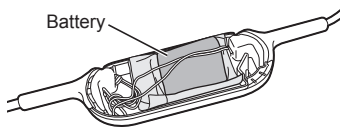

4

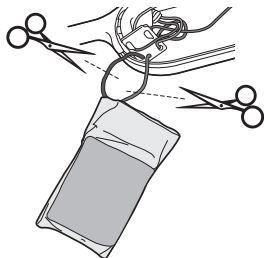

The following instructions are not intended for repairing purposes but for the disposal of this unit. This unit is not restorable once disassembled. When disposing of this unit, take out the battery installed in this unit and recycle it.

Danger

As the rechargeable battery is specifically for this product, do not use it for any other device.

Do not charge the removed battery.

- Do not heat or expose to flame.
 - Do not leave the battery(ies) in a car exposed to direct sunlight for a long period of time with doors and windows closed.
 - Do not pierce the battery with a nail, subject it to an impact, or dismantle or modify it.
 - Do not let the wires touch any other metal or each other.
 - Do not carry or store the battery with a necklace, hair pin, or the like.
- Doing so may cause the battery to generate heat, ignite, or rupture.

Warning

Do not place the removed battery, and other items within reach of infants.

Accidental swallowing of such an item may have an adverse effect on the body.

- In the event that you think such an item has been swallowed, consult a doctor immediately.

In the event of fluid leaking from the battery, take the following measure, and do not touch the fluid with bare hands.

Fluid entering into an eye may cause loss of eyesight.

- Wash the eye with water immediately without rubbing it, and then consult a doctor.
- Fluid getting on your body or clothes may cause inflammation of the skin or injury.
- Sufficiently rinse with clean water, and then consult a doctor.

A lithium-ion polymer rechargeable battery is built in to the battery case. Please discard according to local regulations.

When disposing this product, disassemble properly by following the procedure, and remove the internal rechargeable battery.

- Disassemble after the battery runs out.
- When disposing of the battery, please contact your local authorities or dealer and ask for the correct method of disposal.

1 Put a straight-slot screwdriver (commercially available) into the battery case.

- Make sure to keep fingers away from the tip of the screwdriver.
- Select a screwdriver to be large enough for a space under the joint part.

2 Use the screwdriver for leverage, push and open the battery case.

- Be careful not to touch the battery with the screwdriver.

3 Hold the battery and remove it.

4 Pull off the battery and separate it from the battery case by cutting off the wires, one by one, with scissors.

- Insulate the wire parts of the removed battery with cellophane tape.
- Do not damage or dismantle the battery.



(For US and Canada only)

A lithium ion battery that is recyclable powers the product you have purchased. Please call 1-800-8-BATTERY for information on how to recycle this battery.

Panasonic Corporation of North America
Two Riverfront Plaza, Newark, NJ 07102-5490

<http://shop.panasonic.com/>

Panasonic Canada Inc.
5770 Ambler Drive, Mississauga, Ontario L4W 2T3

www.panasonic.com

© Panasonic Corporation 2017

En

TQBM0049-1
M0317KZ1067