

Panasonic[®]

**Owner's Manual
Manuel d'utilisation
使用説明書**

**Convection Steam Oven
Four à convection et à vapeur
純蒸氣烤焗爐**

**Household Use Only
Pour usage domestique seulement
僅家庭用**



**Model No.
N° de modèle
型號:** **NU-SC180B**

**Important safety instructions
Read carefully and keep for future reference
Importantes mesures de sécurité
Lire attentivement et conserver pour référence future
重要安全措施
仔細閱讀並妥善保存**

Table of Contents

English

| | |
|---|-------|
| Important Safety Instructions..... | 2-3 |
| Precautions for Placement and Cooking | 3-4 |
| Heating Principle | 5 |
| Cooking Techniques | 6 |
| Food Characteristics..... | 6 |
| Feature Diagram..... | 7-8 |
| Cookware and Utensil Guide..... | 9 |
| Control Panel..... | 10-11 |
| Steam Setting | 12 |
| Stew Setting | 13 |
| Healthy Fry Setting..... | 14 |
| Fermentation Setting | 15 |
| Convection Setting | 16-17 |
| Steam Convection Setting..... | 18-19 |
| Steam Shot Setting..... | 20 |
| One Push Setting | 21 |
| Child Safety Lock Setting | 22 |
| Auto Cook Setting and Menus..... | 23-36 |
| Reheating Chart | 37 |
| Cooking Chart..... | 38-39 |
| Cleaning (Utensils)..... | 40 |
| Cleaning (Feeding Bottles)..... | 41 |
| Oven Cleaning Setting..... | 42-45 |
| Cleaning (Deodorization)..... | 42 |
| Cleaning (Cavity)..... | 43 |
| Cleaning (System)..... | 44 |
| Cleaning (with Citric Acid) | 45 |
| Care of Your Oven..... | 46 |
| Before Requesting Service..... | 47-49 |
| WARRANTY | 50 |
| Specifications | 51 |

Important Safety Instructions

English

Read the manual carefully and keep it properly.

Precautions for using this product for cooking Check whether the product is damaged.

Please inspect your oven as follows before using:

1. The oven door and the oven cavity are not damaged or cracked. If they are damaged or cracked, do not use.
2. The oven must be grounded before use. In case of electric leakage, the ground can provide a current loop to avoid electric shock. The power supply plug must be inserted into a single-phase bipolar socket with grounding.
3. Read this manual carefully before using the appliance. The oven can only be used for the purposes indicated in this manual.

Prevention Items

Forbidden items

1. In the event that the oven door or door seal has been damaged, do not use the oven until a qualified technician has repaired it.
2. Do not damage the safety lock of the oven door, including the door hinges.
3. This appliance is not intended for use by persons (including children) with reduced physical, sensory or mental capabilities, or lack of experience and knowledge, unless they have been given supervision or instruction concerning use of the appliance by a person responsible for their safety.
4. Children should be supervised to ensure that they do not play with the appliance.
5. Except for a qualified technician, repair is very dangerous. Do not attempt to disassemble, repair or modify the oven yourself.
6. When the oven works abnormally, do not continue using it.
7. Once finding any crack or notch on the water tank, do not use the product, as water leakage can lead to electric leakage or electric shock.
8. When the socket hole gets loose or the power supply cord or plug is damaged, do not use the product. If the supply cord is damaged, it must be replaced by manufacturers, its service agent or similarly qualified persons in order to avoid a hazard.
9. Do not use a wet hand to press or insert/remove the power supply plug; otherwise an electric shock may be caused.
10. Do not knock on parts such as the control panel, housing, oven cavity and oven door; otherwise it may lead to product failure.
11. Do not place the product and power supply cord in damp places with high temperatures, e.g., near a gas stove, electrified area or sink.

12. The oven is used for household cooking only and may not be used for laboratory tests or other commercial purposes. Moreover, the product cannot be placed in a cupboard for use.
13. Do not use a rough scrubbing tool or sharp metal scraper to clean the oven window; otherwise the glass will be ruptured.
14. Appliances are not intended to be operated by means of an external timer or separate remote-control system.
15. Do not block the air inlet and outlet; otherwise a fire maybe caused. Please clean the product regularly to prevent the air inlet and outlet from being blocked by foreign matter and dust.

Dangerous Items

1. Do not place inflammable materials around the oven or in the oven cavity; otherwise a fire may be caused.
2. Upon finding smoke, turn off the appliance or remove the power supply plug and make sure that the oven door is closed to prevent spreading fire. Press **Stop/Reset** button, and then remove the power supply plug or turn off the general power switch in the room.
3. Do not use the product for purpose not mentioned in the manual, e.g., using the product to dry articles; otherwise a fire may be caused.
4. If the product is not cleaned regularly, the appliance surface will be degraded to affect the appliance service life and dangers may occur.
5. Avoid actions or behavior that may damage the power supply cord and power supply plug, e.g., immersing the power supply cord and power supply plug into water, keeping the power supply cord at a position at a high temperature, or forcedly bending, twisting, pressing or binding the power supply cord. A damaged power supply cord or plug may lead to dangers such as short circuit, electric shock and fire. Do not immerse the appliance in water.

Safety Precautions

1. The oven surface may become very hot during and after use. The temperature at the housing surface, air outlet, oven door and oven cavity are relatively high. Do not press these parts; otherwise you maybe scalded. Young children should be kept away.
2. If white smoke appears when the convection function is used for the first time, it does not indicate a fault. The protective oil of components is volatilized to generate white smoke due to heating.
3. The vessel and food temperatures are very high when you stir or turn over the food during cooking or take food out after the cooking. Please use insulation gloves or a pot clip to prevent scalding.

Important Safety Instructions

(continued)

4. If you need to open the oven door to stir, turn over or rearrange food in the process of using steam, note to keep a distance; otherwise steam may scald your face or hands.
5. When the oven door is open, do not drag the container along the oven door. The weight borne by the oven door cannot exceed 4 kg.

Instruction Items

1. Before using vessels of different materials, first confirm whether the vessels can withstand high temperature. When the food is cooked in a plastic or paper package, please watch it, as it could catch fire.
2. Food must be placed in a proper vessel and cannot be directly placed in the oven cavity for cooking.
3. The surface temperature and internal temperature of the oven are very high after cooking. Do not clean it immediately after cooking. Be sure to clean the product after it cools down; otherwise you may be scalded.
4. Remove the power supply plug before cleaning. Do not use a corrosive cleaning agent; otherwise it will damage or corrode the product.
5. Clean dust from the power supply plug on a regular basis. If the product will not be used for a long time, remove the power supply plug. Do not pull the power supply cord as remove the power supply plug: hold the plug to remove it.

Precautions for Placement and Cooking

Placement of Oven

1. The product must be placed at a position more than 91.6 cm height from the ground. In normal use, good ventilation must be ensured around the product. Allow 20 cm of space on the top of the oven, reserve a gap not smaller than 5 cm from the right wall, a gap not smaller than 5 cm from the left wall and a gap not less than 10 cm from the back wall. Do not block the ventilation opening. Keep the environment clean and prevent roaches and other insects from entering the product.
 - (a) Do not block the air inlet and outlet; otherwise a fire may be caused. Maintain the product regularly and prevent foreign matter and dust from blocking the air inlet and outlet.
 - (b) Do not position the product at a damp place with high temperatures, e.g., near a gas stove, electrified area or sink.
 - (c) The product must be placed level.
 - (d) Do not remove the legs. Place the product in a solid position.
 - (e) Do not put a heavy load on the oven door or top.
 - (f) The product cannot be used if the indoor humidity is too high.
2. This product is for household use only. This oven is intended for Counter-top use only. It is not intended for built-in use or use inside a cupboard. The oven shall not be placed in a cabinet.
3. Do not use the cavity for storage purposes.

Power Supply

1. A short power-supply cord is provided to reduce the risks resulting from becoming entangled in or tripping over a longer cord.

2. Longer cord sets or extension cords may be used if care is exercised in their use. DO NOT let cord hang over edge of a table or counter.
3. If a long cord or extension cord is used,
 - The marked electrical rating of the cord set or extension cord should be at least as great as the electrical rating of the appliance.
 - The extension cord must be a grounding-type 3-wire cord.

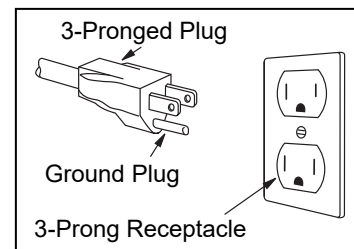

- The longer cord should be arranged so that it will not drape over the counter top or tabletop where it can be pulled on by children or tripped over accidentally.

Grounding Instructions

THIS APPLIANCE MUST BE GROUNDED.

In the event of an electrical short circuit, grounding reduces the risk of electric shock by providing an escape wire for the electric current. This appliance is equipped with a cord having a grounding wire with a grounding plug. The plug must be plugged into an outlet that is properly installed and grounded.

- **Plug into properly installed and grounded three-prong outlet.**
- **DO NOT** remove ground prong.
- **DO NOT** use an adapter.

English

Precautions for Placement and Cooking (continued)

English

Wiring Requirements

1. The oven must be operated on a SEPARATE CIRCUIT. No other appliance should share the circuit with the oven.
If it does, the branch circuit fuse may blow or the circuit breaker may trip.
2. The oven must be plugged into at least a 15 A or 20 A, 120 V, 60 Hz GROUNDED OUTLET. (Beginning in 2017, all new construction and all renovated single family homes must have at least a 20 A, 120 VOLT, 60 Hz GROUNDED OUTLET). Where a standard two-prong outlet is encountered, it is the personal responsibility and obligation of the consumer to have it replaced with a properly grounded three-prong outlet.
3. The VOLTAGE used must be the same as specified on this oven (120 V, 60 Hz). Using a higher voltage is dangerous and may result in a fire or oven damage. Using a lower voltage will cause slow cooking. Panasonic is NOT responsible for any damages resulting from the use of the oven with any voltage other than specified.

Precautions for cooking

1. Cautiously take out heated liquid foods such as soups, sauces and beverages. Pay attention to the following items during cooking:
 - (a) Prevent over-heating; otherwise the liquid may suddenly boil and splash to scald you when you take out the food.
 - (b) When you heat liquid food, the liquid should be loaded to at least eighty percent of the container capacity; otherwise a small amount of heated liquids may suddenly splash due to boiling.
 - (c) Stir the food before or during the heating.
 - (d) After heating, keep the food in the oven for a while, stir it slightly, and then take it out.

- (e) After you use a milk bottle or heat baby food, stir the food or shake the bottle, and check the temperature before feeding your baby so that he or she may not be hurt.
2. Using a common thermometer is forbidden. You must use a meat thermometer to check the cooking effect. If cooking is insufficient, place the food into the oven again for further cooking.
 3. Cooking recipes provide the cooking time for reference. A lot of factors may affect the cooking time, including the desired degree of cooking, starting temperature, portion, size, food shape and container type. If you are familiar with product operations, you can properly adjust the cooking time by referring to the above factors.
 4. When using the convection function, you must control the cooking time and pay attention to the heated food all times. Over-heated food may lead to smoke or fire.

Exterior oven surfaces, including air vents on the cabinet and the oven door will get hot during Convection. Use care when opening or closing door and inserting or removing food and accessories.

Caution! Hot surfaces



Fan Motor Operation

After using the oven, the fan may rotate to cool the electric components and “” rotates in the display window. You can take out the food from the oven while the fan operates. It is recommended to keep the oven plugged in until the Fan Motor completely stops operating.

Warning

- (a) In the event that the oven door or door seal has been damaged, do not use the oven until a qualified technician has repaired it. Do not damage the safety lock of the oven door, including the door hinges. To repair the product, please contact an authorized Service Center by Panasonic.
- (b) Except for a qualified technician, repair work is very dangerous. Do not attempt to disassemble, repair or modify the oven yourself.
- (c) Do not allow children or someone without knowledge of oven operation to use the oven in an unattended manner unless they get proper instructions on use and know that any improper operation may lead to danger.
- (d) Do not use a rough scrubbing tool or sharp metal scraper to clean the oven door glass; otherwise the glass will be ruptured.

Heating Principle

The diagrams shown below are examples of the accessories placements of various cooking modes. It may vary depending on the recipe/dish used.

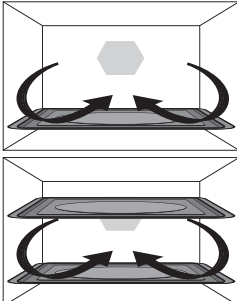
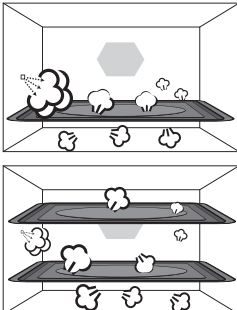
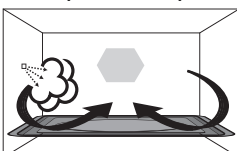
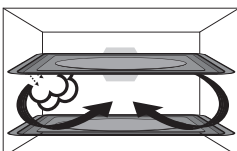
| Cooking modes | Principle and Types Uses | Caution | Placement |
|--|---|--|---|
| <p>Convection, Fermentation, Healthy Fry</p>  | <p>Use the convection heater for heating.</p> <ul style="list-style-type: none"> • Baking pastries like puff, swiss rolls and pizza, etc. • Roasting meat and poultry, etc. • Fermentation and making yoghurt. • Frying thin foods with high temperature, such as shrimp, fish and chicken pieces, etc. <p>Preheat advised (without fermentation)</p> | <p>Take food out immediately after heating; otherwise the residual heat will deepen the browning color. To maintain the temperature in the oven during heating, do not open and close the oven door in the heating process. To uniform browning color, you can readjust the food position or rotate the metal tray midway.</p> | <p>One level cooking: lower shelf position Two levels cooking: upper and lower shelf position</p> |
| <p>Steam-Med</p>  | <p>Steam is used for heating to complete cooking.</p> <ul style="list-style-type: none"> • Steaming various seafood, poultry, meat, vegetables, rice, and Chinese desserts. | <p>Since steam is generated during cooking, the cover (plastic wrap) cannot be used in the heating process. For individual dishes that require the plastic wrap, see the recipes.</p> | <p>One level cooking: lower shelf position Two levels cooking: upper and lower shelf position</p> |
| <p>Stew, Steam-High, Steam Convection (One level)</p>  <p>Steam-High, Steam Convection (Two levels)</p>  | <p>Steam combines convection heater to cooking.</p> <ul style="list-style-type: none"> • Stew soup and meat. • Bake soft cakes, souffle etc. • Bake soft meat such as teriyaki chicken pieces etc. <p>• Steam-High can be used to cook meat and seafood etc at a faster speed</p> <p>• Preheat advised for Steam Convection</p> | <p>Cooking can remain higher temperature and lock the food moisture. It is recommended to use heatproof soup bowl with 1000 ml volume and cover with lid when using Stew function.</p> | <p>One level cooking: lower shelf position Two levels cooking: upper and lower shelf position</p> |

Cooking Techniques

Timing

A range in heating time is given in each recipe. The time range compensates for the uncontrollable differences in food shapes, starting temperature and regional preferences. Always cook food for the minimum cooking time given in the recipe and check for doneness. If the food is under cooked, continue cooking. It is easy to add time to an under cooked product. Once the food is overcooked, nothing can be done!

Spacing

Individual foods, such as baked potatoes and cupcakes will heat more evenly if placed in the oven equal distance apart. When possible, arrange foods in a circular pattern.

Similarly, when placing foods around the outside of accessory, not lined up next to each other. Food should NOT be stacked on top of each other.

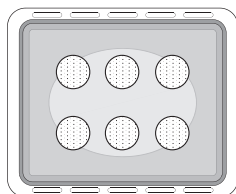
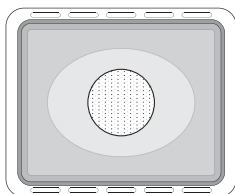

Browning

To shorten the food convection or cooking time and get good color effect, be sure to apply dark soy sauce or spicy sauce to the food before baking. For quick breads or muffins, brown sugar can be used in the recipe in place of granulated sugar, or the surface can be sprinkled with dark spices before baking.

Piercing

The skin or membrane on some foods will cause steam to build up during cooking. These foods must be pierced or a strip of skin should be peeled off before cooking to allow the steam to escape. It has a good performance during convection.

Potatoes — pierced with a fork.

Sausages — scratched smoked sausages. Pierce the casing with a fork.

Rotating and repositioning food

Sometimes heat cannot be redistributed by stirring the food. To achieve even cooking effect, you can reposition or rotate the food. For example, turn over the food in the cooking process, turn over large portions of food such as meat or chicken, or rotate the metal tray during baking.

Food Characteristics

The cooking method is closely related to the food characteristics.

Size

Small portions cook faster than large ones.

Shape

Uniform sizes heat more evenly. To compensate for irregular shapes, place thin pieces toward the centre of the dish and thicker pieces toward the edge of dish.



Starting Temperatures

Room temperature foods take less time to heat up than refrigerated, or frozen foods.

Density

Porous, airy foods take less time to heat than heavy, compact foods.

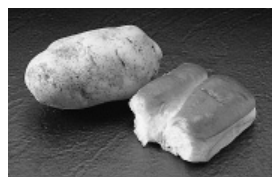

Feature Diagram

English

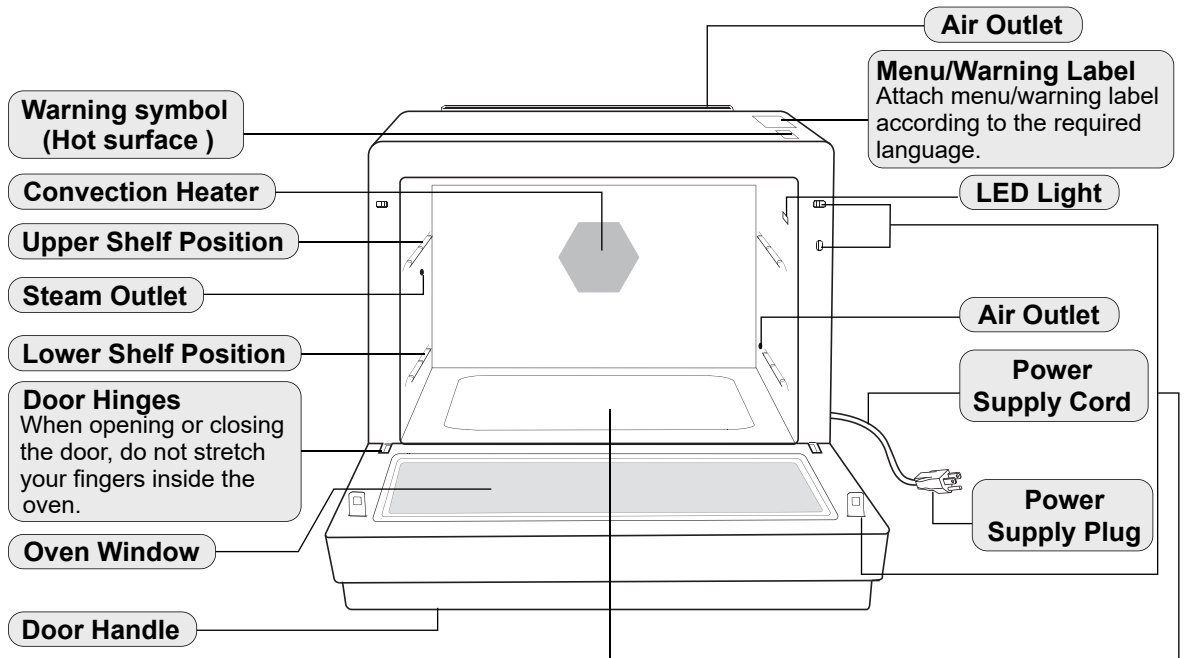

Bottom Plate

1. Clean oven after cooking is finished, and bottom plate is cooled.
2. Do not cook directly on the bottom plate. Always place food on the metal tray or wire rack.

Door Safety Lock System (both sides)

To prevent injury, do not insert finger, knife, spoon or other objects into the latch hole.

Identification Plate

Air Outlet

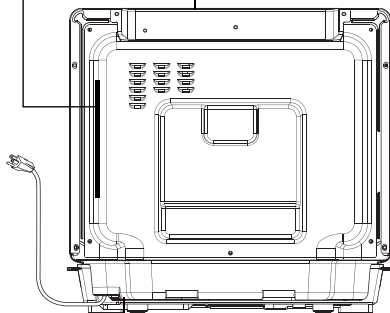

Air Inlet

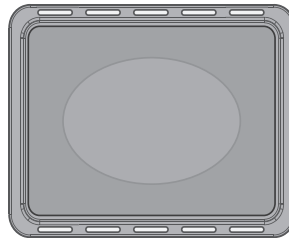

Metal Tray (×2)

1. All cooking must use the metal tray. Food cannot be put directly on bottom plate.
2. When using the metal tray, it must be placed in the shelf position.
3. Take it out with thermal insulation gloves after use. To avoid scalding, do not press it with your hands.
4. To avoid damaging the oven door, do not drag on the oven doors when handing.
5. The maximum weight that can be placed on the metal tray is 3 kg (include total weight of food and dish).

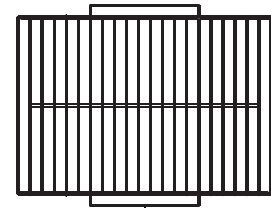

Wire Rack (×2)

1. It can help to keep the base dry and drip water or fat into the metal tray. Wire rack cannot be used individually. Always put on the metal tray.
2. Always use thermal insulation gloves after cooking. Do not press directly to avoid scalding.
3. The maximum weight that can be placed on the wire rack is 2.7 kg (includes total weight of food and dish).

Notes:

1. The above illustration is for reference only.
2. Oven accessories are including two metal trays and two wire racks. Other cooking utensils involved in the instructions should be purchased by you.

Feature Diagram

(continued)

English

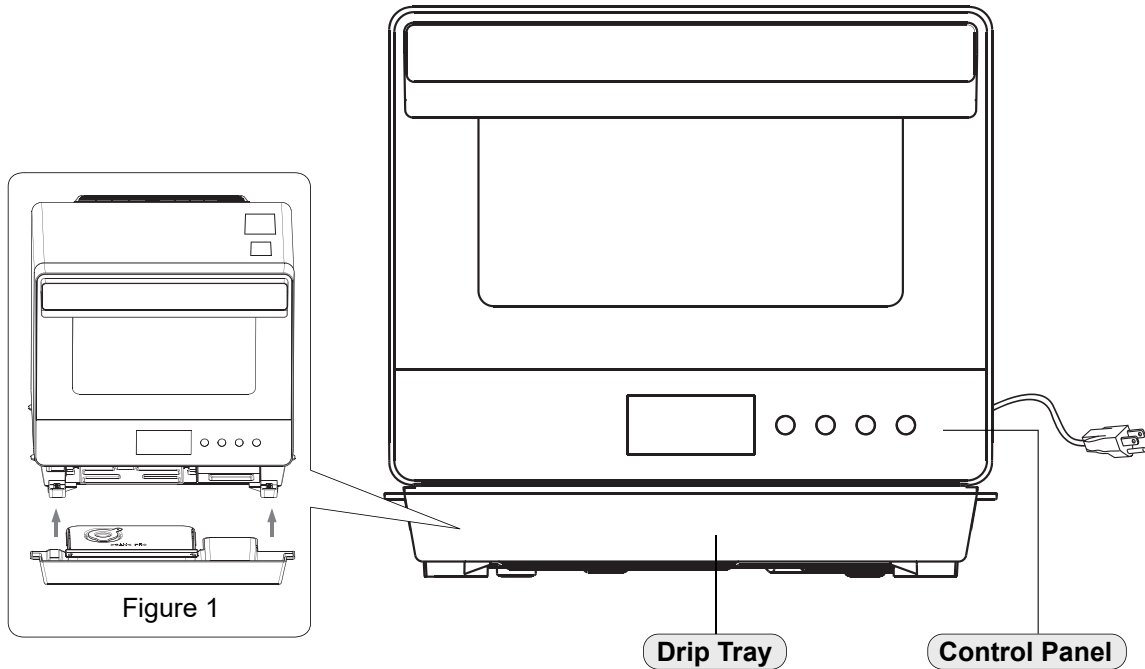
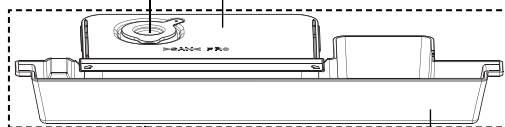

Figure 1

Water Tank

1. Full water level is 800 ml. Add water to 800 ml mark.
2. Fill with pure water (do not use mineral water).
3. Fully fill the water tank, and cover with the rubber lid.

Rubber Lid



Water Tank Lid

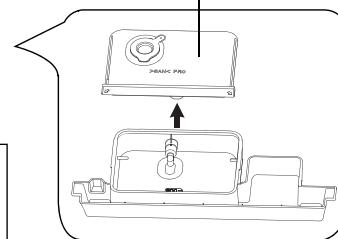

Integrated Water Tank

1. Water tank and drip tray are parts of integrated water tank.
2. Take integrated water tank out from package before using according to figure 1. Then install it to the lower side.
3. To remove the drip tray, hold with both hands and gently ease forward.
4. Always clean the integrated water tank.
5. Ensure the water tank is closed tightly and securely positioned, otherwise leakage may occur.
6. DO NOT USE A DISHWASHER TO CLEAN THE INTEGRATED WATER TANK.

Note: When removing the integrated water tank, several drops may flow from the water outlet of bottom cavity. You can remove the integrated water tank after the oven cavity has cooled down.

Drip tray





1. The drip tray must be fitted as it collects excess water during cooking.
2. The drip tray should be removed and cleaned on a regular basis.



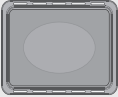
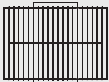

Notes:

1. The above illustration is for reference only.
2. Protective films cover the surface of the door handle and control panel. You can remove them before using.

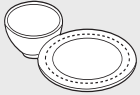
Cookware and Utensil Guide

English

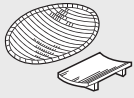
| Container | Convection*, Steam High, Fermentation | Steam-Med |
|--|--|-----------|
| Metal tray  | ✓ | ✓ |
| Wire rack  | ✓ | ✓ |
| Heat-proof glass container  | ✓ | ✓ |
| Non-heat-proof glass containers  | Note: They can be used for constant temperature fermentation. | ✗ |
| Heat-proof plastic containers  | Note: They can be used for constant temperature fermentation. | ✓ |
| Non-heat-proof plastic containers  | Note: They can be used for constant temperature fermentation. | ✗ |
| Ceramic • porcelain  | Note: Color stripping may be found in containers with internal color pictures. Do not use such a container. | ✓ |

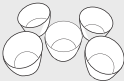
| Container | Convection*, Steam High, Fermentation | Steam-Med |
|--|--|--|
| Lacquerware  | ✗ | ✗ |
| Aluminum and other metal containers  | Note: Meal containers with resin handles cannot be used. | Note: Easy-rusting metal container is forbidden. |
| Wood • bamboo • paper containers  | Note: Paper containers that have undergone Heat-proof treatment and Heat-proof treatment higher than setting temperature can be used. | Note: Wood and bamboo container, paper containers that have undergone Heat-proof treatment can be used. |
| Plastic wrap  | Note: ① Plastic wrap will melt under a high temperature. ② They can be used for constant temperature fermentation. | Note: Do not use without special instructions. |
| Aluminum foil  | ✓ | ✓ |
| Heat-proof silica gel container  | ✓ | ✓ |

* When Healthy Fry, Steam Convection and Stew functions are used, the cooking utensils and accessories should be selected according to requirements for Convection.

Notes:

- Accessories must be used when cooking.
- Place the wire rack on the metal tray. Do not use it without the metal tray.
- Take it out with thermal insulation gloves after use. To avoid scalding, do not press it with your hands.
- For container placement, in all types of cooking, you can refer to Heating Principle (see page 5).
- Do not use accessories, or other containers, in the preheating stage.

Control Panel

English

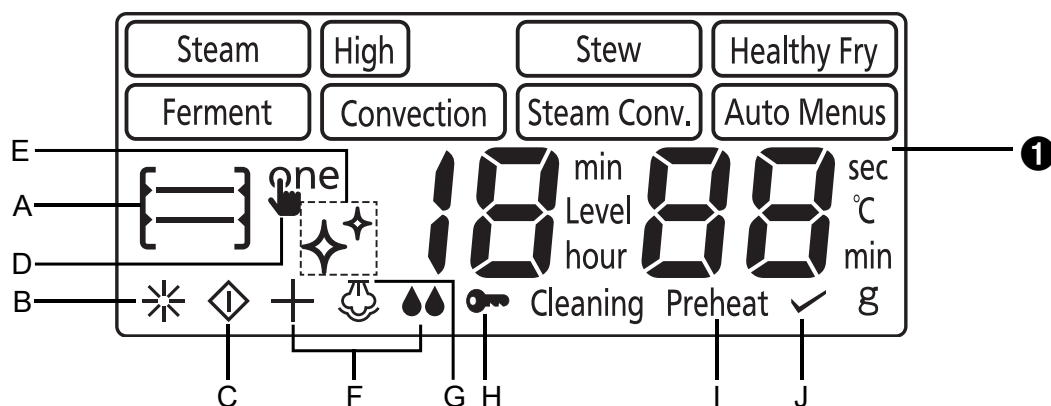
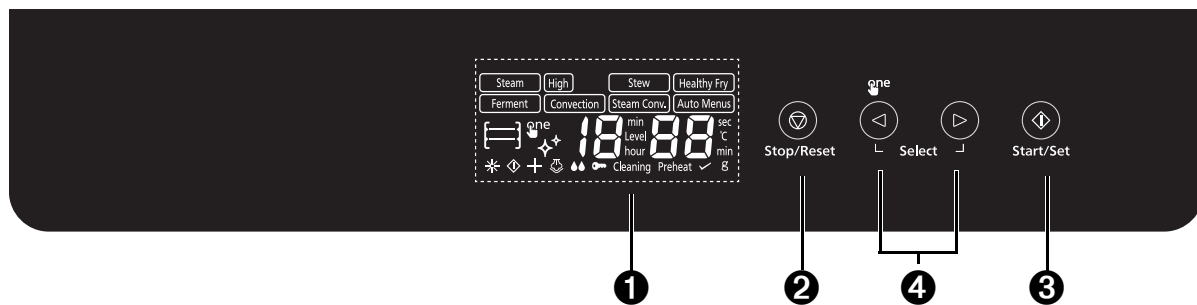

❶ Display Window:

- A: Top shelf and Bottom shelf
- B: Normal Working
(The mark is rotate during operation.)
- C: Start/Set
- D: One Push Function
- E: Steam System Cleaning Function, Citric Acid Cleaning Function
- F: Full Water Icon
- G: Steam Shot Icon
- H: Child Safety Lock
- I: Preheat Icon
- J: Preheat End Icon

Mode:

Two modes of steam cooking:

- Steam-Med.....(See page 12)
- Steam-High.....(See page 12)
- Stew.....(See page 13)
- Healthy Fry.....(See page 14)
- Fermentation.....(See page 15)
- Convection..... (See page 16-17)
- Steam Conv..... (See page 18-19)
- Auto Menus..... (See page 23-36)

❷ Stop/Reset button

❸ Start/Set button

❹ Select button

Control Panel

(continued)

English

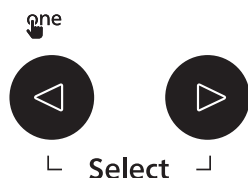

- **One Push Setting/Cancel**
To set/cancel one push setting. (Press “” button 2 seconds)
- **Function Setting**
To select a function which you desired.
- **Time Setting***
To set the cooking time.
- **Menu Setting**
To choose desired menu among auto menus.
- **Weight/Serving/Level Setting**
To set desired cooking weight/serving/level among auto menus.
- **Temperature Setting**
To set the temperature of Convection, Fermentation and Steam Convection.



Note: To ensure safety, the convection temperature will gradually decrease to 200 °C when using above 200 °C in cooling and remaining 8 minutes. If you continue to use above 200 °C, cooking time will shorter. This not influence its performance.

* Press “” button for a long time, you can fast forward or rewind of time setting.

Beep Sound:

| Times | Results |
|-----------------|--|
| None | Did not or could not accept the instruction |
| Once | Accept the instruction |
| Twice | Between programmed stages to prompt turn over, stir, rearrange foods or error message during cooking |
| Three times | After preheating for manual setting |
| Long time beeps | After preheating for auto menu setting |
| Five times | End of any completed program |

Notes:

1. The above illustration is for reference only.
2. After 6 minutes without operation after setting the cooking program, including opening or closing the oven door, the program will automatically be cancelled and revert back to “” or enter standby mode. Open and close the oven door once, it can operate again. If the oven is used for another time without being unplugged and plugged in again, the last program will be displayed.
3. : This illustration is placement of accessory for auto cook menus.

Steam Setting

English

Two modes for steam cooking, Steam-Med and Steam-High. Cooking with steam can keep foods soft and moist. For example: vegetables, seafood and so on. Additionally, it also can heat tin foods or vacuum packaged foods.

1

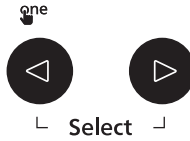

Place wire rack with food on the metal tray in the lower shelf position, then select **Steam-High** mode by pressing **Select** button.

Example: select Steam-High mode

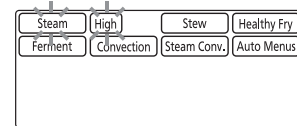

Note: Fill the tank with water before using.

2



Press **Set** button to set the **Steam-High** mode.

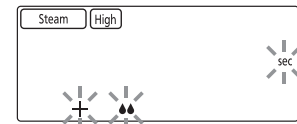

3

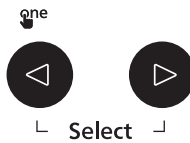

Set desired cooking time by pressing **Select** button.

Example: 5 minutes



4



Press **Start** button. Cooking will start. The time in the display window will count down.

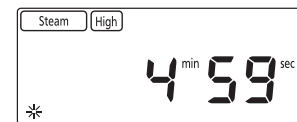

| Mode | Suitable kinds of foods |
|------------|--------------------------------------|
| Steam-High | Meat, Seafood, Root Vegetables, etc. |
| Steam-Med | Bun, Shrimp, Chicken Breast, etc. |

Notes:

1. Fill the tank with water before using. The max volume is 800 ml.
2. Max time for Steam-Med is 1 hour.
3. Max time for Steam-High is 30 minutes.
4. Flashing state “*” will flash in the display window.
5. When using Steam-High for cooking, please ensure that the heat resisting temperature of the cooking container is above 130 degrees.

Stew Setting

This mode combines the steam and convection heater. It is suitable for stew soup and vegetables with long cooking times. You can set cooking time only.

English

1



Select

Place wire rack with food on the metal tray in the lower shelf position. Select **Stew** mode by pressing **Select** button.

Note: Fill the tank with water before using.

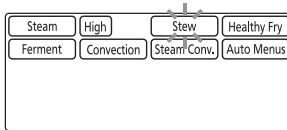

2



Start/Set

Press **Set** button to set the **Stew** mode.

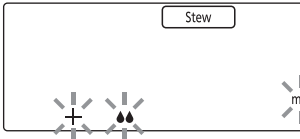

3



Select

Set desired cooking time by pressing **Select** button.

(Setting time range from 1 hour and 30 minutes to 3 hours. One shift time is 30 minutes.)

Example: 1 hour
30 minutes

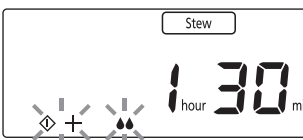

4



Start/Set

Press **Start** button. Cooking will start. The cooking time in the display window will count down.

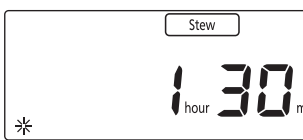

Notes:

1. Fill the tank with water before using.
2. This mode is suitable for small soup bowl. If you stew food using large-capacity container, it is recommended to extend the cooking time appropriately.

Healthy Fry Setting

This mode can cook foods like fries with little or no oil. This is more healthy than traditional deep-frying and suitable for fried fish fillets, fried shrimp with bread crumbs, fried chicken etc.

English

1

Select **Healthy Fry** mode by pressing **Select** button. Preheat is automatically set and its icon appears in the display window.

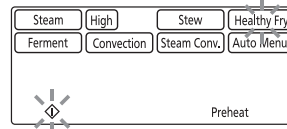

2



Start/Set

Press **Start** button and preheating starts.



3

After preheating, the oven will beep three times and the icon "✓" appears to inform preheat is done. Open the door and place accessory with food in the according shelf position quickly.

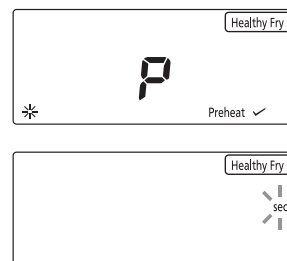

4



Select

Set desired cooking time by pressing **Select** button.

(Maximum setting time is 1 hour 30 minutes.)

Example: 5 minutes



5



Start/Set

Press **Start** button. The cooking time in the display window will count down.

You can adjust the cooking time while cooking. Pressing the Select button can increase or decrease the cooking time in 1 minute increments (up to 10 minutes).

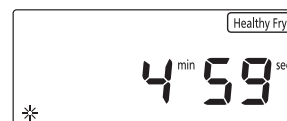









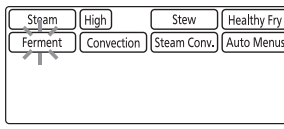

Note:

To ensure safety on extended cooking times in the Healthy Fry mode, the oven will gradually decrease the temperature 8 minutes after it has achieved the desired temperature. This will not influence the cook performance.

Fermentation Setting

Fermentation has 30 °C and 40 °C modes. 30 °C can be used for fermentation of European bread and dough with rich oil. Like baguette or Danish bread. 40 °C can be used for fermentation of Chinese pastry and pizza dough.

English

| | | |
|--|---|--|
| <p>1</p>  <p>Select</p> | <p>Place food in the container or directly on the metal tray in the according shelf position. Press Select button to choose Fermentation.</p> |  |
| <p>2</p>  <p>Start/Set</p> | <p>Press Set button to set Fermentation.</p> |  |
| <p>3</p>  <p>Select</p> | <p>Set desired fermentation temperature by pressing Select button. (You can set 30 °C and 40 °C. Default temperature is 30 °C.)</p> | <p>Example: 40 °C</p>  |
| <p>4</p>  <p>Start/Set</p> | <p>Press Set button to set desired temperature.</p> |  |
| <p>5</p>  <p>Select</p> | <p>Set desired cooking time by pressing Select button. (Maximum Fermentation time is 12 hours.)</p> | <p>Example: 30 minutes</p>  |
| <p>6</p>  <p>Start/Set</p> | <p>Press Start button. The cooking time in the display window will count down. You can adjust the cooking time while cooking. Pressing Select button can increase or decrease the cooking time in 1 minute increments (up to 10 minutes).</p> |  |

Notes:

- Oven temperature will change with food and room temperature. Please adjust the fermentation time according to the performance.
- When cavity or room temperature is higher than the setting fermentation temperature, fermentation effect of food may be affected, "U50" will be appeared in the display window. Please wait until the cavity or room temperature cools down. When "U50" disappears, you can use fermentation again or ferment food at room temperature.
- Steam Shot function can be used when you need steam in fermentation. Please refer to page 20.



Convection Setting

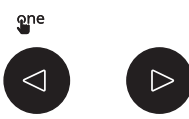

Convection setting from 100 °C to 230 °C are suitable for baking meat, fish and Western desserts like cakes, pizzas, etc. Place the foods directly on the accessory, select suitable temperature and time, and start cooking. For evenly distributed color of cooked food, re-arrange food position or rotate the accessory during cooking.

English

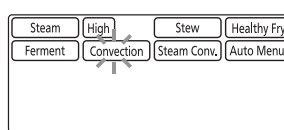

When cooking without Preheat:

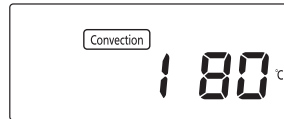
- 1**  Place food on the accessory in the upper and lower shelf position. Select **Convection** mode by pressing **Select** button. (Without Preheat)

- 2**  Press **Set** button to set **Convection** mode. (Without Preheat)

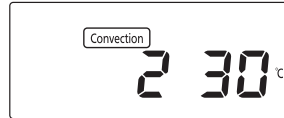

- 3**  Set desired cooking temperature by pressing **Select** button. (Temperatures range from 100 °C to 230 °C. Default temperature is 180 °C.)

Example: 230 °C

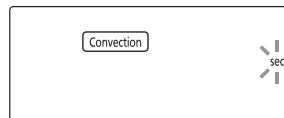
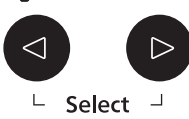

- 4**  Press **Set** button to set desired temperature.

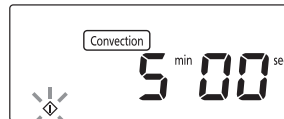
- 5**  Set desired cooking time by pressing **Select** button. (Maximum **Convection** time is 1 hour and 30 minutes.)

Example: 5 minutes

- 6**  Press **Start** button. The cooking time in the display window will count down.

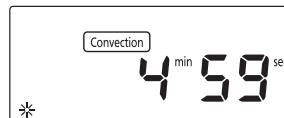
You can adjust the cooking time while cooking. Pressing **Select** button can increase or decrease the cooking time in 1 minute increments (up to 10 minutes).



Convection Setting

(continued)

English

When cooking with Preheat:

1  Select 

Select **Convection** mode by pressing **Select** button. (With Preheat)





Control panel showing: Steam, High, Stew, Healthy Fry, Ferment, Convection, Steam Conv., Auto Menus, Preheat.

2  Start/Set

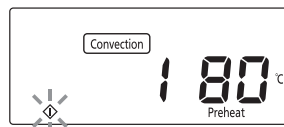
Press **Set** button to set **Convection** mode. (With Preheat)



Display showing: Convection, 180 °C, Preheat.

3  Select 

Set desired cooking temperature by pressing **Select** button.

Example: 190 °C

(Temperatures range from 100 °C to 230 °C. Default temperature is 180 °C.)

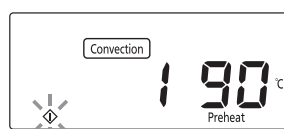

Display showing: Convection, 190 °C, Preheat.

4  Start/Set

Press **Start** button to preheat.

(You can adjust the desired temperature by pressing **Select** button during preheating.)

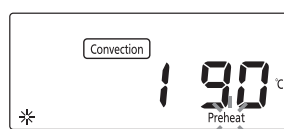

Display showing: Convection, 190 °C, Preheat, *

5

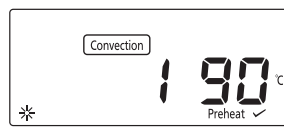

After preheating, the oven will beep three times and the icon “✓” appears to inform preheat is done. Open the door and place accessory with food in the upper and lower shelf position quickly.

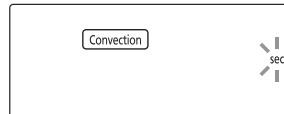

Display showing: Convection, 190 °C, Preheat ✓, *



Display showing: Convection, Preheat icon, *

6  Select 

Set desired cooking time by pressing **Select** button.

Example: 5 minutes

(Maximum **Convection** time is 1 hour and 30 minutes.)

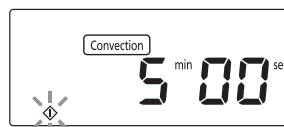

Display showing: Convection, 5 min 00 sec, Preheat, *

7  Start/Set

Press **Start** button. The cooking time in the display window will count down.

You can adjust the cooking time while cooking. Pressing **Select** button can increase or decrease the cooking time in 1 minute increments (up to 10 minutes).

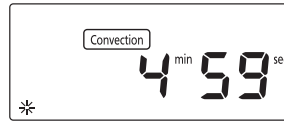



Display showing: Convection, 4 min 59 sec, *

Steam Convection Setting

This mode combines the steam and convection modes, adding steam while cooking in Convection mode which creates fluffier cakes and juicier meats. For more evenly distributed food color, re-arrange food or rotate the accessory during cooking.

English

When cooking without Preheat:

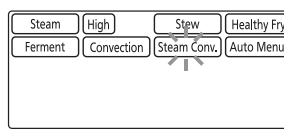

- 1**   Place accessory with food in the according shelf position. Select **Steam Conv.** mode by pressing **Select** button. (Without Preheat)

Note: Fill the tank with water before using.



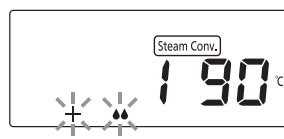

- 2**  Press **Set** button to set **Steam Conv.** mode. (Without Preheat)



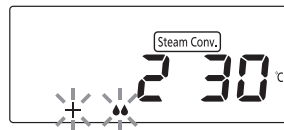

- 3**   Set desired cooking temperature by pressing **Select** button. (Temperatures range from 190 °C to 230 °C. Default temperature is 190 °C.)

Example: 230 °C



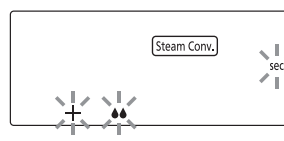

- 4**  Press **Set** button to set desired temperature.

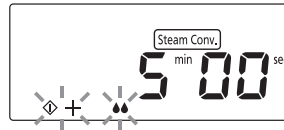

- 5**   Set desired cooking time by pressing **Select** button. (Maximum setting time is 1 hour.)

Example: 5 minutes



- 6**  Press **Start** button. The cooking time in the display window will count down.

You can adjust the cooking time while cooking. Pressing **Select** button can increase or decrease the cooking time in 1 minute increments (up to 10 minutes).

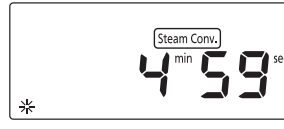

Steam Convection Setting

(continued)

When cooking with Preheat:

English



Press **Select** button to select **Steam Conv.** mode. (With Preheat)

Note: Fill the tank with water before using.

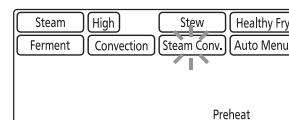

Press **Set** button to set **Steam Conv.** mode. (With Preheat)

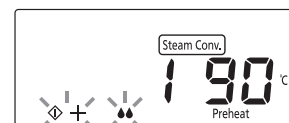

Set desired cooking temperature by pressing **Select** button.

(Temperatures range from 190 °C to 230 °C. Default temperature is 190 °C.)

Example: 230 °C

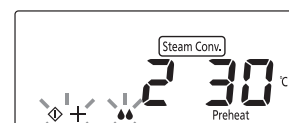

Press **Start** button to preheat.

You can adjust the desired temperature by pressing **Select** button during preheating.

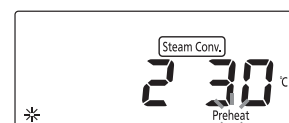

5

After preheating, the oven will beep three times and the icon "✓" appears to inform preheat is done. Open the door and place accessory with food in the according shelf position quickly.

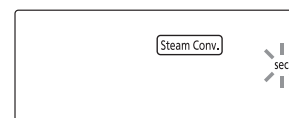
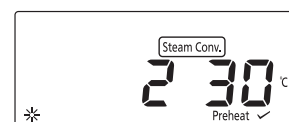

Set desired cooking time by pressing **Select** button.

(Maximum setting time is 1 hour.)

Example: 5 minutes

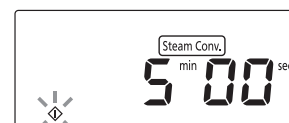

Press **Start** button. The cooking time in the display window will count down.

You can adjust the cooking time while cooking. Pressing **Select** button can increase or decrease the cooking time in 1 minute increments (up to 10 minutes).

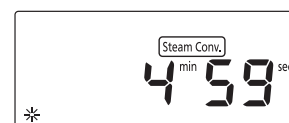

Steam Shot Setting

English

This function allows you to add steam during cooking in Convection and Fermentation mode (up to 3 minutes). Adding steam during cooking can enhance moisture distribution, thus promoting the softer dessert surfaces and juicier meats. At the beginning of fermentation using steam can increase cavity humidity, which is better for the dough to ferment.

Example: Add steam 1 minute during cooking in the Convection mode.

1

Cooking in **Convection** mode.

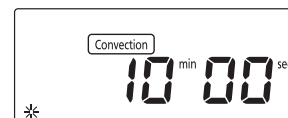

2



Start/Set

Press button 2 seconds and add steam 1 minute will appear in the display window.

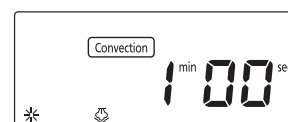

3

If you want to add 3 minutes steam, press the button twice again within 3 seconds when the step 2 operation appears. Display window will increase 3 minutes.

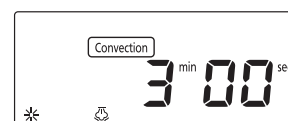

(It will become "0" when you press button 3 times. You can reset time by duplicating above steps.)

The key to "Steam Shot" in cooking process:

Cooking in the Convection mode:

For cooking puffs or bread, after preheating, please add steam when heating starts. For cooking cakes, after preheating, please add steam half way through total heating time.

Notes:

1. Fill the tank with water before using.
2. Steam shot is not available during preheating of Convection mode.
3. The original Convection or Fermentation cooking time still counts down when setting steam shot.



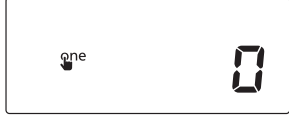

One Push Setting

One push setting can simplify operation. You can set desired function as one push setting that can use easily in each time.



To Save:

| | | |
|---|--|---|
| 1 | “one” will flash in the display window after finishing. It means you can save program as one push setting. |  |
| 2 | “one” will stop flash in the display window when press button 2 seconds. Program has saved successfully. |  |

To set:

| | | | |
|---|--|--|---|
| 1 |  Start/Set | Press Start/Set button and saved program appears in the display window. | Example: Saved “Steam-High” for 3 minutes |
| 2 |  Start/Set | Press Start button to cooking. |   |

To cancel:

| | | | |
|---|--|--|---|
| 1 |  Start/Set | Press Start/Set button and saved program appears in the display window. | Example: Cancel saved “Steam-High” for 3 minutes |
| 2 |  Start/Set | Press the button 2 seconds and cancel one push setting. |  |

Notes:

1. “one” will flash in the display window after finishing. Press Stop/Reset button if you do not want to save program as one push setting.
2. If one push setting is saved, “one” will flash in the display window.
3. Only one program can be set to one push setting. Previous one push program will be covered when a new program is saved.
4. One push program will remain if powered off.
5. One push setting is available for all functions. (only except Steam Shot)

Child Safety Lock Setting

This function allows you to prevent a young child operating the oven; however, the door can still be opened. You can set Child Safety Lock when “0” shows in display window.

English

To set:



Stop/Reset

Press 3 times, “” appears in the display window.



To cancel:



Stop/Reset

Press 3 times, “” appears in the display window.











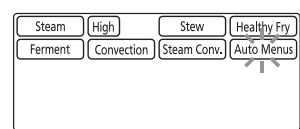

Note:

To set or cancel child safety lock should be pressed within 10 seconds.

Auto Cook Setting and Menus

This function allows you to cook most of your favorite foods by setting the different weight. It can follow the prompts and cooking automatically without setting function, temperature and time. Press **Select** button and menu number will appear in the display window.

Operation as follows: (except No.10-11, 13-18)











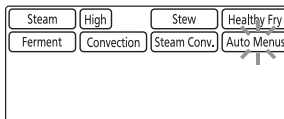

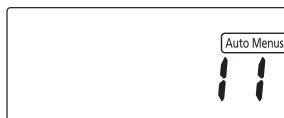

| | | |
|--|--|--|
| <p>1</p>  <p>Select</p> | <p>Press Select button to select Auto Menu.</p> |  |
| <p>2</p>  <p>Start/Set</p> | <p>Press Set button to set a desired Auto Menu.</p> |  |
| <p>3</p>  <p>Select</p> | <p>Press Select button to select a desired cooking menu number. (See page 25)</p> | <p>Example: No.5 Steamed Fresh Vegetables</p>  |
| <p>4</p>  <p>Start/Set</p> | <p>Press Set button to set cooking menu number.</p> <p>Note: If you choose the 6, 8, 9, 12 menus, skip the 4th and 5th steps.</p> |  |
| <p>5</p>  <p>Select</p> | <p>Press Select button to set a desired Weight/Serving/Level.</p> <p>Note: If you choose the No.3, No.4 and No.7 menus, select level according to weight. If you choose the No.2 menu, select serving according to weight.</p> | <p>Example: 300 g</p>  |
| <p>6</p>  <p>Start/Set</p> | <p>Press Start button. The cooking time in the display window will count down.</p> |  |

Auto Cook Setting and Menus

(continued)



























English

Operation as follows: No.10-11, 13-18

| | | |
|--|--|---|
| <p>1</p>  <p>Select</p> | <p>Press Select button to select Auto Menu.</p> |  |
| <p>2</p>  <p>Start/Set</p> | <p>Press Set button to set a desired Auto Menu.</p> |  |
| <p>3</p>  <p>Select</p> | <p>Press Select button to select a desired cooking menu number. (See page 25)</p> | <p>Example: No.11 Fried Fish Fillets</p>  |
| <p>4</p>  <p>Start/Set</p> | <p>Press Set button to set a desired cooking menu number.</p> |  |
| <p></p> | <p>Note: If you choose the No.17 menu, skip the step 4 and step 5.</p> | |
| <p>5</p>  <p>Select</p> | <p>Press Select button to set a desired Weight or Level.</p> | <p>Example: 2 levels</p>  |
| <p></p> | <p>Note: If you set the No.13 menu, select a desired weight.</p> | |
| <p>6</p>  <p>Start/Set</p> | <p>Press Start button to preheat.</p> |  |
| <p>7</p> | <p>Notes: If you set the No.18 menu, put dough into the oven and press Start to fermentation. Take dough out when beep sound is heard and then press Start button again to preheat.</p> <p>After preheating, the oven will beep long time and the icon “✓” appears to inform preheat is done. Place accessory with food in the upper and lower shelf position quickly.</p> |   |
| <p>8</p>  <p>Start/Set</p> | <p>Press Start button. The cooking time in the display window will count down.</p> |  |

Auto Cook Setting and Menus

(continued)

| No. | Menu | Weight/Serving/Level | | | | Accessories | Placement | Reference Page |
|-----|-------------------------------------|----------------------|----------------------|-------|-------|--|---|----------------|
| | | | | | | | | |
| 1 | Steamed Fish* | 200 g | 300 g | 400 g | 500 g |   |  | P. 27 |
| 2 | Steamed Egg* | 1-3 serves | 4-6 serves | - | - |   |  | P. 27 |
| 3 | Steamed Chinese Buns* | 1 level (9 pcs) | 2 levels (18 pcs) | - | - |   |   | P. 28 |
| 4 | Steamed Frozen Foods* | 1 level (12 pcs) | 2 levels (24 pcs) | - | - |   |   | P. 28 |
| 5 | Steamed Fresh Vegetables* | 200 g | 300 g | 400 g | 500 g |   |  | P. 29 |
| 6 | Steamed Sweet Potato Cubes* | 50-150 g | - | - | - |   |  | P. 29 |
| 7 | Steamed Scallop with Mashed Garlic* | 1 level (6 pcs) | 2 levels (12 pcs) | - | - |   |   | P. 30 |
| 8 | Chinese White Sliced Chicken* | 1000 g | - | - | - |   |  | P. 30 |
| 9 | Stewed Ribs Soup* | 2-4 serves | - | - | - |   |  | P. 31 |
| 10 | Fried Shrimp with Bread Crumbs | 1 level (16 pcs) | 2 levels (32 pcs) | - | - |  |   | P. 31 |
| 11 | Fried Fish Fillets | 1 level (350 g) | 2 levels (700 g) | - | - |  |   | P. 32 |
| 12 | Home-made Yoghurt | 4-8 cups | - | - | - |  |  | P. 32 |
| 13 | Barbecue Pork | 400 g | 600 g | 800 g | - |   |   | P. 33 |
| 14 | Teriyaki Chicken Wings* | 1 level (12 pcs) | 2 levels (24 pcs) | - | - |   |   | P. 33 |
| 15 | Egg Tarts | 1 level (9 pcs) | 2 levels (18 pcs) | - | - |  |   | P. 34 |
| 16 | Cookies | 1 level (20 pcs) | 2 levels (40 pcs) | - | - |  |   | P. 34 |
| 17 | Cheese Cake* | 7 inch | - | - | - |  |  | P. 35 |
| 18 | Home-made Pizza | 1 level (1pc) | 2 levels (2 pcs) | - | - |  |   | P. 36 |
| 19 | Cleaning (Utensils)* | - | - | - | - |   |  | P. 40 |
| 20 | Cleaning (Feeding Bottles)* | - | - | - | - |   |  | P. 41 |

English

Auto Cook Setting and Menus

(continued)

English

| No. | Menu | Weight/Serving/Level | Accessories | Placement | Reference Page |
|-----|-----------------------------|-----------------------|-------------|-----------|----------------|
| 21 | Cleaning (Deodorization) | Oven Cleaning Setting | | | P. 42 |
| 22 | Cleaning (Cavity)* | | | | P. 43 |
| 23 | Cleaning (System)* | | | | P. 44 |
| 24 | Cleaning (with Citric Acid) | | | | P. 45 |

Notes:

1. The recipes marked with “**” require steam. Be sure to fill the water tank before cooking. Add detergent before using citric acid cleaning.
2. All seasonings in this book is only for your reference.
3. Accessories placement see the table below.

| Display | Placement |
|---------|-----------------|
| { — } | lower |
| { = } | upper and lower |

Auto Cook Setting and Menus

(continued)

English

Steamed Fish

(200/300/400/500 g)

1



Ingredients

fish 1 (net weight 300 g)
sliced ginger 5 g
green onion 3 g

Seasonings

salt taste
cooking wine 5 g
seasoned soy sauce or
light soy sauce 15 g

Container

Heat-proof dish,
metal tray, wire rack
(lower shelf), integrated
water tank



Method

1. Wash and cut fish both sides 2-3 slices with knife.
2. Marinate with salt and cooking wine. Then set aside for 10 minutes.
3. Place the fish in a heat-proof dish while topping with sliced ginger and green onion.
4. Place wire rack with dish on the metal tray, then place the metal tray in the lower shelf position.
5. Fill water tank.
6. Select Auto Menus No.1 and weight, then press **Start** to cook.
7. Drizzle with seasoned soy sauce or light soy sauce to serve immediately.

Notes:

1. The ingredients listed in this recipe are for 300 g fish, for multiple weights, calculate the material quantities according to the proportion.
2. For thicker fish, please add additional Steam-Med cooking time by manually setting according to your preference.

Steamed Egg

(1-3/4-6 serves)

2



(2 serves)

Ingredients

egg 2 (about 50 g an egg
without shell)
warm water (about 40 °C) 180 ml

Seasonings

light soy sauce 2 g
cooking wine 2 g
salt taste
sesame oil drops

Container

Soup bowl, metal tray,
wire rack (lower shelf),
integrated water tank



Method

1. Mix light soy sauce, cooking wine and salt with beaten eggs. Stir and filtrate well after add warm water. Pour into bowls with 135 g each and divide their foam, then cover with plastic wrap or lid.
2. Place wire rack with soup bowl on the metal tray in the lower shelf position.
3. Fill water tank.
4. Select Auto Menus No.2 and serving, then press **Start** to cook.
5. Drizzle with sesame oil to serve.

Note:

The ingredients listed in this recipe are for 2 serves. For multiple servings, calculate the material quantities according to the proportion, and put them into the soup bowl respectively, the placement method for cooking of multiple serves are shown below.

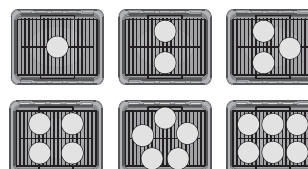

Auto Cook Setting and Menus

(continued)

English

Steamed Chinese Buns

(1 level / 2 levels)

3



Ingredients (1 level, 9 pcs)

Wrapper:

all purpose flour 225 g
castor sugar 2 g
yeast 2.5 g
warm water (40 °C)
..... about 120 ml
oil 5 g

Fillings:

minced meat 200 g
dried mushroom 40 g
(after soaked)
scallion and ginger water ... 40 g
dark soy sauce 4 g
light soy sauce 10 g
white pepper taste
salt 3 g
castor sugar 6 g
sesame oil 4 g

Container

Metal tray, wire rack
(lower shelf), integrated
water tank



Method

Filling:

Soak dried mushroom in water for minutes, drain and chop. Add fillings without scallion and ginger water into minced meat and stir well. Then add scallion and ginger water gradually and stirring in one direction until the mixture thickness.

Wrapper:

1. Pour all purpose flour, castor sugar, yeast, oil and warm water into a bowl, and stir evenly and knead the dough until smooth.
2. Divide the dough into 9 equal parts and roll into small round pieces with relatively thick rims for easy stuffing. Package about 35 g meat into the dough.
3. Prepare suitable size baking paper underneath buns and place them on the wire rack according to the 3×3 arrangement evenly. Then put the wire rack on the metal tray in the lower shelf position.
4. Fill water tank.
5. Select Auto Menus No.3 and level, then press **Start** to cook.
6. Take out after cooking.

Notes:

1. The ingredients listed includes proportions for 9 pieces of 1 level. Cooking for other weights calculate ingredients in proportion. Each level can put 9 pieces when cooking 2 levels. Place metal tray in the upper and lower shelf position, then you select "2 levels".
2. When the cavity gets overheated, "U50" will appear in the display window. Please wait until the cavity cools down, and start operation after "U50" disappears.

Steamed Frozen Foods

(1 level / 2 levels)

4



(1 level, 12 pcs)

Ingredient

frozen foods (30-40 g/pc).....12 pcs

Container

Metal tray, wire rack
(lower shelf), integrated
water tank



Method

1. Prepare suitable size baking paper underneath frozen foods. Place frozen foods according to 3×4 arrangement evenly on the wire rack, then put the wire rack on the metal tray in the lower shelf position.
2. Fill water tank.
3. Select Auto Menus No.4 and level, then press **Start** to cook.
4. Take out after cooking.

Notes:

1. It is suitable for cook frozen foods without defrosting. Add additional cooking time of steam manually for over-sized food.
2. Each level can put 12 pieces when cooking. Place metal tray in the upper and lower shelf position, then you select "2 levels".

Auto Cook Setting and Menus

(continued)

Steamed Fresh Vegetables

(200/300/400/500 g)

5



Ingredient

vegetables (green vegetables, Chinese Kale etc.)

Container

Metal tray, wire rack
(lower shelf),
integrated water tank



Method

1. Clean the vegetables and cut into suitable size.
2. Arrange vegetables evenly on the wire rack, then put wire rack on the metal tray in the lower shelf position.
3. Fill water tank.
4. Select Auto Menus No.5 and weight, then press **Start** to cook.

Note:

This program is only suitable for leafy vegetables or root vegetables. Keep the vegetables as flat as possible when placing them, avoid stacking.

Steamed Sweet Potato Cubes (50-150 g)

(50-150 g)

6



Ingredient

sweet potatoes 50 -150 g

Container

Metal tray, wire rack
(lower shelf),
integrated water tank



Method

1. Clean, peel and dice sweet potatoes into small cubes.
2. Place sweet potatoes evenly on wire rack on the metal tray in the lower shelf position.
3. Fill water tank.
4. Select Auto Menus No.6, then press **Start** to cook.

English

Auto Cook Setting and Menus

(continued)

English

Steamed Scallop with Mashed Garlic (1 level / 2 levels) 7

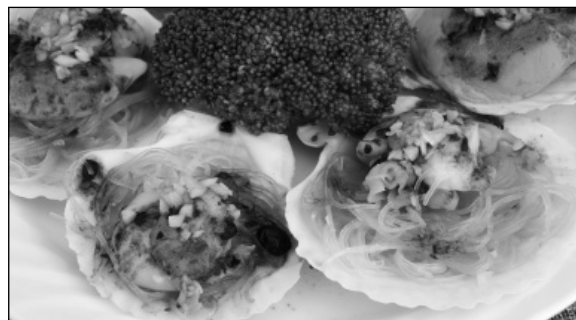

Ingredients (1 level, 6 pcs)

| | |
|---------------------------|--------------------------|
| scallop | 6 pcs (about 120 g each) |
| vermicelli noodles | 25 g |
| mashed garlic | 30 g |
| chopped green onion | 5 g |
| sliced red pepper | 2 g |

Seasonings

| | |
|--------------------------|------|
| oil | 40 g |
| cooking wine | 15 g |
| seasoned soy sauce | 25 g |

Container

Metal tray, wire rack (lower shelf), integrated water tank



Method

1. Remove any sand and clean the scallop, remove the shellfish with a knife carefully. Then marinate with cooking wine in a bowl to reduce fishy smell, clear the shells and soak the vermicelli noodles with hot water until soft.
2. Oil is heated and add mashed garlic and sliced red pepper and stir-fry until light yellow. Serve in a bowl and add chopped green onion and seasoned soy sauce, mix well.
3. Place wire rack on the metal tray and roll the vermicelli noodles up with chopsticks and lay them on the shells, topping with scallop meat and sauteed garlic, drizzle with oil and place them evenly on the wire rack.
4. Fill the water tank.
5. Select Auto Menus No.7 and level, then place the metal tray in the lower shelf position, then press **Start** to cook.

Notes:

1. You can put 6 pcs in each level when cooking 2 levels. Place metal tray in the upper and lower shelf position and select "2 levels".
2. Thick scallop meat should cut several holes on the surface.

Chinese White Sliced Chicken (1000 g) 8



Ingredient

| | |
|---------------|--------------|
| chicken | about 1000 g |
|---------------|--------------|

Seasonings

| | |
|---------------------------|------|
| salt | 5 g |
| ginger | 50 g |
| chopped green onion | 5 g |
| oil | 5 g |

Container

Heat-proof dish, metal tray, wire rack (lower shelf), integrated water tank



Method

1. Wash and remove chicken head and feet. Ground ginger into minced ginger, extract about 15 g ginger juice and remaining the pressed ginger to cook.
2. Rub the chicken's surface and inside with salt first, then spread the ginger juice well to marinate above 2 hours. Stir chicken with once or twice during marinating to assure tasty. To get a good cooking performance, put chicken into refrigerator is not recommended.
3. Put the wire rack on the metal tray. Place chicken on baking paper and fold over leaving both ends uncovered. (Steam can enter chicken inside to avoid directly touching skin.) Place heat-proof dish on the wire rack with breast on the top (back end towards left air outlet), then place it in the lower shelf position.
4. Fill water tank.
5. Select Auto Menus No.8, then press **Start** to cook.
6. Put pressed ginger and chopped green onion into a bowl, add chicken broth (water in heat-proof dish after steaming) and add hot oil heated in a pan, then become green onion-ginger oil.
7. When chicken is cool down, chop into pieces to serve. You can eat with green onion-ginger oil.

Auto Cook Setting and Menus

(continued)

Stewed Ribs Soup

(2-4 serves)

9



Ingredients (4 serves)

| | |
|----------------|----------|
| pork ribs | 350 g |
| carrot | 130 g |
| sweet corn | 130 g |
| dried mushroom | 4 pieces |
| water | 700 ml |

Seasoning

salt taste

Container

Covered 300 ml
stew pot×4, metal tray,
wire rack (lower shelf),
integrated water tank



Method

1. Soak dried mushroom in water in advance, clean and blanch pork ribs.
2. Cut carrot into big chunks without peel. Cut sweet corn into about 2 cm slices.
3. Place wire rack on the metal tray. Place step 1 and step 2 ingredients evenly in 4 stew pots respectively. Add water covered and place them evenly on the wire rack in the lower shelf position.
4. Fill water tank.
5. Select Auto Menus No.9, then press **Start** to cook.
6. After cooking, take food out and add salt.

Note:

The ingredients listed in this recipe are for 4 serves. For multiple servings, calculate the material quantities according to the proportion.

Fried Shrimp with Bread Crumbs

(1 level / 2 levels)

10



Ingredients (1 level, 16 pcs)

| | |
|-----------------|----------------------|
| shelled shrimps | 400 g (about 16 pcs) |
| beaten egg | 20 g |
| bread crumbs | 40 g |
| shredded ginger | 5 g |

Seasonings

| | |
|--------------|-------|
| oil | 30 g |
| salt | taste |
| cooking wine | 5 g |

Container

Metal tray (lower shelf)



Method

1. Remove head, shells and devein shrimps. Only leave the tail and the shell of the first joint. Add shredded ginger, salt and cooking wine for marinating.
2. Put bread crumbs and oil into a bowl, and stir evenly.
3. Place baking paper on the metal tray. Coat shrimps with beaten egg and bread crumbs after drying the shrimps, and place them on the metal tray in 4×4 formation evenly.
4. Select Auto Menus No.10 and level and press **Start** to preheat. After preheating, place the metal tray in the lower shelf position and press **Start** to cook.

Note:

The ingredients listed in this recipe are for 400 g fried shrimp (1 level). For 2 levels, calculate the material quantities according to the proportion. Place metal tray in the upper and lower shelf position and select "2 levels".

English

Auto Cook Setting and Menus

(continued)

English

Fried Fish Fillets

(1 level / 2 levels)

11



Ingredients (1 level, 350 g)

belt fish 350 g (about 12 pieces)
corn starch 15 g

Seasonings

cooking wine 12 g
salt taste
oil 15 g

Container

Metal tray (lower shelf)



Method

1. Clean belt fish and cut into about 5 cm each.
2. Mix fish with cooking wine and salt and then marinate for 30 minutes.
3. Place baking paper on the metal tray, drizzle with a little oil on fish after coating with a thin layer of corn starch, then arrange in 3×4 formation.
4. Select Auto Menus No.11 and level, and press **Start** to preheat. After preheating, put metal tray in the lower shelf position and press **Start** to cook.

Notes:

1. The ingredients listed in this recipe are for 350 g fish fillet (1 level). For 2 levels, calculate the material quantities according to the proportion. Place metal tray in the upper and lower shelf position and select "2 levels".
2. If fish fillet is thick, add convection time manually according to the condition.
3. Thin fish fillet is recommend for getting a better color performance.

Home-made Yoghurt

(4-8 cups)

12



Note:

This auto menu will run for 5 hours.

Ingredients

| weight | 4 cups | 8 cups |
|---------|--------|--------|
| milk | 475 g | 950 g |
| yoghurt | 60 g | 120 g |

Container

Cups with 150 ml×4

Metal tray (lower shelf)



Method

1. Pour milk in a casserole and heat up to 45 °C, add yoghurt and mix well, then pour into a cup evenly about 130 g per cup.
2. Cover each cup with plastic wrap, then put on the metal tray in the lower shelf position.
3. Select Auto Menus No.12 and press **Start** to cook.

Notes:

1. For multiple cups, calculate the material quantities according to the proportion.
2. When the cavity overheats, "U50" will appear in the display window. Please wait until the cavity cools down, and start operation after "U50" disappears.

Auto Cook Setting and Menus

(continued)

Barbecue Pork (400/600/800 g) 13



Ingredients

pork shoulder (or pork belly)400 g
maltose (or honey)30 g
water30 ml

Seasonings

dark soy sauce20 g
light soy sauce30 g
red preserved bean curd80 g
castor sugar90 g
five-spice powder2 g
smashed garlic10 g
oyster sauce50 g
red vinasse and red
fermented bean curd juice35 g

Container

Metal tray, wire rack (lower shelf)



Method

1. Pour all seasonings into bowl, stir evenly and become honey-stewed B.B.Q pork sauce.
2. Clean the pork shoulder and drain well, then cut into long pieces about 4 cm thickness. Lay pork shoulder in a seal box (stick using a fork several times to make it more palatable), add enough pork sauce (cover the pork). Marinate in refrigerator for 1 to 2 days.
3. Drain marinated pork and placed on a wire rack, then put wire rack on the metal tray with an aluminum foil.
4. Select Auto Menus No.13 and weight, press **Start** to preheat. After preheating, place the metal tray in the lower shelf position, and press **Start** to cook.
5. Mix maltose and water to sugar water. Take food out when heard beeps, grease the surface of barbecue pork with a brush dipped in sugar water and turn it over then put it back to the oven. Press **Start** to cook. (The oven will beep twice between programmed stages.)

Notes:

1. The ingredients listed in this recipe are for 400 g pork shoulder. For multiple weights, calculate the material quantities according to the proportion.
2. When cooking 800 g barbecue pork, place 2 wire racks on the 2 metal trays with 400 g pork shoulder respectively. Then put them in the upper and lower shelf position and select "800 g".
3. Close oven door is recommended to keep cavity temperature when greasing maltose water.

Teriyaki Chicken Wings (1 level / 2 levels) 14



Ingredient (1 level, 12 pcs)

chicken wings 400 g (12 pcs)

Seasonings

light soy sauce 30 g
oyster sauce 30 g
castor sugar 5 g
sesame oil 3 g

Container

Metal tray, wire rack
(lower shelf),
integrated water tank



Method

1. Wash chicken wings and prick chicken surface several times with fork or bamboo stick.
2. Mix chicken wings with all seasonings and marinate for 30 minutes.
3. Place marinated chicken wings skin side up on the wire rack after drain well with 3×4 formation on the metal tray with an aluminum foil.
4. Fill water tank.
5. Select Auto Menu No.14 and level, press **Start** to preheat. After preheating, place the metal tray in the lower shelf position and press **Start** to cook.

Note:

The ingredients listed in this recipe are for 12 pieces chicken wings. For 2 levels, calculate the material quantities according to the proportion. Place metal tray in the upper and lower shelf position and select "2 levels".

English

Auto Cook Setting and Menus

(continued)

English

Egg Tarts (1 level / 2 levels) 15



Ingredient (1 level, 9 pcs)

egg tart skin 9 pcs

Egg tart batter

whipping cream 105 g
milk 85 g
cake flour 8 g
castor sugar 30 g
egg yolk 2 pcs
condensed milk 10 g

Container

Metal tray (lower shelf) 

Method

1. Frozen egg tart skin can use when it defrost at room temperature.
2. Mixture of whipping cream, milk, condensed milk and castor sugar in a small pot are heated by low fire. Heat and stir until castor sugar melt when cool down (about 45 °C). Add egg yolk and cake flour and stir well to egg tart batter.
3. Pour egg tart batter into egg tart skin, 80% full.
4. Select Auto Menus No.15 and level and press **Start** to preheat.
5. Arrange egg tart with 3×3 formation on the metal tray.
6. After preheating, place the metal tray in the lower shelf position and press **Start** to cook.

Note:

The ingredients listed in this recipe are for 9 pieces egg tarts on 1 level and calculate the material quantities according to the proportion. Each level can put 9 pieces when cooking 2 levels. Place the metal tray in the upper and lower shelf positions and select "2 levels".

Cookies (1 level / 2 levels) 16



Ingredients (2 levels, 40 pcs)

unsalted butter 160 g
cake flour 155 g
icing sugar 35 g
salt 0.6 g
corn starch 35 g
milk powder 20 g

Container

Metal tray (upper and lower shelf) 

Method

1. Take unsalted butter out in advance, soften it at room temperature, add icing sugar and salt and stir with eggbeater until it is fluffy.
2. Mix cornstarch, cake flour and milk powder and put through a sieve. Mix evenly with rubber scraper to batter for cooking.
3. Insert either a #8, or #12, decorating tip, and the ingredients from Step 2 into the pastry bag.
4. Place baking paper on the metal tray. Squeezing pastry out with 3 cm diameter and 8 g - 9 g weight and arrange 4×5 formation.
5. Select Auto Menus No.16 and level and press **Start** to preheat.
6. After preheating, place the metal tray in the upper and lower shelf position and press **Start** to cook.

Note:

The ingredients listed in this recipe are for 2 levels of cookies, and calculate the material quantities according to the proportion when you cook 1 level. Place the metal tray in the lower shelf position and select "1 level".

Auto Cook Setting and Menus

(continued)

Cheese Cake (7 inch)

17



Ingredients

Cake base:

digestive biscuit 100 g
unsalted butter 40 g

Cake batter:

cream cheese 250 g
castor sugar 90 g
sour cream 130 g
unsalted butter 33 g
vanilla bean 1/3 piece
whole egg liquid 81 g
egg yolk 27 g
corn starch 15 g

Container

7 inch cake tin, metal tray
(lower shelf), integrated
water tank

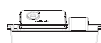

Method

Cake base:

1. Smash digestive biscuit in a plastic food bag and crush with rolling pin.
2. Melt unsalted butter completely and mix well with biscuit crumbs.
3. Pour the mixture into tin bottom and inside with baking paper and press firmly and put the cake tin in refrigerator to serve.

Cake batter:

1. Cut cream cheese and unsalted butter into small pieces and let stand naturally until soft. Open vanilla bean and take vanilla seeds out for later use.
2. Stir together cream cheese, castor sugar, and vanilla seed in a mixer then beat until the texture is smooth.
3. Stir soften unsalted butter and sour cream well after each addition.
4. Mix whole egg liquid and egg yolk with 3 times to add in, stir thoroughly after each addition.
5. Add the sifted corn starch and stir quickly and evenly with a hand-held whisk.
6. Fill water tank.
7. Select Auto Menus No.17 and press **Start** to preheat.
8. Take out cake tin from refrigerator, fill in the batter, smooth the surface and use a bamboo stick to remove bubbles from the surface.
9. After preheating, place cake tin on the metal tray in the lower shelf position and press **Start** to cook.
10. Remove cake tin after cooking and let it cool down, then put cake in refrigerator about 4 hours and serve.

English

Home-made Pizza

(1 level / 2 levels)

18



Ingredients (1 level, 1 pc)

Base ingredients:

| | |
|-----------------------|-------|
| cake flour | 130 g |
| castor sugar | 10 g |
| unsalted butter | 10 g |
| milk powder | 7 g |
| salt | 3 g |

Fillings:

| | |
|---------------------------|------|
| chopped onions | 20 g |
| sliced mushroom | 20 g |
| sliced sausage | 30 g |
| sliced green pepper | 20 g |

| | |
|--------------------------|-------|
| warm water (40 °C) | 70 ml |
| yeast | 3 g |
| castor sugar | 1 g |
| mozzarella cheese | 80 g |
| tomato paste | 40 g |

| | |
|------------------|-----------------------|
| oil | taste (coating) |
| cake flour | taste (anti-sticking) |

Container

Heat-proof container,
metal tray (lower shelf)



Method

1. Stir yeast and 1 g castor sugar mixture in warm water and wait for 5 minutes.
2. To make the dough by hand, in a large bowl, add yeast water and stir together all the base ingredients, grease oil in the heat-proof container, spread out the dough in a container, cover loosely with plastic wrap, place the container in the center of metal tray and put metal tray in the lower shelf position.
3. Select Auto Menus No.18 and level and press **Start** to ferment. It will remind you to take out the metal tray and container with promoting beeps. Then press **Start** to preheat.
4. Drizzle lightly cake flour on the work surface, then flatten the dough with hands to allow inside air to escape.
5. Place baking paper in the metal tray. Roll out the dough in about 20 cm diameter round and transfer to metal tray. Then lift the dough and give it a quarter turn.
6. Prick the base and apply tomato paste, sprinkle with half mozzarella cheese and the rest fillings, then top with remaining cheese.
7. After preheating, place the metal tray in the lower shelf position and press **Start** to cook.

Notes:

1. The ingredients listed in this recipe are for 1 home-made pizza. For 2 pizzas, calculate the material quantities according to the proportion. Place metal tray in the upper and lower shelf position and select "2 levels".
2. When the cavity overheats, "U50" will appear in the display window. Please wait until the cavity cools down, and start operation after "U50" disappears.
3. Home-made pizza should be placed in the oven within 30 minutes when preheating is completed, if not, the program will end automatically.

Reheating Chart

Note: In page 37 to 39, marking “①” means that cooking by metal tray. Symbol “②” means wire rack in metal tray.

| Sorts | Foods | Weight | Accessories | Program | Time |
|--|------------------------------|----------------------------------|--------------------------------------|--------------------------------------|----------------------------------|
| Chilled/ Frozen Pastry | Chilled Shumai* | 207 g (9 pcs) | ② / lower shelf | Steam-Med | chilled : about 10 to 11 minutes |
| | | | | | frozen : about 12 to 13 minutes |
| | Chilled Vermicelli Roll* | 200 g (5 pcs) | ② / lower shelf | Steam-Med | chilled : about 8 to 9 minutes |
| | | | | | frozen : about 11 to 12 minutes |
| | Chilled Sticky Rice Chicken* | 160 g - 320 g (2 pcs - 4 pcs) | ② / lower shelf | Steam-Med | chilled : about 16 to 18 minutes |
| | | | | | frozen : about 23 to 24 minutes |
| | Chilled Buns* | 100 g - 200 g (4 pcs - 8 pcs) | ② / lower shelf | Steam-Med | chilled : about 8 to 9 minutes |
| Chilled Rice* | 200 g - 300 g (1 serve) | ② / lower shelf | Steam-Med | chilled : about 14 to 16 minutes | |
| | | | 190 °C Steam Conv. (without preheat) | frozen : about 20 to 22 minutes | |
| Chilled Pizza | about 320 g (1 pizza) | ① / lower shelf | 230 °C Convection (with preheat) | chilled : about 11 to 12 minutes | |
| | | | | frozen : about 15 to 16 minutes | |
| Chilled Dish | Baked Chicken in Salt (pcs)* | 200 g - 400 g (1 dish) | ② / lower shelf | Steam-High | about 9 to 10 minutes |
| | Chilled Chicken Wings* | about 300 g (10 pcs) | ② / lower shelf | 190 °C Steam Conv. (without preheat) | about 11 to 12 minutes |
| | Chilled Vegetable* | 200 g - 400 g (1 dish) | ② / lower shelf | Steam-Med | about 7 to 9 minutes |
| Chilled Beverage/ Porridge/ Soup | Chilled Milk* | 250 ml - 500 ml (1 cup - 2 cups) | ① / lower shelf (aluminum foil) | Steam-Med | about 7 to 8 minutes |
| | Chilled Porridge* | 200 g - 250 g (1 bowl) | ② / lower shelf (aluminum foil) | Steam-High | about 16 to 17 minutes |
| | Chilled Soup* | 200 g - 400 g (1 bowl - 2 bowls) | ② / lower shelf | Steam-Med | about 15 to 16 minutes |
| Chilled Bread | Croissant | 45 g - 180 g (1 pc - 4 pcs) | ① / lower shelf | 160 °C Convection (without preheat) | about 6 to 7 minutes |
| | Chilled Bread With Cheese | about 170 g (1 pc) | ① / lower shelf | 170 °C Convection (without preheat) | about 8 to 10 minutes |
| | Chilled Sandwich | 120 g - 480 g (1 pc - 4 pcs) | ① / lower shelf | 180 °C Convection (without preheat) | about 8 to 11 minutes |
| Bread | Pineapple Bread | 50 g - 100 g (1 pc - 2 pcs) | ① / lower shelf | 180 °C Convection (without preheat) | about 6 to 7 minutes |
| | Croissant | 80 g - 160 g (1 pc - 2 pcs) | ① / lower shelf | 170 °C Convection (without preheat) | about 7 to 8 minutes |
| | Cereal Bread | 165 g (1 pc) | ① / lower shelf | 180 °C Convection (without preheat) | about 8 to 9 minutes |
| | Soft Bread | about 170 g (1 pc) | ① / lower shelf | 180 °C Convection (without preheat) | about 6 to 7 minutes |
| | Thick Toast | 55 g - 110 g (1 pc - 2 pcs) | ② / lower shelf | 230 °C Convection (with preheat) | about 6 to 7 minutes |

Notes:

- The recipes marked with “*” require steam function. Be sure to fill the water tank before cooking.
- Please use baking paper or aluminium foil and heat-proof utensils before cooking.
- Frozen refers to storage temperature is under 0 °C. Chilled refers to storage temperature in the range of 0-3 °C.

Cooking Chart

English

| Foods | Weight | Accessories | Program | Time | Statement |
|-----------------------------|--------------------------------------|-----------------|--------------------------------------|------------------------|--|
| Steamed Dazha Crabs* | 3 pairs (6 pcs) about 100-150 g each | ② / lower shelf | Steam-High | about 18 to 20 minutes | Wash Dazha crabs, and place on wire rack, belly up, along with ginger slices. |
| Steamed Salmon* | 300 g (2 pcs) | ② / lower shelf | Steam-Med | about 11 to 13 minutes | Clean and dry salmon. Sprinkle some salt and fish sauce for 15 minutes marination. |
| Steamed Canned food* | 1 can | ① / lower shelf | Steam-Med | about 15 minutes | All kinds of tins sold in the market. |
| Steamed Eggs with Clams* | 3 serves | ② / lower shelf | Steam-Med | about 10 to 11 minutes | Wash 250 g clam and cooked until the clam begin to open, then put them on the heat-proof dish. |
| | | | | about 17 to 18 minutes | Break 3 eggs and add 300 g pure water about 40 °C, seasoned, filtered and pour over the dish with the clam (cover plastic wrap). |
| Frozen Spring Roll | 8 pcs (about 260 g) | ② / lower shelf | 230 °C Convection (with preheat) | about 15 to 17 minutes | Sold in the market or homemade. Coat oil on the surface. |
| Roast Beef Skewers | 8 skewers (160 g) | ② / lower shelf | 180 °C Convection (with preheat) | about 10 minutes | All kinds of frozen beef skewers sold in the market. Grease oil on the surface after defrosting. |
| Lamb Kebab | 12 skewers (250 g) | ② / lower shelf | 180 °C Convection (with preheat) | about 12 minutes | All kinds of frozen kebabs sold in the market. You need defrost first. |
| Roasted Vegetables | 350 g | ① / lower shelf | 220 °C Convection (with preheat) | about 14 to 16 minutes | Other root vegetables such as eggplants, green peppers, carrots, potatoes and asparagus should wash and cut into appropriate sizes. Add crushed black pepper, soy sauce, and olive oil to marinate for 10 minutes. |
| Chicken Wing | 400 g (6 pcs) | ② / lower shelf | 210 °C Convection (with preheat) | about 20 to 23 minutes | All kinds of chilled semi-finished product sold in the market. |
| Steamed sweet corn* | 500 g - 600 g | ② / lower shelf | Steam-Med | about 35 to 40 minutes | Sweet corn. (sliced) |
| Steamed Rice* | 200 g | ② / lower shelf | Steam-Med | about 40 minutes | Mix 200 g rice and 200 g water. After cooking, cover with plastic wrap and wait for 5 minutes. |
| Peach Gum Sweet Soup | 6 cups (200 ml each) | ② / lower shelf | Stew | about 3 hours | Wash 15 g peach gum, after soaking for 10 hours, place them evenly into 6 cups respectively, add water and covered with lid. |
| Soup* | 4 cups (300 ml each) | ② / lower shelf | Stew | about 3 hours | Prepare 300 g rib and chicken ,etc. Cut pieces and pour into water with cover. |
| Baked Quail Eggs with Salt* | 24 pcs | ① / lower shelf | 190 °C Steam Conv. (with preheat) | about 16 to 18 minutes | Take 2 packs of coarse salt and stir-fried in the pan firstly. Spread a thin layer of coarse salt inside the tin foil and put quail egg on it. Then cover the quail eggs completely with coarse salt. |
| Roast Cashew Nut | 500 g | ① / lower shelf | 110 °C Convection (with preheat) | about 60 minutes | Sold in the market. |
| Chicken Skewers | 300 g (8 skewers) | ② / lower shelf | 190 °C Convection (with preheat) | about 12 to 15 minutes | Sold in the market and defrosted. |
| Frozen Egg Tart | 150 g - 300 g (4 pcs - 8 pcs) | ① / lower shelf | 200 °C Convection (with preheat) | about 16 to 18 minutes | All kinds of frozen egg tart sold in the market. |
| Fried Short Rib | 250 g (3 pcs) | ② / lower shelf | 210 °C Convection (with preheat) | about 7 to 9 minutes | Dry short ribs, drizzle salt and chop black pepper for marinate a few moment. |

Cooking Chart

(continued)

English

| Foods | Weight | Accessories | Program | Time | Statement |
|----------------------------------|-----------------------|-----------------|--|------------------------|---|
| Fried Frozen Hash Browns | 260 g (4 pcs) | ② / lower shelf | 220 °C Convection (with preheat) | about 18 to 20 minutes | Cook directly without defrosting. Different potatoes products need different cooking time depends on the pre-fried extent and thickness conduction. Please adjust cooking time according to the actual condition. |
| French Fries | 250 g | ① / lower shelf | Healthy Fry (with preheat) | about 28 to 30 minutes | |
| Fried Spare Ribs with Spicy Salt | 200 g | ① / lower shelf | Healthy Fry (with preheat) | about 16 to 17 minutes | Sold in the market. |
| Fried Chicken Nugget | 350 g | ② / lower shelf | Healthy Fry (with preheat) | about 19 to 21 minutes | Cut chicken thigh into 30 g each pieces and coat fried chicken powder. Then marinate for 15-20 minutes. |
| Beef Steak with Black Pepper | 1 pc (200 g each) | ② / lower shelf | 220 °C Convection (with preheat) | about 11 to 12 minutes | Dry steak and drizzle some salt and chop black pepper to marinate for 5-10 minutes. (After cooking, take out steak quickly and pack with aluminium foil. Standing for 3 minutes and serve.) |
| | 2 pcs (200 g each) | | | about 13 to 14 minutes | |
| Frozen Cod Fillet | 380 g (8 pcs) | ② / lower shelf | Healthy Fry (with preheat) | about 29 to 30 minutes | Sold in the market and grease oil on the surface. |
| Frozen Pizza | 1 pc (320 g) | ① / lower shelf | 230 °C Convection (with preheat) | about 15 to 16 minutes | All kinds of frozen pizza sold in the market. |
| Baked Sausage | 400 g (6 pcs) | ② / lower shelf | 190 °C Convection (with preheat) | about 14 to 16 minutes | Sold in the market. Grease bake barbecue sauce or your favorite sauce. (Cut with knife to avoid bursting.) |
| Defrost Minced Meat* | 400 g - 500 g | ① / lower shelf | 40 °C Fermentation | about 30 to 35 minutes | Remove food package and place on heat-proof dish. Press Start button for 2 seconds and press again to add 2 minutes steam. Turn over food when cooking to half time. After cooking, wait for 5-10 minutes. |
| Defrost Drumsticks* | 500 g | ① / lower shelf | 40 °C Fermentation | about 40 minutes | |
| Defrost Chicken Wings* | 400 g - 500 g | ① / lower shelf | 40 °C Fermentation | about 40 minutes | |
| Defrost Fish* | 400 g - 500 g | ① / lower shelf | 30 °C Fermentation | about 35 to 40 minutes | |

Notes:











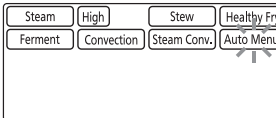

1. The recipes marked with “*” require steam. Be sure to fill the water tank before cooking.
2. Frozen refers to storage temperature is under 0 °C. Chilled refers to storage temperature in the range of 0-3 °C.
3. Please use baking paper or aluminium foil and heat-proof utensils before cooking.
4. When the cavity overheats, or room temperature is too high, “U50” maybe appear in the display window. This is to avoid high temperature effecting the fermentation/defrosting. Please wait until the cavity or room temperature cools down, and start fermenting/defrosting again after “U50” disappears.

Cleaning (Utensils)

English

Cleaning (Utensils)

This function is suitable for all kinds of dish cleaning. (need 30 minutes)

| | | | |
|--|--|--|---|
| <p>1</p>  <p>Select</p> | <p>☰</p>  | <p>Place wire rack with utensils on the metal tray in the lower shelf position. Then select Auto Menu by pressing Select button.</p> |  |
| | | | |
| <p>2</p>  <p>Start/Set</p> |  | <p>Press Set button to set Auto Menu.</p> |  |
| | | | |
| <p>3</p>  <p>Select</p> |  | <p>Press Select button until “19” appear in the display window.</p> |  |
| | | | |
| <p>4</p>  <p>Start/Set</p> |  | <p>Press Start button once.</p> |  |

Notes:



1. High temperature will occur when using steam to wash dishes. All dishes must be heat-proof (for over 130 °C) before using this function.
2. Fill the tank with water before using.
3. When the cavity overheats, “U50” will appear in the display window. Please wait until the cavity has cooled down, and continue to clean the utensils after “U50” disappears.

Cleaning (Feeding Bottles)

Cleaning (Feeding Bottles)

This function is used for all kinds of feeding bottles.

English

1   Place wire rack with feeding bottle on the metal tray in the lower shelf position. Then select **Auto Menu** by pressing **Select** button.

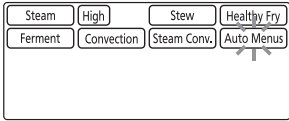



.....

2  Press **Set** button to set **Auto Menu**.





.....

3   Press **Select** button until “20” appear in the display window.



.....

4  Press **Start** button once.



Notes:

1. High temperature will occur when using steam to wash feeding bottles. All bottles and accessories must be heat-proof temperature over 110 °C before using this function.
2. Fill the tank with water before using.
3. When the cavity overheats, “U50” will appear in the display window. Please wait until the cavity has cooled down, and continue to clean the feeding bottles after “U50” disappears.
4. After cleaning, you should take feeding bottle out quickly.

Oven Cleaning Setting

English

Cleaning (Deodorization)

This function is suitable for ovens with odors (need 20 minutes). Before maintenance (cleaning the oven), please empty the oven and wipe inside dirt.

1 Select **Auto Menus** by pressing **Select** button.

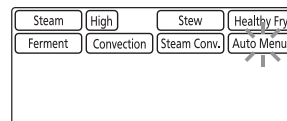
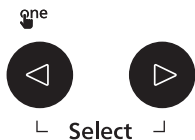

2 Press **Set** button to set **Auto Menus**.



3 Press **Select** button until "21" appear in the display window.

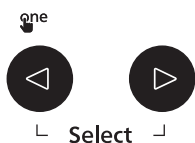

4 Press **Start** button once.





Oven Cleaning Setting

(continued)

Cleaning (Cavity)

This function is suitable for cleaning a dirty oven caused by oil (need 30 minutes).

English

1   Select **Auto Menus** by pressing **Select** button.

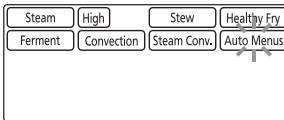



.....

2  Press **Set** button to set **Auto Menus**.



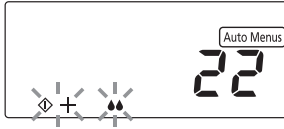

.....

3   Press **Select** button until "22" appear in the display window.



.....

4  Press **Start** button once.



Notes:

1. Fill the tank with water before using.
2. After cleaning, open the door and wipe it clean with a damp cloth.



Oven Cleaning Setting

(continued)

English

Cleaning (System)

After using steam function, this function can make the water pump through the pipe to the drip tray.

1   Select **Auto Menus** by pressing **Select** button.

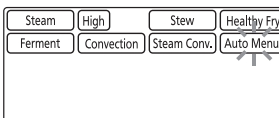

Note: Fill water tank with 100 ml water before using and remove the water from the drip tray.





| | | | |
|---------|------------|-------------|-------------|
| Steam | High | Stew | Healthy Fry |
| Ferment | Convection | Steam Conv. | Auto Menu |

2  Press **Set** button to set **Auto Menus**.



3   Press **Select** button until “23” appear in the display window.



4  Press **Start** button once.

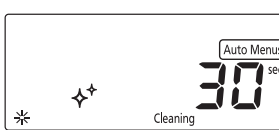

Notes:

1. Do not remove the integrated water tank when using this function.
2. Wash the drip tray clean after cleaning.







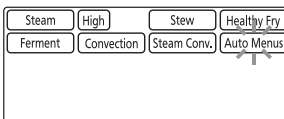

Oven Cleaning Setting

(continued)

English

Cleaning (with Citric Acid)

If “✧✧” appears in the display window after cooking, you should use citric acid to clean the water-piping. After using citric acid to clean, rinse with water again. Flush and clean water will drain into the drip tray. (need 30 minutes) Prepare detergent with approximately 20 g of citric acid dissolved completely in 250 ml of water, and pour the mixture into the integrated water tank of the oven directly.

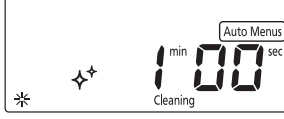
| | | | |
|----------|---|---|---|
| 1 |  | Select Auto Menu by pressing Select button. |  |
| 2 |  | Press Set button to set Auto Menu . Note: Empty the drip tray and check prepared detergent in the water tank. |  |
| 3 |  | Press Select button until “24” appear in the display window. |  |
| 4 |  | Press Start button once. |  |
| 5 | | After the program is automatically paused, you can remove water in drip tray and clean the water tank, then fill the tank with water. |  |
| 6 |  | Press Start button once. Program will continue 1 minute. |  |

Notes:

1. After cleaning, please wipe the residue in the water tank and wash the drip tray clean.
2. Do not remove the integrated water tank when using this function.

Care of Your Oven

English

Be sure to clean and maintain the oven after it is completely cold. Turn the oven off and remove the power supply plug from the wall socket before cleaning. A steam cleaner should not be used for cleaning.

The outside oven surfaces should be cleaned with a damp cloth. To prevent damage to the operating parts inside the oven, water should not be allowed to seep into the ventilation openings and air outlet.

Always clean the bottom plate, after cooling down, with a mild detergent and wipe to dry.

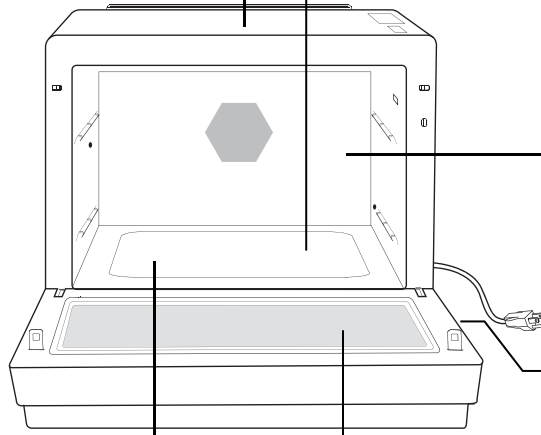

Keep the inside of the oven clean regularly. When food splatters or spilled liquids adhere to oven walls, wipe with a damp cloth. Mild detergent may be used if the oven gets very dirty. The use of harsh detergent or abrasives is not recommended. Any fat and grease that builds up on the roof and walls of the oven will begin to smoke if not cleaned. Clean the oven after it is completely cold.

Do not allow the Control Panel to become wet. Clean with a soft and dry cloth. Do not use the detergent of harsh or abrasives on the Control Panel. After cleaning, press **Stop/Reset** button to clear display window.

If steam accumulates inside or around the outside of the oven door, wipe with a soft cloth. This may occur when the oven is operated under high humidity conditions and in no way indicates malfunction of the unit.

Clean the door and oven window with a soft and damp cloth. Mild detergent may be used if the oven gets very dirty. Do not use harsh and abrasive cleaners to clean the oven window, since they can scratch the surface, which may result in shattering of the glass.

After using, clean with a mild detergent or dishwasher. Do not use abrasive cleaners to clean the metal tray and wire rack. (Such as steel wool, etc.)

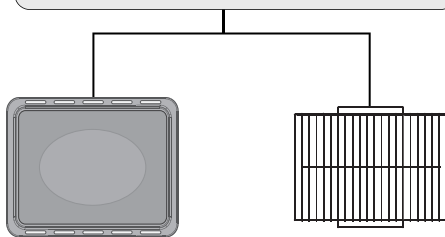

Always remove integrated water tank after use and clean it using a soft damp sponge with water.

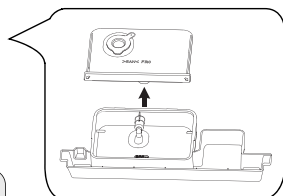

Before Requesting Service

PROBLEM

POSSIBLE CAUSE

REMEDY

English

No display on panel.

| | |
|--|---|
| The oven is not plugged in securely. | Remove plug from outlet, wait 10 seconds and re-insert. |
| Circuit breaker or fuse is tripped or blown. | Reinstall the fuse or reset the circuit breaker. |
| There is a problem with the outlet. | Plug another appliance into the outlet to check if the outlet is working. |
| There is a problem with the oven. | Please contact the service center specified by Panasonic. |

Oven cannot start operation.

| | |
|--|--|
| The door is not closed completely. | Close the oven door securely. |
| Start/Set button was not pressed after programming. | Press Start/Set button. |
| Another program has already been entered into the oven. | Press Stop/Reset button to cancel the previous program and program again. |
| The program has not been entered correctly. | Program again according to the operating instructions. |
| Stop/Reset button has been pressed accidentally. | Program oven again. |

No steam.

| | |
|--|--|
| Check whether the water tank has water. | Fully fill the water tank and properly install it. |
| Check whether the integrated water tank is installed correctly in place. | |

"U14" appears in the display window.

| | |
|---|---|
| The water tank lacks water. Even it is full of water, "U14" will appear in the display window in different conditions. | "U14" appears in the first two cooking stages, you can refill water and press Start/Set button to continue. It is not available if "U14" appears in the third time. Please fill the water tank with water again. Replace to the oven and press Stop/Reset to reset. |
| If it is not cleaned in time after "✧*" appears in the display window, scale will accumulate around the inner wall of the water-piping. | Please use the citric acid cleaning function to clean the water-piping. |

Before Requesting Service

(continued)

English

PROBLEM

POSSIBLE CAUSE

REMEDY

"U50" appears in the display window.

The cavity temperature is overheated.

Operate again after cavity temperature cooling down and "U50" disappears.

White powder found at steam outlet, drip tray and oven cavity.

The white powder is mineral crystal from evaporation of water, it is natural substance and harmless to human body.

You can use auto cleaning menu with Auto Menu 23&24 to clean the steam system and water supply pipe to improve condition. If crystal attached to the nozzle or in the oven cavity, please wipe and clean with a wring cloth. After using steam function or cleaning, pour out the water from the drip tray and wipe with a sponge.

If it seems there is a problem with the oven, contact an authorized Service Center by Panasonic.

Before Requesting Service

(continued)

English

ALL THESE THINGS ARE NORMAL:

| | |
|--|---|
| Sounds will occur when using the Steam function. | This is caused by air mixed when the water tank is working. It is normal. |
| The sound of "Bar... Bar..." may be emitted at the back of the oven cavity during and after the use of different kinds of Convection function. | This is a cause of thermal expansion and contraction of the metal material used in the product. It is normal. |
| Steam accumulates on the oven door and warm air comes from the air outlet. | During cooking, steam and warm air are given off from the food. Most of the steam and warm air are removed from the air outlet by the air which circulates in the oven cavity. However, some steam will condense on cooler surfaces such as inside or on the oven door. It is normal. |
| Steam leaks out from all four sides of the oven door. | When a function related to steam is used, a lot of steam are generated in the oven cavity during operation of the product. Some steam may leak from all four sides of the oven door. It is normal. |
| I accidentally operated my oven without any food in it. | Operating the oven empty for a short time will not damage the oven, however, it is not recommended. |
| The oven has an odor, and generates smoke, when using Convection and Steam Convection function. | It is essential that your oven is wiped out regularly, particularly after cooking by Convection and Steam Convection. Any fat and grease that builds up on the roof and walls of the oven will begin to smoke if not cleaned. |
| The fan motor continues operating after cooking is over. | After using the oven, the fan motor will operate for several minutes to cool the oven and electric components. It is normal. |
| The rear side of the oven's color has yellowing. | Metal ions will generate yellow marks when heated. It is normal that will not affect the use of the oven and harm to human health. |
| Door seal maybe deformed. | The door seal may be distorted due to high temperature. It is normal and will not affect the performance of use of the oven. |
| Some smoke and odor will be given off from the cavity when using different kinds of Convection functions for the first time. | It is caused by the excessive oil in the cavity used for rust protection. |
| The part where the power supply cord connects to the product's bottom plate has loosened. | It is normal. |

WARRANTY

Panasonic Canada Inc.

5770 Ambler Drive, Mississauga, Ontario L4W 2T3

PANASONIC PRODUCT – LIMITED WARRANTY

Panasonic Canada Inc. warrants this product to be free from defects in material and workmanship under normal use and for a period as stated below from the date of original purchase agrees to, at its option either (a) repair your product with new or refurbished parts, (b) replace it with a new or a refurbished equivalent value product, or (c) refund your purchase price. The decision to repair, replace or refund will be made by Panasonic Canada Inc.

| Category | Service type | Parts | Labor |
|--------------------|--------------|---------|---------|
| Convection/Steamer | Carry-in | 2 Years | 2 Years |

This warranty is given only to the original purchaser, or the person for whom it was purchased as a gift, of a Panasonic brand product mentioned above sold by an authorized Panasonic dealer in Canada and purchased and used in Canada, which product was not sold "as is", and which product was delivered to you in new condition in the original packaging.

IN ORDER TO BE ELIGIBLE TO RECEIVE WARRANTY SERVICE HEREUNDER, A PURCHASE RECEIPT OR OTHER PROOF OF DATE OF ORIGINAL PURCHASE, SHOWING AMOUNT PAID AND PLACE OF PURCHASE IS REQUIRED

LIMITATIONS AND EXCLUSIONS

This warranty ONLY COVERS failures due to defects in materials or workmanship, and DOES NOT COVER normal wear and tear or cosmetic damage. The warranty ALSO DOES NOT COVER damages which occurred in shipment, or failures which are caused by products not supplied by Panasonic Canada Inc., or failures which result from accidents, misuse, abuse, neglect, mishandling, misapplication, alteration, faulty installation, set-up adjustments, misadjustment of consumer controls, improper maintenance, power line surge, lightning damage, modification, introduction of sand, humidity or liquids, commercial use such as hotel, office, restaurant, or other business or rental use of the product, or service by anyone other than a Authorized Servicer, or damage that is attributable to acts of God.

THIS EXPRESS, LIMITED WARRANTY IS IN LIEU OF ALL OTHER WARRANTIES, EXPRESS OR IMPLIED, INCLUDING ANY IMPLIED WARRANTIES OF MERCHANTABILITY AND FITNESS FOR A PARTICULAR PURPOSE. IN NO EVENT WILL Panasonic Canada Inc. BE LIABLE FOR ANY SPECIAL, INDIRECT OR CONSEQUENTIAL DAMAGES RESULTING FROM THE USE OF THIS PRODUCT OR ARISING OUT OF ANY BREACH OF ANY EXPRESS OR IMPLIED WARRANTY. (As examples, this warranty excludes damages for lost time, travel to and from the Authorized Servicer, loss of or damage to media or images, data or other memory or recorded content. This list of items is not exhaustive, but for illustration only.)

In certain instances, some jurisdictions do not allow the exclusion or limitation of incidental or consequential damages, or the exclusion of implied warranties, so the above limitations and exclusions may not be applicable. This warranty gives you specific legal rights and you may have other rights which vary depending on your province or territory.

WARRANTY SERVICE

For product information and operation assistance, please visit our Support page: www.panasonic.ca/english/support

PRODUCT REPAIRS

Please locate your nearest Authorized Servicentre: panasonic.ca/english/support/servicentrelocator

IF YOU SHIP THE PRODUCT TO A SERVICENTER

Carefully pack and send prepaid, adequately insured and preferably in the original carton. Include details of the defect claimed, and proof of date of original purchase.

Specifications

| | | |
|--|-------------|-------------------------------|
| Model Number | | NU-SC180B |
| Power Source | | 120 V, 60 Hz |
| Power Consumption | Steam | 9.3 A 1130 W |
| | Convection | 10.2 A 1230 W |
| | Steam Conv. | 10.2 A 1230 W |
| Output Power | Steam | 1100 W |
| | Convection | 1200 W |
| | Steam Conv. | 1200 W |
| Outside Dimensions (H × W × D) | | 376 mm × 404 mm × 404 mm |
| Outside Dimensions (With handle) (H × W × D) | | 376 mm × 404 mm × 438 mm |
| Oven Cavity Dimensions (H × W × D) | | 220 mm × 320 mm × 280 mm |
| Cavity Volume | | 20 L |
| Weight | | 12.3 kg (Without accessories) |

English

Specifications subject to change without notice.



Panasonic Canada Inc.
5770 Ambler Drive Mississauga, Ontario L4W 2T3
www.panasonic.com

F0003CF00CP
PA0321-0
Printed in China
Imprimé en Chine
中國印刷