

# Panasonic®

**Owner's Manual**  
**Microwave Oven**  
**Household Use Only**  
**Model No. NN-SV79MS**



**Scan this code for special instructions and features.**

**READ ALL INSTRUCTIONS CAREFULLY BEFORE USING THE OVEN.**

**For assistance, please contact us via the web at:**

<http://shop.panasonic.com/support> (U.S.A only)

**For microwave oven safety reference, please visit the FDA's web page at:**

<http://www.fda.gov/Radiation-EmittingProducts/default.htm>

**Para obtener instrucciones en español, por favor visite la página web en:**

<http://shop.panasonic.com/support>

# CONTENTS

<b>TERMS &amp; POLICIES</b> .....	1
<b>Safety Information</b>	
IMPORTANT SAFETY INSTRUCTIONS.....	2-3
Utensils.....	3
Radio Interference.....	4
Grounding Instructions.....	4-5
Installation.....	6
Food Preparation.....	6-7
Cookware Guide.....	8
<b>Operation</b>	
Location of controls.....	9
Display Window.....	10
Dial Feature .....	10
Operation.....	11-35
Setting up Alexa on your microwave oven..	11-12
Using the Microwave for the First Time.....	13
Disconnect wireless network/Factory reset.....	13
Demo Mode.....	14
Menu Action ON/OFF.....	14
Setting the Clock.....	15
Setting the Child Safety Lock.....	15
Cooking.....	16-17
Keep Warm.....	18
Quick 30.....	19
Setting the Kitchen Timer.....	20
Setting a Standing Time.....	21
Setting a Delayed Start.....	22
3-Stage Setting .....	23
Add Time.....	24
Popcorn.....	25
Turbo Defrost.....	26-27
Sensor Reheat.....	28
Auto/Sensor cook.....	29-34
Beverage/Soup(No.1-3).....	30
Sensor Cook(No.4-14).....	31-32
Frozen Pancake/Reheat Desert(No.15-16).....	33
Melt & Soften(No.17-20).....	34
MICROWAVE RECIPES.....	35
Voice Command Chart.....	36-39
Food Characteristics.....	40
<b>Maintenance</b>	
Care and Cleaning of Your Microwave Oven.....	41
Shop Accessories.....	41
Before Requesting Service.....	42
Limited Warranty.....	43
<b>General Information</b>	
Copyright Information.....	44-54
Specifications.....	55
User's Record.....	58

# TERMS & POLICIES

## **AMAZON TERMS & POLICIES**

Your microwave oven works with Amazon Alexa.

By using your microwave oven, you agree to Amazon's Conditions of Use, available at [www.amazon.com/conditionsofuse](http://www.amazon.com/conditionsofuse), and all the terms located at [www.amazon.com/devicesupport](http://www.amazon.com/devicesupport) or found in the Alexa App in Help & Feedback > Legal & Compliance. You can find Amazon's Privacy Notice in the Help section of the Alexa App or at [www.amazon.com/privacy](http://www.amazon.com/privacy).

## **CONTACT US**

Servicing your appliance, go to <http://shop.panasonic.com/support>  
Assistance with Alexa, please contact Amazon Customer Support.  
Contact details can be found at [www.amazon.com/devicesupport](http://www.amazon.com/devicesupport).



# IMPORTANT SAFETY INSTRUCTIONS

## Your safety and the safety of others are very important.



We have provided important safety messages in this manual and on your appliance. Always read and obey all safety messages.

This is the safety alert symbol. It is used to alert you to potential hazards that can kill or hurt you and others.

All safety messages will follow the safety alert symbol and either the word "DANGER", "WARNING" or "CAUTION". These words mean:

### **DANGER**

You can be killed or seriously injured if you don't immediately follow instructions.

### **WARNING**

You can be killed or seriously injured if you don't follow instructions.

### **CAUTION**

You can be exposed to a potentially hazardous situation which, if not avoided, may result in minor or moderate injury.

All safety messages will tell you what the potential hazard is, tell you how to reduce the chance of injury, and tell you what can happen if the instructions are not followed.



## PRECAUTIONS TO AVOID POSSIBLE EXPOSURE TO EXCESSIVE MICROWAVE ENERGY

- (a) **DO NOT** attempt to operate this oven with the door open since open-door operation can result in harmful exposure to microwave energy. It is important not to defeat or tamper with the safety interlocks.
- (b) **DO NOT** place any object between the oven front face and the door or allow soil or cleaner residue to accumulate on sealing surfaces.
- (c) **DO NOT** operate the oven if it is damaged. It is particularly

important that the oven door close properly and that there is no damage to the:

- (1) DOOR (bent),
- (2) HINGES AND LATCHES (broken or loosened),
- (3) DOOR SEALS AND SEALING SURFACES.
- (d) The oven should not be adjusted or repaired by anyone except properly qualified service personnel.

## Thank you for purchasing a Panasonic Microwave Oven

When using electrical appliances basic safety precautions should be followed, including the following.

### **WARNING**

To reduce the risk of burns, electric shock, fire, injury to persons, or exposure to excessive microwave energy:

1. Read all instructions before using the appliance.
2. Read and follow the specific: "**PRECAUTIONS TO AVOID POSSIBLE EXPOSURE TO EXCESSIVE MICROWAVE ENERGY**" above.
3. This appliance must be grounded. Connect only to properly grounded outlet. See "**GROUNDING INSTRUCTIONS**" found on page 4.
4. Install or locate this appliance only in accordance with the provided installation instructions.
5. As with any appliance, close supervision is necessary when used by children.
6. When cleaning surfaces of door and oven that comes together on closing the door, use only mild, nonabrasive soaps, or detergent applied with a sponge or soft cloth.
7. Keep cord away from heated surface.
8. Liquids, such as water, coffee, or tea are able to overheat beyond the boiling point without appearing to be boiling. Visible bubbling or boiling when the container is removed from the microwave oven is not always present. **THIS COULD RESULT IN VERY HOT LIQUID SUDDENLY BOILING OVER WHEN THE CONTAINER IS DISTURBED OR A UTENSIL IS INSERTED INTO THE LIQUID.**  
To reduce the risk of injury to persons:
  - (a) **DO NOT** overheat the liquid.

# ! IMPORTANT SAFETY INSTRUCTIONS (continued)

- (b) Stir the liquid both before and halfway through heating it.
  - (c) **DO NOT** use straight-sided containers with narrow necks.
  - (d) After heating, allow the container to stand in the microwave oven for a short time before removing the container.
  - (e) Use extreme care when inserting a spoon or other utensil into the container.
9. This appliance should be serviced only by qualified service personnel. Contact nearest authorized service facility for examination, repair, or adjustment.
  10. To reduce the risk of fire in the oven cavity:
    - (a) **DO NOT** overcook food. Carefully attend appliance when paper, plastic, or other combustible materials are placed inside the oven to facilitate cooking.
    - (b) Remove wire twist-ties from paper or plastic bag before placing bag in oven.
    - (c) If material inside of the oven ignites, keep oven door closed, turn oven off, and disconnect the power cord, or shut off power at the fuse or circuit breaker panel.
    - (d) **DO NOT** use the cavity for storage purposes. **DO NOT** leave paper products, cooking utensils, or food in the cavity when not in use.
  11. Some products such as whole eggs and sealed containers, for example, closed glass jars are able to explode and should not be heated in this oven.
  12. **DO NOT** store this appliance outdoors. **DO NOT** use this product near water - for example, near a kitchen sink, in a wet basement, near a swimming pool, or similar location.
  13. **DO NOT** immerse cord or plug in water or any other liquid.
  14. Use this appliance only for its intended use as described in the manual. **Do not** use corrosive chemicals or vapors in this appliance. This type of oven is specifically designed to heat, cook or dry food. It is not designed for industrial or laboratory use.
  15. **DO NOT** operate this appliance if it has a damaged cord or plug, if it is not working properly, or if it has been damaged or dropped.
  16. **DO NOT** cover or block any openings on the appliance.
  17. **DO NOT** let cord hang over edge of table or counter.

## SAVE THESE INSTRUCTIONS HOUSEHOLD USE ONLY (NOT FOR COMMERCIAL USE)



### UTENSILS

#### ! CAUTION

##### Personal Injury Hazard:

Tightly-closed utensils could explode. Closed containers should be opened and plastic pouches should be pierced before cooking.

See the instructions on "Materials you can use in microwave oven." or "Materials can not be used in microwave oven."

There may be certain non-metallic utensils that are not safe to use for microwaving. If in doubt, you can test the utensil in question following the procedure below.

##### Utensil Test:

1. Fill a microwave-safe container with 1 cup of cold water (250ml) along with the utensil in question.

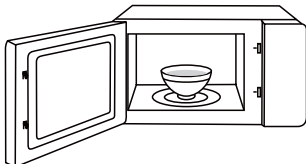

2. Cook on maximum power for 1 min.
3. Carefully feel the utensil. If the empty utensil is warm, do not use it for microwave cooking.
4. **DO NOT** exceed 1 min cooking time.

#### ! CAUTION

KEEP THE CAVITY CLEAN

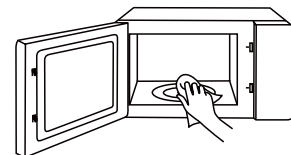



## RADIO INTERFERENCE

1. Operation of the microwave oven may cause interference to your radio, TV or similar equipment.
2. When there is interference, it may be reduced or eliminated by taking the following measures:
  - (a) Clean door and sealing surface of the oven.
  - (b) Reorient the receiving antenna of radio or television.
  - (c) Relocate the microwave oven with respect to the receiver.
  - (d) Move the microwave oven away from the receiver.
  - (e) Plug the microwave oven into a different outlet so that microwave oven and receiver are on different branch circuits.

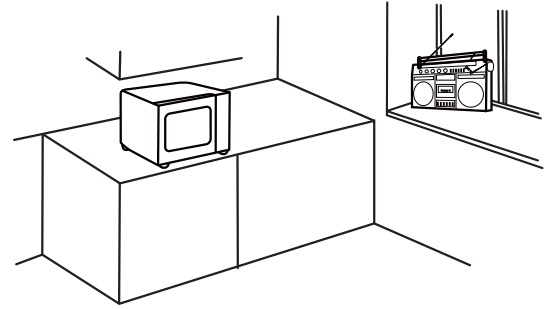

**This device complies with part 18 of the FCC Rules.**



## GROUNDING INSTRUCTIONS

### Grounding Instructions

#### **THIS APPLIANCE MUST BE GROUNDED.**

In the event of an electrical short circuit, grounding reduces the risk of electric shock by providing an escape wire for the electric current. This appliance is equipped with a cord having a grounding wire with a grounding plug. The plug must be plugged into an outlet that is properly installed and grounded.

### **! WARNING**

Improper use of the grounding can result in a risk of electric shock. Consult a qualified electrician or serviceman if the grounding instructions are not completely understood, or if doubt exists as to whether the appliance is properly grounded. If it is necessary to use an extension cord, use only a 3-wire extension cord that has a 3-blade grounded plug, and 3-slot receptacle that will accept the plug on the appliance. The marked rating of the extension cord shall be equal to or greater than the electrical rating of the appliance.

### **! DANGER**

#### **Electric Shock Hazard:**

Touching some of the internal components can cause serious personal injury or death. Do not disassemble this appliance.

### **! WARNING**

#### **Electric Shock Hazard:**

Improper use of the grounding can result in electric shock. Do not plug into an outlet until appliance is properly installed and grounded.

1. A short power-supply cord is provided to reduce the risks resulting from becoming entangled in or tripping over a longer cord.
2. Long cord sets or extension cords are not recommended.
3. If a long cord or extension cord is used:
  - (a) The marked electrical rating of the cord set or extension cord should be at least as great as the electrical rating of the appliance.
  - (b) The extension cord must be a grounding-type 3-wire cord.
  - (c) The longer cord should be arranged so that it will not drape over the counter top or tabletop where it can be pulled on by children or tripped over unintentionally.



# GROUNDING INSTRUCTIONS

## Grounding Instructions

### THIS APPLIANCE MUST BE GROUNDED.

In the event of an electrical short circuit, grounding reduces the risk of electric shock by providing an escape wire for the electric current. This appliance is equipped with a cord having a grounding wire with a grounding plug.

The plug must be plugged into an outlet that is properly installed and grounded.

- **Plug into properly installed and grounded three-prong outlet.**
- **DO NOT** remove ground prong.
- **DO NOT** use an adapter.

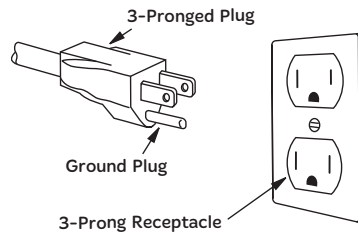

## Wiring Requirements

1. The oven must be operated on a DEDICATED CIRCUIT. No other appliance should share the circuit with the microwave oven. If it does, the branch circuit fuse may blow or the circuit breaker may trip.

2. The oven must be plugged into at least a 20 A, 120 V, 60 Hz GROUNDED OUTLET. Where a standard two-prong outlet is encountered, it is the personal responsibility and obligation of the consumer to have it replaced with a properly grounded three-prong outlet.

3. The VOLTAGE used must be the same as specified on this microwave oven (120 V, 60 Hz).

Using a higher voltage is dangerous and may result in a fire or oven damage. Using a lower voltage will cause slow cooking. Panasonic is NOT responsible for any damages resulting from the use of the oven with any voltage other than specified.

## TV / RADIO/WIRELESS EQUIPMENT INTERFERENCE

This product has been tested and found to comply with the limits for Microwave Oven, pursuant to Part 18 of the FCC Rules. This product can radiate radio frequency energy, which could cause interference to such products as radio, TV, baby monitor, cordless phone, Bluetooth, wireless router, etc., which can be confirmed by turning this product off and on. If present, the user is encouraged to try to correct by taking one or more of the following countermeasures:

- (1) Increase the spacing distance between the microwave oven and other product receiving the interference.
- (2) If possible, use a properly installed receiver antenna and/or reorient the receiving antenna of the other product receiving the interference.
- (3) Plug the microwave oven into a different outlet from the other product receiving the interference.
- (4) Clean door and sealing surfaces of the oven. (See Care and Cleaning of Your Microwave Oven)

# Installation

## Examine Your Oven

Unpack oven, remove all packing material and examine the oven for any damage such as dents, broken door latches or cracks in the door. Notify dealer immediately if oven is damaged. **DO NOT** install if oven is damaged.

## Placement of Oven

1. The oven must be placed on a flat, stable surface. For proper ventilation, a minimum clearance of 3.0 inches (7.5cm) is required between the oven and any adjacent walls and right side must be open. Leave a minimum clearance of 12 inches (30cm) above the oven.

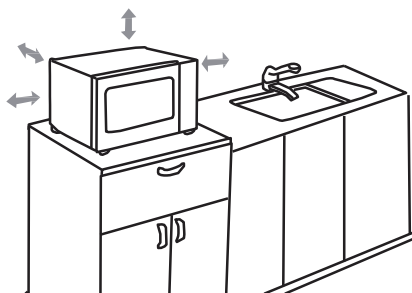

- (a) **DO NOT** block air vents. If they are blocked during operation, the oven may overheat and be damaged.
  - (b) **DO NOT** place oven near a hot, damp surface such as a gas or electric range, sink, or dishwasher.
  - (c) **DO NOT** operate oven when room humidity is excessive.
2. This oven is manufactured for household use only. It is not approved or tested for mobile vehicle, marine, or commercial use.

## Installation

1. **DO NOT** block air vents. If they are blocked during operation, the oven may overheat. If the oven overheats, a thermal safety device will turn the oven off. The oven will remain inoperable until it has cooled.

# Food Preparation

Follow these Safety Precautions when cooking in your oven.

## **IMPORTANT**

Proper cooking depends upon the power, the time setting and quantity of food. If you use a smaller portion than recommended but cook at the time for the recommended portion, fire could result.

### 1) HOME CANNING / STERILIZING / DRYING FOODS / SMALL QUANTITIES OF FOODS

- **DO NOT** use your oven for home canning. Your oven cannot maintain the food at the proper canning temperature. The food may be contaminated and then spoil.
- **DO NOT** use the microwave oven to sterilize objects (baby bottles, etc.). It is difficult to keep the oven at the high temperature needed for sterilization.
- **DO NOT** dry meats, herbs, fruits or vegetables in your oven. Small quantities of food or foods with low moisture content can dry out, scorch or catch on fire if overheated.

### 2) POPCORN

*Popcorn may be popped in a microwave oven corn popper. Microwave popcorn that pops in its own package is also available. Follow popcorn manufacturers' directions and use a brand suitable for the cooking power of your microwave oven.*

**CAUTION:** When using pre-packaged microwave popcorn, you can follow recommended package instructions or use the Popcorn button (refer to page 24). Otherwise, the popcorn may not pop adequately or may ignite and cause a fire. Never leave the oven unattended when popping popcorn. Allow the popcorn bag to cool before opening, and always open the bag facing away from your face and body to prevent steam burns.





## Food Preparation (continued)

### 3) DEEP FAT FRYING

- **DO NOT** deep fat fry in your microwave oven. Cooking oils may burst into flames and may cause damage to the oven and may result in burns. Microwave utensils may not withstand the temperature of the hot oil, and can shatter or melt.

### 4) FOODS WITH NONPOROUS SKINS

- **DO NOT COOK / REHEAT WHOLE EGGS, WITH OR WITHOUT THE SHELL.**

Steam buildup in whole eggs may cause them to explode, and possibly damage the oven or cause injury. Reheating SLICED hard-boiled eggs and cooking SCRAMBLED eggs is safe.

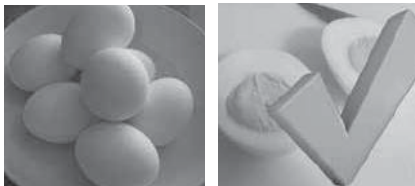

- **Potatoes, apples, whole squash and sausages** are examples of foods with nonporous skins. These types of foods must be pierced before microwave cooking to prevent them from exploding.



**CAUTION: Cooking dry or old potatoes can cause fire.**

### 5) GLASS TRAY / COOKING CONTAINERS / FOIL

- Cooking containers get hot during microwaving. Heat is transferred from the HOT food to the container and the Glass Tray. Use pot holders when removing containers from the oven or when removing lids or plastic wrap covers from cooking containers, to avoid burns.
- The Glass Tray will get hot during cooking. It should be allowed to cool before handling or before paper products, such as paper plates or microwave popcorn bags, are placed in the oven for microwave cooking.
- When using foil in the oven, allow at least 1-inch (2.5 cm) of space between foil and interior oven walls or door.
- Dishes with metallic trim should not be used, as arcing may occur.

### 6) PAPER TOWELS / CLOTHS

- **DO NOT** use paper towels or cloths that contain a synthetic fiber woven into them. The synthetic fiber may cause the towel to ignite. Use paper toweling under supervision.

### 7) BROWNING DISHES / OVEN COOKING BAGS

- Only use browning dishes that are designed for microwave cooking. Check browning dish information for instructions/heating chart. **DO NOT** preheat browning dish more than six minutes.
- If an oven cooking bag is used for microwave cooking, prepare according to package directions. **DO NOT** use a wire twist-tie to close bag. Instead use plastic ties, cotton string or a strip cut from the open end of the bag.



### 8) THERMOMETERS

- **DO NOT** use a conventional meat thermometer in your oven. Arcing may occur. Microwave safe thermometers are available for both meat and candy.



### 9) BABY FORMULA / BABY FOOD

- **DO NOT** heat baby formula or baby food in the microwave oven. The glass jar or surface of the food may appear warm while the interior can be so hot as to burn the infant's mouth and esophagus.



### 10) REHEATING PASTRY PRODUCTS

- When reheating pastry products, check temperatures of any fillings before eating. Some foods have fillings, which heat faster and can be extremely hot, while the surface remains warm to the touch (for example, jelly donuts).

### 11) GENERAL OVEN USAGE GUIDELINES

- **DO NOT** use the oven for any purpose other than the preparation of food.

# Cookware Guide

This section answers the question, "Can I use in the Microwave?"

## Aluminum Foil

It is not recommended to use. Arcing can occur if foil is too close to oven wall or door and cause damage to your oven.



## Browning Dish

Yes. Only use browning dishes that are designed for microwave cooking. Check browning dish information for instructions/heating chart. Do not preheat for more than six minutes.

## Brown Paper Bags

No. They may cause a fire in the oven.



## Microwave Safe

Yes. If labeled Microwave Safe, check manufacturers' directions for use in microwave heating. Some dinnerware may state on the back of the dish, "Oven-Microwave Safe".



## Dinnerware

If unlabeled, use CONTAINER TEST below.

## Disposable Polyester Paperboard Dishes

Yes. Some frozen foods are packaged in these dishes. Also can be purchased in some grocery stores.



## Fast Food Cartons with Metal Handle

No. Metal handle may cause arcing.



## Frozen Dinner Trays

If made for the microwave, then yes. If it contains metal, then no.



## Glass Jars

No. Most glass jars are not heat resistant.



## Heat Resistant Oven Glassware/Ceramic

Yes, but only ones for microwave cooking and browning. (See CONTAINER TEST below.)



## Metal Bakeware

No. Metal can cause arcing and damage to your oven.



## Metal Twist-Ties

No. May cause arcing which could cause a fire in the oven.



## Oven Cooking Bag

Yes. Follow manufacturers' directions. Close bag with the nylon tie provided, a strip cut from the end of the bag, or a piece of cotton string. Do not close with metal twist-tie. Make six 1/2-inch slits near the closure.

## Paper Plates/Cups

Yes. Use to warm cooked foods, and to cook foods that require short cooking time, such as hot dogs. **Do not microwave paper cups; they may overheat and ignite.**



## Towels & Napkins

Yes, only paper napkins/towels. Use to warm rolls and sandwiches, only if labeled safe for microwave use. Do NOT use recycled paper towels.



## Parchment Paper

Yes. Use as a cover to prevent splattering.

## Plastic Cookware

Yes, with caution. Should be labeled, "Suitable for Microwave Heating."



Check Microwave Safe manufacturers' directions for recommended uses. Some microwave safe plastic containers are not suitable for cooking foods with high fat or sugar content. The heat from hot food may cause warping.

## Plastic, Melamine

No. This material absorbs microwave energy. Dishes get HOT!

## Plastic Foam Cups

Yes, with caution. Plastic foam will melt if foods reach a high temperature. Use short term only to reheat foods to a low serving temperature. **Do not microwave paper cups; they may overheat and ignite.**



## Plastic Wrap

Yes. Use to cover food during cooking to retain moisture and prevent splattering. Should be labeled "Suitable for Microwave Heating". Check package directions.



## Straw, Wicker, Wood

Yes, short term only. Use only for short term reheating and to bring food to a low serving temperature. Wood may dry out, split or crack.



## Thermometers

Only microwave safe thermometers can be used, NOT conventional thermometers.



## Wax Paper

Yes. Use as a cover to prevent splattering and to retain moisture.



## CONTAINER TEST

**TO TEST A CONTAINER FOR SAFE MICROWAVE OVEN USE:** Fill a microwave safe cup with cool water and place it in the microwave oven along side the empty container to be tested; **heat one (1) minute at PL10 (HIGH)**. If the container is microwave oven safe (transparent to microwave energy), the empty container should remain comfortably cool and the water should be hot. If the container is hot, it has absorbed some microwave energy and should NOT be used. This test cannot be used for plastic containers.



# Location of Controls

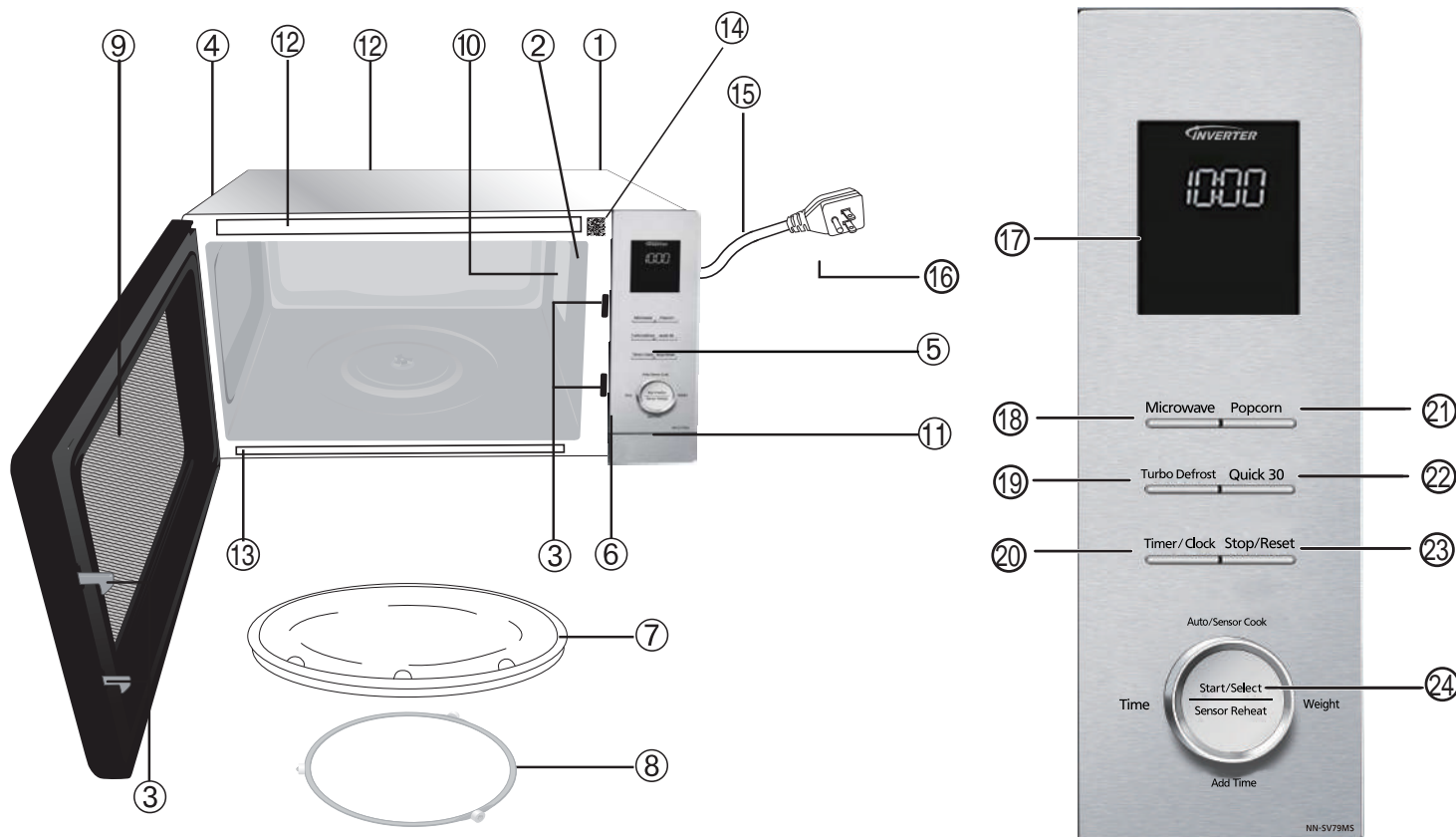

- 1 External Air Vent
- 2 Internal Air Vent
- 3 Door Safety Lock System
- 4 Exhaust Air Vent
- 5 Control Panel
- 6 Identification Plate
- 7 Glass Tray
- 8 Roller Ring
- 9 Heat/Vapor Barrier Film  
**(do not remove)**
- 10 Waveguide Cover  
**(do not remove)**
- 11 Door Release Button
- 12 Warning label
- 13 Menu label
- 14 Alexa Barcode label (page 10-11)
- 15 Power Supply Cord
- 16 Power Supply Plug
- 17 Display Window (page 9)
- 18 Microwave Button (page 16)
- 19 Turbo Defrost Button (page 25-26)
- 20 Timer/Clock Button (page 14, 19)
- 21 Popcorn Button (page 24)
- 22 Quick 30 Button (page 18)

## 23 Stop/Reset Button

Before cooking:  
One press clears your instructions.  
During cooking:  
One press temporarily stops the cooking process. Another press cancels all your instructions and colon or time of day appears in the display window.

## 24 Dial

The dial have 4 function  
(see details on next page)

### Beep Sound:

When a pad is pressed correctly, a beep will be heard. If a pad is pressed and no beep is heard, the unit did not or cannot accept the instruction.  
When operating, the oven will beep twice between programmed stages. At the end of any complete program, the oven will beep 5 times.  
When customer don't open/close door for 10 minutes, the unit don't accept to start cooking and will beep 3 times.

### NOTE:

If an operation(except "One Push Reheating") is set and **Start** is not pressed, after 6 minutes, the oven will automatically cancel the operation. The display will revert back to clock or colon mode.

The clock or colon(:) will disappear to save power if no operation for 3 minutes.

# Display Window

To help you operate the oven conveniently, the present state will appear in the display window.

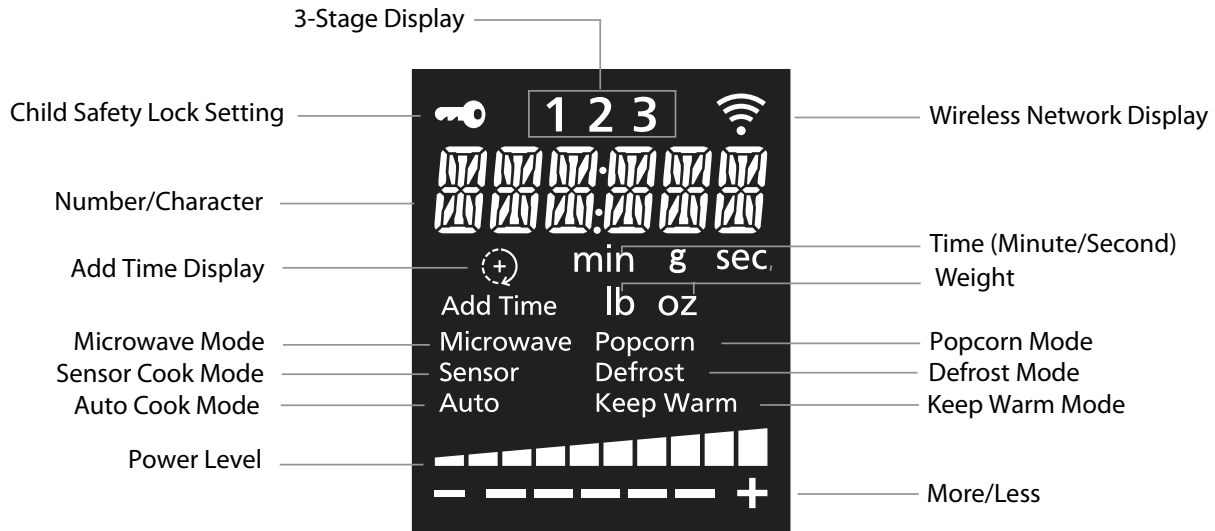

Note: When cooking time is longer than 60 minutes, the time will appear in hours and minutes.

# Dial Feature

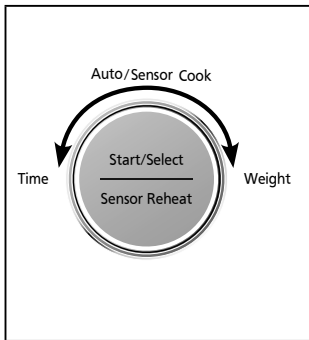

➤ **1 Time (Cooking time)**

After selecting a manual cooking mode, enter time by turning the dial. Use the dial for the Add Time function (page 23).

➤ **2 Auto Cook (Auto/Sensor Cook)**

a. When clock mode is displayed, turn the dial to select auto programs and weight (pages 29-33).

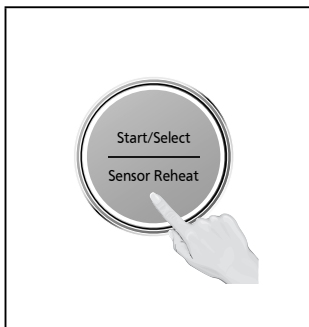

➤ **3 Start/Select (Confirmation)**

Press the dial to start operating the oven or confirm the setting. If during cooking the door is opened or Stop/Reset is pressed once, Start has to be pressed again to continue cooking.

➤ **4 Sensor Reheat (One Push Reheating)**

When Clock mode is displayed, press dial for quick start reheating chilled meal (page 27).

# Operation

## SETTING UP ALEXA ON YOUR MICROWAVE OVEN

Your microwave oven can be controlled with Alexa using any Alexa-enabled device such as Echo or Echo Dot. To control your microwave oven using Alexa, you'll need to set up your microwave and connect to Alexa using one of the below pairing methods.



**NOTE:** This function can be used by only 2.4GHz for wireless network frequency. Please connect your Alexa-enabled device and app to 2.4GHz.

### Pairing Method 1: Zero-Touch Setup (ZTS)

In order to pair using this method, **all** pre-requisites listed below must be met. If not, go to pairing method #2 or #3.

- ✓ You opted-in to store your wireless network credentials to your Amazon account in the past. This occurs when you previously set up another Echo family device or a Works with Alexa device.
- ✓ The microwave must have been ordered from the same Amazon account and while ordering you must have opted to link the device upon purchase. If microwave was purchased/received as a gift, or user de-selected this option upon purchase, the microwave will not be linked to end user's Amazon/Alexa account and ZTS will not be enabled. Please go to pairing method #2 or #3.
- ✓ The microwave would need to be within the range of the user's wireless network.
- ✓ The microwave should be within the wireless range of an Echo family device, which was signed into using the same Amazon account.

If above conditions are met:

1. Plug the microwave oven into a power outlet that is grounded.
2. Ensure that home wireless network is on and the device is in setup mode.
3. If the  stops blinking and stays on steadily, the device is ready to be controlled by using Alexa. (If the  is off, press the Popcorn button for 3 sec. to turn the wireless network on.)
4. Open Alexa app on your phone and sign into the same Amazon account as the one above. The Microwave should appear in the list of devices.

• **Setup mode** : There are 2 type of set up mode as below.

- Initial setup mode

After plug on, Display show "READY TO SETUP-CONNECT TO ALEXA APP" .

When this mode, you can connect wireless network by only pairing method #1 and #2 without pushing any button.

When this mode, you can connect wireless network by pairing method #3 with pushing popcorn button for 3 sec.

After setup by this mode, you can proceed weight/beep sound setup mode(page 12)

- Normal set up mode

When display show clock time or ":", you can use this mode by pushing Popcorn button for 3 sec. After pushing Popcorn key for 3 sec, display show "ENTER SETUP MODE" and you can connect wireless network by pairing method #2 or #3.

While the device is in setup mode,  is flashing until successfully paired.

Setup mode is activated for 5 minutes. After activated time, setup mode will time out.

### Pairing Method 2: Barcode Setup (BCS)

If Zero-Touch Setup (ZTS) is not possible, you can set up your microwave and connect to Alexa using Barcode Setup (BCS).

1. Install the latest version of Alexa app on your smart device and login with your Amazon account.
2. Plug the microwave oven into a power outlet that is grounded.
3. Ensure that home wireless network is on.
- 4-a. If your Alexa app automatically find your microwave oven by showing popup dialog after app is opened, press continue and please go to step.5.
- 4-b. If your Alexa app automatically doesn't find your microwave oven, open the Alexa App, tap the Devices icon in the lower right, and tap the "+" icon in the top right. Select "Add Device" and "Microwave" to begin set up for your microwave oven. Press "Panasonic".
5. Press "NEXT", When a screen with 2D Barcode appears, press "SCAN BARCODE", then scan the 2D barcode for your microwave oven. Follow on-screen instructions to set up your microwave oven.



# Operation

**NOTE:** The QR code used for microwave oven setup is attached inside the product. Please open the door and scan the QR code to the right of a key image on the front side of the product.

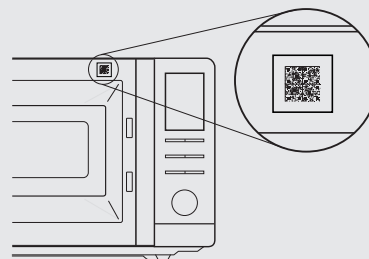

7. If  stop blinking and is off, restart from the step 4-b.

## Pairing Method 3: User Guided Setup (UGS)

If the QR code on the device is lost or has been damaged and you cannot use Pairing Method #2, you can set up your microwave and connect to Alexa using User Guided Setup (UGS).

1. Install the latest version of Alexa app on your smart device and login with your Amazon account.
2. Plug the microwave oven into a power outlet that is grounded.
3. Ensure that home wireless network is on.
- 4-a. If your Alexa app automatically find your microwave oven by showing popup dialog after app is opened, press continue and please go to step.6.
- 4-b. If your Alexa app automatically doesn't find your microwave oven or you try to connect with normal setup mode, Press the Popcorn button for 3 seconds. The screen will display 'ENTER SETUP MODE'. Then the microwave oven is ready for setup.
5. Open the Alexa App, tap the Devices icon in the lower right, and tap the "+" icon in the top right. Select "Add Device" and "Microwave Oven" to begin set up for your microwave oven. Press "Panasonic".
6. Press "NEXT", When a screen with 2D Barcode appears, press "DON'T HAVE A BARCODE" to continue setup. And then, follow the on-screen instructions to set up your microwave oven.
7. If  stop blinking and is off, restart from the step 4-b .

When "CONNECTED" shows on the microwave LED display and the beep sounds, set up is complete. After set up, the LED display will turn on the  and show local time in your location.

**NOTE:** It may take a few minutes for the LED display to show the correct local time.

Once set up is completed, it is automatically set up even after turning the power of the oven off and on.

**NOTE:** When you delete the product from the Alexa app, you must set up again.

## How to disconnect with Alexa

If you no longer need Alexa connection, you can turn off this function. Press and hold Defrost and Quick 30 button simultaneously for 3 seconds. Your microwave will be back to initial setup.

# Operation

## Using the Microwave for the First Time

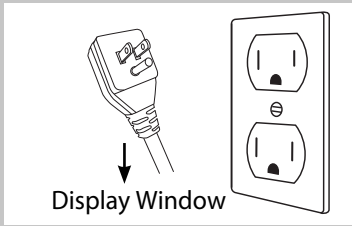

Display Window

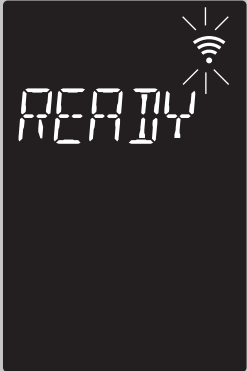

Plug into a properly grounded electrical outlet. "READY TO SETUP-CONNECT TO ALEXA APP" scrolls across display window.

Then, you can proceed Alexa setup mode.(page 10-11) If you don't need to connect Alexa, you can skip it and proceed weight/beep sound setup mode.

### Function Features

This unique function of your Panasonic microwave oven allows you to establish the initial non-cooking features of your Oven.

This microwave oven has the functions below:

- WEIGHT UNITS CHOICE
- BEEP CHOICE

**Plug into a properly grounded electrical outlet.**

### NOTES:

1. These choices can be selected only when you plug-in the oven.
2. Press **Stop/Reset**, it will revert to initial mode (" : ").
3. After beep setting it will revert back to the Weight Units Choice setting if Start dial is pressed again.

**WEIGHT UNITS CHOICE:**  
The oven has a choice of Metric Units or Imperial Units display.

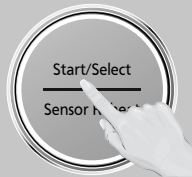
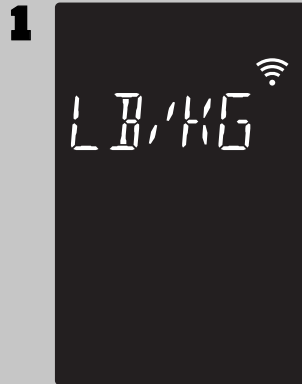

After Alexa setup complete or plug on, Press **Start (Dial)** once within 10 sec. "LB /KG " scrolls across display window.

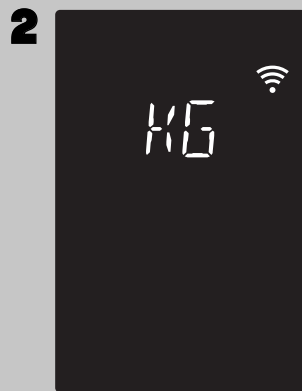

Select the "LB" or "KG" by pressing **Timer/Clock**. The default weight unit is LB.

**3**  
After setting, press **Stop/Reset** to exit.

**BEEP CHOICE:** The oven has both Beep On and Beep Off mode.

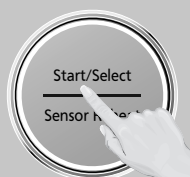

Press **Start (Dial)** 2 times. "BEEP ON/OFF" scrolls across display window. The default mode is Beep ON.

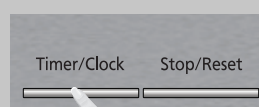

Press **Timer/Clock** once. The mode changes to Beep OFF.

**3**  
After setting, press **Stop/Reset** to exit.

## Disconnect wireless network / Factory Reset

This feature helps you to disconnect wireless network and reset wireless network information for your unit.

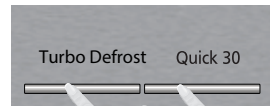

Press and hold **Defrost** and **Quick 30** button simultaneously for 3 seconds.



Display "SUCCESS" and wireless network mark start to blink. After 5 min., wireless network mark will disappear. If you want to connect Alexa again, please follow method on page 10-11.

## Demo Mode

**1** When "**DEMO MODE PRESS ANY KEY**" or "**D**" appears in the display window, it means the oven is under demonstration mode, microwave does not emit. Demo mode is designed for retail store display. In this mode, the oven can be demonstrated with no cooking power in the oven.

### NOTES:

1. To set Demo Mode, repeat step 1-3.
2. Default mode is Demo Mode off.

## 2

### To cancel:

Press **Microwave** once, **Start** 4 times and **Stop/Reset** 4 times.

### Step 1.

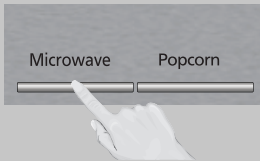

### Step 2.

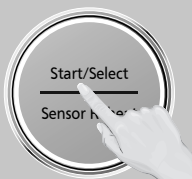

### Step 3.

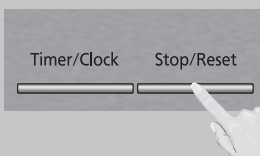

## Menu Action ON/OFF

This feature helps you to program your oven by prompting the next step to be taken. When you become familiar with your oven, the prompt can be turned off. This feature can be selected when colon or clock appears in the display window.

### To turn ON/OFF:

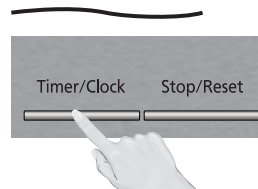
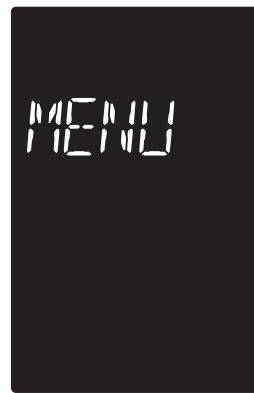

Press **Timer/Clock** 4 times to turn Menu Action ON/OFF. The default setting is **Menu Action ON**.

### NOTES:

This function only can be operated when word prompt turns on.



# Operation (continued)

## Setting the Clock



With the oven NOT cooking, press **Timer/Clock** twice; the hour will blink.

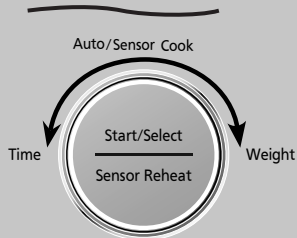
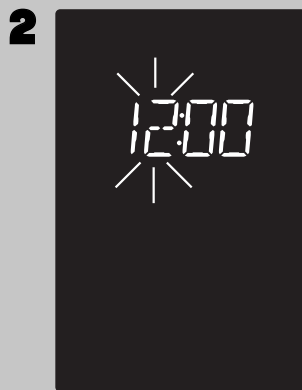

Turn the Start/Select dial to set hours.

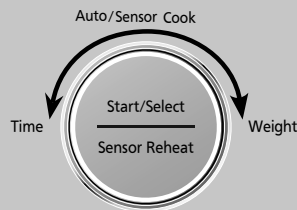
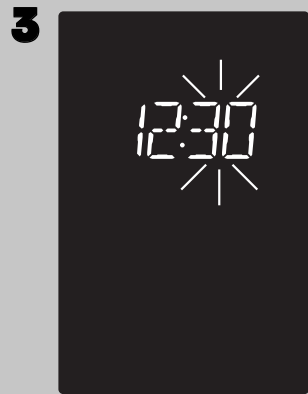

After setting hour, press Start/Select again, and turn dial to set minutes.

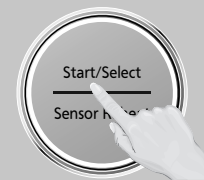

Once minutes are set press Start/Select to finish. Time will appear in the display window.

### NOTES:

1. To reset the clock, repeat steps.
2. The clock will retain the time of day as long as the oven is plugged in and electricity is supplied.
3. The clock is a 12-hour display.
4. Oven will not operate while time is blinking.
5. The clock or colon(:) will disappear to save power if no operation for 3 minutes.
6. If you connect wireless network with Alexa, time will be automatically appear on display.

## Setting the Child Safety Lock

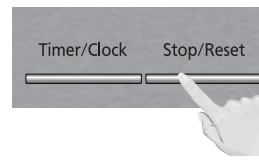
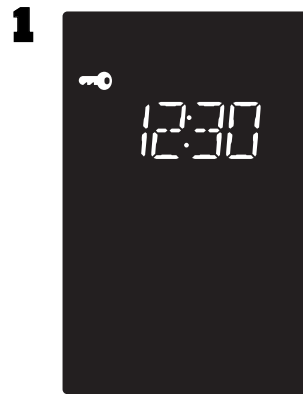

When the colon or time of day appears in the display, press **Stop/Reset** three times; "🔑" will appear in the display.

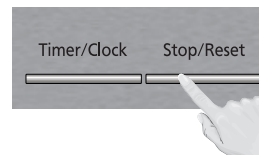

Press **Stop/Reset** three times; the display will return to the colon or time of the day and Child Safety Lock will be cancelled.

### NOTES:

1. This feature prevents the electronic operation of the oven until cancelled. It does not lock the door.
2. To set or cancel Child Safety Lock, **Stop/Reset** button must be pressed 3 times within 10 seconds.
3. You can set Child Safety Lock feature when the display shows a colon or time of day.

## OPERATING YOUR MICROWAVE OVEN

You can use your oven without setting it up for Alexa control. However, we highly recommend using your oven with Alexa control to unlock the full potential. Throughout this section, the following icons indicate:

instructions to operate the oven with voice.

**NOTE:** As a safety measure, the oven can only be commanded using voice within 10 minutes of the door being closed.

### Cooking

This feature allows you to set the desired power and time to cook food. Do not place food directly on the glass tray. Use microwave safe dishes, plates or bowls covered with a lid or pierced cling film.

"Alexa, microwave for X. "

To microwave by time, say "Alexa, microwave for X," where X is the amount of time you'd like to cook for. For example, to cook for 5 minutes, say "Alexa, microwave for 5 minutes." Or, to cook for 2 minutes and 39 seconds, say "Alexa, microwave for 2 minutes and 39 seconds."

"Alexa, add X in the microwave."

While microwaving, you can ask to cook for additional time by saying "Alexa, add X in the microwave," where X is the amount of time you'd like to add. For example, to add 2 minutes to the cooking time while the microwave is already running, say "Alexa, add 2 minutes in the microwave."

**NOTE :** By default, the oven will microwave at PL10 (maximum power)

"Alexa, microwave for X on power Y."

By default, your oven will microwave at PL10 (maximum power). To cook at a specific power, say "Alexa, microwave for X on power Y," where X is the amount of time you'd like to cook for and Y is the power level. For example, to cook at power 5 for 3 minutes, say "Alexa, microwave for 3 minutes at power 5."

**Continued on the  
Next Page**

## Cooking(Continued)

**1**

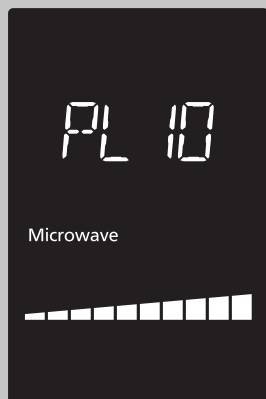

Press **Microwave** until the desired power level appears in the display. PL10 is the highest and PL1 is the lowest.

**2**

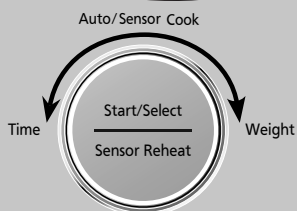

Set cooking time by turning dial. PL10 and KEEP WARM have max. cooking time of 30 minutes. For other power levels, the max. time is 1 hour and 30 minutes.

**3**

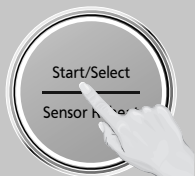
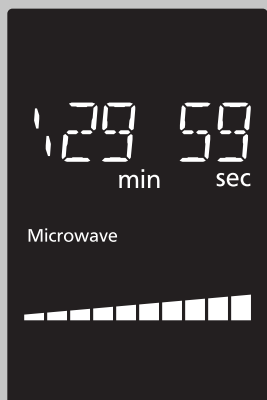

Press dial to **Start**; the cooking will start and the time will count down in the display. At the end of cooking, five beeps will sound.

### NOTES:

1. Opening the door and taking out the defrosted parts during the operating time is recommended. Turn over, stir or rearrange the parts which are still in icy.
2. When the selected cooking time is less than one hour, the time counts down second by second.
3. When the selected cooking time is over one hour, the time counts down minute by minute until only "1H 00" (1 hour) remains. The display then indicates minutes and seconds and counts down second by second.
4. For reheating, use PL10 (HIGH) for liquids, PL7 (MED-HIGH) for most foods, and PL6 (MEDIUM) for dense foods.
5. For defrosting, use PL3 (MED-LOW).

### DO NOT OVERCOOK:

This oven requires less time to cook than older units. Overcooking will cause food to dry out and may cause a fire. A microwave oven's cooking power tells you the amount of microwave power available for cooking.

### Caution:

DO NOT defrost food at a high power setting. Doing so can cause energy concentration at a focused point, which can lead to arcing and damage to the oven. Use the "Defrost" function instead.

Press	Power level
once	PL10 (HIGH)
twice	PL9
3 times	PL8
4 times	PL7 (MED-HIGH)
5 times	PL6(MEDIUM)
6 times	PL5
7 times	PL4
8 times	PL3 (MED-LOW/ DEFROST)
9 times	PL2
10 times	PL1 (LOW)
11 times	KEEP WARM

# Operation (continued)

## Keep Warm

(Will keep "cooked" food warm for up to 30 minutes after cooking)

Alexa, warm for X.

To keep warm by time, say "Alexa, warm for X," where X is the amount of time you'd like to keep warm for. For example, to keep warm for 5 minutes, say "Alexa, warm for 5 minutes." Or, to keep warm for 2 minutes and 39 seconds, say "Alexa, warm for 2 minutes and 39 seconds." When you say "warm", product always work with "Keep Warm" program which is PL1 even if you say warm with other power level. If you say "Alexa, warm for 10 minutes at power level 5", product work with PL1.



Press **Microwave** 11 times to select the KEEP WARM.

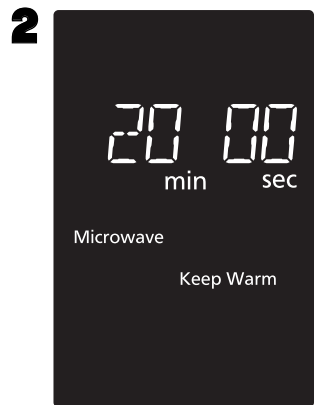

Set warming time by turning dial (up to 30 minutes). Set 20 minutes cooking for an example.



Press dial to **Start**, the cooking will start and the time will count down in the display. At the end of cooking, five beeps will sound.

### NOTES:

**KEEP WARM** can be set as the final stage after cook time has been manually entered. It cannot be used with Sensor or auto features.

# Operation (continued)

## Quick 30

### (Set or add cooking time in 30 seconds increments)

Quick 30 allows you to reheat for 30 seconds at 100% (full power) by simply pressing the Quick 30 button. By repeatedly pressing the Quick 30 button, you can also extend reheating time to to 5 minutes by 30 second increments. To microwave by Quick 30, say like this.

"Alexa, microwave for 30 seconds."

"Alexa, cook for 30 seconds."

if you want to add more 30 seconds while microwaving, say like this.

"Alexa, add 30 seconds in the microwave."

1

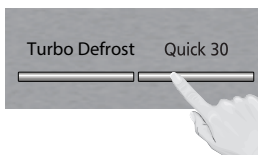
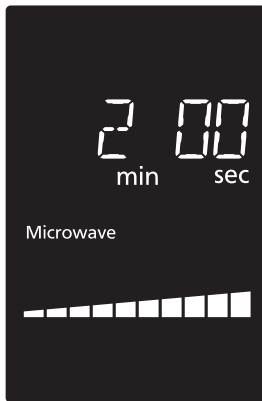

Press **Quick 30** until the desired cooking time (up to 5 minutes) appears in the display. Power level is pre-set at PL10.

2

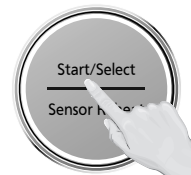
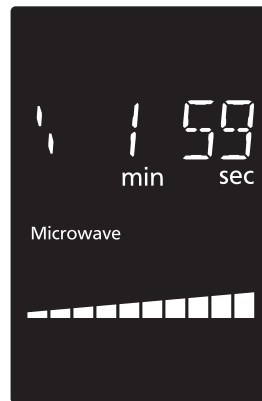

Press dial to **Start**; the cooking will start and the time will count down in the display. At the end of cooking, five beeps will sound.

### NOTES:

1. If desired, you can use other power levels. Select desired power level before pressing **Quick 30**
2. After setting the time by **Quick 30** button, you cannot use the **Dial**
3. **Quick 30** button can also be used to add more time during manual cooking.
4. It cannot be used with auto programs (such as Defrost, Sensor Reheat, Auto/Sensor Cook).

## Setting the Kitchen Timer



This feature allows you to program the oven as a kitchen timer. Press **Timer/Clock** once.

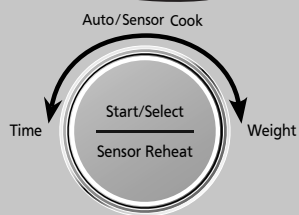
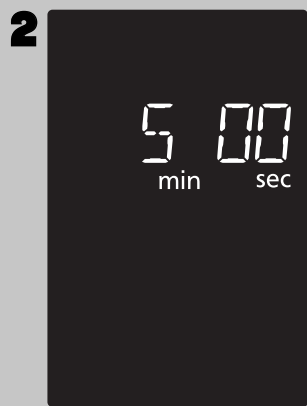

Set desired amount of kitchen time by turning dial (up to 1 hour and 30 minutes).

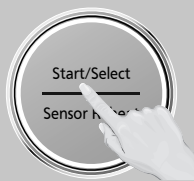
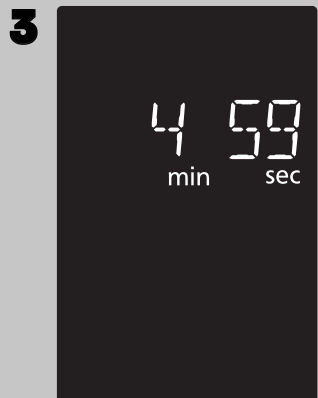

Press dial to **Start**. Time will count down without oven operating.

**Caution:** If oven lamp is lit while using the timer feature with door closed, the oven is **NOT** set properly; **STOP OVEN IMMEDIATELY** and re-read instructions.

### NOTES:

1. If the oven door is opened during Kitchen Timer, Standing Time, Delay Start, the time in the display window will continue to count down.
2. If the time exceeds one hour, it will count down in units of minutes. If less than one hour, the time will count down in units of seconds.
3. An "H" will appear in the display to denote hours.

# Operation (continued)

## Setting a Standing Time

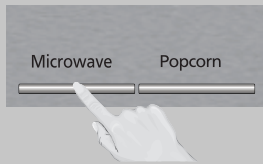

Some recipes call for a standing time after cooking. Press **Microwave** until the desired power level appears in the display. PL10 is the highest and PL1 is the lowest.



Press **Timer/Clock** once.

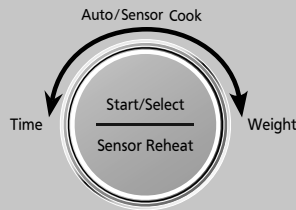
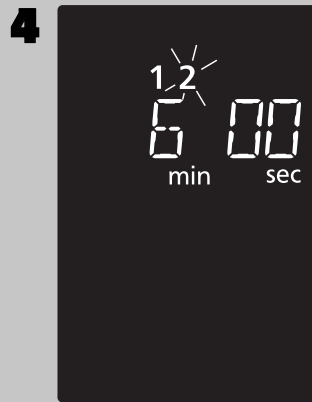

Set desired standing time by turning dial (up to 1 hour and 30 minutes).

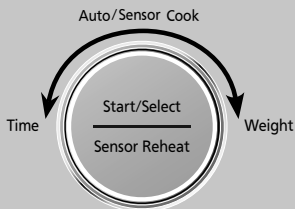
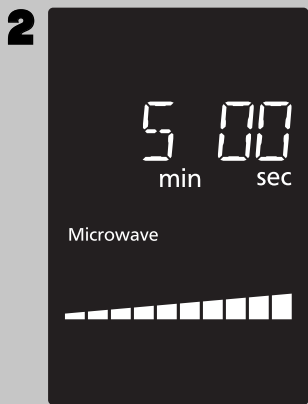

Set cooking time by turning dial (see previous page for maximum times).

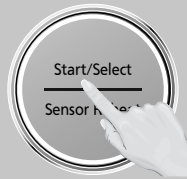
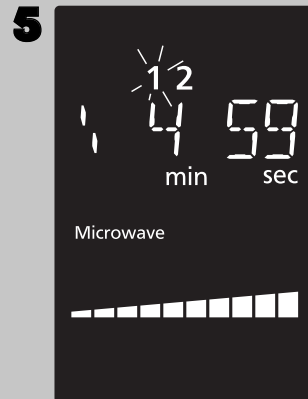

Press dial to **Start**. Cooking will start. After cooking, standing time will count down without oven operating.

### NOTES:

1. When each stage finishes, the oven will beep twice. At the end of the program, the oven will beep five times.
2. If the oven door is opened during Kitchen Timer, Standing Time, Delay Start, the time in the display window will continue to count down.
3. Standing Time and Delay Start can not be programmed together with auto programs (such as Defrost, Sensor Reheat, Auto/Sensor Cook) and preheating. This is to prevent the starting temperature of food from rising before defrosting or cooking begins. A change in starting temperature could cause inaccurate results.
4. When using Standing Time or Delay Start, it is up to 2 power stages.
5. If the time exceeds one hour, it will count down in units of minutes. If less than one hour, the time will count down in units of seconds.
6. An "H" will appear in the display to denote hours.
7. Standing Time, Delay Start and Stage Cooking cannot be used by Alexa control.

# Operation (continued)

## Setting a Delayed Start



The start time can be delayed to start cooking at a later time. To do this, first press **Timer/Clock** once.

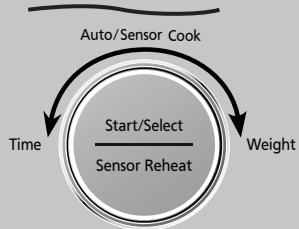
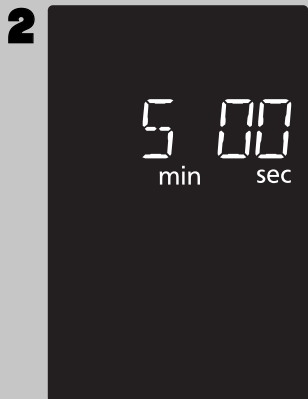

Set the desired delay time by turning dial (up to 1 hour and 30 minutes).

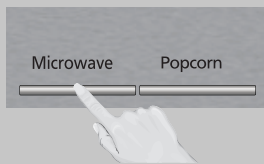
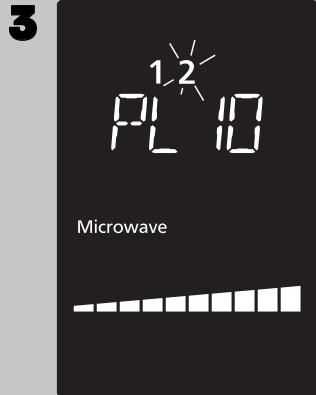

Press **Microwave** until the desired power level appears in the display. PL10 is the highest and PL1 is the lowest.

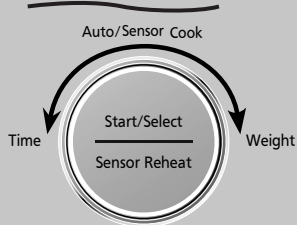
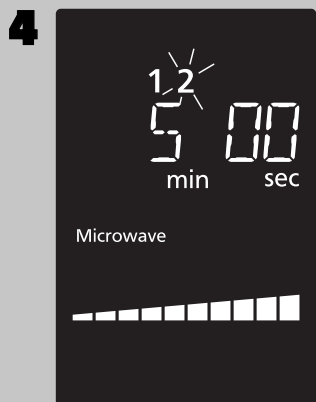

Set cooking time by turning dial (see previous page for maximum times).

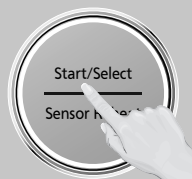
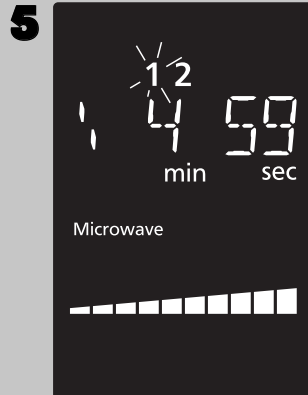

Press dial to **Start**, the delay time will count down, then cooking will begin.

## NOTES:

1. When each stage finishes, the oven will beep twice. At the end of the program, the oven will beep five times.
2. If the oven door is opened during Kitchen Timer, Standing Time, Delay Start, the time in the display window will continue to count down.
3. Standing Time and Delay Start can not be programmed together with auto programs (such as Defrost, Sensor Reheat, Auto/Sensor Cook) and preheating. This is to prevent the starting temperature of food from rising before defrosting or cooking begins. A change in starting temperature could cause inaccurate results.
4. When using Standing Time or Delay Start, it is up to 2 power stages.
5. If the time exceeds one hour, it will count down in units of minutes. If less than one hour, the time will count down in units of seconds.
6. An "H" will appear in the display to denote hours.
7. Standing Time, Delay Start and Stage Cooking cannot be used by Alexa control.



# Operation (continued)

## 3-Stage Setting

(Example: Continually set PL10 for 5 minutes, P7 for 3 minutes and P4 for 5 minutes.)

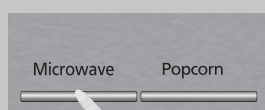

Press **Microwave** once to select **PL10**.



Auto/Sensor Cook

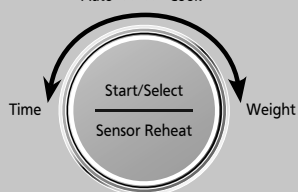

Set as 5 minutes by turning dial.

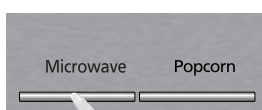

Press **Microwave** 4 times to select **PL7**.

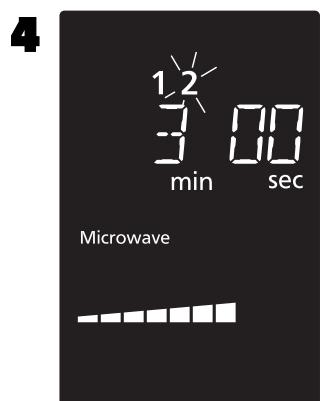

Auto/Sensor Cook

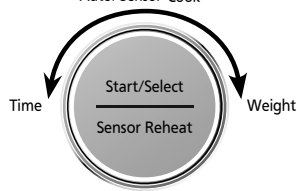

Set as 3 minutes by turning dial.

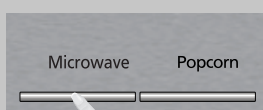

Press **Microwave** 7 times to select **PL4**.



Auto/Sensor Cook

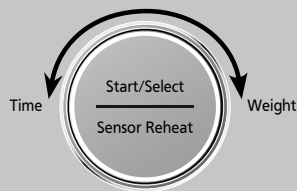

Set as 5 minutes by turning dial.

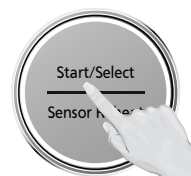
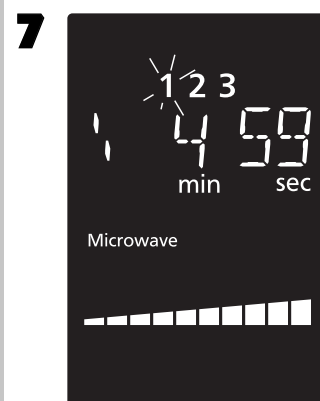

Press dial to **Start**. The time will count down at the first stage in the display window.

### NOTES:

1. When operating, two beeps will sound between each stage.
2. Auto programs (such as Defrost, Sensor Reheat, Auto/Sensor Cook and Steam Clean) and preheating can not be used with 3-stage cooking.
3. Standing Time, Delay Start can be used with 3-stage cooking.
4. During cooking, one press on **Stop/Reset** stops the operation. You can re-start it by pressing **Start**. A second press of **Stop/Reset** will cancel the selected program.
5. Whilst not operating, one press of **Stop/Reset** cancels the selected program.
6. Standing Time, Delay Start and Stage Cooking cannot be used by Alexa control.

# Operation (continued)

## Add Time

(Example: To add cooking time after PL5)

**1**



Set the desired cooking program, by entering cooking method and time required.

**2**

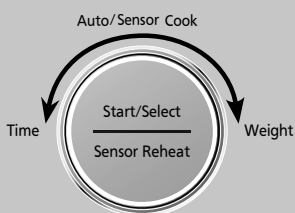

Set desired cooking time by turning dial.

### NOTES:

1. This feature is not available for auto programs (such as Defrost, Sensor Reheat, Auto/Sensor Cook).
2. **The Add Time function will be cancelled if you do not perform any operation within 1 minute after cooking.**
3. The Add Time function can be used after the 3-stage cooking.
4. The power level is the same as the last stage.

**3**



After cooking, "**ADD TIME OR ENJOY YOUR MEAL**" will appear in the display window.

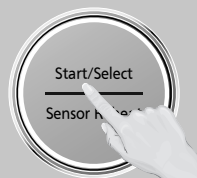

Press dial to **Start**. Time will be added. The time in the display window will count down.

# Operation (continued)

## Popcorn

(Example: To pop 3.5 oz (100g) of popcorn)

Alexa, microwave three point five ounce of popcorn

Weight range is 1.5 - 3.5 oz.(40 - 100 g).

Weight stride is 0.1 oz.(1 g).

**1**



Microwave Popcorn  
Auto

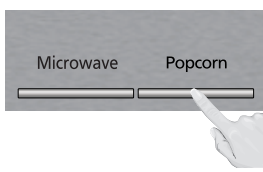

Microwave Popcorn

Press **Popcorn** button

**2**



3.5  
OZ  
Microwave Popcorn  
Auto

Auto/Sensor Cook

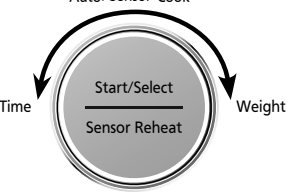

Time Start/Select Weight  
Sensor Reheat

Select the weight of the food by turning dial. Turning the dial slowly will count up in 0.1 oz(1 g) steps. Initial weight is 3.0oz(85g)

**3**



YOU CA  
Microwave Popcorn  
Auto

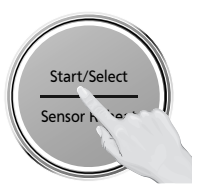

Start/Select  
Sensor Reheat

Press dial to Start. "YOU CAN ADJUST COOKING TIME MORE/ LESS" will appear in the display window. If desires, More/Less adjustment can be done. Turn dial to add or subtract the cooking time (5 levels can be select), after turning the dial within 14 seconds.

**4**

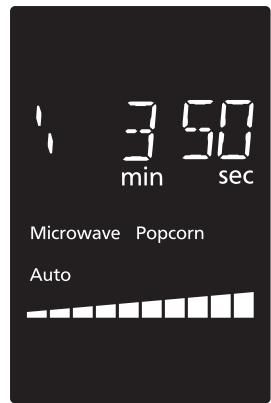

3:50  
min sec  
Microwave Popcorn  
Auto

After 14sec., The time appears in the display window and begins to count down. At the end of cooking, five beeps will sound.

### NOTES:

1. Pop one bag at a time.
2. Place bag in oven according to manufacturers' directions.
3. Start with popcorn at room temperature.
4. Allow popped corn to sit unopened for a few minutes.
5. Open bag carefully to prevent burns, because steam will escape.
6. Do not reheat unpopped kernels or reuse bag.
7. If popcorn is of a different weight than listed, follow instructions on popcorn package.
8. **Never leave the oven unattended.**
9. **If popping slows to 2 to 3 seconds between pops, stop oven. Overcooking can burn popcorn or cause fire.**
10. When popping multiple bags one right after the other, the cooking time may vary slightly. This does not affect the popcorn results.

## Turbo Defrost

"Alexa, Defrost for 10 minutes."

When you operate Defrost by time with voice, product work with PL3.

"Alexa, Defrost for two breads"

You can use " Defrost " with food quantity by only Alexa control.(See Voice Command Chart on Page.35)  
Quantity range is 1-4.

" Alexa, Defrost two pounds of food."

You can use food name(Ex. Beef/Fish/Frozen Fruits) instead of only "food".(See Voice Cooking Chart on Page.35)  
When you operate Defrost by weight with voice, product work with PL6.

Weight range is 0.3 - 6.0 lb.(100 - 2700 g).  
Weight stride is 0.1 lb.(10 g).

**1**



Press Turbo Defrost

**2**

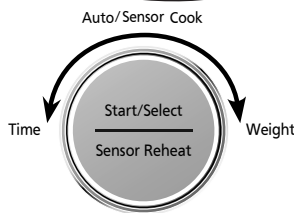

Select the weight of the food by turning dial. Turning the dial slowly will count up in 0.2 lb(50g) steps.

**3**

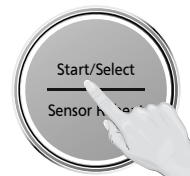

Press dial to Start. The time appears in the display window and begins to count down.

**Continued on the  
Next Page**

## Turbo Defrost (Continued)

### Conversion

Follow the chart to convert ounces or hundredths of a pound into tenths of a pound. To use Turbo Defrost, enter the weight of the food in pounds (1.0) and tenths of a pound (0.1). If a piece of meat weighs 1.95 lbs or 1 lb 14 oz, enter 1.9 lbs.

Ounces	Hundredths of a Pound	Tenths of a Pound
0	.01 - .05	0.0
1 - 2	.06 - .15	0.1
3 - 4	.16 - .25	0.2
5	.26 - .35	0.3
6 - 7	.36 - .45	0.4
8	.46 - .55	0.5
9 - 10	.56 - .65	0.6
11 - 12	.66 - .75	0.7
13	.76 - .85	0.8
14 - 15	.86 - .95	0.9

### Defrosting Tips & Techniques

#### Preparation For Freezing:

1. Freeze meats, poultry, and fish in packages with only one or two layers of food. Place wax paper between layers.
2. Package in heavy-duty plastic wraps, bags (labeled "For Freezer"), or freezer paper.
3. Remove as much air as possible.
4. Seal securely, date, and label.

#### To Defrost:

1. Remove wrapper. This helps moisture to evaporate. Juices from food can get hot and cook the food.
2. Set food in microwave safe dish.
3. Place roasts fat-side down. Place whole poultry breast-side down.
4. Select power and minimum time so that items will be under-defrosted.

5. Drain liquids during defrosting.
6. Turn over (invert) items during defrosting.

#### After Defrosting:

1. Large items may be icy in the center. Defrosting will complete during Standing Time.
2. Let stand, covered, following stand time directions on page 9.
3. Rinse foods indicated in the chart.
4. Items which have been layered should be rinsed separately or have a longer stand time.

FOOD	DEFROST TIME at P3 mins (per lb)	DURING DEFROSTING	AFTER DEFROSTING	
			Stand Time	Rinse
<b>Fish and Seafood</b>				
Crabmeat [up to 3 lbs. (1.4 kg)]	6	Break apart/Rearrange	5 min.	YES
Fish Steaks	4 to 6	Turn over		
Fish Fillets	4 to 6	Turn over/Rearrange		
Sea Scallops	4 to 6	Break apart/ Remove defrosted pieces		
Whole fish	4 to 6	Turn over		
<b>Meat</b>				
Ground Meat	4 to 5	Turn over/ Remove defrosted portion	10 min.	NO
Roasts [2½-4 lbs. (1.1-1.8 kg)]	4 to 8	Turn over	30 min. in fridge.	
Chops/Steak	6 to 8	Turn over/Rearrange	5 min.	
Ribs/T-bone	6 to 8	Turn over/Rearrange		
Stew Meat	4 to 8	Break apart/ Remove defrosted pieces		
Liver (thinly sliced)	4 to 6	Drain liquid/Turn over/ Separate pieces		
Bacon (sliced)	4	Turn over	----	
<b>Poultry</b>				
Chicken, Whole [up to 3 lbs. (1.4 kg)]	4 to 6	Turn over	20 min. in fridge.	YES
Cutlets	4 to 6	Break apart/Turn over/ Remove defrosted Pieces	5 min.	
Pieces	4 to 6	Break apart/Turn over	10 min.	
Cornish hens	6 to 8	Turn over		
Turkey Breast [5-6 lbs. (2.3-2.7 kg)]	6	Turn over	20 min. in fridge.	

## Sensor Reheat (One Push Reheating)

### the Genius

This unique feature 'the Genius' built-in sensor allows you to reheat a chilled meal with one push of the dial. It is not necessary to select the power level or cooking time. The built-in sensor measures the humidity of the food and calculates the cooking time.

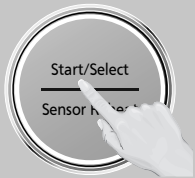

When clock mode is displayed, press the dial to Start. To reset oven and return to clock mode, press Stop/Reset twice.

**Casseroles:** Add three to four tablespoons of liquid, cover with lid or vented plastic wrap. Stir when time appears in the display window.

**Canned foods:** Empty contents into casserole dish or serving bowl, cover dish with lid or vented plastic wrap. After reheating, let stand for a few minutes.

**Plate of food:** Arrange food on plate; top with butter, gravy, etc. Cover with lid or vented plastic wrap. After reheating, let stand for a few minutes.

### DO NOT USE SENSOR REHEAT:

1. To reheat bread and pastry products. Use manual power and time for these foods.
2. For raw or uncooked foods.
3. If oven cavity is warm.
4. For beverages.
5. For frozen foods.

### How it works

Once the One Push Reheating has been selected, the food is heated up. As food begins to get hot, steam is emitted. When the food reaches a certain temperature and begins to cook, an even greater amount of steam is released. The increase in steam emission is detected by a humidity sensor in the oven. This acts as a signal for the oven to calculate how much longer the food needs to cook. The remaining cooking time will appear in the display window after two beeps. Whilst the Sensor symbol is still flashing in the display window the oven door should not be opened. Wait until the cooking time appears in the window, and then open the door if required, to stir or turn the food.

### Adjust to Taste

The One Push Reheating reheats a chilled meal for average tastes. You are able to adjust the reheating program to your own taste. After pressing Start, +/- symbol and flashing bar appears in the display, turn dial clockwise for more time or anticlockwise for less time. This operation should be completed within 14 seconds. Default mode is normal.

### Notes:

1. Press the dial in two minutes right after the door was closed, otherwise One Push Reheating Function will be rejected and beeps will sound. Open the door and close it again will release the One Push Reheating Function.
2. The oven automatically calculates the reheating time or the remaining reheating time.
3. The door should not be opened before the time appears in the display window.
4. To prevent any mistakes during One Push Reheating ensure that glass tray and the container are dry.
5. The room temperature should not be more than 95 °F (35 °C) and not less than 32 °F (0 °C).
6. "Sensor Reheat" cannot be used by Alexa control. If you use "Reheat" by Alexa control, product work with PL10(max power).

## Auto/Sensor Cook

You can cook some food with special Sensor /Auto program. (See Voice Cooking Chart on Page.35-38)

### Auto Reheat

"Alexa, Reheat Y (cups of) X."

X is the food name and Y is the food weight or quantity you'd like to reheat. For example, to cook 2 cups of Coffee, say "Alexa, reheat 2 cups of Coffee." Please refer Notes on Page. 29 for Auto Reheat Cooking.

### Sensor Cook

"Alexa, Microwave X."

"Alexa, Cook X."

X is the food name you'd like to cook with sensor.  
For example, to cook Potato, say "Alexa, microwave Potato." Or "Alexa, cook Potato."  
You don' need to mention about weight or quantity.  
Please refer Notes on Page. 30 - 31 for Sensor Cooking.

### Melt/Soften

"Alexa, Melt Y ounce of X."

"Alexa, Soften Y ounce of X."

X is the food name and Y is the food weight you'd like to melt/soften.  
For example, to melt five ounce of butter, say "Alexa, melt five ounce of Butter."  
Please refer Notes on Page. 33 for Melt/Softening Cooking.

**Continued on the  
Next Page**

# Operation (continued)

## Auto/Sensor Cook(Continued)

### Auto Reheat

#### Beverage/Soup (No.1 - No.3)

(Example: To reheat 1 cup milk.)

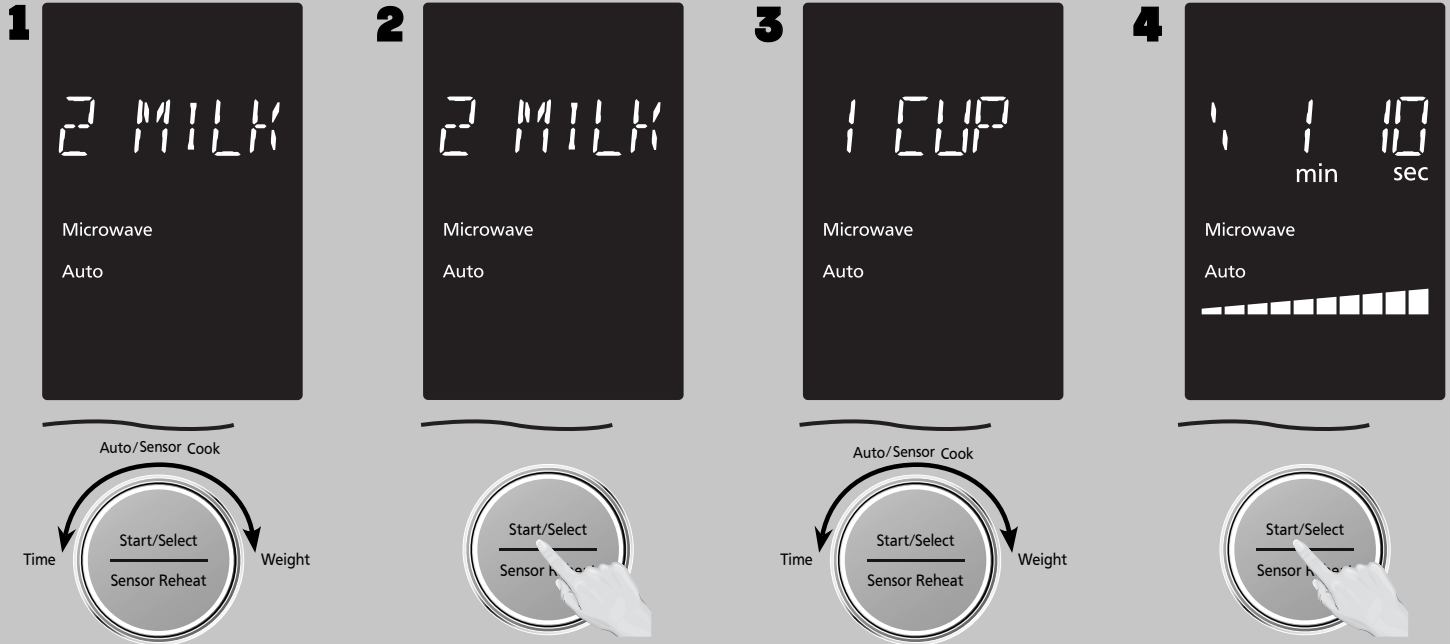

To allow auto program operation, ensure the oven is in clock mode. Select the desired menu by turning the dial. (see chart below)

Press the dial to confirm the program selection.

Select the weight of the food by turning dial.

Press dial to **Start**. The time appears in the display window and begins to count down.

No.	Menu	Weight Range	Recommended Container	Hints
1	<b>Coffee</b>	1 cup - 4 cups (250 - 1000ml)	microwave safe cup	This feature allows you to reheat 1 cup (250 ml) or 2 cups (500 ml) or 3 cups(750ml) or 4 cups(1000 ml) of room temperature beverages/soup without setting power and time.(Refer to NOTES 3)
2	<b>Milk</b>		microwave safe cup	
3	<b>Soup</b>		micro-safe bowl	

#### NOTES:

1. Use a microwave safe cup/bowl.
2. Heated liquids can erupt if not mixed with air. Do not heat liquids in your microwave oven without stirring before and halfway through heating.
3. Care must be exercised not to overheat liquids when using the Beverage/Soup feature. It is programmed to give proper results when heating 1-4 cups of liquid, starting from room temperature and refrigerator temperature. Overheating will cause an increased risk of scalding, or water eruption. Refer to page 3, item 18.



## Auto/Sensor Cook(Continued)

### Sensor Cook : (No.4 - No.14)

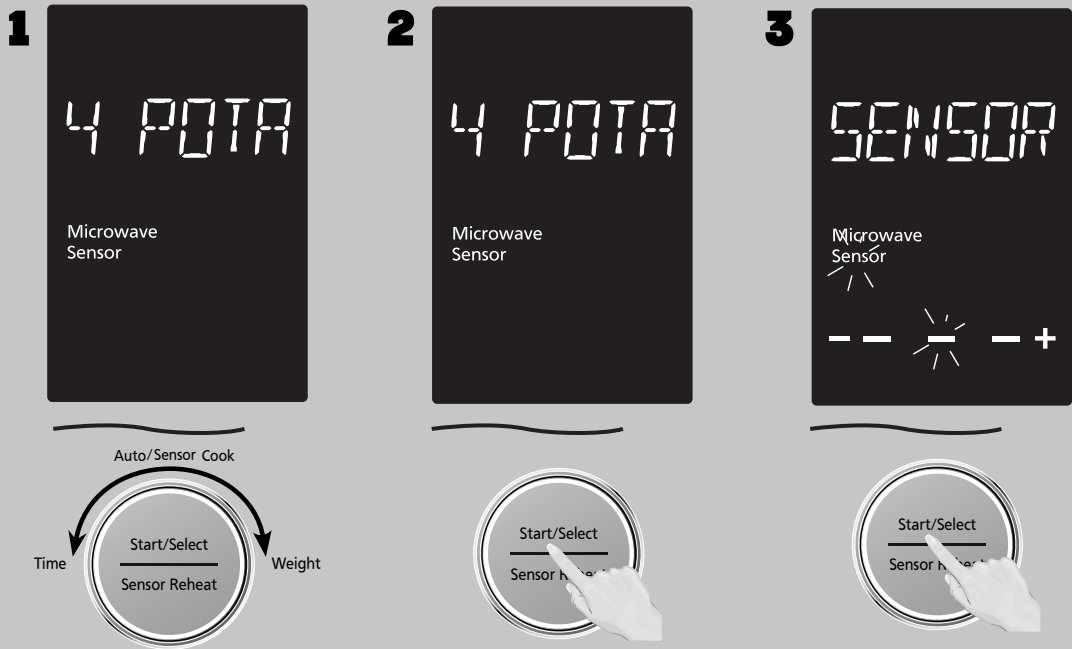

To allow auto program operation, ensure the oven is in Clock mode. Select the desired menu by turning the dial. (see chart on the next page.)

Press the dial to confirm the program.

Press dial to **Start**. The food category will be repeated in the display window until the oven calculates the cooking time after detecting a burst of steam. Do not open the oven door until the remaining cooking time appears in the display window.

#### NOTES:

1. If desired, More/Less adjustment can be done. Turn dial to add or subtract the cooking time (3 levels can be selected), after turning the dial within 14 seconds.
2. After having used the Sensor Cook feature a few times, you may decide you would prefer your food cooked to a different doneness – that is why you would like to turning the dial.
3. When steam is detected by the Genius Sensor and two beeps sound, the remaining cooking time will appear in the display.
4. Automatic features are provided for your convenience. If results are not suitable to your individual preference, or if serving size is other than what is listed in next page, please refer to manual cooking on page 16.

#### For the best results with the GENIUS SENSOR, follow these recommendations:

##### BEFORE Reheating/Cooking:

1. The room temperature surrounding the oven should be below 95 °F (35 °C).
2. Food weight should exceed 4 oz. (110 g).
3. Be sure the glass tray, the outside of the cooking containers and the inside of the microwave oven are dry before placing food in the oven. Residual beads of moisture turning into steam can mislead the sensor.
4. Cover food with lid, or with vented plastic wrap. Never use tightly sealed plastic containers—they can prevent steam from escaping and cause food to overcook.

##### DURING Reheating/Cooking:

DO NOT open the oven door until two beeps sound and cooking time appears in the display. Doing so will cause inaccurate cooking since the steam from food is no longer contained within the oven cavity. Once the cooking time begins to count down, the oven door may be opened to stir, turn or rearrange foods.

##### AFTER Reheating/Cooking:

All foods should have a standing time.

## Operation (continued)

No.	Menu	Weight Range	Recommended Container	Hints
4	Potatoes	1 - 4 potatoes (6 - 8 oz. each) (170 - 220 g)	kitchen paper	Pierce each potato with a fork 6 times spacing around surface. Place potato or potatoes around the edge of paper-towel-lined glass tray (Turntable), at least 1 inch (2.5 cm) apart. Do not cover. Turn over after 2 beeps. Let stand 5 minutes to complete cooking.
5	Fresh Vegetables	4 - 16 oz (110 - 450 g)	microwave safe casserole with a lid or plastic wrap	All pieces should be the same size. Wash thoroughly, add 1 tbsp. of water per ½ cup of vegetables, and cover with lid or vented plastic wrap. Do not salt/butter until after cooking. After 2 beeps, stir or rearrange. Re-cover and press Start .
6	Frozen Vegetables	4 - 16 oz (110 - 450 g)	microwave safe casserole with a lid or plastic wrap	Add 1 tbsp. of water per ½ cup of vegetables, and cover with lid or vented plastic wrap. Do not salt/butter until after cooking. (Not suitable for vegetables in butter or sauce.) After 2 beeps, stir or rearrange. Re-cover and press Start .
7	Frozen Pizza (single)	6 - 12 oz (170 - 340 g)	Package	Follow manufacturers' directions for preparation. Add more time of cooking if needed.
8	Frozen Entrées	6 - 32 oz (170 - 900 g)	Package	Follow manufacturers' directions for preparation. After 2 beeps, stir or rearrange. Be careful when removing the film cover after cooking. Remove facing away from you to avoid steam burns. If additional time is needed, continue to cook manually.
9	Frozen Dinners	11 - 16 oz (300 - 450 g)	Package	Follow manufacturers' directions for preparation. Be careful when removing the film cover after cooking. Remove facing away from you to avoid steam burns. If additional time is needed, continue to cook manually.
10	Frozen Breakfast	1 - 2 pcs	Package	It is suitable for Frozen breakfast, Brito, hot pockets and sandwich. Follow manufactures' directions for preparation. Be careful when open the package after cooking. If additional time is needed, continue to cook manually.
11	Frozen Nuggets	4 - 12 oz (110 - 340 g)	microwave-safe dish	Place frozen nuggets on a microwave safe dish. Do not cover.
12	Oatmeal	0.5 - 1.0 cup (1.4 - 2.8 oz) (40 - 80 g)	microwave-safe bowl	Place inside a microwave safe serving bowl with no cover. Follow manufacturers' directions for preparation.
13	Rice	0.5 - 1.5 cups	microwave-safe casserole dish	Place rice with hot tap water in a microwave safe casserole dish. Cover with lid or vented plastic wrap. Let stand 5 to 10 minutes before serving. Add 1 ½ parts water to 1 part rice.
14	Pasta	1.75 - 5.5 oz (50 - 155 g)	microwave-safe casserole dish	Place 1.75 oz.(50 g) pasta with 3 cups (750 ml) hot tap water in a 2 qt microwave safe casserole, salt and oil, if desired, covered with lid or vented plastic wrap. For 4 oz.(110 g) pasta use 4 cups (1000 ml)hot tap water, for 5.5 oz.(155 g) pasta use 6 cups (1500 ml) hot tap water in 3 qt casserole.

## Auto/Sensor Cook(Continued)

### Auto Reheat

### Frozen Pancake/Reheat Desert(No.15 - No.16)

(Example: To reheat 1 pc Pancake .)

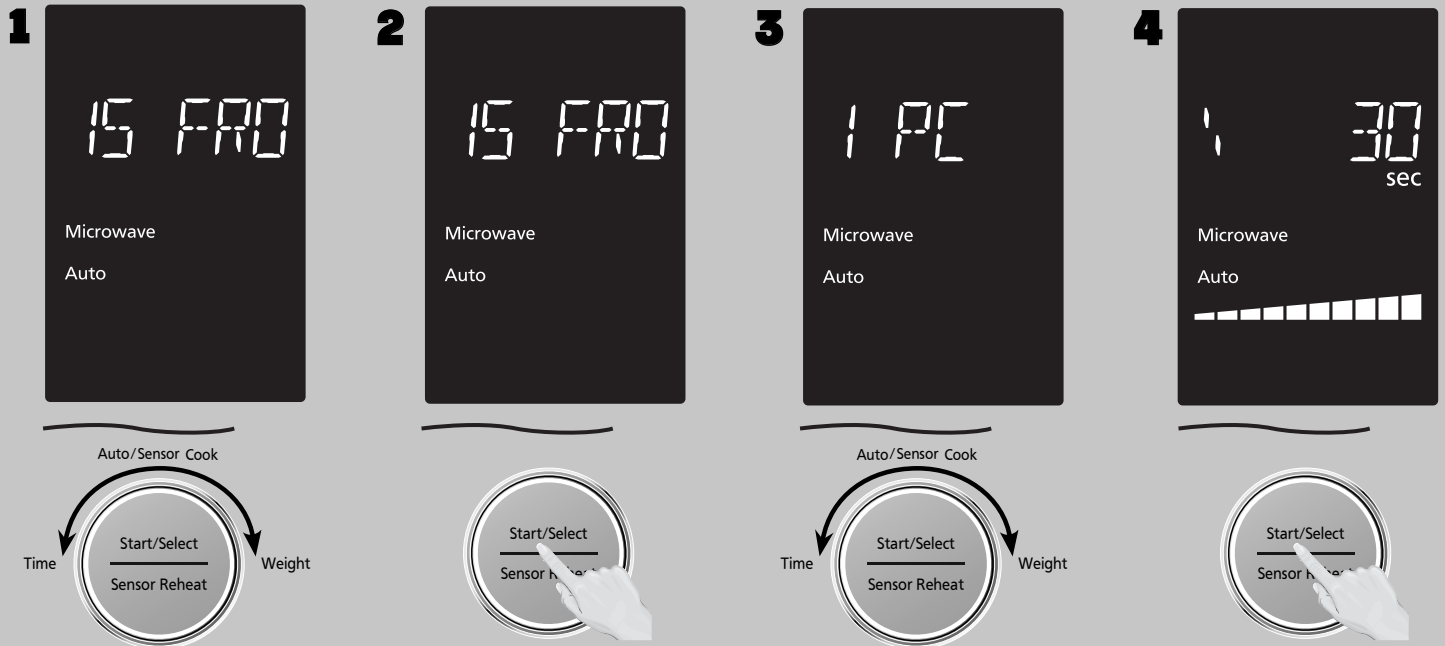

To allow auto program operation, ensure the oven is in clock mode. Select the desired menu by turning the dial. (see chart below)

Press the dial to confirm the program selection.

Select the weight of the food by turning dial.

Press dial to **Start**. The time appears in the display window and begins to count down.

No.	Menu	Weight Range	Recommended Container	Hints
15	Frozen Pancake	1 pc - 4 pcs (30g-40g / each) (1oz-1 ½ oz / each)	microwave-safe dish	It is suitable for frozen pancake. Place pancake on a microwave-safe dish. Do not cover.
16	Reheat Dessert		microwave-safe dish	It is suitable for cake, brownie, pancake from room temperature. Place dessert on a microwave safe dish. Do not cover.

#### NOTES:

- Automatic features are provided for your convenience. If results are not suitable to your individual preference, or if serving size is other than what is listed on above, please refer to manual cooking on page 15.

#### BEFORE Reheating/Cooking:

- Cover food with lid, or with vented plastic wrap. Never use tightly sealed plastic containers—they can prevent steam from escaping and cause food to overcook.

#### AFTER Reheating/Cooking:

All foods should have a standing time.

## Auto/Sensor Cook(Continued)

### Auto Cook:

#### Melt & Soften (No.17 - No.20)

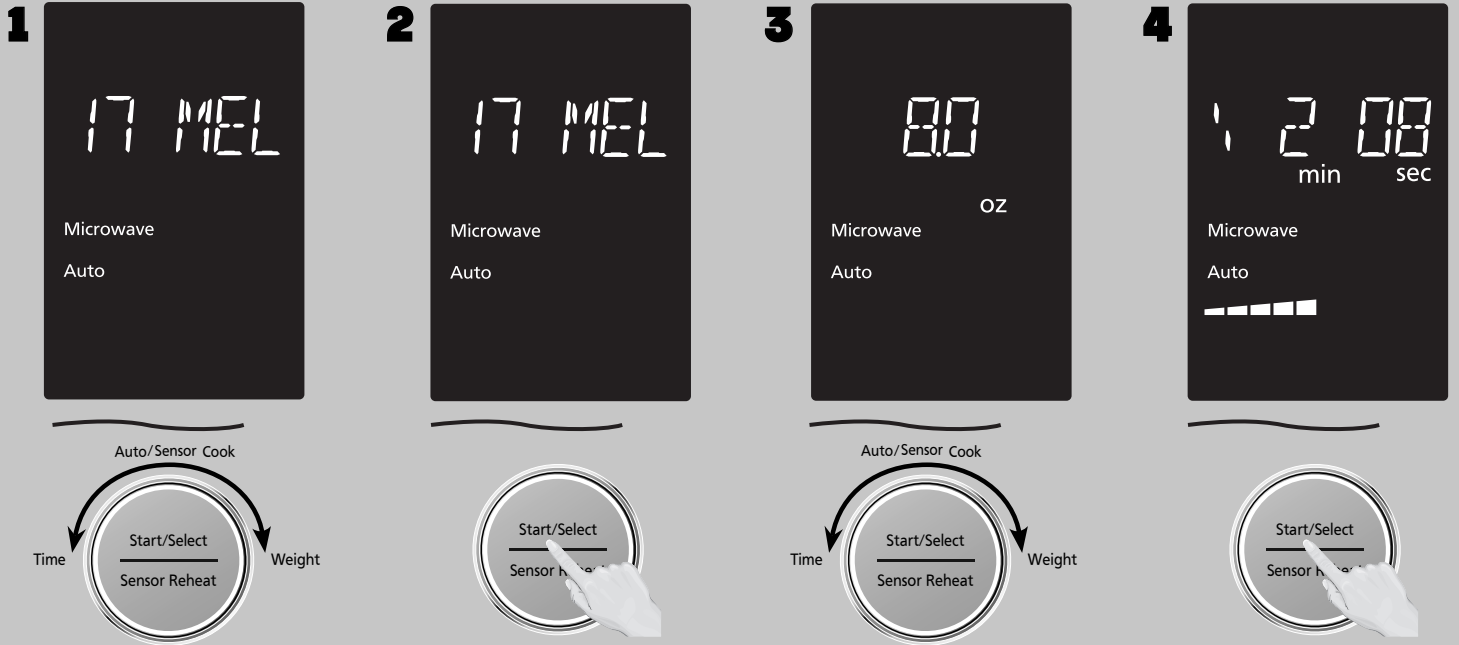

To allow auto program operation, ensure the oven is in Clock mode. Select the desired menu by turning the dial. (see chart below)

Press the dial to confirm the program.

Select the weight of the food by turning dial.

Press dial to **Start**. The time appears in the display window and begins to count down.

No.	Menu	Weight Range	Recommended Container	Hints
17	Melt Butter	2 - 12 oz (60 - 340 g)	microwave-safe dish	Remove wrapper, cut butter into 1 inch (3 cm) cube, and place in a microwave safe dish. Cover with plastic wrap.
18	Melt Chocolate	2 - 8 oz (60 - 230 g)	microwave-safe dish	Suitable for melting milk chocolate. Remove wrapper, separate chocolate into small pieces, and place in a microwave safe dish. Cook without cover. Stir after 2 beeps, and replace and press Start. Stir well after cooking.
19	Soften Butter	2 - 12 oz (60 - 340 g)	microwave-safe dish	Remove wrapper, cut butter into 1 inch (3 cm) cube, and place in a microwave safe dish. Cover with plastic wrap.
20	Soften Cream Cheese	2 - 12 oz (60 - 340 g)	microwave-safe dish	Remove wrapper, cut cheese into 1 inch (3 cm) cube, and place in a microwave safe dish. Cover with plastic wrap.

## MICROWAVE RECIPES

### OMELET

#### Basic Omelet Recipe

**Yield:** 1 Serving

1 tablespoon butter or margarine

2 eggs

2 tablespoons milk

Salt and ground black pepper, if desired Heat butter in a microwave safe 8-inch round dish, 20 seconds at PL10, or until melted.

Turn the dish to coat the bottom with butter.

Meanwhile, combine the remaining ingredients in a separate bowl, beat together and pour into the dish. Cook, covered with vented plastic wrap, cook 2 minutes at PL10. Let stand 2 minutes. With a spatula, loosen the edges of the omelet from the dish, fold into thirds to serve. **Always beat the eggs before making the omelet.**

**NOTE:** Double ingredients for a 4-egg Omelet.

### MACARONI AND CHEESE

**Yield:** 4 - 6 servings

2 1/2 tablespoons butter

1 1/2 tablespoons chopped onion

1/2 clove minced garlic

4 tablespoons all-purpose flour

2/3 teaspoon dry mustard

2/3 teaspoon salt

1/8 teaspoon ground black pepper

1 1/2 cups milk

1 1/2 cups grated cheddar cheese

140 g (5 oz.) (dry weight) macaroni, cooked and drained

3 tablespoons bread crumbs

2/3 teaspoon paprika

In a 3qt. casserole dish, melt the butter for 40 seconds at PL10, with cover with lid or vented plastic wrap. Add onion and garlic, cover the casserole dish with lid or vented plastic wrap, and cook for 1 minute at PL10. Stir in flour, mustard, salt and pepper, and gradually add the milk. Cover the casserole dish with lid or vented plastic wrap and cook for 3-4 minutes at PL10 until sauce thickens, stirring once.

Add the cheddar cheese and the macaroni into the sauce and stir well.

Sprinkle the bread crumbs and paprika on the top of the dish.

Cover with lid or vented plastic wrap.

Cook with the PL10 4-5minutes, then cook PL5 5minutes.

### BEEF AND MACARONI CASSEROLE

**Yield:** 4 - 6 servings

220 g (1/2 pound) lean ground beef

1/2 small onion, chopped

1/4 green bell pepper, chopped

1/2 cup chopped celery

1 (430 g/15 oz.) can tomato sauce

2/3 cup water

1/2 cup uncooked elbow macaroni

1/2 teaspoon parsley

1/4 teaspoon salt

1/8 teaspoon ground black pepper

1/4 cup grated cheddar cheese

Crumble the ground beef in a 3qt. casserole dish. Cook for 5-7 minutes at PL6 or until the meat is cooked, stirring twice. Stir in onion, peppers and celery. Cook for 3-4 minutes at PL10. Stir in the remaining ingredients, except cheese. Cover with lid or vented plastic wrap.

Cook with the PL10 4-5minutes, then cook PL5 5minutes. Sprinkle with cheese. Cover and let stand 5 minutes.

# Voice Command Chart

With the Amazon Alexa App or an Echo device you can enjoy hands-free cooking with over 100 Alexa voice commands.

MENU ITEM		COMMAND	QUANTITY RANGE	HINTS
Quick 30		Alexa, add 30 seconds to the microwave.	PL1 - PL10	-
Add Time		Alexa, add X minutes to the microwave. Alexa, add Y seconds to the microwave.	X = 01:00 – 60:00 Y = 00:01 - 00:59	-
Pause Time		Alexa, pause the microwave/cooking.	-	-
Stop Time		Alexa, stop the microwave.	-	-
Time Cook		Alexa, microwave for X minutes and Y seconds (at Z). Alexa, cook for X minutes and Y seconds (at Z).	X = 01:00 - 90:00 Y = 00:01 - 00:59 Z = Power Level 1–10 low/middium/high	If you don't mention Z(Power level), product always work with High power(PL10). PL10 cannot work with more than 30 min.
Warm		Alexa, Warm for X minutes and Y seconds.	X = 01:00 – 30:00 Y = 00:01 - 00:59	When you say "Warm", product always work with PL1 even though you mention other power level.
Time Defrost		Alexa, defrost for X minutes and Y seconds.	X = 01:00 - 90:00 Y = 00:01 - 00:59	-
Weight Defrost		Alexa, defrost X of food.	X = 0.3 - 6.0 lb. (100 - 2700 g)	-
Auto Defrost	Bread	Alexa, defrost X of Bread.	X= 1 - 4	-
	Wa es	Alexa, defrost X of Wa es.		-
	Roll	Alexa, defrost X of Roll.		-
	Sliced Bread	Alexa, defrost X of Slice bread.		-
	Pie	Alexa, defrost X of Pie.		-
	Ground beef	Alexa, defrost X of Ground beef.	X = 0.3 - 6.0 lb. (100 - 2700 g)	-
	Ground pork	Alexa, defrost X of Ground pork.		-
	Ground sausage	Alexa, defrost X of Ground sausage.		-
	Ground chicken	Alexa, defrost X of Ground chicken.		-
	Ground meat	Alexa, defrost X of Ground meat.		-
	Pattie	Alexa, defrost X of Pattie.		-
	Sausage	Alexa, defrost X of Sausage.		-
	Brat	Alexa, defrost X of Brat.		-
	Meat	Alexa, defrost X of Meat.		-
	Beef	Alexa, defrost X of Beef.		-
	Steak	Alexa, defrost X of Steak.		-
	Ribs	Alexa, defrost X of Ribs.		-
	Lamb chop	Alexa, defrost X of Lamb chop.		-
	Pork chop	Alexa, defrost X of Pork chop.		-
	Pork loin	Alexa, defrost X of Pork loin.		-
Whole chicken	Alexa, defrost X of Whole chicken.	-		
Chicken thigh	Alexa, defrost X of Chicken thigh.	-		
Chicken breast	Alexa, defrost X of Chicken breast.	-		

## Voice Command Chart

MENU ITEM		COMMAND	QUANTITY RANGE	HINTS
Auto Defrost	Chicken wings	Alexa, defrost X of Chicken wings.	X = 0.3 - 6.0 lb. (100 - 2700 g)	-
	Fish	Alexa, defrost X of Fish.		-
	Salmon	Alexa, defrost X of Salmon.		-
	Cod	Alexa, defrost X of Cod.		-
	Frozen Fruite	Alexa, defrost X of Frozen Fruites.		-
	Frozen Berries	Alexa, defrost X of Frozen Berries.		-
	Frozen Mango	Alexa, defrost X of Frozen Mango.		-
	Frozen Vegetables	Alexa, defrost X of Frozen Vegetables.		-
Reheat		Alexa, reheat for X minutes and Y seconds.	X = 01:00 - 30:00 Y = 00:01 - 00:59	If you don't mention food name, product work with High power(PL10).
Weight reheat	Coffee	Alexa, reheat X of Coffee.	X= 1 - 4 cups	1cup=250ml
	Milk	Alexa, reheat X of Milk.		1cup=250ml
	Hot Chocolate	Alexa, reheat X of Hot Chocolate.		1cup=250ml
	Soup	Alexa, reheat X of Soup.		1cup=250ml
	Pancakes	Alexa, reheat X of Pancakes.	X= 1 - 4	1= 1oz-1 ½oz(30-40g)
	Waffles	Alexa, reheat X of Waffles.		1= 1oz-1 ½oz(30-40g)
	Pie	Alexa, reheat X of Pie.		1= 2oz-3oz(60-85g)
	Brownie	Alexa, reheat X of Brownie.		1= 1oz-1 ½oz(30-40g)
	Bread	Alexa, reheat X of Bread.		1= 1oz-1 ½oz(30-40g)
	Dessert	Alexa, reheat X of Dessert.		1= 1oz-1 ½oz(30-40g)
Weight reheat (Frozen food)	Frozen Pancake	Alexa, microwave/cook X of Frozen Pancakes.	X= 1 - 4	1= 1oz-1 ½oz(30-40g)
	Frozen Waffles	Alexa, microwave/cook X of Frozen Waffles.		1= 1oz-1 ½oz(30-40g)
Popcorn		Alexa, microwave/cook X of popcorn.	X = 1.5 - 3.5 oz. (40 - 100 g)	-
Soften	Butter	Alexa, soften X of Butter.	X= 2 - 12 oz. (60 - 340 g)	-
	Ice cream	Alexa, soften X of Ice cream.	X= 3 - 48 oz. (85 - 1360 g)	-
	Cream cheese	Alexa, soften X of Cream cheese.	X= 2 - 12 oz. (60 - 340 g)	-
Melt	Butter	Alexa, melt X of Butter.		-
	Chocolate	Alexa, melt X of Chocolate.	X= 2 - 8 oz. (60 - 230 g)	-
Sensor reheat	Leftovers	Alexa, reheat Leftovers.	8 - 16 oz. (225 - 450 g)	-
	Pizza	Alexa, reheat Pizza.		-
	Casserole	Alexa, reheat Casserole.		-
	Potatoes	Alexa, reheat Potatoes.		-
	Vegetables	Alexa, reheat Vegetables.		-
	Chicken	Alexa, reheat Chicken.		-
	Lasagna	Alexa, reheat Lasagna.		-
	Pasta	Alexa, reheat Pasta.		-
	Dinner	Alexa, reheat Dinner.		-

## Voice Command Chart

MENU ITEM		COMMAND	QUANTITY RANGE	HINTS
Sensor cook	Oatmeal	Alexa, microwave/cook Oatmeal.	0.5 - 1.0 cup (1.4 - 2.8 oz) (40 - 80 g)	-
	Rice	Alexa, microwave/cook Rice.	0.5 - 1.5 cups	-
	Pasta	Alexa, microwave/cook Pasta.	1.75 - 5.5 oz (50 - 155 g)	-
Sensor cook (Vegetables)	Potatoes	Alexa, microwave/cook Potatoes.	1 - 4 potatoes (6 - 8 oz. each) (170 - 220 g)	-
	Fresh Vegetables	Alexa, microwave/cook Fresh Vegetables.	4 - 16 oz (110 - 450 g)	-
	Frozen Vegetables	Alexa, microwave/cook Frozen Vegetables.		-
	Vegetables	Alexa, microwave/cook Vegetables.		-
	Broccoli	Alexa, microwave/cook Broccoli.		-
	Frozen Broccoli	Alexa, microwave/cook Frozen Broccoli.		-
	Corn	Alexa, microwave/cook Corn.		-
	Frozen corn	Alexa, microwave/cook Frozen corn.		-
	Green beans	Alexa, microwave/cook Green beans.		-
	Frozen Green beans	Alexa, microwave/cook Frozen Green beans.		-
	Peas	Alexa, microwave/cook Peas.		-
	Frozen Peas	Alexa, microwave/cook Frozen Peas.		-
	Frozen Edamame	Alexa, microwave/cook Frozen Edamame.		-
	Squash	Alexa, microwave/cook Squash.		-
	Frozen Squash	Alexa, microwave/cook Frozen Squash.		-
	Sprouts	Alexa, microwave/cook Sprouts.		-
	Brussel Sprouts	Alexa, microwave/cook Brussel Sprouts.		-
	Frozen Brussel Sprouts	Alexa, microwave/cook Frozen Brussel Sprouts.		-
	Carrot	Alexa, microwave/cook Carrot.		-
	Frozen carrot	Alexa, microwave/cook Frozen carrot.		-
(Frozen)Mixed vegetables	Alexa, microwave/cook (Frozen)Mixed vegetables.	-		



# Voice Command Chart

MENU ITEM		COMMAND	QUANTITY RANGE	HINTS
Sensor cook (Frozen food)	Frozen Pizza	Alexa, microwave/cook Frozen Pizza.	6 - 12 oz	-
	Frozen Pie	Alexa, microwave/cook Frozen Pie.	(170 - 340 g)	-
	Frozen Entrée	Alexa, microwave/cook Frozen Entrée.	6 - 32 oz (170 - 900 g)	-
	Frozen Bowl	Alexa, microwave/cook Frozen Bowl.		-
	Frozen Lasagna	Alexa, microwave/cook Frozen Lasagna.		-
	Frozen Pasta	Alexa, microwave/cook Frozen Pasta.		-
	Frozen Dinner	Alexa, microwave/cook Frozen Dinner.	11 - 16 oz (300 - 450 g)	-
	Frozen Meal	Alexa, microwave/cook Frozen Meal.	-	
	Frozen Nuggets	Alexa, microwave/cook Frozen Nuggets.	4 - 12 oz (110 - 340 g)	-
	Frozen Fries	Alexa, microwave/cook Frozen Fries.		-
	Frozen Appetizers	Alexa, microwave/cook Frozen Appetizers.		-
	Frozen Quiche	Alexa, microwave/cook Frozen Quiche.		-
	Frozen Sandwich	Alexa, microwave/cook Frozen Sandwich.	1 - 2	-
	Frozen Burrito	Alexa, microwave/cook Frozen Burrito.		-
	Frozen hot pockets	Alexa, microwave/cook Frozen hot pockets.		-
	Frozen Breakfast	Alexa, microwave/cook Frozen Breakfast.		-

# Food Characteristics

## Food Characteristics

### Bone and Fat

Both bone and fat affect cooking. Bones may cause irregular cooking. Meat next to the tips of bones may overcook while meat positioned under a large bone, such as a ham bone, may be undercooked. Large amounts of fat absorb microwave energy and the meat next to these areas may overcook.



### Density

Porous, airy foods such as breads, cakes or rolls take less time to cook than heavy, dense foods such as potatoes and roasts. When reheating donuts or other foods with different centers be very careful. Certain foods have centers made with sugar, water, or fat and these centers attract microwaves (for example, jelly donuts). When a jelly donut is heated, the jelly can become extremely hot while the exterior remains warm to the touch. This could result in a burn if the food is not allowed to cool properly in the center.



### Quantity

Two potatoes take longer to cook than one potato. As the quantity of the food decreases so does the cooking time. Overcooking will cause the moisture content in the food to decrease and a fire could result. Never leave microwave unattended while in use.



### Shape

Uniform sizes heat more evenly. The thin end of a drumstick will cook more quickly than the meaty end. To compensate for irregular shapes, place thin parts toward the center of the dish and thick pieces toward the edge.



### Size

Thin pieces cook more quickly than thick pieces.



### Starting Temperature

Foods that are at room temperature take less time to cook than if they are chilled, refrigerated or frozen.



## Cooking Techniques

### Piercing

Foods with skins or membranes must be pierced, scored or have a strip of skin peeled before cooking to allow steam to escape. Pierce clams, oysters, chicken livers, whole potatoes and whole vegetables. Whole apples or new potatoes should have a 1-inch strip of skin peeled before cooking. Score sausages and frankfurters. Do not Cook/Reheat whole eggs, with or without the shell. Steam buildup in whole eggs may cause them to explode, and possibly damage the oven or cause injury. Reheating SLICED hard-boiled eggs and cooking SCRAMBLED eggs is safe.

### Browning

Foods will not have the same brown appearance as conventionally cooked foods or those foods which are cooked utilizing a browning feature. Meats and poultry may be coated with browning sauce, Worcestershire sauce, barbecue sauce or shake-on browning sauce. To use, combine browning sauce with melted butter or margarine and brush on before cooking. For quick breads or muffins, brown sugar can be used in the recipe in place of granulated sugar, or the surface can be sprinkled with dark spices before cooking.

### Spacing

Individual foods, such as baked potatoes, cupcakes and appetizers, will cook more evenly if placed in the oven equal distances apart. When possible, arrange foods in a circular pattern.

### Covering

As with conventional cooking, moisture evaporates during microwave cooking. Casserole lids or plastic wrap are used for a tighter seal. When using plastic wrap, vent the plastic wrap by folding back part of the plastic wrap from the edge of the dish to allow steam to escape. Loosen or remove plastic wrap as recipe directs for stand time. When removing plastic wrap covers, as well as any glass lids, be careful to remove them away from you to avoid steam burns. Various degrees of moisture retention are also obtained by using wax paper or paper towels.

### Cooking Time

Cooking times will vary because of food shape variations, starting temperature, and regional preferences. Always cook food for the minimum cooking time given in a recipe and check for doneness. If the food is undercooked, continue cooking. It is easier to add time to an undercooked product. Once the food is overcooked, nothing can be done.

### Stirring

Stirring is usually necessary during microwave cooking. Always bring the cooked outside edges toward the center and the less cooked center portions toward the outside of the dish.

### Rearranging

Rearrange small items such as chicken pieces, shrimp, hamburger patties or pork chops. Rearrange pieces from the edge to the center and pieces from the center to the edge of the dish.

### Turning

It is not possible to stir some foods to distribute the heat evenly. At times, microwave energy will concentrate in one area of the food. To help ensure even cooking, these foods need to be turned. Turn over large foods, such as roasts or turkeys, halfway through cooking.

### Standing Time

Most foods will continue to cook by conduction after the microwave oven is turned off. After cooking meat, the internal temperature will rise 5 °F to 15 °F (3 °C to 8 °C), if allowed to stand, tented with foil, for 10 to 15 minutes. Casseroles and vegetables need a shorter amount of standing time, but this standing time is necessary to allow foods to complete cooking to the center without overcooking on the edges.

### Test for Doneness

The same tests for doneness used in conventional cooking may be used for microwave cooking. Meat is done when fork-tender or splits at fibers. Chicken is done when juices are clear yellow and drumstick moves freely. Fish is done when it flakes and is opaque. Cake is done when a toothpick or cake tester is inserted and comes out clean.

Check foods to see that they are cooked to the United States Department of Agriculture's recommended temperatures.

To test for doneness, insert a meat thermometer in a thick or dense area away from fat or bone. NEVER leave the thermometer in the food during cooking, unless it is approved for microwave oven use.

Temp	Food
160 °F	For fresh pork, ground meat, boneless white poultry, fish, seafood, egg dishes and frozen prepared food.
165 °F	For leftover, ready-to-reheat refrigerated, and deli and carryout "fresh" food.
170 °F	For white meat poultry.
180 °F	For dark meat poultry.

# Care and Cleaning of Your Microwave Oven

Please see below and the following page for particular cleaning instructions for each section of the oven.

**BEFORE CLEANING:** Unplug oven at wall outlet. If outlet is inaccessible, leave oven door open while cleaning.

**AFTER CLEANING:** Be sure to place the Roller Ring and the Glass Tray in the proper position and press Stop/Reset Button to clear the Display.

1. **Outside oven surfaces:** Clean with a damp cloth. To prevent damage to the operating parts inside the oven, water should not be allowed to seep into ventilation openings.
2. **Label:** Do not remove. Wipe with a damp cloth.
3. **Inside the Oven:** Wipe with a damp cloth after using. Mild detergent may be used if needed. Do not use harsh detergents or abrasives.
4. **Oven Door:** Wipe with a soft dry cloth when steam accumulates inside or around the outside of the oven door. During cooking, especially under high humidity conditions, steam is given off from the food. (Some steam will condense on cooler surfaces, such as the oven door. This is normal.) Inside surface is covered with a heat and vapor barrier film. **Do not remove.**
5. **Oven Cavity Floor:** Clean the bottom surface of the oven with mild detergent, water or window cleaner, and dry.
6. **Wave Guide Cover:** Do not remove Wave Guide Cover. **It is important to keep cover clean in the same manner as the inside of the oven.**
7. **Control Panel:** The Control Panel is covered with a removable protective film to prevent scratches during shipping. Small bubbles may appear under this film, so if this is the case, remove by applying masking or clear tape to an exposed corner and pull gently. If the Control Panel becomes wet, clean it with a soft dry cloth. Do not use harsh detergents or abrasives.
8. **Glass Tray:** Remove and wash in warm soapy water or in a dishwasher.
9. **Roller Ring:** Roller Ring may be washed in mild soapy water or dishwasher. These areas should be kept clean to avoid excessive noise.

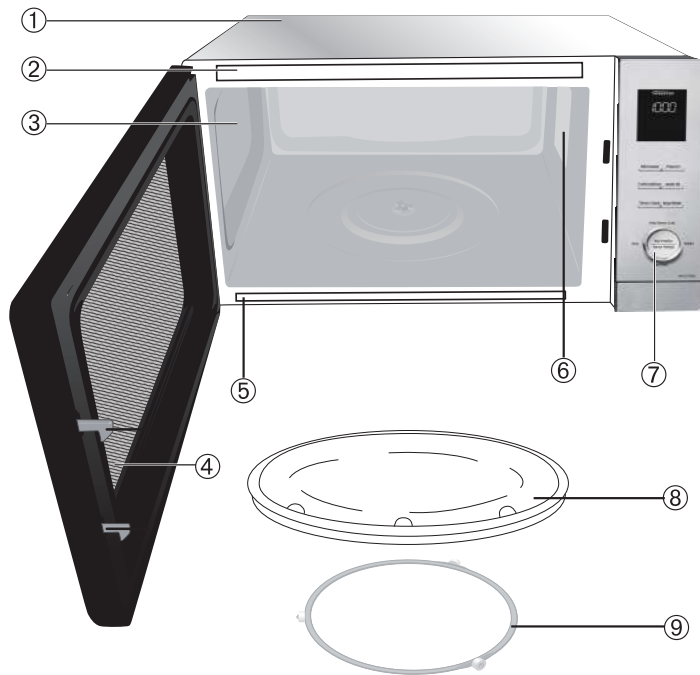

**IT IS IMPORTANT TO KEEP THE OVEN CLEAN AND DRY. FOOD RESIDUE AND CONDENSATION MAY CAUSE RUSTING OR ARCING AND DAMAGE TO THE OVEN. AFTER USE, WIPE DRY ALL SURFACES, INCLUDING VENT OPENINGS, OVEN SEAMS, AND UNDER GLASS TRAY.**

## Shop Accessories

Purchase Parts, Accessories and Instruction Books online for all Panasonic Products by visiting our Web Site at:  
<http://shop.panasonic.com/support>

### Parts Available to Order:

Instructions/Operating Manual (this book) .....	16170000A88673
Glass Tray .....	12570000008334
Roller Ring Assembly .....	12170000004310

## Before Requesting Service

See below before calling for service, as most problems can easily be remedied by following these simple solutions:

The oven causes TV interference.	Some radio and TV interference might occur when you cook with the microwave oven. This interference is similar to the interference caused by small appliances such as mixers, vacuums, blow dryers, etc. It does not indicate a problem with your oven.
Steam accumulates on oven door and warm air comes from the oven vents.	During cooking, steam and warm air are given off from the food. Most of the steam and warm air are removed from the oven by the air which circulates in the oven cavity. However, some steam will condense on cooler surfaces such as the oven door. This is normal. After use, the oven should be wiped dry (see page 40).
Oven will not turn on.	<p>The oven is not plugged in securely or needs to be reset; remove plug from outlet, wait ten seconds and re-insert.</p> <p>Main circuit breaker or main fuse is tripped; reset main circuit breaker or replace main fuse.</p> <p>There is a problem with the outlet; plug another appliance into the outlet to check if it is working.</p>
Oven will not start cooking.	<p>The door is not completely closed; close the oven door securely.</p> <p><b>Start</b> was not pressed after programming; press <b>Start</b>.</p> <p>Another program is already entered into the oven; press <b>Stop/Reset</b> to cancel the previous program and enter new program.</p> <p>The program is not correct; program again according to the Operating Instructions.</p> <p><b>Stop/Reset</b> has been pressed accidentally; program oven again.</p>
The Glass Tray wobbles.	The Glass Tray is not positioned properly on the Roller Ring or there is food under the Roller Ring; take out Glass Tray and Roller Ring. Wipe with a damp cloth and reset Roller Ring and Glass Tray properly.
When the oven is operating, there is noise coming from the Glass Tray.	The Roller Ring and oven bottom are dirty; clean these parts according to <b>Care and Cleaning of Your Microwave Oven</b> (see page 40).
"DEMO MODE PRESS ANY KEY" or "D" appears in the display window.	The oven is under demonstration mode. Press Microwave button once, Start 4 times and Stop/Reset button 4 times.
"  " appears in the display.	The CHILD SAFETY LOCK was activated by pressing <b>Stop/Reset</b> three times; Deactivate CHILD SAFETY LOCK by pressing <b>Stop/Reset</b> three times.

# Limited Warranty (Only for U.S.A.)

## Panasonic Products Limited Warranty

### Limited Warranty Coverage (For USA Only)

If your product does not work properly because of a defect in materials or workmanship, Panasonic Consumer Electronics Company (referred to as "the warrantor") will, for the length of the period indicated on the chart below, which starts with the date of original purchase ("warranty period"), at its option either (a) repair your product with new or refurbished parts, (b) replace it with a new or a refurbished equivalent value product, or (c) refund your purchase price. The decision to repair, replace or refund will be made by the warrantor.

Product or Part Name	Labor	Parts
<b>ALL PARTS</b> (EXCEPT MAGNETRON TUBE)	1 yr.	1 yr.
<b>MAGNETRON TUBE</b>	1 yr.	5 yr.

During the "Labor" warranty period there will be no charge for labor. During the "Parts" warranty period, there will be no charge for parts. This warranty only applies to products purchased and serviced in the United States. This warranty is extended only to the original purchaser of a new product which was not sold "as is".

### Mail-In Service – Online Repair Request

To submit a new repair request, and for quick repair status visit our Web Site at: <http://shop.panasonic.com/support>

When shipping the unit, carefully pack and send it in the original (or supplied) carton. Include a letter detailing the complaint along with the bill of sales and provide a daytime phone number where you can be reached. A valid registered receipt is required under the Limited Warranty.

When shipping Lithium Ion batteries please visit our web site at <http://shop.panasonic.com/support> as Panasonic is committed to providing the most up to date information.

**IF REPAIR IS NEEDED DURING THE WARRANTY PERIOD, THE PURCHASER WILL BE REQUIRED TO FURNISH A SALES RECEIPT/PROOF OF PURCHASE INDICATING DATE OF PURCHASE, AMOUNT PAID AND PLACE OF PURCHASE. CUSTOMER WILL BE CHARGED FOR THE REPAIR OF ANY UNIT RECEIVED WITHOUT SUCH PROOF OF PURCHASE.**

### Limited Warranty Limits And Exclusions

This warranty ONLY COVERS failures due to defects in materials or workmanship, and DOES NOT COVER glass, plastic parts, temperature probes (if included) and normal wear and tear or cosmetic damage. The warranty ALSO DOES NOT COVER damages which occurred in shipment, or failures which are caused by products not supplied by the warrantor, or failures which result from accidents, misuse, abuse, neglect, bug infestation, mishandling, misapplication, alteration, faulty installation, set-up adjustments, maladjustment of consumer controls, improper maintenance, power line surge, lightning damage, modification, or commercial use (such as in a hotel, office, restaurant, or other business), rental use of the product, service by anyone other than a Factory Service center or other Authorized Servicer, or damage that is attributable to acts of God.

**THERE ARE NO EXPRESS WARRANTIES EXCEPT AS LISTED UNDER "LIMITED WARRANTY COVERAGE".**

**THE WARRANTOR IS NOT LIABLE FOR INCIDENTAL OR CONSEQUENTIAL DAMAGES RESULTING FROM THE USE OF THIS PRODUCT, OR ARISING OUT OF ANY BREACH OF THIS WARRANTY.**

(As examples, this excludes damages for lost time, travel to and from the servicer, loss of or damage to media or images, data or other memory or recorded content. The items listed are not exclusive, but for illustration only.)

**ALL EXPRESS AND IMPLIED WARRANTIES, INCLUDING THE WARRANTY OF MERCHANTABILITY, ARE LIMITED TO THE PERIOD OF THE LIMITED WARRANTY.**

Some states do not allow the exclusion or limitation of incidental or consequential damages, or limitations on how long an implied warranty lasts, so the exclusions may not apply to you.

This warranty gives you specific legal rights and you may also have other rights which vary from state to state. If a problem with this product develops during or after the warranty period, you may contact your dealer or Service Center. If the problem is not handled to your satisfaction, then write to:

Panasonic Consumer Electronics Company of North America  
Consumer Affairs Department 8th Fl.  
Two Riverfront Plaza  
Newark NJ 07102-5490

**PARTS AND SERVICE, WHICH ARE NOT COVERED BY THIS LIMITED WARRANTY, ARE YOUR RESPONSIBILITY.**

Product registration is not mandatory. Failure to complete the form does not affect the consumer's warranty rights.

## **Shop Accessories!**

for all your Panasonic gear

Go to

<http://shop.panasonic.com/support>

Get everything you need to get the most out of your Panasonic products  
Accessories & Parts for your Camera, Phone, A/V products, TV, Computers & Networking, Personal Care, Home Appliances, Headphones, Batteries, Backup Chargers & more...

## **Customer Services Directory**

For Product Information, Operating Assistance, Parts, Owner's Manuals, Dealer and Service info  
go to <http://shop.panasonic.com/support>

For the hearing or speech impaired TTY: 1- 877-833-8855

As of October 15 2021



# Copyright Information

This product incorporates the following software:

- (1) the software developed for Panasonic Consumer Electronics Company
- (2) the software owned by third party and licensed to Panasonic Consumer Electronics Company,
- (3) open source software.

The software categorized as (3) is distributed in the hope that it will be useful, but WITHOUT ANY WARRANTY, without even the implied warranty of MERCHANTABILITY or FITNESS FOR A PARTICULAR PURPOSE. Please refer to the detailed terms and conditions there of shown below.

ACK Module with MediaTek chipset Firmware 1352 (3.211135220.build2009222236)

Copyright 2020 Amazon.com, Inc. or its affiliates. All Rights Reserved.

## NOTICE RELATING TO OPEN SOURCE SOFTWARE

This product contains software ("Open Source Software") that is provided to you under open source licenses. In the event of a conflict between the software license in the Amazon terms applicable to this product and the open source license applicable to such Open Source Software, the open source license will prevail with respect to that Open Source Software. Some open source licenses give you the right to obtain a copy of source code. A copy of source code for Open Source Software licensed under such licenses is provided with this product.

\*\*\*\*\*

### Open Source Software Components

\*\*\*\*\*

\*\* mbedTLS; version 2.16.6 -- <https://tls.mbed.org/>

Copyright (C) 2006-2015, ARM Limited, All Rights Reserved

Apache License

Version 2.0, January 2004

<http://www.apache.org/licenses/> TERMS AND CONDITIONS FOR USE, REPRODUCTION, AND

## DISTRIBUTION

Copyright (C) 2020 Nuvoton Technology Corp. All rights reserved

Copyright (C) 2018 Nuvoton Technology Corp. All rights reserved

Copyright 2018-2019 Amazon.com, Inc. or its affiliates. All Rights Reserved

Copyright (c) 2009 - 2015 ARM LIMITED

Copyright (C) 2010-2014 ARM Limited. All rights reserved

Copyright (C) 2010-2015 ARM Limited. All rights reserved

## 1. Definitions.

"License" shall mean the terms and conditions for use, reproduction, and distribution as defined by Sections 1 through 9 of this document. "Licensor" shall mean the copyright owner or entity authorized by the copyright owner that is granting the License.

"Legal Entity" shall mean the union of the acting entity and all other entities that control, are controlled by, or are under common control with that entity. For the purposes of this definition, "control" means (i) the power, direct or indirect, to cause the direction or management of such entity, whether by contract or otherwise, or (ii) ownership of fifty percent (50%) or more of the outstanding shares, or (iii) beneficial ownership of such entity.

"You" (or "Your") shall mean an individual or Legal Entity exercising permissions granted by this License.

"Source" form shall mean the preferred form for making modifications, including but not limited to software source code, documentation source, and configuration files.

"Object" form shall mean any form resulting from mechanical transformation or translation of a Source form, including but not limited to compiled object code, generated documentation, and conversions to other media types.

"Work" shall mean the work of authorship, whether in Source or Object form, made available under the License, as indicated by a copyright notice that is included in or attached to the work (an example is provided in the Appendix below).

"Derivative Works" shall mean any work, whether in Source or Object form, that is based on (or derived from) the Work and for which the editorial revisions, annotations, elaborations, or other modifications represent, as a whole, an original work of authorship. For the purposes of this License, Derivative Works shall not include works that remain separable from, or merely link (or bind by name) to the interfaces of, the Work and Derivative Works thereof.

"Contribution" shall mean any work of authorship, including the original version of the Work and any modifications or additions to that Work or Derivative Works thereof, that is intentionally submitted to Licensor for inclusion in the Work by the copyright owner or by an

# Copyright Information

individual or Legal Entity authorized to submit on behalf of the copyright owner. For the purposes of this definition, "submitted" means any form of electronic, verbal, or written communication sent to the Licensor or its representatives, including but not limited to communication on electronic mailing lists, source code control systems, and issue tracking systems that are managed by, or on behalf of, the Licensor for the purpose of discussing and improving the Work, but excluding communication that is conspicuously marked or otherwise designated in writing by the copyright owner as "Not a Contribution."

"Contributor" shall mean Licensor and any individual or Legal Entity on behalf of whom a Contribution has been received by Licensor and subsequently incorporated within the Work.

2. Grant of Copyright License. Subject to the terms and conditions of this License, each Contributor hereby grants to You a perpetual, worldwide, non-exclusive, no-charge, royalty-free, irrevocable copyright license to reproduce, prepare Derivative Works of, publicly display, publicly perform, sublicense, and distribute the Work and such Derivative Works in Source or Object form.

3. Grant of Patent License. Subject to the terms and conditions of this License, each Contributor hereby grants to You a perpetual, worldwide, non-exclusive, no-charge, royalty-free, irrevocable (except as stated in this section) patent license to make, have made, use, offer to sell, sell, import, and otherwise transfer the Work, where such license applies only to those patent claims licensable by such Contributor that are necessarily infringed by their Contribution(s) alone or by combination of their Contribution(s) with the Work to which such Contribution(s) was submitted. If You institute patent litigation against any entity (including a cross-claim or counterclaim in a lawsuit) alleging that the Work or a Contribution incorporated within the Work constitutes direct or contributory patent infringement, then any patent licenses granted to You under this License for that Work shall terminate as of the date such litigation is filed.

4. Redistribution. You may reproduce and distribute copies of the Work or Derivative Works thereof in any medium, with or without modifications, and in Source or Object form, provided that You meet the following conditions:

- (a) You must give any other recipients of the Work or Derivative Works a copy of this License; and
- (b) You must cause any modified files to carry prominent notices stating that You changed the files; and
- (c) You must retain, in the Source form of any Derivative Works that You distribute, all copyright, patent, trademark, and attribution notices from the Source form of the Work, excluding those notices that do not pertain to any part of the Derivative Works; and
- (d) If the Work includes a "NOTICE" text file as part of its distribution, then any Derivative Works that You distribute must include a readable copy of the attribution notices contained within such NOTICE file, excluding those notices that do not pertain to any part of the Derivative Works, in at least one of the following places: within a NOTICE text file distributed as part of the Derivative Works; within the Source form or documentation, if provided along with the Derivative Works; or, within a display generated by the Derivative Works, if and wherever such third-party notices normally appear. The contents of the NOTICE file are for informational purposes only and do not modify the License. You may add Your own attribution notices within Derivative Works that You distribute, alongside or as an addendum to the NOTICE text from the Work, provided that such additional attribution notices cannot be construed as modifying the License. You may add Your own copyright statement to Your modifications and may provide additional or different license terms and conditions for use, reproduction, or distribution of Your modifications, or for any such Derivative Works as a whole, provided Your use, reproduction, and distribution of the Work otherwise complies with the conditions stated in this License.

5. Submission of Contributions. Unless You explicitly state otherwise, any Contribution intentionally submitted for inclusion in the Work by You to the Licensor shall be under the terms and conditions of this License, without any additional terms or conditions. Notwithstanding the above, nothing herein shall supersede or modify the terms of any separate license agreement you may have executed with Licensor regarding such Contributions.

6. Trademarks. This License does not grant permission to use the trade names, trademarks, service marks, or product names of the Licensor, except as required for reasonable and customary use in describing the origin of the Work and reproducing the content of the NOTICE file.

7. Disclaimer of Warranty. Unless required by applicable law or agreed to in writing, Licensor provides the Work (and each Contributor provides its Contributions) on an "AS IS" BASIS, WITHOUT WARRANTIES OR CONDITIONS OF ANY KIND, either express or implied, including, without limitation, any warranties or conditions of TITLE, NON-INFRINGEMENT, MERCHANTABILITY, or FITNESS FOR A PARTICULAR PURPOSE. You are solely responsible for determining the appropriateness of using or redistributing the Work and assume any risks associated with Your exercise of permissions under this License.

## Copyright Information

8. Limitation of Liability. In no event and under no legal theory, whether in tort (including negligence), contract, or otherwise, unless required by applicable law (such as deliberate and grossly negligent acts) or agreed to in writing, shall any Contributor be liable to You for damages, including any direct, indirect, special, incidental, or consequential damages of any character arising as a result of this License or out of the use or inability to use the Work (including but not limited to damages for loss of goodwill, work stoppage, computer failure or malfunction, or any and all other commercial damages or losses), even if such Contributor has been advised of the possibility of such damages.

9. Accepting Warranty or Additional Liability. While redistributing the Work or Derivative Works thereof, You may choose to offer, and charge a fee for, acceptance of support, warranty, indemnity, or other liability obligations and/or rights consistent with this License. However, in accepting such obligations, You may act only on Your own behalf and on Your sole responsibility, not on behalf of any other Contributor, and only if You agree to indemnify, defend, and hold each Contributor harmless for any liability incurred by, or claims asserted against, such Contributor by reason of your accepting any such warranty or additional liability. END OF TERMS AND CONDITIONS.

APPENDIX: How to apply the Apache License to your work.

To apply the Apache License to your work, attach the following boilerplate notice, with the fields enclosed by brackets "[]" replaced with your own identifying information. (Don't include the brackets!) The text should be enclosed in the appropriate comment syntax for the file format. We also recommend that a file or class name and description of purpose be included on the same "printed page" as the copyright notice for easier identification within third-party archives.

Copyright [yyyy] [name of copyright owner] Licensed under the Apache License, Version 2.0 (the "License"); you may not use this file except in compliance with the License. You may obtain a copy of the License at <http://www.apache.org/licenses/LICENSE-2.0> Unless required by applicable law or agreed to in writing, software distributed under the License is distributed on an "AS IS" BASIS, WITHOUT WARRANTIES OR CONDITIONS OF ANY KIND, either express or implied. See the License for the specific language governing permissions and limitations under the License.

\* For mbedTLS see also this required NOTICE:

Copyright (C) 2006-2015, ARM Limited, All Rights Reserved

-----  
\*\* axTLS Embedded SSL; version not declared --<http://sourceforge.net/projects/axtls/> Copyright (c) 2008, Cameron Rich All rights reserved. Redistribution and use in source and binary forms, with or without modification, are permitted provided that the following conditions are met:

Redistributions of source code must retain the above copyright notice, this list of conditions and the following disclaimer. Redistributions in binary form must reproduce the above copyright notice, this list of conditions and the following disclaimer in the documentation and/or other materials provided with the distribution. Neither the name of the axTLS Project nor the names of its contributors may be used to endorse or promote products derived from this software without specific prior written permission.

THIS SOFTWARE IS PROVIDED BY THE COPYRIGHT HOLDERS AND CONTRIBUTORS "AS IS" AND ANY EXPRESS OR IMPLIED WARRANTIES, INCLUDING, BUT NOT LIMITED TO, THE IMPLIED WARRANTIES OF MERCHANTABILITY AND FITNESS FOR A PARTICULAR PURPOSE ARE DISCLAIMED. IN NO EVENT SHALL THE REGENTS OR CONTRIBUTORS BE LIABLE FOR ANY DIRECT, INDIRECT, INCIDENTAL, SPECIAL, EXEMPLARY, OR CONSEQUENTIAL DAMAGES (INCLUDING, BUT NOT LIMITED TO, PROCUREMENT OF SUBSTITUTE GOODS OR SERVICES; LOSS OF USE, DATA, OR PROFITS; OR BUSINESS INTERRUPTION) HOWEVER CAUSED AND ON ANY THEORY OF LIABILITY, WHETHER IN CONTRACT, STRICT LIABILITY, OR TORT (INCLUDING NEGLIGENCE OR OTHERWISE) ARISING IN ANY WAY OUT OF THE USE OF THIS SOFTWARE, EVEN IF ADVISED OF THE POSSIBILITY OF SUCH DAMAGE.

-----  
\*\* FreeBSD; version 8.2 -- <https://www.freebsd.org/>  
Copyright (c) 1992-2017 The FreeBSD Project. All rights reserved.

# \$FreeBSD\$

# @(#)COPYRIGHT 8.2 (Berkeley) 3/21/94

The compilation of software known as FreeBSD is distributed under the following terms:

Copyright (c) 1992-2017 The FreeBSD Project. All rights reserved.

Redistribution and use in source and binary forms, with or without modification, are permitted provided that the following conditions are met:

1. Redistributions of source code must retain the above copyright notice, this list of conditions and the following disclaimer.
2. Redistributions in binary form must reproduce the above copyright notice, this list of conditions and the following disclaimer in the documentation and/or other materials provided with the distribution.

THIS SOFTWARE IS PROVIDED BY THE AUTHOR AND CONTRIBUTORS ``AS IS" AND ANY EXPRESS OR IMPLIED WARRANTIES, INCLUDING, BUT NOT LIMITED TO, THE IMPLIED WARRANTIES OF MERCHANTABILITY AND FITNESS FOR A PARTICULAR PURPOSE ARE DISCLAIMED. IN NO EVENT SHALL THE AUTHOR OR CONTRIBUTORS BE LIABLE FOR ANY DIRECT, INDIRECT, INCIDENTAL, SPECIAL, EXEMPLARY, OR CONSEQUENTIAL DAMAGES (INCLUDING, BUT NOT LIMITED TO, PROCUREMENT OF SUBSTITUTE GOODS OR SERVICES; LOSS OF USE, DATA, OR PROFITS; OR BUSINESS INTERRUPTION) HOWEVER CAUSED AND ON ANY THEORY OF LIABILITY, WHETHER IN CONTRACT, STRICT LIABILITY, OR TORT (INCLUDING NEGLIGENCE OR OTHERWISE) ARISING IN ANY WAY OUT OF THE USE OF THIS SOFTWARE, EVEN IF ADVISED OF THE POSSIBILITY OF SUCH DAMAGE.



# Copyright Information

The 4.BSD and 4.BSD-Lite software is distributed under the following terms:

All of the documentation and software included in the 4.BSD and 4.BSD-Lite. Releases is copyrighted by The Regents of the University of California. Copyright 1979, 1980, 1983, 1986, 1988, 1989, 1991, 1992, 1993, 1994 .The Regents of the University of California. All rights reserved.

Redistribution and use in source and binary forms, with or without modification, are permitted provided that the following conditions are met:

1. Redistributions of source code must retain the above copyright notice, this list of conditions and the following disclaimer.
2. Redistributions in binary form must reproduce the above copyright notice, this list of conditions and the following disclaimer in the documentation and/or other materials provided with the distribution.
3. All advertising materials mentioning features or use of this software must display the following acknowledgement:  
This product includes software developed by the University of California, Berkeley and its contributors.
4. Neither the name of the University nor the names of its contributors may be used to endorse or promote products derived from this software without specific prior written permission.

THIS SOFTWARE IS PROVIDED BY THE REGENTS AND CONTRIBUTORS ``AS IS" AND ANY EXPRESS OR IMPLIED WARRANTIES, INCLUDING, BUT NOT LIMITED TO, THE IMPLIED WARRANTIES OF MERCHANTABILITY AND FITNESS FOR A PARTICULAR PURPOSE ARE DISCLAIMED. IN NO EVENT SHALL THE REGENTS OR CONTRIBUTORS BE LIABLE FOR ANY DIRECT, INDIRECT, INCIDENTAL, SPECIAL, EXEMPLARY, OR CONSEQUENTIAL DAMAGES (INCLUDING, BUT NOT LIMITED TO, PROCUREMENT OF SUBSTITUTE GOODS OR SERVICES; LOSS OF USE, DATA, OR PROFITS; OR BUSINESS INTERRUPTION) HOWEVER CAUSED AND ON ANY THEORY OF LIABILITY, WHETHER IN CONTRACT, STRICT LIABILITY, OR TORT (INCLUDING NEGLIGENCE OR OTHERWISE) ARISING IN ANY WAY OUT OF THE USE OF THIS SOFTWARE, EVEN IF ADVISED OF THE POSSIBILITY OF SUCH DAMAGE.

The Institute of Electrical and Electronics Engineers and the American National Standards Committee X3, on Information Processing Systems have given us permission to reprint portions of their documentation.

In the following statement, the phrase ``this text" refers to portions of the system documentation.

Portions of this text are reprinted and reproduced in electronic form in the second BSD Networking Software Release, from IEEE Std 1003.1-1988, IEEE Standard Portable Operating System Interface for Computer Environments (POSIX), copyright C 1988 by the Institute of Electrical and Electronics Engineers, Inc. In the event of any discrepancy between these versions and the original IEEE Standard, the original IEEE Standard is the referee document.

In the following statement, the phrase ``This material" refers to portions of the system documentation.

This material is reproduced with permission from American National Standards Committee X3, on Information Processing Systems. Computer and Business Equipment Manufacturers Association (CBEMA), 311 First St., NW, Suite 500, Washington, DC 20001-2178. The developmental work of Programming Language C was completed by the X3J11 Technical Committee.

The views and conclusions contained in the software and documentation are those of the authors and should not be interpreted as representing official policies, either expressed or implied, of the Regents of the University of California.

NOTE: The copyright of UC Berkeley's Berkeley Software Distribution ("BSD")

source has been updated. The copyright addendum may be found at <ftp://ftp.cs.berkeley.edu/pub/4bsd/README.Impt.License.Change> and is included below.

July 22, 1999

To All Licensees, Distributors of Any Version of BSD:

As you know, certain of the Berkeley Software Distribution ("BSD") source code files require that further distributions of products containing all or portions of the software, acknowledge within their advertising materials that such products contain software developed by UC Berkeley and its contributors.

Specifically, the provision reads:

- " \* 3. All advertising materials mentioning features or use of this software
  - \* must display the following acknowledgement:
  - \* This product includes software developed by the University of
  - \* California, Berkeley and its contributors."

Effective immediately, licensees and distributors are no longer required to include the acknowledgement within advertising materials. Accordingly, the foregoing paragraph of those BSD Unix files containing it is hereby deleted in its entirety.

William Hoskins

Director, Office of Technology Licensing University of California, Berkeley

-----

\*\* iperf; version not declared -- <https://github.com/esnet/iperf> iperf, Copyright (c) 2014-2018, The Regents of the University of California, through Lawrence Berkeley National Laboratory (subject to receipt of any required approvals from the U.S. Dept. of Energy). All rights reserved.

# Copyright Information

Redistribution and use in source and binary forms, with or without modification, are permitted provided that the following conditions are met:

- (1) Redistributions of source code must retain the above copyright notice, this list of conditions and the following disclaimer.
- (2) Redistributions in binary form must reproduce the above copyright notice, this list of conditions and the following disclaimer in the documentation and/ or other materials provided with the distribution.
- (3) Neither the name of the University of California, Lawrence Berkeley National Laboratory, U.S. Dept. of Energy nor the names of its contributors may be used to endorse or promote products derived from this software without specific prior written permission.

THIS SOFTWARE IS PROVIDED BY THE COPYRIGHT HOLDERS AND CONTRIBUTORS "AS IS" AND ANY EXPRESS OR IMPLIED WARRANTIES, INCLUDING, BUT NOT LIMITED TO, THE IMPLIED WARRANTIES OF MERCHANTABILITY AND FITNESS FOR A PARTICULAR PURPOSE ARE DISCLAIMED. IN NO EVENT SHALL THE COPYRIGHT OWNER OR CONTRIBUTORS BE LIABLE FOR ANY DIRECT, INDIRECT, INCIDENTAL, SPECIAL, EXEMPLARY, OR CONSEQUENTIAL DAMAGES (INCLUDING, BUT NOT LIMITED TO, PROCUREMENT OF SUBSTITUTE GOODS OR SERVICES; LOSS OF USE, DATA, OR PROFITS; OR BUSINESS INTERRUPTION) HOWEVER CAUSED AND ON ANY THEORY OF LIABILITY, WHETHER IN CONTRACT, STRICT LIABILITY, OR TORT (INCLUDING NEGLIGENCE OR OTHERWISE) ARISING IN ANY WAY OUT OF THE USE OF THIS SOFTWARE, EVEN IF ADVISED OF THE POSSIBILITY OF SUCH DAMAGE.

You are under no obligation whatsoever to provide any bug fixes, patches, or upgrades to the features, functionality or performance of the source code ("Enhancements") to anyone; however, if you choose to make your Enhancements available either publicly, or directly to Lawrence Berkeley National Laboratory, without imposing a separate written license agreement for such Enhancements, then you hereby grant the following license: a non-exclusive, royalty-free perpetual license to install, use, modify, prepare derivative works, incorporate into other computer software, distribute, and sublicense such enhancements or derivative works thereof, in binary and source code form.

=====

This software contains source code (src/cjson.{c,h}) that is:

Copyright (c) 2009 Dave Gamble

Permission is hereby granted, free of charge, to any person obtaining a copy of this software and associated documentation files (the "Software"), to deal in the Software without restriction, including without limitation the rights to use, copy, modify, merge, publish, distribute, sublicense, and/or sell copies of the Software, and to permit persons to whom the Software is furnished to do so, subject to the following conditions:

The above copyright notice and this permission notice shall be included in all copies or substantial portions of the Software.

THE SOFTWARE IS PROVIDED "AS IS", WITHOUT WARRANTY OF ANY KIND, EXPRESS OR IMPLIED, INCLUDING BUT NOT LIMITED TO THE WARRANTIES OF MERCHANTABILITY, FITNESS FOR A PARTICULAR PURPOSE AND NONINFRINGEMENT. IN NO EVENT SHALL THE AUTHORS OR COPYRIGHT HOLDERS BE LIABLE FOR ANY CLAIM, DAMAGES OR OTHER LIABILITY, WHETHER IN AN ACTION OF CONTRACT, TORT OR OTHERWISE, ARISING FROM, OUT OF OR IN CONNECTION WITH THE SOFTWARE OR THE USE OR OTHER DEALINGS IN THE SOFTWARE.

=====

This software contains source code (src/net.{c,h}) that is:

This software was developed as part of a project at MIT.

Copyright (c) 2005-2007 Russ Cox,

Massachusetts Institute of Technology

Permission is hereby granted, free of charge, to any person obtaining a copy of this software and associated documentation files (the "Software"), to deal in the Software without restriction, including without limitation the rights to use, copy, modify, merge, publish, distribute, sublicense, and/or sell copies of the Software, and to permit persons to whom the Software is furnished to do so, subject to the following conditions:

The above copyright notice and this permission notice shall be included in all copies or substantial portions of the Software.

THE SOFTWARE IS PROVIDED "AS IS", WITHOUT WARRANTY OF ANY KIND, EXPRESS OR IMPLIED, INCLUDING BUT NOT LIMITED TO THE WARRANTIES OF MERCHANTABILITY, FITNESS FOR A PARTICULAR PURPOSE AND NONINFRINGEMENT. IN NO EVENT SHALL THE AUTHORS OR COPYRIGHT HOLDERS BE LIABLE FOR ANY CLAIM, DAMAGES OR OTHER LIABILITY, WHETHER IN AN ACTION OF CONTRACT, TORT OR OTHERWISE, ARISING FROM, OUT OF OR IN CONNECTION WITH THE SOFTWARE OR THE USE OR OTHER DEALINGS IN THE SOFTWARE.

====

Contains parts of an earlier library that has:

\* The authors of this software are Rob Pike, Sape Mullender, and Russ Cox

\* Copyright (c) 2003 by Lucent Technologies.

\* Permission to use, copy, modify, and distribute this software for any purpose without fee is hereby granted, provided that this entire notice is included in all copies of any software which is or includes a copy or modification of this software and in all copies of the supporting documentation for such software.

## Copyright Information

\* THIS SOFTWARE IS BEING PROVIDED "AS IS", WITHOUT ANY EXPRESS OR IMPLIED WARRANTY. IN PARTICULAR, NEITHER THE AUTHORS NOR LUCENT TECHNOLOGIES MAKE ANY REPRESENTATION OR WARRANTY OF ANY KIND CONCERNING THE MERCHANTABILITY OF THIS SOFTWARE OR ITS FITNESS FOR ANY PARTICULAR PURPOSE.

\* THIS SOFTWARE IS BEING PROVIDED "AS IS", WITHOUT ANY EXPRESS OR IMPLIED WARRANTY. IN PARTICULAR, NEITHER THE AUTHORS NOR LUCENT TECHNOLOGIES MAKE ANY REPRESENTATION OR WARRANTY OF ANY KIND CONCERNING THE MERCHANTABILITY OF THIS SOFTWARE OR ITS FITNESS FOR ANY PARTICULAR PURPOSE.

=====

This software contains source code (src/net.c) that is:

\* Copyright (c) 2001 Eric Jackson <ericj@monkey.org>

\* Redistribution and use in source and binary forms, with or without modification, are permitted provided that the following conditions are met:

1. Redistributions of source code must retain the above copyright notice, this list of conditions and the following disclaimer.
2. Redistributions in binary form must reproduce the above copyright notice, this list of conditions and the following disclaimer in the documentation and/or other materials provided with the distribution.
3. The name of the author may not be used to endorse or promote products derived from this software without specific prior written permission.

\*THIS SOFTWARE IS PROVIDED BY THE AUTHOR ``AS IS" AND ANY EXPRESS OR IMPLIED WARRANTIES, INCLUDING, BUT NOT LIMITED TO, THE IMPLIED WARRANTIES OF MERCHANTABILITY AND FITNESS FOR A PARTICULAR PURPOSE ARE DISCLAIMED. IN NO EVENT SHALL THE AUTHOR BE LIABLE FOR ANY DIRECT, INDIRECT, INCIDENTAL, SPECIAL, EXEMPLARY, OR CONSEQUENTIAL DAMAGES (INCLUDING, BUT NOT LIMITED TO, PROCUREMENT OF SUBSTITUTE GOODS OR SERVICES; LOSS OF USE, DATA, OR PROFITS; OR BUSINESS INTERRUPTION) HOWEVER CAUSED AND ON ANY THEORY OF LIABILITY, WHETHER IN CONTRACT, STRICT LIABILITY, OR TORT (INCLUDING NEGLIGENCE OR OTHERWISE) ARISING IN ANY WAY OUT OF THE USE OF THIS SOFTWARE, EVEN IF ADVISED OF THE POSSIBILITY OF SUCH DAMAGE.

=====

This software contains source code (src/queue.h) that is:

\* Copyright (c) 1991, 1993

\* The Regents of the University of California. All rights reserved.

\* Redistribution and use in source and binary forms, with or without modification, are permitted provided that the following conditions are met:

1. Redistributions of source code must retain the above copyright notice, this list of conditions and the following disclaimer.
2. Redistributions in binary form must reproduce the above copyright notice, this list of conditions and the following disclaimer in the documentation and/or other materials provided with the distribution.
3. Neither the name of the University nor the names of its contributors may be used to endorse or promote products derived from this software without specific prior written permission.

\* THIS SOFTWARE IS PROVIDED BY THE REGENTS AND CONTRIBUTORS ``AS IS" AND ANY EXPRESS OR IMPLIED WARRANTIES, INCLUDING, BUT NOT LIMITED TO, THE IMPLIED WARRANTIES OF MERCHANTABILITY AND FITNESS FOR A PARTICULAR PURPOSE ARE DISCLAIMED. IN NO EVENT SHALL THE REGENTS OR CONTRIBUTORS BE LIABLE FOR ANY DIRECT, INDIRECT, INCIDENTAL, SPECIAL, EXEMPLARY, OR CONSEQUENTIAL DAMAGES (INCLUDING, BUT NOT LIMITED TO, PROCUREMENT OF SUBSTITUTE GOODS OR SERVICES; LOSS OF USE, DATA, OR PROFITS; OR BUSINESS INTERRUPTION) HOWEVER CAUSED AND ON ANY THEORY OF LIABILITY, WHETHER IN CONTRACT, STRICT LIABILITY, OR TORT (INCLUDING NEGLIGENCE OR OTHERWISE) ARISING IN ANY WAY OUT OF THE USE OF THIS SOFTWARE, EVEN IF ADVISED OF THE POSSIBILITY OF SUCH DAMAGE.

=====

@(#)queue.h 8.5 (Berkeley) 8/20/94

=====

This software contains source code (src/units.{c,h}) that is:

\*-----

\* Copyright (c) 1999,2000,2001,2002,2003 The Board of Trustees of the University of Illinois All Rights Reserved.

\*-----

\* Permission is hereby granted, free of charge, to any person obtaining a copy of this software (lperf) and associated documentation files (the "Software"), to deal in the Software without restriction, including without limitation the rights to use, copy, modify, merge, publish, distribute, sublicense, and/or sell copies of the Software, and to permit persons to whom the Software is furnished to do so, subject to the following conditions:

- \* Redistributions of source code must retain the above copyright notice, this list of conditions and the following disclaimers.
- \* Redistributions in binary form must reproduce the above copyright notice, this list of conditions and the following disclaimers in the documentation and/or other materials provided with the distribution.
- \* Neither the names of the University of Illinois, NCSA, nor the names of its contributors may be used to endorse or promote products derived from this Software without specific prior written permission.

\* THE SOFTWARE IS PROVIDED "AS IS", WITHOUT WARRANTY OF ANY KIND, EXPRESS OR IMPLIED, INCLUDING BUT NOT LIMITED TO THE WARRANTIES OF MERCHANTABILITY, FITNESS FOR A PARTICULAR PURPOSE AND NONINFRINGEMENT. IN NO EVENT SHALL THE

## Copyright Information

CONTRIBUTORS OR COPYRIGHT HOLDERS BE LIABLE FOR ANY CLAIM, DAMAGES OR OTHER LIABILITY, WHETHER IN AN ACTION OF CONTRACT, TORT OR OTHERWISE, ARISING FROM, OUT OF OR IN CONNECTION WITH THE SOFTWARE OR THE USE OR OTHER DEALINGS IN THE SOFTWARE.

\* National Laboratory for Applied Network Research National Center for Supercomputing Applications University of Illinois at Urbana-Champaign <http://www.ncsa.uiuc.edu>

=====

This software contains source code (`src/portable_endian.h`) that is: "License": Public Domain // I, Mathias Panzenböck, place this file hereby into the public domain. Use it at your own risk for whatever you like.

=====

\* lwIP; version not declared -- <http://savannah.nongnu.org/projects/lwip/> Copyright (c) 2001-2004 Swedish Institute of Computer Science. All rights reserved. Redistribution and use in source and binary forms, with or without modification, are permitted provided that the following conditions are met:

1. Redistributions of source code must retain the above copyright notice, this list of conditions and the following disclaimer.
2. Redistributions in binary form must reproduce the above copyright notice, this list of conditions and the following disclaimer in the documentation and/or other materials provided with the distribution.
3. The name of the author may not be used to endorse or promote products derived from this software without specific prior written permission.

THIS SOFTWARE IS PROVIDED BY THE AUTHOR ``AS IS AND ANY EXPRESS OR IMPLIED WARRANTIES, INCLUDING, BUT NOT LIMITED TO, THE IMPLIED WARRANTIES OF MERCHANTABILITY AND FITNESS FOR A PARTICULAR PURPOSE ARE DISCLAIMED. IN NO EVENT SHALL THE AUTHOR BE LIABLE FOR ANY DIRECT, INDIRECT, INCIDENTAL, SPECIAL, EXEMPLARY, OR CONSEQUENTIAL DAMAGES (INCLUDING, BUT NOT LIMITED TO, PROCUREMENT OF SUBSTITUTE GOODS OR SERVICES; LOSS OF USE, DATA, OR PROFITS; OR BUSINESS INTERRUPTION) HOWEVER CAUSED AND ON ANY THEORY OF LIABILITY, WHETHER IN CONTRACT, STRICT LIABILITY, OR TORT (INCLUDING NEGLIGENCE OR OTHERWISE) ARISING IN ANY WAY OUT OF THE USE OF THIS SOFTWARE, EVEN IF ADVISED OF THE POSSIBILITY OF SUCH DAMAGE.

-----  
\* Protobuf; version 3.1.0 -- <https://developers.google.com/protocol-buffers/> Copyright 2008 Google Inc. All rights reserved.

Redistribution and use in source and binary forms, with or without modification, are permitted provided that the following conditions are met:

- \* Redistributions of source code must retain the above copyright notice, this list of condition and the following disclaimer.
- \* Redistributions in binary form must reproduce the above copyright notice, this list of conditions and the following disclaimer in the documentation and/or other materials provided with the distribution.
- \* Neither the name of Google Inc. nor the names of its contributors may be used to endorse or promote products derived from this software without specific prior written permission.

THIS SOFTWARE IS PROVIDED BY THE COPYRIGHT HOLDERS AND CONTRIBUTORS "AS IS" AND ANY EXPRESS OR IMPLIED WARRANTIES, INCLUDING, BUT NOT LIMITED TO, THE IMPLIED WARRANTIES OF MERCHANTABILITY AND FITNESS FOR A PARTICULAR PURPOSE ARE DISCLAIMED. IN NO EVENT SHALL THE COPYRIGHT OWNER OR CONTRIBUTORS BE LIABLE FOR ANY DIRECT, INDIRECT, INCIDENTAL, SPECIAL, EXEMPLARY, OR CONSEQUENTIAL DAMAGES (INCLUDING, BUT NOT LIMITED TO, PROCUREMENT OF SUBSTITUTE GOODS OR SERVICES; LOSS OF USE, DATA, OR PROFITS; OR BUSINESS INTERRUPTION) HOWEVER CAUSED AND ON ANY THEORY OF LIABILITY, WHETHER IN CONTRACT, STRICT LIABILITY, OR TORT (INCLUDING NEGLIGENCE OR OTHERWISE) ARISING IN ANY WAY OUT OF THE USE OF THIS SOFTWARE, EVEN IF ADVISED OF THE POSSIBILITY OF SUCH DAMAGE.

Code generated by the Protocol Buffer compiler is owned by the owner of the input file used when generating it. This code is not standalone and requires a support library to be linked with it. This support library is itself covered by the above license.

-----

\* Eclipse Paho; version not declared --<http://repo.maven.apache.org/maven2/org/eclipse/paho/java-parent/>

Copyright (c) 2007, Eclipse Foundation, Inc. and its licensors.

Redistribution and use in source and binary forms, with or without modification, are permitted provided that the following conditions are met:

Redistributions of source code must retain the above copyright notice, thi list of conditions and the following disclaimer.

## Copyright Information

Redistributions in binary form must reproduce the above copyright notice, this list of conditions and the following disclaimer in the documentation and/or other materials provided with the distribution. Neither the name of the Eclipse Foundation, Inc. nor the names of its contributors may be used to endorse or promote products derived from this software without specific prior written permission. THIS SOFTWARE IS PROVIDED BY THE COPYRIGHT HOLDERS AND CONTRIBUTORS "AS IS" AND ANY EXPRESS OR IMPLIED WARRANTIES, INCLUDING, BUT NOT LIMITED TO, THE IMPLIED WARRANTIES OF MERCHANTABILITY AND FITNESS FOR A PARTICULAR PURPOSE ARE DISCLAIMED. IN NO EVENT SHALL THE COPYRIGHT OWNER OR CONTRIBUTORS BE LIABLE FOR ANY DIRECT, INDIRECT, INCIDENTAL, SPECIAL, EXEMPLARY, OR CONSEQUENTIAL DAMAGES (INCLUDING, BUT NOT LIMITED TO, PROCUREMENT OF SUBSTITUTE GOODS OR SERVICES; LOSS OF USE, DATA, OR PROFITS; OR BUSINESS INTERRUPTION) HOWEVER CAUSED AND ON ANY THEORY OF LIABILITY, WHETHER IN CONTRACT, STRICT LIABILITY, OR TORT (INCLUDING NEGLIGENCE OR OTHERWISE) ARISING IN ANY WAY OUT OF THE USE OF THIS SOFTWARE, EVEN IF ADVISED OF THE POSSIBILITY OF SUCH DAMAGE.

\*\* Kiss FFT; version not declared -- <http://sourceforge.net/projects/kissfft/> Copyright (c) 2003-2010 Mark Borgerding All rights reserved. Redistribution and use in source and binary forms, with or without modification, are permitted provided that the following conditions are met:

\* Redistributions of source code must retain the above copyright notice, this list of conditions and the following disclaimer.

\* Redistributions in binary form must reproduce the above copyright notice, this list of conditions and the following disclaimer in the documentation and/or other materials provided with the distribution.

\* Neither the author nor the names of any contributors may be used to endorse or promote products derived from this software without specific prior written permission.

THIS SOFTWARE IS PROVIDED BY THE COPYRIGHT HOLDERS AND CONTRIBUTORS "AS IS" AND ANY EXPRESS OR IMPLIED WARRANTIES, INCLUDING, BUT NOT LIMITED TO, THE IMPLIED WARRANTIES OF MERCHANTABILITY AND FITNESS FOR A PARTICULAR PURPOSE ARE DISCLAIMED. IN NO EVENT SHALL THE COPYRIGHT OWNER OR CONTRIBUTORS BE LIABLE FOR ANY DIRECT, INDIRECT, INCIDENTAL, SPECIAL, EXEMPLARY, OR CONSEQUENTIAL DAMAGES (INCLUDING, BUT NOT LIMITED TO, PROCUREMENT OF SUBSTITUTE GOODS OR SERVICES; LOSS OF USE, DATA, OR PROFITS; OR BUSINESS INTERRUPTION) HOWEVER CAUSED AND ON ANY THEORY OF LIABILITY, WHETHER IN CONTRACT, STRICT LIABILITY, OR TORT (INCLUDING NEGLIGENCE OR OTHERWISE) ARISING IN ANY WAY OUT OF THE USE OF THIS SOFTWARE, EVEN IF ADVISED OF THE POSSIBILITY OF SUCH DAMAGE.

-----  
\* Xmodem; version not declared -- <https://www.menie.org/georges/embedded/> Copyright 1979, 1980, 1983, 1986, 1988, 1989, 1991, 1992, 1993, 1994 The Regents of the University of California. All rights reserved.

Redistribution and use in source and binary forms, with or without modification, are permitted provided that the following conditions are met:

Redistributions of source code must retain the above copyright notice, this list of conditions and the following disclaimer.

Redistributions in binary form must reproduce the above copyright notice, this list of conditions and the following disclaimer in the documentation and/or other materials provided with the distribution. All advertising materials mentioning features or use of this software must display the following acknowledgement:

This product includes software developed by the University of California, Berkeley and its contributors.

Neither the name of the University nor the names of its contributors may be used to endorse or promote products derived from this software without specific prior written permission.

THIS SOFTWARE IS PROVIDED BY THE REGENTS AND CONTRIBUTORS "AS IS" AND ANY EXPRESS OR IMPLIED WARRANTIES, INCLUDING, BUT NOT LIMITED TO, THE IMPLIED WARRANTIES OF MERCHANTABILITY AND FITNESS FOR A PARTICULAR PURPOSE ARE DISCLAIMED. IN NO EVENT SHALL THE REGENTS OR CONTRIBUTORS BE LIABLE FOR ANY DIRECT, INDIRECT, INCIDENTAL, SPECIAL, EXEMPLARY, OR CONSEQUENTIAL DAMAGES (INCLUDING, BUT NOT LIMITED TO, PROCUREMENT OF SUBSTITUTE GOODS OR SERVICES; LOSS OF USE, DATA, OR PROFITS; OR BUSINESS INTERRUPTION) HOWEVER CAUSED AND ON ANY THEORY OF LIABILITY, WHETHER IN CONTRACT, STRICT LIABILITY, OR TORT (INCLUDING NEGLIGENCE OR OTHERWISE) ARISING IN ANY WAY OUT OF THE USE OF THIS SOFTWARE, EVEN IF ADVISED OF THE POSSIBILITY OF SUCH DAMAGE.

\* WPA supplicant; version not declared -- [http://hostap.epitest.fi/wpa\\_supplicant/](http://hostap.epitest.fi/wpa_supplicant/) Copyright (c) 2003-2017, Jouni Malinen <j@w1.fi> and contributors

This software may be distributed, used, and modified under the terms of BSD license:

Redistribution and use in source and binary forms, with or without modification, are permitted provided that the following conditions are met:



# Copyright Information

1. Redistributions of source code must retain the above copyright notice, this list of conditions and the following disclaimer.
2. Redistributions in binary form must reproduce the above copyright notice, this list of conditions and the following disclaimer in the documentation and/or other materials provided with the distribution.
3. Neither the name(s) of the above-listed copyright holder(s) nor the names of its contributors may be used to endorse or promote products derived from this software without specific prior written permission.

THIS SOFTWARE IS PROVIDED BY THE COPYRIGHT HOLDERS AND CONTRIBUTORS "AS IS" AND ANY EXPRESS OR IMPLIED WARRANTIES, INCLUDING, BUT NOT LIMITED TO, THE IMPLIED WARRANTIES OF MERCHANTABILITY AND FITNESS FOR A PARTICULAR PURPOSE ARE DISCLAIMED. IN NO EVENT SHALL THE COPYRIGHT OWNER OR CONTRIBUTORS BE LIABLE FOR ANY DIRECT, INDIRECT, INCIDENTAL, SPECIAL, EXEMPLARY, OR CONSEQUENTIAL DAMAGES (INCLUDING, BUT NOT LIMITED TO, PROCUREMENT OF SUBSTITUTE GOODS OR SERVICES; LOSS OF USE, DATA, OR PROFITS; OR BUSINESS INTERRUPTION) HOWEVER CAUSED AND ON ANY THEORY OF LIABILITY, WHETHER IN CONTRACT, STRICT LIABILITY, OR TORT (INCLUDING NEGLIGENCE OR OTHERWISE) ARISING IN ANY WAY OUT OF THE USE OF THIS SOFTWARE, EVEN IF ADVISED OF THE POSSIBILITY OF SUCH DAMAGE.

\* CMSIS; version not declared -- <https://github.com/ARM-software/CMSIS> Copyright (C) 2009-2014 ARM Limited.

Redistribution and use in source and binary forms, with or without modification, are permitted provided that the following conditions are met:

- Redistributions of source code must retain the above copyright notice, this list of conditions and the following disclaimer.
- Redistributions in binary form must reproduce the above copyright notice, this list of conditions and the following disclaimer in the documentation and/or other materials provided with the distribution.
- Neither the name of ARM nor the names of its contributors may be used to endorse or promote products derived from this software without specific prior written permission.

THIS SOFTWARE IS PROVIDED BY THE COPYRIGHT HOLDERS AND CONTRIBUTORS "AS IS" AND ANY EXPRESS OR IMPLIED WARRANTIES, INCLUDING, BUT NOT LIMITED TO, THE IMPLIED WARRANTIES OF MERCHANTABILITY AND FITNESS FOR A PARTICULAR PURPOSE ARE DISCLAIMED. IN NO EVENT SHALL COPYRIGHT HOLDERS AND CONTRIBUTORS BE LIABLE FOR ANY DIRECT, INDIRECT, INCIDENTAL, SPECIAL, EXEMPLARY, OR CONSEQUENTIAL DAMAGES (INCLUDING, BUT NOT LIMITED TO, PROCUREMENT OF SUBSTITUTE GOODS OR SERVICES; LOSS OF USE, DATA, OR PROFITS; OR BUSINESS INTERRUPTION) HOWEVER CAUSED AND ON ANY THEORY OF LIABILITY, WHETHER IN CONTRACT, STRICT LIABILITY, OR TORT (INCLUDING NEGLIGENCE OR OTHERWISE) ARISING IN ANY WAY OUT OF THE USE OF THIS SOFTWARE, EVEN IF ADVISED OF THE POSSIBILITY OF SUCH DAMAGE.

\* Cexception; version not declared --<https://github.com/ThrowTheSwitch/Cexception> Copyright (c) 2007-2017 Mark VanderVoord

This software is licensed under the MIT License

Permission is hereby granted, free of charge, to any person obtaining a copy of this software and associated documentation files (the "Software"), to deal in the Software without restriction, including without limitation the rights to use, copy, modify, merge, publish, distribute, sublicense, and/or sell copies of the Software, and to permit persons to whom the Software is furnished to do so, subject to the following conditions:

The above copyright notice and this permission notice shall be included in all copies or substantial portions of the Software.

THE SOFTWARE IS PROVIDED "AS IS", WITHOUT WARRANTY OF ANY KIND, EXPRESS OR IMPLIED, INCLUDING BUT NOT LIMITED TO THE WARRANTIES OF MERCHANTABILITY, FITNESS FOR A PARTICULAR PURPOSE AND NONINFRINGEMENT. IN NO EVENT SHALL THE AUTHORS OR COPYRIGHT HOLDERS BE LIABLE FOR ANY CLAIM, DAMAGES OR OTHER LIABILITY, WHETHER IN AN ACTION OF CONTRACT, TORT OR OTHERWISE, ARISING FROM, OUT OF OR IN CONNECTION WITH THE SOFTWARE OR THE USE OR OTHER DEALINGS IN THE SOFTWARE.

\* Fake function framework; version not declared --<https://github.com/meekrosoft/fff> Copyright (c) 2010 Michael Long

The MIT License (MIT)

Permission is hereby granted, free of charge, to any person obtaining a copy of this software and associated documentation files (the "Software"), to deal in the Software without restriction, including without limitation the rights to use, copy, modify, merge, publish, distribute, sublicense, and/or sell copies of the Software, and to permit persons to whom the Software is furnished to do so, subject to the following conditions:

The above copyright notice and this permission notice shall be included in all copies or substantial portions of the Software.

THE SOFTWARE IS PROVIDED "AS IS", WITHOUT WARRANTY OF ANY KIND, EXPRESS OR IMPLIED, INCLUDING BUT NOT LIMITED TO THE WARRANTIES OF MERCHANTABILITY, FITNESS FOR A PARTICULAR PURPOSE AND NONINFRINGEMENT. IN NO EVENT SHALL THE AUTHORS OR COPYRIGHT HOLDERS BE LIABLE FOR ANY CLAIM, DAMAGES OR OTHER LIABILITY, WHETHER IN AN ACTION OF CONTRACT, TORT OR OTHERWISE, ARISING FROM, OUT OF OR IN CONNECTION WITH THE SOFTWARE OR THE USE OR OTHER DEALINGS IN THE SOFTWARE.

\* cJSON; version 1.7.7 -- <https://github.com/DaveGamble/cJSON> Copyright (c) 2009-2017 Dave Gamble and cJSON contributors etl; version 11.8.0 -- <http://www.etlcpp.com>

Copyright (c) 2016 jwellbelove FreeRTOS Modifications; version not declared -- <https://www.mediatek.com/> Copyright (C) 2014-2018 MediaTek Inc. All rights reserved.

\* http-parser; version not declared -- <https://github.com/nodejs/http-parser> Copyright Joyent, Inc. and other Node contributors.

\* JSMN; version not declared -- <https://zserge.com/jsmn.html> ©2012–2018 · Serge Zaitsev · [zaitsev.serge@gmail.com](mailto:zaitsev.serge@gmail.com)

# Copyright Information

\* nghttp2; version not declared -- <https://github.com/nghttp2/nghttp2> Copyright (c) 2012, 2014, 2015, 2016 Tatsuhiro Tsujikawa  
Copyright (c) 2012, 2014, 2015, 2016 nghttp2 contributors

\* Pycrc; version not declared -- <https://pycrc.org/> Copyright (c) 2006-2015, Thomas Pircher <tehpeh-pycrc@tty1.net>

\* Unity; version not declared -- <https://throwtheswitch.org>

Copyright (c) 2007 - 2017 Unity Project by Mike Karlesky, Mark VanderVoord, and Greg Williams

Permission is hereby granted, free of charge, to any person obtaining a copy of this software and associated documentation files (the "Software"), to deal in the Software without restriction, including without limitation the rights to use, copy, modify, merge, publish, distribute, sublicense, and/or sell copies of the Software, and to permit persons to whom the Software is furnished to do so, subject to the following conditions:

The above copyright notice and this permission notice shall be included in all copies or substantial portions of the Software.

THE SOFTWARE IS PROVIDED "AS IS", WITHOUT WARRANTY OF ANY KIND, EXPRESS OR IMPLIED, INCLUDING BUT NOT LIMITED TO THE WARRANTIES OF MERCHANTABILITY, FITNESS FOR A PARTICULAR PURPOSE AND NONINFRINGEMENT. IN NO EVENT SHALL THE AUTHORS OR COPYRIGHT HOLDERS BE LIABLE FOR ANY CLAIM, DAMAGES OR OTHER LIABILITY, WHETHER IN AN ACTION OF CONTRACT, TORT OR OTHERWISE, ARISING FROM, OUT OF OR IN CONNECTION WITH THE SOFTWARE OR THE USE OR OTHER DEALINGS IN THE SOFTWARE.

\* NanoPB; version 0.3.9 -- <https://github.com/nanopb/nanopb> Copyright (c) 2011 Petteri Aimonen <jpa at nanopb.mail.kapsi.fi>

This software is provided 'as-is', without any express or implied warranty. In no event will the authors be held liable for any damages arising from the use of this software.

Permission is granted to anyone to use this software for any purpose, including commercial applications, and to alter it and redistribute it freely, subject to the following restrictions:

1. The origin of this software must not be misrepresented; you must not claim that you wrote the original software. If you use this software in a product, an acknowledgment in the product documentation would be appreciated but is not required.
2. Altered source versions must be plainly marked as such, and must not be misrepresented as being the original software.
3. This notice may not be removed or altered from any source distribution.

\* Ceedling; version 0.28.2 -- <https://github.com/ThrowTheSwitch/Ceedling> Copyright (c) 2007-2017 Mike Karlesky, Mark VanderVoord, Greg Williams

Permission is hereby granted, free of charge, to any person obtaining a copy of this software and associated documentation files (the "Software"), to deal in the Software without restriction, including without limitation the rights to use, copy, modify, merge, publish, distribute, sublicense, and/or sell copies of the Software, and to permit persons to whom the Software is furnished to do so, subject to the following conditions:

The above copyright notice and this permission notice shall be included in all copies or substantial portions of the Software. The end-user documentation included with the redistribution, if any, must include the following acknowledgment: "This product includes software developed for the Unity Project, by Mike Karlesky, Mark VanderVoord, and Greg Williams and other contributors", in the same place and form as other third-party acknowledgments. Alternately, this acknowledgment may appear in the software itself, in the same form and location as other such third-party acknowledgments.

THE SOFTWARE IS PROVIDED "AS IS", WITHOUT WARRANTY OF ANY KIND, EXPRESS OR IMPLIED, INCLUDING BUT NOT LIMITED TO THE WARRANTIES OF MERCHANTABILITY, FITNESS FOR A PARTICULAR PURPOSE AND NONINFRINGEMENT. IN NO EVENT SHALL THE AUTHORS OR COPYRIGHT HOLDERS BE LIABLE FOR ANY CLAIM, DAMAGES OR OTHER LIABILITY, WHETHER IN AN ACTION OF CONTRACT, TORT OR OTHERWISE, ARISING FROM, OUT OF OR IN CONNECTION WITH THE SOFTWARE OR THE USE OR OTHER DEALINGS IN THE SOFTWARE.

## NOTICE RELATING TO OPEN SOURCE SOFTWARE

The ACK Getting started guide will instruct you to retrieve and use Arduino – a third-party environments, and/or software packages at install-time or build-time ("External Dependencies") from third-party sources. There are terms and conditions that you need to agree to abide by if you choose to install the External Dependencies. If you do not agree with every term and condition associated with the External Dependencies, then you are not permitted to use the software package/environment. Provided below is a list of the External Dependencies and the applicable terms and conditions as indicated by the documentation associated with the External Dependencies as of Amazon's most recent review of such documentation.

THIS INFORMATION IS PROVIDED FOR CONVENIENCE ONLY. AMAZON DOES NOT PROMISE THAT THE LIST OR THE APPLICABLE TERMS AND CONDITIONS ARE COMPLETE, ACCURATE, OR UP-TO-DATE, AND AMAZON WILL HAVE NO LIABILITY FOR ANY INACCURACIES. YOU SHOULD CONSULT THE DOWNLOAD SITES FOR THE EXTERNAL DEPENDENCIES FOR THE MOST COMPLETE AND UP-TO-DATE LICENSING INFORMATION. YOUR USE OF THE EXTERNAL DEPENDENCIES IS AT YOUR SOLE RISK. IN NO EVENT WILL AMAZON BE LIABLE FOR ANY DAMAGES, INCLUDING WITHOUT LIMITATION ANY DIRECT, INDIRECT, CONSEQUENTIAL, SPECIAL, INCIDENTAL, OR PUNITIVE DAMAGES (INCLUDING FOR ANY LOSS OF GOODWILL, BUSINESS INTERRUPTION, LOST PROFITS OR DATA, OR COMPUTER FAILURE OR MALFUNCTION) ARISING FROM OR RELATING TO THE EXTERNAL DEPENDENCIES, HOWEVER CAUSED AND REGARDLESS OF THE THEORY OF LIABILITY, EVEN IF AMAZON HAS BEEN ADVISED OF THE POSSIBILITY OF SUCH DAMAGES. THESE LIMITATIONS AND DISCLAIMERS APPLY EXCEPT TO THE EXTENT PROHIBITED BY APPLICABLE LAW.

# Copyright Information

This sample software includes software ("Open Source Software") that is provided to you under open source licenses. In the event of a conflict between the software license in the Amazon terms of use applicable to this sample software and the open source license applicable to such Open Source Software, the open source license will prevail with respect to that Open Source Software. Please see external/ for more information.

\* Nanopb is licensed as follows:

Copyright (c) 2011 Petteri Aimonen <jpa at nanopb.mail.kapsi.fi>

This software is provided 'as-is', without any express or implied warranty. In no event will the authors be held liable for any damages arising from the use of this software.

Permission is granted to anyone to use this software for any purpose, including commercial applications, and to alter it and redistribute it freely, subject to the following restrictions:

1. The origin of this software must not be misrepresented; you must not claim that you wrote the original software. If you use this software in a product, an acknowledgment in the product documentation would be appreciated but is not required.
2. Altered source versions must be plainly marked as such, and must not be misrepresented as being the original software.
3. This notice may not be removed or altered from any source distribution.

\* Protocol Buffers is licensed as follows:

Copyright 2008 Google Inc. All rights reserved.

Redistribution and use in source and binary forms, with or without modification, are permitted provided that the following conditions are met:

- \* Redistributions of source code must retain the above copyright notice, this list of conditions and the following disclaimer.
- \* Redistributions in binary form must reproduce the above copyright notice, his list of conditions and the following disclaimer in the documentation and/or other materials provided with the distribution.
- \* Neither the name of Google Inc. nor the names of its contributors may be used to endorse or promote products derived from this software without specific prior written permission.

THIS SOFTWARE IS PROVIDED BY THE COPYRIGHT HOLDERS AND CONTRIBUTORS "AS IS" AND ANY EXPRESS OR IMPLIED WARRANTIES, INCLUDING, BUT NOT LIMITED TO, THE IMPLIED WARRANTIES OF MERCHANTABILITY AND FITNESS FOR A PARTICULAR PURPOSE ARE DISCLAIMED. IN NO EVENT SHALL THE COPYRIGHT OWNER OR CONTRIBUTORS BE LIABLE FOR ANY DIRECT, INDIRECT, INCIDENTAL, SPECIAL, EXEMPLARY, OR CONSEQUENTIAL DAMAGES (INCLUDING, BUT NOT LIMITED TO, PROCUREMENT OF SUBSTITUTE GOODS OR SERVICES; LOSS OF USE, DATA, OR PROFITS; OR BUSINESS INTERRUPTION) HOWEVER CAUSED AND ON ANY THEORY OF LIABILITY, WHETHER IN CONTRACT, STRICT LIABILITY, OR TORT (INCLUDING NEGLIGENCE OR OTHERWISE) ARISING IN ANY WAY OUT OF THE USE OF THIS SOFTWARE, EVEN IF ADVISED OF THE POSSIBILITY OF SUCH DAMAGE.

\* Unity is licensed as follows:

Copyright (c) <year> 2007-14 Mike Karlesky, Mark VanderVoord, Greg Williams

Permission is hereby granted, free of charge, to any person obtaining a copy of this software and associated documentation files (the "Software"), to deal in the Software without restriction, including without limitation the rights to use, copy, modify, merge, publish, distribute, sublicense, and/or sell copies of the Software, and to permit persons to whom the Software is furnished to do so, subject to the following conditions:

The above copyright notice and this permission notice shall be included in all copies or substantial portions of the Software.

THE SOFTWARE IS PROVIDED "AS IS", WITHOUT WARRANTY OF ANY KIND, EXPRESS OR IMPLIED, INCLUDING BUT NOT LIMITED TO THE WARRANTIES OF MERCHANTABILITY, FITNESS FOR A PARTICULAR PURPOSE AND NONINFRINGEMENT. IN NO EVENT SHALL THE AUTHORS OR COPYRIGHT HOLDERS BE LIABLE FOR ANY CLAIM, DAMAGES OR OTHER LIABILITY, WHETHER IN AN ACTION OF CONTRACT, TORT OR OTHERWISE, ARISING FROM, OUT OF OR IN CONNECTION WITH THE SOFTWARE OR THE USE OR OTHER DEALINGS IN THE SOFTWARE.

\* Code from STMicroelectronics is licensed as follows: COPYRIGHT(c) <year> STMicroelectronics

Redistribution and use in source and binary forms, with or without modification, are permitted provided that the following conditions are met:

1. Redistributions of source code must retain the above copyright notice, this list of conditions and the following disclaimer.
2. Redistributions in binary form must reproduce the above copyright notice, this list of conditions and the following disclaimer in the documentation and/or other materials provided with the distribution.
3. Neither the name of STMicroelectronics nor the names of its contributors may be used to endorse or promote products derived from this software without specific prior written permission.

THIS SOFTWARE IS PROVIDED BY THE COPYRIGHT HOLDERS AND CONTRIBUTORS "AS IS" AND ANY EXPRESS OR IMPLIED WARRANTIES, INCLUDING, BUT NOT LIMITED TO, THE IMPLIED WARRANTIES OF MERCHANTABILITY AND FITNESS FOR A PARTICULAR PURPOSE ARE DISCLAIMED. IN NO EVENT SHALL THE COPYRIGHT HOLDER OR CONTRIBUTORS BE LIABLE FOR ANY DIRECT, INDIRECT, INCIDENTAL, SPECIAL, EXEMPLARY, OR CONSEQUENTIAL DAMAGES (INCLUDING, BUT NOT LIMITED TO, PROCUREMENT OF SUBSTITUTE GOODS OR SERVICES; LOSS OF USE, DATA, OR PROFITS; OR BUSINESS INTERRUPTION) HOWEVER CAUSED AND ON ANY THEORY OF LIABILITY, WHETHER IN CONTRACT, STRICT LIABILITY, OR TORT (INCLUDING NEGLIGENCE OR OTHERWISE) ARISING IN ANY WAY OUT OF THE USE OF THIS SOFTWARE, EVEN IF ADVISED OF THE POSSIBILITY OF SUCH DAMAGE.



# Specifications

Power Source .....	120 V, 60 Hz
Power Consumption .....	12 Amps, 1,400 W
Cooking Power* .....	1,200 W
Outside Dimensions (W x H x D) .....	20 <sup>7</sup> / <sub>16</sub> " x 12 <sup>15</sup> / <sub>16</sub> " x 17 <sup>13</sup> / <sub>32</sub> " (519 mm x 329mm x 442 mm)
Oven Cavity Dimensions (W x H x D).....	13 <sup>7</sup> / <sub>8</sub> " x 10 <sup>13</sup> / <sub>32</sub> " x 16 <sup>1</sup> / <sub>16</sub> " (353 mm x 264.7mm x 407.8 mm)
Operating Frequency.....	2,450 MHz
Net Weight.....	Approx. 27.3 lbs (12.4kg)

\*IEC Test procedure

Specifications subject to change without notice.





## User's Record

The serial number of this product may be found on the back side of the oven or on the left side of the control panel. You should note the model number and the serial number of this oven in the space provided and retain this book as a permanent record of your purchase for future reference.

Model No. \_\_\_\_\_

Serial No. \_\_\_\_\_

Date of Purchase \_\_\_\_\_



**Scan this code for special instructions and features**

PN:16170000A88673