



Panasonic[®]

Owner's Manual
Convection / Broil / Microwave Oven
Household Use Only
Model No. NN-CD87KS



**PLEASE READ THESE INSTRUCTIONS CAREFULLY BEFORE USING THIS PRODUCT,
AND SAVE THIS MANUAL FOR FUTURE USE.**
Inverser le manuel pour lire les instructions en français.

Panasonic Canada Inc.
5770 Ambler Drive
Mississauga, Ontario
L4W 2T3
www.panasonic.com

F0003CD70CP
PA0220-0
Printed in China

© Panasonic Appliances Microwave Oven (Shanghai) Co., Ltd. 2020

CONTENTS

Safety Information

IMPORTANT SAFETY INSTRUCTIONS	3-5
Installation and Grounding Instructions	6
Food Preparation	7-8

Operation

Location of Controls	10
Oven Accessories	11
Control Panel	12
Display Window	13
Dial Feature	13
Cooking Modes	14
Operation	15-42
Using the Microwave for the First Time	15
Function Features	15
Demo Mode	16
Menu Action ON/OFF	16
Setting the Clock	17
Setting the Child Safety Lock	17
Airfry	18
Airfry Chart	19
Broil	20
Combo	21
Casserole Recipes	22
Convection Bake	23-24
Microwave	25
Keep Warm	26
Quick 30	26
Setting the Kitchen Timer	27
Setting a Standing Time	28
Setting a Delayed Start	29
Add Time	30
3-Stage Setting	31
Sensor Reheat (One Push Reheating)	32
Auto Defrost	33
Auto Cook (Sensor)	34-36
Popcorn	34
Auto Cook	37-41

Melt & Soften	37
Convection Bake/Combo	38-39
Beverage	40
Re-Bake Bread	41
Auto Steam Clean	42
Defrosting Tips & Techniques	43
Microwave shortcuts	44-45
Defrosting Chart	46
Reheating Chart	47
Cooking Chart	48-50
Food Characteristics	51
Cooking Techniques	52

Maintenance

Care and Cleaning of Your Microwave Oven	53
Shop Accessories	53
Before Requesting Service	54
WARRANTY	55

General Information

Cookware and Utensil Chart	9
Specifications	56
Trim Kit Information	56
User's Record	56



IMPORTANT SAFETY INSTRUCTIONS

Your safety and the safety of others are very important.



We have provided important safety messages in this manual and on your appliance. Always read and obey all safety messages.

This is the safety alert symbol. It is used to alert you to potential hazards that can kill or hurt you and others.

All safety messages will follow the safety alert symbol and either the word "DANGER", "WARNING" or "CAUTION". These words mean:

DANGER

You can be killed or seriously injured if you don't immediately follow instructions.

WARNING

You can be killed or seriously injured if you don't follow instructions.

CAUTION

You can be exposed to a potentially hazardous situation which, if not avoided, may result in minor or moderate injury.

All safety messages will tell you what the potential hazard is, tell you how to reduce the chance of injury, and tell you what can happen if the instructions are not followed.



PRECAUTIONS TO AVOID POSSIBLE EXPOSURE TO EXCESSIVE MICROWAVE ENERGY

- (a) **DO NOT** attempt to operate this oven with the door open, since open-door operation can result in harmful exposure to microwave energy. It is important not to defeat or tamper with the safety interlocks.
- (b) **DO NOT** place any object between the oven front face and the door, or allow soil or cleaner residue to accumulate on sealing surfaces.
- (c) **DO NOT** operate the oven if it is damaged. It is particularly important that the oven door close properly and that there is no damage to the:
 - (1) door (bent),
 - (2) hinges and latches (broken or loosened),
 - (3) door seals and sealing surfaces.
- (d) The oven should not be adjusted or repaired by anyone except properly qualified service personnel.

Thank you for purchasing a Panasonic Microwave Oven

Your microwave oven is a cooking appliance and you should use as much care as you use with a stove or any other cooking appliance. When using this electric appliance, basic safety precautions should be followed, including the following:

WARNING

To reduce the risk of burns, electric shock, fire, injury to persons, or exposure to excessive microwave energy:

1. Read all instructions before using this appliance.
2. Read and follow the specific "**PRECAUTIONS TO AVOID POSSIBLE EXPOSURE TO EXCESSIVE MICROWAVE ENERGY;**" above.
3. This appliance must be grounded. Connect only to a properly grounded outlet. See "**GROUNDING INSTRUCTIONS**" found on page 6.
4. As with any cooking appliance, **DO NOT** leave oven unattended while in use.
5. Install or locate this appliance only in accordance with the installation instructions found on page 6.
6. **DO NOT** cover or block any openings on this appliance.
7. **DO NOT** store this appliance outdoors. **DO NOT** use this product near water (for example, near a kitchen sink, in a wet basement, or near a swimming pool or similar locations).
8. Use this appliance only for its intended use as described in this manual. **DO NOT** use corrosive chemicals, vapors or non-food products in this appliance. This type of oven is specifically designed to heat or cook food. It is not designed for industrial or laboratory use. The use of corrosive chemicals in heating or cleaning will damage the appliance and may result in radiation leaks.



IMPORTANT SAFETY INSTRUCTIONS (continued)

9. When cleaning surfaces of the door and oven that come together on closing the door, use only mild, non-abrasive soaps or detergents applied with a sponge or soft cloth.
10. **DO NOT** allow children to use this appliance, unless closely supervised by an adult. **DO NOT** assume that because a child has mastered one cooking skill he/she can cook everything.
11. **DO NOT** operate this appliance if it has a damaged cord or plug, if it is not working properly, or if it has been damaged or dropped.
12. **DO NOT** immerse cord or plug in water.
13. Keep cord away from heated surfaces.
14. **DO NOT** let cord hang over edge of a table or counter.
15. This appliance should be serviced only by qualified service personnel. Contact the nearest authorized service center for examination, repair or adjustment.
16. Some products such as whole eggs, with or without shell, narrow neck bottles and sealed containers (for example, closed glass jars) may explode and should not be heated in this oven.
17. To reduce the risk of fire in the oven cavity:
 - (a) **DO NOT** overcook food. Carefully attend appliance when paper, plastic, or other combustible materials are placed inside the oven to facilitate cooking.
 - (b) Remove wire twist-ties from paper or plastic bags before placing bag in oven.
 - (c) **If material inside the oven ignites, keep oven door closed, turn oven off, and disconnect the power cord, or shut off power at the fuse or circuit breaker panel.**
 - (d) **DO NOT** use the cavity for storage purposes. **DO NOT leave paper products, cooking utensils or food in the cavity when not in use.**
18. **Superheated Liquids:** Liquids, such as water, coffee or tea are able to be overheated beyond the boiling point without showing evidence (or signs) of boiling. Visible bubbling is not always present when the container is removed from the microwave oven. **THIS COULD RESULT IN VERY HOT LIQUIDS SUDDENLY BOILING OVER WHEN THE CONTAINER IS DISTURBED OR A UTENSIL IS INSERTED INTO THE LIQUID.** To reduce the risk of injury to persons:
 - (a) **STIR THE LIQUID BOTH BEFORE AND HALFWAY THROUGH HEATING.**
 - (b) **DO NOT heat water and oil, or fats together. The film of oil will trap steam, and may cause a violent eruption.**
 - (c) **DO NOT** use straight-sided containers with narrow necks.
 - (d) After heating, allow the container to stand in the microwave oven for a short time before removing the container.
19. **DO NOT** cook directly on the glass tray. It can crack, and cause injury or damage to the oven.
20. Oversized foods or oversized metal utensils should not be used in a microwave/broiler oven as they may create a fire or risk of electric shock.
21. **DO NOT** clean with metal scouring pads. Pieces can burn off the pad and touch electrical parts involving a risk of electric shock.
22. **DO NOT** use paper products when appliance is operated in the broil mode.
23. **DO NOT** store any materials, other than manufacturer's recommended accessories in this oven when not in use.
24. **DO NOT** cover racks or any other part of the oven with metal foil. This will cause overheating of the oven.

Attention: Hot Surfaces



SAVE THESE INSTRUCTIONS

For proper use of your oven, read remaining safety cautions and owner's manual.



IMPORTANT SAFETY INSTRUCTIONS (continued)

WARNING

Safety Precautions

TO AVOID THE RISK OF SHOCK:

DO NOT remove top or outer panel from oven. Repairs must be done only by a qualified service person.

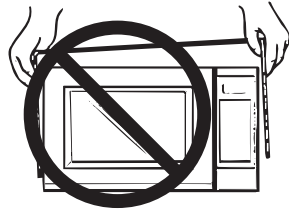

TO REDUCE THE RISK OF EXPOSURE TO MICROWAVE ENERGY:

DO NOT tamper with, or make any adjustments or repairs to Door, Control Panel Frame, Safety Interlock Switches, or any other part of the oven. Microwave leakage may result.

TO AVOID THE RISK OF ARCING DAMAGE OR FIRE:

1. **DO NOT** operate the microwave oven empty, **cook small food portions unattended**, or use metal containers. When using the microwave oven without water or food, **or cook too small a serving**, microwave energy cannot be absorbed and will continuously reflect throughout the cavity. This will cause arcing and damage the oven cavity, door or other components.

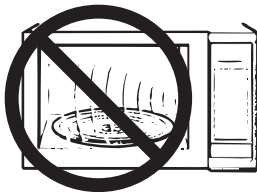

- DO NOT** store flammable materials next to, on top of, or in the oven.
- DO NOT** dry clothes, newspapers or other materials in the oven, or use newspaper or paper bags for cooking.
- DO NOT** hit or strike Control Panel. Damage to controls may occur.
- DO NOT** use recycled paper products unless the paper product is labeled as safe for microwave oven use. Recycled paper products may contain impurities, which may cause sparking.



TO AVOID THE RISK OF SCALDING AND BURNING:

POT HOLDERS should always be used when removing items from the oven. Heat is transferred from the HOT food to the cooking container and from the container to the Glass Tray. The Glass Tray can also be very HOT after removing the cooking container from the oven. The wire rack is designed for use in the Convection, Broil, Airfry and Combo modes, and will be hot after use.



Care in handling the Wire Rack, Enamel Tray and Airfry Basket must be exercised.

Glass Tray

- DO NOT** operate the oven without the Roller Ring and the Glass Tray in place.
- DO NOT** operate the oven without the Glass Tray fully engaged on the drive hub. Improper cooking or damage to the oven could result. Verify that the Glass Tray is properly engaged and rotating by observing its rotation when you press **Start**.
Note: The Glass Tray can turn in either direction.
- Use only the Glass Tray specifically designed for this oven. **DO NOT** substitute any other Glass Tray.
- If the Glass Tray is hot, allow to cool before cleaning or placing in water.
- DO NOT** cook directly on the Glass Tray. Always place food in a microwave safe dish, or on a rack set in a microwave safe dish.
- If food or utensil on the Glass Tray touches oven walls, causing the tray to stop moving, the tray will automatically rotate in the opposite direction.

Roller Ring

- The Roller Ring and oven floor should be cleaned frequently to prevent excessive noise.
- Always replace the Roller Ring and the Glass Tray in their proper positions.
- The Roller Ring must always be used for cooking along with the Glass Tray.



Installation and Grounding Instructions

Examine Your Oven

Unpack oven, remove all packing material and examine the oven for any damage such as dents, broken door latches or cracks in the door. Notify dealer immediately if oven is damaged. **DO NOT** install if oven is damaged.

Placement of Oven

- The oven must be placed on a flat, stable surface, which is more than 36 inches (91.6 cm) height from the ground. Place the front surface of the door 3 inches (7.6 cm) or more from the counter top edge to avoid accidental tipping of the microwave oven during normal use. For proper operation, the oven must have sufficient air flow. **Allow 6 inches (15 cm) of space on the top of the oven, 4 inches (10 cm) at back and 2 inches (5 cm) on both sides. If one side of the oven is placed flush to a wall, the other side or top must not be blocked. Do not remove feet.**
 - DO NOT** block air vents. If they are blocked during operation, the oven may overheat and be damaged.
 - DO NOT** place oven near a hot, damp surface such as a gas or electric range, or dishwasher.
 - DO NOT** operate oven when room humidity is excessive.
- This oven is manufactured for household use only. It is not approved or tested for mobile vehicle, marine, or commercial use.

Installation

- DO NOT** block air vents. If they are blocked during operation, the oven may overheat. If the oven overheats, a thermal safety device will turn the oven off. The oven will remain inoperable until it has cooled.
- If the oven is designed for installation into a wall cabinet, only use the proper Panasonic trim kit available from a local Panasonic dealer, or online from the Panasonic Canada eStore. Follow all instructions packed with the trim kit.
- Use of a non-Panasonic trim kit will void the Manufacturer's warranty for the Microwave oven.

WARNING: IMPROPER USE OF THE GROUNDING PLUG CAN RESULT IN A RISK OF ELECTRIC SHOCK.

Consult a qualified electrician or service person if the grounding instructions are not completely understood, or if doubt exists as to whether the appliance is properly grounded. If it is necessary to use an extension cord, use only a three-wire extension cord that has a three-prong polarized grounding plug, and a three-slot receptacle that will accept the plug of the appliance. The marked rating of the extension cord should be equal to or greater than the electrical rating of the appliance.

Grounding Instructions

THIS APPLIANCE MUST BE GROUNDED.

In the event of an electrical short circuit, grounding reduces the risk of electric shock by providing an escape wire for the electric current. This appliance is equipped with a cord having a grounding wire with a grounding plug. The plug must be plugged into an outlet that is properly installed and grounded.

- **Plug into properly installed and grounded three-prong outlet.**
- **DO NOT** remove ground prong.
- **DO NOT** use an adapter.

Power Supply

- A short power-supply cord is provided to reduce the risks resulting from becoming entangled in or tripping over a longer cord.
- Longer cord sets or extension cords may be used if care is exercised in their use. **DO NOT** let cord hang over edge of a table or counter.
- If a long cord or extension cord is used,
 - The marked electrical rating of the cord set or extension cord should be at least as great as the electrical rating of the appliance.
 - The extension cord must be a grounding-type 3-wire cord.
 - The longer cord should be arranged so that it will not drape over the counter top or tabletop where it can be pulled on by children or tripped over accidentally.

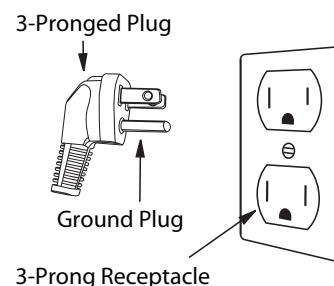

Wiring Requirements

- The oven must be operated on a SEPARATE CIRCUIT. No other appliance should share the circuit with the microwave oven. If it does, the branch circuit fuse may blow or the circuit breaker may trip.
- The oven must be plugged into at least a 15 A or 20 A, 120 V, 60 Hz GROUNDED OUTLET. **(Beginning in 2017, all new construction and all renovated single family homes must have at least a 20 A, 120 VOLT, 60 Hz GROUNDED OUTLET).** Where a standard two-prong outlet is encountered, it is the personal responsibility and obligation of the consumer to have it replaced with a properly grounded three-prong outlet.
- The VOLTAGE used must be the same as specified on this microwave oven (120 V, 60 Hz). Using a higher voltage is dangerous and may result in a fire or oven damage. Using a lower voltage will cause slow cooking. Panasonic is NOT responsible for any damages resulting from the use of the oven with any voltage other than specified.

TV / RADIO / WIRELESS EQUIPMENT INTERFERENCE

This product has been tested and found to comply with the limits for Microwave Oven. This product can radiate radio frequency energy, which could cause interference to such products as radio, TV, baby monitor, cordless phone, Bluetooth, wireless router, etc., which can be confirmed by turning this product off and on. If present, the user is encouraged to try to correct by taking one or more of the following countermeasures:

- (1) Increase the spacing distance between the microwave oven and other product receiving the interference.
- (2) If possible, use a properly installed receiver antenna and/or reorient the receiving antenna of the other product receiving the interference.
- (3) Plug the microwave oven into a different outlet from the other product receiving the interference.
- (4) Clean door and sealing surfaces of the oven. (See Care and Cleaning of Your Microwave Oven)

Fan Motor Operation

After using the oven, the fan may rotate to cool the electric components and "COOLING" appears in the display window. You can take out the food from the oven while the fan operates. It is recommended to keep the oven plugged in until the Fan Motor completely stops operating.

Note: It's normal for the door cooling fan (inside the door) to remain operating after the cooking. No "COOLING" display during this cooling period.

Food Preparation

Follow these Safety Precautions when cooking in your oven.

IMPORTANT

Proper cooking depends upon the power, the time setting and quantity of food. If you use a smaller portion than recommended but cook at the time for the recommended portion, fire could result.

1) HOME CANNING / STERILIZING / DRYING FOODS / SMALL QUANTITIES OF FOODS

- **DO NOT** use your oven for home canning. Your oven cannot maintain the food at the proper canning temperature. The food may be contaminated and then spoil.
- **DO NOT** use the microwave oven to sterilize objects (baby bottles, etc.). It is difficult to keep the oven at the high temperature needed for sterilization.
- **DO NOT** dry meats, herbs, fruits or vegetables in your oven. Small quantities of food or foods with low moisture content can dry out, scorch or catch on fire if overheated.
- **DO NOT** prepare small food portions at high power. This can cause energy concentration at a fixed spot, which can lead to arcing and damage to your oven. Select a lower cook power setting when preparing small portions.

2) POPCORN

Popcorn may be popped in a microwave oven corn popper. Microwave popcorn that pops in its own package is also available. Follow popcorn manufacturers' directions and use a brand suitable for the cooking power of your microwave oven.

CAUTION: When using pre-packaged microwave popcorn, you can follow recommended package instructions or use the Popcorn menu (refer to page 34). Otherwise, the popcorn may not pop adequately or may ignite and cause a fire. Never leave the oven unattended when popping popcorn. Allow the popcorn bag to cool before opening, and always open the bag facing away from your face and body to prevent steam burns.



3) DEEP FAT FRYING

- **DO NOT** deep fat fry in your microwave oven. Cooking oils may burst into flames and may cause damage to the oven and may result in burns. Microwave utensils may not withstand the temperature of the hot oil, and can shatter or melt.

4) FOODS WITH NONPOROUS SKINS

- **DO NOT COOK / REHEAT WHOLE EGGS, WITH OR WITHOUT THE SHELL.**

Steam buildup in whole eggs may cause them to explode, and possibly damage the oven or cause injury. Reheating SLICED hard-boiled eggs and cooking SCRAMBLED eggs is safe.



- **Potatoes, apples, whole squash and sausages** are examples of foods with nonporous skins. These types of foods must be pierced before microwave cooking to prevent them from exploding.

CAUTION: Cooking dry or old potatoes can cause fire.



5) GLASS TRAY / COOKING CONTAINERS / FOIL

- Cooking containers get hot during microwaving. Heat is transferred from the HOT food to the container and the Glass Tray. Use pot holders when removing containers from the oven or when removing lids or plastic wrap covers from cooking containers, to avoid burns.
- The Glass Tray will get hot during cooking. It should be allowed to cool before handling or before paper products, such as paper plates or microwave popcorn bags, are placed in the oven for microwave cooking.
- When using foil in the oven, allow at least 1-inch (2.5 cm) of space between foil and interior oven walls or door.
- Dishes with metallic trim should not be used, as arcing may occur.

6) PAPER TOWELS / CLOTHS

- **DO NOT** use paper towels or cloths that contain a synthetic fiber woven into them. The synthetic fiber may cause the towel to ignite. Use paper toweling under supervision.

7) BROWNING DISHES / OVEN COOKING BAGS

- Browning dishes or grills are designed for microwave cooking only. Always follow instructions provided by the manufacturer. **DO NOT** preheat browning dish more than six minutes.
- If an oven cooking bag is used for microwave cooking, prepare according to package directions. **DO NOT** use a wire twist-tie to close bag. Instead use plastic ties, cotton string or a strip cut from the open end of the bag.



Food Preparation (continued)

8) THERMOMETERS

- **DO NOT** use a conventional meat thermometer in your oven. Arcing may occur. Microwave safe thermometers are available for both meat and candy.



9) BABY FORMULA / BABY FOOD

- **DO NOT** heat baby formula or baby food in the microwave oven. The glass jar or surface of the food may appear warm while the interior can be so hot as to burn the infant's mouth and esophagus.



10) REHEATING PASTRY PRODUCTS

- When reheating pastry products, check temperatures of any fillings before eating. Some foods have fillings, which heat faster and can be extremely hot, while the surface remains warm to the touch (for example, jelly donuts).

11) GENERAL OVEN USAGE GUIDELINES

- **DO NOT** use the oven for any purpose other than the preparation of food. This oven is specifically designed to heat or cook food. **DO NOT** use this oven to heat chemicals or other non-food products.
- Before use, check that utensils/containers are suitable for use in microwave ovens.
- **DO NOT** attempt to use this microwave oven to dry newspaper, clothing or any other materials. They may catch fire.
- When the oven is not being used, **DO NOT** store any objects other than oven accessories inside the oven in case it is accidentally turned on.
- The appliance shall not be operated by Microwave or Combo **WITHOUT FOOD IN THE OVEN.**
Operation in this manner may damage the appliance.
- If smoke or a fire occurs in the oven, press the **Stop/Reset** button and leave the door closed in order to extinguish the flames. Disconnect the power cord, or shut off power at the fuse.
- Extreme caution must be used when moving hot liquids.
- When handling cooking containers take care not to let the contents spill.
- Avoid hot steam, serious burns and scalds could result.
- To prevent injury, do not allow anyone to lean, hang, sit or place heavy items on the open door of the appliance. Severe personal injury could result.
- Do not use a steam cleaner to clean this appliance. The steam from the cleaning appliance could penetrate live components and permanently damage the oven or cause injury.
- The use of accessories not recommended by Panasonic may cause injury.

12) HEATER OPERATION

- Exterior oven surfaces, including air vents on the cabinet and the oven door will get hot during Airfry, Convection, Combo or Broil functions. To prevent burns, take care when opening or closing the door and when inserting or removing food and accessories.
- The oven has heaters situated in the top of the oven. During and after using either the Airfry, Convection, Combo or Broil functions, all inside surfaces of the oven will be very hot. To prevent burns, care should be taken to avoid touching the inside surfaces of the oven.
- **TO AVOID THE RISK OF SCALDING**, please use caution when touching accessible parts when oven is operated in Convection, Combo or Broil mode, because the accessible parts may become extremely hot.

13) BEFORE USING YOUR OVEN

- Before using the oven for the first time, wipe excessive oil off in the oven cavity and operate the oven without food and accessories on Convection at 425 °F (220 °C), for 10 minutes. This will allow the oil that is **used for rust protection to be burned off. This is the only time the oven is used empty.** (with the exception of preheating on Convection.)

Cookware and Utensil Chart

	Microwave	Broil	Convection	Airfry	Combo	
					Combo 1 (Broil + Microwave)	Combo 2 (Convection + Microwave)
Aluminium foil	for shielding	yes	yes	no	for shielding	for shielding
Ceramic plate	yes	yes	yes	no	yes	yes
Browning dish	yes	no	no	no	no	no
Brown paper bags	no	no	no	no	no	no
Dinnerware oven/microwave safe	yes	yes	yes	no	yes	yes
non-oven/microwave safe	no	no	no	no	no	no
Disposable paperboard containers	yes*	yes*	yes*	no	yes*	yes*
Glassware oven glassware & ceramic	yes	yes	yes	no	yes	yes
non-heat resistant	no	no	no	no	no	no
Metal cookware	no	yes	yes	no	no	no
Metal twist-ties	no	yes	yes	no	no	no
Oven cooking bag	yes	yes*	yes*	no	yes	yes
Paper towels and napkins	yes	no	no	no	no	no
Plastic defrosting rack	yes	no	no	no	no	no
Plastic dishes microwave safe	yes	no	no	no	no	no
non microwave safe	no	no	no	no	no	no
Microwave safe plastic wrap	yes	no	no	no	no	no
Straw, wicker, wood	yes	no	no	no	no	no
Thermometers microwave safe	yes	no	no	no	no	no
conventional	no	yes	yes	no	no	no
Waxed paper	yes	yes	no	no	yes	no
Silicon bakeware	yes*	yes*	yes*	no	yes*	yes*

* Check manufacturers' recommendation, must withstand heat or follow the recipe instructions.

CONTAINER TEST

TO TEST A CONTAINER FOR SAFE MICROWAVE OVEN USE: Fill a microwave safe cup with cool water and place it in the microwave oven along side the empty container to be tested; **heat one (1) minute at 1000 W (HIGH)**. If the container is microwave oven safe (transparent to microwave energy), the empty container should remain comfortably cool and the water should be hot. If the container is hot, it has absorbed some microwave energy and should NOT be used. This test cannot be used for plastic containers.



Location of Controls

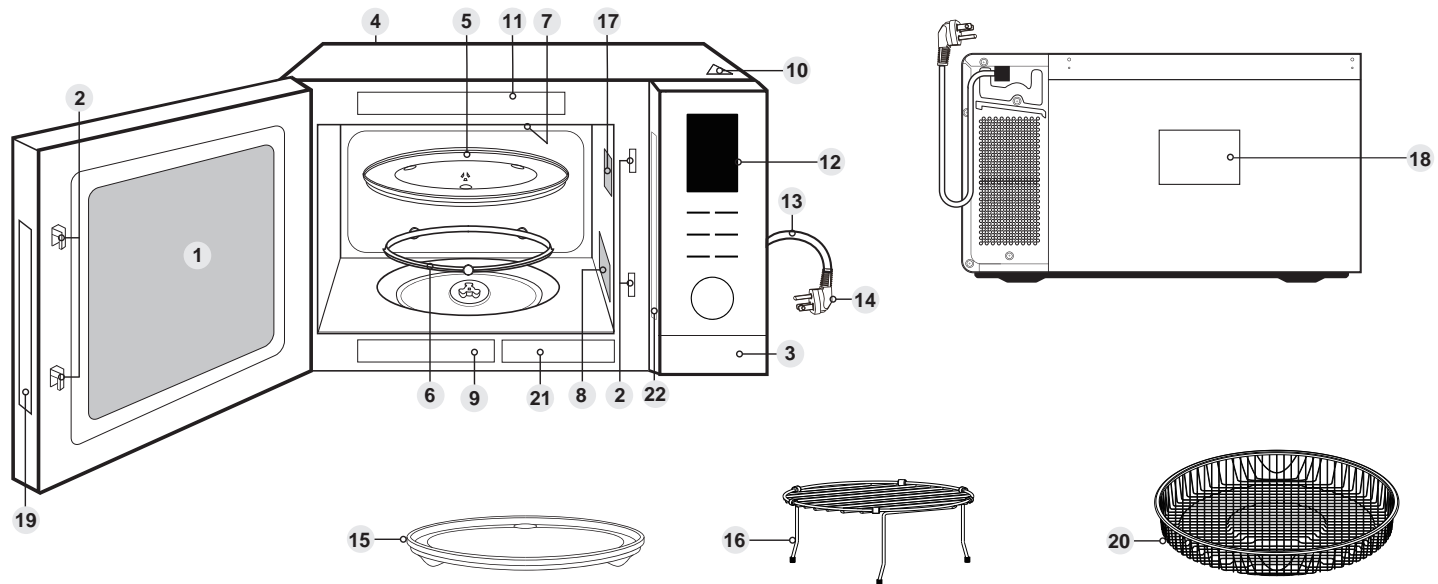

① Oven Window

② Door Safety Lock System

③ Door Release Button

Push to open the door. Opening the door during cooking will stop the cooking process without cancelling the program.

Cook resumes as soon as the door is closed and Start is pressed. It is quite safe to open the door at any time during a cooking program and there is no risk of Microwave exposure.

④ External oven air vents

⑤ Glass Tray

- DO NOT** operate the oven without the roller ring and glass tray in place.
- Only use the glass tray specifically designed for this oven. Do not substitute any other glass tray.
- If the glass tray is hot, allow to cool before cleaning or placing in water.
- DO NOT** cook directly on the glass tray. Always place food on a microwave-safe dish, or on a rack set in a microwave-safe dish.
- If food or utensil on the glass tray touches oven walls, causing the tray to stop moving, the tray will automatically rotate in the opposite direction. This is normal.
- Glass tray can rotate in either direction.
- Always place the container on the center of glass tray when cooking.

⑥ Roller Ring

- Roller ring should be cleaned regularly to avoid excessive noise.
- Roller ring and glass tray should be used at the same time.

⑦ Broil and Convection Heater

⑧ Waveguide Cover (do not remove)

⑨ Menu Label

Position your supplied menu label here.

⑩ Caution Label (hot surfaces)

⑪ Warning Label

⑫ Control Panel

⑬ Power Supply Cord

⑭ Power Supply Plug

⑮ Enamel Tray

- The enamel tray is for cooking on Airfry, Broil, Convection and Combo. Do not use enamel tray in Microwave mode only.
- The enamel tray must always be in place on the glass tray (unless stated).
- Take it out with thermal insulation gloves after use. To avoid scalding, do not touch it with your hands.

⑯ Wire Rack (with spacers)

- A wire rack is included with the oven in order to facilitate browning of small dishes.
- Wire rack should be cleaned regularly.
- When using wire rack in the manual Airfry, Broil, Convection and Combo cooking modes, be careful to choose heat-proof containers; containers made of plastic or paper may melt or burn when exposed to the heat radiating from the Broil.
- When using the Combo mode, never place any aluminum or metal container directly on wire rack. Always insert a glass plate or dish between wire rack and the aluminum container. This will prevent sparking that may damage the oven.
- Do not use wire rack when cooking in the MICROWAVE mode only.
- Spacers: Do not remove when cooking.

⑰ Oven Light

Oven Light will turn on during cooking and also when door is opened.

⑱ Warning Label

⑲ CSA Label

⑳ Airfry Basket

The Airfry Basket is for Airfry function.

The Airfry Basket must always be in place on the wire rack on Enamel tray, and glass tray (unless stated).

㉑ Function Label



㉒ Identification Plate

Notes:

- The above illustration is for reference only.
- The glass tray, wire rack, enamel tray and airfry basket are the only accessories with this oven. All other cooking utensils mentioned in this manual must be purchased separately.

Oven Accessories

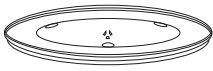
The following chart shows correct use of the accessories in the oven.

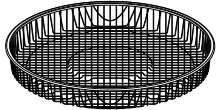
		Glass Tray	Enamel Tray	Wire Rack	Airfry Basket
Mode					
Microwave		YES	NO	NO	NO
Broil		YES	YES	YES	NO
Airfry		YES	YES	YES	YES
Convection		YES	YES	YES	NO
Combo	Combo 1 (Broil + Microwave)	YES	YES	YES	NO
	Combo 2 (Convection + Microwave)	YES	YES	YES	NO

Control Panel

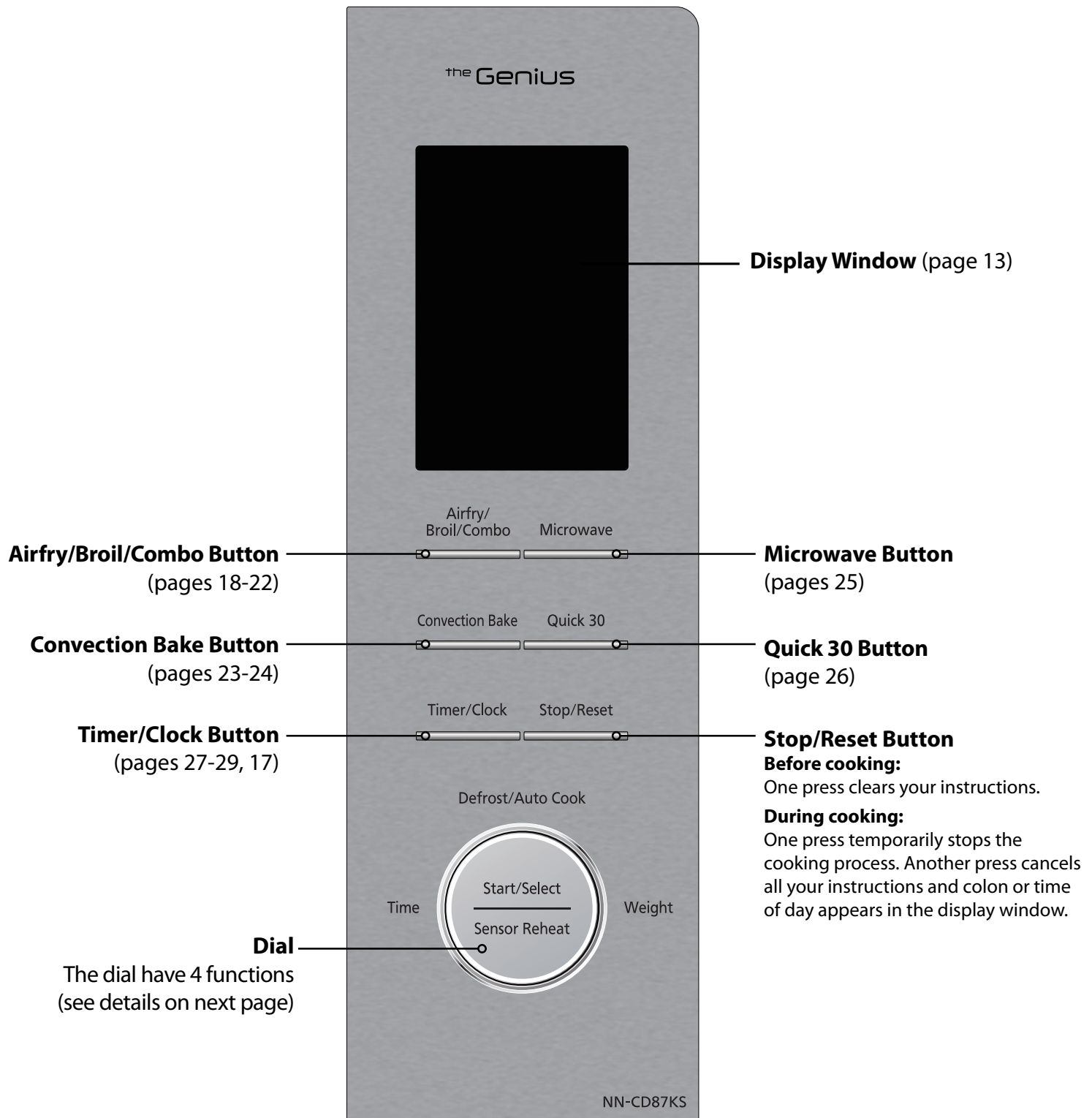

Beep Sound:

When a Button is pressed correctly, a beep sound will be heard. If a Button is pressed and no beep is heard, the unit did not or could not accept the instruction. The oven will beep twice between programmed stages. The oven will beep three times after preheating. At the end of any completed program, the oven will beep 5 times.

Note:

If an operation (except "One Push Reheating") is set and **Start** is not pressed, after 6 minutes, the oven will automatically cancel the operation. This display will revert back to clock or colon mode.

Display Window

To help you operate the oven conveniently, the present state will appear in the display window.

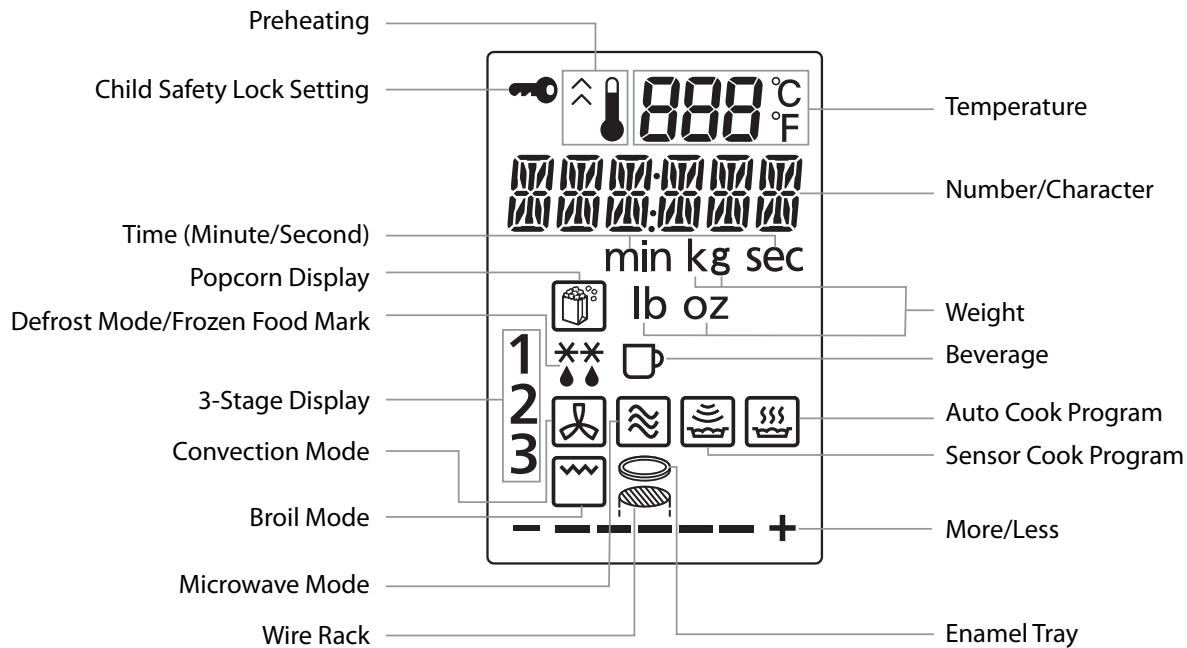

Note: When cooking time is longer than 60 minutes, the time will appear in hours and minutes.

Dial Feature

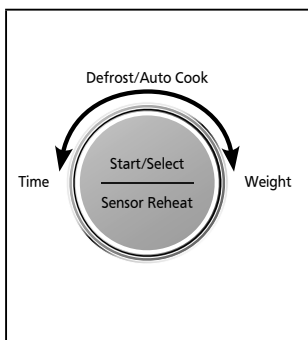

❶ Time (Cooking time)

After selecting a manual cooking mode, enter time by turning the dial. Use the dial for the Add Time function (page 30).

❷ Defrost/Auto Cook (Defrost, Auto/Sensor Cook, Steam Clean)

- When clock mode is displayed, turn the dial to select auto programs and weight (pages 33-41).
- Steam Clean: This Program is to clean the cavity and remove any food odour from the microwave oven (page 42).

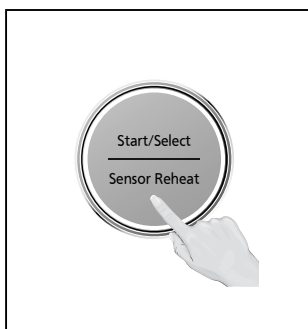

❸ Start/Select (Confirmation)

Press the dial to start operating the oven or confirm the setting. If during cooking the door is opened or Stop/Reset is pressed once, Start has to be pressed again to continue cooking.

❹ Sensor Reheat (One Push Reheating)

When Clock mode is displayed, press dial for quick start reheating chilled meal (page 32).

Cooking Modes

The diagrams shown below are examples of the accessories. It may vary depending on recipe/dish used.

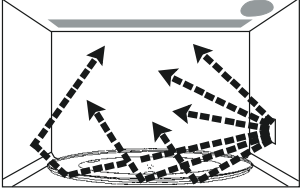
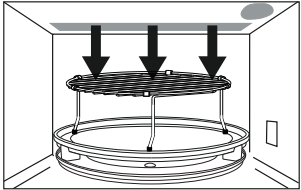
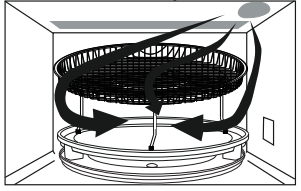
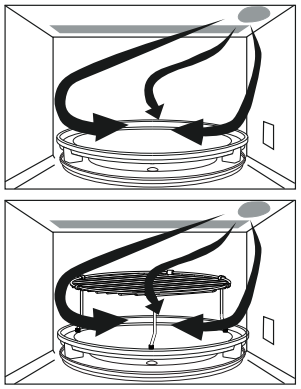
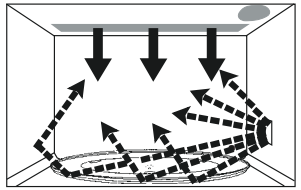
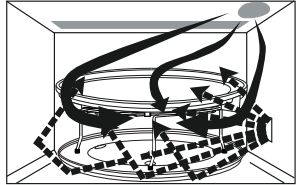
Cooking modes	Uses	Recommended accessories	Containers
<p>Microwave</p> 	<ul style="list-style-type: none"> ■ Defrosting ■ Reheating ■ Melting: butter, chocolate, cheese. ■ Cooking: fish, vegetables, fruits, eggs, rice and porridge. ■ Simmering: soup, stew, casseroles, double boiled ■ Preparing: stewed fruits, jam, sauces, custards, choux, pastry, caramel, meat, fish. ■ Keep warming cooked food. <p>No Preheating</p>	-	<p>Use your own microwaveable dishes, plates or bowls.</p> <p>No metal.</p>
<p>Broil</p> 	<ul style="list-style-type: none"> ■ Broiling of chicken pieces or seafood. ■ Toast broiling. ■ Colouring of gratin dishes, meat pie or meringue pies. <p>No Preheating</p>	Wire rack on enamel tray	Use heatproof dishes, plates or bowls.
<p>Airfry</p> 	<ul style="list-style-type: none"> ■ Baking french fries. ■ Baking steak, pork chops, hamburgers. ■ Baking frozen breaded foods. <p>No Preheating</p>	Airfry basket + wire rack + enamel tray	Put the food on the airfry basket directly.
<p>Convection</p> 	<ul style="list-style-type: none"> ■ Baking of small pastry items with short cooking times: puff, pastry, cookies, choux, short pastry, roll cakes. ■ Special roasting: steak, big joint lamb, whole chicken. ■ Baking of pizzas and tarts. <p>Preheating advised</p>	Enamel tray or Wire rack	<p>Heatproof, metal tin can be used on enamel tray.</p> <p>Do not place dishes directly on glass tray.</p>
<p>Combo 1 (Broil + Microwave)</p> 	<ul style="list-style-type: none"> ■ Cooking casserole dishes: potato casserole, seafood casserole, beef casserole. <p>No Preheating</p>	-	<p>Microwaveable casserole dishes without lids, directly on glass tray.</p> <p>No metal.</p>
<p>Combo 2 (Convection + Microwave)</p> 	<ul style="list-style-type: none"> ■ Baking frozen foods: frozen chicken nuggets, frozen pizza, frozen chicken wings. <p>No preheating</p>	Enamel tray on wire rack	<p>Put the frozen foods directly on the enamel tray on wire rack.</p> <p>No metal.</p>

Operation

Using the Microwave for the First Time

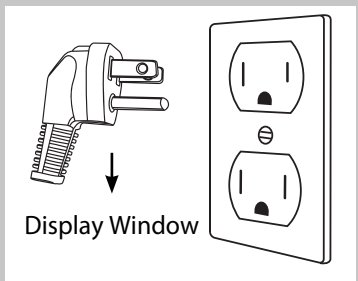

Plug into a properly grounded electrical outlet. **"WELCOME TO PANASONIC REFER TO OWNER'S MANUAL BEFORE USE"** scrolls across display window.

Function Features

This unique function of your Panasonic microwave oven allows you to establish the initial non-cooking features of your Oven.

This microwave oven has the functions below:

- **WEIGHT/TEMPERATURE UNITS CHOICE**
- **LANGUAGE CHOICE**
- **BEEP CHOICE**

Plug into a properly grounded electrical outlet.

NOTES:

1. These choices can be selected only when you plug-in the oven.
2. Press **Stop/Reset**, it will revert to initial mode (" : ").
3. After setting, it will revert back to Weight/Temperature Units Choice setting if **Start** is pressed again, press **Stop/Reset** to exit.

WEIGHT/TEMPERATURE UNITS CHOICE: The oven has a choice of Metric Units or Imperial Units display.

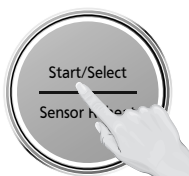
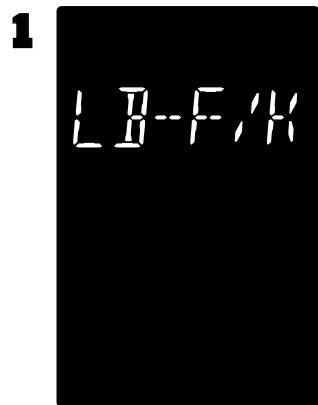

Press **Start (Dial)** once. **"LB-F/KG-C"** scrolls across display window.

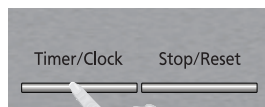

Select the **"LB-F"** or **"KG-C"** by pressing **Timer/Clock**. The default weight unit is LB-F.

3 After setting, press **Stop/Reset** to exit.

LANGUAGE CHOICE: The oven has a choice of English, French or Spanish display.

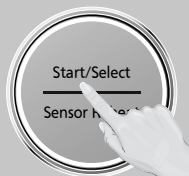

Press **Start (Dial)** twice. **"LANGUAGE"** scrolls across display window. The default language is English.

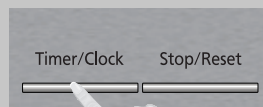

Press "Timer/Clock"	Display Language
Once	French
Twice	Spanish
3 times	English

3 After setting, press **Stop/Reset** to exit.

BEEP CHOICE: The oven has both Beep On and Beep Off mode.

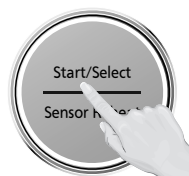

Press **Start (Dial)** 3 times. **"BEEP ON/OFF"** scrolls across display window. The default mode is Beep **ON**.

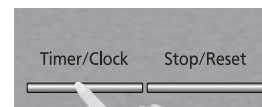

Press **Timer/Clock** once. The mode changes to Beep **OFF**.

3 After setting, press **Stop/Reset** to exit.

Operation (continued)

Demo Mode

1 When "**DEMO MODE PRESS ANY KEY**" or "**D**" appears in the display window, it means the oven is under demonstration mode, microwave does not emit. Demo mode is designed for retail store display. In this mode, the oven can be demonstrated with no cooking power in the oven.

NOTES:

1. To set Demo Mode, repeat step 1-3.
2. Default mode is Demo Mode off.

2

To cancel:

Press **Microwave** once, **Start** 4 times and **Stop/Reset** 4 times.

Step 1.

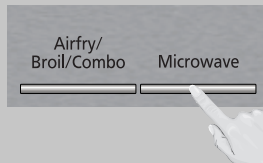

Step 2.

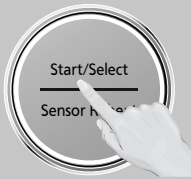

Step 3.

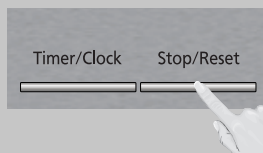

Menu Action ON/OFF

This feature helps you to program your oven by prompting the next step to be taken. When you become familiar with your oven, the prompt can be turned off. This feature can be selected when colon or clock appears in the display window.

To turn ON/OFF:



Press **Timer/Clock** 4 times to turn Menu Action ON/OFF. The default setting is **Menu Action ON**.

NOTES:

This function only can be operated when word prompt turns on.

Operation (continued)

Setting the Clock

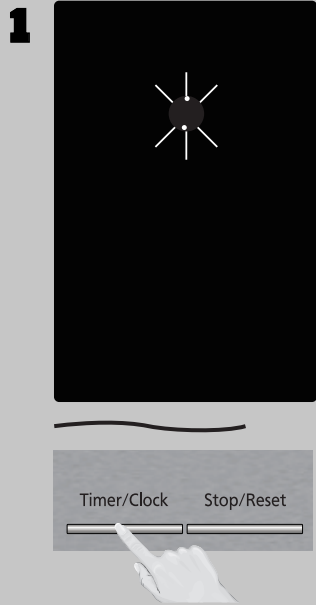

With the oven **NOT** cooking, press **Timer/Clock** twice; the colon will blink.



Press **Timer/Clock** to finish setting and the colon (:) will stop blinking.

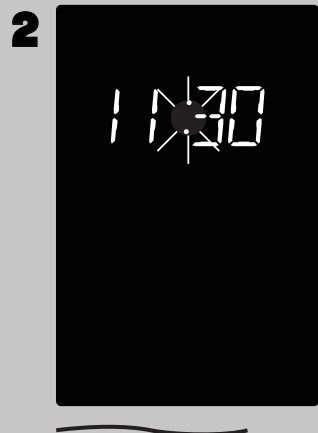

NOTES:

1. To reset the clock, repeat steps.
2. The clock will retain the time of day as long as the oven is plugged in and electricity is supplied.
3. The clock is a 12-hour display.
4. Oven will not operate while colon (:) is flashing.

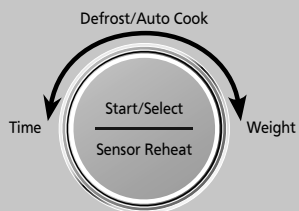

Set time of day by turning dial. Time appears in the display window; colon continues flashing.

Setting the Child Safety Lock

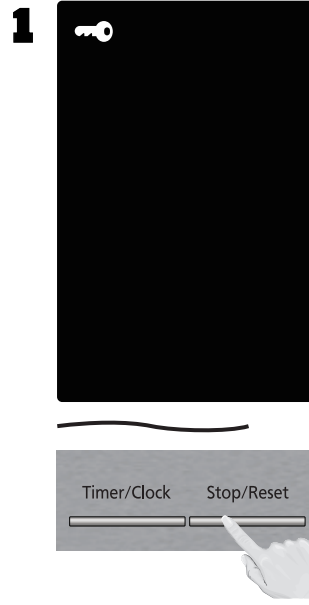

NOTES:

1. This feature prevents the electronic operation of the oven until cancelled. It does not lock the door.
2. To set or cancel Child Safety Lock, **Stop/Reset** button must be pressed 3 times within 10 seconds.
3. You can set Child Safety Lock feature when the display shows a colon or time of day.

When the colon or time of day appears in the display, press **Stop/Reset** three times; "🔑" will appear in the display.

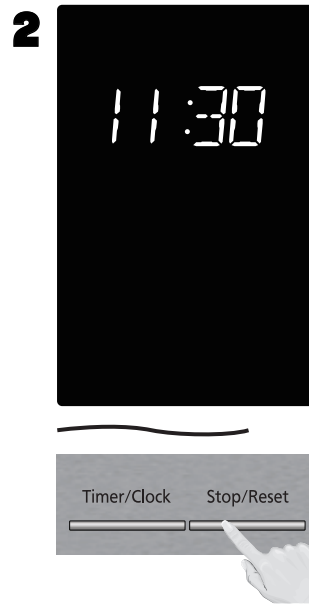

Press **Stop/Reset** three times; the display will return to the colon or time of the day and Child Safety Lock will be cancelled.

Operation (continued)

Airfry

The Airfry function combines intense heat and maximized airflow to cook food crispy and brown. No need to set temperature and preheating, turn the Dial to set the cooking time up to 9 hours after selecting Airfry function.

1

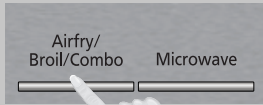

Press **Airfry/Broil/Combo** button once.

2

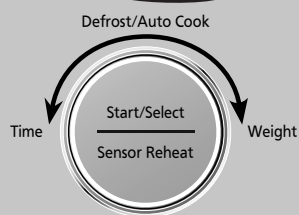
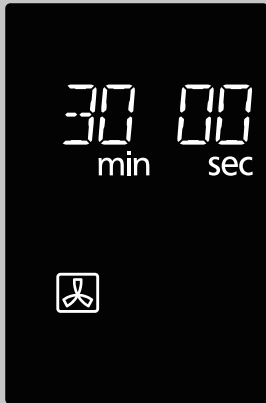

Set desired cooking time by turning dial (up to 9 hours).

3

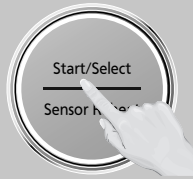
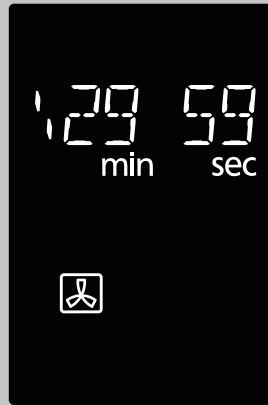

Press dial to **Start**, the cooking will start and the time will count down in the display. At the end of cooking, five beeps will sound.

Oven accessories to use

Airfry basket on wire rack on enamel tray



NOTES:

1. Ensure to use the proper accessories. Put the food on the Airfry Basket on the Wire Rack on the Enamel Tray for dripping oil. **DO NOT** remove the spacer on the Wire Rack.
2. Arrange food evenly in the Airfry Basket. For best results, place food in a single layer and leave space between pieces. For large amount of food, stir or rearrange the food several times during cooking.
3. When the selected cooking time is less than one hour, the time counts down second by second.
4. When the selected cooking time is over one hour, the time counts down minute by minute until only "1H 00" (1 hour) remains. The display then indicates minutes and seconds and counts down second by second.

CAUTION:

Food, accessories and the surrounding oven will get very hot. Use oven mitts.

Operation (continued)

Airfry Chart

Food		Weight range	Recommended time (minute)	Hints
Frozen	Thin frozen fries	8 - 16 oz. (225 - 450 g)	20-30	stir at $\frac{2}{3}$ of total time for over 16 oz. (450 g)
		16 - 32 oz. (450 - 900 g)	30-40	
	Thick frozen fries/Frozen potato steak fries/wedges	16 - 32 oz. (450 - 900 g)	25-30	stir at $\frac{2}{3}$ of total time for over 16 oz. (450 g)
	Frozen potato steak fries/wedges	16 - 32 oz. (450 - 900 g)	25-30	stir at $\frac{2}{3}$ of total time for over 16 oz. (450 g)
	Frozen cheese sticks	16 - 42 oz. (450 - 1200 g)	16-20	-
	Frozen chicken nuggets	16 - 40 oz. (450 - 1100 g)	20-30	stir at $\frac{2}{3}$ of total time for over 16 oz. (450 g)
	Frozen fish sticks	16 - 42 oz. (450 - 1200 g)	20-30	stir at $\frac{2}{3}$ of total time for over 16 oz. (450 g)
Fresh	Homemade fries	16 - 32 oz. (450 - 900 g)	30-40	soak in cold water for 1 hour in the refrigerator, dry and mix with oil, stir at $\frac{2}{3}$ of total time for over 16 oz. (450 g)
	Steak ($\frac{1}{2}$ inch of thickness)	2 - 4 pcs (12 - 24 oz.) (340 - 670 g)	16-18	seasoned, turn over at $\frac{2}{3}$ of total time
	Pork chops	2 - 6 pcs (8 - 24 oz.) (225 - 670 g)	20-30	seasoned, turn over at $\frac{2}{3}$ of total time
	Hamburger	2 - 4 pcs (10 - 20 oz.) (280 - 560 g)	16-20	seasoned, turn over at $\frac{2}{3}$ of total time
	Chicken wings	16 - 36 oz. (450 - 1000 g)	25-30	seasoned, turn over at $\frac{2}{3}$ of total time
	Drumsticks	4 - 8 pcs (16 - 42 oz.) (450 - 1200 g)	35-40	seasoned, turn over at $\frac{2}{3}$ of total time
	Chicken breast	2 - 4 pcs (12 - 24 oz.) (340 - 670 g)	25-30	seasoned, turn over at $\frac{2}{3}$ of total time
	Fish fillets	2 - 4 pcs (8 - 16 oz.) (225 - 450 g)	20-25	seasoned, less than $1\frac{1}{2}$ inch of thickness

Operation (continued)

Broil

Directions for Broiling:

There are two power levels for Broil. When broiling, heat is radiated from heater. The Broil is especially suitable for thin slices of meat and seafood as well as bread and meals. Preheating isn't required before broiling. Select Broil setting, set the time and start the oven. The food being broiled should normally be turned over after half the broiling time. When the oven door is opened, the program is interrupted. Turn the food over, place it back the oven, close the door and restart oven. While broiling, the oven door can be opened at any time to check the food.

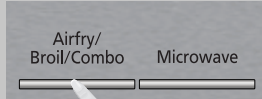

Press **Airfry/Broil/Combo** button until the desired power level appears in the display window.

Press	Power level
twice	Broil 1 (High)
3 times	Broil 2 (Low)

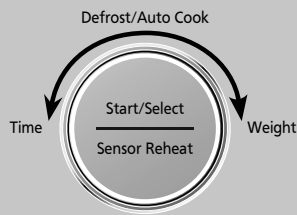
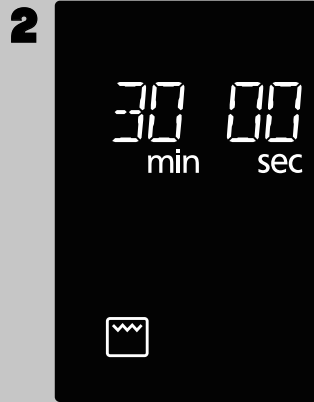

Set desired cooking time by turning dial (up to 1 hour and 30 minutes).

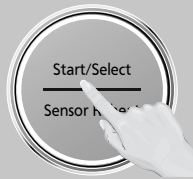
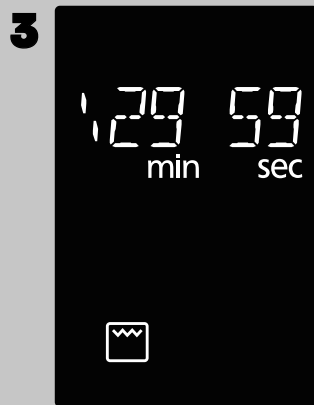

Press dial to **Start**, the cooking will start and the time will count down in the display. At the end of cooking, five beeps will sound.

Oven accessories to use

When broiling foods the glass tray should be in position, with the enamel tray and the wire rack on top.

Place food on wire rack on the enamel tray on the glass tray. The wire rack will allow fat to drip through into the enamel tray to reduce excess splatter and smoke when broiling steaks, chops and other fatty foods.

If broiling fish or small items, place the enamel tray on top of the wire rack.



Cooking Tips:

1. Most meat items e.g. sausages, chops can be cooked on the hottest setting - **Broil 1 (High)**. This setting is also suitable for toasting bread, muffins and teacakes etc.
2. **Broil 2 (Low)** used for more delicate foods or those that require a longer broil time e.g. fish or chicken portions.

NOTES:

1. There is no microwave power on the Broil only program.
2. Use the accessories provided, as explained.
3. The Broil will only operate with the oven door closed.
4. Do not preheat the broil.
5. Never cover the food when broiling.
6. After broiling it is important that the broil accessories are removed for cleaning before reuse and that the oven walls and floor are wiped with a cloth squeezed in hot soapy water to remove any grease.

CAUTION:

Food, accessories and the surrounding oven will get very hot. Use oven mitts.

Operation (continued)

Combo

1



Press **Airfry/Broil/Combo** button until the desired power level appears in the display window.

Press	Power level
4 times	Combo 1 (Casserole)
5 times	Combo 2 (Frozen foods)

2

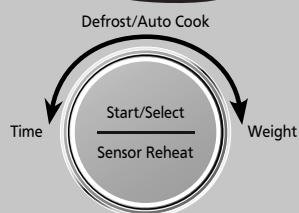
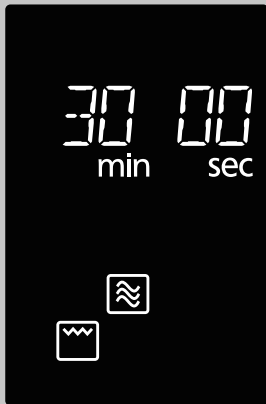

Set desired cooking time by turning dial (up to 9 hours).

3

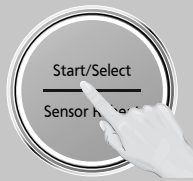
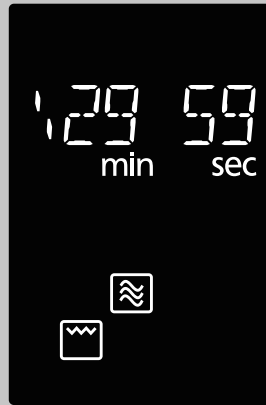

Press dial to **Start**; the cooking will start and the time will count down in the display. At the end of cooking, five beeps will sound.

CAUTION:

Food, accessories and the surrounding oven will get very hot. Use oven mitts.

Combo 1 (Casserole)

This function is suitable for cooking casserole dishes. The cooking power combines microwave and broil. Follow the recommended recipes and cooking time on the next page, use microwaveable dishes, and cook without lids. For other recipe of casserole, please set cooking time as you desired.

Recipe	Weight	Recommended time (minute)	Hints
Macaroni and Cheese	4-6 servings (3 quarts)	25-30	stir at ½ of total time
Beef and Macaroni casserole	4-6 servings (3 quarts)	35-40	stir at ½ of total time
Potato Casserole	4-6 servings (3 quarts)	35-40	stir at ½ of total time
Tuna Casserole	4-6 servings (3 quarts)	30-35	stir at ½ of total time

* See casserole recipes on next page.

Combo 2 (Frozen foods)

This function is suitable for baking frozen foods. The cooking power combines microwave and convection bake. Follow the chart as below, put the frozen foods directly on the enamel tray on the wire rack, turn over at recommended time.

For other Frozen foods, please set cooking as you desired.

Recipe	Weight	Recommended time (minute)	Hints
Chicken Wings	1.0 lb (450 g)	25-28	turn over at ² / ₃ of total time
French Fries	8 oz. (225 g)	18-20	-
Chicken Nuggets	1.0 lb (450 g)	24-28	turn over at ² / ₃ of total time
Frozen Pizza	12 inch (30 cm)	20-22	-

NOTES:

- Food is usually cooked **uncovered**.
- The wire rack and enamel tray are designed to be used for Combo and broiling. Never attempt to use any other metal accessory except the one provided with the oven. Place the enamel tray underneath to catch any fat or drips.
- Do not use plastic **microwave** containers on Combo programs. Dishes must be able to withstand the heat of the top heater. Do not put dishes on wire rack directly under the heater, use the enamel tray.
- When the selected cooking time is less than one hour, the time counts down second by second.
- When the selected cooking time is over one hour, the time counts down minute by minute until only "1H 00" (1 hour) remains. The display then indicates minutes and seconds and counts down second by second.
- To turn food just press the door release, take out the enamel tray and wire rack, turn the food, return to the oven, close the door and press dial to Start. The oven will continue to count down the remaining cooking time.
- Foods should always be cooked until browned and piping hot.
- After cooking it is important that the accessories are removed for cleaning before re-use and that the oven walls and floor are wiped with a cloth squeezed in hot soapy water to remove any grease.

Operation (continued)

Casserole Recipes

Macaroni and cheese (4-6 servings)

2½ tbsp. (40 g)	butter
1½ tbsp. (25 g)	chopped onion
½	clove minced garlic
4 tbsp. (60 g)	all-purpose flour
⅔ tsp. (2.5 g)	dry mustard
⅔ tsp. (2.5 g)	salt
to taste	ground black pepper
1½ cups (375 ml)	milk
1½ cups (300 g)	grated cheddar cheese
5 oz. (140 g)	(dry weight) macaroni, cooked and drained
3 tbsp. (45 g)	bread crumbs
⅔ tsp. (2.5 g)	paprika

In a 3-quart casserole dish, melt the butter for 20 seconds at 1000 W. Add onion and garlic, and cook for 1 minute at 1000 W. Stir in flour, mustard, salt and pepper, and gradually add the milk. Cook for 4-5 minutes at 1000 W until sauce thickens, stir once. Add the cheddar cheese and the macaroni into the sauce and stir well. Sprinkle the bread crumbs and paprika on the top of the dish. Cook uncovered at "Combo 1" for 25-30 minutes, let stand for 10 minutes.

Beef and Macaroni casserole (4-6 servings)

8 oz. (225 g)	lean ground beef
½	small onion, chopped
¼	green bell pepper, chopped
½ cup (110 g)	chopped celery
15 oz. (430 g)	can tomato sauce
⅔ cup (150 ml)	water
½ cup (110 g)	uncooked elbow macaroni
½ tsp. (2 g)	parsley
¼ tsp. (1 g)	salt
to taste	grounded black pepper
¼ cup (50 g)	grated cheddar cheese

In a 3-quart casserole dish, combine all ingredients except cheese, mix well. Put the casserole dish on the glass tray and cook uncovered at "Combo 1" for 35-40 minutes. Stir occasionally during cooking. Sprinkle with cheese. Cover and let stand 5 minutes.

Potato casserole (4-6 servings)

1½ lb. (750 g)	potatoes, peeled and sliced
½ cup (125 ml)	sour cream
½ cup (125 ml)	milk
3	green onions, finely chopped
1	small onion, thinly sliced
¼ cup (50 g)	parmesan cheese
2	bacon slices, finely chopped

In a 3-quart casserole dish, layer potatoes, sour cream and onions. Top with cheese and bacon. Pour milk on the top. Put the casserole dish on the glass tray and cook uncovered at "Combo 1" for 35-40 minutes. Stand, covered, 5-10 minutes before serving.

Tuna casserole (4-6 servings)

6½ oz. (180 g)	can tuna, drained and flaked
4 cups (1 L)	pasta, cooked and drained
10 oz. (280 g)	can condensed cream of mushroom soup
4 oz. (120 g)	can of sliced mushrooms, drained
10 oz. (280 g)	package of frozen peas, defrosted
¾ cup (175 ml)	milk
2 tbsp. (25 g)	pimento, chopped
1 cup (250 g)	crushed potato chips

In a 3-quart casserole dish, combine all ingredients except potato chips, mix well. Put the casserole dish on the glass tray and cook uncovered at "Combo 1" for 30-35 minutes. Stir occasionally during cooking. Top with potato chips. Stand, uncovered, 3-5 minutes.

Operation (continued)

Convection Bake

The oven can be used as a conventional oven using the Convection mode which incorporates a heating element with a fan. There is a choice of Convection temperatures 100 °F (40 °C) and 215 °F (100 °C) - 425 °F (220 °C). For quick selection of the most commonly used cooking temperatures, the oven starts at 300 °F (150 °C) and then for each press the temperature will count up in 18 °F (10 °C) stages to 425 °F (220 °C), then to, 100 °F (40 °C), 215 °F (100 °C), 230 °F (110 °C) etc. This feature provides 2 modes to select. For best results always place food in a preheated oven.

Press	Temperature
once	300 °F (150 °C)
twice	325 °F (160 °C)
3 times	340 °F (170 °C)
4 times	350 °F (180 °C)
5 times	375 °F (190 °C)
6 times	400 °F (200 °C)
7 times	410 °F (210 °C)
8 times	425 °F (220 °C)
9 times	100 °F (40 °C)
10 times	215 °F (100 °C)
11 times	230 °F (110 °C)
12 times	250 °F (120 °C)
13 times	270 °F (130 °C)
14 times	285 °F (140 °C)

With Preheating:

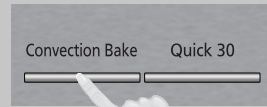
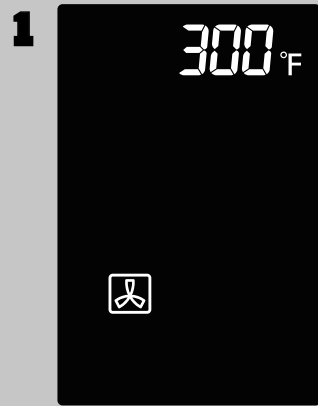

Press **Convection Bake** until the desired temperature appears in the display window.

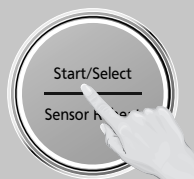
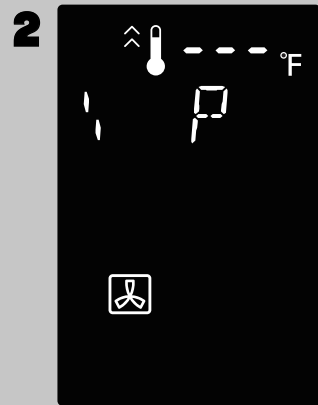

Press dial to preheat. "PREHEAT" will scroll across display window once then a "P" will appear in the display window. When preheating is completed, the oven will beep and "P END" will display in the display window.

Then open the door and place the food inside.*

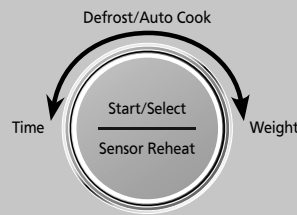

Set desired cooking time by turning dial (up to 9 hours).

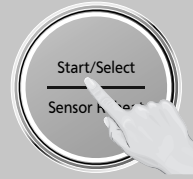

Press dial to **Start**. The cooking time appears in the display window and begins to count down.

NOTES:

- * Open the door using the door release button, because if the **Stop/Reset** button is pressed the program may be cancelled.
- When preheating, the screen displays the actual temperature of the oven cavity. The current temperature is not displayed until more than 215 °F (100 °C) is reached. To change the temperature during cooking, press the **Convection Bake** button.
- The oven will maintain the selected preheated temperature for approximately 30 minutes without the door opened. If no food has been placed inside the oven or a cooking time set, then it will beep 5 times and automatically cancel the cooking program and revert to colon or time of day.
- Once you open the door and Start is not pressed, after 6 minutes, the oven will automatically cancel the preheated program. This display will revert back to clock or colon mode.
- The oven cannot preheat to 100 °F (40 °C).

Operation (continued)

Convection Bake

Without Preheating:
(100 °F (40 °C) is available in Convection without preheating.)

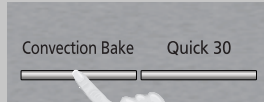
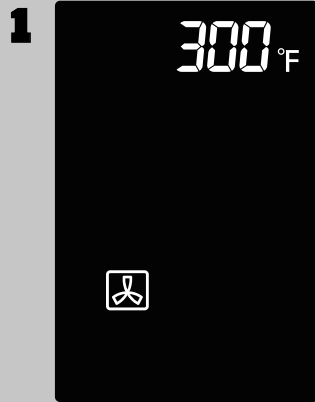

Press **Convection Bake** until the desired temperature appears in the display window.

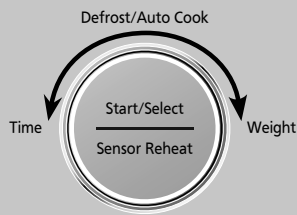

Set desired cooking time by turning dial. (up to 9 hours).

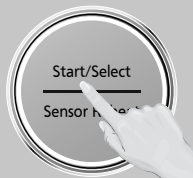
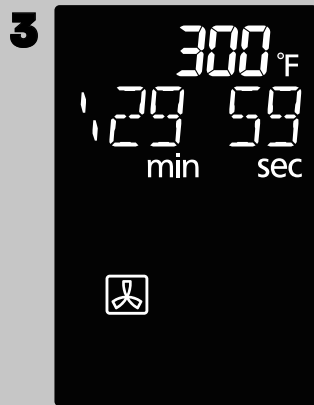

Press dial to **Start**. The cooking time appears in the display window and begins to count down.

NOTES:

1. When the selected cooking time is less than one hour, the time counts down second by second.
2. When the selected cooking time is over one hour, the time counts down minute by minute until only "1H 00" (1 hour) remains. The display then indicates minutes and seconds and counts down second by second.

Oven accessories to use

When using the Convection oven the glass tray should be in position and must have the enamel tray placed on top. The food is then placed onto the enamel tray. Follow your individual recipe guidelines. When using the oven as a Convection oven, there is **NO MICROWAVE POWER**, i.e. the oven is operating as a conventional oven and you can use all your standard metal baking tins and ovenware. It is not recommended to cook on more than one level when using the Convection oven. When cooking 2 trays of buns etc, cook in two batches.

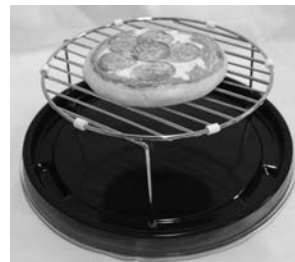

CAUTION:

Food, accessories and the surrounding oven will get very hot. Use oven mitts.

Operation (continued)

Microwave

This feature allows you to set the desired power and time to cook food. Do not place food directly on the glass tray. Use microwave safe dishes, plates or bowls covered with a lid or pierced cling film.

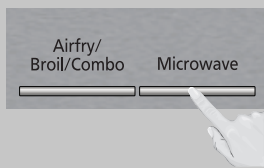

Press **Microwave** until the desired power level appears in the display. 1000 W is the highest and 100 W is the lowest.

Press	Power level
once	1000 W (HIGH)
twice	800 W (MED-HIGH)
3 times	600 W (MEDIUM)
4 times	440 W (MED-LOW)
5 times	300 W (DEFROST)
6 times	100 W (LOW)
7 times	KEEP WARM

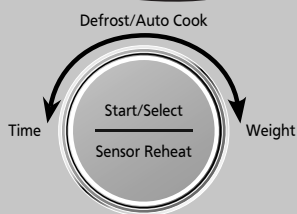
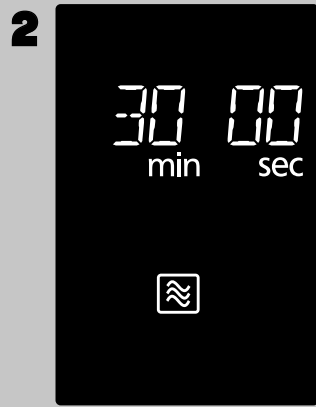

Set cooking time by turning dial. 1000 W and KEEP WARM have max. cooking time of 30 minutes. For other power levels, the max. time is 1 hour and 30 minutes.

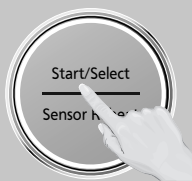
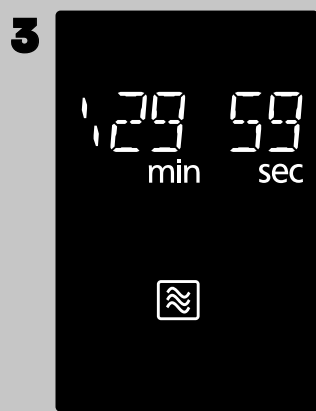

Press dial to **Start**; the cooking will start and the time will count down in the display. At the end of cooking, five beeps will sound.

NOTES:

1. Opening the door and taking out the defrosted parts during the operating time is recommended. Turn over, stir or rearrange the parts which are still in icy.
2. When the selected cooking time is less than one hour, the time counts down second by second.
3. When the selected cooking time is over one hour, the time counts down minute by minute until only "1H 00" (1 hour) remains. The display then indicates minutes and seconds and counts down second by second.

DO NOT OVERCOOK:

This oven requires less time to cook than older units. Overcooking will cause food to dry out and may cause a fire. A microwave oven's cooking power tells you the amount of microwave power available for cooking.

Caution:

DO NOT defrost food at a high power setting. Doing so can cause energy concentration at a focused point, which can lead to arcing and damage to the oven. Use the "Defrost" function instead.

Operation (continued)

Keep Warm

(Will keep "cooked" food warm for up to 30 minutes after cooking)

1

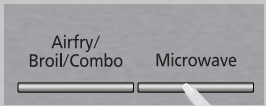

Press **Microwave** 7 times to select the KEEP WARM.

2

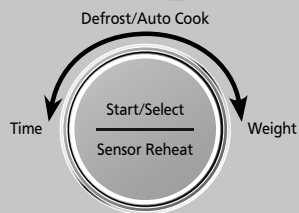
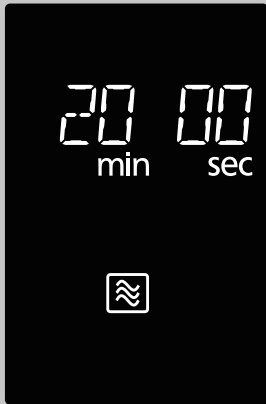

Set warming time by turning dial (up to 30 minutes). Set 20 minutes cooking for an example.

3

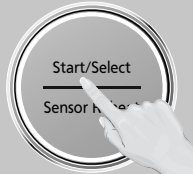
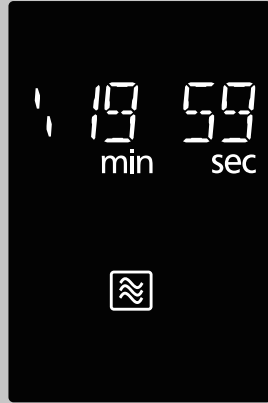

Press dial to **Start**, the cooking will start and the time will count down in the display. At the end of cooking, five beeps will sound.

NOTES:

KEEP WARM can be set as the final stage after cook time has been manually entered. It cannot be used with auto programs (such as Defrost, Sensor Reheat, Auto/Sensor Cook and Steam Clean).

Quick 30

(Set or add cooking time in 30 seconds increments)

1

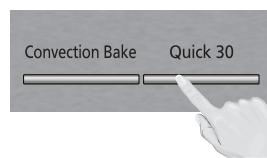
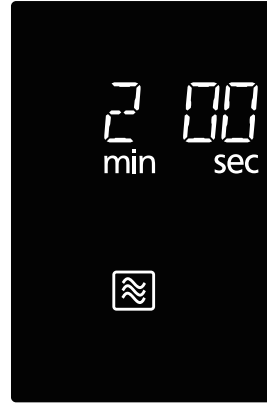

Press **Quick 30** until the desired cooking time (up to 5 minutes) appears in the display. Power level is pre-set at 1000 W.

2

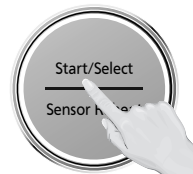
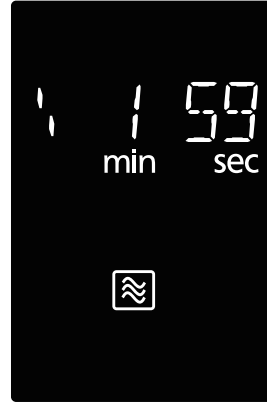

Press dial to **Start**; the cooking will start and the time will count down in the display. At the end of cooking, five beeps will sound.

NOTES:

1. If desired, you can use other power levels. Select desired power level before pressing **Quick 30**.
2. After setting the time by **Quick 30** button, you cannot use the **Dial**.
3. **Quick 30** button can also be used to add more time during manual cooking.
4. It cannot be used with auto programs (such as Defrost, Sensor Reheat, Auto/Sensor Cook and Steam Clean).

Operation (continued)

Setting the Kitchen Timer

1

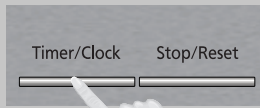

This feature allows you to program the oven as a kitchen timer. Press **Timer/Clock** once.

2

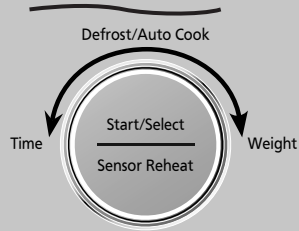
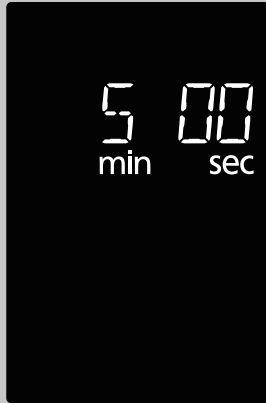

Set desired amount of kitchen time by turning dial (up to 1 hour and 30 minutes).

3

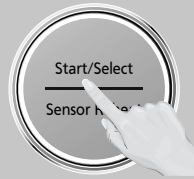
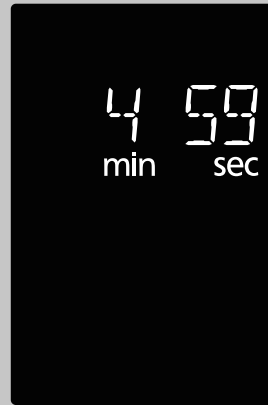

Press dial to **Start**. Time will count down without oven operating.

Caution: If oven lamp is lit while using the timer feature with door closed, the oven is **NOT** set properly; **STOP OVEN IMMEDIATELY** and re-read instructions.

NOTES:

1. If the oven door is opened during Kitchen Timer, Standing Time, Delay Start, the time in the display window will continue to count down.
2. If the time exceeds one hour, it will count down in units of minutes. If less than one hour, the time will count down in units of seconds.
3. An "H" will appear in the display to denote hours.

Operation (continued)

Setting a Standing Time



Some recipes call for a standing time after cooking. Press **Microwave** until the desired power level appears in the display. 1000 W is the highest and 100 W is the lowest.

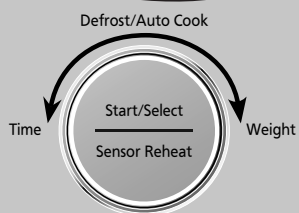
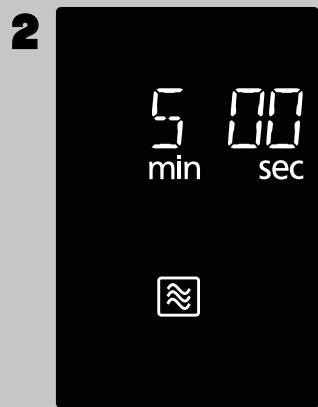

Set cooking time by turning dial (see previous page for maximum times).

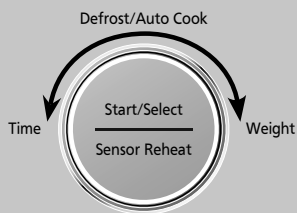
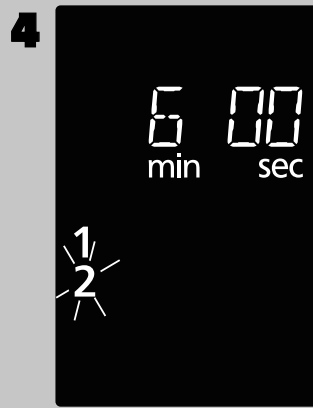

Set desired standing time by turning dial (up to 1 hour and 30 minutes).



Press dial to **Start**. Cooking will start. After cooking, standing time will count down without oven operating.

NOTES:

1. If the oven door is opened during Kitchen Timer, Standing Time, Delay Start, the time in the display window will continue to count down.
2. Standing Time and Delay Start can not be programmed together with auto programs (such as Defrost, Sensor Reheat, Auto/Sensor Cook and Steam Clean) and preheating. This is to prevent the starting temperature of food from rising before defrosting or cooking begins. A change in starting temperature could cause inaccurate results.
3. When using Standing Time or Delay Start, it is up to 2 power stages.
4. If the time exceeds one hour, it will count down in units of minutes. If less than one hour, the time will count down in units of seconds.
5. An "H" will appear in the display to denote hours.

Operation (continued)

Setting a Delayed Start



1 The start time can be delayed to start cooking at a later time. To do this, first press **Timer/Clock** once.

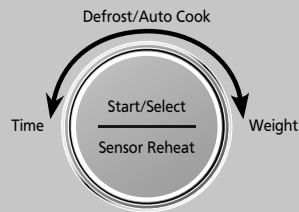

Set the desired delay time by turning dial (up to 1 hour and 30 minutes).

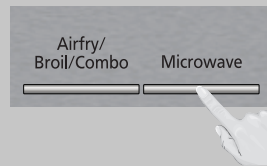
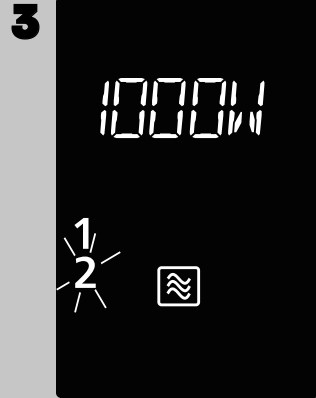

3 Press **Microwave** until the desired power level appears in the display. 1000 W is the highest and 100 W is the lowest.

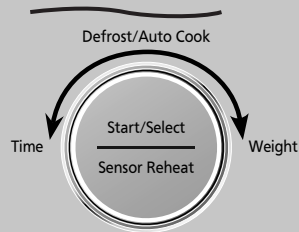
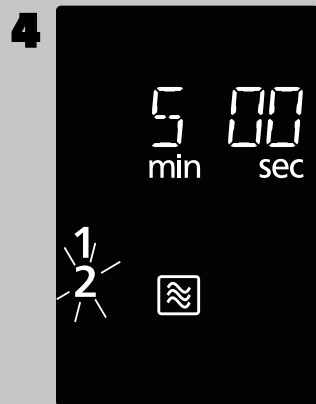

4 Set cooking time by turning dial (see previous page for maximum times).

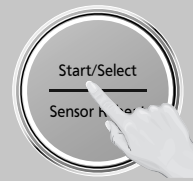
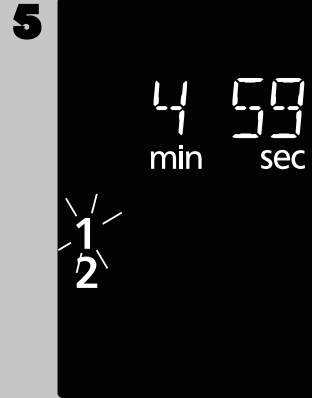

5 Press dial to **Start**, the delay time will count down, then cooking will begin.

NOTES:

1. If the oven door is opened during Kitchen Timer, Standing Time, Delay Start, the time in the display window will continue to count down.
2. Standing Time and Delay Start can not be programmed together with auto programs (such as Defrost, Sensor Reheat, Auto/Sensor Cook and Steam Clean) and preheating. This is to prevent the starting temperature of food from rising before defrosting or cooking begins. A change in starting temperature could cause inaccurate results.
3. When using Standing Time or Delay Start, it is up to 2 power stages.
4. If the time exceeds one hour, it will count down in units of minutes. If less than one hour, the time will count down in units of seconds.
5. An "H" will appear in the display to denote hours.

Operation (continued)

Add Time

(Example: To add cooking time after Broil 1 (High).)

1

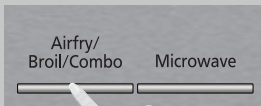

Set the desired cooking program, by entering cooking method and time required.

After cooking, "**ADD TIME OR ENJOY YOUR MEAL**" will appear in the display window.

3

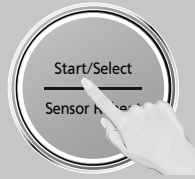
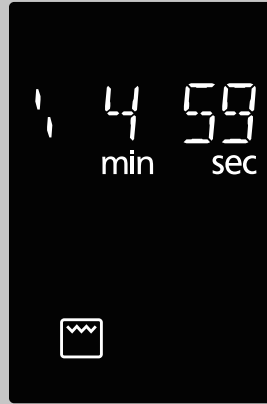

Press dial to **Start**. Time will be added. The time in the display window will count down.

2

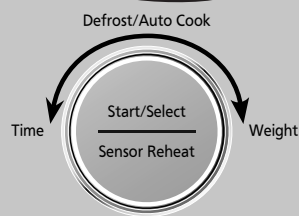
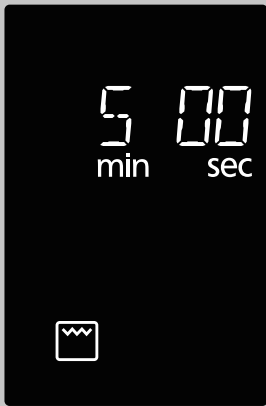

Set desired cooking time by turning dial.

NOTES:

1. This feature is not available for auto programs (such as Defrost, Sensor Reheat, Auto/Sensor Cook and Steam Clean).
2. **The Add Time function will be cancelled if you do not perform any operation within 1 minute after cooking.**
3. The Add Time function can be used after the 3-stage cooking.
4. The power level is the same as the last stage.

Operation (continued)

3-Stage Setting

(Example: Continually set [800 W] 2 minutes, [Combo 2 (Frozen foods)] 3 minutes and [Broil 2 (Low)] 2 minutes.)

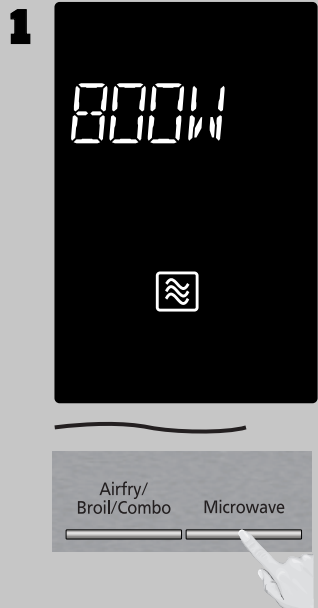

Press twice to select **800 W**.

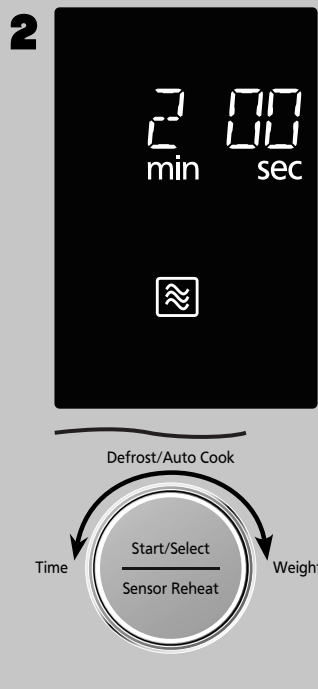

Set as 2 minutes by turning dial.



Press 5 times to select **Combo 2 (Frozen foods)**.



Set as 3 minutes by turning dial.

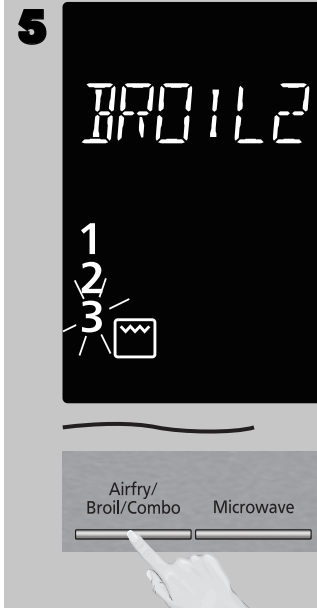

Press 3 times to select **Broil 2 (Low)**.



Set as 2 minutes by turning dial.

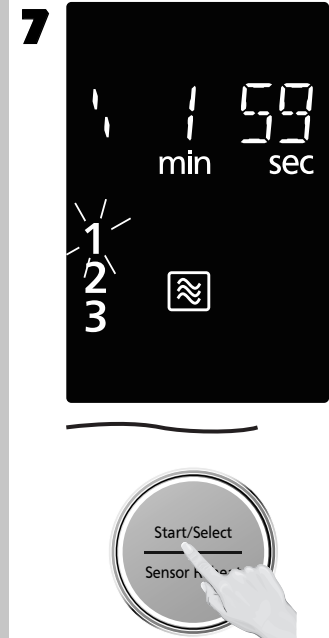

Press dial to **Start**. The time will count down at the first stage in the display window.

NOTES:

- When operating, two beeps will sound between each stage.
- Auto programs (such as Defrost, Sensor Reheat, Auto/Sensor Cook and Steam Clean) and preheating can not be used with 3-stage cooking.
- Standing Time, Delay Start can be used with 3-stage cooking.
- During cooking, one press on **Stop/Reset** stops the operation. You can re-start it by pressing **Start**. A second press of **Stop/Reset** will cancel the selected program.
- Whilst not operating, one press of **Stop/Reset** cancels the selected program.

Example to use:

Mug cake (1 mug)

Stage 1	800 W	1 minute
Stage 2	timer	20 seconds
Stage 3	800 W	1 minute

Operation (continued)

Sensor Reheat (One Push Reheating)

the Genius

This unique feature 'the Genius' built-in sensor allows you to reheat a chilled meal with one push of the dial. It is not necessary to select the power level or cooking time. The built-in sensor measures the humidity of the food and calculates the cooking time.

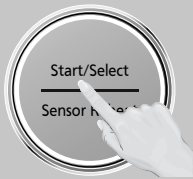
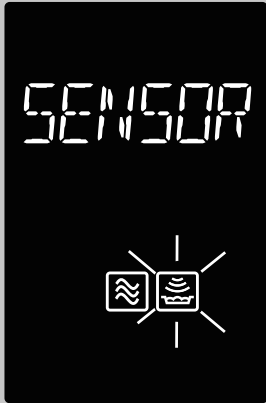

When clock mode is displayed, press the dial to Start. To reset oven and return to clock mode, press Stop/Reset twice.

Program	Weight	Accessories	Instructions
Sensor Reheat	8 - 36 oz. (200 - 1000 g)		All foods must be pre-cooked. Foods should be at refrigerator temperature approx. 41 °F (+ 5 °C). Reheat in microwaveable container as purchased. If transferring food to dish, cover with pierced plastic wrap. Press dial to Start. Stir at beeps. Stir again at end of program and allow a few minutes standing time. Large pieces of meat/fish in a thin sauce may require longer cooking.

One Push Reheating food chart:

Suitable foods	Pre-Cooked Dishes: Casserole, Stew, Leftover
	Chilled Meal, Entrée
Unsuitable foods	Raw Foods: Vegetables, Meats, Rice
	Thicker Foods, cannot not be stirred: Lasagne, Shepherds Pie
	Beverages: Water, Milk, Coffee

How it works

Once the One Push Reheating has been selected, the food is heated up. As food begins to get hot, steam is emitted. When the food reaches a certain temperature and begins to cook, an even greater amount of steam is released. The increase in steam emission is detected by a humidity sensor in the oven. This acts as a signal for the oven to calculate how much longer the food needs to cook. The remaining cooking time will appear in the display window after two beeps. Whilst the Sensor symbol is still flashing in the display window the oven door should not be opened. Wait until the cooking time appears in the window, and then open the door if required, to stir or turn the food.

Adjust to Taste

The One Push Reheating reheats a chilled meal for average tastes. You are able to adjust the reheating program to your own taste. After pressing Start, +/- symbol and flashing bar appears in the display, turn dial clockwise for more time or anticlockwise for less time. This operation should be completed within 14 seconds. Default mode is normal.

Notes:

1. Press the dial in two minutes right after the door was closed, otherwise One Push Reheating Function will be rejected and beeps will sound. Open the door and close it again will release the One Push Reheating Function.
2. The oven automatically calculates the reheating time or the remaining reheating time.
3. The door should not be opened before the time appears in the display window.
4. To prevent any mistakes during One Push Reheating ensure that glass tray and the container are dry.
5. The room temperature should not be more than 95 °F (35 °C) and not less than 32 °F (0 °C).
6. If the oven has previously been used and it is too hot to be used on One Push Reheating, "HOT INSIDE WAIT" will appear in the display window. After the "HOT INSIDE WAIT" disappears, the One Push Reheating may be used. If in a hurry, cook food manually by selecting the correct cooking mode and cooking time yourself.

Operation (continued)

Auto Defrost (No.1)

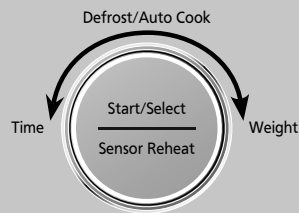

To allow auto program operation, ensure the oven is in clock mode. Select the Defrost by turning dial. The weight is 0.1 - 6.0 lbs (0.1 - 3.0 kg). (see chart on page 36.)

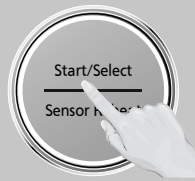

Press the dial to confirm the program.

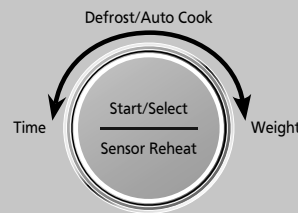
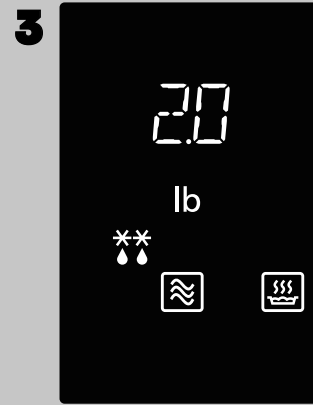

Select the weight of the food by turning dial. Turning the dial slowly will count up in 0.1 lb (0.1 kg) steps.

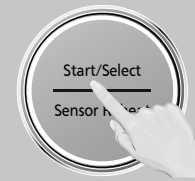
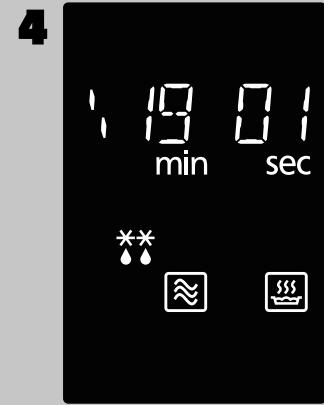

Press dial to **Start**. The time appears in the display window and begins to count down.

NOTES:

- Defrost can be used to defrost many cuts of meat, poultry and fish by weight. The oven will determine the defrosting time and power levels. Once the oven is programmed, the defrosting time will appear in the display. For best results the minimum recommended weight is 0.1 lb (0.1 kg).
- Turn over the food, remove defrosted food and shield thin ends/fat bones of roast with foil when buzzer rings in the middle of cooking.
- Allow standing time so that the center of the food thaws out. (Minimum of 1 hour for joints of meat and whole chickens).

Conversion

Follow the chart to convert ounces or hundredths of a pound into tenths of a pound. To use **Defrost**, enter the weight of the food in pounds (1.0) and tenths of a pound (0.1). If a piece of meat weighs 1.95 lbs or 1 lb 14 oz., enter 1.9 lbs.

Ounces	Hundredths of a Pound	Tenths of a Pound
0	.01 - .05	0.0
1 - 2	.06 - .15	0.1
3 - 4	.16 - .25	0.2
5	.26 - .35	0.3
6 - 7	.36 - .45	0.4
8	.46 - .55	0.5
9 - 10	.56 - .65	0.6
11 - 12	.66 - .75	0.7
13	.76 - .85	0.8
14 - 15	.86 - .95	0.9

Operation (continued)

Auto Cook (Sensor):

Popcorn (No.2)

1

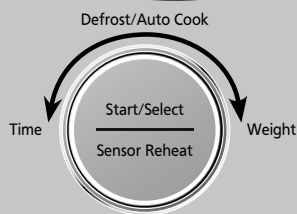

To allow auto program operation, ensure the oven is in clock mode. Select the Popcorn by turning the dial. The weight is 1.5 - 3.2 oz. (42 - 90 g). (see chart on page 36.)

2

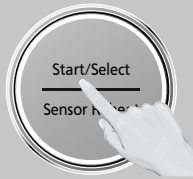

Press the dial to confirm the program.

3

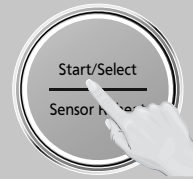

Press dial to **Start**. The food category will be repeated in the display window until the oven calculates the cooking time after detecting a burst of steam. Do not open the oven door until the remaining cooking time appears in the display window.

NOTES:

1. If desired, More/Less adjustment can be done. Turn dial to add or subtract the cooking time (5 levels can be selected), after turning the dial within 14 seconds.
2. Pop one bag at a time.
3. Place bag in oven according to manufacturers' directions.
4. Start with popcorn at room temperature.
5. Allow popped corn to sit unopened for a few minutes.
6. Open bag carefully to prevent burns, because steam will escape.
7. Do not reheat unpopped kernels or reuse bag.
8. If popcorn is of a different weight than listed, follow instructions on popcorn package.
9. **Never leave the oven unattended.**
10. **If popping slows to 2 to 3 seconds between pops, stop oven. Overcooking can burn popcorn or cause fire.**
11. When popping multiple bags one right after the other, the cooking time may vary slightly. This does not affect the popcorn results.
12. If the temperature of the cavity is too high, Sensor Cook feature cannot be used. The message "HOT INSIDE WAIT" will appear in the display window. Sensor Cook feature can be used again when the "HOT INSIDE WAIT" message disappears. Please open the door in order to cool the temperature of the cavity more quickly.

Operation (continued)

Auto Cook (Sensor): (No.3 - No.5)

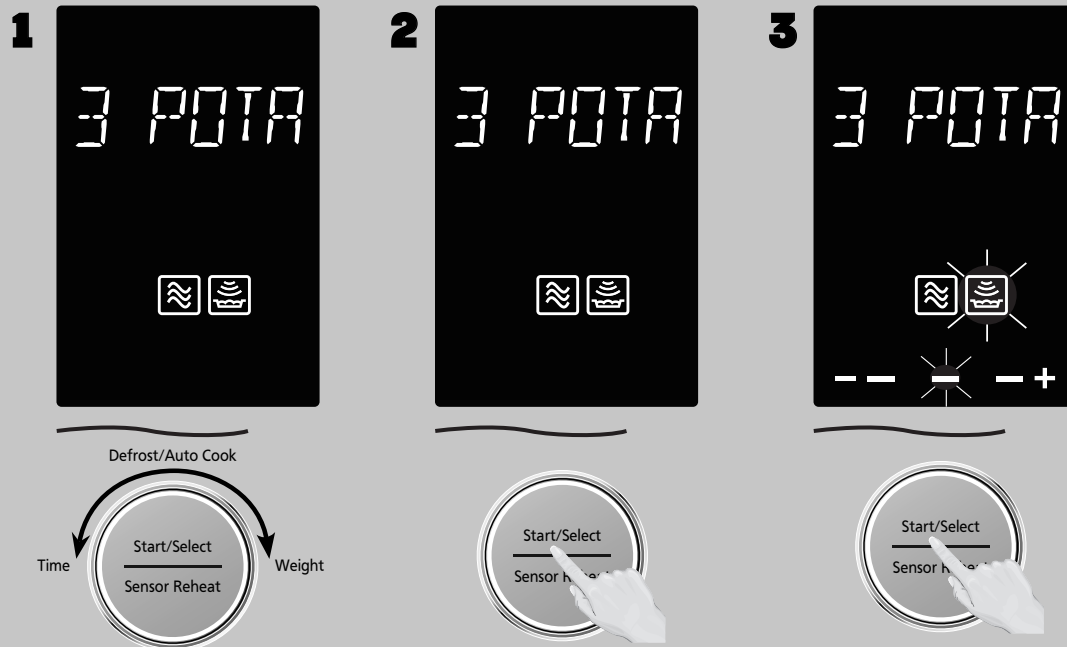

To allow auto program operation, ensure the oven is in Clock mode. Select the desired menu by turning the dial. (see chart on the next page.)

Press the dial to confirm the program.

Press dial to **Start**. The food category will be repeated in the display window until the oven calculates the cooking time after detecting a burst of steam. Do not open the oven door until the remaining cooking time appears in the display window.

NOTES:

1. If desired, More/Less adjustment can be done. Turn dial to add or subtract the cooking time (3 levels can be selected), after turning the dial within 14 seconds.
2. After having used the Sensor Cook feature a few times, you may decide you would prefer your food cooked to a different doneness – that is why you would like to turning the dial.
3. When steam is detected by the Genius Sensor and two beeps sound, the remaining cooking time will appear in the display.
4. Automatic features are provided for your convenience. If results are not suitable to your individual preference, or if serving size is other than what is listed in next page, please refer to manual cooking on page 25.
5. If the temperature of the cavity is too high, Sensor Cook feature cannot be used. The message “HOT INSIDE WAIT” will appear in the display window. Sensor Cook feature can be used again when the “HOT INSIDE WAIT” message disappears. Please open the door in order to cool the temperature of the cavity more quickly.

For the best results with the GENIUS SENSOR, follow these recommendations:

BEFORE Reheating/Cooking:

1. The room temperature surrounding the oven should be below 95 °F (35 °C).
2. Food weight should exceed 4 oz. (110 g).
3. Be sure the glass tray, the outside of the cooking containers and the inside of the microwave oven are dry before placing food in the oven. Residual beads of moisture turning into steam can mislead the sensor.
4. Cover food with lid, or with vented plastic wrap. Never use tightly sealed plastic containers—they can prevent steam from escaping and cause food to overcook.

DURING Reheating/Cooking:

DO NOT open the oven door until two beeps sound and cooking time appears in the display. Doing so will cause inaccurate cooking since the steam from food is no longer contained within the oven cavity. Once the cooking time begins to count down, the oven door may be opened to stir, turn or rearrange foods.

AFTER Reheating/Cooking:

All foods should have a standing time.

Operation (continued)

No.	Menu	Weight Range	Recommended Container	Accessory and Placement
1	Defrost	0.1 - 6.0 lb (0.1 - 3.0 kg)	microwave safe dish	Directly on the glass tray
2	Popcorn	1.5 - 3.2 oz. (42 - 90 g)	original bag	Directly on the glass tray
3	Potatoes	8 - 56 oz. (200 - 1500 g)	kitchen paper	Directly on the glass tray
4	Steam Vegetables	8 - 36 oz. (200 - 1000 g)	microwave safe casserole with a lid or plastic wrap	Directly on the glass tray
5	Fresh Fish	8 - 30 oz. (200 - 800 g)	microwave safe casserole with a lid or plastic wrap	Directly on the glass tray

1. Defrost

This feature allows you to defrost minced meat, chops, chicken portions, meat joints. Foods should be placed in a suitable dish. Chops, chicken portions should be placed in a single layer. It is not necessary to cover the foods. Turn over or stir the food after beeps. Allow standing time so that the center of the food thaws out.

2. Popcorn

Pop one bag at a time. Place bag in oven according to manufacturers' directions. Start with popcorn at room temperature. Allow popped corn to sit unopened for a few minutes. Open bag carefully to prevent burns, because steam will escape. Do not reheat unpopped kernels or reuse bag. If popcorn is of a different weight than listed, follow instructions on popcorn package.

3. Potatoes

Pierce each potato with a fork 6 times spacing around surface. Place potato or potatoes around the edge of paper-towel-lined glass tray, at least 1 inch (2.5 cm) apart. Do not cover. Turn at beeps. Let stand 5 minutes to complete cooking.

4. Steam Vegetables

All pieces should be the same size. Wash thoroughly, add 1 tbsp (15 ml) of water per ½ cup (125 ml) of vegetables, and cover with lid or plastic wrap. Pierce with a fork several times. Stir at beeps. Do not salt/butter until after cooking.

5. Fresh Fish

To cook fresh fillets or steaks of fish. Place fish in a suitable size container, add 2 tbsp (30 ml) water. Cover with lid or plastic wrap. Pierce with a fork several times.

Operation (continued)

Auto Cook:

Melt & Soften (No.6 - No.8)

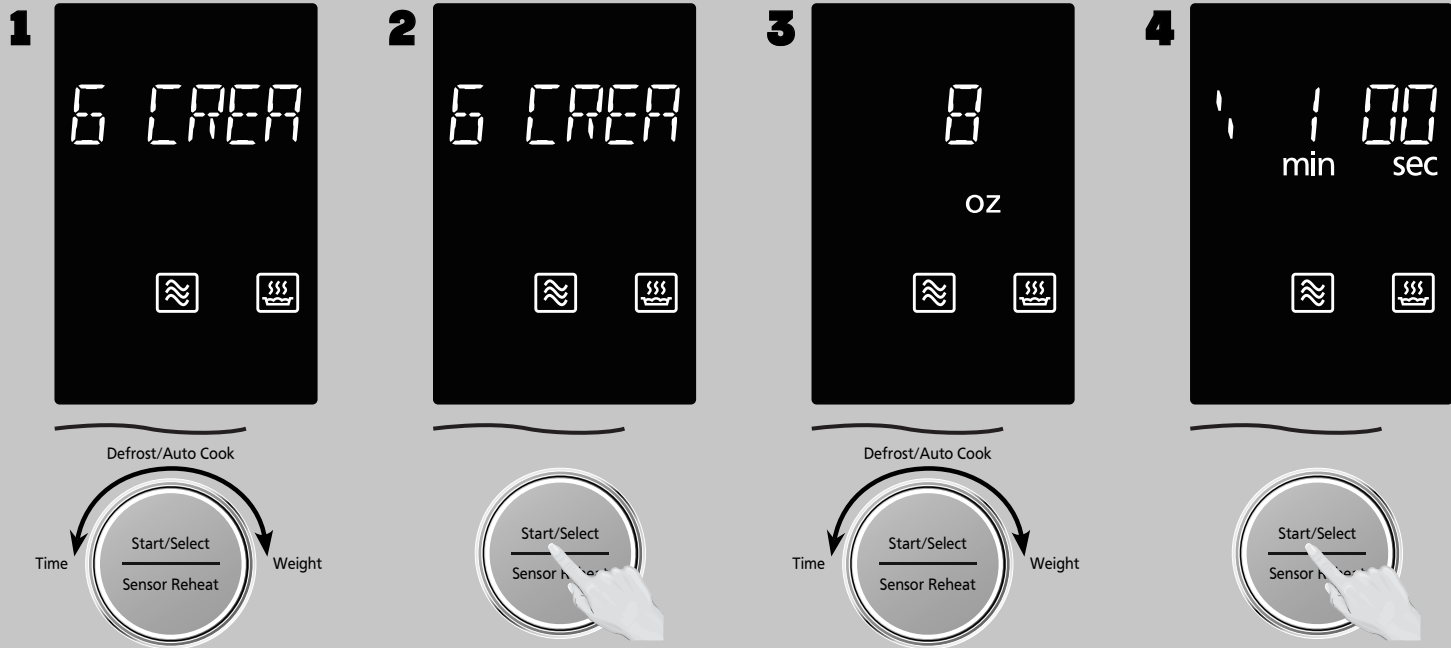

To allow auto program operation, ensure the oven is in Clock mode. Select the desired menu by turning the dial. (see chart below)

Press the dial to confirm the program.

Select the weight of the food by turning dial.

Press dial to **Start**. The time appears in the display window and begins to count down.

No.	Menu	Weight Range	Recommended Container	Accessory and Placement
6	Cream Cheese	2/4/6/8/10/12 oz. (50/100/150/200/250/300 g)	microwave safe dish with plastic wrap	Directly on the glass tray
7	Chocolate	2/4/6/8/10/12 oz. (50/100/150/200/250/300 g)	microwave safe dish	Directly on the glass tray
8	Butter	2/4/6/8/10/12 oz. (50/100/150/200/250/300 g)	microwave safe dish with plastic wrap	Directly on the glass tray

6. Cream Cheese

Remove wrapper, cut cheese into 1 inch (3 cm) cube, and place in a microwave safe dish. Cover with plastic wrap.

7. Chocolate

Suitable for melting milk chocolate. Remove wrapper, separate chocolate into small pieces, and place in a microwave safe dish. Cook without cover. Stir after cooking.

8. Butter

Remove wrapper, cut butter into 1 inch (3 cm) cube, and place in a microwave safe dish. Cover with plastic wrap.

Operation (continued)

Auto Cook:

Convection Bake/Combo (No.9 - No.16)

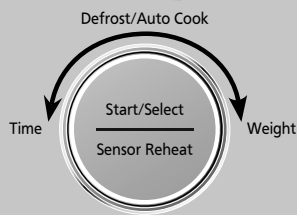
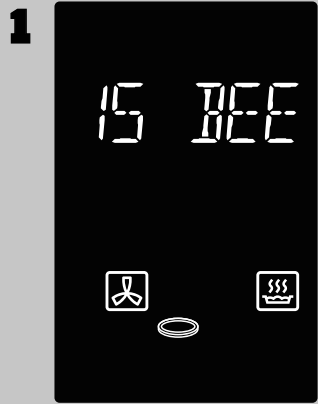

To allow auto program operation, ensure the oven is in clock mode. Select the desired menu by turning the dial. Press the dial to confirm the program.
(see chart below, recipes are on the next page.)

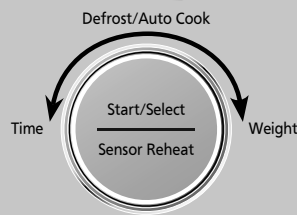

Select the weight of the food by turning dial. (except Menu No.9, No.10 and No.14)

3 Press the dial to preheat the oven. "PREHEAT" will scroll across display window once then a "P" will appear in the display window.
(Skip this step when preheating is not required)

After preheating, the oven will beep and "P END" will display in the display window. Open the door, put the food into the oven immediately and close the door.

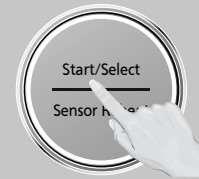
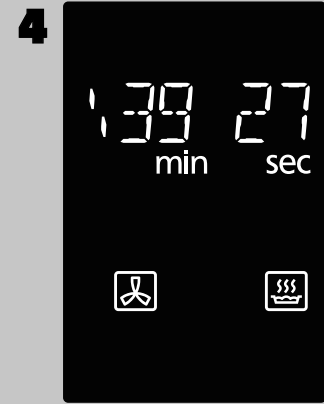

Press dial to **Start**. The time appears in the display window and begins to count down.

No.	Menu	Weight Range	Recommended Container	Accessory and Placement
9*	Cake	9 inch (23 cm)	9 inch cake pan	Enamel tray on glass tray
10*	Cookie	15 pcs	—	Enamel tray on glass tray
11**	Frozen Pizza	9 inch/12 inch (23 cm/30 cm)	—	Wire rack on enamel tray on glass tray
12*	Fresh Pizza	9 inch/12 inch (23 cm/30 cm)	—	Enamel tray on glass tray
13*	Roast Chicken	36 - 80 oz. (900 - 2000 g)	—	Enamel tray on glass tray
14**	Slow Cook/Stew	6 servs	microwave safe casserole	Directly on the glass tray
15**	Beef Rare	20 - 80 oz. (500 - 2000 g)	—	Enamel tray on glass tray
16**	Beef Medium	20 - 80 oz. (500 - 2000 g)	—	Enamel tray on glass tray

* With preheating

** Without preheating

Refer to P39

Operation (continued)

9. Cake

Ingredient:

15 oz. (420 g)	cake mix
3	eggs
4 oz. (110 g)	vegetable oil
10 oz. (280 g)	water

Method:

1. Beat cake mix, eggs, vegetable oil and water in a large bowl with electric mixer on low speed for 30 seconds, then on medium speed for 2 minutes.
2. Use the dial to set the program, then press Start to preheat the oven.
3. Pour cake batter into a 9 inch (23 cm) round and at least 2 inch (5 cm) deep cake pan with baking paper. Place cake pan on enamel tray.
4. After preheating, beeps sound and "P END" will flash in the display. Put the enamel tray on glass tray quickly and press the dial to Start. Cool for 10 minutes in pan and gently remove from pan onto wire rack to cool completely.

10. Cookie

Ingredient:

8½ oz. (240 g)	cookie mix
1½ oz. (40 g)	butter
1 oz. (25 g)	egg wash

Method:

1. Stir cookie mix, butter and egg in a large bowl with a wooden spoon until just combined. Use your hands to form a soften dough.
2. Measure tablespoons of cookie dough and roll into balls. Place onto baking paper lined enamel tray, spacing about 2 inch (5 cm) apart.
3. Use the dial to set the program, then press Start to preheat the oven.
4. After preheating, beeps sound and "P END" will flash in the display. Put the enamel tray on glass tray quickly and press the dial to Start. Cool on tray for 10 minutes, then gently remove from tray onto a wire rack to cool completely.

11. Frozen Pizza

For reheating and browning frozen, purchased pizza. Remove all packaging and place pizza on wire rack on enamel tray on glass tray.

12. Fresh Pizza

Ingredients:

(9 inch)

6 oz. (150 g)	fresh pizza dough
Extra oil for brushing	

Toppings:

1 oz. (25 g)	tomato sauce
2 oz. (55 g)	pepperoni
2 oz. (55 g)	shredded mozzarella cheese, or more to taste

(12 inch)

10 oz. (280 g)	fresh pizza dough
Extra oil for brushing	

Toppings:

2 oz. (55 g)	tomato sauce
3 oz. (80 g)	pepperoni
4 oz. (110 g)	shredded mozzarella cheese, or more to taste

Directions:

1. Roll the dough out to 9 inch (23 cm)/12 inch (30 cm) and brush the bottom with oil, then put it on enamel tray, top crust with sauce, cheese and pepperoni.
2. Use the dial to set the program, then press Start to preheat the oven.
3. After preheating, beeps sound and "P END" will flash in the display. Put the enamel tray on glass tray quickly and press the dial to Start.

13. Roast Chicken

1. Marinated the whole chicken for 30 minutes.
2. Use the dial to set the program, then press Start to preheat the oven.
3. After preheating, beeps sound and "P END" will flash in the display. Put the chicken on enamel tray on glass tray quickly and press the dial to Start. Turn it over at beeps.

14. Slow Cook/Stew

Beef curry casserole (6 servings)

Ingredient:

½ oz. (15 g)	oil
1	large onion, chopped
1	large tomato, chopped
1 oz. (25 g)	curry paste
1 tbsp. (15 g)	flour
8 oz. (225 g)	beef stock
36 oz. (1000 g)	chuck steak, fat removed and cut into 1 inch (2.5 cm) cubes
1 tbsp. (15 g)	vinegar

Place all ingredients in a 4-quart casserole dish. Put the microwave safe casserole on the glass tray. Uncovered. Stir at beeps.

15. Beef Rare

For cooking rare fresh roast beef (top side, rump or silver-side). Place the beef on the enamel on glass tray. Turn at beeps. Allow to stand for 10 to 20 minutes after cooking.

16. Beef Medium

For cooking medium fresh roast beef (top side, rump or silver-side). Place the beef on the enamel on glass tray. Turn at beeps. Allow to stand for 10 to 20 minutes after cooking.

Operation (continued)

Auto Cook:

Beverage (No.17 - No.18)

(Example: To reheat 1 cup milk.)

1

Defrost/Auto Cook

Time Start/Select Weight
Sensor Reheat

To allow auto program operation, ensure the oven is in clock mode. Select the desired menu by turning the dial. (see chart below)

2

Start/Select
Sensor Reheat

Press the dial to confirm the program selection.

3

Defrost/Auto Cook

Time Start/Select Weight
Sensor Reheat

Select the weight of the food by turning dial.

4

Start/Select
Sensor Reheat

Press dial to **Start**. The time appears in the display window and begins to count down.

No.	Menu	Weight Range	Recommended Container	Accessory and Placement
17	Tea/Coffee	1 cup/2 cups (250/500 ml)	microwave safe cup	Directly on the glass tray
18	Milk/Hot Chocolate/ Milky Coffee	1 cup/2 cups (250/500 ml)	microwave safe cup	Directly on the glass tray

NOTES:

- Use a microwave safe cup.
- Heated Beverage can erupt if not mixed with air. Do not heat Beverage in your microwave oven without stirring before and halfway through heating.
- Care must be exercised not to overheat Beverage. It is programmed to give proper result when heating 1 cup or 2 cups of Beverage, starting from room temperature for Tea/Coffee and refrigerator temperature for Milk/Hot Chocolate/Milky Coffee. Overheating will cause an increased risk of scalding, or water eruption. Refer to page 4, item 18.

Operation (continued)

Auto Cook:

Re-Bake Bread (No.19 - No.20)

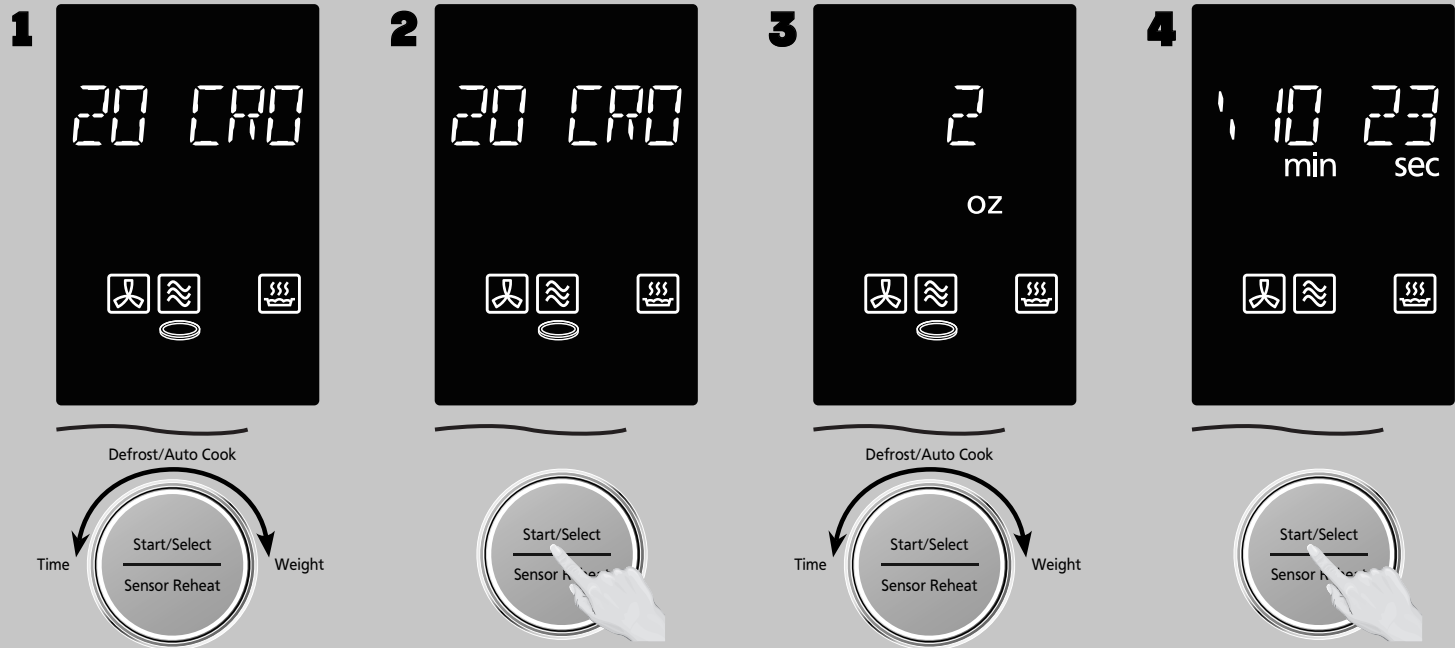

To allow auto program operation, ensure the oven is in clock mode. Select the desired menu by turning the dial. (see chart below)

Press the dial to confirm the program.

Select the weight of the food by turning dial.

Press dial to **Start**. The time appears in the display window and begins to count down.

No.	Menu	Weight Range	Recommended Container	Accessory and Placement
19	Baguette/Crusty Rolls	4 - 20 oz. (100 - 500 g)	—	Enamel tray on glass tray
20	Croissants	2 - 14 oz. (50 - 350 g)	—	Enamel tray on glass tray

19. Baguette/Crusty Rolls

To re-bake pre-purchased baguettes and rolls from room temperature. Ensure height of baguette/rolls is no more than 2 inch (5 cm). Place baguette/crusty rolls on enamel tray on glass tray. After cooking place on a wire rack for a few minutes.

20. Croissants

To re-bake pre-purchased croissants from room temperature. Place croissants on enamel tray on glass tray. After cooking place on a wire rack for a few minutes.

Operation (continued)

Auto Steam Clean: (No.21)

1 Place 1¼ cups (300 ml) tap water with 1 tbsp (15 ml) lemon juice in a microwaveable container (e.g. jug or bowl). Use a jug or bowl of at least 2 cups (500 ml) volume.

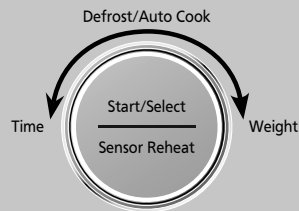

To allow auto program operation, ensure the oven is in clock mode. Select the desired menu by turning the dial. Press the dial to confirm the program.

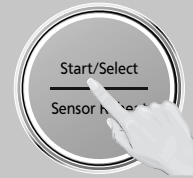
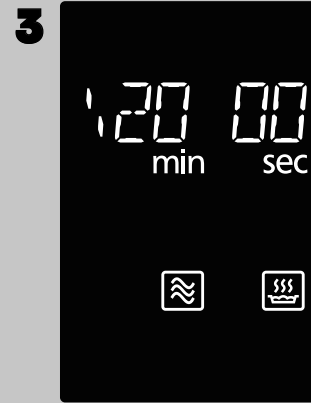

Press dial to **Start**. The time appears in the display window and begins to count down. The program runs for 20 minutes.

4 Five beeps sound at the completion of the program. Open oven door and wipe the cavity and door area with a soft cloth.

NOTES:

1. This program is to clean the cavity and remove any food odour from the microwave oven.
2. Do not remove the glass tray and roller ring during this program.
3. To clean the glass tray and roller ring, refer to page 53.
4. Repeat the above procedure as required.

Defrosting Tips & Techniques

Preparation For Freezing:

1. Freeze meats, poultry, and fish in packages with only one or two layers of food. Place wax paper between layers.
2. Package in heavy-duty plastic wraps, bags (labeled "For Freezer"), or freezer paper.
3. Remove as much air as possible.
4. Seal securely, date, and label.

To Defrost:

1. Remove wrapper. This helps moisture to evaporate. Juices from food can get hot and cook the food.
2. Set food in microwave safe dish.
3. Place roasts fat-side down. Place whole poultry breast-side down.
4. Select power and minimum time so that items will be under-defrosted.
5. Drain liquids during defrosting.
6. Turn over (invert) items during defrosting.

After Defrosting:

1. Large items may be icy in the center. Defrosting will complete during Standing Time.
2. Let stand, covered, following standing time directions on page 28.
3. Rinse foods indicated in the chart.
4. Items which have been layered should be rinsed separately or have a longer standing time.

FOOD	MANUAL DEFROST TIME at 300 W (min/kg) (min/lb)		DURING DEFROSTING	AFTER DEFROSTING	
				Standing Time	Rinse
Fish and Seafood [up to 3 lbs. (1.4 kg)]					
Crabmeat	12	6	Break apart/Rearrange	5 min.	YES
Fish Steaks	10 to 12	5 to 6	Turn over		
Fish Fillets	10 to 12	5 to 6	Turn over/Rearrange/Shield ends		
Sea Scallops	10 to 12	5 to 6	Break apart/ Remove defrosted pieces		
Whole fish	10 to 12	5 to 6	Turn over		
Meat					
Ground Meat	8 to 10	4 to 5	Turn over/Remove defrosted portion/Shield edges	10 min.	NO
Roasts [2½-4 lbs. (1.1-1.8 kg)]	8 to 16	4 to 8	Turn over/Shield ends and defrosted surface	30 min. in fridge.	
Chops/Steak	12 to 16	6 to 8	Turn over/Rearrange/Shield ends and defrosted surface	5 min.	
Ribs/T-bone	12 to 16	6 to 8	Turn over/Rearrange/Shield ends and defrosted surface		
Stew Meat	8 to 16	4 to 8	Break apart/Rearrange/ Remove defrosted pieces		
Liver (thinly sliced)	8 to 12	4 to 6	Drain liquid/Turn over/ Separate pieces		
Bacon (sliced)	8	4	Turn over	---	
Poultry					
Chicken, Whole [up to 3 lbs. (1.4 kg)]	8 to 12	4 to 6	Turn over/Shield	20 min. in fridge	YES
Cutlets	8 to 12	4 to 6	Break apart/Turn over/ Remove defrosted Pieces	5 min.	
Pieces	8 to 12	4 to 6	Break apart/Turn over/Shield	10 min.	
Cornish hens	12 to 16	6 to 8	Turn over/Shield		
Turkey Breast [5-6 lbs. (2.3-2.7 kg)]	12	6	Turn over/Shield	20 min. in fridge	

Microwave shortcuts

FOOD	POWER	TIME (in mins.)	DIRECTIONS
To separate refrigerated Bacon, 16 oz. (450 g)	1000 W	30 sec.	Remove wrapper and place in microwave safe dish. After heating, use a plastic spatula to separate slices.
To soften refrigerated Butter, 1 stick, 4 oz. (110 g)	300 W	1	Remove wrapper and place butter in a microwave safe dish covered with lid or vented plastic wrap.
To melt refrigerated Butter, 1 stick, 4 oz. (110 g)	600 W	1½ - 2	
To melt Chocolate, 1 square, 1 oz. (25 g)	600 W	1 - 1½	Remove wrapper and place chocolate in a microwave safe dish. After heating, stir until completely melted. NOTE: Chocolate holds its shape even when softened.
To melt Chocolate, ½ cup (125 ml) chips	600 W	1 - 1½	
To toast Coconut, ½ cup (125 ml)	1000 W	1	Place in a microwave safe dish. Stir every 30 seconds.
To soften Cream Cheese, 8 oz. (225 g)	300 W	1 - 1½	Remove wrapper and place in a microwave safe bowl.
To brown Ground Beef, 16 oz. (450 g)	1000 W	4 - 5	Crumble into a microwave safe colander set into another dish. Cover with plastic wrap. Stir twice. Drain grease.
To cook Vegetables, Fresh 8 oz. (225 g)	800 W	4 - 5	All pieces should be the same size. Wash thoroughly, add 1 tbsp of water per ½ cup of vegetables, and cover with lid or vented plastic wrap. Do not salt/butter until after cooking.
Frozen 10 oz. (280 g)	800 W	6 - 7	
Canned 15 oz. (420 g)	800 W	3½ - 4	
To cook baked Potato, 6 - 8 oz. each (165 - 225 g)	800 W 800 W	4 - 5	Pierce each potato with a fork 6 times spacing around surface. Place potato or potatoes around the edge of paper-towel-lined glass tray (Turntable), at least 1 inch (2.5 cm) apart. Do not cover. Let stand 5 minutes to complete cooking.
1 piece 2 pieces		6 - 7	
To steam Hand Towel	1000 W	20 - 30 sec.	Soak in water, then wring out excess. Place on a microwave safe dish. Heat. Present immediately.
To soften Ice Cream, ½ gallon (2 L)	300 W	1 - 1½	Check often to prevent melting.

Microwave shortcuts (continued)

FOOD	POWER	TIME (in mins.)	DIRECTIONS
Cup of liquid To boil water, broth, etc. 1 cup, 8 oz. (250 ml) 2 cups, 16 oz. (500 ml)	1000 W	1½ - 2 2½ - 3	Heated liquids can erupt if not stirred. Do not heat liquids in microwave oven Cup of liquid without stirring before heating.
Cup of liquid To warm Beverage, 1 cup, 8 oz. (250 ml) 2 cups, 16 oz. (500 ml)	800 W	1½ - 2 2½ - 3	
To roast Nuts, 1½ cups (340 g)	1000 W	3 - 4	Spread nuts into a 9-inch (23 cm) microwave safe pie plate. Stir occasionally.
To toast Sesame Seeds, ¼ cup (55 g)	1000 W	2 - 2½	Place in a small microwave safe bowl. Stir twice.
To skin Tomatoes, (one at a time)	1000 W	30 sec.	Place tomato into a microwave safe bowl containing boiling water. Rinse and peel. Repeat for each tomato.
To remove Cooking Odours	1000 W	5	Combine 1 to 1½ cups (250 - 375 ml) water with the juice and peel of one lemon in a 2 quart microwave safe bowl. After water finishes boiling, wipe interior of oven with a cloth. You can also use a Combo of several whole cloves and ¼ cup of vinegar with 1 cup of water.

Defrosting Chart

Select **Defrost** microwave. The times given below are a guideline only. Always check the progress of the food by opening the oven door and then re-starting.

For larger quantities adjust times accordingly. Food should not be covered during defrosting.

Food	Defrosting Time	Method	Standing Time
Meat			
Beef/Lamb/Pork joint 18 oz. (500 g)	8-9 mins	Place in a suitable dish or on an upturned saucer or use a microwave safe rack. Turn once. Shield.	30 mins
Minced beef 18 oz. (500 g)	6 mins 30 secs	Place in a suitable dish. Break up and turn once.	5 mins
Chops 16 oz. (450 g)	6-7 mins	Place in a suitable dish in a single layer. Turn once. Shield if necessary.	5 mins
Sausages 16 oz. (450 g)	6 mins	Place in a suitable dish in a single layer. Turn twice. Shield if necessary.	5 mins
Bacon rashers 18 oz. (500 g)	4-6 mins	Place in a suitable dish. Turn and separate twice. Shield if necessary.	3 mins
Stewing steak 16 oz. (450 g)	6 mins	Place in a suitable dish. Break up frequently.	5 mins
Whole chicken 18 oz. (500 g)	6-8 mins	Place in a suitable dish on an upturned saucer or use a microwave safe rack. Turn once. Shield.	10 mins
Chicken portions 16 oz. (450 g)	5-7 mins	Place in a suitable dish in a single layer. Turn once. Shield if necessary.	10 mins
Fish			
Whole 12 oz. (340 g)	7-9 mins	Place in a suitable dish. Turn once. Shield.	5 mins
Fillet/Steak 16 oz. (450 g)	5-6 mins	Place in a suitable dish. Turn once, separate and shield if necessary.	5 mins
Prawns 16 oz. (450 g)	5-7 mins	Place in a suitable dish. Stir halfway during defrosting.	5 mins
General			
Bread sliced 14 oz. (400 g)	4 mins	Place on a plate. Separate and rearrange during defrosting.	5 mins
Slice of bread 2 oz. (55 g)	20 secs-30 secs	Place on a plate.	1-2 mins
Pastry 18 oz. (500 g)	4 mins	Place on a plate. Turn halfway.	5-10 mins
Soft fruit 16 oz. (450 g)	5-6 mins	Place in a suitable dish. Stir once during defrosting.	2 mins

Note:

Opening the door and taking out the defrosted parts during the operating time is recommended. Turn over, stir or rearrange the parts which are still in icy.

Reheating Chart

The times given in the charts below are a guideline only, and will vary depending on starting temperature, dish size etc.

Food	Weight/ Quantity	Power Level	Time to Select (approx)	Instructions/Guidelines
Canned beans, pasta				
Baked beans	8 oz. (225 g)	1000 W	2 mins	Place in a micro-safe bowl on glass tray. Cover.
	16 oz. (450 g)	1000 W	3 mins	
Baked beans & sausages/burgers	16 oz. (450 g)	1000 W	3-4 mins	
Canned meat				
Hot dogs (drained)	16 oz. (450 g)	1000 W	2-3 mins	Place in a micro-safe bowl on glass tray. Cover.
Stewed steak	16 oz. (450 g)	1000 W	3-4 mins	
Canned soups				
Cream of mushroom	16 oz. (450 g)	1000 W	3-4 mins	Place in a micro-safe bowl on glass tray. Cover.
Minestrone	16 oz. (450 g)	1000 W	2 mins 30 secs	Stir halfway.
Canned vegetables - Drain where appropriate				
Carrots, whole	12 oz. (340 g)	1000 W	2 mins	Place in a micro-safe bowl on glass tray. Cover.
Peas, mushy	12 oz. (340 g)	1000 W	2 mins	Stir halfway.
Peas, garden	12 oz. (340 g)	1000 W	2 mins - 2 mins 30 secs	Place in a micro-safe bowl on glass tray. Cover.
Sweetcorn	8 oz. (225 g)	1000 W	1 min 30 secs	Place in a micro-safe bowl on glass tray. Cover. Stir halfway.
	12 oz. (340 g)	1000 W	2-3 mins	
Tomatoes, whole	14 oz. (400 g)	1000 W	3 mins 30 secs	Place in a micro-safe bowl on glass tray. Cover.
Pastry products – precooked – N.B. Pastries reheated by microwave will have a soft base. For combination cooking, if pie comes in foil container place directly onto enamel tray.				
Cornish pastie	5 oz. (150 g)	1000 W or Combo 2	1-2 mins	Place in micro-safe dish on glass tray. Do not cover.
	12 oz. (340 g)	1000 W or Combo 2	2-3 mins	Place in micro-safe dish on glass tray. Do not cover.
Pastry products – precooked – N.B. Pastries reheated by microwave will have a soft base. If pie comes in foil container place directly onto enamel tray.				
Meat pies	12 oz. (340 g)	Combo 2	2-3 mins	Place on enamel tray on glass tray
Steak and kidney Shortcrust pie	8 oz. (225 g)	Combo 2	2-3 mins	
Quiche	16 oz. (450 g)	1000 W	4-5 mins	Place in micro-safe dish on glass tray. Do not cover.
		or Combo 2	3-4 mins	Place on wire rack on enamel tray on glass tray.
Sausage roll	12 oz. (340 g)	Combo 2	3-4 mins	Do not cover.
Xmas mince pies	4 oz. (110 g)	1000 W	10-20 secs	Place in micro-safe dish on glass tray. Do not cover.
Plated meals – homemade – chilled				
Child size	1	1000 W	2-3 mins	Place on a micro-safe plate on glass tray. Cover.
Adult size	1	1000 W	4-5 mins	
Puddings and desserts- Transfer puddings to a micro-safe/heatproof dish				
Apple pie (chilled)	18 oz. (500 g)	1000 W or Combo 2	3-4 mins	Place in micro-safe dish on glass tray. Do not cover.
Apple and blackcurrant pies (room temperature)	x 6	Convection 425 °F (220 °C)	6-7 mins	Place in foil cases on wire rack on enamel tray on glass tray. Do not cover.
Bread and butter pudding (chilled)	18 oz. (500 g)	1000 W	3-4 mins	Place on glass tray. Do not cover.
Custard (chilled)	1¼ cups (300 ml)	1000 W	2 mins - 2 mins 30 secs	Place in large jug. Stir during reheating.

Note:

Always check that food is piping hot after reheating in the microwave. If unsure return to oven. Foods will still require a standing time, especially if they cannot be stirred. The denser the food the longer the standing time.

Cooking Chart

The times given in the charts below are a guideline only, and will vary depending on starting temperature, dish size etc.

Food	Weight/ Quantity	Power Level	Time to Select (approx)	Instructions/Guidelines
Bread – Frozen				
Part-baked rolls	8 oz. (225 g)	Combo 2	3-4 mins	Place on enamel tray on glass tray.
Part-baked garlic baguette	5 oz. (140 g)	Combo 2	3-4 mins	
Bacon – from raw				
Rashers	12 oz. (340 g)	1000 W	4-6 mins or 1 min per rasher	Place on micro-safe rack or plate on glass tray and cover with kitchen towel to minimise splatter.
		or Broil 1	12-14 mins	Place on enamel tray on wire rack on glass tray. Turn halfway.
Steaks	8 oz. (225 g)	1000 W	4-5 mins	Place on micro-safe rack or plate on glass tray. Cover.
		or Broil 1	28-30 mins	Place on wire rack on enamel tray on glass tray. Turn halfway.
Beans & pulses – should be pre-soaked (except lentils)				
Black eyed beans	8 oz. (225 g)	1000 W then 300 W	10 mins 25-30 mins	Use 2½ cups (600 ml) boiling water in a large bowl. Cover.
Chick peas	8 oz. (225 g)	1000 W then 300 W	10 mins 45 mins	
Lentils	8 oz. (225 g)	600 W	10-15 mins	
Red kidney beans	8 oz. (225 g)	1000 W then 300 W	15 mins 35-40 mins	
Beef - Joints from raw – Caution: Hot fat! Remove dish with care.				
Topside, Forerib, Sirloin	-	Combo 2	10-12 min per 16 oz. (450 g)	Place on an upturned saucer on enamel tray on glass tray. Turn halfway.
Mince	18 oz. (500 g)	1000 W then 600 W	10 mins 15 mins	Place in micro-safe dish with stock and seasonings on glass tray. Stir halfway. Cover.
Chicken from raw – Caution: Hot Fat! Remove oven accessories with care.				
Breasts, boneless	26 oz. (730 g)	600 W	12-14 mins	Place on micro-safe rack or plate on glass tray. Cover.
Drumsticks	28 oz. (780 g)	600 W	12-14 mins	Place on micro-safe rack or plate on glass tray. Cover.
		or Convection 425 °F (220 °C)	25-30 mins	Place on wire rack on enamel tray on glass tray. Turn halfway.
Eggs – Scrambled				
Egg	1	1000 W	30 secs	Add 1 tablespoon of milk for each egg used. Beat eggs, milk and knob of butter together. Cook for 1st cooking time then stir. Cook for 2nd cooking time then stand for 1 minute.
Eggs	2	1000 W	20 secs	
		1000 W	50 secs	
Eggs	3	1000 W	30 secs	
		1000 W	1 min 20 secs	
		1000 W	30 secs	

Note:

Always check that food is piping hot after reheating in the microwave. If unsure return to oven. Foods will still require a standing time, especially if they cannot be stirred. The denser the food the longer the standing time.

Cooking Chart (continued)

Food	Weight/ Quantity	Power Level	Time to Select (approx)	Instructions/Guidelines
Fish – Fresh from raw				
Breaded fillets	10 oz. (280 g)	Broil 1	10-15 mins	Place on enamel tray on wire rack on glass tray. Turn halfway.
Fillets	10 oz. (280 g)	1000 W	3-4 mins	Place in micro-safe dish. Add 2 tbsp (30 ml) of liquid. Cover.
		or Broil 1	12-14 mins	Place on enamel tray on wire rack on glass tray. Turn halfway.
Steaks	8 oz. (225 g)	1000 W	3-4 mins	Place in micro-safe dish. Add 2 tbsp (30 ml) of liquid. Cover.
		or Broil 2	16-20 mins	Place on enamel tray on wire rack on glass tray. Turn halfway.
Whole	11 oz. (310 g)	1000 W	3-4 mins	Place in micro-safe dish. Add 2 tbsp (30 ml) of liquid. Cover.
		or Broil 2	22 mins	Place on enamel tray on wire rack on glass tray. Turn halfway.
Lamb – from raw – Caution: Hot Fat! Remove accessory with care.				
Chops, cutlets	11 oz. (310 g)	600 W	4-6 mins	Place in micro-safe dish or rack on glass tray. Cover.
Chops, loin	20 oz. (560 g)	600 W	5-7 mins	Place in micro-safe dish or rack on glass tray. Cover.
Joints	-	Combo 2	5-6 mins per 16 oz. (450 g)	Place on enamel tray on glass tray. Turn halfway.
Stewing lamb	16 oz. (450 g)	1000 W then 440 W	10 mins 40 mins	Place in micro-safe dish with stock and vegetables on glass tray. Stir halfway. Cover.
		or Combo 1	30-35 mins	Place in casserole dish, add stock and vegetables, cover with lid on enamel tray on glass tray. Stir halfway.
Pasta - Place in a large 3 litre microwave safe bowl.				
Twists	8 oz. (225 g)	1000 W	8-10 mins	Use 1 litre boiling water. Add 1 tbsp (15 ml) oil. Cover.
Macaroni	8 oz. (225 g)	1000 W	10-12 mins	Stir halfway.
Spaghetti / tagliatelle	8 oz. (225 g)	1000 W	8-10 mins	Use 1½ litres boiling water. Add 1 tbsp (15 ml) oil. Cover. Stir halfway.
Pasta shells - i.e. conchiglie	8 oz. (225 g)	1000 W	10-12 mins	
Pizza – fresh chilled – N.B. Remove all packaging. Pizzas will have a soft base if cooked by microwave only.				
Deep pan, ham	14 oz. (400 g)	1000 W	4-6 mins	Place on micro-safe plate on glass tray. Do not cover.
		or Convection 425 °F (220 °C)	12-16 mins	Place directly on wire rack on enamel tray on glass tray. Do not cover.
Thin and crispy	12 oz. (340 g)	Combo 2	5-7 mins	Place on wire rack on enamel tray on glass tray. Do not cover.
		or Convection 425 °F (220 °C)	9 mins	
Pork – from raw – Caution: Hot Fat! Remove oven accessories with care.				
Chops	18 oz. (500 g)	Broil 1	35-40 mins	Place on wire rack on enamel tray on glass tray. Turn halfway.
Pork – from raw – Caution: Hot Fat! Remove oven accessories with care.				
Joints	-	600 W	15-18 mins per 16 oz. (450 g)	Place on upturned saucer in micro-safe dish on glass tray. Turn joint over halfway during cooking. Drain off fat during cooking.
Gammon covered with water	-	1000 W then 600 W	15 mins 25-30 mins per 16 oz. (450 g)	Place in large casserole dish with lid and cover with water.

Note:

Always check that food is piping hot after reheating in the microwave. If unsure return to oven. Foods will still require a standing time, especially if they cannot be stirred. The denser the food the longer the standing time.

Cooking Chart (continued)

Food	Weight/ Quantity	Power Level	Time to Select (approx)	Instructions/Guidelines
Potato products part cooked – frozen				
Croquettes	12 oz. (340 g)	Combo 1	9-11 mins	Place on enamel tray on wire rack on glass tray. Turn halfway.
Hash browns	12 oz. (340 g)	Broil 1	16-19 mins	Place on enamel tray on wire rack on glass tray. Turn halfway.
Sausages from raw – caution: Hot Fat! Remove oven accessories with care.				
Thick	14 oz. (400 g)	Broil 1	17-18 mins	Place on wire rack on enamel tray on glass tray. Turn halfway.
Turkey from raw- Caution: Hot fat! Remove oven accessories with care.				
Turkey, crown	-	Combo 2	12-14 mins per 16 oz. (450 g)	Place on enamel tray on glass tray. Turn halfway.
Fresh vegetables – place in shallow micro-safe dish				
Broad beans	16 oz. (450 g)	1000 W	5-6 mins	Add 6 tbsp (90 ml) water. Cover.
Beetroot	16 oz. (450 g)	600 W	12-15 mins	
Brussel sprouts	16 oz. (450 g)	1000 W	8-9 mins	
Cabbage - sliced	16 oz. (450 g)	1000 W	8-10 mins	
Carrots - sliced	16 oz. (450 g)	1000 W	8-10 mins	
Courgettes	16 oz. (450 g)	1000 W	5 mins	
Corn on the cob	16 oz. (450 g)	1000 W	6-7 mins	
Leeks - sliced	16 oz. (450 g)	1000 W	7-8 mins	
Mushrooms	16 oz. (450 g)	1000 W	5 mins	
Spinach	16 oz. (450 g)	1000 W	6 mins	
Swede - cubed	16 oz. (450 g)	1000 W	8-12 mins	
Frozen vegetables – place in shallow micro-safe dish.				
Beans	16 oz. (450 g)	1000 W	8 mins	Add 2 tbsp (30 ml) water. Cover.
Beans - green	16 oz. (450 g)	1000 W	8-9 mins	
Broccoli	16 oz. (450 g)	1000 W	8-9 mins	
Brussels sprouts	16 oz. (450 g)	1000 W	9-10 mins	
Cabbage - shredded	16 oz. (450 g)	1000 W	7-8 mins	
Carrots - sliced	16 oz. (450 g)	1000 W	8 mins	
Cauliflower	16 oz. (450 g)	1000 W	9-10 mins	
Peas	16 oz. (450 g)	1000 W	6-7 mins	
Sweetcorn	16 oz. (450 g)	1000 W	7 mins	

Note:

Always check that food is piping hot after reheating in the microwave. If unsure return to oven. Foods will still require a standing time, especially if they cannot be stirred. The denser the food the longer the standing time.

Food Characteristics

Bone and Fat

Both bone and fat affect cooking. Bones may cause irregular cooking. Meat next to the tips of bones may overcook while meat positioned under a large bone, such as a ham bone, may be undercooked. Large amounts of fat absorb microwave energy and the meat next to these areas may overcook.



Density

Porous, airy foods such as breads, cakes or rolls take less time to cook than heavy, dense foods such as potatoes and roasts. When reheating donuts or other foods with different centers be very careful. Certain foods have centers made with sugar, water, or fat and these centers attract microwaves (for example, jelly donuts). When a jelly donut is heated, the jelly can become extremely hot while the exterior remains warm to the touch. This could result in a burn if the food is not allowed to cool properly in the center.



Quantity

Two potatoes take longer to cook than one potato. As the quantity of the food decreases so does the cooking time. Overcooking will cause the moisture content in the food to decrease and a fire could result. Never leave microwave unattended while in use.



Shape

Uniform sizes heat more evenly. The thin end of a drumstick will cook more quickly than the meaty end. To compensate for irregular shapes, place thin parts toward the center of the dish and thick pieces toward the edge.



Size

Thin pieces cook more quickly than thick pieces.



Starting Temperature

Foods that are at room temperature take less time to cook than if they are chilled, refrigerated or frozen.



Cooking Techniques

Piercing

Foods with skins or membranes must be pierced, scored or have a strip of skin peeled before cooking to allow steam to escape. Pierce clams, oysters, chicken livers, whole potatoes and whole vegetables. Whole apples or new potatoes should have a 1-inch (2.5 cm) strip of skin peeled before cooking. Score sausages and frankfurters. Do not Cook/Reheat whole eggs, with or without the shell. Steam buildup in whole eggs may cause them to explode, and possibly damage the oven or cause injury. Reheating SLICED hard-boiled eggs and cooking SCRAMBLED eggs is safe.

Browning

Foods will not have the same brown appearance as conventionally cooked foods or those foods which are cooked utilizing a browning feature. Meats and poultry may be coated with browning sauce, Worcestershire sauce, barbecue sauce or shake-on browning sauce. To use, combine browning sauce with melted butter or margarine and brush on before cooking. For quick breads or muffins, brown sugar can be used in the recipe in place of granulated sugar, or the surface can be sprinkled with dark spices before baking.

Spacing

Individual foods, such as baked potatoes, cupcakes and appetizers, will cook more evenly if placed in the oven equal distances apart. When possible, arrange foods in a circular pattern.

Covering

As with conventional cooking, moisture evaporates during microwave cooking. Casserole lids or plastic wrap are used for a tighter seal. When using plastic wrap, vent the plastic wrap by folding back part of the plastic wrap from the edge of the dish to allow steam to escape. Loosen or remove plastic wrap as recipe directs for standing time. When removing plastic wrap covers, as well as any glass lids, be careful to remove them away from you to avoid steam burns. Various degrees of moisture retention are also obtained by using wax paper or paper towels.

Shielding

Thin areas of meat and poultry cook more quickly than meaty portions. To prevent overcooking, these thin areas can be shielded with strips of aluminum foil. Wooden toothpicks may be used to hold the foil in place. **▲ CAUTION** is to be exercised when using foil. Arcing can occur if foil is too close to oven wall or door and damage to your oven will result.

Cooking Time

Cooking times will vary because of food shape variations, starting temperature, and regional preferences. Always cook food for the minimum cooking time given in a recipe and check for doneness. If the food is undercooked, continue cooking. It is easier to add time to an undercooked product. Once the food is overcooked, nothing can be done.

Stirring

Stirring is usually necessary during microwave cooking. Always bring the cooked outside edges toward the center and the less cooked center portions toward the outside of the dish.

Rearranging

Rearrange small items such as chicken pieces, shrimp, hamburger patties or pork chops. Rearrange pieces from the edge to the center and pieces from the center to the edge of the dish.

Turning

It is not possible to stir some foods to distribute the heat evenly. At times, microwave energy will concentrate in one area of the food. To help ensure even cooking, these foods need to be turned. Turn over large foods, such as roasts or turkeys, halfway through cooking.

Standing Time

Most foods will continue to cook by conduction after the microwave oven is turned off. After cooking meat, the internal temperature will rise 5 °F to 15 °F (3 °C to 8 °C), if allowed to stand, tented with foil, for 10 to 15 minutes. Casseroles and vegetables need a shorter amount of standing time, but this standing time is necessary to allow foods to complete cooking to the center without overcooking on the edges.

Test for Doneness

The same tests for doneness used in conventional cooking may be used for microwave cooking. Meat is done when fork-tender or splits at fibers. Chicken is done when juices are clear yellow and drumstick moves freely. Fish is done when it flakes and is opaque. Cake is done when a toothpick or cake tester is inserted and comes out clean.

Check foods to see that they are cooked to the United States Department of Agriculture's recommended temperatures.

To test for doneness, insert a meat thermometer in a thick or dense area away from fat or bone. NEVER leave the thermometer in the food during cooking, unless it is approved for microwave oven use.

Cook all food to these minimum internal temperatures as measured with a food thermometer before removing food from oven. For reasons of personal preference, you may choose to cook food at higher temperatures.

Product	Minimum Internal Temperature & Rest Time
Beef, Pork, Veal & Lamb Steaks, chops, roasts	145 °F (63 °C) and allow to rest for at least 3 minutes
Ground meats	160 °F (71 °C)
Ham , fresh or smoked (uncooked)	145 °F (63 °C) and allow to rest for at least 3 min.
Fully Cooked Ham (to reheat)	Reheat cooked hams packaged in USDA-inspected plants to 140 °F (60 °C); all others to 165 °F (74 °C).
All Poultry (breasts, whole bird, legs, thighs, and wings, ground poultry, and stuffing)	165 °F (74 °C)
Eggs	160 °F (71 °C)
Fish & Shellfish	145 °F (63 °C)
Leftovers	165 °F (74 °C)
Casseroles	165 °F (74 °C)

Care and Cleaning of Your Microwave Oven

Please see below and the following page for particular cleaning instructions for each section of the oven.

BEFORE CLEANING: Unplug oven at wall outlet. If outlet is inaccessible, leave oven door open while cleaning.

AFTER CLEANING: Be sure to place the Roller Ring and the Glass Tray in the proper position and press **Stop/Reset** Button to clear the Display.

1. **Outside oven surfaces:** Clean with a damp cloth. To prevent damage to the operating parts inside the oven, water should not be allowed to seep into ventilation openings.
2. **Label:** Do not remove. Wipe with a damp cloth.
3. **Inside the Oven:** Wipe with a damp cloth after using. Mild detergent may be used if needed. Do not use harsh detergents or abrasives.
4. **Oven Door:** Wipe with a soft dry cloth when steam accumulates inside or around the outside of the oven door. During cooking, especially under high humidity conditions, steam is given off from the food. (Some steam will condense on cooler surfaces, such as the oven door. This is normal.) Inside surface is covered with a heat and vapor barrier film. **Do not remove.**
5. **Oven Cavity Floor:** Clean the bottom surface of the oven with mild detergent, water or window cleaner, and dry.
6. **Waveguide Cover:** Do not remove Waveguide Cover. **It is important to keep cover clean in the same manner as the inside of the oven. Failure to do so may damage the cover.**
7. **Control Panel:** If the Control Panel becomes wet, clean it with a soft dry cloth. Do not use harsh detergents or abrasives. For some models: The Control Panel is covered with a removable protective film to prevent scratches during shipping. Small bubbles may appear under this film, so if this is the case, remove by applying masking or clear tape to an exposed corner and pull gently.
8. **Glass Tray:** Remove and wash in warm soapy water or in a dishwasher.
9. **Roller Ring:** Roller Ring may be washed in mild soapy water or dishwasher. These areas should be kept clean to avoid excessive noise.

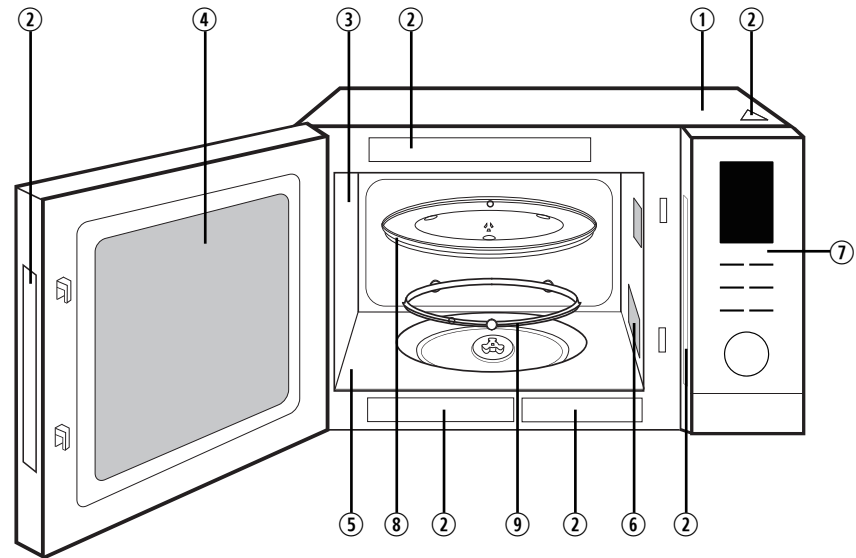

AS WITH ANY COOKING APPLIANCE, MICROWAVE OVENS REQUIRE THE SAME LEVEL OF CARE TO PREVENT OVERHEATING OR DAMAGE. IT IS IMPORTANT TO KEEP THE OVEN CLEAN AND DRY. FOOD RESIDUE AND CONDENSATION MAY CAUSE RUSTING OR ARCING AND DAMAGE TO THE OVEN. AFTER USE, WIPE DRY ALL SURFACES, INCLUDING VENT OPENINGS, OVEN SEAMS, AND UNDER GLASS TRAY.

NOTES:

1. After cooking, the oven should be cleaned with a soft cloth moistened with soapy water. If the oven is not cleaned occasionally to eliminate grease, it can accumulate and cause the oven to "Smoke" during use.
2. DO NOT SPRAY DIRECTLY INSIDE THE OVEN.
A steam cleaner is not to be used for cleaning.

Shop Accessories

Purchase Parts, Accessories and Instruction Books online for all Panasonic Products by visiting our Web Site at:
shop.panasonic.ca

Parts Available to Order

Owner's Manual (this book).....	F0003CD60AP
Glass Tray.....	F0601CD00BP
Roller Ring Assembly	F2181CD00BP
Wire Rack.....	F0602CD60AP
Enamel Tray.....	F0601BG60BP
Airfry Basket	F0603CD60AP

Before Requesting Service

See below before calling for service, as most problems can easily be remedied by following these simple solutions:

Problem	Solution
The oven causes TV interference.	Some radio, TV, Wi-Fi, cordless telephone, baby monitor, blue tooth or other wireless equipment interference might occur when you cook with the microwave oven. This interference is similar to the interference caused by small appliances such as mixers, vacuums, blow dryers, etc. It does not indicate a problem with your oven.
Steam accumulates on oven door and warm air comes from the oven vents.	During cooking, steam and warm air are given off from the food. Most of the steam and warm air are removed from the oven by the air which circulates in the oven cavity. However, some steam will condense on cooler surfaces such as the oven door. This is normal. After use, the oven should be wiped dry (see page 53).
Smoke and burnt smell will occur after the first use.	This is not a malfunction and will go away after a few uses.
Oven will not turn on.	The oven is not plugged in securely or needs to be reset; remove plug from outlet, wait ten seconds and re-insert. Main circuit breaker or main fuse is tripped or blown. Reset main circuit breaker or replace main fuse. There is a problem with the outlet; plug another appliance into the outlet to check if it is working.
Oven will not start cooking.	The door is not closed completely. Close the oven door securely. Start was not pressed after programming; Press dial to Start . Another program is already entered into the oven; press Stop/Reset to cancel the previous program and enter new program. The program is not correct; program again according to the Owner's manual. Stop/Reset has been pressed accidentally; program oven again.
The Glass Tray wobbles.	The Glass Tray is not positioned properly on the Roller Ring or there is food under the Roller Ring. Take out Glass Tray and Roller Ring. Wipe with a damp cloth and reset Roller Ring and Glass Tray properly..
When the oven is operating, there is noise coming from the Glass Tray.	The Roller Ring and oven bottom are dirty; clean these parts according to Care and Cleaning of Your Microwave Oven (see page 53).
The "🔒" appears in the display window.	The CHILD SAFETY LOCK was activated by pressing Stop/Reset three times; Deactivate CHILD SAFETY LOCK by pressing Stop/Reset three times.
The oven stops cooking and "SERVICE" appears in the display window.	The display indicates a problem with microwave generation system. Please contact an authorised Service Center (see next page).
"HOT INSIDE WAIT" appears in the display window.	The cavity is overheated. Operate again after it cools down. Please open the door in order to cool the temperature of the cavity more quickly.
"COOLING" appears in the display window.	The fan is operating to cool the electric components. The word "COOLING" will disappear after the fan stops.
"DEMO MODE PRESS ANY KEY" or "D" appears in the display window.	The oven is under demonstration mode. Press Microwave button once, Start 4 times and Stop/Reset button 4 times.

WARRANTY

Panasonic Canada Inc.
5770 Ambler Drive, Mississauga, Ontario L4W 2T3
Panasonic PRODUCT – LIMITED WARRANTY

Panasonic Canada Inc. warrants this product to be free from defects in material and workmanship under normal use and for a period as stated below from the date of original purchase agrees to, at its option either (a) repair your product with new or refurbished parts, (b) replace it with a new or a refurbished equivalent value product, or (c) refund your purchase price. The decision to repair, replace or refund will be made by Panasonic Canada Inc.

Category	Service type	Parts	Labour	Magnetron
Counter top microwave oven (except Prestige models)	Carry-in	1 Year	1 Year	Additional 4 Years (Part only)
Counter top microwave oven – Prestige model (Genius Prestige, Genius Prestige Plus and Genius Prestige Grill)	In-home	2 Years	2 Years	Additional 3 Years (Part only)
Microwave Convection oven	In-home	2 Years	2 Years	Additional 3 Years (Part only)
Over The Range (OTR) microwave oven	In-home	2 Years	2 Years	Additional 3 Years (Part only)

In-home Service will be carried out only to locations accessible by roads and within 50 km of an authorized Panasonic service facility.

This warranty is given only to the original purchaser, or the person for whom it was purchased as a gift, of a Panasonic brand product mentioned above sold by an authorized Panasonic dealer in Canada and purchased and used in Canada, which product was not sold "as is", and which product was delivered to you in new condition in the original packaging.

IN ORDER TO BE ELIGIBLE TO RECEIVE WARRANTY SERVICE HEREUNDER, A PURCHASE RECEIPT OR OTHER PROOF OF DATE OF ORIGINAL PURCHASE, SHOWING AMOUNT PAID AND PLACE OF PURCHASE IS REQUIRED

LIMITATIONS AND EXCLUSIONS

This warranty ONLY COVERS failures due to defects in materials or workmanship, and DOES NOT COVER normal wear and tear or cosmetic damage. The warranty ALSO DOES NOT COVER damages which occurred in shipment, or failures which are caused by products not supplied by **Panasonic Canada Inc.**, or failures which result from accidents, misuse, abuse, neglect, mishandling, misapplication, alteration, faulty installation, set-up adjustments, misadjustment of consumer controls, improper maintenance, power line surge, lightning damage, modification, introduction of sand, humidity or liquids, commercial use such as hotel, office, restaurant, or other business or rental use of the product, or service by anyone other than a Authorized Servicer, or damage that is attributable to acts of God.

Over-The-Range cooktop light bulbs are excluded from coverage under this warranty.

In the case where the microwave oven is built-in, the warranty will be voided if using a non-Panasonic trim kit.

THIS EXPRESS, LIMITED WARRANTY IS IN LIEU OF ALL OTHER WARRANTIES, EXPRESS OR IMPLIED, INCLUDING ANY IMPLIED WARRANTIES OF MERCHANTABILITY AND FITNESS FOR A PARTICULAR PURPOSE. IN NO EVENT WILL Panasonic Canada Inc. BE LIABLE FOR ANY SPECIAL, INDIRECT OR CONSEQUENTIAL DAMAGES RESULTING FROM THE USE OF THIS PRODUCT OR ARISING OUT OF ANY BREACH OF ANY EXPRESS OR IMPLIED WARRANTY. (As examples, this warranty excludes damages for lost time, travel to and from the Authorized Servicer, loss of or damage to media or images, data or other memory or recorded content. This list of items is not exhaustive, but for illustration only.)

In certain instances, some jurisdictions do not allow the exclusion or limitation of incidental or consequential damages, or the exclusion of implied warranties, so the above limitations and exclusions may not be applicable. This warranty gives you specific legal rights and you may have other rights which vary depending on your province or territory.

WARRANTY SERVICE

PRODUCT OPERATION ASSISTANCE

For product information and operation assistance, please visit our Support page: www.panasonic.ca/english/support

PRODUCT REPAIRS

Please locate your nearest Authorized Servicentre: panasonic.ca/english/support/servicentrelocator

IF YOU SHIP THE PRODUCT TO A SERVICENTRE

Carefully pack and send prepaid, adequately insured and preferably in the original carton.
Include details of the defect claimed, and proof of date of original purchase.

Specifications

Power Source.....	120 V, 60 Hz
Power Consumption	
Microwave.....	9.5 Amps, 1,110 W
Heater (Broil).....	11.4 Amps, 1,350 W
Heater (Convection).....	11.4 Amps, 1,350 W
Combination (Combo).....	11.4 Amps, 1,350 W
Cooking Power	
Microwave*.....	1,000 W
Heater (Broil).....	1,300 W
Heater (Convection).....	1,300 W
Operating Frequency.....	2,450 MHz
Outside Dimensions (W x H x D).....	22 1/16" x 13 33/64" x 17 23/32" (560 mm x 343 mm x 450 mm)
Oven Cavity Dimensions (W x H x D).....	14 31/32" x 9" x 15 23/64" (380 mm x 228.4 mm x 390 mm)
Net Weight.....	Approx. 39.1 lbs (17.7 kg)

*IEC Test procedure

Specifications subject to change without notice.

Trim Kit Information

Trim Kit for NN-CD87KS

Model Number.....	NN-TK81KC
Outside Dimensions (W x H).....	23 1/2" x 16 5/32" (596 mm x 410 mm)
Cabinet Opening (W x H x D).....	23 5/8" x 15 9/16" x 21" (600 mm x 395 mm x 533 mm)

User's Record

The serial number of this product may be found on the back side of the oven or on the left side of the control panel. You should note the model number and the serial number of this oven in the space provided and retain this book as a permanent record of your purchase for future reference.

Model No. _____

Serial No. _____

Date of Purchase _____