

Panasonic®

Integrated Telephone System

Operating Instructions

Model No. **KX-TSC11W**
KX-TSC11B

Pulse-or-tone dialing capability



KX-TSC11W

Caller ID Compatible

PLEASE READ BEFORE USE AND SAVE.

Panasonic World Wide Web address: <http://www.panasonic.com>
for customers in the USA or Puerto Rico

Preparation

Basic Operation

Advanced Operation

Useful Information

Before Initial Use

Please read **IMPORTANT SAFETY INSTRUCTIONS** on page 37 before use. Read and understand all instructions.

Thank you for purchasing your new Panasonic integrated telephone.

Caller ID, Call Waiting and Voice Mail Service, where available, are telephone company services. After subscribing to Caller ID, this phone will display a caller's name and phone number. Call Waiting Caller ID, which displays a second caller's name and phone number while the user is on another call, requires a subscription to both Caller ID and Call Waiting. After subscribing to Voice Mail Service, this phone's message-waiting display will be shown when there are messages in the mail box.

Attach your purchase receipt here.

For your future reference

Serial No.

Date of purchase

(found on the rear of the unit)

Name and address of dealer

Accessories (included)

To order replacement accessories, call 1-800-332-5368.

TTY users (hearing or speech impaired users) can call 1-866-605-1277.

Handset (p. 6)

Order No.

PQJXE0411Z (White)

PQJXE0401Z (Black)

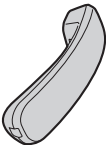

one

Handset Cord (p. 6)

Order No.

PQJA212M (White)

PQJA212N (Black)

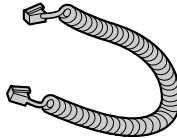

one

Telephone Line

Cord (p. 6)

Order No.

PQJA10075Z

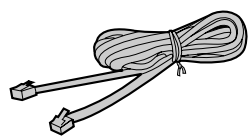

one

Contents

Preparation

Location of Controls	4
Display	5
Settings	6
Installing the Batteries	6
Connecting the Handset/ Telephone Line Cord	6
Programming Summary	7
Time and Date	8
Dialing Mode	10
LCD Contrast	11
Ringer Volume	11
Caller ID Number Auto Edit ..	12
Voice Mail Tone	13
Display Language	14

Basic Operation

Making Calls	15
Answering Calls	16
Caller ID Service	16
Using the Caller List	17
Viewing the Caller List	17
Calling Back from the Caller List	19
Editing the Caller's Phone Number	19
Storing Caller List Information in the Phone Book List	20
Erasing Caller List Information	21

Advanced Operation

Phone Book	22
Storing Names and Phone Numbers in the Phone Book List	22
Dialing from the Phone Book ..	25
Chain Dial	26
Editing	27
Erasing	28
Voice Mail Service	28
Listening to Voice Mail Message(s)	28
Special Features	29
Temporary Tone Dialing (For Rotary or Pulse Service Users)	29
How to Use the PAUSE Button (For PBX Line/Long Distance Calls)	29
For Call Waiting Service Users	29
Mute	30
FLASH Button	30
Setting the Password	31
Call Restriction	32

Useful Information

Wall Mounting	33
Battery Replacement	34
Troubleshooting	35
Important Safety Instructions ..	37
Specifications	39
FCC and Other Information ...	40
Index	42
Warranty	43
Customer Services	45

Location of Controls

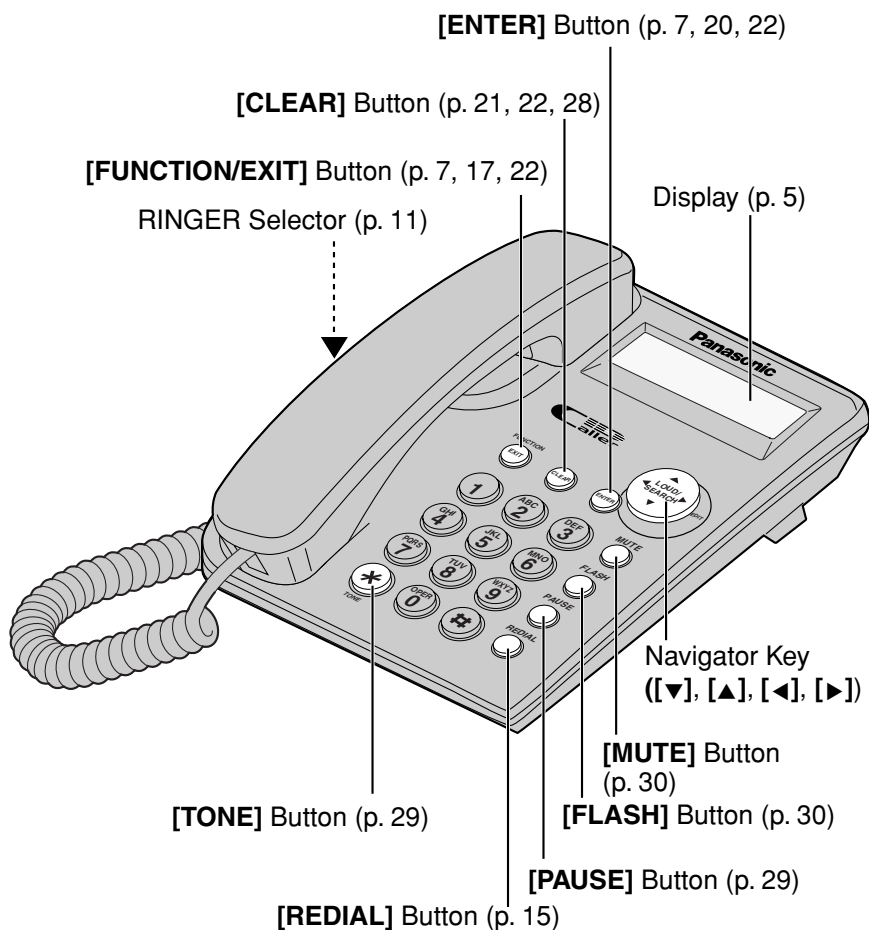

How to use the Navigator key

This key has four active areas that are indicated by arrows.



- Pressing the up and down arrows allows you to enter the Caller List and select the function menu, the Caller List and the Phone Book List. The up and down arrows are also used to adjust the receiver volume while talking.
- Pressing the right and left arrows allows you to enter the Phone Book List and move the cursor when entering items.

Throughout these Operating Instructions, the navigator key is indicated by the arrows [▼], [▲], [◀] or [▶].

Display

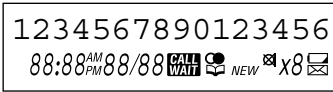

(This display shows all of the possible configurations.)



While the unit is not in use, the display shows the current time and date, and the number of new calls.

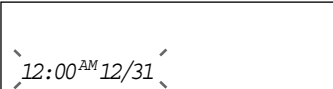

If the display continuously shows “12:00^{AM} 12/31” or “0:00 12/31”, the clock needs adjustment (p. 8, 9).

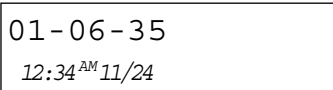

During a conversation, the display shows the length of the call (Ex. 1 hour, 6 minutes and 35 seconds).



This is a display from the Caller List. The display shows:

- the caller's name and number,
- the time and date of the last call (Ex. Nov. 23, 11:50 AM),
- the caller's information is new and has not been viewed (“NEW” is displayed), and
- the number of times called (Ex. 3 times).

☒ : [MUTE] was pressed during a conversation (p. 30).

CALL WAIT : The second call has been received while talking (p. 29).

📖 : The unit enters in the Phone Book List (p. 20).

🔴 : [REDIAL] was pressed while the handset is on the cradle (p. 15).

🔋 : This display flashes, when the battery power is low. Replace the batteries (p. 34).

✉ : The voice mail message(s) is/are recorded (p. 28).

P : [PAUSE] was pressed while dialing or storing phone numbers.

F : [FLASH] was pressed while storing phone numbers.

Settings

Installing the Batteries

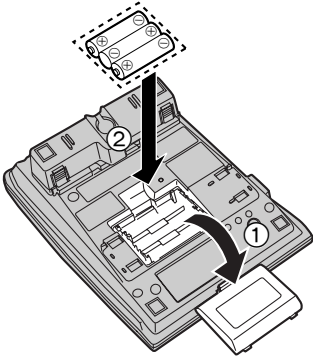

- 1 Press down in the direction of the arrow and remove the battery cover (①).
- 2 Install the batteries in the proper order as shown (②), matching the correct polarity.
- 3 Close the battery cover.

- Batteries are not included in the unit.
- Install three high quality "AA" size Alkaline (LR6) or Manganese (R6, UM-3) batteries. We recommend to use Panasonic Alkaline batteries.
Battery life is: —about six months in use of Alkaline batteries.
—about three months in use of Manganese batteries.
Battery life may depend on usage conditions and ambient temperature.
- Make sure batteries were inserted properly in phase to ensure the functionality of this unit.

THE UNIT MAY NOT WORK PROPERLY WITHOUT BATTERIES.

Connecting the Handset/Telephone Line Cord

After connection, lift the handset to check for a dial tone.

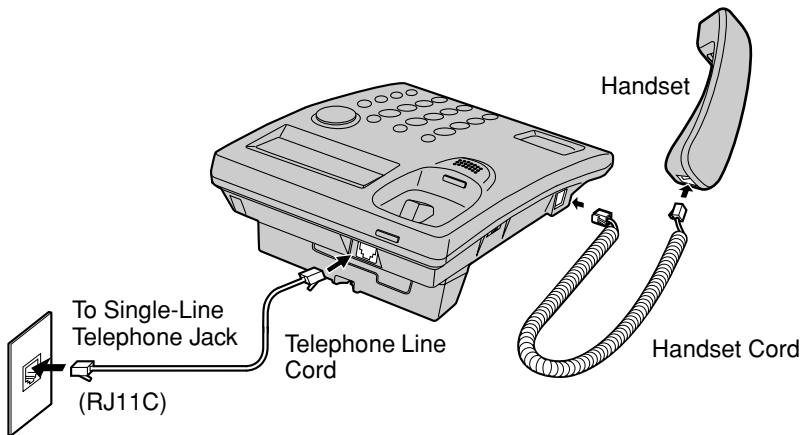



- Use only a Panasonic Handset for the KX-TSC11W or KX-TSC11B.
- Use only a telephone line cord included in the unit.
- If your unit is connected to a PBX which does not support Caller ID services, you cannot access those services.

Programming Summary

You can program the following functions. The display shows the programming instructions. See the corresponding pages for function details.

Make sure that the handset is on the cradle.

Press **[FUNCTION/EXIT]**.



<Function menu>*

SAVE PHONEBOOK ?	To store names and phone numbers in memory (p. 22).
SET CLOCK ?	To adjust the time and date (p. 8).
CHANGE PASSWORD?	To change the password for the call restriction (p. 31).
CALL RESTRICT ?	To set the call restriction (p. 32).
SET FLASH TIME ?	To select the flash time (p. 30).
SET DIAL MODE ?	To select the dialing mode (p. 10).
LCD CONTRAST ?	To select the LCD contrast (p. 11).
SET AUTO EDIT ?	To set the Auto Edit (p. 12)
VM TONE DETECT ?	To select the Voice Mail Tone detect (p. 13).
CHANGE LANGUAGE?	To select the display language (p. 14).

During programming

- * To select a desired function item, scroll through the items by pressing **[▼]** or **[▲]**. Then press **[ENTER]** to go to the next step.
- You can exit the programming mode any time by pressing **[FUNCTION/EXIT]**.
 - If you do not press any buttons for 60 seconds, the unit will exit the programming mode.

→ Settings

Time and Date

You can select AM/PM or 24-hour clock by programming.

Make sure that the handset is on the cradle.

1 Press [FUNCTION/EXIT].

2 Scroll to "SET CLOCK ?" by pressing [▼] or [▲].

SET CLOCK ?

3 Press [ENTER].

ENTER YEAR 2004
12:00^{AM}12/31

4 Enter the current year.
(Ex. To set 2004, enter "04".)
• You can set the year 2000 to 2099.

ENTER YEAR 2004
12:00^{AM}12/31

5 Press [ENTER].

ENTER TIME
12:00^{AM}12/31

6 Enter the current time (hour and minute) using a 4-digit number.
(Ex. To set 9:30, enter "0930".)
• For AM/PM setting: Enter numbers between 0100 and 1259.
• For 24-hour clock: Enter numbers between 0000 and 2359.

ENTER TIME
09:30^{AM}12/31

7 Press [ENTER].
• If numbers between 0000 and 0059, or 1300 and 2359 are entered, the time will automatically be set using the 24-hour clock. Go to the step 10.

#=AM/PM
09:30^{AM}12/31



8 Press [#] to select “AM”, “PM” or 24-hour clock.
(Ex. You select “PM”.)

= AM / PM
09:30_{PM} 12/31

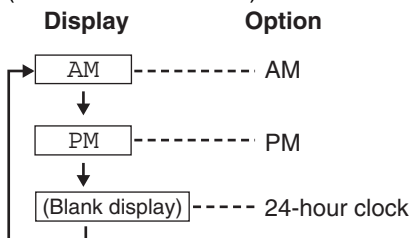

- Each time you press [#], the selection will change on the display.

9 Press [ENTER].

ENTER MONTH/DAY
09:30_{PM} 12/31

10 Enter the current day and month using a 4-digit number.
(Ex. To set Dec. 27, enter “1227”.)

ENTER MONTH/DAY
09:30_{PM} 12/27

11 Press [ENTER].

SAVED

- The clock starts working.
- The display will return to step 2. To exit the programming mode, press [FUNCTION/EXIT] or wait for 60 seconds.

- If the time and date entered are not correct, “ERROR” will be displayed and you cannot continue with setting. Enter the correct time and date.

If the batteries installed in the unit expired, the time and date will be shown as “12:00^{AM} 12/31” or “0:00 12/31” while talking or after the battery replacement. Readjust the time/date.

For Caller ID service users (p. 16)

If a time display service is available with the Caller ID service:
The Caller ID information will re-set the clock after the ring if the adjusted time and/or date is incorrect. However, if the time/date has not previously been set, the Caller ID information will not adjust the clock.

→ Settings

Dialing Mode

You can select the dialing mode by programming. If you have touch tone service, set to Tone. If rotary or pulse service is used, set to Pulse. Your phone comes from the factory set to Tone.

Make sure that the handset is on the cradle.

1 Press [FUNCTION/EXIT].

SAVE PHONEBOOK ?
⏪

2 Scroll to "SET DIAL MODE ?" by pressing [▼] or [▲].

SET DIAL MODE ?

3 Press [ENTER].

:TONE

4 Select "PULSE" or "TONE" by pressing [▼] or [▲].

5 Press [ENTER].

- The display will return to step 2. To exit the programming mode, press [FUNCTION/EXIT] or wait for 60 seconds.

SAVED

- You can exit the programming mode any time by pressing [FUNCTION/EXIT].



LCD Contrast

You can select the LCD contrast level from 1 to 4 by programming. Your phone comes from the factory set to 2.

Make sure that the handset is on the cradle.

- 1 Press [FUNCTION/EXIT].
- 2 Scroll to "LCD CONTRAST ?" by pressing [▼] or [▲].



- 3 Press [ENTER].
 - The current setting is displayed.



- 4 Select the desired contrast by pressing [▼] or [▲].
 - Each time you press [▼] or [▲], the LCD contrast will change.

- 5 Press [ENTER].
 - The display will return to step 2. To exit the programming mode, press [FUNCTION/EXIT] or wait for 60 seconds.



• You can exit the programming mode any time by pressing [FUNCTION/EXIT].

Ringer Volume

You can select the ringer volume to HIGH, LOW or OFF. Your phone comes from the factory set to HIGH.

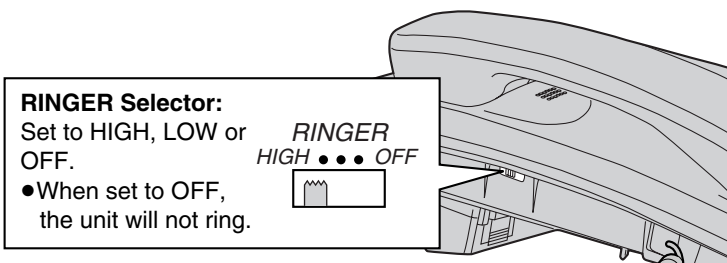

➔ Settings

Caller ID Number Auto Edit

Once you call back an edited number (p. 19), this unit can automatically edit incoming phone numbers from the same area code in the Caller List and each time you receive a call. For example, it can ignore the area code of calls originating from your area code, so that you can call these numbers from the Caller List without dialing the area code.

To activate this feature, you must edit a caller's phone number in the Caller List (p. 19) by selecting pattern **(a)**, **(b)**, or **(c)**, then make a call to that number. Calls from numbers in that area code will be edited automatically. The unit can remember up to 4 area codes to be edited according to patterns **(a)** and **(b)**.

When more than 5 area codes are edited, older area codes are reset to pattern **(c)**. Phone numbers from the 4 most recently edited area codes will be automatically edited. You can turn this feature on or off. The factory preset is ON.

To turn Caller ID Number Auto Edit ON or OFF

1 Press **[FUNCTION/EXIT]**.

2 Scroll to "SET AUTO EDIT ?" by pressing **[▼]** or **[▲]**.

SET AUTO EDIT ?

3 Press **[ENTER]**.

: ON

4 Select "OFF" or "ON" by pressing **[▼]** or **[▲]**.

5 Press **[ENTER]**.

SAVED

- If you fail to reach your destination when making a call, the phone number you dialed might have an incorrect pattern. Edit the phone number with another pattern (p. 19).
- When this feature is turned off, the unit will still be able to display Caller ID, but incoming Caller ID numbers will not be automatically edited.
- If you move to another area, you may need to turn this feature off to erase the previously edited area codes. To use this feature again, turn it on and reprogram the area codes you want to edit once again.



Voice Mail Tone

If your voice mail service sends a voice mail tone after a new message has finished recording, set to “ON”. “✉” icon will flash on the display if a message was recorded in your mailbox. You will hear a series of voice mail tones then a dial tone after lifting the handset.

(Contact your service provider about your service.)

Set to “OFF” when:

- you do not subscribe to a voice mail service.
- your voice mail service does not send a voice mail tone, or
- the unit is connected to a PBX.

Your phone comes from the factory set to “ON”.

Make sure that the handset is on the cradle.

1 Press [FUNCTION/EXIT].

SAVE PHONEBOOK ?



2 Scroll to “VM TONE DETECT ?” by pressing [▼] or [▲].

VM TONE DETECT ?

3 Press [ENTER].

: ON

4 Select “ON” or “OFF” by pressing [▼] or [▲].

5 Press [ENTER].

SAVED

- You can exit the programming mode any time by pressing [FUNCTION/EXIT].

→ Settings

Display Language

You can select “English”, “French” or “Spanish” as the display language. Your phone comes from the factory set to “English”.

Make sure that the handset is on the cradle.

1 Press [FUNCTION/EXIT].

SAVE PHONEBOOK ?
☞

2 Scroll to “CHANGE LANGUAGE?” by pressing [▼] or [▲].

CHANGE LANGUAGE?

3 Press [ENTER].

: ENGLISH

4 Select “ENGLISH”, “FRANCAIS” or “ESPANOL” by pressing [▼] or [▲].

5 Press [ENTER].

- The display will return to step 2. To exit the programming mode, press [FUNCTION/EXIT] or wait for 60 seconds.

SAVED

- You can exit the programming mode any time by pressing [FUNCTION/EXIT].

Making Calls

To make a call, this unit can dial up by 2 methods as below steps.

- 1 Enter a phone number, then lift the handset.
OR
Lift the handset, then dial a phone number.

- The dialed number is displayed.
- After a few seconds, the display will show the length of the call.
- If you misdial, hang up and start again from step 1.

1234567890
12:34_{PM}11/24

00-00-00
12:34_{PM}11/24

- 2 When finished talking, hang up.

To redial the last number dialed

Lift the handset → press **[REDIAL]**.

To redial using the redial list (Memory Redial)

The last 20 phone numbers dialed are stored in the redial list.

1. Press **[REDIAL]**.
 - The last number dialed and “●” are displayed.
 - When the dialed number has been stored in the Phone Book List, the name is displayed instead of the number. To see the number, press **[◀]**.
 2. Select the desired number by pressing **[▼]** or **[▲]**.
 - You can also select through the list by pressing **[REDIAL]**.
 - To exit the list, press **[FUNCTION/EXIT]**.
 3. Lift the handset.
 - The displayed phone number is dialed.
- To erase an item, repeat steps 1 and 2, and press **[CLEAR]**.
 - If “NO ITEMS STORED” is displayed, the list is empty.

To adjust the handset volume (4 levels) while talking

To increase, press **[▲]**.

To decrease, press **[▼]**.

- The display shows the volume level for a few seconds.

Ex. Handset volume level: 2

□□
12:34_{PM}11/24

Answering Calls

When a call is received, the unit rings, “INCOMING CALL” is displayed. If you subscribe to a Caller ID service, the calling party’s information will be displayed when the unit is ringing (see below).

- 1 When the unit rings, lift the handset.
- 2 When finished talking, hang up.

• When the ringer volume is set to OFF (p. 11), the unit will not ring.

Caller ID Service

This unit is compatible with a Caller ID service offered by your telephone company. If you subscribe to a Caller ID service, the calling party’s information will be displayed when the unit is ringing.

The unit can record information of up to 50 different callers, including the time and date received and the number of times called, in the Caller List. The Caller List information is sorted from the most recent to the oldest call. When the 51st call is received, the oldest call is deleted.

Using the list, you can automatically call back a caller. You can store the callers’ names and numbers, from the Caller List in the Phone book memory.

How caller information is displayed when a call is received

The display shows the caller’s name and phone number when the unit is ringing.*

- After you answer the call, the display will show the length of the call.

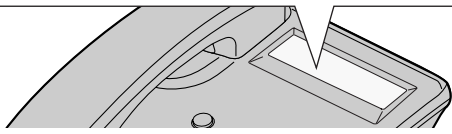
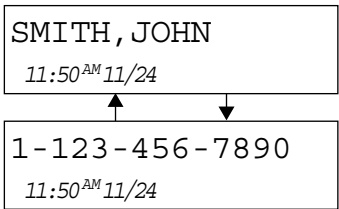

*Private Name Display

If you receive a call from one of the same phone numbers stored in the Phone Book List, the caller’s name will be displayed.

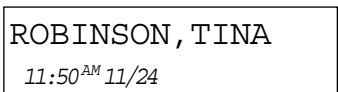

• To use this function, names and phone numbers must be stored in the Phone Book List (p. 22).

- Caller information will not be displayed in the following cases:
 - If the caller dialed from an area which does not provide a Caller ID service, the display will show “OUT OF AREA”.
 - If the caller has requested not to display his/her information, the display will show “PRIVATE CALLER”.
 - If a long distance call is identified and caller’s name and/or number cannot be received, the display will show “LONG DISTANCE”.
- If your unit is connected to a PBX which does not support Caller ID services, you cannot access those services.

- If the batteries installed in the unit have expired, Caller ID services will not be available.
- If the name and the time/date display service is available in your area, the display will show caller’s names and the time/date the calls were received. For further information, please contact your telephone company.

Using the Caller List

If you have received 10 new calls, the number of new calls will be displayed as shown, while the unit is not in use.

10 MISSED CALLS
12:34 PM 11/24

Viewing the Caller List

To check who has called, follow the steps below.

- 1 Press [▼] or [▲] to enter the Caller List.
- 2 To search from the most recent call, press [▼].
 - To search from the oldest call, press [▲].
 - To scroll between callers, press [▼] or [▲].
- 3 To exit the Caller List, press [FUNCTION/EXIT].

SMITH, JOHN
11:50 AM 11/24 NEW

- If “NO ITEMS STORED” is displayed, the Caller List is empty.
- If more than one call is received from the same caller, the date and time of the most recent call will be recorded.

→ Using the Caller List

Ex. When you search from the most recent call:

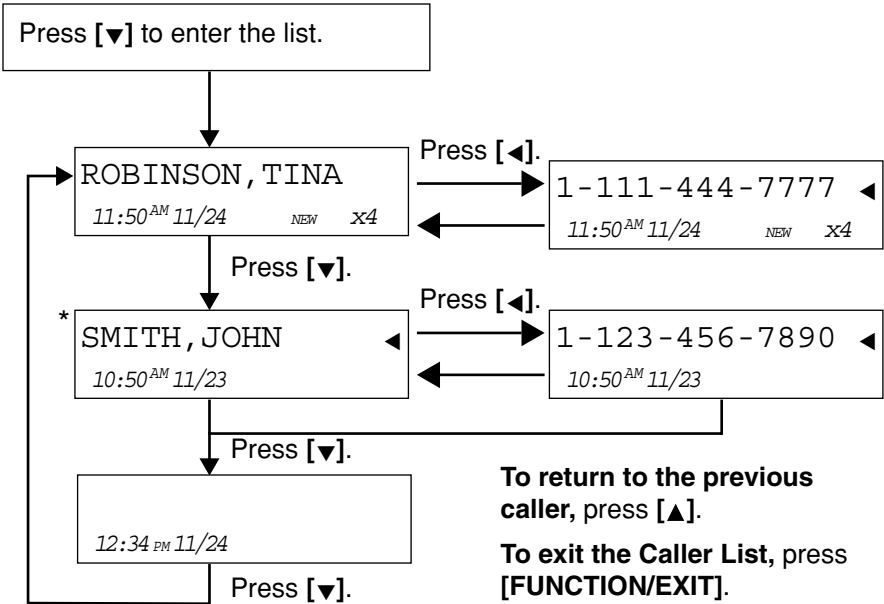

* If you receive a call from one of the same phone numbers stored in the Phone Book List, the caller's name will be displayed (**Private name display**). To see the phone number, press [◀]. Each time you press [◀], the display will change alternately.

Display meaning:

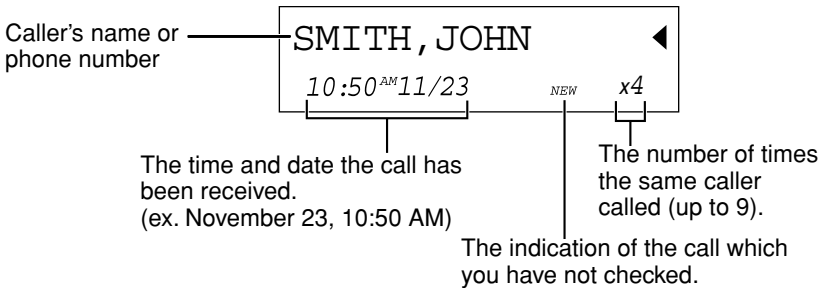



Calling Back from the Caller List

1 Press [▼] or [▲] to enter the Caller List.

2 Scroll to the desired caller by pressing [▼] or [▲].

SMITH, JOHN ◀
10:50^{AM} 11/23

- To exit the Caller List, press [FUNCTION/EXIT] or wait for 60 seconds.

3 Lift the handset.

- The displayed phone number is dialed automatically.
- After a few seconds, the display will show the length of the call.

1234567890
10:50^{AM} 11/24

00-00-00
10:50^{AM} 11/24

- In some cases, you may have to edit the number before dialing (see below).
- If a phone number is not displayed in the caller information, you cannot call back that caller.

Editing the Caller's Phone Number

You can edit a phone number in the Caller List by removing its area code and/or the long distance code "1".

Once you call back an edited number, this unit can automatically edit incoming phone numbers from the same area code in the Caller List and each time you receive a call (**Caller ID Number Auto Edit**, page 12).

1 Press [▼] or [▲] to enter the Caller List.

2 Scroll to the desired caller by pressing [▼] or [▲].

SMITH, JOHN ◀
10:50^{AM} 11/23 NEW x4

3 Press [◀].

4 Press [▶] repeatedly until the number is shown in the desired format.

- Each time you press [▶], the number is rearranged into one of 3 patterns.

- (a) Phone no.
- (b) Area code – Phone no.
- (c) 1– Area code – Phone no.

- The order in which patterns (a) – (c) are displayed depends on how the telephone number is displayed in step 2.

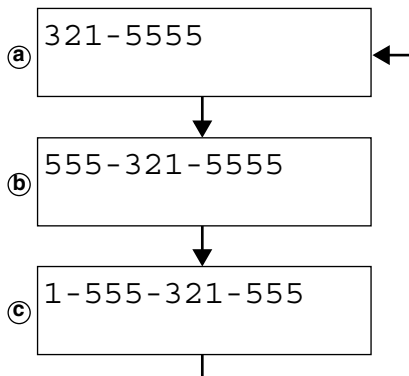

→ Using the Caller List

- 5 After editing, you can continue with calling back or storing procedures.
- To call back, lift the handset.
 - To store the number in the Phone book memory, follow steps 4 to 5 on page 20 to complete the operation.
 - If Caller ID Number Auto Edit is turned on (factory preset is on), phone numbers with the same area code as the number you edited will now be updated in the Caller List and each time you receive a call.
 - **To save the edited number into the Phone Book, press [ENTER].**
- To exit the Caller List during editing, press [FUNCTION/EXIT] or wait for 60 seconds.

Storing Caller List Information in the Phone Book List

You can store numbers in the Caller List to the Phone Book List.

Make sure that the handset is on the cradle.

- 1 Press [▼] or [▲] to enter the Caller List.

- 2 Scroll to the caller you want to store by pressing [▼] or [▲].

SMITH, JOHN
10:50 ^{AM} 11/23 <small>NEW</small> x4

- 3 Press [ENTER].
- If the number requires editing, see page 19.

1-123-456-7890

- 4 Press [ENTER].

If there is no name information for the caller, "ENTER NAME" will be displayed.

SMITH, JOHN

- a) If a name is required, enter the name (p. 24). When finished, go to step 5.
- b) If a name is not required, go to step 5.

If there is name information for the caller, you can edit name information.

- a) If you need to change the name, enter the name (p. 24). When finished, go to step 5.
- b) If you do not need to change the name, go to step 5.

5 Press [ENTER].

- After a few seconds, the display will return to the Caller List. You can continue storing other items. To exit the Caller List, press [FUNCTION/EXIT] or wait for 60 seconds.

SAVED

⏪

- If the display shows “PHONEBOOK FULL” in step 4, press [FUNCTION/EXIT] to exit the list. To erase other stored items from the Phone Book List, see page 28.
- To cancel during programming, press [FUNCTION/EXIT]. Start again from step 1.
- You cannot store caller information in the Phone Book List if a phone number is not displayed.

Erasing Caller List Information

After checking the Caller List, you can erase some or all of the entries.

Make sure that the handset is on the cradle.

To erase a specific caller from the Caller List

1 Press [▼] or [▲] to enter the Caller List.

2 Scroll to the caller you want to erase by pressing [▼] or [▲].

SMITH, JOHN ◀

10:50^{AM} 11/23

3 Press [CLEAR].

- The information is erased.
- After a few seconds, the display will show the previous caller information.
- To exit the Caller List, press [FUNCTION/EXIT] or wait for 60 seconds.

ERASED

To erase all entries in the Caller List

1 Press [CLEAR].

- To stop erasing, press [FUNCTION/EXIT].

ALL ERASE ?

2 Press [ENTER].

- All entries are erased.
- The unit will exit the Caller List.

ALL ERASED

Phone Book

Storing Names and Phone Numbers in the Phone Book List

You can store up to 50 names and phone numbers in memory.

Make sure that the handset is on the cradle.

- 1 Press **[FUNCTION/EXIT]**.

SAVE PHONEBOOK ?



- 2 Press **[ENTER]**.

- After a few second the display will change.

12 ITEMS STORED



- 3 Enter a name, up to 15 characters with the dialing buttons (p. 24).

- To move the cursor while entering name, press **[◀]** or **[▶]**.
- If a name is not required, press **[ENTER]** and go to step 5.

ENTER NAME



- 4 Press **[ENTER]**.

- If you want to return to step 3 for editing, press **[▲]**.

ENTER PHONE NO .



- 5 Enter a phone number up to 22 digits.

- If you entered a wrong number, press **[CLEAR]** and enter the correct number.
- To move the cursor while entering number, press **[◀]** or **[▶]**.

1234567890 





6 Press [ENTER].

- To continue storing other items, repeat from step 2.
- The display will return to step 1. To exit the programming mode, press **[FUNCTION/EXIT]** or wait for 60 seconds.

SAVED



- If the display shows “PHONEBOOK FULL” in step 2, press **[FUNCTION/EXIT]** to exit. To erase other stored items from the Phone Book List, see page 28.
- You can exit the programming mode any time by pressing **[FUNCTION/EXIT]**.
- If a pause is required for dialing, press **[PAUSE]** where needed. If required, you can also store **[FLASH]** in a phone number. Pressing **[PAUSE]** or **[FLASH]** counts as one digit (p. 29, 30).
- To store numbers for calling card access (see “Chain Dial” on page 26), we recommend you add pauses after each item. Storing pauses with numbers will prevent misdialing (p. 29). The delay time necessary will depend on your telephone company.
- When using the Call Restriction feature (p. 32), you cannot store the emergency number in the Phone Book.
- If the display shows “CALL RESTRICTED” in step 4, you cannot store the emergency number in the Phone Book. See page 32.
- When storing a name, you can also enter space by pressing **[0]** twice. Items with space at the beginning will be displayed with first priority. See page 25.

To store an emergency number:

When storing a name in step 3 on page 22, enter # at the beginning of the name by pressing **[#]**. See page 24.

- Items with # at the beginning will be displayed with first priority if CALL RESTRICTION is set to ON. See page 32.

➔ Phone Book

Selecting characters to enter names

The dialing buttons ([0] to [9]) can be used to enter letters and symbols. Pressing each button selects a character as shown below.

Keys	Number of times key is pressed								
	1	2	3	4	5	6	7	8	9
[1]	&	'	()	,	-	.	/	1	
[2]	A	B	C	2					
[3]	D	E	F	3					
[4]	G	H	I	4					
[5]	J	K	L	5					
[6]	M	N	O	6					
[7]	P	Q	R	S	7				
[8]	T	U	V	8					
[9]	W	X	Y	Z	9				
[*]	*								
[0]	0	Space							
[#]	#								
[◀]	To move the cursor to the left								
[▶]	To move the cursor to the right								

If you make a mistake while entering a name

Use [◀] or [▶] to move the cursor to the incorrect character, press [CLEAR] to delete and enter the correct character. Each time you press [CLEAR], a character is erased.

For example, to enter "TOM JONES":

- 1 Press [8].
- 2 Press [6] three times, then press [▶].
- 3 Press [6] once, then press [▶] twice.
- 4 Press [5], press [6] three times, then press [▶].
- 5 Press [6] twice, press [3] twice, then press [7] four times.

T
TO
TOM
TOM JO
TOM JONES



Dialing from the Phone Book

Make sure that the handset is on the cradle.

1 Press [◀] or [▶] to enter the Phone Book List.



2 Scroll to the desired item by pressing [▼] or [▲].

- All Phone book items are stored in the order shown on the right.

To search for a name by initial:

1. Press the dialing button for the first letter of the desired name until any name with the same initial is displayed (see the Index table on page 26).
Ex. To find "Frank", press [3] repeatedly until the first item under "F" is displayed.

2. Press [▼] repeatedly until the name is displayed.

- Items with # at the beginning will be displayed with first priority if CALL RESTRICTION is set to ON.

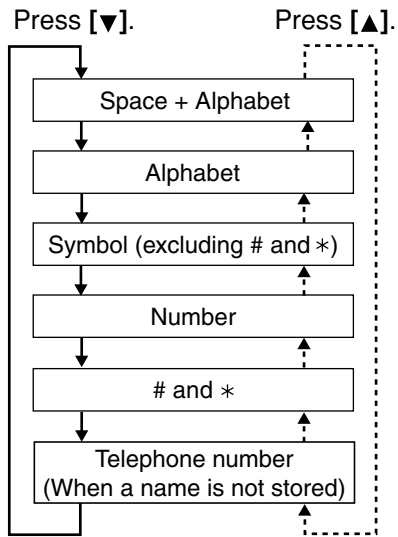

3 Lift the handset.

- The number is dialed automatically.

4 To hang up, place the handset on the cradle.

- If "NO ITEMS STORED" is displayed in step 1, the Phone Book is empty.
- You can exit the Phone Book List any time by pressing [FUNCTION/EXIT].
- You can also dial the stored number as follows:
 1. Lift the handset.
 2. Find the desired item (above step).
 3. Press [ENTER].
- If there is no battery, this function will not operate.

➔ Phone Book

Index table

Keys	Index	Keys	Index
[1]	Symbols, 1	[7]	P, Q, R, S, 7
[2]	A, B, C, 2	[8]	T, U, V, 8
[3]	D, E, F, 3	[9]	W, X, Y, Z, 9
[4]	G, H, I, 4	[*]	*
[5]	J, K, L, 5	[0]	0, Space
[6]	M, N, O, 6	[#]	#

Chain Dial

You can dial a combination of the Phone Book or manual key pad entries while making a call. This feature can be used, for example, to first automatically dial a calling card access number that you have stored in the Phone Book, then manually or automatically dial your PIN and then automatically dial the destination number from the Phone Book.

Ex. Using a long distance calling card

- To prevent misdialing, we recommend you add pauses where needed when storing numbers. For example, add pauses after a calling card access number and your PIN when storing in the Phone Book (p. 23).
1. Search and dial from the Phone Book: **18000123456** (Calling card access number)
 - The voice guidance may be announced.
 2. Search and dial from the Phone Book: 1234 (Calling card PIN)
 3. Search and dial from the Phone Book: **15550123456** (Destination number)

1 While you are on a call;
Press [◀] or [▶].

2 Search for the desired item by pressing [▼] or [▲].

- To search for an item by initial, see page 25.

3 Press [ENTER].

- The phone number is dialed.
- If required, repeat steps 1 to 3 for any remaining numbers.

- If you have rotary or pulse service, you need to press [*] before pressing [◀] or [▶] in step 1 to change the dialing mode temporarily to tone.



Editing

Make sure that the handset is on the cradle.

1 Press [**◀**] or [**▶**] to enter the Phone Book List.

2 Scroll to the Phone Book item you want to change by pressing [**▼**] or [**▲**].

- To search for the item by initial, see page 25.

JANE ▶

3 Press [**▶**] or [**ENTER**].

- If you do not need to change the name, go to step 5.

JANE

4 Edit the name using the dialing buttons (p. 24).

- To clear an incorrect character, move the cursor to the character by using [**◀**] or [**▶**], then press [**CLEAR**].

5 Press [**ENTER**].

To add a number

Add a number to the current number.

00123456789

To erase a number

Press [**CLEAR**] to erase the number.

- To move the cursor, press [**◀**] or [**▶**].

6 Press [**ENTER**].

- To continue editing other items repeat from step 2.

➔ Phone Book

Erasing

Make sure that the handset is on the cradle.

- 1 Press [◀] or [▶] to enter the Phone Book List.
- 2 Scroll to the Phone Book item that you want to erase by pressing [▼] or [▲].
 - To search for the item by initial, see page 25.
- 3 Press [CLEAR].
 - To stop erasing, press [◀].
- 4 Press [ENTER].
 - To erase other items, repeat from step 2.
 - To exit the Phone Book List, press [FUNCTION/EXIT].

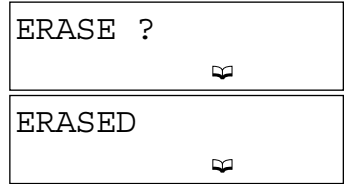

Voice Mail Service

Voice mail service is an electronic on-line answering system offered by your telephone company. After subscribing, the voice mail system can answer calls automatically when your line is busy or if calls are not answered. Callers can leave messages by following the pre-recorded instructions. When voice mail messages will be recorded, "VOICE MAIL"* will be displayed and "☒" will be displayed.

*The message "VOICE MAIL" will appear only when no new call exists in the caller list.

Listening to Voice Mail Message(s)

After receiving a voice mail message, "☒" will flash on the display. To listen to your voice mail, perform the following steps.

- 1 Lift the handset and dial an access phone number.
 - You will get an access phone number from your telephone company.
- 2 Follow the pre-recorded instructions.
- 3 When finished, place the handset on the cradle.
 - "☒" will go out.

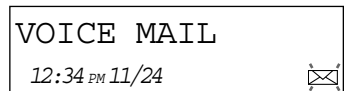

- If "☒" still flash after you have listened to your voice mail message(s), press [FUNCTION/EXIT], and then press and hold [CLEAR]. "VOICE MAIL" and "☒" will disappear.

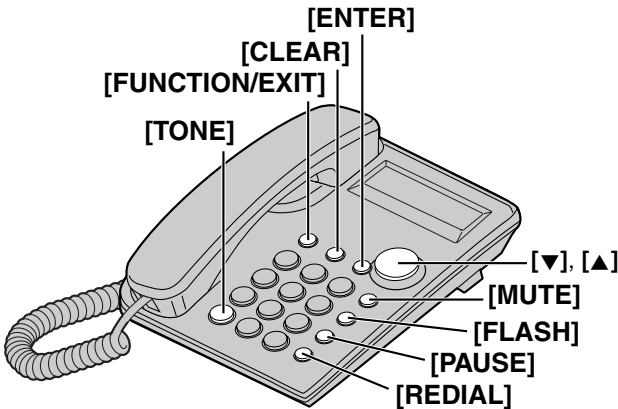

Temporary Tone Dialing

(For Rotary or Pulse Service Users)

Press **[TONE]** before entering access numbers which require tone dialing.

- The dialing mode changes to tone. You can enter numbers to access an answering service, electronic banking service, etc. When you hang up, the mode will return to pulse.

How to Use the PAUSE Button

(For PBX Line/Long Distance Calls)

We recommend you press **[PAUSE]** if a pause is required for dialing with a PBX or to make a long distance call.

Ex. Line access number **[9]** (PBX)

[9] → **[PAUSE]** → Phone number

- Pressing **[PAUSE]** once creates a 3.5 second pause. This prevents misdialing when you redial or dial a stored number.
- Pressing **[PAUSE]** more than once increases the length of the pause between numbers.

For Call Waiting Service Users

Press **[FLASH]** if you hear a call-waiting tone while talking.

- The first call is put on hold and you can answer the second call.
- To return to the first caller, press **[FLASH]** again.
- The call waiting service cannot be used when a parallel connected telephone is in use.
- If this function does not operate properly, consult your telephone company for details.

→ Special Features

Call Waiting Caller ID Feature

Call Waiting Caller ID Feature allows your unit to display the second caller's information. After you hear a call-waiting tone while talking, the unit will display the caller's phone number and "CALL WAIT".

- Please contact your telephone company for details and availability in your area.

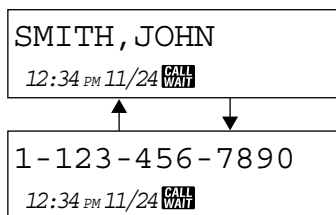

Mute

Press **[MUTE]** while talking. "☒" will be displayed.

- The other party cannot hear you but you can hear them.
- To resume the conversation, press **[MUTE]** again.

FLASH Button

Pressing **[FLASH]** allows you to use special features of your host PBX such as transferring an extension call or accessing special telephone services (optional) such as call waiting.

Selecting the flash time

The flash time depends on your telephone exchange or host PBX. You can select the following flash times: "80, 90, 100, 110, 200, 250, 300, 400, 600, 700 ms (milliseconds)". Your phone comes from the factory set to "600 ms".

Make sure that the handset is on the cradle.

- 1 Press **[FUNCTION/EXIT]**.
- 2 Scroll to "SET FLASH TIME ?" by pressing **[▼]** or **[▲]**.

SET FLASH TIME ?

- 3 Press **[ENTER]**.

: 600MS

- 4 Select the desired time by pressing **[▼]** or **[▲]**.

- 5 Press **[ENTER]**.

SAVED

- The display will return to step 2. To exit the programming mode, press **[FUNCTION/EXIT]** or wait for 60 seconds.

- You can exit the programming mode any time by pressing **[FUNCTION/EXIT]**.
- If the unit is connected via a PBX, PBX functions (transferring a call, etc.) might not work correctly. Consult your PBX supplier for the correct setting.
- If there is no battery, Flash function may not operate appropriately.



Setting the Password

You can change the password for the call restriction.
The factory preset password is "1111".

To set the password

Make sure that the handset is on the cradle.

1 Press **[FUNCTION/EXIT]**.

2 Scroll to "CHANGE PASSWORD?" by pressing **[▼]** or **[▲]**.

CHANGE PASSWORD?

3 Press **[ENTER]**.

CURRENT PASSWORD

4 Enter the current password.

: ***✖

5 Press **[ENTER]**.

- If the wrong password was entered at step 4, "ERROR" will be displayed, then "----" will be displayed. Enter the correct password.

NEW PASSWORD

6 Enter a new password using a 4-digit number. (Ex. "1234" is entered.)

: 1234✖

7 Press **[ENTER]**.

- The display will return to step 2. To exit the programming mode, press **[FUNCTION/EXIT]** or wait for 60 seconds.

SAVED

- You can exit the programming mode any time by pressing **[FUNCTION/EXIT]**.

Please write down your password. If you forget your password, consult your nearest Panasonic service center.

➔ Special Features

Call Restriction

You can prevent the unit from dialing phone numbers beginning with specified digit(s) (1 digit or 2 digits). Phone numbers with the restricted leading digits cannot be dialed out except the emergency numbers stored in the Phone Book.

To set the call restriction

Make sure that the handset is on the cradle.

- 1 Press **[FUNCTION/EXIT]**.
- 2 Scroll to "CALL RESTRICT ?" by pressing **[▼]** or **[▲]**.

CALL RESTRICT ?

- 3 Press **[ENTER]**.

RESTRICT NO. : 

If you changed the password "1111" (factory set), the display on the right will be shown. Follow below steps 1 and 2.

1. Enter the password (p. 31).
2. Press **[ENTER]**. Go to step 4.
 - If the wrong password was entered, "ERROR" will be displayed, then "----" will be displayed. Enter the correct password.

ENTER PASSWORD

: ***

- 4 Enter the number(s) (1 digit or 2 digits) you want to restrict (**[0]** to **[9]**).
 - If the wrong number was entered, press **[CLEAR]** and enter the correct number.

RESTRICT NO. : 

- 5 Press **[ENTER]**.
 - The display will return to step 2. To exit the programming mode, press **[FUNCTION/EXIT]** or wait for 60 seconds.

SAVED

- When dialing a phone number with the restricted leading digit(s), "CALL RESTRICTED" is displayed.
- If the display shows "CALL RESTRICTED", you cannot store the emergency numbers in the Phone Book.

To cancel the call restriction

Follow steps 1 through 3. In step 4, press **[CLEAR]** to clear the restricted digits, and press **[ENTER]**.

Wall Mounting

This unit can be mounted on a wall phone plate.

- 1 Press the tabs in the direction of the arrows (①), then remove the wall mounting adaptor (②).

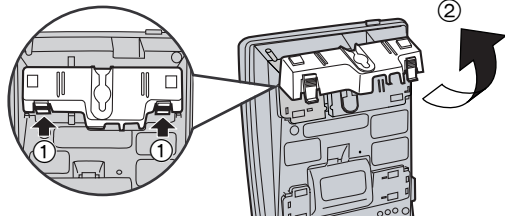

- 2 Tuck the telephone line cord inside the wall mounting adaptor, and push it in the direction of the arrow (① and ②).

- The word "UP WALL" should face upward.

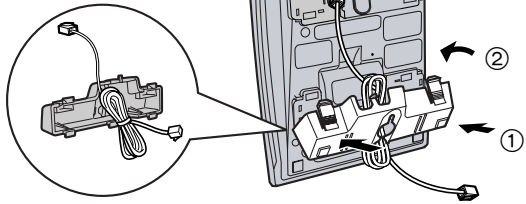

- 3 Connect the telephone line cord. Mount the unit, and slide down.

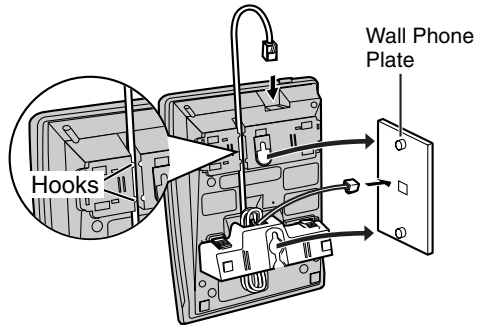

- 4 Adjust the LCD contrast level for best view (p. 11).

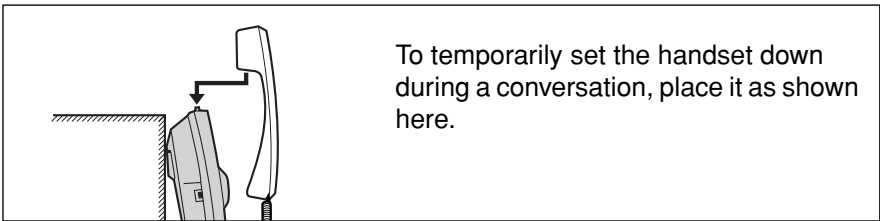

To temporarily set the handset down during a conversation, place it as shown here.

Battery Replacement

If “□” flashes, the battery power is low. Install new batteries as soon as possible. If batteries are not replaced even after the “□” is displayed, the unit may not work properly.

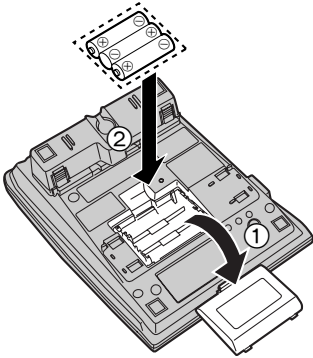

- 1 Disconnect the telephone line cord from the unit.
- 2 Press down in the direction of the arrow and remove the battery cover (①).
- 3 Replace the batteries with new ones using correct polarity (+, -) (②), and close the battery cover.
- 4 Connect the telephone line cord to the unit.

- After the battery replacement, the information stored in the Redial List will be cleared. Store the desired item in the Phone Book List and Caller List.
- The time will be shown as “12 : 00^{AM} 12/31” or “0 : 00 12/31” after replacing the batteries, readjust the time and date.

Battery Precautions:

The batteries should be used correctly, otherwise the unit may be damaged by battery leakage.

- Do not mix different types of batteries.
- Do not charge, short-circuit, disassemble, heat or dispose of in fire.
- Remove all the batteries when replacing.

Note:

- If you do not install the batteries or if the battery power is low, the time will be shown as “12 : 00^{AM} 12/31” or “0 : 00 12/31”. Readjust the time and date after the battery replacement.
- Replace all the batteries every six months if using Alkaline batteries, or misoperation may occur. (When you use Manganese batteries, replace all of them every three months.)
- Do not use nickel-cadmium batteries.

Troubleshooting



Problem	Cause and Remedy	
The unit does not work.	<ul style="list-style-type: none">• Check the settings (p. 6 – 14).• Remove the batteries and reinstall them to reset the unit.	
The unit does not ring.	<ul style="list-style-type: none">• The ringer selector is set to OFF. Set to HIGH or LOW (p. 11).	
The display is blank.	<ul style="list-style-type: none">• Install new batteries (p. 34).	
You cannot dial.	<ul style="list-style-type: none">• Check that the dialing mode selection is correct (p. 10).• The dialed number is restricted. To cancel, see page 32.	
The other party suddenly cannot hear your voice during a conversation.	<ul style="list-style-type: none">• [MUTE] may have been pressed during the conversation. If “You cannot program items such as the dialing mode.	<ul style="list-style-type: none">• Programming is not possible when the handset is off the cradle.• Do not pause for over 60 seconds while programming.
You cannot store a name and phone number in memory.	<ul style="list-style-type: none">• When using the Call Restriction feature (p. 32), you cannot store an emergency number in the Phone Book List.• If “PHONEBOOK FULL” is displayed, erase other stored items from the Phone Book List (p. 28).• Programming is not possible when the handset is off the cradle.• Check that the batteries are installed in the unit and that the battery power is not low.• Do not pause for over 60 seconds while storing.• Do not enter a phone number more than 22 digits long.	
While programming or searching, the unit starts to ring and stops the program/search.	<ul style="list-style-type: none">• To answer the call, lift the handset. Start again from the beginning after hanging up.	

→ Troubleshooting

Problem	Cause and Remedy
The unit does not display the caller's phone number.	<ul style="list-style-type: none">• You need to subscribe to a Caller ID service.• Install or replace the batteries.• Other telephone equipment may be interfering with your phone. Disconnect it and try again.• Telephone line noise may be interfering with the Caller ID information. Consult your telephone company.• Generally caller information is displayed from the 2nd ring.
The display exits the Caller List.	<ul style="list-style-type: none">• Do not pause for over 60 seconds while searching.
You cannot redial by pressing [REDIAL] .	<ul style="list-style-type: none">• If the last number dialed was more than 32 digits long, the number will not be redialed correctly.
Information stored in the Redial List is erased.	<ul style="list-style-type: none">• If “” flashes, replace the batteries as soon as possible. Otherwise, information stored in the Redial List may be erased. Store the desired item in the Phone Book List, if necessary.

Important Safety Instructions

When using this unit, basic safety precautions should always be followed to reduce the risk of fire, electric shock, or personal injury.

1. Read and understand all instructions.
2. Follow all warnings and instructions marked on this unit.
3. Unplug this unit from wall outlets before cleaning. Do not use liquid or aerosol cleaners. Use a damp cloth for cleaning.
4. Do not use this unit near water, for example, near a bathtub, washbowl, kitchen sink, or the like.
5. Place this unit securely on a stable surface. Serious damage and/or injury may result if the unit falls.
6. Do not cover slots and openings on the unit. They are provided for ventilation and protection against overheating. Never place the unit near radiators, or in a place where proper ventilation is not provided.
7. Do not place objects on the power cord. Install the unit where no one can step or trip on the cord.
8. Do not overload wall outlets and extension cords. This can result in the risk of fire or electric shock.
9. Never push any objects through slots in this unit. This may result in the risk of fire or electric shock. Never spill any liquid on the unit.
10. To reduce the risk of electric shock, do not disassemble this unit. Take the unit to an authorized servicenter when service is required. Opening or removing covers may expose you to dangerous voltages or other risks. Incorrect reassembly can cause electric shock when the unit is subsequently used.
11. Unplug this unit from the wall outlet and refer servicing to an authorized servicenter when the following conditions occur:
 - A. When the power supply cord or plug is damaged or frayed.
 - B. If liquid has been spilled into the unit.
 - C. If the unit has been exposed to rain or water.
 - D. If the unit does not work normally by following the operating instructions. Adjust only controls covered by the operating instructions. Improper adjustment may require extensive work by an authorized servicenter.
 - E. If the unit has been dropped or physically damaged.
 - F. If the unit exhibits a distinct change in performance.
12. During thunderstorms, avoid using telephones except cordless types. There may be a remote risk of an electric shock from lightning.
13. Do not use this unit to report a gas leak, when in the vicinity of the leak.

SAVE THESE INSTRUCTIONS

WARNING:

TO PREVENT FIRE OR SHOCK HAZARD, DO NOT EXPOSE THIS PRODUCT TO RAIN OR ANY TYPE OF MOISTURE.

→ Important Safety Instructions

CAUTION:

To reduce the risk of fire or injury to persons, read and follow these instructions.

1. Use only the battery(ies) specified.
2. Do not dispose of the battery(ies) in a fire. It (they) may explode.
3. Do not open or mutilate the battery(ies). Released electrolyte is corrosive and may cause burns or injury to the eyes or skin. The electrolyte may be toxic if swallowed.
4. Exercise care in handling the battery(ies) in order not to short the battery(ies) to conductive materials such as rings, bracelets, and keys. The battery(ies) and/or conductor may overheat and cause burns.
5. Do not recharge the battery(ies) provided with or identified for use with this product. The battery(ies) may leak corrosive electrolyte or explode.
6. Do not attempt to rejuvenate the battery(ies) provided with or identified for use with this product by heating. Sudden release of battery electrolyte may occur causing burns or irritation to the eyes or skin.
7. Replace all batteries at the same time. Mixing fresh and discharged batteries could increase internal cell pressure and rupture the discharged batteries. (Applies to products employing more than one separately replaceable primary battery.)
8. When installing batteries observe the proper polarity or direction. Incorrect installation can cause charging, and may result in leakage or explosion. (Applies to products employing more than one separately replaceable primary battery.)
9. Remove the battery(ies) from this product if the product will not be used for a long period of time (several months or more). During this time the battery(ies) could leak in the product.
10. Discard the dead battery(ies) as soon as possible. The dead battery(ies) may leak in the product.
11. Do not store this product, or the battery(ies) provided with or identified for use with this product, in high temperature areas. Batteries that are stored in a freezer or refrigerator for the purpose of extending shelf life should be protected from condensation during storage and defrosting. Batteries should be stabilized at room temperature prior to use after cold storage.

Specifications

Power Source:	From 3 AA (R6, UM-3, LR6) batteries
Dimensions (H x W x D):	Approx. 96 mm x 150 mm x 200 mm (3 ²⁵ / ₃₂ " x 5 ²⁹ / ₃₂ " x 7 ⁷ / ₈ ")
Mass (Weight):	Approx. 550 g (1.21 lb.)
Dialing Mode:	Tone (DTMF)/Pulse
Operating Environment:	5 °C – 40 °C (41 °F – 104 °F)

Specifications are subject to change without notice.

FCC and Other Information

This equipment complies with Part 68 of the FCC rules and the requirements adopted by the ACTA. On the bottom of this equipment is a label that contains, among other information, a product identifier in the format US:ACJ-----. If requested, this number must be provided to the telephone company.

Registration No. (found on the bottom of the unit)
Ringer Equivalence No. (REN) 1.0B

A plug and jack used to connect this equipment to the premises wiring and telephone network must comply with the applicable FCC Part 68 rules and requirements adopted by the ACTA. A compliant telephone cord and modular plug is provided with this product. It is designed to be connected to a compatible modular jack that is also compliant.

The REN is used to determine the number of devices that may be connected to a telephone line. Excessive RENs on a telephone line may result in the devices not ringing in response to an incoming call. In most but not all areas, the sum of RENs should not exceed five (5.0). To be certain of the number of devices that may be connected to a line, as determined by the total RENs, contact the local telephone company. For products approved after July 23, 2001, the REN for this product is part of the product identifier that has the format US:AAAEQ##TXXXX. The digits represented by ## are the REN without a decimal point (e.g., 03 is a REN of 0.3).

If this equipment causes harm to the telephone network, the telephone company will notify you in advance that temporary discontinuance of service may be required. But if advance notice isn't practical, the telephone company will notify the customer as soon as possible. Also, you will be advised of your right to file a complaint with the FCC if you believe it is necessary.

The telephone company may make changes in its facilities, equipment, operations or procedures that could affect the operation of the equipment. If this happens the telephone company will provide advance notice in order for you to make necessary modifications to maintain uninterrupted service.

If trouble is experienced with this equipment, for repair or warranty information, please contact a Factory Servicenter or other Authorized Servicer. If the equipment is causing harm to the telephone network, the telephone company may request that you disconnect the equipment until the problem is resolved.

Connection to party line service is subject to state tariffs. Contact the state public utility commission, public service commission or corporation commission for information.

If your home has specially wired alarm equipment connected to the telephone line, ensure the installation of this equipment does not disable your alarm equipment. If you have questions about what will disable alarm equipment, consult your telephone company or a qualified installer.

This device complies with Part 15 of the FCC Rules. Operation is subject to the following two conditions: (1) This device may not cause harmful interference, and (2) this device must accept any interference received, including interference that may cause undesired operation.

CAUTION:

Any changes or modifications not expressly approved by the party responsible for compliance could void the user's authority to operate this device.

Note:

This equipment has been tested and found to comply with the limits for a Class B digital device, pursuant to Part 15 of the FCC Rules. These limits are designed to provide reasonable protection against harmful interference in a residential installation. This equipment generates, uses, and can radiate radio frequency energy and, if not installed and used in accordance with the instructions, may cause harmful interference to radio communications. However, there is no guarantee that interference will not occur in a particular installation. If this equipment does cause harmful interference to radio or television reception, which can be determined by turning the equipment off and on, the user is encouraged to try to correct the interference by one or more of the following measures:

- Reorient or relocate the receiving antenna.
- Increase the separation between the equipment and receiver.
- Connect the equipment into an outlet on a circuit different from that to which the receiver is connected.
- Consult the dealer or an experienced radio/TV technician for help.

This equipment is hearing aid compatible as defined by the FCC in 47 CFR Section 68.316.

When you hold the phone to your ear, noise might be heard in your Hearing Aid. Some Hearing Aids are not adequately shielded from external RF (radio frequency) energy. If noise occurs, use an optional headset accessory or the speakerphone option (if applicable) when using this phone. Consult your audiologist or Hearing Aid manufacturer about the availability of Hearing Aids which provide adequate shielding to RF energy commonly emitted by digital devices.

A TIA/EIA-IS-968 compliant telephone cord and modular plug is provided with this equipment. This equipment is designed to be connected to the telephone network or premises wiring using a compatible modular jack that is also TIA/EIA-IS-968 compliant.

- **Environment**—do not place the unit in a room where the temperature is less than 5°C (41°F) or greater than 40°C (104°F). Allow 10 cm (4") clearance around the unit for proper ventilation. Avoid excessive smoke, dust, mechanical vibration, shock, or direct sunlight.
- **Routine care**—wipe the unit with a soft cloth. Do not use benzine, thinner, or any abrasive powder.
- **If there is any trouble**—disconnect the unit from the telephone line and connect a known working phone. If the known working phone operates properly, have your unit repaired by one of the authorized Panasonic Factory Service Centers. If the known working phone does not operate properly, consult your telephone company.

Index

A

Accessories: 2
Answering Calls: 16

B

Battery Installation: 6
Battery Replacement: 34

C

Call Restriction: 32
Call Waiting: 29
Caller ID Number Auto Edit: 12
Caller ID Service: 16
Caller List
 Calling Back: 19
 Editing: 19
 Erasing: 21
 Storing: 20
 Viewing: 17

D

Dialing Mode: 10
Display: 5

F

FCC and Other Information: 40
Flash Button: 30
Flash time: 30

I

Important Safety Instructions: 37

L

LCD Contrast: 11

M

Making Calls: 15
Mute: 30

N

Navigator Key: 4

P

Password: 31
PAUSE: 29
Phone Book
 Chain Dial: 26
 Editing: 27
 Erasing: 28
 Storing: 22
Pulse Service: 29

R

Redial: 15
Ringer Volume: 11
Rotary Service, Tone Dialing: 29

S

Specifications: 39

T

Time Adjustment: 8
Troubleshooting: 35

V

Voice Mail: 28

W

Wall Mounting: 33
Warranty: 43

Warranty

PANASONIC CONSUMER
ELECTRONICS COMPANY, DIVISION
OF PANASONIC CORPORATION OF
NORTH AMERICA
One Panasonic Way
Secaucus, New Jersey 07094

PANASONIC SALES COMPANY,
DIVISION OF PANASONIC PUERTO
RICO, INC.,
Ave. 65 de Infanteria, Km. 9.5
San Gabriel Industrial Park
Carolina, Puerto Rico 00985

Panasonic Telephone Products Limited Warranty

Limited Warranty Coverage

If your product does not work properly because of a defect in materials or workmanship, Panasonic Consumer Electronics Company or Panasonic Sales Company (collectively referred to as "the warrantor") will, for the length of the period indicated on the chart below, which starts with the date of original purchase ("Limited Warranty period"), at its option either (a) repair your product with new or refurbished parts, or (b) replace it with a new or a refurbished product. The decision to repair or replace will be made by the warrantor.

Parts	Labor
One (1) Year	One (1) Year

During the "Labor" Limited Warranty period there will be no charge for labor. During the "Parts" Limited Warranty period, there will be no charge for parts. You must mail-in your product during the Limited Warranty period. This Limited Warranty excludes both parts and labor for batteries, antennas, and cosmetic parts (cabinet). This Limited Warranty only applies to products purchased and serviced in the United States or Puerto Rico. This Limited Warranty is extended only to the original purchaser and only covers products purchased as new.

Mail-In Service

For assistance in the continental U.S.A. in obtaining repairs please ship the product to:

Panasonic Services Company Customer Servicenter
4900 George McVay Drive Suite B Door #12 McAllen, TX 78503

For assistance in Puerto Rico call Panasonic Sales Company (787)-750-4300 or fax (787)-768-2910.

For Limited Warranty service for headsets if a headset is included with this product please call Panasonic Call Center at 1-800-211-PANA (7262).

When shipping the unit carefully pack, include all accessories, and send it prepaid, adequately insured and preferably in the original carton. Include a letter detailing the complaint and provide a day time phone number where you can be reached.

IF REPAIR IS NEEDED DURING THE LIMITED WARRANTY PERIOD THE PURCHASER WILL BE REQUIRED TO FURNISH A SALES RECEIPT/PROOF OF PURCHASE INDICATING DATE OF PURCHASE, AMOUNT PAID AND PLACE OF PURCHASE. CUSTOMER WILL BE CHARGED FOR THE REPAIR OF ANY UNIT RECEIVED WITHOUT SUCH PROOF OF PURCHASE.

Limited Warranty Limits And Exclusions

This Limited Warranty ONLY COVERS failures due to defects in materials or workmanship, and DOES NOT COVER normal wear and tear or cosmetic damage. The Limited Warranty ALSO DOES NOT COVER damages which occurred in shipment, or failures which are caused by products not supplied by the warrantor, or failures which result from accidents, misuse, abuse, neglect, mishandling, misapplication, alteration, faulty installation, set-up adjustments, misadjustment of consumer controls, improper maintenance, power line surge, lightning damage, modification, introduction of sand, humidity or liquids, commercial use such as hotel, office, restaurant, or other business or rental use of the product, or service by anyone other than a Factory Servicenter or other Authorized Servicer, or damage that is attributable to acts of God.

THERE ARE NO EXPRESS WARRANTIES EXCEPT AS LISTED UNDER "LIMITED WARRANTY COVERAGE". THE WARRANTOR IS NOT LIABLE FOR INCIDENTAL OR CONSEQUENTIAL DAMAGES RESULTING FROM THE USE OF THIS PRODUCT, OR ARISING OUT OF ANY BREACH OF THIS LIMITED WARRANTY. (As examples, this excludes damages for lost time, lost calls or messages, cost of having someone remove or re-install an installed unit if applicable, travel to and from the servicer. The items listed are not exclusive, but are for illustration only.) **ALL EXPRESS AND IMPLIED WARRANTIES, INCLUDING THE WARRANTY OF MERCHANTABILITY, ARE LIMITED TO THE PERIOD OF THE LIMITED WARRANTY.**

Some states do not allow the exclusion or limitation of incidental or consequential damages, or limitations on how long an implied warranty lasts, so the exclusions may not apply to you.

This Limited Warranty gives you specific legal rights and you may also have other rights which vary from state to state. If a problem with this product develops during or after the Limited Warranty period, you may contact your dealer or Servicenter. If the problem is not handled to your satisfaction, then write to the warrantor's Consumer Affairs Department at the addresses listed for the warrantor.

PARTS AND SERVICE, WHICH ARE NOT COVERED BY THIS LIMITED WARRANTY, ARE YOUR RESPONSIBILITY.

Customer Services Directory

Obtain Product Information and Operating Assistance; locate your nearest Dealer or Servicenter; purchase Parts and Accessories; or make Customer Service and Literature requests by visiting our Web Site at:

<http://www.panasonic.com/consumersupport>

or, contact us via the web at:

<http://www.panasonic.com/contactinfo>

You may also contact us directly at: 1-800-211-PANA (7262),
Monday-Friday 9 am-9 pm; Saturday-Sunday 10 am-7 pm, EST.

TTY users (hearing or speech impaired users) can call 1-877-833-8855.

Accessory Purchases

Purchase Parts, Accessories and Instruction Books online for all Panasonic Products by visiting our Web Site at:

<http://www.pasc.panasonic.com>

or, send your request by E-mail to:

npcparts@us.panasonic.com

You may also contact us directly at:

1-800-332-5368 (Phone) 1-800-237-9080 (Fax Only)

(Monday - Friday 9 am to 8 pm, EST.)

Panasonic Services Company

20421 84th Avenue South, Kent, WA 98032

(We Accept Visa, MasterCard, Discover Card, American Express, and Personal Checks)

TTY users (hearing or speech impaired users) can call 1-866-605-1277.

Service in Puerto Rico

Panasonic Puerto Rico, Inc. Panasonic Sales Company

Factory Servicenter:

Ave. 65 de Infantería, Km. 9.5, San Gabriel Industrial Park,
Carolina, Puerto Rico 00985

Phone (787)750-4300, Fax (787)768-2910

If you need assistance with setup or operation;

1 Visit our website: <http://www.panasonic.com/consumersupport>

2 Contact us via the web at: <http://www.panasonic.com/contactinfo>

3 Call us at: 1-800-211-PANA (7262)

TTY users (hearing or speech impaired users) can call 1-877-833-8855

When you ship the product

- Carefully pack your unit, preferably in the original carton.
- Attach a letter, detailing the symptom, to the outside of the carton.

Symptom

- Send the unit to an authorized servicer, prepaid and adequately insured.
- Do not send your unit to the Panasonic Consumer Electronics Company listed below or to executive or regional sales offices. These locations do not repair consumer products.

**If you need assistance with the setup or operation,
please call 1-800-211-PANA(7262)**

For hearing or speech impaired TTY users, TTY : 1-877-833-8855

Copyright:

This material is copyrighted by Panasonic Communications (Malaysia) Sdn. Bhd., and may be reproduced for internal use only. All other reproduction, in whole or in part, is prohibited without the written consent of Panasonic Communications (Malaysia) Sdn. Bhd.

© 2004 Panasonic Communications (Malaysia) Sdn. Bhd. All Rights Reserved.

**Panasonic Consumer Electronics Company,
Division of Panasonic Corporation of North America**

One Panasonic Way, Secaucus, New Jersey 07094

**Panasonic Sales Company,
Division of Panasonic Puerto Rico, Inc.**

Ave. 65 de Infantería, Km. 9.5, San Gabriel Industrial Park
Carolina, Puerto Rico 00985