

Panasonic[®]

Operating Instructions

Integrated Telephone System

Model No. **KX-TS880**



Thank you for purchasing a Panasonic product.

Please read these operating instructions before using the unit and save them for future reference.

Consulte "Guía Rápida en Español", página 37.

This unit is compatible with Caller ID. You must subscribe to the appropriate service offered by your service provider/telephone company.

For assistance, visit our website:

<http://www.panasonic.com/help> for customers in the USA or Puerto Rico.

Please register your product: <http://www.panasonic.com/prodreg>

Table of Contents

Introduction		Voice Mail Service	
Accessory information.....	3	Voice mail service.....	27
Important Information		Useful Information	
For your safety	4	Optional headset	28
Important safety instructions	4	Desk mount setup.....	29
For best performance.....	5	Wall mount setup.....	30
Other information	5	Troubleshooting.....	32
Specifications	5	FCC and other information	35
Preparation		Guía Rápida En Español	
Controls.....	6	Guía rápida en español	37
Display	7	Appendix	
Battery installation and		Customer services.....	45
replacement	8	Warranty (For United States	
Connections	9	and Puerto Rico).....	46
Symbols used in these		Index	
operating instructions.....	10	Index.....	48
Setting up the unit before			
use	11		
Making/Answering Calls			
Making calls	12		
Answering calls	13		
Useful features during a call.....	14		
One-Touch Dialer			
One-touch dialer.....	15		
Speed Dialer			
Speed dialer	17		
Phonebook			
Phonebook.....	18		
Chain dial	19		
Programming			
Programmable settings	20		
Special instructions for			
programmable settings.....	22		
Caller ID Service			
Using Caller ID service.....	23		
Caller list	24		

Introduction

For your future reference

We recommend keeping a record of the following information to assist with any repair under warranty.

Serial No. _____ Date of purchase _____
 (found on the bottom of the unit)

Name and address of dealer _____

- - - - -
Attach your purchase receipt here.
 - - - - -

Accessory information

Supplied accessories

To order replacement accessories, please contact your nearest Panasonic dealer for sales information (page 45).

No.	Accessory item	Quantity
①	Handset Order no. : PQJXF0102Z (White) PQJXF0101Z (Black)	1
②	Handset cord Order no. : PQJA10152Z (White) PQJA10152W (Black)	1
③	Telephone line cord Order no. : PQJA10075Z	1

①

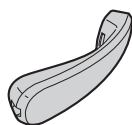

②

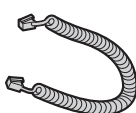

③



Important Information

For your safety

To prevent severe injury and loss of life/property, read this section carefully before using the product to ensure proper and safe operation of your product.

WARNING

Installation

- To prevent the risk of fire or electrical shock, do not expose the product to rain or any type of moisture.
- Unplug this unit from power outlets if it emits smoke, an abnormal smell or makes unusual noise. These conditions can cause fire or electric shock. Confirm that smoke has stopped and contact the Panasonic Call Center at 1-800-211-PANA (1-800-211-7262).

Operating safeguards

- Do not disassemble the product.
- Do not spill liquids (detergents, cleansers, etc.) onto the telephone line cord plug, or allow it to become wet at all. This may cause a fire. If the telephone line cord plug becomes wet, immediately pull it from the telephone wall jack, and do not use.

CAUTION

Installation and location

- Never install telephone wiring during an electrical storm.
- Never install telephone line jacks in wet locations unless the jack is specifically designed for wet locations.
- Never touch uninsulated telephone wires or terminals unless the telephone line has been disconnected at the network interface.
- Use caution when installing or modifying telephone lines.
- This product is unable to make calls when the call restriction feature is turned on (only phone numbers stored in the unit as emergency numbers can be called.)

Battery

- We recommend using the batteries noted on page 8.
- Do not mix old and new batteries.

Important safety instructions

When using your product, basic safety precautions should always be followed to reduce the risk of fire, electric shock, and injury to persons, including the following:

1. Do not use this product near water, for example, near a bathtub, washbowl, kitchen sink or laundry tub, in a wet basement or near a swimming pool.
2. Avoid using a telephone (other than a cordless type) during an electrical storm. There may be a remote risk of electric shock from lightning.
3. Do not use the telephone to report a gas leak in the vicinity of the leak.
4. Use only the batteries indicated in this manual. Do not dispose of batteries in a fire. They may explode. Check with local codes for possible special disposal instructions.

SAVE THESE INSTRUCTIONS

Important Information

For best performance

Environment

- The product should be kept free from excessive smoke, dust, high temperature, and vibration.
- The product should not be exposed to direct sunlight.
- Do not place heavy objects on top of the product.
- The product should be kept away from heat sources such as radiators, cookers, etc. It should not be placed in rooms where the temperature is less than 0°C (32°F) or greater than 40°C (104°F). Damp basements should also be avoided.

Routine care

- **Wipe the outer surface of the product with a soft moist cloth.**
- Do not use benzine, thinner, or any abrasive powder.

Other information

Notice for product disposal, transfer, or return

- This product can store your private/confidential information. To protect your privacy/confidentiality, we recommend that you erase information such as phonebook, one-touch dial, speed dial or caller list entries from the memory before you dispose of, transfer, or return the product.

Specifications

Power source:

From telephone line
From 3 AA (LR6, R6, UM-3) batteries

Dimensions (H x W x D):

Approx. 93 mm × 172 mm × 220 mm
(3 ²¹/₃₂" × 6 ⁷⁷/₁₀₀" × 8 ²¹/₃₂")

Mass (Weight):

Approx. 550 g (1.21 lb.)

Operating conditions:

0 °C–40 °C (32 °F–104 °F),
20 %–80 % relative air humidity (dry)

Note:

- Design and specifications are subject to change without notice.
- The illustrations in these instructions may vary slightly from the actual product.

Preparation

Controls

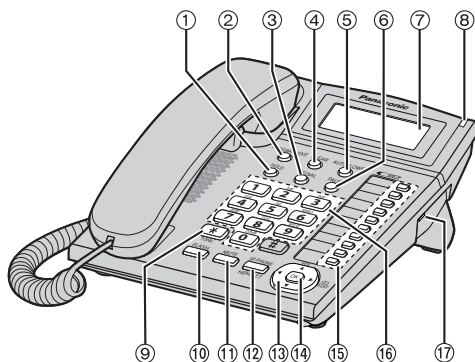

- | | |
|---|--|
| ① [HOLD] (page 14) | ⑩ [FLASH] (page 14) |
| ② [PROGRAM/EXIT] (page 11, 15, 17, 20, 22) | ⑪ [MUTE] (page 14) |
| ③ [REDIAL] (page 12) | ⑫ [SP-PHONE] (Speakerphone) (page 12, 13, 15, 17, 24)
[HEADSET] (page 28) |
| ④ [CLEAR] (page 12, 17, 18, 19, 22) | ⑬ Navigator key ([▲] , [▼] , [◀] , [▶]) (page 18, 19, 24) |
| ⑤ [AUTO/LOWER] (page 15, 17) | ⑭ [OK] (page 11, 15, 20, 22, 24) |
| ⑥ [PAUSE] (page 13) | ⑮ One-touch dial buttons (page 15) |
| ⑦ Display (page 7) | ⑯ Dial key buttons/memory station numbers (page 17) |
| ⑧ RINGER indicator (page 13) | ⑰ RINGER selector (page 13) |
| ⑨ [*] (TONE) (page 14) | |

How to use the Navigator key and [OK] button

This key has five active areas that are indicated by arrows and **[OK]**.

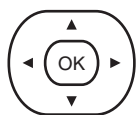





- Pressing the up and down arrows allows you to enter the Caller List and scroll through the function menu.
- Pressing the right and left arrows allows you to enter the Phonebook and move the cursor when entering items. The right arrow also use to select the desired item.
- The **[OK]** button is used to select and confirm desired item.

Throughout this Operating Instructions, the navigator key is indicated by the arrows **[▼]**, **[▲]**, **[◀]** or **[▶]** and **[OK]**.

Preparation

Display

Display items

Item	Meaning
✓	You have checked this caller information, answered the call or called back the caller from the caller list (page 24).
	The phone line is in SP-PHONE (speakerphone) call mode (page 12).
	The display flashes when the battery power is low. To replace the batteries, see page 8.
	The second call has been received while talking (page 14).
P	[PAUSE] was pressed while dialing or storing phone numbers.
F	[FLASH] was pressed while storing phone numbers.
⌂	[*] was pressed while dialing.
≡	[#] was pressed while dialing.
	The phone line is in headset call mode.

Preparation

Battery installation and replacement

Installing the batteries

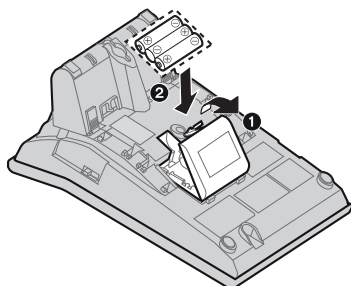

- 1** Press down in the direction of the arrow and open the cover (1).
 - 2** Install the batteries in the proper order as shown (2), matching the correct polarity.
 - 3** Close the battery cover.
 - After battery installation, the unit will reset and "Set clock" will always display until the time is set.
 - To set the clock, see page 11.
- Batteries are not included with the unit.
 - Install three high quality "AA" size Alkaline (LR6) or Manganese (R6, UM-3) batteries. We recommend to use Panasonic batteries.
- Battery life is:
- about six months when using Alkaline batteries.
 - about three months when using Manganese batteries.
- Battery life may depend on usage conditions and ambient temperature.
 - Make sure batteries were inserted properly inphase to ensure the functionality of this unit.

THE UNIT MAY NOT WORK PROPERLY WITHOUT BATTERIES.

Replacing the batteries

If "☐" flashes, the battery power is low. Install new batteries as soon as possible. If batteries are not replaced even after the "☐" is displayed, the unit may not work properly.

- Store the desired items in the phonebook, because after the battery replacement, the information stored in the redial list will be cleared.
- 1** Disconnect the telephone line cord from the unit.
 - 2** Press down in the direction of the arrow and open the cover.
 - 3** Replace the batteries with new ones using correct polarity (+, -), and close the cover.
 - 4** Connect the telephone line cord to the unit.

Battery precautions:

The batteries should be used correctly, otherwise the unit may be damaged by battery leakage.

- Do not mix different types of batteries.
- Do not charge, short-circuit, disassemble, heat or dispose of in fire.
- Remove all the batteries when replacing.

Note:

- If you do not install the batteries or if the battery power is low, the display will become blank. Readjust the time after the battery replacement.
- Replace all the batteries every six months if using Alkaline batteries, or misoperation may occur. (When you use Manganese batteries, replace all of them every three months.)
- Do not use nickel-cadium batteries.

Preparation

Connections

Connect the handset cord (❶) to the handset and the unit. Connect the telephone line cord until it clicks into the unit and telephone line jack (❷). After line connection, lift the handset to check for a dial tone.

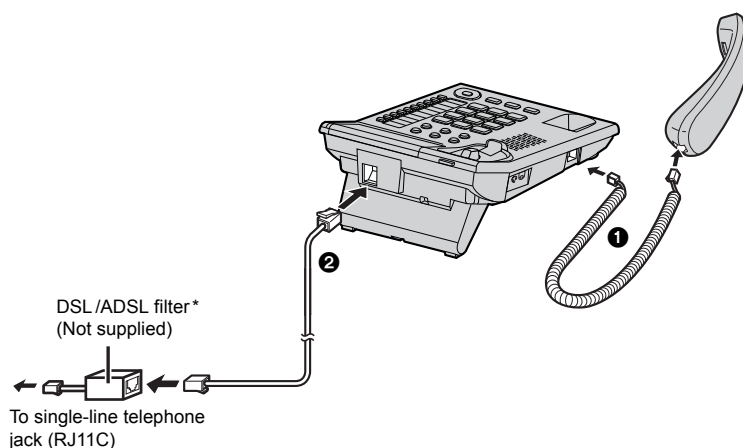

- Use only a Panasonic handset for KX-TS880.
- Use only the supplied telephone line cord. Using another telephone line cord may not allow the unit to work properly.

* For DSL/ADSL service users

Please attach a DSL/ADSL filter (contact your DSL/ADSL provider) to the telephone line between the unit and the telephone line jack in the event of the following:

- noise is heard during conversations.
- Caller ID features do not function properly.

Preparation

Symbols used in these operating instructions

Symbol	Meaning
[]	The words in the brackets indicate button names on the unit.
→	Proceed to the next operation.
“ ”	The words in quotations indicate the menu on the display. Example: “Save phonebook ?”
【▼】/【▲】: “ ”	Press 【▼】 or 【▲】 to select the words in quotations. Example: 【▼】/【▲】: “off”

Preparation

Setting up the unit before use

Display language

You can select "English" or "Español" as the display language. The default setting is "English".

- 1 [PROGRAM/EXIT] → [▼] / [▲]: "Change language?" → [OK]
- 2 [▼] / [▲]: Select the desired setting → [OK] → [PROGRAM/EXIT]

Date and time

- 1 [PROGRAM/EXIT] → [▼] / [▲]: "Set clock ?" → [OK]
- 2 Enter the current year by selecting 2 digits.
Example: 2010
[1] [0]
 - You can select the year from 2000 to 2099.
- 3 [OK]
- 4 Enter the current hour and minute by selecting 2 digits for each.
- 5 [OK]
 - If numbers between 0000 and 0059, or 1300 and 2359 are entered, the time will automatically set using the 24-hour clock. Skip steps 6 and 7, and go to step 8.
- 6 Press [#] to select "AM", "PM" or 24-hour clock.

Display	Option
AM	-----AM
PM	-----PM
(Blank display)	----- 24-hour clock

- Each time you press [#], the selection will change on the display.

Example: 9:30PM

[0] [9] [3] [0] → Press [#] until "9:30PM" is displayed.

- 7 [OK]
- 8 Enter the current month and day by selecting 2 digits for each.
Example: July 15
[0] [7] [1] [5]
- 9 [OK] → [PROGRAM/EXIT]
 - If the date and time are entered wrong, "ERROR" will be displayed and you cannot continue with the setting. Enter the correct date and time.

For Caller ID service users (page 23)

If a time display service is available with the Caller ID service:

- The Caller ID information will re-set the clock after the ring if:
 - the adjusted time and/or date is incorrect.
 - the time adjustment set to ON.

Dialing mode

If you cannot make calls, change this setting according to your telephone line service.

The default setting is "Tone".

"Tone": For tone dial service.

"Pulse": For rotary/pulse dial service.

- 1 [PROGRAM/EXIT]
- 2 [▼] / [▲]: "Program ?" → [OK]
- 3 [▼] / [▲]: "Set dial mode ?" → [OK]
- 4 [▼] / [▲]: Select the desired setting → [OK] → [PROGRAM/EXIT]

Making/Answering Calls

Making calls

- 1** Lift the handset and dial the phone number.
- 2** When you finish talking, place the handset on the cradle.

Using the speakerphone

- 1** **[SP-PHONE]** → Dial a phone number.
OR
Dial a phone number
→ **[SP-PHONE]**
 - Speak alternately with the other party.
 - If you have misdialled, press **[SP-PHONE]** and start again from step 1.
- 2** When you finish talking, press **[SP-PHONE]**.

Note:

- For best performance, use the speakerphone in a quiet environment. If necessary, adjust the speaker volume.
- You can switch to the handset by lifting it up. To switch back to the speakerphone, press **[SP-PHONE]** and place the handset on the cradle.

Adjusting the handset or the speaker volume

Press **[▼]** or **[▲]** repeatedly while talking.

- "0" shows one level.

Making a call using the redial list

The last 20 phone numbers dialed are stored in the redial list.

- 1** **[REDIAL]**
- 2** **[▼]** / **[▲]**: Select the desired phone number.
 - You can also scroll through the list by pressing **[REDIAL]**.
 - To exit the list, press **[PROGRAM/EXIT]**.
- 3** Lift the handset or press **[SP-PHONE]** to start calling.

Erasing a number in the redial list

- 1** **[REDIAL]**
- 2** **[▼]** / **[▲]**: Select the desired phone number.
- 3** **[CLEAR]**
 - If "No items stored" is displayed, the list is empty.
- 4** **[PROGRAM/EXIT]**

Making/Answering Calls

Pause (for PBX/long distance service users)

A pause is sometimes required when making calls using a PBX or long distance service. When storing a calling card access number and/or PIN in the phonebook, one-touch dial or speed dial, a pause is also needed. Example: If you need to dial the line access number "9" when making outside calls with a PBX:

- 1** [9] → [PAUSE]
- 2** Dial the phone number.
- 3** Lift the handset or press [SP-PHONE] to start calling.

Note:

- A 3.5 second pause is inserted each time [PAUSE] is pressed. Repeat as needed to create longer pauses.

Answering calls

When a call is being received, the unit rings, the ringer indicator flashes quickly and "Incoming call" is displayed. You can answer a call by simply lifting the handset.

Using the speakerphone

- 1** [SP-PHONE]
- 2** When you finish talking, press [SP-PHONE].

Note:

- The ringer indicator will flash when
 - a telephone number is dialed in "Pulse" mode, or
 - someone picks up or hangs up another phone connected to the same phone line.

This is normal.

Adjusting the unit ringer volume

You can select the ringer volume to HIGH, LOW or OFF. The default setting is HIGH.



Making/Answering Calls

Useful features during a call

Hold

This feature allows you to put an outside call on hold.

- 1** Press **[HOLD]** during an outside call.
 - If using the handset, you can place it on the cradle.
 - During the hold, both party will hear music. For canceling music, see page 20.
- 2** To release hold, lift the handset if the handset is on the cradle.
OR
Press **[HOLD]** if the handset is off the cradle.
OR
Press **[SP-PHONE]** if using the speakerphone.

Note:

- If another phone is connected to the same line, you can also take the call by lifting its handset.

Mute

While mute is turned on, you can hear the other party, but the other party cannot hear you.

- 1** During an outside call, press **[MUTE]**.
- 2** To return to the conversation, press **[MUTE]**.

Flash

[FLASH] allows you to use the special features of your host PBX such as transferring an extension call, or accessing optional telephone services.

Note:

- To change the flash time, see page 20.

For call waiting or Call Waiting Caller ID service users

To use call waiting, you must first subscribe to the call waiting service of your service provider/telephone company. This feature allows you to receive calls while you are already talking on the phone. If you receive a call while on the phone, you will hear a call waiting tone. **If you subscribe to both Caller ID and Call Waiting with Caller ID services**, the 2nd caller's information and "**[CALL]**" are displayed after you hear the call waiting tone.

- 1** Press **[FLASH]** to answer the 2nd call.
- 2** To switch between calls, press **[FLASH]**.

Note:

- Please contact your service provider/telephone company for details and availability of this service in your area.

Temporary tone dialing (for rotary/pulse service users)

You can temporarily switch the dialing mode to tone when you need to access touch-tone services (for example, answering services, telephone banking services, etc.). Press **[*]** (TONE) before entering access numbers which require tone dialing.

One-Touch Dialer

One-touch dialer

You can store up to 20 phone numbers in the one-touch dial buttons (10 numbers in UPPER memory locations and 10 numbers in LOWER memory locations). Do not press any one-touch dial buttons before storing to prevent misoperation.

Note:

- If a phone number is stored in a one-touch dial button which already contains a phone number, the old number will be erased.
- To store a number as an emergency number, see page 18.

UPPER memory locations

Storing phone numbers

- 1** **[PROGRAM/EXIT]** → **[▼]/[▲]**:
"Save one touch ?" → **[OK]**
- 2** Enter the party's name
(15 characters max.) → **[OK]**
- 3** Enter the party's phone number
(32 digits max.) → **[OK]**
- 4** Press the one-touch dial button.
 - A long beep sounds.
- 5** **[PROGRAM/EXIT]**

Note:

- We recommend you program an emergency number in the EMERGENCY button.

Erasing a stored number

- 1** Press the one-touch dial button.
- 2** **[CLEAR]** → **[OK]**
 - A long beep sounds.

Dialing a stored number

- 1** Lift the handset or press **[SP-PHONE]**.
- 2** Press the one-touch dial button.
- 3** When you finish talking, place the handset on the cradle or press **[SP-PHONE]**.

OR

- 1** Press the one-touch dial button.
- 2** Lift the handset or press **[SP-PHONE]**.
- 3** When you finish talking, place the handset on the cradle or press **[SP-PHONE]**.

LOWER memory locations

Storing phone numbers

- 1** **[PROGRAM/EXIT]** → **[▼]/[▲]**:
"Save one touch ?" → **[OK]**
- 2** Enter the party's name
(15 characters max.) → **[OK]**
- 3** Enter the party's phone number
(32 digits max.) → **[OK]**
- 4** **[AUTO/LOWER]** → Press the one-touch dial button.
 - A long beep sounds.
- 5** **[PROGRAM/EXIT]**

Erasing a stored number

- 1** **[AUTO/LOWER]** → Press the one-touch dial button.
- 2** **[CLEAR]** → **[OK]**
 - A long beep sounds.

Dialing a stored number

- 1** Lift the handset or press **[SP-PHONE]**.
- 2** **[AUTO/LOWER]** → Press the one-touch dial button.
- 3** When you finish talking, place the handset on the cradle or press **[SP-PHONE]**.

OR

- 1** **[AUTO/LOWER]** → Press the one-touch dial button.
- 2** Lift the handset or press **[SP-PHONE]**.
- 3** When you finish talking, place the handset on the cradle or press **[SP-PHONE]**.

One-Touch Dialer

Index card

Use the index card to record the names/phone numbers stored to the one-touch dial buttons.

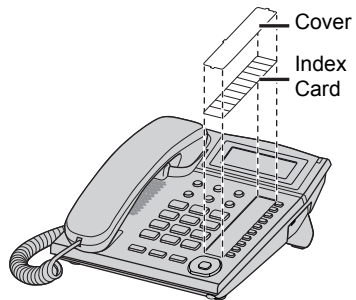
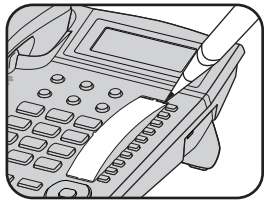

Speed Dialer

Speed dialer

You can store up to 10 numbers in the memory stations. The dialing buttons **[0]** to **[9]** function as memory station numbers. Do not press any memory stations before storing to prevent misoperation.

Note:

- If a phone number is stored in a dialing button which already contains a phone number, the old number will be erased.
- To store a number as an emergency number, see page 18.

Storing phone numbers

- 1** **[PROGRAM/EXIT]** → **[▼]** / **[▲]**:
"Save speed dial?" → **[OK]**
- 2** Enter the party's name
(15 characters max.) → **[OK]**
- 3** Enter the party's phone numbers
(32 digits max.) → **[OK]**
- 4** Press the memory station number
(**[0]** to **[9]**).
 - A long beep sounds.
- 5** **[PROGRAM/EXIT]**

Erasing a stored number

- 1** **[AUTO/LOWER]** → Press the memory station number (**[0]** to **[9]**) for the phone number to be erased.
- 2** **[CLEAR]** → **[OK]**
 - A long beep sounds.

Dialing a stored number

- 1** Lift the handset or press **[SP-PHONE]**.
- 2** **[AUTO/LOWER]** → Press the memory station number (**[0]** to **[9]**).
- 3** When you finish talking, place the handset on the cradle or press **[SP-PHONE]**.

OR

- 1** **[AUTO/LOWER]** → Press the memory station number (**[0]** to **[9]**).
- 2** Lift the handset or press **[SP-PHONE]**.
- 3** When you finish talking, place the handset on the cradle or press **[SP-PHONE]**.

Phonebook

Phonebook

The phonebook allows you to make calls without having to dial manually. You can add 50 names and phone numbers.

Adding entries

- 1** [PROGRAM/EXIT]
- 2** [▼]/[▲] → "Save phonebook ?" → [OK]
 - The display will show the number of stored items.
- 3** Enter the party's name (15 characters max.) → [OK]
- 4** Enter the party's phone number (32 digits max.) → [OK]
 - To add other entries, repeat from step 2.
 - If the display shows "Phonebook full" in step 2, press [PROGRAM/EXIT] to exit the list. To erase other stored items from the phonebook, see page 19.
- 5** [PROGRAM/EXIT]

To store emergency numbers

Emergency numbers are numbers stored in the phonebook, one-touch dial and speed dial that can be dialed even when call restriction (page 22) is turned on.

To store a number as an emergency number, add # at the beginning of the party's name except the number at EMERGENCY button.

Character table for entering names

Key	Character
[1]	& ' () , - . / 1
[2]	a b c A B C 2
[3]	d e f D E F 3
[4]	g h i G H I 4
[5]	j k l J K L 5
[6]	m n o M N O 6
[7]	p q r s P Q R S 7
[8]	t u v T U V 8
[9]	w x y z W X Y Z 9
[0]	0 Space
[*]	*
[#]	#

- To enter another character that is located on the same dial key, press [▶] to move the cursor to the next space.

Correcting a mistake

Press [◀] or [▶] to move the cursor to the character or number you want to erase, then press [CLEAR]. Enter the appropriate character or number.

- Press and hold [CLEAR] to erase all characters or numbers.

Phonebook

Finding and calling a phonebook entry

Scrolling through all entries

- 1** Press [**◀**] or [**▶**] to enter the phonebook list.
- 2** [**▼**] / [**▲**]: Select the desired entry.
 - Item with # at the beginning will be displayed with first priority if call restriction (page 22) is turned on.
- 3** Lift the handset or press [**SP-PHONE**] to start calling.

Searching by first character (alphabetically)

- 1** Press [**◀**] or [**▶**] to enter the phonebook list.
- 2** Press the dial key ([**0**]-[**9**], [*****] or [**#**]) which contains the character you are searching for (page 18).
 - Press the same dial key repeatedly to display the first entry corresponding to each character located on that dial key.
 - If there is no entry corresponding to the character you selected, the next entry is displayed.
- 3** [**▼**] / [**▲**]: Scroll through the phonebook if necessary.
- 4** Lift the handset or press [**SP-PHONE**] to start calling.

Editing entries

- 1** Press [**◀**] or [**▶**] to enter the phonebook list.
- 2** [**▼**] / [**▲**]: Select the desired entry → [**OK**]
- 3** Edit the name if necessary (15 characters max.: page 18) → [**OK**]
- 4** Edit the phone number if necessary (32 digits max) → [**OK**] → [**PROGRAM/EXIT**]

Erasing entries

- 1** Press [**◀**] or [**▶**] to enter the phonebook list.
- 2** [**▼**] / [**▲**]: Select the desired entry → [**CLEAR**] → [**OK**]
 - A beep sounds.
- 3** [**PROGRAM/EXIT**]

Chain dial

This feature allows you to dial phone numbers in the phonebook while you are on a call. This feature can be used, for example, to dial a calling card access number or bank account PIN that you have stored in the phonebook, without having to dial manually.

- 1** During an outside call, press [**◀**] or [**▶**].
- 2** [**▼**] / [**▲**]: Select the desired entry → [**OK**]



Note:

- When storing a calling card access number and your PIN in the phonebook as one phonebook entry, press [**PAUSE**] to add pauses after the number and PIN as necessary (page 13).
- If you have rotary/pulse service, you need to press [*****] before pressing [**◀**] or [**▶**] in step 1 to change the dialing mode temporarily to tone.

Programming

Programmable settings

You can customize the unit by programming the following features.

Make sure that the handset is on the cradle and “” or “” is not displayed.

Programming by scrolling through the display menus

1 [PROGRAM/EXIT]

2 [▼]/[▲]: Select the desired item in main menu → [OK]

3 [▼]/[▲]: Select the desired setting → [OK]

- This step may vary depending on the feature being programmed.
- To exit the operation, press [PROGRAM/EXIT] or wait for 60 seconds.

Note:

- In the following table, < > indicates the default settings.
- The current item or setting is highlighted on the display.

Main menu	Sub-menu	Setting	Page
Save phonebook ?	–	–	18
Save one touch ?	–	–	15
Save speed dial?	–	–	17
Program ?	Change password?	<1111>	22
	Call restrict ?	–	22
	Set flash time ?*1	900/700/600/400/300/ 250/200/160/110/100/ 90/80 <600>	–
	Set dial mode ?	Tone/Pulse <Tone>	11
	LCD contrast ?*2	0000/000/00/0 <00>	–
	Set hold music ?*3	On/Off <On>	–
	Set auto edit ?	On/Off <On>	24
	Time adjustment?*4	On/Off <On>	–
	VM tone detect ?	On/Off <On>	27
Set clock ?	–	–	11
Change language?	–	English/Español <English>	11

Programming

- *1 The flash time (ms) depends on your telephone exchange or host PBX. Contact your PBX supplier if necessary.
- *2 "□" shows one level. To make the display clearer, set to high level.
- *3 You can set music play during the hold.
- *4 If the Caller ID time and date display service is available in your area, this feature allows the unit to automatically adjust the date and time setting when caller information is received. To use this feature, set the date and time first.

Programming

Special instructions for programmable settings

Call restriction

You can restrict the unit from dialing phone numbers beginning with specified digit(s) (1 digit or 2 digits). Phone numbers with the restricted leading digits cannot be dialed out, except the emergency numbers (#) stored in the phonebook, one-touch dial and speed dial.

- When call restriction is turned on, you cannot store, edit, or erase the emergency numbers begin with # in the phonebook, one-touch dial and speed dial.

Setting the call restriction

- 1 [PROGRAM/EXIT]
- 2 [▼]/[▲]: "Program ?" → [OK]
- 3 [▼]/[▲]: "Call restrict ?" → [OK]
 - If you have not changed the unit password (default: 1111), go to step 5.
- 4 Enter the unit password → [OK]
- 5 Enter the number(s) (1 digit or 2 digits) you want to restrict ([0] to [9]) → [OK] → [PROGRAM/EXIT]

Erasing the restricted number

- 1 [PROGRAM/EXIT]
- 2 [▼]/[▲]: "Program ?" → [OK]
- 3 [▼]/[▲]: "Call restrict ?" → [OK]
 - If you have not changed the unit password (default: 1111), go to step 5.
- 4 Enter the unit password → [OK]

- 5 Press and hold [CLEAR] → [OK] → [PROGRAM/EXIT]

Changing the unit password

Important:

- If you change the password, please make note of your new password. The unit will not reveal the password to you. If you forget your password, consult your nearest Panasonic service center.

- 1 [PROGRAM/EXIT]
- 2 [▼]/[▲]: "Program ?" → [OK]
- 3 [▼]/[▲]: "Change password?" → [OK]
- 4 Enter the current 4-digit password (default: "1111") → [OK]
 - If you have entered the wrong password, "ERROR" and "----" will be displayed. Enter the correct password.
- 5 Enter the new 4-digit password → [OK] → [PROGRAM/EXIT]

Caller ID Service

Using Caller ID service

Important:

- This unit is Caller ID compatible. To use Caller ID features, you must subscribe to Caller ID service. Contact your service provider / telephone company for details.

Caller ID features

When an outside call is being received, the name and phone number is displayed.

Caller information for the last 50 callers is logged in the caller list from the most recent call to the oldest. When the 51st call is received, the oldest call is deleted.

- If the unit cannot receive caller information, the following is displayed:
 - **"Out of area"**: The caller dialed from an area which does not provide Caller ID service.
 - **"Private caller"**: The caller requested not to send caller information.
 - **"Long distance"**: The caller made a long distance call.
- If the unit is connected to a PBX system, caller information may not be received properly. Contact your PBX supplier.
- If the batteries installed in the unit have expired, Caller ID services will not be available.

Missed calls

If a call is not answered, the unit treats the call as a missed call. The display shows the number of missed calls, while the unit is not in use. This lets you know if you should view the caller list to see who called while you were away. If you have entered the caller list before and there is no new missed call coming in after that, number of missed calls will not be displayed in standby mode.

- If there are unviewed missed calls, number of missed calls will be displayed when you enter the caller list.

Private name display

When caller information is received and it matches a phone number stored in the phonebook, one-touch and speed dial, the stored name is displayed and logged in the caller list.

Caller ID Service

Caller list

Important:

- Make sure the unit's date and time setting is correct (page 11).

Viewing the caller list and calling back

- 1 Press [▼] or [▲] to enter the caller list.
- 2 Press [▼] to search from the most recent call, or [▲] to search from the oldest call.
- 3 To call back, lift the handset or press [SP-PHONE].
- 4 To exit, press [PROGRAM/EXIT].

Note:

- If the item has already been viewed or answered, "✓" is displayed.
- If "No items stored" is displayed in step 1, the caller list is empty.

Editing a caller's phone number before calling back

- 1 Press [▼] or [▲] to enter the caller list.
- 2 [▼] / [▲]: Select the desired entry → [OK].
- 3 Press [▶] repeatedly until the number is shown in the desired format.
 - Ⓐ Local phone number
Example: 321-5555
 - Ⓑ Area code - Local phone number
Example: 555-321-5555
 - Ⓒ 1 - Area code - Local phone number
Example: 1-555-321-5555
- 4 To call back, lift the handset or press [SP-PHONE].

Caller ID number auto edit feature

Once you call back an edited number, the unit will remember the area code and format of the edited number. The next time someone calls from the same area code, caller information is customized by the unit as follows:

- When the call is being received, the Caller ID number is displayed in the same format as the edited number.
- After the call has ended, the caller's phone number is displayed in the same format as the edited number, when reviewed from the caller list.

For example, you can use this feature to set the unit to ignore the area code of callers in your area, so that you can call these local numbers using caller information without dialing the area code. To activate this feature, you must edit an entry in the caller list, then call that number. After that, phone numbers from that caller's area code are edited automatically.

The default setting is "On".

- 1 [PROGRAM/EXIT]
- 2 [▼] / [▲]: "Program ?" → [OK]
- 3 [▼] / [▲]: "Set auto edit ?" → [OK]
- 4 [▼] / [▲]: Select the desired setting → [OK]
- 5 [PROGRAM/EXIT]
 - Phone numbers from the 4 most recently edited area codes are automatically edited.
 - If you fail to reach your destination when making a call, the phone number you dialed might have an incorrect pattern. Edit the phone number with another pattern.
 - When this feature is turned off, the unit will still be able to display caller ID, but incoming caller ID numbers will not be automatically edited.
 - If you move to another area, you may need to turn this feature off to erase the previously edited area codes. To use this feature again, turn it on and reprogram the area codes you want to edit once again.

Caller ID Service

Erasing selected caller information

- 1** Press [▼] or [▲] to enter the caller list.
- 2** [▼] / [▲]: Select the desired entry.
- 3** [CLEAR]
 - A long beep sounds.
- 4** [PROGRAM/EXIT]

Erasing all caller information

- 1** [CLEAR]
- 2** "All erase ?" → [OK]
 - A long beep sounds.
- 3** [PROGRAM/EXIT]

Storing caller information into the phonebook

- 1** Press [▼] or [▲] to enter the caller list.
- 2** [▼] / [▲]: Select the desired entry → [OK].
 - To edit the number, press [▶] repeatedly until the phone number is shown in the desired format.
- 3** [OK]
 - If there is name information for the caller, go to step 5.
- 4** Enter the name (15 character max.: page 18) → [OK]
- 5** "▼ Phonebook?" → [OK]
 - A long beep sounds.
- 6** [PROGRAM/EXIT]

Storing caller information into the one touch dial

- 1** Press [▼] or [▲] to enter the caller list.
- 2** [▼] / [▲]: Select the desired entry → [OK].
 - To edit the number, press [▶] repeatedly until the phone number is shown in the desired format.
- 3** [OK]
 - If there is name information for the caller, go to step 5.
- 4** Enter the name (15 character max.: page 18) → [OK]
- 5** Press [▼] → "▼▲ One touch?" → [OK]
- 6** Press the one-touch dial button.
 - If a phone number is stored in a one-touch dial button which already contains a phone number, the old number will be erased.
 - A long beep sounds.
- 7** [PROGRAM/EXIT]

Storing caller information into the speed dial

- 1** Press [▼] or [▲] to enter the caller list.
- 2** [▼] / [▲]: Select the desired entry → [OK].
 - To edit the number, press [▶] repeatedly until the phone number is shown in the desired format.
- 3** [OK]
 - If there is name information for the caller, go to step 5.
- 4** Enter the name (15 character max.: page 18) → [OK]
- 5** Press [▼] twice → "▲ Speed dial?" → [OK]

Caller ID Service

6 Press the memory station number
([0] to [9])

- If a phone number is stored in a dialing button which already contains a phone number, the old number will be erased.
- A long beep sounds.

7 **[PROGRAM/EXIT]**

Voice Mail Service

Voice mail service

Voice mail is an automatic answering service offered by your service provider/telephone company. After you subscribe to this service, your service provider/telephone company's voice mail system answers calls for you when you are unavailable to answer the phone or when your line is busy. Messages are recorded by your service provider/telephone company, not your telephone. Please contact your service provider/telephone company for details of this service.

Listening to voice mail message(s)

The unit lets you know that you have new voice mail messages in the following way:

- "Voice mail" is displayed.

- 1** Lift the handset or press **[SP-PHONE]** and dial an access phone number.
 - You will get an access phone number from your telephone company.
- 2** Follow the pre-recorded instructions.
- 3** Press **[SP-PHONE]** if using the speakerphone.
 - "Voice mail" will disappear from the display.
 - If "voice mail" still display after you have listened to your voice mail messages, press **[PROGRAM/EXIT]**, and then press and hold **[CLEAR]** and "Voice mail" will disappear.

Voice mail (VM) tone detection

Your service provider/telephone company sends special signals (sometimes called "voice mail tones" or "stutter tones") to the unit to let you know you have new voice mail messages. If you hear a series of dial tones followed by a continuous dial tone after lifting the handset, you have new voice mail messages. Soon after you hang up a call or after the phone stops ringing, your unit checks the phone line to see if new voice mail messages have been recorded.

Turn this feature off when:

- You do not subscribe to voice mail service.
- Your service provider/telephone company does not send voice mail tones.
- Your phone is connected to a PBX. If you are not sure which setting is required, contact your service provider/telephone company.

Turning VM tone detection on/off

The default setting is "On".

- 1** **[PROGRAM/EXIT]**
- 2** **[▼] / [▲]**: "Program ?" → **[OK]**
- 3** **[▼] / [▲]**: "VM tone detect ?" → **[OK]**
- 4** **[▼] / [▲]**: Select the desired mode → **[OK]**
- 5** **[PROGRAM/EXIT]**

Useful Information

Optional headset

Plugging the optional headset into the unit allows a hands-free phone conversation. Please use only a Panasonic KX-TCA93, KX-TCA400, KX-TCA430 or KX-TCA60.

Connecting the optional headset to the unit

Connect the optional headset to the headset jack as shown below.

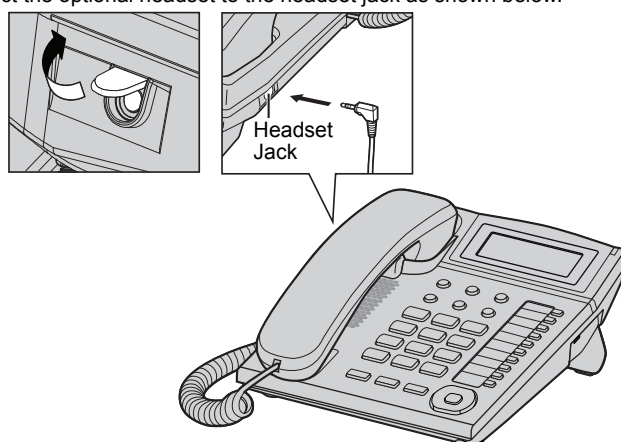

If you want to have a normal conversation, disconnect the headset.

Making/answering calls

Make sure to install the batteries.

- 1** Press **[HEADSET]** to make or answer a call.
OR
Dial the number and press **[HEADSET]** to make a call.
 - If you misdial during pre-dialing, press **[CLEAR]** and enter the correct number. Then press **[HEADSET]** for dialing.
- 2** To hang up, press **[HEADSET]**.

To adjust the headset receiver volume (4 levels):

While using the headset, press **[▲]** or **[▼]**.

- During a conversation using the headset, you cannot switch the call to the handset by lifting it off the cradle.
- If you disconnect the optional headset during a conversation with the handset on the cradle, the call will be switched to the speakerphone.
- During a conversation using the speakerphone, you can switch the call to the headset by connecting the headset.

Useful Information

Desk mount setup

This unit can be used in 2 positions.

Low desk position (default)

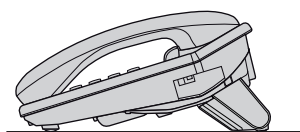

High desk position

— You can adjust the wall mount adaptor to slope this unit.

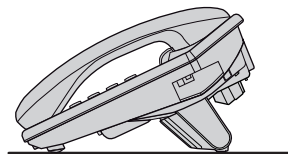

— Changing to the high desk position.

1. Press the tab in the direction of the arrow (1), then remove the wall mount adaptor (2).
2. To attach the wall mount adaptor to high (1), push it in the direction of arrows ((1) and (2)) as shown.

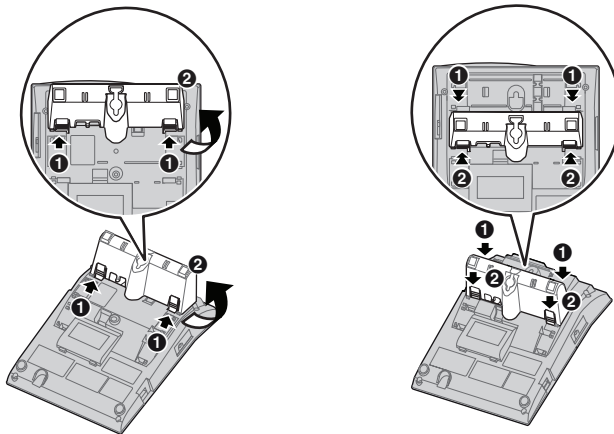

Useful Information

Wall mount setup

This unit can be mounted on a wall phone plate.

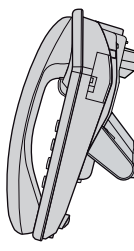

- 1** Pull down the handset hook until it locks, so the tabs holds the handset.

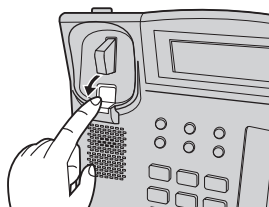

- 2** Press the tabs in the direction of the arrows (1), then remove the wall mount adaptor (2).

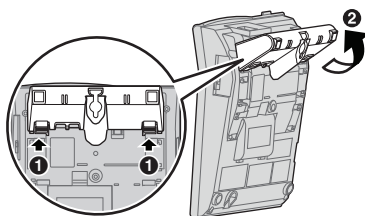

Low desk position

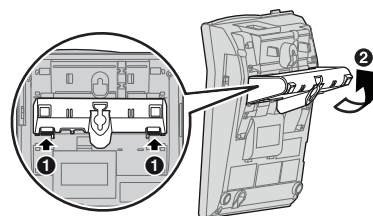

High desk position

- 3** Tuck the telephone line cord inside the wall mount adaptor, and push it in the direction of the arrow.

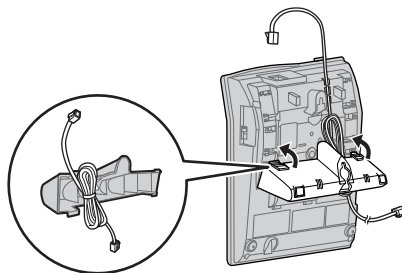

Useful Information

- 4** Drive screws (not included) into the wall using the wall template below. Connect the telephone line cord. Mount the unit, and then slide it down.

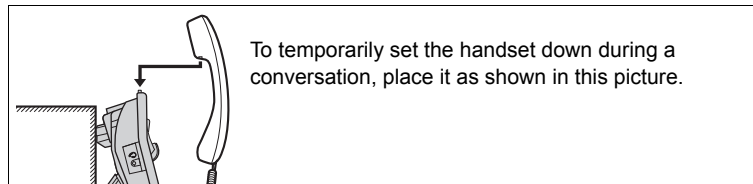
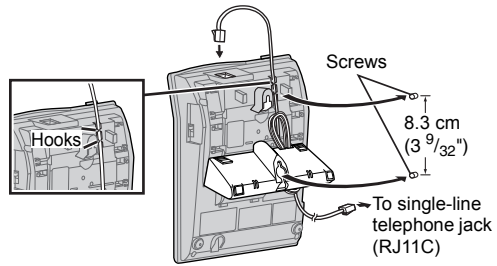

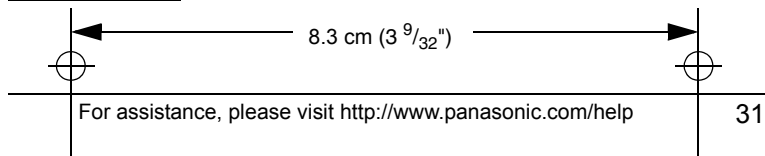

Wall Template





Useful Information

Troubleshooting

Problem	Cause/solution
The unit does not work.	<ul style="list-style-type: none"> • Check the connections (page 9). • Remove the batteries and reinstall them to reset the unit.
I cannot hear a dial tone.	<ul style="list-style-type: none"> • Disconnect the unit from the telephone line and connect the line to a known working telephone. If the working telephone operates properly, contact our service personnel to have the unit repaired. If the working telephone does not operate properly, contact your service provider/telephone company.
The unit does not ring.	<ul style="list-style-type: none"> • The RINGER selector is set to OFF. Set to HIGH or LOW (page 13).
The display is blank.	<ul style="list-style-type: none"> • Install new batteries (page 8).
LCD display response is slow.	<ul style="list-style-type: none"> • Change LCD contrast setting to higher level (page 21). • Batteries are running low. Install or replace the batteries.
You cannot dial.	<ul style="list-style-type: none"> • Check the dial tone. If there is no dial tone, check the connections (page 9). • The dialing mode may be set incorrectly. Change the settings (page 11). • The dialed number is restricted. To cancel, see page 22.
The other party suddenly cannot hear your voice during a conversation.	<ul style="list-style-type: none"> • [MUTE] may have been pressed during the conversation. To cancel, press [MUTE] again (page 14).
You cannot program items such as the dialing mode.	<ul style="list-style-type: none"> • Programming is not possible when: <ul style="list-style-type: none"> – the handset is off the cradle. – viewing caller information. – “” is displayed. – “” is displayed. • Do not pause for over 60 seconds while programming.
You cannot make long distance calls.	<ul style="list-style-type: none"> • Make sure that you have long distance service.

Useful Information

Problem	Cause/solution
Caller information is not displayed.	<ul style="list-style-type: none"> You need to subscribe to Caller ID service. Consult your service provider/telephone company for details. Install or replace the batteries. If your unit is connected to any additional telephone equipment such as a Caller ID box or cordless telephone line jack, plug the unit directly into the wall jack. If you use a DSL /ADSL service, we recommend connecting a DSL /ADSL filter between the unit and the telephone line jack. Contact your DSL /ADSL provider for details. The name display service may not be available in some areas. Contact your service provider/ telephone company for details. Other telephone equipment may be interfering with your phone. Disconnect it and try again.
Number of missed calls does not display during standby mode.	<ul style="list-style-type: none"> You have entered the caller list before and there is no new missed call coming in after that. If there are unviewed missed calls, number of missed calls will be displayed when you enter the caller list.
You cannot store a name and phone number in memory.	<ul style="list-style-type: none"> Programming is not possible when: <ul style="list-style-type: none"> the handset is off the cradle. “” is displayed. “” is displayed. Check that the batteries are installed in the unit and the battery power is not low. Do not pause for over 60 seconds while storing. Do not enter a phone number more than 32 digits long. When using the call restriction feature (page 22), you cannot store emergency numbers (#). If “Phonebook full” is displayed, erase other stored items from the phonebook memory (page 19).
The caller list/incoming phone numbers are not edited automatically.	<ul style="list-style-type: none"> The Caller ID number auto edit feature is turned off. Turn it on and try again (page 20). You need to call back the edited number to activate Caller ID number auto edit.
You cannot dial the phone number edited in the caller list.	<ul style="list-style-type: none"> The phone number you dialed might have been edited incorrectly (for example, the long distance “1” or the area code is missing). Edit the phone number with another pattern (page 24).

Useful Information

Problem	Cause/solution
The 2nd caller's information is not displayed during an outside call.	<ul style="list-style-type: none"> In order to use Caller ID, call waiting, or Call Waiting Caller ID (CWID), you must first contact your service provider/telephone company and subscribe to the desired service. After subscribing, you may need to contact your service provider/telephone company again to activate this specific service, even if you already subscribed to both Caller ID and Call Waiting with Caller ID services (CWID).
While programming or searching, the unit starts to ring and stops the program/search.	<ul style="list-style-type: none"> A call is being received. Answer the call and start again after hanging up.
The display exits the caller list.	<ul style="list-style-type: none"> Do not pause for over 60 seconds while searching.
You cannot redial by pressing [REDIAL] .	<ul style="list-style-type: none"> If the last number dialed was more than 32 digits long, the number will not be redialed correctly.
Information stored in the redial list is erased.	<ul style="list-style-type: none"> If " " flashes, replace the batteries as soon as possible. Otherwise, information stored in the redial list will be erased. Store the desired item in the phonebook, one-touch dial or speed dial memory before the battery replacement.

Liquid damage

Problem	Cause/solution
Liquid or other form of moisture has entered the unit.	<ul style="list-style-type: none"> Disconnect the telephone line cord from the unit. Remove the batteries from the unit and leave to dry for at least 3 days. After the unit is completely dry, reconnect the telephone line cord. Insert the batteries.

Caution:

- To avoid permanent damage, do not use a microwave oven to speed up the drying process.

Useful Information

FCC and other information

This equipment complies with Part 68 of the FCC rules and the requirements adopted by the ACTA. On the bottom of this equipment is a label that contains, among other information, a product identifier in the format US:ACJ-----. If requested, this number must be provided to the telephone company.

- Registration No.(found on the bottom of the unit)
- Ringer Equivalence No. (REN).....1.0B

A plug and jack used to connect this equipment to the premises wiring and telephone network must comply with the applicable FCC Part 68 rules and requirements adopted by the ACTA. A compliant telephone cord and modular plug is provided with the product. It is designed to be connected to a compatible modular jack that is also compliant.

The REN is used to determine the number of devices that may be connected to a telephone line. Excessive RENs on a telephone line may result in the devices not ringing in response to an incoming call. In most but not all areas, the sum of RENs should not exceed five (5.0). To be certain of the number of devices that may be connected to a line, as determined by the total RENs, contact the local telephone company. For products approved after July 23, 2001, the REN for this product is part of the product identifier that has the format US:AAAEQ##TXXXX. The digits represented by ## are the REN without a decimal point (e.g., 03 is a REN of 0.3).

If this equipment causes harm to the telephone network, the telephone company will notify you in advance that temporary discontinuance of service may be required. But if advance notice isn't practical, the telephone company

will notify the customer as soon as possible. Also, you will be advised of your right to file a complaint with the FCC if you believe it is necessary.

The telephone company may make changes in its facilities, equipment, operations or procedures that could affect the operation of the equipment. If this happens the telephone company will provide advance notice in order for you to make necessary modifications to maintain uninterrupted service.

If trouble is experienced with this equipment, for repair or warranty information, please contact a Factory Service Center or other Authorized Servicer. If the equipment is causing harm to the telephone network, the telephone company may request that you disconnect the equipment until the problem is resolved.

Connection to party line service is subject to state tariffs. Contact the state public utility commission, public service commission or corporation commission for information.

If your home has specially wired alarm equipment connected to the telephone line, ensure the installation of this equipment does not disable your alarm equipment. If you have questions about what will disable alarm equipment, consult your telephone company or a qualified installer.

This device complies with Part 15 of the FCC Rules. Operation is subject to the following two conditions: (1) This device may not cause harmful interference, and (2) this device must accept any interference received, including interference that may cause undesired operation.

CAUTION:

Any changes or modifications not expressly approved by the party responsible for compliance could void the user's authority to operate this device.

Useful Information

Note:

This equipment has been tested and found to comply with the limits for a Class B digital device, pursuant to Part 15 of the FCC Rules. These limits are designed to provide reasonable protection against harmful interference in a residential installation. This equipment generates, uses, and can radiate radio frequency energy and, if not installed and used in accordance with the instructions, may cause harmful interference to radio communications. However, there is no guarantee that interference will not occur in a particular installation. If this equipment does cause harmful interference to radio or television reception, which can be determined by turning the equipment off and on, the user is encouraged to try to correct the interference by one or more of the following measures:

- Reorient or relocate the receiving antenna.
- Increase the separation between the equipment and receiver.
- Connect the equipment into an outlet on a circuit different from that to which the receiver is connected.
- Consult the dealer or an experienced radio/TV technician for help.

This equipment is hearing aid compatible as defined by the FCC in 47 CFR Section 68.316.

Compliance with TIA-1083 standard:

Telephone handsets identified with this logo have reduced noise and interference when used with T-Coil equipped hearing aids and cochlear implants.

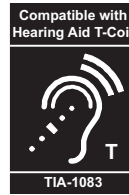

Guía Rápida en Español

Guía rápida en español

Configuración

Instalación de las baterías

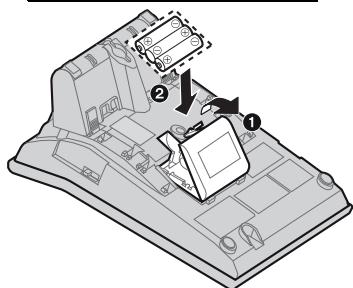

- 1 Presione hacia abajo en dirección de la flecha y abra la tapa (1).
- 2 Instale las baterías en el orden apropiado como se muestra (2), colocando las polaridades en las posiciones correctas.
- 3 Cierre la tapa de las baterías.
 - Las baterías no vienen incluidas con la unidad.

Cómo conectar el cable del auricular/línea telefónica

- Use sólo un auricular Panasonic para KX-TS880.
- Use sólo el cable para línea telefónica suministrado con el teléfono.

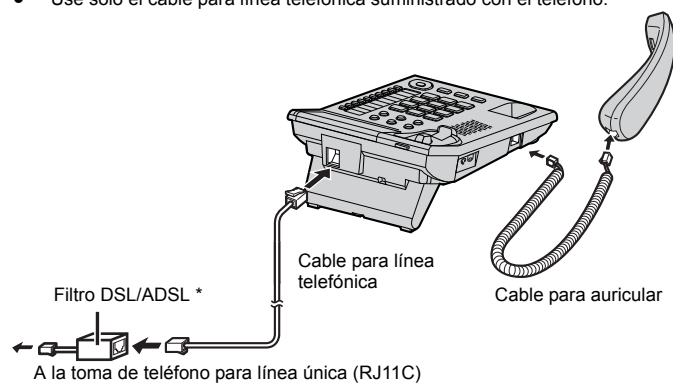

* El filtro DSL/ADSL (no incluido) es necesario si tiene servicio DSL/ADSL.

Guía Rápida en Español

Consejos de operación

Cómo usar la tecla del navegador y el botón [OK]

Esta tecla tiene cinco áreas activas que están indicadas por flechas y por [OK].



- Presionar las flechas hacia arriba y hacia abajo le permite entrar a la lista de personas que llaman y desplazarse a través del menú de funciones.
- Presionar las flechas hacia la derecha y la izquierda le permite entrar al directorio telefónico y mover el cursor al introducir elementos. La flecha hacia la derecha también se usa para seleccionar el elemento deseado.
- El botón [OK] se usa para seleccionar y confirmar el elemento deseado.

A lo largo de esta Guía Rápida, la tecla de navegación está representada por las flechas [▼], [▲], [◀] o [▶] y [OK].

Idioma de la pantalla (Valor predeterminado: Inglés)

- 1 [PROGRAM/EXIT] → [▼] / [▲]: "Change language?" → [OK]
- 2 [▼] / [▲]: Seleccione la configuración deseada → [OK]
→ [PROGRAM/EXIT]

Fecha y hora

- 1 [PROGRAM/EXIT] → [▼] / [▲]: "Set clock ?" → [OK]
- 2 Introduzca el año actual al seleccionar 2 dígitos para cada uno.
 - Para configurar 2010, introduzca "10".
- 3 [OK]
- 4 Introduzca la hora y los minutos actuales al seleccionar 2 dígitos para cada uno.
 - Para configurar 9:30PM, introduzca "0930".
- 5 [OK]
- 6 Pulse [⌘] para seleccionar "AM", "PM" o reloj de 24 horas.
- 7 [OK]
- 8 Introduzca el día y el mes actual al seleccionar 2 dígitos para cada uno.
 - Para configurar "15 de julio", introduzca "0715".
- 9 [OK] → [PROGRAM/EXIT]

Modo de marcación (Valor predeterminado: TONO)

- 1 [PROGRAM/EXIT] → [▼] / [▲]: "Program ?" → [OK]
- 2 [▼] / [▲]: "Set dial mode ?" → [OK]
- 3 [▼] / [▲]: Seleccione la configuración deseada → [OK]
→ [PROGRAM/EXIT]

Guía Rápida en Español

Operaciones básicas	
Cómo realizar y responder llamadas	
Para hacer llamadas	Levante el auricular o presione [SP-PHONE] → Marque el número telefónico.
Para contestar llamadas	Levante el auricular o presione [SP-PHONE] .
Cómo colgar	Coloque en auricular en la base o presione [SP-PHONE] .
Cómo modificar el volumen del auricular o del altavoz manos libres	Presione [▲] o [▼] repetidas veces mientras esté hablando.
Cómo realizar una llamada usando la lista de remarcación	1 [REDIAL] → [▼] / [▲] : Seleccione el número telefónico deseado. 2 Levante el auricular o presione [SP-PHONE] para comenzar a llamar.
Cómo modificar el volumen de timbrado de la unidad	Seleccionar el volumen del timbre en HIGH (alto), LOW (bajo) y OFF (desactivado). La configuración predeterminada es HIGH (alto).

Marcación con un solo toque	
Memoria SUPERIOR	
Cómo guardar números telefónicos	
1 [PROGRAM/EXIT] → [▼] / [▲] : "Save one touch ?" → [OK]	
2 Introduzca el nombre de la persona (máximo de 15 caracteres) → [OK]	
3 Introduzca el número telefónico de la persona (máximo de 32 dígitos) → [OK]	
4 Presione un número de marcación de un solo toque.	
5 [PROGRAM/EXIT]	
Para borrar un número almacenado	
1 Presione un número de marcación de un solo toque.	
2 [CLEAR] → [OK]	
Marcación de un número almacenado	
1 Levante el auricular o presione [SP-PHONE] .	
2 Presione un número de marcación de un solo toque.	
O	
1 Presione un número de marcación de un solo toque.	
2 Levante el auricular o presione [SP-PHONE] .	

Guía Rápida en Español

Memoria INFERIOR

Cómo guardar números telefónicos

- 1** [PROGRAM/EXIT] → [▼] / [▲]: "Save one touch ?" → [OK]
- 2** Introduzca el nombre de la persona (máximo de 15 caracteres) → [OK]
- 3** Introduzca el número telefónico de la persona (máximo de 32 dígitos) → [OK]
- 4** [AUTO/LOWER] → Presione un número de marcación de un solo toque.
- 5** [PROGRAM/EXIT]

Para borrar un número almacenado

- 1** [AUTO/LOWER] → Presione un número de marcación de un solo toque.
- 2** [CLEAR] → [OK]

Marcación de un número almacenado

- 1** Levante el auricular o presione [SP-PHONE].
- 2** [AUTO/LOWER] → Presione un número de marcación de un solo toque.
o
- 1** [AUTO/LOWER] → Presione un número de marcación de un solo toque.
- 2** Levante el auricular o presione [SP-PHONE].

Marcación rápida

Cómo guardar números telefónicos

- 1** [PROGRAM/EXIT] → [▼] / [▲]: "Save speed dial?" → [OK]
- 2** Introduzca el nombre de la persona (máximo de 15 caracteres) → [OK]
- 3** Introduzca el número telefónico de la persona (máximo de 32 dígitos) → [OK]
- 4** Presione un número de estación de memoria ([0] a [9]).
- 5** [PROGRAM/EXIT]

Para borrar un número almacenado

- 1** [AUTO/LOWER] → Presione un número de estación de memoria ([0] a [9]) para el número que será borrado.
- 2** [CLEAR] → [OK]

Marcación de un número almacenado

- 1** Levante el auricular o presione [SP-PHONE].
- 2** [AUTO/LOWER] → Presione un número de estación de memoria ([0] a [9]).
o
- 1** [AUTO/LOWER] → Presione un número de estación de memoria ([0] a [9]) para el número que será borrado.
- 2** Levante el auricular o presione [SP-PHONE].

Guía Rápida en Español

Directorio telefónico

Cómo añadir entradas

- 1** **[PROGRAM/EXIT]** → **[▼]** / **[▲]**: "Save phonebook ?" → **[OK]**
 - La pantalla mostrará la cantidad de elementos almacenados.
- 2** Introduzca el nombre de la persona (máximo de 15 caracteres) → **[OK]**
- 3** Introduzca el número telefónico de la persona (máximo de 32 dígitos) → **[OK]**
- 4** **[PROGRAM/EXIT]**

Tabla de caracteres para introducir los nombres

Tecla	Carácter	Tecla	Carácter
[1]	& ' () , - . / 1	[7]	p q r s P Q R S 7
[2]	a b c A B C 2	[8]	t u v T U V 8
[3]	d e f D E F 3	[9]	w x y z W X Y Z 9
[4]	g h i G H I 4	[0]	0 Espacio
[5]	j k l J K L 5	[*]	*
[6]	m n o M N O 6	[#]	#

- Para introducir otro carácter que esté ubicado en la misma tecla de marcado, presione **[▶]** para mover el cursor al siguiente espacio.

Cómo corregir un error

Presione **[◀]** o **[▶]** para mover el cursor al carácter o número que desee borrar, después presione **[CLEAR]**. Introduzca el carácter o número adecuado.

- Presione y sujete **[CLEAR]** para borrar todos los caracteres o números.

Para hacer llamadas

- 1** Presione **[◀]** o **[▶]** para entrar a la lista del directorio telefónico.
- 2** **[▼]** / **[▲]**: Seleccione la entrada deseada.
- 3** Levante el auricular o presione **[SP-PHONE]** para comenzar a llamar.

Guía Rápida en Español

Cómo usar el servicio de identificación de llamadas

Importante:

- Esta unidad es compatible con el identificador de llamadas. Para usar las funciones del identificador de llamadas usted debe suscribirse al servicio de identificación de llamadas. Contacte su proveedor de servicios/compañía telefónica para más detalles.

Funciones del identificador de llamadas

Cuando se reciba una llamada desde el exterior, se visualizará el nombre y el teléfono. La información de las 50 últimas llamadas estará almacenada en la lista desde la llamada más reciente hasta la más antigua. Cuando se recibe la llamada número 51, la llamada más antigua se borra.

- Si la unidad no puede recibir información de la persona que llama, se visualizará lo siguiente:
 - "Out of area": La persona que llama marcó desde un área que no ofrece servicio de identificación de llamada.
 - "Private caller": La persona que llama solicitó no enviar información de quien llama.
 - "Long distance": La persona que llama realizó una llamada de larga distancia.
- Si la unidad está conectada a un sistema PBX, puede que la información de quien llama no se reciba adecuadamente. Contacte su proveedor PBX.
- Si se han agotado las baterías instaladas en la unidad, los servicios de identificación de llamadas no estarán disponibles.

Llamadas perdidas

Si no se contesta una llamada, la unidad la tratará como una llamada perdida. La pantalla mostrará la cantidad de llamadas perdidas mientras la unidad no esté en uso. Esto le permite saber si usted debe visualizar la lista de llamadas para ver quien llamó mientras estuvo ausente.

Si ha entrado a la lista de llamadas anteriormente y no hay una llamada perdida nueva entrante después de eso, la cantidad de llamadas perdidas no se visualizará en modo de espera.

- Si hay llamadas perdidas no visualizadas, la cantidad de llamadas perdidas se visualizará cuando entre a la lista de llamadas.

Visualización de número privado

Cuando se reciba la información de la persona que llama y la misma corresponda con un número almacenado en el directorio telefónico, el nombre almacenado en el directorio telefónico se visualizará y se registrará en la lista de llamadas.

Guía Rápida en Español

Lista de personas que llaman

Cómo visualizar la lista de llamadas y devolver la llamada

- 1** Presione **[▼]** o **[▲]** para entrar en la lista de personas que llaman.
- 2** Presione **[▼]** para buscar desde la llamada más reciente, o **[▲]** para buscar desde la llamada más antigua.
- 3** Para devolver una llamada, levante el auricular o presione **[SP-PHONE]**.
Para salir, presione **[PROGRAM/EXIT]**.

Cómo editar un número telefónico antes de devolver la llamada

- 1** Presione **[▼]** o **[▲]** para entrar en la lista de personas que llaman.
- 2** **[▼]** / **[▲]**: Seleccione la entrada deseada → **[OK]**
- 3** Presione **[▶]** repetidas veces hasta que el número aparezca con el formato deseado.
 - Ⓐ Número telefónico local
Ejemplo: 321-5555
 - Ⓑ Código de área - Número telefónico local
Ejemplo: 555-321-5555
 - Ⓒ 1 - Código de área - Número telefónico local
Ejemplo: 1-555-321-5555
- 4** Para devolver una llamada, levante el auricular o presione **[SP-PHONE]**.

Cómo borrar la información seleccionada de la persona que llama

- 1** Presione **[▼]** o **[▲]** para entrar en la lista de personas que llaman.
- 2** **[▼]** / **[▲]**: Seleccione la entrada deseada.
- 3** **[CLEAR]** → **[PROGRAM/EXIT]**

Cómo borrar toda la información de la persona que llama

- 1** **[CLEAR]** → **[OK]** → **[PROGRAM/EXIT]**

Guía Rápida en Español

Cómo almacenar la información de la persona que llama en el directorio telefónico

- 1** Presione [▼] o [▲] para entrar en la lista de personas que llaman.
- 2** [▼] / [▲]: Seleccione la entrada deseada → [OK]
 - Para editar el número, presione [▶] repetidas veces hasta que el número aparezca con el formato deseado.
- 3** [OK]
 - Si hay alguna información de nombre para quien llama, vaya al paso 5.
- 4** Introduzca el nombre de la persona (máximo de 15 caracteres) → [OK]
- 5** “▼ Phonebook?” → [OK]
- 6** [PROGRAM/EXIT]

Cómo almacenar la información de quién llama en el marcado de un toque

- 1** Presione [▼] o [▲] para entrar en la lista de personas que llaman.
- 2** [▼] / [▲]: Seleccione la entrada deseada → [OK]
 - Para editar el número, presione [▶] repetidas veces hasta que el número aparezca con el formato deseado.
- 3** [OK]
 - Si hay alguna información de nombre para quien llama, vaya al paso 5.
- 4** Introduzca el nombre de la persona (máximo de 15 caracteres) → [OK]
- 5** Presione [▼] → “▼▲ One touch?” → [OK]
- 6** Presione un número de marcación de un solo toque.
- 7** [PROGRAM/EXIT]

Cómo almacenar información de quién llama en el marcado rápido

- 1** Presione [▼] o [▲] para entrar en la lista de personas que llaman.
- 2** [▼] / [▲]: Seleccione la entrada deseada → [OK]
 - Para editar el número, presione [▶] repetidas veces hasta que el número aparezca con el formato deseado.
- 3** [OK]
 - Si hay alguna información de nombre para quien llama, vaya al paso 5.
- 4** Introduzca el nombre de la persona (máximo de 15 caracteres) → [OK]
- 5** Presione [▼] dos veces → “▲ Speed dial?” → [OK]
- 6** Presione un número de estación de memoria ([0] a [9]).
- 7** [PROGRAM/EXIT]

Appendix

Customer services

Customer Services Directory (United States and Puerto Rico)

Obtain Product Information and Operating Assistance; locate your nearest Dealer or Service Center; purchase Parts and Accessories; or make Customer Service and Literature requests by visiting our Web site at:

<http://www.panasonic.com/help>

or, contact us via the web at:

<http://www.panasonic.com/contactinfo>

You may also contact us directly at: 1-800-211-PANA (1-800-211-7262), Monday-Friday 9 am to 9 pm; Saturday-Sunday 10 am to 7 pm, EST.

TTY users (hearing or speech impaired users) can call 1-877-833-8855.

Accessory Purchases (United States and Puerto Rico)

Purchase Parts, Accessories and Instruction Books online for all Panasonic Products by visiting our Web Site at:

<http://www.pstc.panasonic.com>

or, send your request by E-mail to:

npcparts@us.panasonic.com

You may also contact us directly at:

1-800-332-5368 (Phone) 1-800-237-9080 (Fax only)

(Monday-Friday 9 am to 9 pm, EST.)

Panasonic Service and Technology Company

20421 84th Avenue South, Kent, WA 98032

(We Accept Visa, MasterCard, Discover Card, American Express, and Personal Checks.)

TTY users (hearing or speech impaired users) can call 1-866-605-1277.

Appendix

Warranty (For United States and Puerto Rico)

PANASONIC CORPORATION OF NORTH AMERICA
One Panasonic Way, Secaucus, New Jersey 07094

Panasonic Telephone Products Limited Warranty

Limited Warranty Coverage

If your product does not work properly because of a defect in materials or workmanship, Panasonic Corporation of North America (referred to as "the warrantor") will, for the length of the period indicated on the chart below, which starts with the date of original purchase ("Limited Warranty period"), at its option either (a) repair your product with new or refurbished parts, or (b) replace it with a new or a refurbished product. The decision to repair or replace will be made by the warrantor.

Parts	Labor
One (1) Year	One (1) Year

During the "Labor" Limited Warranty period there will be no charge for labor. During the "Parts" Limited Warranty period, there will be no charge for parts. You must mail-in your product prepaid during the Limited Warranty period. This Limited Warranty excludes both parts and labor for batteries, antennas, and cosmetic parts (cabinet). This Limited Warranty only applies to products purchased and serviced in the United States or Puerto Rico. This Limited Warranty is extended only to the original purchaser and only covers products purchased as new.

Ship-In Service

For assistance in the continental United States and Puerto Rico in obtaining repairs please ship the product prepaid to:

PSTC (Panasonic) Exchange Center,
4900 George McVay Drive, Suite B Door #12, McAllen, TX 78503
panacare@us.panasonic.com

When shipping the unit carefully pack in a padded shipping carton, include all accessories, and send it prepaid. Include a letter detailing the complaint, a return address and provide a day time phone number where you can be reached. P.O. Boxes are not acceptable. Keep the tracking number for your records. A copy of valid registered receipt is required under the 1 year parts and labor Limited Warranty.

For Limited Warranty service for headsets if a headset is included with this product please follow instructions above.

IF REPAIR IS NEEDED DURING THE LIMITED WARRANTY PERIOD THE PURCHASER WILL BE REQUIRED TO FURNISH A SALES RECEIPT/PROOF OF PURCHASE INDICATING DATE OF PURCHASE, AMOUNT PAID AND PLACE OF PURCHASE. CUSTOMER WILL BE CHARGED FOR THE REPAIR OF ANY UNIT RECEIVED WITHOUT SUCH PROOF OF PURCHASE.

Appendix

Limited Warranty Limits And Exclusions

This Limited Warranty ONLY COVERS failure due to defects in materials or workmanship, and DOES NOT COVER normal wear and tear or cosmetic damage. The Limited Warranty ALSO DOES NOT COVER damages which occurred in shipment, or failures which are caused by products not supplied by the warrantor, or failures which result from accidents, misuse, abuse, neglect, bug infestation, mishandling, misapplication, alteration, faulty installation, set-up adjustments, misadjustment of consumer controls, improper maintenance, power line surge, lightning damage, modification, introduction of sand, humidity or liquids, commercial use such as hotel, office, restaurant, or other business or rental use of the product, or service by anyone other than a Factory Service Center or other Authorized Servicer, or damage that is attributable to acts of God.

THERE ARE NO EXPRESS WARRANTIES EXCEPT AS LISTED UNDER "LIMITED WARRANTY COVERAGE". THE WARRANTOR IS NOT LIABLE FOR INCIDENTAL OR CONSEQUENTIAL DAMAGES RESULTING FROM THE USE OF THIS PRODUCT, OR ARISING OUT OF ANY BREACH OF THIS LIMITED WARRANTY. (As examples, this excludes damages for lost time, lost calls or messages, cost of having someone remove or re-install an installed unit if applicable, travel to and from the servicer. The items listed are not exclusive, but are for illustration only.) **ALL EXPRESS AND IMPLIED WARRANTIES, INCLUDING THE WARRANTY OF MERCHANTABILITY, ARE LIMITED TO THE PERIOD OF THE LIMITED WARRANTY.**

Some states do not allow the exclusion or limitation of incidental or consequential damages, or limitations on how long an implied warranty lasts, so the exclusions may not apply to you.

This Limited Warranty gives you specific legal rights and you may also have other rights which vary from state to state. If a problem with this product develops during or after the Limited Warranty period, you may contact your dealer or Service Center. If the problem is not handled to your satisfaction, then write to the warrantor's Consumer Affairs Department at the addresses listed for the warrantor.

PARTS AND SERVICE, WHICH ARE NOT COVERED BY THIS LIMITED WARRANTY, ARE YOUR RESPONSIBILITY.

When you ship the product

- Carefully pack your unit, preferably in the original carton.
- Attach a letter, detailing the symptom.
- Send the unit to PSTC (Panasonic) Exchange Center, prepaid and adequately insured.
- Do not send your unit to Panasonic Corporation of North America listed on the back cover or to executive or regional sales offices. These locations do not repair consumer products.

Index

Index

- A** Accessories: 3
Answering calls: 13
- B** Battery: 8
- C** Call restriction: 22
Call waiting: 14
Caller ID service: 23
Caller list: 24
Chain dial: 19
Connections: 9
Controls: 6
- D** Date and time: 11
Desk mount setup: 29
Dialing mode: 11
Display: 7
Display language: 11
DSL/ADSL service users: 9
- F** Flash: 14
- H** Headset: 28
Hold: 14
- I** Index card: 16
- L** LOWER memory: 15
- M** Making calls: 12
- N** Navigator key: 6
- O** One-touch dialer: 15
- P** Password: 22
Pause: 13
Phonebook: 18
- R** Redial: 12
Rotary/pulse service: 14
- S** Speed dialer: 17
- T** Temporary tone dialing: 14
Troubleshooting: 32
- U** UPPER memory: 15
- V** Voice mail: 27
Volume
Handset: 12
Ringer: 13
- W** Wall mount setup: 30

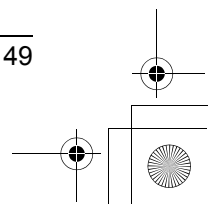
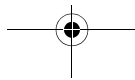
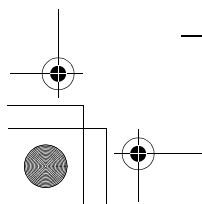
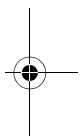
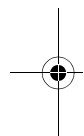
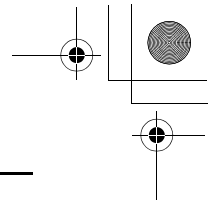
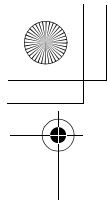

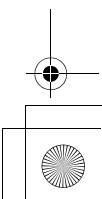
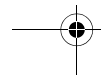
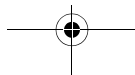
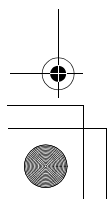
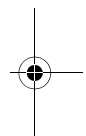
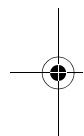
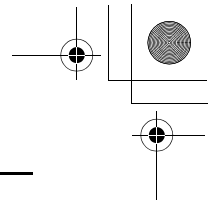
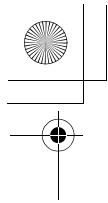

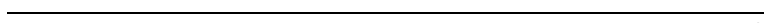
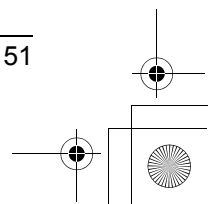
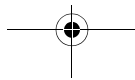
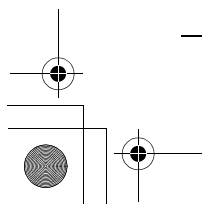
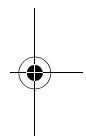
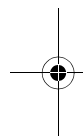
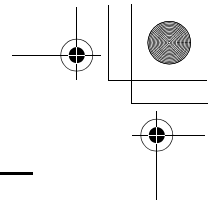
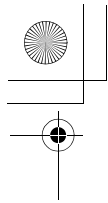

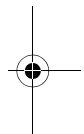
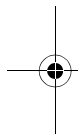
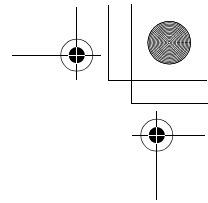
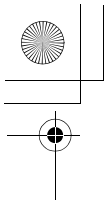

Panasonic Corporation of North America
One Panasonic Way, Secaucus, New Jersey 07094

Copyright:

This material is copyrighted by Panasonic System Networks Malaysia Sdn. Bhd., and may be reproduced for internal use only. All other reproduction, in whole or in part, is prohibited without the written consent of Panasonic System Networks Malaysia Sdn. Bhd.

© Panasonic System Networks Malaysia Sdn. Bhd. 2010



TS880

PNQX2837ZA FM0810NE0

Printed in Malaysia

