

# Panasonic<sup>®</sup>

## Operating Instructions

---

### Digital Cordless Phone

Model No. **KX-TGC380C**  
**KX-TGC382C**  
**KX-TGC383C**  
**KX-TGC384C**



Model shown is KX-TGC380.

***Before initial use, see “Getting Started”  
on page 8.***

**Thank you for purchasing a Panasonic product.**

Please read these operating instructions before using the unit and save them for future reference.

For assistance, please visit our Support page:

**[www.panasonic.ca/english/support](http://www.panasonic.ca/english/support)**

## Table of Contents

---

<b>Introduction</b>		<b>Index</b>	
Model composition .....	3	Index.....	30
Accessory information .....	3		
<b>Important Information</b>			
For your safety .....	5		
Important safety instructions .....	6		
For best performance .....	6		
Other information .....	7		
Specifications .....	7		
<b>Getting Started</b>			
Setting up .....	8		
Controls .....	9		
Display icons .....	10		
Language settings .....	10		
Date and time .....	10		
Other settings .....	10		
<b>Making/Answering Calls</b>			
Making calls .....	11		
Answering calls .....	11		
Useful features during a call .....	11		
Intercom .....	12		
<b>Phonebook</b>			
Phonebook .....	13		
Speed dial .....	14		
<b>Programming</b>			
Menu list .....	16		
Alarm .....	19		
Night mode .....	19		
Call block .....	19		
Other programming .....	20		
Registering a handset to the base unit .....	20		
<b>Caller ID Service</b>			
Using Caller ID service .....	21		
Caller list .....	22		
<b>Useful Information</b>			
Voicemail service .....	23		
Error messages .....	24		
Troubleshooting .....	24		
Wall mounting (Charger only) .....	27		
Industry Canada Notices and other information .....	28		
Warranty .....	29		

## Model composition

Series	Model No.	Base unit	Handset	
		Part No.	Part No.	Quantity
KX-TGC380 series	KX-TGC380	KX-TGC380	KX-TGCA38	1
	KX-TGC382	KX-TGC380	KX-TGCA38	2
	KX-TGC383	KX-TGC380	KX-TGCA38	3
	KX-TGC384	KX-TGC380	KX-TGCA38	4

## Accessory information

### Supplied accessories

No.	Accessory item/ Part number	Quantity			
		KX-TGC380	KX-TGC382	KX-TGC383	KX-TGC384
①	AC adaptor/PNLV226	1	1	1	1
②	Telephone line cord	1	1	1	1
③	Rechargeable batteries*1	2	4	6	8
④	Handset cover*2	1	2	3	4
⑤	Charger	–	1	2	3

\*1 See page 4 for replacement battery information.

\*2 The handset cover comes attached to the handset.



## Introduction

---

### Additional/replacement accessories

Please contact your nearest Panasonic dealer for sales information.

Accessory item	Model number/Specifications
Rechargeable batteries	HHR-4DPA
	Battery type: <ul style="list-style-type: none"><li>– Nickel metal hydride (Ni-MH)</li><li>– 2 x AAA (R03) size for each handset</li></ul>

### Expanding your phone system

Handset (optional): KX-TGDA20C
You can expand your phone system by registering optional handsets (6 max.) to a single base unit.

## Important Information

### For your safety

To prevent severe injury and loss of life/property, read this section carefully before using the product to ensure proper and safe operation of your product.

#### WARNING

##### Power connection

- Use only the power source marked on the product.
- Do not overload power outlets and extension cords. This can result in the risk of fire or electric shock.
- Completely insert the AC adaptor/power plug into the power outlet. Failure to do so may cause electric shock and/or excessive heat resulting in a fire.
- Regularly remove any dust, etc. from the AC adaptor/power plug by pulling it from the power outlet, then wiping with a dry cloth. Accumulated dust may cause an insulation defect from moisture, etc. resulting in a fire.
- Unplug the product from power outlets if it emits smoke, an abnormal smell, or makes an unusual noise. These conditions can cause fire or electric shock. Confirm that smoke has stopped emitting and contact us by visiting our Support page: [www.panasonic.ca/english/support](http://www.panasonic.ca/english/support)
- Unplug from power outlets and never touch the inside of the product if its casing has been broken open.
- Never touch the plug with wet hands. Danger of electric shock exists.

##### Installation

- To prevent the risk of fire or electrical shock, do not expose the product to rain or any type of moisture.
- Do not place or use this product near automatically controlled devices such as automatic doors and fire alarms. Radio waves emitted from this product may cause such devices to malfunction resulting in an accident.

- Do not allow the AC adaptor or telephone line cord to be excessively pulled, bent or placed under heavy objects.

##### Operating safeguards

- Unplug the product from power outlets before cleaning. Do not use liquid or aerosol cleaners.
- Do not disassemble the product.
- Do not spill liquids (detergents, cleansers, etc.) onto the telephone line cord plug, or allow it to become wet at all. This may cause a fire. If the telephone line cord plug becomes wet, immediately pull it from the telephone wall jack, and do not use.

##### Medical

- Consult the manufacturer of any personal medical devices, such as pacemakers or hearing aids, to determine if they are adequately shielded from external RF (radio frequency) energy. (The product operates in the frequency range of 1.92 GHz to 1.93 GHz, and the RF transmission power is 115 mW (max.).)
- Do not use the product in health care facilities if any regulations posted in the area instruct you not to do so. Hospitals or health care facilities may be using equipment that could be sensitive to external RF energy.

#### CAUTION

##### Installation and location

- Never install telephone wiring during an electrical storm.
- Never install telephone line jacks in wet locations unless the jack is specifically designed for wet locations.
- Never touch uninsulated telephone wires or terminals unless the telephone line has been disconnected at the network interface.
- Use caution when installing or modifying telephone lines.
- The AC adaptor is used as the main disconnect device. Ensure that the AC outlet is installed near the product and is easily accessible.

For assistance, visit [www.panasonic.ca/english/support](http://www.panasonic.ca/english/support)

5

## Important Information

- This product is unable to make calls when:
  - the handset batteries need recharging or have failed.
  - there is a power failure.

### Battery

- We recommend using the batteries noted on page 4. **USE ONLY rechargeable Ni-MH batteries AAA (R03) size.**
- Do not mix old and new batteries.
- Do not open or mutilate the batteries. Released electrolyte from the batteries is corrosive and may cause burns or injury to the eyes or skin. The electrolyte is toxic and may be harmful if swallowed.
- Exercise care when handling the batteries. Do not allow conductive materials such as rings, bracelets, or keys to touch the batteries, otherwise a short circuit may cause the batteries and/or the conductive material to overheat and cause burns.
- Charge the batteries provided with or identified for use with this product only, in accordance with the instructions and limitations specified in this manual.
- Only use a compatible base unit (or charger) to charge the batteries. Do not tamper with the base unit (or charger). Failure to follow these instructions may cause the batteries to swell or explode.

#### Attention:



A nickel metal hydride battery that is recyclable powers the product you have purchased.

Please call 1-800-8-BATTERY (1-800-822-8837) for information on how to recycle this battery.

## Important safety instructions

When using your product, basic safety precautions should always be followed to reduce the risk of fire, electric shock, and injury to persons, including the following:

1. Do not use this product near water for example, near a bathtub, washbowl, kitchen sink, or laundry tub, in a wet basement or near a swimming pool.
2. Avoid using a telephone (other than a cordless type) during an electrical storm. There may be a remote risk of electric shock from lightning.
3. Do not use the telephone to report a gas leak in the vicinity of the leak.
4. Use only the power cord and batteries indicated in this manual. Do not dispose of batteries in a fire. They may explode. Check with local codes for possible special disposal instructions.

### SAVE THESE INSTRUCTIONS

## For best performance

### Environment

- The product should be kept free from excessive smoke, dust, high temperature, and vibration.
- When you leave the product unused for a long period of time, unplug the product from the power outlet.
- The product should be kept away from heat sources such as heaters, kitchen stoves, etc. It should not be placed in rooms where the temperature is less than 0 °C (32 °F) or greater than 40 °C (104 °F). Damp basements should also be avoided.
- Operating the product near electrical appliances may cause interference. Move away from the electrical appliances.

## Important Information

### Other information

**CAUTION:** Risk of explosion if battery is replaced by an incorrect type. Dispose of used batteries according to the instructions.

#### Notice for product disposal, transfer, or return

- This product can store your private/confidential information. To protect your privacy/confidentiality, we recommend that you erase information such as phonebook or caller list entries from the memory before you dispose of, transfer, or return the product.

#### Compliance with TIA-1083 standard

Telephone handsets identified with this logo have reduced noise and interference when used with T-Coil equipped hearing aids and cochlear implants.



### Specifications

- **Standard:**  
DECT 6.0 (Digital Enhanced Cordless Telecommunications 6.0)
- **Frequency range:**  
1.92 GHz to 1.93 GHz
- **RF transmission power:**  
115 mW (max.)
- **Power source:**  
120 V AC, 60 Hz
- **Power consumption:**  
**Base unit:**  
Standby: Approx. 0.6 W  
Maximum: Approx. 3.2 W  
**Charger:**  
Standby: Approx. 0.1 W  
Maximum: Approx. 1.8 W
- **Operating conditions:**  
0 °C – 40 °C (32 °F – 104 °F), 20 % – 80 % relative air humidity (dry)

## Getting Started

### Setting up

#### Connections

- 1 Connect the AC adaptor to the unit by pressing the plug firmly.
- 2 Fasten the cord by hooking it.
- 3 Connect the AC adaptor to the power outlet.
- 4 Connect the telephone line cord to the unit, then to the single-line telephone jack (RJ11C) until you hear a click.
- 5 A DSL/ADSL filter (not supplied) is required if you have a DSL/ADSL service.

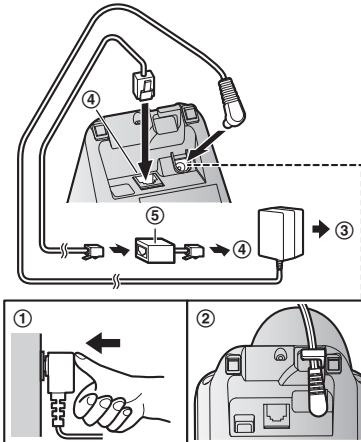

### Battery installation

- USE ONLY rechargeable Ni-MH batteries AAA (R03) size (A).
- Do NOT use alkaline/manganese/Ni-Cd batteries.
- Confirm correct polarities (+, -).

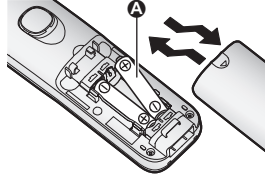

### Battery charging

Charge for about 7 hours.

#### Note for battery charging

- Clean the charge contacts with a soft and dry cloth once a month. Before cleaning the unit, disconnect from power outlets and any telephone line cords.

### Battery level

Icon	Battery level
	High
	Medium
	Low
	Needs charging.
	Empty

### Panasonic Ni-MH battery performance (supplied batteries)

Operation	Operating time
In continuous use	10 hours max.*1
Not in use (standby)	6 days max.*1

\*1 If eco mode is on.



**Note:**

- Actual battery performance depends on usage and ambient environment.

## Intelligent eco mode

This feature automatically reduces handset power consumption whenever possible. When it is activate, **ECO** is displayed.

## Controls

### Handset

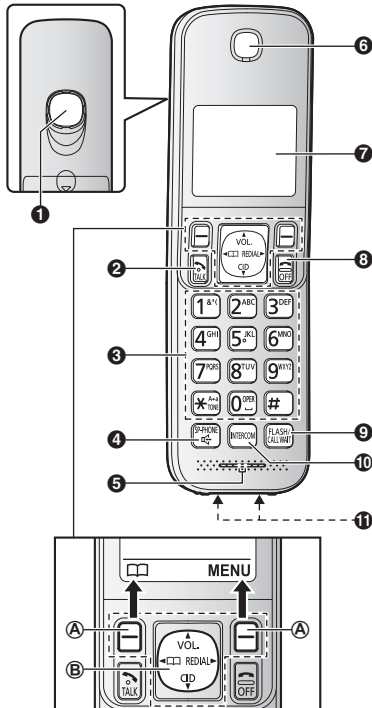

**1** Speaker

- 2** **[TALK]** (TALK)
- 3** Dial keypad (**[TONE]**)
- 4** **[SP-PHONE]** (SP-PHONE: Speakerphone)
- 5** Microphone
- 6** Receiver
- 7** Display
- 8** **[OFF]**
- 9** **[FLASH][CALL WAIT]**
- 10** **[INTERCOM]**
  - This feature is available between 2 handsets.
- 11** Charge contacts
- (A)** Soft keys
- (B)** Navigator key
  - **[▲]**, **[▼]**, **[◀]**, or **[▶]**: Scroll through various lists and items.
  - VOL. (Volume: **[▲]** or **[▼]**): Adjust the receiver or speaker volume while talking.
  - **[☐]**: View the phonebook entry.
  - **[▶]** REDIAL: View the redial list.
  - **[▼]** CID (Caller ID): View the caller list.

### Base unit



- 1** Charge contacts
- 2** **[••]** (LOCATOR)

For assistance, visit [www.panasonic.ca/english/support](http://www.panasonic.ca/english/support)

## Getting Started

### Display icons

#### Handset display items

Item	Meaning
	Within base unit range
	Out of base unit range
	The line is in use. <ul style="list-style-type: none"><li>When flashing: The call is put on hold.</li><li>When flashing rapidly: An incoming call is now being received.</li></ul>
<b>ECO</b>	Eco mode is on. (page 9)
	Speakerphone is on. (page 11)
	Ringer volume is off. (page 11)
	Night mode is on. (page 19)
<b>PRIV</b>	Privacy mode is on. (page 18)
	Alarm is on. (page 19)
<b>1</b>	Handset number
	Battery level
	Blocked call (page 19)
<b>BOOST</b>	Clarity booster is on automatically.
<b>Line in use</b>	Someone is using the line.

### Language settings

#### Display language

- 1 **[MENU]#110**
- 2 **[↕]**: Select the desired setting. → **[SAVE] → [OFF]**

### Date and time

- 1 **[MENU]#101**
- 2 Enter the current month, date, and year by selecting 2 digits for each.  
**Example:** July 15, 2016  
**07 15 16**
- 3 **[OK]**
- 4 Enter the current hour and minute (12-hour clock format) by selecting 2 digits for each.  
**Example:** 9:30  
**09 30**
- 5 **[⌂]**: Select "AM" or "PM".
- 6 **[SAVE] → [OFF]**

#### Note:

- Either 12-hour or 24-hour time format is used depending on the display language.

### Other settings

#### Dialing mode

- 1 **[MENU]#120**
- 2 **[↕]**: Select the desired setting. → **[SAVE] → [OFF]**

### Making calls

- 1 Lift the handset and dial the phone number.
  - To correct a digit, press **[CLEAR]**.
- 2 **[↶]** or **[↷]**
  - To adjust the receiver or speaker volume, press **[▲]** or **[▼]** repeatedly.
- 3 When you finish talking, press **[OFF]**.

#### Note:

- To switch back to the receiver, press **[↷]**/**[↶]**.

### Making a call using the redial list

The last 5 phone numbers dialed are stored in the redial list.

- 1 **[▶]** REDIAL
- 2 **[↕]**: Select the desired entry. → **[↶]**

### Pause (for PBX/long distance service users)

A pause is sometimes required when making calls using a PBX or long distance service. When storing a calling card access number and/or PIN in the phonebook, a pause is also needed (page 14).

**Example:** If you need to dial the line access number "9" when making outside calls with a PBX:

- 1 **[9]** → **[▲]** (Pause)
- 2 Dial the phone number. → **[↶]**

### Answering calls

- 1 Lift the handset and press **[↶]** or **[↷]** when the unit rings.
  - 2 When you finish talking, press **[OFF]**.
- Auto talk:** You can answer calls simply by lifting the handset (page 17).
- Temporary handset ringer off:** Press **[⏏]**.

### Adjusting the handset ringer volume

Press **[▲]** or **[▼]** repeatedly while ringing.

### Useful features during a call

#### Hold

- 1 Press **[MENU]** during an outside call.
- 2 **[↕]**: "Hold" → **[SELECT]**
- 3 To release hold, press **[↶]**.

#### Note:

- After holding for 10 minutes, the call is disconnected.

#### Mute

- 1 Press **[MUTE]** during a call.
- 2 To return to the call, press **[MUTE]**.

#### Flash

**[FLASH]** allows you to use the special features of your host PBX.

#### Note:

- To change the flash time, see page 18.

### For call waiting or Call Waiting Caller ID service users

To use call waiting or Call Waiting Caller ID, you must first subscribe with your phone service provider.

This feature allows you to receive calls while you are already talking on the phone. If you receive a call while on the phone, you will hear a call waiting tone.

**If you subscribe to both Caller ID and Call Waiting with Caller ID services,** the 2nd caller's information is displayed on the handset that is in use after you hear the call waiting tone.

- 1 Press **[CALL WAIT]** to answer the 2nd call.

## Making/Answering Calls

- 2 To switch between calls, press **[CALL WAIT]**.

**Note:**

- Please contact your phone service provider for details and availability of this service in your area.

### Temporary tone dialing (for rotary/pulse service users)

Press **[TONE]** before entering access numbers which require tone dialing.

### Call share

While you are on an outside call, another unit can join the conversation. Only 2 units can join an outside call.

**Note:**

- To prevent other users from joining your conversations, turn privacy mode on (page 18).

### Transferring calls, conference calls

- 1 During an outside call, press **[INTERCOM]**.  
**When 3 or more handsets are registered:**  
**[↕]:** Select the desired unit. → **[SELECT]**
- 2 Wait for the paged party to answer.
  - If the paged party does not answer, press **[↶]** to return to the outside call.
- 3 **To complete the transfer:**  
Press **[OFF]**.  
**To establish a conference call:**  
**[MENU]** → **[↕]:** "Conf." → **[SELECT]**
  - To leave the conference, press **[OFF]**.
  - To put the outside call on hold:  
**[MENU]** → **[↕]:** "Hold" → **[SELECT]**  
To resume the conference: **[MENU]** → **[↕]:** "Conf." → **[SELECT]**
  - To cancel the conference: **[MENU]** → **[↕]:** "Stop conference" → **[SELECT]**

## Intercom

### Making an intercom call

- 1 **[INTERCOM]**.  
**When 3 or more handsets are registered:**  
**[↕]:** Select the desired unit. → **[SELECT]**

## Phonebook

You can add 50 names (16 characters max.) and phone numbers (24 digits max.) to the phonebook.

### Adding phonebook entries

- 1 or → [MENU]
- 2 : "Add new entry" → [SELECT]
- 3 Enter the party's name. → [OK]
- 4 Enter the party's phone number. → [OK]
- 5 : Select the desired group. → [SELECT] 2 times → [OFF]

### Entering characters

Press the dial key that corresponds to the desired character. Press repeatedly to scroll through the available characters. The following operations are also available.

Key	Operation
	Switch between the uppercase and lowercase (A ↔ a)
	Move the cursor
[CLEAR]	Erase the character or number <ul style="list-style-type: none"> <li>• To erase all, press and hold it.</li> </ul>

### Storing a redial list number to the phonebook

- 1 REDIAL
- 2 : Select the desired entry. → [SAVE]
- 3 To store the name, continue from step 3, "Editing entries", page 14.

### Storing caller information to the phonebook

- 1 CID

- 2 : Select the desired entry.
  - To edit the number: [MENU] → : "Edit" → [SELECT]  
Press [EDIT] repeatedly until the phone number is shown in the desired format. And then, press [SAVE]. Go to step 5.
- 3 [MENU]
- 4 : "Save CID" → [SELECT]
- 5 : "Phonebook" → [SELECT]
- 6 Continue from step 3, "Editing entries", page 14.

### Groups

You can assign your phone entries to groups for each searching. You can assign a ringtone to each group to help identify incoming calls (Caller ID required).

### Changing group names/setting ringer ID

- 1 or → [MENU]
- 2 : "Group" → [SELECT]
- 3 : Select the desired group. → [SELECT]
- 4 **To change group names**  
: "Group name" → [SELECT] → Edit the name. → [SAVE]  
**To set group ringer tone**  
: Select the current setting of the group ringer tone. → [SELECT] → : Select the desired ringer tone. → [SAVE]
- 5 [OFF]

### Finding and calling from a phonebook entry

- 1 or
- 2 : Select the desired entry.
- 3

## Phonebook

### Editing entries

- 1 Find the desired entry (page 13).
- 2 **[MENU]** → **[↕]**: "Edit" → **[SELECT]**
- 3 Edit the name if necessary. → **[OK]**
- 4 Edit the phone number if necessary. → **[OK]**
- 5 **[↕]**: Select the desired group (page 13). → **[SELECT]** 2 times → **[OFF]**

### Erasing an entry

- 1 Find the desired entry (page 13).
- 2 **[MENU]** → **[↕]**: "Erase" → **[SELECT]**
- 3 **[↕]**: "Yes" → **[SELECT]** → **[OFF]**

### Chain dial

This feature allows you to dial phone numbers in the phonebook while you are on a call. This feature can be used, for example, to dial a calling card access number or bank account PIN that you have stored in the phonebook, without having to dial manually.

- 1 During an outside call, press **[MENU]**.
- 2 **[↕]**: "Phonebook" → **[SELECT]**
- 3 **[↕]**: Select the desired entry.
- 4 Press **[CALL]** to dial the number.

#### Note:

- When storing a calling card access number and your PIN in the phonebook as one phonebook entry, press **[▲]** (Pause) to add pauses after the number and PIN as necessary (page 11).
- If you have rotary/pulse service, you need to press **[☒]** (TONE) before pressing **[MENU]** in step 1 to change the dialing mode temporarily to tone. When adding entries to the phonebook, we recommend adding **[☒]** (TONE) to the beginning of phone numbers you wish to chain dial (page 13).

### Speed dial

You can assign 1 phone number to each of the dial keys (**[1]** to **[9]**) on the handset.

### Adding phone numbers to speed dial keys

#### ■ By entering phone numbers:

- 1 Press and hold the desired speed dial key (**[1]** to **[9]**). → **[ADD]**
- 2 **[↕]**: "Manual" → **[SELECT]**
- 3 Enter the party's name. → **[OK]**
- 4 Enter the party's phone number. → **[OK]** → **[SELECT]** → **[OFF]**

#### ■ From the phonebook:

- 1 Press and hold the desired speed dial key (**[1]** to **[9]**). → **[ADD]**
- 2 **[↕]**: "Phonebook" → **[SELECT]**
- 3 **[↕]**: Select the desired entry. → **[SAVE]** → **[OFF]**

#### Note:

- If you edit a phonebook entry which is assigned to a speed dial key, the edited entry does not transfer to the speed dial key.

### Editing an entry

- 1 Press and hold the desired speed dial key (**[1]** to **[9]**). → **[MENU]**
- 2 **[↕]**: "Edit" → **[SELECT]**
- 3 Edit the name if necessary. → **[OK]**
- 4 Edit the phone number if necessary. → **[OK]** → **[SELECT]** → **[OFF]**

### **Erasing an entry**

- 1** Press and hold the desired speed dial key ([1] to [9]). → **[MENU]**
- 2** [↕]: “Erase” → **[SELECT]**
- 3** [↕]: “yes” → **[SELECT]** → **[OFF]**

---

### **Making a call**

Press and hold the desired speed dial key ([1] to [9]). → **[📞]**

## Programming

### Menu list

Scrolling through the display menus: [MENU] → Press [▼] or [▲] to select the desired main menu. → [SELECT]

OR

Using the direct command code: [MENU] → Enter the desired code.

Example: Press [MENU]#101.

- To exit the operation, press [OFF].

### Display menu tree and direct command code table

Main menu:  "Phonebook"

Operation	Code	Page
Viewing the phonebook entry.	#280	13

Main menu:  "Caller list"

Operation	Code	Page
Viewing the caller list.	#213	22

Main menu:  "V.M. access" (V.M.: Voicemail)

Operation	Code	Page
Listening to voicemail messages.	#330	23

Main menu:  "Intercom"

Operation	Code	Page
Paging the desired unit.	#274	12

Main menu:  "Set date & time"

Sub-menu 1	Sub-menu 2	Settings <Default>	Code	Page
Date and time	–	–	#101	10
Alarm	–	<Off> Once Daily	#720	19
Time adjustment*1	–	<Caller ID auto> Manual	#226	–



## Programming

Main menu:  "Initial setting"

Sub-menu 1	Sub-menu 2	Settings <Default>	Code	Page
Ringer setting	Ringer volume	Off-6 <6>	#160	11
	Ringer tone <sup>*2</sup>	<Tone 1>	#161	-
	Night mode - On/Off	On <Off>	#238	19
	Night mode - Start/End	<11:00 PM/06:00 AM>	#237	19
Set date & time	Date and time	-	#101	10
	Alarm	<Off> Once Daily	#720	19
	Time adjustment <sup>*1</sup>	<Caller ID auto> Manual	#226	-
Handset name	-	-	#104	20
Call block	-	-	#217	19
	First ring	<On> Off	#173	20
	Block w/o num <sup>*3</sup>	On <Off>	#240	20
Speed dial	-	-	#261	14
Voice mail	Store VM access#	-	#331	23
	VM tone detect	<On> Off	#332	23
LCD contrast	-	Level 1-4 <2>	#145	-
Key tone	-	<On> Off	#165	-
Auto talk	-	On <Off>	#200	11

## Programming

Sub-menu 1	Sub-menu 2	Settings <Default>	Code	Page
Set tel line	Set dial mode	<Tone> Pulse	#120	10
	Set flash time	80 ms 90 ms 100 ms 110 ms 160 ms 200 ms 250 ms 300 ms 400 ms 600 ms <700 ms> 900 ms	#121	11
	Set line mode*4	A <B>	#122	-
	C. WTG options	On <Off>	#215	21
Privacy mode	-	On <Off>	#194	12
Registration	Register handset	-	#130	20
	Deregistration*3	-	#131	20
Change language	Display	<English> Français	#110	10

Main menu: ? "Customer support"

Operation	Code	Page
Displaying customer support Web address.	#680	-

- \*1 This feature allows the unit to automatically adjust the date and time each time caller information including date and time is received.  
To turn this feature on, select "Caller ID auto". To turn this feature off, select "Manual". (Caller ID subscribers only)  
To use this feature, set the date and time first (page 10).
- \*2 The preset melodies in this product ("Tone 3" - "Tone 5", "Melody 1" - "Melody 10") are used with permission of © 2012 Copyrights Vision Inc.
- \*3 This menu is not displayed when scrolling through the display menus. It is only available in direct command code.
- \*4 Generally, the line mode setting should not be changed. This setting automatically maintains receiver volume at the proper level depending on the current telephone line condition. Set the line mode to "A" if telephone line condition is not good.

## Alarm

An alarm sounds at the set time for 3 minutes once or daily. Alarm can be set for each handset.

- 1 **[MENU]#720**
- 2 **[↕]**: Select the desired alarm option. → **[SELECT]**
- 3 Enter the desired month and date. → **[OK]**
- 4 Set the desired time.
- 5 **[x]**: Select “**AM**” or “**PM**”. → **[OK]**
- 6 **[↕]**: Select the desired alarm tone. → **[SELECT]**
- 7 **[SELECT]** → **[OFF]**

## Night mode

Night mode allows you to select a period of time during which the handset will not ring for outside calls. This feature is useful for time periods when you do not want to be disturbed, for example, while sleeping. Night mode can be set for each unit.

### Important:

- If you have set the alarm, the alarm sounds even if the night mode is turned on.

### Turning night mode on/off

- 1 **[MENU]#238**
- 2 **[↕]**: Select the desired setting. → **[SAVE]**
- 3 Follow the directions on the display to complete the operation.

### Changing the start and end time

- 1 **[MENU]#237**
- 2 Follow the directions on the display to complete the operation.

## Call block

This feature allows the unit to block calls when:

- the unit receives a call from a phone number stored in the call block list as unwanted (“Storing unwanted callers”, page 19).
- the unit receives a call without phone number (“Blocking incoming calls that have no phone number”, page 20).

When a call is received, the unit rings once\*1 while caller information is being received. If the caller’s phone number matches an entry in the call block list, the unit emits no sound to the caller, and disconnects the call. (Caller ID subscribers only)

\*1 This is called first ring. If you do not want the first ring to sound, turn this setting to “**OFF**” (page 20).

### Important:

- Blocked calls are logged in the caller list.

## Storing unwanted callers

You can store up to 30 phone numbers in the call block list.

### Important:

- We recommend storing 10 digits (including the area code). If only 7 digits are stored, all numbers that have the same last 7 digits will be blocked.

### ■ From the caller list:

- 1 **[v]** CID
- 2 **[↕]**: Select the entry to be blocked.
  - To edit the number: **[MENU]** → **[↕]**: “**Edit**” → **[SELECT]**  
Press **[EDIT]** repeatedly until the phone number is shown in the 10-digit format. And then, press **[SAVE]**. Go to step 5.
- 3 **[MENU]**
- 4 **[↕]**: “**save CID**” → **[SELECT]**
- 5 **[↕]**: “**Call block**” → **[SELECT]**
- 6 **[↕]**: “**Yes**” → **[SELECT]**
- 7 Edit the phone number if necessary (24 digits max.).

## Programming

### 8 [SAVE] → [OFF]

■ By entering phone numbers:

- 1 [MENU]#217
- 2 [MENU] → [↕]: "Add" → [SELECT]
- 3 Enter the phone number (24 digits max.).
  - To erase a digit, press [CLEAR].
- 4 [SAVE] → [OFF]

### Blocking incoming calls that have no phone number

You can block calls when no phone number is provided, such as private callers or out of area calls.

- 1 [MENU]#240
- 2 [↕]: Select the desired setting. → [SAVE] → [OFF]

### Turning the first ring on and off

You can choose whether the first ring sounds when a call is received.

"On" (default): The first ring for all calls will be heard, including calls from blocked phone numbers.

"Off": The first ring is muted for all calls. If this setting is selected, the unit will never ring for calls from blocked phone numbers.

- 1 [MENU]#173
- 2 [↕]: Select the desired setting. → [SAVE] → [OFF]

### Viewing/editing/erasing call block numbers

- 1 [MENU]#217
- 2 [↕]: Select the desired entry.
- 3 **To edit a number:**  
[EDIT] → Edit the phone number. → [SAVE] → [OFF]  
**To erase a number:**  
[ERASE] → [↕]: "Yes" → [SELECT] → [OFF]

#### Note:

- When viewing, "Block w/o num" is displayed if the blocking incoming calls without phone number feature is turned on. To turn the feature off: [ERASE] → [v] → [SAVE] → [OFF]

## Other programming

### Changing the handset name

- 1 [MENU]#104
- 2 Enter the desired name.
- 3 [SAVE]
- 4 [↕]: Select the desired setting. → [SELECT] 2 times → [OFF]

### Registering a handset to the base unit

If for some reason the handset is not registered to the base unit, re-register the handset.

- 1 **Handset:**  
[MENU]#130
- 2 **Base unit:**  
Press and hold [••] for about 5 seconds.
  - If all registered handsets start ringing, press [••] again to stop, then repeat this step.
- 3 **Handset:**  
Press [OK], then wait until a long beep sounds.

### Deregistering a handset

- 1 [MENU]#131
  - All handsets registered to the base unit are displayed.
- 2 [↕]: Select the handset you want to cancel. → [SELECT]
- 3 [↕]: "Yes" → [SELECT] → [OFF]

## Using Caller ID service

### Important:

- This unit is Caller ID compatible. To use Caller ID features, you must subscribe to a Caller ID service. Contact your phone service provider for details.

### Caller ID features

When an outside call is being received, the caller information is displayed.

Caller information for the last 50 callers is logged in the caller list from the most recent call to the oldest.

- If the unit cannot receive caller information, the following is displayed:
  - “**Unavailable**”: The caller dials from an area which does not provide a Caller ID service.
  - “**Private caller**”: The caller requests not to send caller information.
  - “**Long distance**”: The caller makes a long distance call.
- If the unit is connected to a PBX system, caller information may not be properly received. Contact your PBX supplier.

### For Call Waiting Deluxe service users

To use Call Waiting Deluxe, you must subscribe to Call Waiting Deluxe from your phone service provider. This feature not only allows the unit currently in use to display the 2nd caller's information, but also offers you a variety of ways to deal with the 2nd call.

### Important:

- Please contact your phone service provider for details and availability of this service in your area.
- This feature must be turned on before it can be used.

### To turn Call Waiting Deluxe on/off

To use Call Waiting Deluxe, you must turn this feature on. The default setting is “**OFF**”.

- 1 **[MENU]**#**[2]****[1]****[5]**
- 2 **[↓]**: Select the desired setting. →  
**[SAVE]** → **[OFF]**

### Call Waiting Deluxe service options

When a 2nd call is received, you can choose how to handle the call by selecting an option shown on the unit display.

### Note:

- Your phone service provider may not offer all of the options (page 21).

Displayed option	Function
<b>Answer</b>	Answers the waiting call, while keeping the 1st call on hold.
<b>Hold</b>	Holds the waiting call. The caller will hear the pre-recorded hold message played by your phone service provider.
<b>Announce</b>	The caller will hear the pre-recorded busy message played by your phone service provider (for example, “We are not available now.”) and will then be disconnected.
<b>Forward</b>	Forwards the waiting call to the voicemail service provided by your phone service provider. You must subscribe to voicemail service to use this function.
<b>Drop</b>	Disconnects (drops) the current call and answers the waiting call.
<b>Conference</b>	Answers the waiting call and combines it with the current call to make a conference call (3-party call).
<b>Return</b>	Returns to the waiting caller while keeping the current call on hold.

## Caller ID Service

Displayed option	Function
Drop caller1	Disconnects (drops) the 1st call during a conference call.
Drop caller2	Disconnects (drops) the 2nd call during a conference call.

### To use Call Waiting Deluxe service

- 1 When you hear a call waiting tone during an outside call, press **[FLASH]**.
  - The option menu is displayed.
- 2 **[↓]**: Select the desired option. → **[SELECT]**
  - After selecting “Answer”, “Hold”, or “Conference”, you can select another option. → **[FLASH]** → **[↓]**: Select the desired option. → **[SELECT]**

#### Note:

- To exit from the option menu, wait for 20 seconds.

## Caller list

### Viewing the caller list and calling back

- 1 **[▼]** CID
- 2 Press **[▼]** to search from the most recent call, or **[▲]** to search from the oldest call.
- 3 To call back, press **[↶]**.

### Editing a caller's phone number

- 1 **[▼]** CID
- 2 **[↓]**: Select the desired entry.
- 3 **[MENU]** → **[↓]**: “Edit” → **[SELECT]**
- 4 Press **[EDIT]** repeatedly until the phone number is shown in the desired format.
- 5 **[↶]**

#### Note:

- The number edited in step 4 will not be saved in the caller list.

### Erasing selected caller information

- 1 **[▼]** CID
- 2 **[↓]**: Select the desired entry.
- 3 **[ERASE]** → **[↓]**: “Yes” → **[SELECT]** → **[OFF]**

## Voice mail service

Voice mail is an answering service that may be offered by your phone service provider. This service can also record calls when you are unavailable to answer the phone or when your line is busy. Messages are recorded on the phone company system.

### Storing the voice mail (VM) access number

You can store the phone number used to access your voice mail service.

- 1 **[MENU]#331**
- 2 Enter your access number. → **[SAVE]**  
→ **[OFF]**

**Note:**

- When storing your voice mail access number and your mailbox password, press **[▲]** (Pause) to add pauses (page 11) between the access number and the password as necessary. Contact your phone service provider for the required pause time.

**Example:**

1-222-333-4444	PPPP	8888
VM access number	Pauses	Password

### To erase the voice mail access number

- 1 **[MENU]#331**
- 2 Press and hold **[CLEAR]** until all digits are erased. → **[SAVE]** → **[OFF]**

### Voice mail (VM) tone detection

Your voice mail service provider sends special signals to the unit to let you know that you have new voice mail messages. If you hear a series of dial tones followed by a continuous dial tone after you press **[📞]**, you have new voice mail messages.

The unit can detect these signals automatically. Turn this feature off in the following situations.

- You do not subscribe to voice mail service.
- Your phone is connected to a PBX.

### Turning VM tone detection on/off

- 1 **[MENU]#332**
- 2 **[↕]**: Select the desired setting. →  
**[SAVE]** → **[OFF]**

### Listening to voice mail messages

- 1 **[MENU]#330**
  - The speakerphone turns on.
- 2 Follow the pre-recorded instructions.
- 3 When finished, press **[OFF]**.

**Note:**

- You can also use the **[VM]** soft key, if displayed, to play new voice mail messages.
- If the handset still indicate there are new messages even after you have listened to all new messages, turn it off by pressing and holding **[#]** until the handset beeps.

## Useful Information

### Error messages

Display message	Cause/solution
Access # to VM service is not stored	<ul style="list-style-type: none"><li>You have not stored the voicemail access number. Store the number (page 23).</li></ul>
Base no power or No link. Re-connect base AC adaptor.	<ul style="list-style-type: none"><li>The handset has lost communication with the base unit. Move closer to the base unit and try again.</li><li>Unplug the base unit's AC adaptor to reset the unit. Reconnect the adaptor and try again.</li><li>The handset's registration may have been cancelled. Re-register the handset (page 20).</li></ul>
Busy	<ul style="list-style-type: none"><li>Other units are in use and the system is busy. Try again later.</li></ul>
Check tel line	<ul style="list-style-type: none"><li>The supplied telephone line cord has not been connected yet or not connected properly. Check the connections (page 8).</li></ul>
Invalid	<ul style="list-style-type: none"><li>There is no handset registered to the base unit matching the handset number you entered.</li><li>The handset is not registered to the base unit. Register the handset (page 20).</li></ul>
Use rechargeable battery.	<ul style="list-style-type: none"><li>A wrong type of battery such as alkaline or manganese was inserted. Use only the rechargeable Ni-MH batteries noted on page 4, 6.</li></ul>

### Troubleshooting

If you still have difficulties after following the instructions in this section, disconnect the base unit's AC adaptor, then reconnect the base unit's AC adaptor. Remove the batteries from the handset, and then insert the batteries into the handset again.

#### General use

Problem	Cause/solution
The handset does not turn on even after installing charged batteries.	<ul style="list-style-type: none"><li>Place the handset on the base unit or charger to turn on the handset.</li></ul>
The unit does not work.	<ul style="list-style-type: none"><li>Make sure the batteries are installed correctly (page 8).</li><li>Fully charge the batteries (page 8).</li><li>Check the connections (page 8).</li><li>Unplug the base unit's AC adaptor to reset the unit. Reconnect the adaptor and try again.</li><li>The handset has not been registered to the base unit. Register the handset (page 20).</li></ul>



## Useful Information

Problem	Cause/solution
I cannot hear a dial tone.	<ul style="list-style-type: none"> <li>The base unit's AC adaptor or telephone line cord is not connected. Check the connections.</li> </ul>
Time on the unit has shifted.	<ul style="list-style-type: none"> <li>Incorrect time information from incoming Caller ID changes the time. Set the time adjustment to "Manual" (off) (page 17).</li> </ul>

### Battery recharge

Problem	Cause/solution
I fully charged the batteries, but <ul style="list-style-type: none"> <li>still flashes,</li> <li>is displayed, or</li> <li>the operating time seems to be shorter.</li> </ul>	<ul style="list-style-type: none"> <li>Clean the battery ends (+, -) and the charge contacts with a dry cloth and charge again.</li> <li>It is time to replace the batteries (page 8).</li> </ul>

### Making/answering calls, intercom

Problem	Cause/solution
is displayed.	<ul style="list-style-type: none"> <li>The handset is too far from the base unit. Move closer.</li> <li>The base unit's AC adaptor is not properly connected. Reconnect AC adaptor to the base unit.</li> <li>The handset is not registered to the base unit. Register it (page 20).</li> </ul>
Noise is heard, sound cuts in and out.	<ul style="list-style-type: none"> <li>You are using the handset or base unit in an area with high electrical interference. Re-position the base unit and use the handset away from sources of interference.</li> <li>Move closer to the base unit.</li> <li>If you use a DSL/ADSL service, we recommend connecting a DSL/ADSL filter between the base unit and the telephone line jack. Contact your DSL/ADSL provider for details.</li> </ul>
The handset does not ring.	<ul style="list-style-type: none"> <li>The ringer volume is turned off. Adjust the ringer volume (page 11, 17).</li> <li>Night mode is turned on. Turn it off (page 19).</li> </ul>
I cannot make a call.	<ul style="list-style-type: none"> <li>The dialing mode may be set incorrectly. Change the setting (page 10).</li> </ul>

## Useful Information

### Caller ID

Problem	Cause/solution
Caller information is not displayed.	<ul style="list-style-type: none"><li>• You must subscribe to Caller ID service. Contact your phone service provider for details.</li><li>• If your unit is connected to any additional telephone equipment such as a Caller ID box or cordless telephone line jack, plug the unit directly into the wall jack.</li><li>• If you use a DSL/ADSL service, we recommend connecting a DSL/ADSL filter between the base unit and the telephone line jack. Contact your DSL/ADSL provider for details.</li><li>• The name display service may not be available in some areas. Contact your phone service provider for details.</li></ul>
Caller information is displayed late.	<ul style="list-style-type: none"><li>• Depending on your phone service provider, the unit may display the caller's information at the 2nd ring or later.</li></ul>

### Voicemail

Problem	Cause/solution
"New Voice Mail" is shown on the handset display. How do I remove this message from the display?	<ul style="list-style-type: none"><li>• Listen your new voicemail messages (page 23). Depending on your voicemail service provider, you may need to erase all messages in your voice mailbox in order to remove this message.</li><li>• You can remove this message manually by pressing and holding <b>[#]</b> until the unit beeps.</li></ul>

### Liquid damage

Problem	Cause/solution
Liquid or other form of moisture has entered the handset/base unit.	<ul style="list-style-type: none"><li>• Disconnect the AC adaptor and telephone line cord from the base unit. Remove the batteries from the handset and leave to dry for at least 3 days. After the handset/base unit are completely dry, reconnect the AC adaptor and telephone line cord. Insert the batteries and charge fully before use. If the unit does not work properly, contact an authorized service centre.</li></ul>

#### Caution:

- To avoid permanent damage, do not use a microwave oven to speed up the drying process.

## Wall mounting (Charger only)

**Note:**

- Make sure that the wall and the fixing method are strong enough to support the weight of the unit.

Drive the screws (A) (not supplied) into the wall.

(B) 27.2 mm (1 1/16 inches)

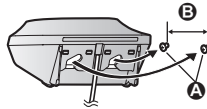

## Useful Information

### Industry Canada Notices and other information

**NOTICE:**

This equipment meets the applicable Industry Canada Terminal Equipment Technical Specifications. This is confirmed by the registration number. The abbreviation, "IC:", before the registration number signifies that registration was performed based on a Declaration of Conformity indicating that Industry Canada technical specifications were met. It does not imply that Industry Canada approved the equipment.

Users should ensure, for their own protection, that the electrical ground connections of the power utility, telephone lines and internal metallic water pipe system, if present, are connected together. This precaution may be particularly important in rural areas.

**NOTICE:**

The **Ringer Equivalence Number (REN)** assigned to each terminal device provides an indication of the maximum number of terminals allowed to be connected to a telephone interface. The termination on an interface may consist of any combination of devices subject only to the requirement that the sum of the Ringer Equivalence Numbers of all the devices does not exceed 5. The Ringer Equivalence Number (REN) of this unit:  
(found on the bottom of the unit).

**NOTICE:**

This device complies with Industry Canada licence-exempt RSS standard(s). Operation is subject to the following two conditions: (1) this device may not cause interference, and (2) this device must accept any interference, including interference that may cause undesired operation of the device.

Privacy of communications may not be ensured when using this telephone.

Some cordless telephones operate at frequencies that may cause interference to nearby TVs and VCRs. To minimize or prevent such interference, the base of the

cordless telephone should not be placed near, or on top of, a TV or VCR. If interference is experienced, move the cordless telephone further away from the TV or VCR. This will often reduce, or eliminate, interference.

**RF Exposure Warning:**

- This product complies with IC radiation exposure limits set forth for an uncontrolled environment.
- To comply with IC RF exposure requirements, the base unit must be installed and operated 20 cm (8 inches) or more between product and all person's body.
- This product may not be collocated or operated in conjunction with any other antenna or transmitter.
- For body-worn operation, the handset must be used only with a non-metallic accessory. Use of other accessories may not ensure compliance with IC RF exposure requirements.

## Warranty

**Panasonic Canada Inc.**  
5770 Ambler Drive, Mississauga, Ontario L4W 2T3  
**PANASONIC PRODUCT - LIMITED WARRANTY**

### EXCHANGE PROGRAM

Panasonic Canada Inc. warrants this product to be free from defects in material and workmanship under normal use and for a period as stated below from the date of original purchase agrees to, at its option either (a) repair your product with new or refurbished parts, (b) replace it with a new or a refurbished equivalent value product, or (c) refund your purchase price. The decision to repair, replace or refund will be made by Panasonic Canada Inc.

**Telephone Accessory / Product**

**One (1) year**

This warranty is given only to the original purchaser, or the person for whom it was purchased as a gift, of a Panasonic brand product mentioned above sold by an authorized Panasonic dealer in Canada and purchased and used in Canada, which product was not sold "as is", and which product was delivered to you in new condition in the original packaging.

**IN ORDER TO BE ELIGIBLE TO RECEIVE WARRANTY SERVICE HEREUNDER, A PURCHASE RECEIPT OR OTHER PROOF OF DATE OF ORIGINAL PURCHASE, SHOWING AMOUNT PAID AND PLACE OF PURCHASE IS REQUIRED**

### **LIMITATIONS AND EXCLUSIONS**

This warranty ONLY COVERS failures due to defects in materials or workmanship, and DOES NOT COVER normal wear and tear or cosmetic damage. The warranty ALSO DOES NOT COVER damages which occurred in shipment, or failures which are caused by products not supplied by Panasonic Canada Inc., or failures which result from accidents, misuse, abuse, neglect, mishandling, misapplication, alteration, faulty installation, set-up adjustments, misadjustment of consumer controls, improper maintenance, improper batteries, power line surge, lightning damage, modification, introduction of sand, humidity or liquids, commercial use such as hotel, office, restaurant, or other business or rental use of the product, or service by anyone other than a Authorized Servicer, or damage that is attributable to acts of God.

Rechargeable batteries are warranted for ninety (90) days from date of original purchase.

THIS EXPRESS, LIMITED WARRANTY IS IN LIEU OF ALL OTHER WARRANTIES, EXPRESS OR IMPLIED, INCLUDING ANY IMPLIED WARRANTIES OF MERCHANTABILITY AND FITNESS FOR A PARTICULAR PURPOSE. IN NO EVENT WILL PANASONIC CANADA INC. BE LIABLE FOR ANY SPECIAL, INDIRECT OR CONSEQUENTIAL DAMAGES RESULTING FROM THE USE OF THIS PRODUCT OR ARISING OUT OF ANY BREACH OF ANY EXPRESS OR IMPLIED WARRANTY. (As examples, this warranty excludes damages for lost time, travel to and from the Authorized Servicer, loss of or damage to media or images, data or other memory or recorded content. This list of items is not exhaustive, but for illustration only.)

In certain instances, some jurisdictions do not allow the exclusion or limitation of incidental or consequential damages, or the exclusion of implied warranties, so the above limitations and exclusions may not be applicable. This warranty gives you specific legal rights and you may have other rights which vary depending on your province or territory.

### **CONTACT INFORMATION**

For product information and operation assistance, please visit our Support page:

**[www.panasonic.ca/english/support](http://www.panasonic.ca/english/support)**

For defective product exchange within the warranty period, please contact the original dealer.

## Index

### Index

- A** Additional handset: 4
  - Alarm: 19
  - Answering calls: 11
  - Auto talk: 11, 17
- B** Battery: 8
  - Booster (Clarity booster): 10
- C** C.WTG (Call Waiting Deluxe): 21
  - Call block: 19
    - First ring: 20
  - Call share: 12
  - Call waiting: 11
  - Call Waiting Caller ID: 11
  - Caller ID service: 21
  - Caller list: 22
  - Caller list edit: 22
  - Chain dial: 14
  - CID (Caller ID): 22
  - Conference calls: 12
  - Customer support: 18
- D** Date and time: 10
  - Dialing mode: 10
  - Direct command code: 16
  - Display
    - Contrast: 17
    - Language: 10
- E** Eco mode: 9
  - Error messages: 24
- F** Flash: 11, 18
- G** Groups: 13
- H** Handset
  - Deregistration: 20
  - Name: 20
  - Registration: 20
  - Hold: 11
- I** Intercom: 12
- K** Key tone: 17
- L** Line mode: 18
- M** Making calls: 11
  - Mute: 11
- N** Night mode: 19
- P** Pause: 11
  - Phonebook: 13
  - Privacy mode: 18
- R** Redialing: 11
  - Ringer ID: 13
  - Ringer tone: 17
- Rotary/pulse service: 12
- S** Speed dial: 14
  - SP-PHONE (Speakerphone): 11
- T** Temporary tone dialing: 12
  - Time adjustment: 17
  - Transferring calls: 12
  - Troubleshooting: 24
- V** VM (Voicemail): 23
  - Voicemail: 23
  - Volume
    - Receiver: 11
    - Ringer (Handset): 11, 17
    - Speaker: 11
- W** Wall mounting: 27

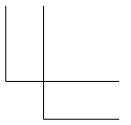
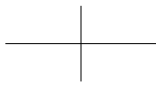
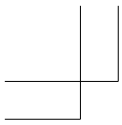

**Notes**

---

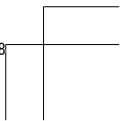
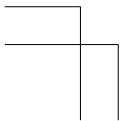
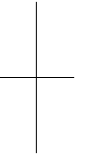
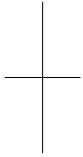

**For your future reference**

We recommend keeping a record of the following information to assist with any repair under warranty.

Serial No.	Date of purchase
(found on the bottom of the base unit)	
Name and address of dealer	
Attach your purchase receipt here.	

Panasonic Canada Inc.  
5770 Ambler Drive, Mississauga, Ontario L4W 2T3

© Panasonic System Networks Co., Ltd. 2015

Printed in Malaysia



\*PNQX7791ZA\*

**PNQX7791ZA** TT1215MU0