

Panasonic

Model No. **KX-TG9541/KX-TG9542**

2LINE

Quick Guide

Connecting the AC adaptor

Base unit

- ① Connect the AC adaptor plug to the unit until you hear a click.
 - ② Connect the AC adaptor to the power outlet.
- Use only the supplied Panasonic AC adaptor PNLV234.

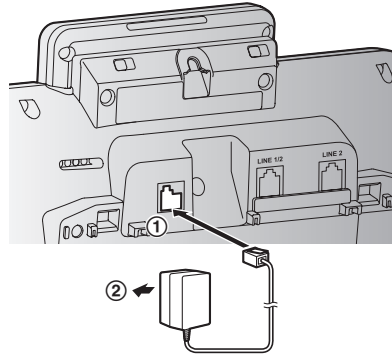

Charger

- ① Connect the AC adaptor to the power outlet.

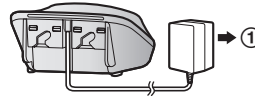

Connecting the telephone line cord

■ To connect to a 2-line telephone jack

- ① Connect the "GREEN" plug telephone line cord (4-wire cord) (A) to the unit, then to the 2-line telephone jack (RJ14C) (B) until you hear a click.

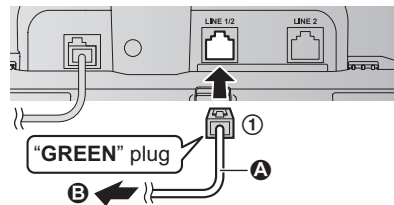

Connecting the telephone line cord

■ To connect to 2 single-line telephone jacks

- ① For Line 1: Connect the "Transparent" plug telephone line cord (2-wire cord) (A) to the unit, then to the Line 1 single-line telephone jack (RJ11C) (B) until you hear a click.
- ② For Line 2: Connect the "GREEN" plug telephone line cord (4-wire cord) (C) to the unit, then to the Line 2 single-line telephone jack (RJ11C) (D) until you hear a click.

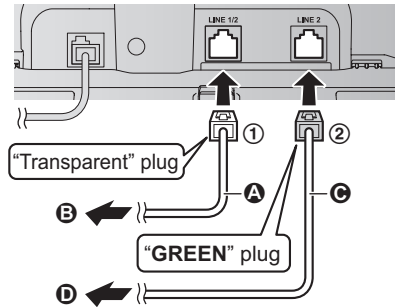

If you subscribe to a DSL/ADSL service, attach a DSL/ADSL filter to the telephone line between the base unit and the telephone line jack. Refer to the operating instructions for connections.

Battery installation/Battery charging

Charge for about 7 hours.

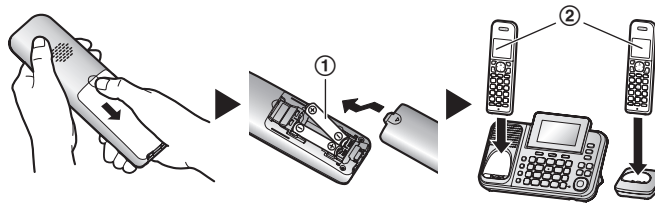

Note:

- USE ONLY Ni-MH batteries AAA (R03) size (①).
- Do NOT use Alkaline/Manganese/Ni-Cd batteries.
- Confirm correct polarities (+, -).
- Follow the directions on the display to set up the unit.
- Confirm "charging" is displayed (②).

Using the unit as a single-line telephone only

- ① Connect the "Transparent" plug telephone line cord (2-wire cord) to LINE 1/2.

Handset/Base unit:

- To use line 1 only: **[MENU]#250** → **[↕]**: "Line1" → **[SAVE]** → **[OFF]/[EXIT]**
- To erase the message "Check tel line2": **[MENU]#190**

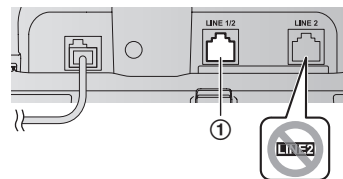

Operating tips

Soft keys

By pressing a soft key, you can select the feature shown directly above it on the display. Pay attention to the display to see what functions the soft keys are assigned during operation.

Navigator key

Handset:

- [▲], [▼], [◀], or [▶]: Scroll through various lists and items.
- (Volume: [▲] or [▼]): Adjust the receiver or speaker volume while talking.
- [◀] : View the phonebook entry.
- [▶] REDIAL: View the redial list.
- [▼] CID (Caller ID): View the caller list.

Base unit:

- [▲], [▼], [◀], or [▶]: Scroll through various lists and items.
- VOL. (Volume: [▲] or [▼]): Adjust the speaker volume while talking.
- [◀◀]/[▶▶]: Repeat/skip messages during playback.

Handset

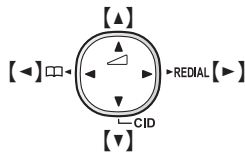
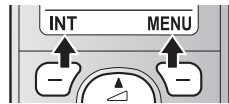

Base unit

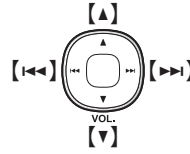
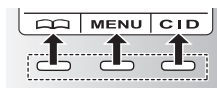

Date and time (Handset/Base unit)

- 1 [MENU]#101
- 2 Enter the current month, date, and year. → [OK]
- 3 Enter the current hour and minute (12-hour clock format).
- 4 Proceed with the operation for your unit.
Handset: : Select "AM" or "PM". → [SAVE]
Base unit: [AM/PM]: Select "AM" or "PM". → [SAVE]
- 5 Proceed with the operation for your unit.
Handset: [OFF]
Base unit: [EXIT]

Recording your greeting message for the answering system for the landline (Handset/Base unit)

If you use a pre-recorded greeting message, you do not need to record your own greeting message.

- 1 For line 1: [MENU]#3021
 For line 2: [MENU]#3022
- 2 [↕]: Select the desired greeting message. → [SELECT]
- 3 [↕]: "Yes" → [SELECT]
- 4 After a beep sounds, speak clearly about 20 cm (8 inches) away from the microphone (2 minutes max.).
- 5 Press [STOP] to stop recording.
- 6 Proceed with the operation for your unit.
Handset: [OFF]
Base unit: [EXIT]

Link to cell

You can use the unit to make or answer calls using a cellular line. Your cellular phones must have Bluetooth® wireless technology that is compatible with this product. For more details, please visit our Web site: <http://www.panasonic.com/link2cell>

- Locate your cellular phone near the base unit. If the cellular phone is too close to the base unit during a cellular call, you may hear noise. For best performance, we recommend placing the cellular phone between 0.6 m to 3 m (2 feet to 10 feet) away from the base unit.



- Ⓐ Cell line
- Ⓑ Cell phone service providers

Pairing a Bluetooth cellular phone (Handset/Base unit)

- For CELL 1: **[MENU]#6241**
- For CELL 2: **[MENU]#6242**
- For CELL 3: **[MENU]#6243**
- For CELL 4: **[MENU]#6244**

- After the corresponding CELL indicator on the base unit starts flashing, the rest of the procedure must be completed within 5 minutes.

2 Your cellular phone:

While the corresponding CELL indicator is flashing, follow the instructions of your cellular phone to enter the pairing mode.

- Depending on your cellular phone, it may ask you to enter the base unit PIN (default: "0000").

3 Wait until a long beep sounds.

- It may take more than 10 seconds to complete pairing.
- When the CELL indicator lights up, the cellular phone is connected to the base unit. You are ready to make cellular calls.

4 Proceed with the operation for your unit.



Handset: [OFF]
Base unit: [EXIT]

Note:

- Make sure that your cellular phone is set to connect to this product automatically. Refer to your cellular phone's operating instructions.

Trademarks

- The Bluetooth® word mark and logos are owned by the Bluetooth SIG, Inc. and any use of such marks by Panasonic Corporation is under license. All other trademarks identified herein are the property of their respective owners.

Link to cell	
Base unit: CELL indicators	
Status	Meaning
On	A cellular phone is connected. Ready to make/receive cellular calls.
Flashing	<ul style="list-style-type: none"> – The cellular line is in use. – Phonebook entries are being copied from a cellular phone. – The base unit is searching for the paired cellular phone. – A cellular call is put on hold.
Flashing rapidly	A cellular call is being received.
Light off	<ul style="list-style-type: none"> – A cellular phone is not paired to the base unit. – A cellular phone is not connected to the base unit.
Handset: Link to cell display items	
	A cellular line is in use. <ul style="list-style-type: none"> • When flashing: The cellular call is put on hold. • When flashing rapidly: A cellular call is being received.
	A cellular phone is connected.* ¹ Ready to make/receive cellular calls. <ul style="list-style-type: none"> • When turned off: A cellular phone is not connected to the base unit. * ¹ Corresponding cellular line(s) is(are) indicated next to the item.
	A cellular call is being done on that line.
Connecting/disconnecting the cellular phone (Handset/Base unit)	
<p>Auto connection to the cellular phone</p> <p>The unit connects to the cellular phone at regular intervals if the connection is lost. To change the interval (default: "1 min"), see the operating instructions.</p> <ul style="list-style-type: none"> • When you are using a cellular line or a Bluetooth headset, the base unit loses its connection from other Bluetooth devices (cellular phone or headset). To automatically resume the connection to cellular phones, leave the auto connection on. <p>Connecting/disconnecting the cellular phone manually</p> <p>If you will not be using the paired cellular phone's link to cell feature temporarily (for example, you do not want the unit to ring when your cellular line receives a call), you can disconnect your cellular phone from the base unit. If you want to use it again, reconnect the cellular phone to the base unit.</p> <ul style="list-style-type: none"> • Even if a paired cellular phone was disconnected from the base unit, if it is brought within the base unit's range during the auto connection interval, it may automatically connect to the base unit. • A disconnected cellular phone is not unpaired from the base unit, so pairing it to the base unit again is unnecessary. <p>1 To connect/disconnect:</p> <p>For CELL 1: [MENU]#6251 (A long beep sounds.) For CELL 2: [MENU]#6252 (A long beep sounds.) For CELL 3: [MENU]#6253 (A long beep sounds.) For CELL 4: [MENU]#6254 (A long beep sounds.)</p> <p>2 Proceed with the operation for your unit.</p> <p>Handset: [OFF] Base unit: [EXIT]</p>	

Basic operations	
Making/Answering calls (Handset)	
Making cellular calls	1 Dial the phone number. → [CELL] • When only 1 cellular phone is paired, the unit starts dialing. 2 When 2 or more cellular phones are paired: [↕] : Select the desired cellular phone. → [SELECT]
Making landline calls	Dial the phone number. → [📞]/[📞]
Answering calls	[📞]/[📞]
To hang up	[OFF]
To adjust the receiver or speaker volume	Press [▲] or [▼] repeatedly while talking.
Making a call using the redial list	1 [▶] REDIAL → [↕] : Select the desired phone number. 2 To make a cellular call: When only 1 cellular phone is paired: [CELL] or When 2 or more cellular phones are paired: [CELL] → [↕] : Select the desired cellular phone. → [SELECT] To make a landline call: [📞]
Making/Answering calls (Base unit)	
Making cellular calls	Dial the phone number. → Press the desired cellular line key ([CELL 1] to [CELL 4]).
Making landline calls	Dial the phone number. → [📞]
Answering calls	[📞]
To hang up	[📞]
To adjust the speaker volume	Press [▲] or [▼] repeatedly while talking.
Making a call using the redial list	1 [REDIAL] → [↕] : Select the desired phone number. 2 To make a cellular call: Press the desired cellular line key ([CELL 1] to [CELL 4]). To make a landline call: [📞]
Adjusting the ringer volume (Handset/Base unit)	
To adjust the handset ringer volume (cellular line/landline)	Press [▲] or [▼] repeatedly to select the desired volume while ringing.

Basic operations	
Phonebook (Handset)	
Adding entries	<ol style="list-style-type: none"> 1 [] → [MENU] 2 []: "Add new entry" → [SELECT] 3 Enter the party's name (16 characters max.). → [OK] 4 Enter the party's phone number (24 digits max.). → [OK] 5 []: Select the desired group. → [SELECT] 2 times → [OFF]
Making calls	<ol style="list-style-type: none"> 1 [] → []: Select the desired entry. 2 To make a cellular call: When only 1 cellular phone is paired: [CELL] or When 2 or more cellular phones are paired: [CELL] → []: Select the desired cellular phone. → [SELECT] To make a landline call: []
Phonebook (Base unit)	
Adding entries	<ol style="list-style-type: none"> 1 [] → [MENU] 2 []: "Add new entry" → [SELECT] 3 Enter the party's name (16 characters max.). → [OK] 4 Enter the party's phone number (24 digits max.). → [OK] 5 []: Select the desired group. → [SELECT] 2 times → [EXIT]
Making calls	<ol style="list-style-type: none"> 1 [] → []: Select the desired entry. 2 To make a cellular call: Press the desired cellular line key ([CELL 1] to [CELL 4]). To make a landline call: []
Answering system for the landline (Base unit)	
Answering on/off	To turn on/off: For line 1: Press [L1](ANSWER ON/OFF). For line 2: Press [L2](ANSWER ON/OFF).
Listening to messages	For line 1: Press [] (PLAY1). For line 2: Press [] (PLAY2).
Answering system for the landline (Handset)	
Listening to messages	To listen to new messages: For line 1: [MENU]#3231 For line 2: [MENU]#3232 To listen to all messages: For line 1: [MENU]#3241 For line 2: [MENU]#3242

Using Bluetooth devices

Copying phonebook entries from a Bluetooth cellular phone (phonebook transfer) (Handset/Base unit)

You can copy phonebook entries from the paired cellular phones or other cellular phones (not paired) to the unit's phonebook.

1 **[MENU]** **#** **6** **1** **8**

2 **To copy from paired cellular phones:**

[↓]: Select the desired cellular phone. → **[SELECT]**

- Copied items are stored to the group ("Cell 1" to "Cell 4") which the cellular phone is paired to.

To copy from other cellular phones (not paired):

[↓]: "other cell" → **[SELECT]** → **[↓]**: Select the group you want to copy to. → **[SELECT]**

3 **When "Use the cell to transfer phone book" is displayed:** Go to step 4.

When "Select mode" menu is displayed:

[↓]: Select "Auto" or "Manual". → **[SELECT]**

"Auto": Download all entries from the cellular phone automatically. Go to step 5.

"Manual": Copy entries you selected.

- "Select mode" menu is displayed only when the cellular phone supports PBAP (Phone Book Access Profile) for Bluetooth connection.

- Some cellular phones may require you to perform an operation on the cellular phone even if you select "Auto".

4 **Cellular phone:**

Follow the instructions of your cellular phone to copy phonebook entries.

- For other cellular phones (not paired), you need to search for and select the base unit. The base unit PIN (default: "0000") may be required.
- The entries being copied are displayed on the unit.

5 Wait until "Completed" is displayed.

6 Proceed with the operation for your unit.

Handset: **[OFF]**

Base unit: **[EXIT]**

Using Bluetooth devices

Using a Bluetooth wireless headset (optional) for landline calls

By pairing a Bluetooth headset to the base unit, you can have a hands-free conversation wirelessly for landline calls.

- While someone is using a cellular line, the Bluetooth headset connection is not available.

Pairing a headset to the base unit (Handset/Base unit)

1 Your headset:

Set your headset to pairing mode.

- Refer to your headset operating instructions.

2 [MENU]#621



- A Pair using the handset or base unit.
- B Pairing

3 If your headset PIN is "0000", go to step 4.

If your headset PIN is other than "0000", press [CLEAR], then enter your headset PIN.

- Typically, default PIN is "0000". Refer to the headset operating instructions.

4 Press [OK], then wait until a long beep sounds. → [OFF]/[EXIT]

- When the HEADSET indicator on the base unit lights up, the headset is available for use.

Operating a Bluetooth wireless headset using a landline (Base unit)

Refer to your headset operating instructions for headset operations.

■ Answering landline calls with your headset

To answer a landline call, turn on your headset referring to your headset operating instructions.

When you finish talking, turn off your headset referring to your headset operating instructions.

- If you cannot hang up the call using your headset, press [END] on the base unit 2 times.

■ Switching between the base unit and your headset

You can switch between the base unit and your headset:

- during a landline call with the base unit speakerphone.
- during an intercom call between the base unit and handset.
- while listening to messages recorded on the base unit answering system.

■ To switch to your headset:

Press [HEADSET] on the base unit.

■ To switch to the base unit:

Press [END] on the base unit.

Frequently asked questions	
Question	Cause/solution
Why is  displayed?	<ul style="list-style-type: none"> • The handset is too far from the base unit. Move closer. • The base unit's AC adaptor is not properly connected. Reconnect AC adaptor to the base unit. • The handset is not registered to the base unit. Register it. <ol style="list-style-type: none"> 1 Handset: [MENU]#[1][3][0] 2 Base unit: Press and hold [LOCATOR] for about 5 seconds until the registration tone sounds. 3 Handset: Press [OK], then wait until a long beep sounds.
Why am I unable to pair a cellular phone to the base unit?	<ul style="list-style-type: none"> • Depending on the compatibility of the cellular phone, you may not be able to pair it to the base unit. For more information, please visit http://www.panasonic.com/link2cell • Confirm that the Bluetooth feature of your cellular phone is turned on. You may need to turn this feature on depending on your cellular phone.
Why is there no dial tone? (cellular line)	<ul style="list-style-type: none"> • Make sure that the CELL indicator lights up and the cellular phone is connected to the base unit. • The cellular phone has not been paired to the base unit. Pair the cellular phone.
How can I increase the handset volume level?	<ul style="list-style-type: none"> • Press the navigator key [▲] repeatedly while talking.
Why is the conversation noisy or cutting off?	<ul style="list-style-type: none"> • Try to relocate the base unit so that distance to the handset is minimized. • If the same problem occurs even if the handset is next to the base unit, call Panasonic customer support at 1-800-211-PANA (1-800-211-7262).
Can I add another accessory handset to my base unit?	<ul style="list-style-type: none"> • Yes, you can add up to 6 handsets (including the handset(s) sold with your base unit) to a single base unit. • To purchase additional accessory handset(s) (KX-TGA950), please visit: http://www.pstc.panasonic.com or call 1-800-332-5368. TTY users (hearing or speech impaired users) can call 1-866-605-1277.
Can I keep the batteries charging all the time?	<ul style="list-style-type: none"> • You can leave the handset on the base unit or charger anytime. This will not harm the batteries.
How can I answer a call waiting call (2nd call)?	<ul style="list-style-type: none"> • Press [CALL WAIT] when you hear the call waiting tone.