

Panasonic[®]

Operating Instructions

Digital Corded/Cordless Answering System

Model No. **KX-TG9471C**

KX-TG9472C

2LINE



Model shown is KX-TG9471.

Before initial use, see “Getting Started” on page 9.

Thank you for purchasing a Panasonic product.

Please read these operating instructions before using the unit and save them for future reference.

This unit is compatible with Call Display. You must subscribe to the appropriate service offered by your service provider/telephone company.

For assistance, please call **1-800-561-5505** or visit us at www.panasonic.ca

Table of Contents

Introduction		
Model composition	3	
Accessory information	3	
System capabilities	5	
“Telephone Plug-in” for Microsoft Office Outlook overview	5	
Important Information		
For your safety	6	
Important safety instructions	7	
For best performance	7	
Other information	7	
Specifications	8	
Getting Started		
Setting up	9	
Note when setting up	11	
Controls	12	
Belt clip	13	
Display/indicators	13	
Initial settings	14	
Making/Answering Calls		
Making calls	16	
Answering calls	17	
Useful features during a call	17	
Using the other line during a call	19	
“Telephone Plug-in” for Microsoft Office Outlook		
“Telephone Plug-in” settings	20	
Making a call from “Telephone Plug-in”	21	
“Telephone Plug-in” pop-up window for incoming call	23	
“Telephone Plug-in” toolbar settings	23	
Phonebook		
Base unit/handset phonebook	24	
Copying phonebook entries	26	
Programming		
Programmable settings	27	
Special programming	31	
Registering a unit	32	
Call Display Service		
Using Call Display service	33	
Caller list	33	
Answering System		
Answering system	36	
Turning the answering system on/off	36	
Greeting message	36	
Listening to messages using the base unit	37	
Listening to messages using the handset	38	
Remote operation	39	
Answering system settings	40	
Voice Mail Service		
Voice Mail service	42	
Intercom/Locator		
Intercom	43	
Handset locator	43	
Transferring calls	43	
Conference calls	44	
Useful Information		
Wall mounting	45	
Error messages	46	
Troubleshooting	47	
Industry Canada Notices and other information	52	
Warranty	53	
Index		
Index.....	54	

Model composition

Series	Model No.	Base unit	Handset	
		Part No.	Part No.	Quantity
KX-TG9471 series	KX-TG9471	KX-TG9471	KX-TGA939	1
	KX-TG9472	KX-TG9471	KX-TGA939	2

- The suffix (C) in the following model numbers will be omitted in these instructions: KX-TG9471C/
KX-TG9472C

Accessory information

Supplied accessories

No.	Accessory item/Part number	Quantity	
		KX-TG9471	KX-TG9472
①	AC adaptor/PQLV219	2	3
②	4-wire telephone line cord with green plugs	1	1
③	2-wire telephone line cord with transparent plugs	1	1
④	Desk stand/Wall mounting adaptor ^{*1}	1	1
⑤	Corded handset	1	1
⑥	Corded handset cord	1	1
⑦	Rechargeable batteries ^{*2}	2	4
⑧	Handset cover ^{*3}	1	2
⑨	Belt clip	1	2
⑩	Charger	1	2
⑪	mini USB cable	1	1
⑫	CD-ROM	1	1

*1 The desk stand/wall mounting adaptor comes attached to the base unit.

*2 See page 4 for replacement battery information.

*3 The handset cover comes attached to the handset.

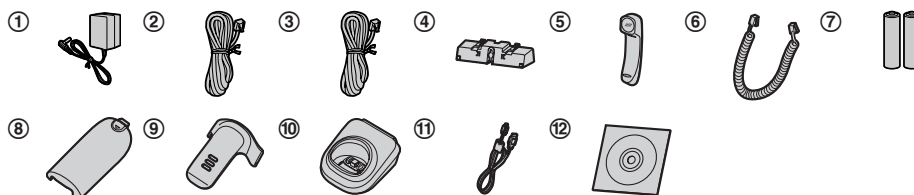

Introduction

Additional/replacement accessories

Please contact your nearest Panasonic dealer for sales information.

Accessory item	Order number
Rechargeable batteries	HHR-4DPA or HHR-4MRA*1
	Battery type: – Nickel metal hydride (Ni-MH) – 2 x AAA (R03) size for each handset
Headset	RP-TCA94, RP-TCA95, KX-TCA400, KX-TCA430
T-adaptor	KX-J66
2-line splitter	KX-J42

*1 Replacement batteries may have a different capacity from that of the supplied batteries.

Expanding your phone system

Optional handset feature overview

Handset (optional): KX-TGA939C	
<p>You can expand your phone system by registering optional handsets (6 max.) to a single base unit.</p> <ul style="list-style-type: none">• Optional handsets may be a different colour from that of the supplied handsets.	

System capabilities

The unit can accommodate up to 2 external telephone lines and the following operations are available at the same time.

How many units can be in use at one time?

■ A maximum of 4 parties are available:

Line 1: Outside call (including 1 extension and 1 outside party)

Line 2: Outside call (including 1 extension and 1 outside party)

e.g. Outside call on line 1



e.g. Outside call on line 2



■ A maximum of 5 parties are available:

Line 1: Conference call (including 2 extensions and 1 outside party)

Line 2: Outside call (including 1 extension and 1 outside party)

e.g. Conference call on line 1

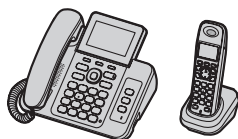

e.g. Outside call on line 2



■ The following operations are possible simultaneously:

- An outside call and 1 pair of intercom call can be made at a time.
- While a caller is leaving a message on your answering system through one line, the unit can make an outside call through another line.

Note:

- The maximum operating number may decrease, depending on the state of usage, for example, when the answering system is taking a call.

“Telephone Plug-in” for Microsoft Office Outlook overview

By installing the supplied “Telephone Plug-in” for Microsoft® Office Outlook® and connecting the base unit and your computer with the mini USB cable, the following features are available:

- You can make a call from the contact list of Microsoft Office Outlook through the base unit speakerphone.
- Caller information is shown in a pop-up window on your computer display when a call is received.

Important Information

For your safety

To prevent severe injury and loss of life/property, read this section carefully before using the product to ensure proper and safe operation of your product.

WARNING

Power connection

- Use only the power source marked on the product.
- Do not overload power outlets and extension cords. This can result in the risk of fire or electric shock.
- Completely insert the AC adaptor/power plug into the power outlet. Failure to do so may cause electric shock and/or excessive heat resulting in a fire.
- Regularly remove any dust, etc. from the AC adaptor/power plug by pulling it from the power outlet, then wiping with a dry cloth. Accumulated dust may cause an insulation defect from moisture, etc. resulting in a fire.
- Unplug the product from power outlets if it emits smoke, an abnormal smell, or makes an unusual noise. These conditions can cause fire or electric shock. Confirm that smoke has stopped emitting and contact an authorized service centre.
- Unplug from power outlets and never touch the inside of the product if its casing has been broken open.
- Never touch the plug with wet hands. Danger of electric shock exists.

Installation

- To prevent the risk of fire or electrical shock, do not expose the product to rain or any type of moisture.
- Do not place or use this product near automatically controlled devices such as automatic doors and fire alarms. Radio waves emitted from this product may cause such devices to malfunction resulting in an accident.
- Do not allow the AC adaptor or telephone line cord to be excessively pulled, bent or placed under heavy objects.

Operating safeguards

- Unplug the product from power outlets before cleaning. Do not use liquid or aerosol cleaners.
- Do not disassemble the product.
- Do not spill liquids (detergents, cleansers, etc.) onto the telephone line cord plug, or allow it to become wet at all. This may cause a fire. If the telephone line cord plug becomes wet, immediately pull it from the telephone wall jack, and do not use.
- Do not excessively pull the corded handset cord from the base unit. This may cause the base unit to fall, resulting in injury.

Medical

- Consult the manufacturer of any personal medical devices, such as pacemakers or hearing aids, to determine if they are adequately shielded from external RF (radio frequency) energy. (The product operates in

the frequency range of 1.92 GHz to 1.93 GHz, and the RF transmission power is 115 mW (max.)

- Do not use the product in health care facilities if any regulations posted in the area instruct you not to do so. Hospitals or health care facilities may be using equipment that could be sensitive to external RF energy.

CAUTION

Installation and location

- Never install telephone wiring during an electrical storm.
- Never install telephone line jacks in wet locations unless the jack is specifically designed for wet locations.
- Never touch uninsulated telephone wires or terminals unless the telephone line has been disconnected at the network interface.
- Use caution when installing or modifying telephone lines.
- The AC adaptor is used as the main disconnect device. Ensure that the AC outlet is installed near the product and is easily accessible.
- This product is unable to make calls when:
 - the handset batteries need recharging or have failed.
 - there is a power failure.

Battery

- We recommend using the batteries noted on page 4. **USE ONLY rechargeable Ni-MH batteries AAA (R03) size.**
- Do not mix old and new batteries.
- Do not open or mutilate the batteries. Released electrolyte from the batteries is corrosive and may cause burns or injury to the eyes or skin. The electrolyte is toxic and may be harmful if swallowed.
- Exercise care when handling the batteries. Do not allow conductive materials such as rings, bracelets, or keys to touch the batteries, otherwise a short circuit may cause the batteries and/or the conductive material to overheat and cause burns.
- Charge the batteries provided with or identified for use with this product only, in accordance with the instructions and limitations specified in this manual.
- Only use a compatible charger to charge the batteries. Do not tamper with the charger. Failure to follow these instructions may cause the batteries to swell or explode.

Attention:



A nickel metal hydride battery that is recyclable powers the product you have purchased. Please call 1-800-8-BATTERY (1-800-822-8837) for information on how to recycle this battery.

Important safety instructions

When using your product, basic safety precautions should always be followed to reduce the risk of fire, electric shock, and injury to persons, including the following:

1. Do not use this product near water for example, near a bathtub, washbowl, kitchen sink, or laundry tub, in a wet basement or near a swimming pool.
2. Avoid using a telephone (other than a cordless type) during an electrical storm. There may be a remote risk of electric shock from lightning.
3. Do not use the telephone to report a gas leak in the vicinity of the leak.
4. Use only the power cord and batteries indicated in this manual. Do not dispose of batteries in a fire. They may explode. Check with local codes for possible special disposal instructions.

SAVE THESE INSTRUCTIONS

For best performance

Base unit location/avoiding noise

The base unit and other compatible Panasonic units use radio waves to communicate with each other.

- For maximum coverage and noise-free communications, place your base unit:
 - at a convenient, high, and central location with no obstructions between the cordless handset and base unit in an indoor environment.
 - away from electronic appliances such as TVs, radios, personal computers, wireless devices, or other phones.
 - facing away from radio frequency transmitters, such as external antennas of mobile phone cell stations. (Avoid putting the base unit on a bay window or near a window.)
- Coverage and voice quality depends on the local environmental conditions.
- If the reception for a base unit location is not satisfactory, move the base unit to another location for better reception.

Environment

- Keep the product away from electrical noise generating devices, such as fluorescent lamps and motors.
- The product should be kept free from excessive smoke, dust, high temperature, and vibration.
- The product should not be exposed to direct sunlight.
- Do not place heavy objects on top of the product.
- When you leave the product unused for a long period of time, unplug the product from the power outlet.
- The product should be kept away from heat sources such as heaters, kitchen stoves, etc. It should not be placed in rooms where the temperature is less than 0 °C (32 °F) or greater than 40 °C (104 °F). Damp basements should also be avoided.
- The maximum calling distance may be shortened when the product is used in the following places: Near obstacles such as hills, tunnels, underground, near metal objects such as wire fences, etc.

- Operating the product near electrical appliances may cause interference. Move away from the electrical appliances.

Routine care

- Wipe the outer surface of the product with a soft moist cloth.
- Do not use benzene, thinner, or any abrasive powder.

Other information

CAUTION: Risk of explosion if battery is replaced by an incorrect type. Dispose of used batteries according to the instructions.

Notice for product disposal, transfer, or return

- This product can store your private/confidential information. To protect your privacy/confidentiality, we recommend that you erase information such as phonebook or caller list entries from the memory before you dispose of, transfer, or return the product.

Compliance with TIA-1083 standard

Telephone handsets identified with this logo have reduced noise and interference when used with T-Coil equipped hearing aids and cochlear implants.

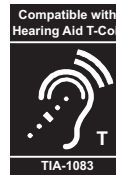

Important Information

Specifications

- **Standard:**
DECT 6.0 (Digital Enhanced Cordless Telecommunications 6.0)
- **Frequency range:**
1.92 GHz to 1.93 GHz
- **RF transmission power:**
115 mW (max.)
- **Power source:**
120 V AC, 60 Hz
- **Power consumption:**
Base unit:
Standby: Approx. 1.2 W
Maximum: Approx. 2.7 W
Charger:
Standby: Approx. 0.6 W
Maximum: Approx. 3.6 W
- **Interface:**
USB 2.0 Full speed (12 Mbps)
- **Operating conditions:**
0 °C – 40 °C (32 °F – 104 °F), 20 % – 80 % relative air humidity (dry)

Note:

- Design and specifications are subject to change without notice.
- The illustrations in these instructions may vary slightly from the actual product.

Setting up

Connecting the AC adaptor/corded handset

- Use only the supplied Panasonic AC adaptor PQLV219.

■ Base unit

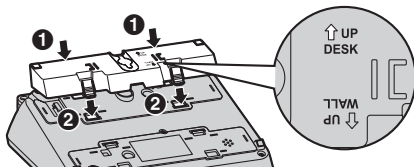
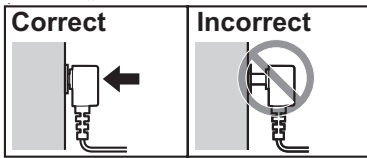
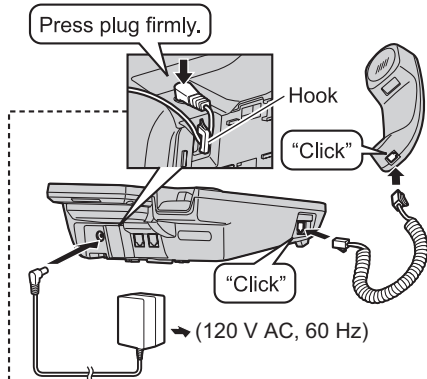
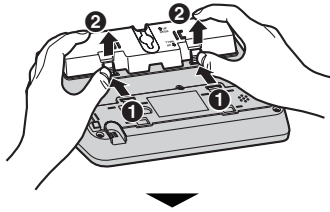

- The words "UP DESK" should be facing up.

■ Charger

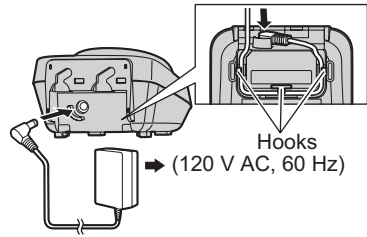

Connecting the telephone line cord

Refer to one of the following methods depending on your situation:

- To connect to a 2-line telephone jack: page 9
- To connect to 2 single-line telephone jacks: page 9
- If you use the unit as a single-line telephone only: page 10

Connect the telephone line cord until it clicks into the base unit and telephone line jack.

To connect to a 2-line telephone jack

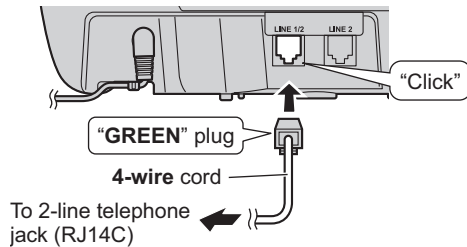

To connect to 2 single-line telephone jacks

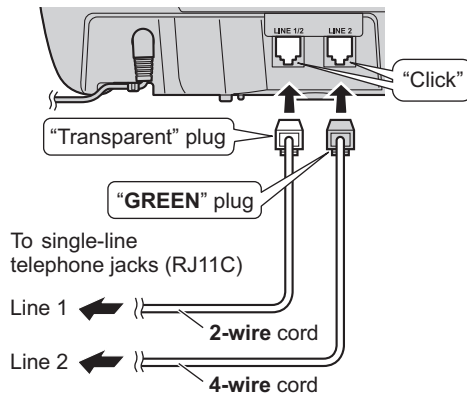

Getting Started

If you use the unit as a single-line telephone only

Be sure to connect the telephone line cord to LINE 1/2. Change the line selection mode from "Auto" to "Line1" (page 15).

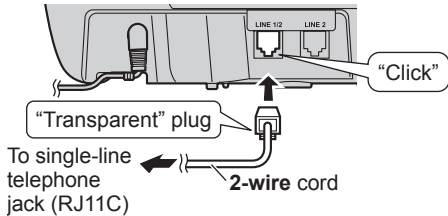

Note:

- "Check tel line 2" is displayed on the unit. To erase it, see page 46.

If you subscribe to a DSL/ADSL service

Please attach a DSL/ADSL filter (contact your DSL/ADSL provider) to the telephone line between the base unit and the telephone line jack in the event of the following:

- noise is heard during conversations.
- Call Display features do not function properly.

To connect to a 2-line telephone jack

For this connection, please purchase a Panasonic 2-line splitter (page 4).

Example: DSL/ADSL line is line 2

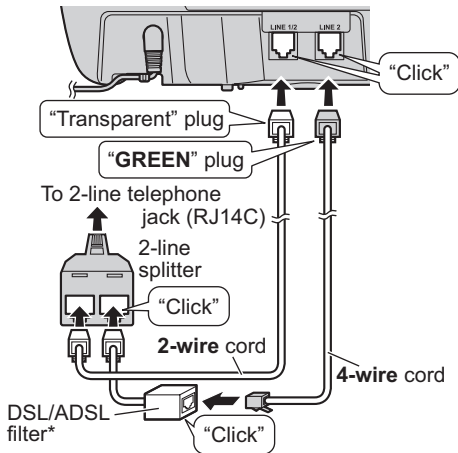

*DSL/ADSL filter (not supplied) is required if you have DSL/ADSL service.

To connect to 2 single-line telephone jacks

Example: DSL/ADSL line is line 2

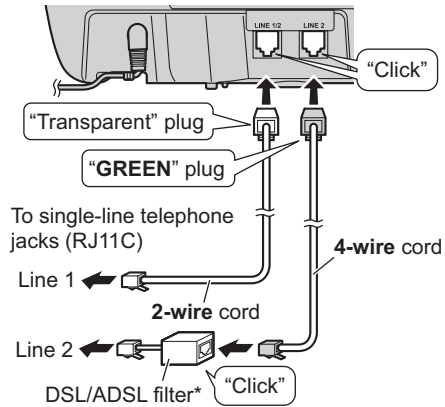

*DSL/ADSL filter (not supplied) is required if you have DSL/ADSL service.

Battery installation

- USE ONLY Ni-MH batteries AAA (R03) size.
- Do NOT use Alkaline/Manganese/Ni-Cd batteries.
- Confirm correct polarities (+, -).

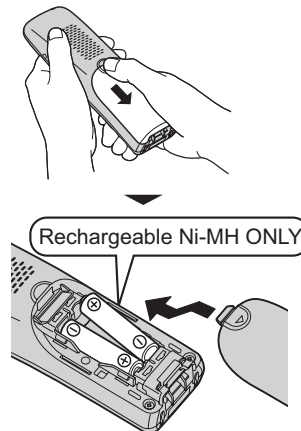

Battery charging

Charge for about 7 hours.

- When the batteries are fully charged, “Charge completed” is displayed.

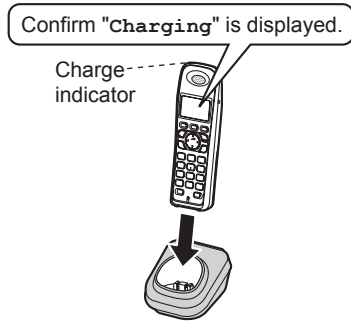

Note when setting up

Note for connections

- The AC adaptor must remain connected at all times. (It is normal for the adaptor to feel warm during use.)
- The AC adaptor should be connected to a vertically oriented or floor-mounted AC outlet. Do not connect the AC adaptor to a ceiling-mounted AC outlet, as the weight of the adaptor may cause it to become disconnected.

During a power failure

The unit will not work during a power failure. We recommend connecting a corded-type telephone (without AC adaptor) to the same telephone line or to the same telephone line jack using a T-adaptor.

Note for battery installation

- Use the supplied rechargeable batteries. For replacement, we recommend using the Panasonic rechargeable batteries noted on page 4, 6.
- Wipe the battery ends (⊕, ⊖) with a dry cloth.
- Avoid touching the battery ends (⊕, ⊖) or the unit contacts.

Note for battery charging

- It is normal for the handset to feel warm during charging.
- Clean the charge contacts of the handset and charger with a soft and dry cloth once a month. Clean more often if the unit is exposed to grease, dust, or high humidity.

Battery level

Icon	Battery level
	High
	Medium
	Low
	Needs charging.

Panasonic Ni-MH battery performance (supplied batteries)

Operation	Operating time
In continuous use	12 hours max.
Not in use (standby)	6 days max.

Note:

- Actual battery performance depends on usage and ambient environment.
- Even after the batteries are fully charged, the handset can be left on the charger without any ill effect on the batteries.
- The battery level may not be displayed correctly after you replace the batteries. In this case, place the handset on the charger and let it charge for at least 7 hours.

Getting Started

Controls

Base unit

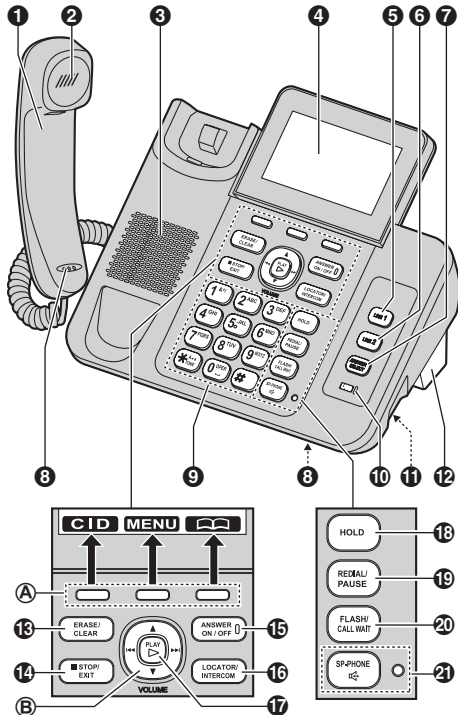

- 1 Coded handset
- 2 Receiver
- 3 Speaker
- 4 Display
 - The display can be moved back and forth to select the desired angle.
- 5 [LINE 1]
LINE 1 indicator
- 6 [LINE 2]
LINE 2 indicator
- 7 [ANSWER SELECT]
- 8 Microphone
- 9 Dial keypad (☒): TONE
- 10 USB indicator
- 11 USB jack

- 12 Desk stand/Wall mounting adaptor
 - The adaptor is a removable attachment for desk stand or wall mounting use. (page 9, 45).
- 13 [ERASE] [CLEAR]
- 14 [■] (STOP) (EXIT)
- 15 [ANSWER ON/OFF]
ANSWER ON/OFF indicator
- 16 [LOCATOR] [INTERCOM]
- 17 [▶] (PLAY)
Message indicator
- 18 [HOLD]
- 19 [REDIAL] [PAUSE]
- 20 [FLASH] [CALL WAIT]
- 21 [📞] (SP-PHONE: Speakerphone)
SP-PHONE indicator

Control type

A Soft keys

The base unit features 3 soft keys. By pressing a soft key, you can select the feature shown directly above it on the display.

B Navigator key

- [▲], [▼], [◀], or [▶]: Scroll through various lists and items.
- VOLUME ([▲] or [▼]): Adjust the receiver or speaker volume while talking.
- [◀]/[▶]: Repeat/skip messages during playback.

Handset

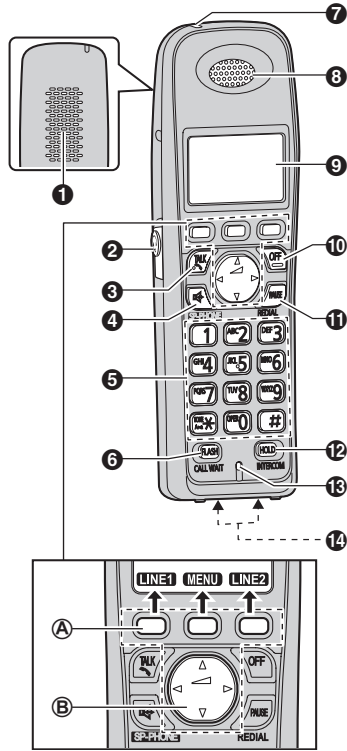

- 1 Speaker
- 2 Headset jack
- 3 [TALK]
- 4 [SP-PHONE: Speakerphone]
- 5 Dial keypad [TONE]
- 6 [FLASH] [CALL WAIT]
- 7 Charge indicator
Ringer indicator
- 8 Receiver
- 9 Display
- 10 [OFF]
- 11 [PAUSE] [REDIAL]
- 12 [HOLD] [INTERCOM]
- 13 Microphone
- 14 Charge contacts

Control type

A Soft keys

The handset features 3 soft keys. By pressing a soft key, you can select the feature shown directly above it on the display.

B Navigator key

- [▲], [▼], [◀], or [▶]: Scroll through various lists and items.
- (Volume: [▲] or [▼]): Adjust the receiver or speaker volume while talking.

Belt clip

To attach

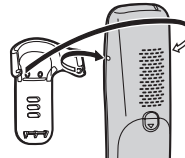

To remove



Display/indicators

Base unit display items







Item	Meaning
LINE1 LINE2	Indicates the selected line(s) for answering system operations and settings.
L1 L2	Ringer volume is off.*1 (page 17)
	Night mode is on. (page 31)
PRIV.	Privacy mode is on. (page 19)

*1 Corresponding line number(s) is indicated next to the item.

Handset display items

Item	Meaning
	Battery level
	Within range of the base unit <ul style="list-style-type: none"> ● When flashing: Handset is searching for the base unit. (page 48)







Getting Started

Item	Meaning
 	The line is in use. <ul style="list-style-type: none"> When flashing: <ul style="list-style-type: none"> The call is put on hold on that line. The answering system is answering a call on that line. When flashing rapidly: An incoming call is now being received on that line.
	Ringer volume is off.*1 (page 17)
	Speakerphone is on. (page 16)
	Night mode is on. (page 31)
	Alarm is on. (page 31)
	Handset number
PRIV.	Privacy mode is on. (page 19)

*1 Corresponding line number(s) is indicated next to the item.

Main menu icons

The following icons are shown when you press down on the middle soft key in standby mode.

Icon	Feature
	View Caller ID
	Phonebook
 *1	Set answering
 *2	Answering device
	Ringer settings
	Initial settings
	Customer support

*1 Base unit

*2 Handset

LINE 1 indicator/LINE 2 indicator on the base unit

The LINE 1 indicator and LINE 2 indicator show the status of each line, respectively, as follows.

Status	Meaning
Light off	The line is available.
Light on	The line is in use.
Flashing rapidly	A call is being received.
Flashing	A call is put on hold or the answering system is answering a call.

USB indicator on the base unit

Status	Meaning
Light off	"Telephone Plug-in" is not active.
Light on	"Telephone Plug-in" is active.



Initial settings

■ Direct command code:

Programmable settings can be accessed by pressing **[MENU]**, **[#]** and then the corresponding code on the dial keypad (page 27).

Example: Press **[MENU][#]1110**.

■ Symbol meaning:

Symbol	Meaning
	Perform with the base unit.
	Perform with the handset.
Example:  : "Off"	Press [▼] or [▲] to select the words in quotations.

Date and time

Program this setting using either the base unit or one of the handsets.

Base unit / Handset

- [MENU][#]101**
- Enter the current month, date, and year by selecting 2 digits for each.
Example: July 15, 2011
07 15 11
- Enter the current hour and minute (12-hour clock format) by selecting 2 digits for each.
Example: 9:30
09 30
- : Select "AM" or "PM". → **[SAVE]**
- Proceed with the operation for your unit.
Base unit: **[■]** (EXIT)
Handset: **[OFF]**

Note:

- When English is selected as the display language, 12-hour clock format is used. When French is selected, 24-hour clock format is used.

- The date and time may be incorrect after a power failure. In this case, set the date and time again.

Display language

You can select either “English” or “Français” as the display language. The default setting is “English”.

Base unit / Handset

- 1 [MENU]#1110
- 2 [↕]: Select the desired setting. → [SAVE]
- 3 Proceed with the operation for your unit.
Base unit: [■] (EXIT)
Handset: [OFF]

Voice guidance language

You can select either “English” or “Français” as the voice guidance language of the answering system. The default setting is “English”. Program this setting using either the base unit or one of the handsets.

Base unit / Handset

- 1 [MENU]#1112
- 2 [↕]: Select the desired setting. → [SAVE]
- 3 Proceed with the operation for your unit.
Base unit: [■] (EXIT)
Handset: [OFF]

Dialing mode

If you cannot make calls, change this setting according to your telephone line service. The default setting is “Tone”.

“Tone”: For tone dial service.

“Pulse”: For rotary/pulse dial service.

Program this setting using either the base unit or one of the handsets.

Base unit / Handset

- 1 [MENU]#120
- 2 [↕]: Select the desired setting. → [SAVE]
- 3 Proceed with the operation for your unit.
Base unit: [■] (EXIT)
Handset: [OFF]

Line selection mode

The line selection mode determines which line is selected when:

- you lift the corded handset
- you press [☎] on the base unit (when making/answering calls)
- you press [☎]/[☎] on the handset (when making/answering calls)

The following setting is available:

- “Auto” (default): When making a call, line 1 is selected. If that line is unavailable, line 2 is selected. When you call back using the caller list (page 33) or while listening to a message (page 37, 38), the indicated line is used. When answering a call, the ringing line is selected.
- “Line1”: Line 1 is selected.
- “Line2”: Line 2 is selected.

Base unit / Handset

- 1 [MENU]#250
- 2 [↕]: Select the desired setting. → [SAVE]
- 3 Proceed with the operation for your unit.
Base unit: [■] (EXIT)
Handset: [OFF]

Note:

- You can select a line manually regardless of the line selection mode by pressing [LINE 1] or [LINE 2].

Making/Answering Calls

Making calls

Using the base unit

- 1 Dial the phone number.
 - To correct a digit, press **[CLEAR]**.
- 2 Lift the corded handset.
 - An available line is automatically selected and either the LINE 1 indicator or LINE 2 indicator lights up. To change the line selection mode, see page 15.
 - You can also select the line manually by pressing **[LINE 1]** or **[LINE 2]** before lifting the corded handset.
- 3 When you finish talking, place the corded handset on the cradle.

Note:

- You can also dial the phone number after lifting the corded handset.
- To switch to the cordless handset, press **[LINE 1]** or **[LINE 2]** on the cordless handset, then place the corded handset on the cradle.

Using the speakerphone

- 1 During a conversation with the corded handset, press **[☎]** to turn on the speakerphone.
 - You can place the corded handset on the cradle.
 - Speak into the base unit microphone.
 - Speak alternately with the other party.
- 2 When you finish talking, press **[☎]**.

Note:

- For best performance, use the speakerphone in a quiet environment.
- To switch to the receiver, lift the corded handset.

Using the handset

- 1 Lift the handset and dial the phone number.
 - To correct a digit, press **[CLEAR]**.
- 2 Press **[☎]**.
 - An available line is automatically selected and the line number is displayed. To change the line selection mode, see page 15.
 - You can also select the line manually by pressing **[LINE 1]** or **[LINE 2]**.

- 3 When you finish talking, press **[OFF]** or place the handset on the charger.

Note:

- The LINE 1 indicator or LINE 2 indicator on the base unit lights up while using the handset.

Using the speakerphone

- 1 Dial the phone number and press **[☎]**.
 - Speak alternately with the other party.
- 2 When you finish talking, press **[OFF]**.

Note:

- For best performance, use the speakerphone in a quiet environment.
- To switch back to the receiver, press **[☎]**.

Adjusting the receiver or speaker volume

 Base unit /  Handset

Press **[▲]** or **[▼]** repeatedly while talking.

Making a call using the redial list

 Base unit /  Handset

The last 10 phone numbers dialed are stored in the redial list (each 48 digits max.).

- 1 **[REDIAL]**
- 2 **[↕]**: Select the desired phone number.
- 3 Proceed with the operation for your unit.
Base unit: Lift the corded handset.
Handset: **[☎]**

Erasing a number in the redial list

- 1 **[REDIAL]**
- 2 **[↕]**: Select the desired phone number. → **[ERASE]** (Soft key)
- 3 **[↕]**: "Yes" → **[SELECT]**
- 4 Proceed with the operation for your unit.
Base unit: **[■]** (EXIT)
Handset: **[OFF]**

Pause (for PBX/long distance service users)

A pause is sometimes required when making calls using a PBX or long distance service. When storing a calling card access number and/or PIN in

Making/Answering Calls

the phonebook, a pause is also needed (page 26).

Example: If you need to dial the line access number "9" when making outside calls with a PBX:

Base unit / Handset

- 1 **[9]** → **[PAUSE]**
- 2 Dial the phone number.
- 3 Proceed with the operation for your unit.
Base unit: Lift the corded handset.
Handset: **[]**



Note:

- A 3.5 second pause is inserted each time **[PAUSE]** is pressed. Repeat as needed to create longer pauses.



Answering calls



Using the base unit

When a call is being received, the LINE 1 indicator and/or LINE 2 indicator on the base unit flashes rapidly.

- 1 Lift the corded handset or press **[]** when the unit rings.
 - The called line is automatically selected. To change the line selection mode, see page 15.
 - You can also answer the call by pressing **[LINE 1]** or **[LINE 2]**.
- 2 When you finish talking, place the corded handset on the cradle. When the speakerphone is used, press **[]**.

Using the handset

When a call is being received, the ringer indicator and  and/or  flashes rapidly.

- 1 Lift the handset and press **[]** or **[]** when the unit rings.
 - The called line is automatically selected. To change the line selection mode, see page 15.
 - You can also answer the call by pressing **[LINE 1]** or **[LINE 2]**.
 - You can also answer the call by pressing any dial key from **[0]** to **[9]**, **[*]**, or **[#]**. (**Any key answer feature**)



- 2 When you finish talking, press **[OFF]** or place the handset on the charger.

Auto talk

You can answer calls simply by lifting the handset off the charger. You do not need to press **[]**. To turn this feature on, see page 29.

Adjusting the ringer volume

Base unit / Handset

- **While the unit is ringing for an incoming call:**
Press **[▲]** or **[▼]** repeatedly to select the desired volume.
- **Programming the volume beforehand:**
 - 1 **[MENU]****[#]****[1]****[6]****[0]**
 - 2 **[]**: Select the desired line. → **[SELECT]**
 - 3 **[]**: Select the desired volume. → **[SAVE]**
 - 4 Proceed with the operation for your unit.
Base unit: **[]** (EXIT)
Handset: **[OFF]**

Temporary ringer off

Base unit / Handset

While the unit is ringing for a call, you can turn the ringer off temporarily by pressing **[]** on the base unit or **[OFF]** on the handset.

Useful features during a call

Hold

This feature allows you to put an outside call on hold.

Base unit

- 1 Press **[HOLD]** during an outside call.
 - If you are using the corded handset, you can place it on the cradle.
- 2 To release hold, press **[LINE 1]** or **[LINE 2]** that is flashing on the base unit.

Handset

- 1 Press **[HOLD]** 2 times during an outside call.

Making/Answering Calls

- 2 To release hold, press **[LINE 1]** or **[LINE 2]** that is flashing on the handset.

Note for base unit and handset:

- If a call is kept on hold for more than 9 minutes, an alarm tone starts to sound and the ringer indicator on the handset flashes rapidly. After 1 additional minute on hold, the call is disconnected.
- If another phone is connected to the same line, you can also take the call by lifting its handset.

Mute

While mute is turned on, you can hear the other party, but the other party cannot hear you.

Base unit / Handset

- 1 Press **[MUTE]** during conversation.
 - **[MUTE]** flashes.
- 2 To return to the conversation, press **[MUTE]** again.

Note:

- **[MUTE]** is a soft key visible on the display during a call.

Flash

Base unit / Handset

[FLASH] allows you to use the special features of your host PBX such as transferring an extension call, or accessing optional telephone services.

Note:

- To change the flash time, see page 29.

For Call Waiting or Visual Call Waiting service users

To use Call Waiting or Visual Call Waiting, you must first subscribe with your service provider/telephone company.

This feature allows you to receive calls while you are already talking on the phone. If you receive a call while on the phone, you will hear a Call Waiting tone.

If you subscribe to both Call Display and Visual Call Waiting services, the 2nd caller's information is displayed on the base unit or handset that is in use after you hear the Call Waiting tone.

Base unit / Handset

- 1 Press **[CALL WAIT]** to answer the 2nd call.
- 2 To switch between calls, press **[CALL WAIT]**.

Note:

- Please contact your service provider/telephone company for details and availability of this service in your area.

Temporary tone dialing (for rotary/pulse service users)

You can temporarily switch the dialing mode to tone when you need to access touch-tone services (for example, answering services, telephone banking services, etc.).

Base unit / Handset

Press **[*]** (TONE) before entering access numbers which require tone dialing.

Call share

You can join an existing outside call.

Base unit

To join the conversation, press **[LINE 1]** or **[LINE 2]** to select the line that is being used by another extension for an outside call, then lift the corded handset.

Handset

To join the conversation, press **[LINE 1]** or **[LINE 2]** to select the line that is being used by another extension for an outside call.

Note for base unit and handset:

- A maximum of 3 parties (including 1 outside party) can join a conversation. **(3-way conference)**

Privacy mode

When the privacy mode is "On", the unit prevents other users from joining your conversations with outside callers. You can turn the feature on for both lines by programming the base unit before the call. To allow other users to join your conversations, leave this feature off. The default setting is "OFF".

Base unit

- 1 **[MENU]** **[#]** **[1]** **[9]** **[4]**
- 2 **[↕]**: “On” or “Off” → **[SAVE]**
- 3 **[■]** (EXIT)
 - When this feature is turned on, “PRIV.” is displayed during an outside call.

Temporarily turning call privacy on/off

During an outside call, you can temporarily turn call privacy on/off.

Base unit

- 1 Press **[MENU]** during an outside call.
 - If any options appear on the display, perform the following:
[↕]: “Privacy” → **[SELECT]**
- 2 **[↕]**: “On” or “Off” → **[SELECT]**
 - When this feature is turned on, “PRIV.” is displayed.

Handset

- 1 Press **[MENU]** during an outside call.
- 2 **[↕]**: “Privacy” → **[SELECT]**
- 3 **[↕]**: “On” or “Off” → **[SELECT]**
 - When this feature is turned on, “PRIV.” is displayed.

Note for base unit and handset:

After you hang up the call, the feature will return to the setting programmed on page 18.

Using the other line during a call

You can use the other line in the following ways:

- When a call is being received on the other line during a conversation, an interrupt tone will be heard (page 29). You can answer the 2nd call while holding the 1st call.
- During an outside call, you can also make a call using the other line by holding the 1st call.

Base unit

Example: If you are using line 1:

- 1 Press **[HOLD]** to put the 1st call (line 1) on hold.
- 2 Press **[LINE 2]** to make or answer a 2nd call.
 - To hold the 2nd call, press **[HOLD]**.

- 3 To return to the 1st call (line 1), press **[LINE 1]**.

Handset

Example: If you are using line 1:

- 1 Press **[HOLD]** 2 times to put the 1st call (line 1) on hold.
- 2 Press **[LINE 2]** to make or answer a 2nd call.
 - To hold the 2nd call, press **[HOLD]** 2 times.
- 3 To return to the 1st call (line 1), press **[LINE 1]**.

Note for base unit and handset:

- If you subscribe to Call Display, the 2nd caller's information is displayed when a call is being received on the other line (page 33).

“Telephone Plug-in” for Microsoft Office Outlook

“Telephone Plug-in” settings

System requirements

Item	Specifications
CPU	1.0 GHz Intel® Pentium®/Celeron® processor or comparable CPU or higher processor
RAM	512 MB or more
OS	<ul style="list-style-type: none">• Microsoft Windows® XP Service Pack 3 or later (32-bit only)• Microsoft Windows Vista® Service Pack 2 or later• Microsoft Windows 7 Service Pack 1 or later
Microsoft Office Outlook	<ul style="list-style-type: none">• Microsoft Office Outlook 2003 Service Pack 3 or later• Microsoft Office Outlook 2007 Service Pack 2 or later• Microsoft Office Outlook 2010 or later (Service Pack)
Hard disk	20 MB or more
Video resolution	1,024 x 768 or higher
Others	<ul style="list-style-type: none">• CD-ROM drive• USB 2.0

Trademarks:

- Microsoft, Windows, Windows Vista, and Outlook are either registered trademarks or trademarks of Microsoft Corporation in the United States and/or other countries.
- Intel, Celeron and Pentium are trademarks of Intel Corporation in the U.S. and other countries.
- All other trademarks identified herein are the property of their respective owners.
- Microsoft product screen shots reprinted with permission from Microsoft Corporation.

Note:

- The screen shot shown is for Microsoft Office Outlook 2010.
- The screen shots shown in these instructions may differ slightly from those of the actual product.
- Software features and appearance are subject to change without notice.

Installing the “Telephone Plug-in”

Before installing “Telephone Plug-in”, make sure of the following:

- Microsoft Office Outlook is installed on your computer.
- The base unit is not connected to your computer with the mini USB cable (until instructed to do so).

- 1 Start Windows and exit all other applications.
 - You must be logged in as an administrator in order to install “Telephone Plug-in”.
- 2 Insert the included CD-ROM into your CD-ROM drive.
 - Installation starts automatically. If the installation does not start, see page 50.
 - **For Microsoft Windows Vista and Microsoft Windows 7 users:**
Click **[Run Setup.exe]** when prompted.
- 3 When the language selection window is displayed, select the desired language and click **[Next]**.
- 4 When the “Telephone Plug-in” window is displayed, click **[Next]**.
- 5 Read the license agreement carefully. If you accept the terms of the license agreement, check the box and click **[Next]**.

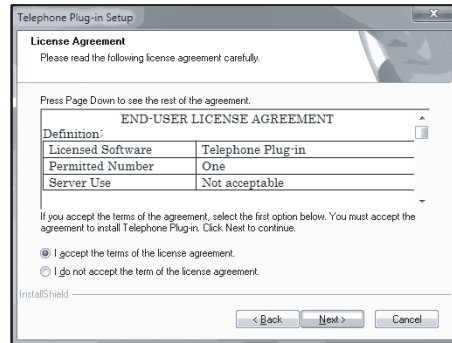

- 6 When the “Telephone Plug-in” install shield wizard is displayed, click **[Install]**.
- 7 When installation is finished, click **[Finish]** to complete the installation. Then remove the CD-ROM from your CD-ROM drive.

“Telephone Plug-in” for Microsoft Office Outlook

Uninstalling the “Telephone Plug-in”

- 1 Exit all applications and disconnect the mini USB cable from your computer.
- 2 To uninstall “Telephone Plug-in”, perform the following procedure:
From the Start menu:
Point to **[All Programs]** → **[Panasonic]** → **[Telephone Plug-in]**, and click **[Uninstall]**.
- 3 When the uninstall confirmation window is displayed, click **[Yes]** to start uninstallation.
- 4 When uninstallation is finished, click **[Finish]** to exit the uninstallation.

Connecting a computer to the base unit with mini USB cable

“Telephone Plug-in” must be installed before connecting the base unit to your computer.

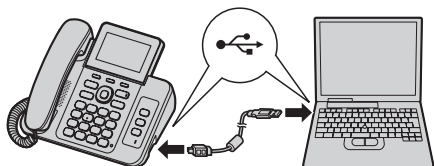

Making a call from “Telephone Plug-in”

When “Telephone Plug-in” is installed correctly, a toolbar appears in the Microsoft Office Outlook display. You can make calls from the base unit speakerphone using the toolbar.

Making a call from the Microsoft Outlook contact list

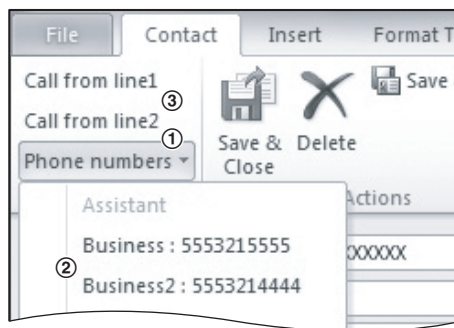

Microsoft Office Outlook 2010 users

- 1 Find and double click the desired contact.
- 2 Click **[Phone numbers ▼]**. ----(1)
- 3 Click the phone number you want to call. ----(2)
- 4 Click **[Call from line1]** or **[Call from line2]** to select the desired line. ----(3)
 - The base unit automatically dials the number with the speakerphone.

Microsoft Office Outlook 2003/2007 users

- 1 Find and double click the desired contact.
- 2 Click **[Call from line1]** or **[Call from line2]** to select the desired line. ----(3)
- 3 Click **[Phone numbers ▼]**. ----(1)
- 4 Click the phone number you want to call. ----(2)
 - The base unit automatically dials the number with the speakerphone.

“Telephone Plug-in” for Microsoft Office Outlook

Making a call from the caller list

The last 10 caller information is stored in the caller list.

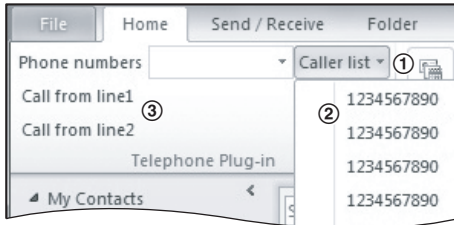

Microsoft Office Outlook 2010 users

- 1 Click **[Caller list ▼]**. ----(①)
- 2 Click the phone number you want to call. ----(②)
- 3 Click **[Call from line1]** or **[Call from line2]** to select the desired line. ----(③)

Microsoft Office Outlook 2003/2007 users

- 1 Click **[Call from line1]** or **[Call from line2]** to select the desired line. ----(③)
- 2 Click **[Caller list ▼]**. ----(①)
- 3 Click the phone number you want to call. ----(②)

Making a call by entering a phone number in the toolbar

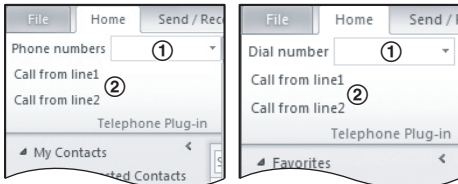

Microsoft Office Outlook 2010 users

- 1 Enter the phone number in the toolbar. ----(①)
 - Only the following keys are accepted (max. 24 digits):
0 to 9, *, #, p (Pause), and f (Flash)
- 2 Click **[Call from line1]** or **[Call from line2]** to select the desired line. ----(②)

Microsoft Office Outlook 2003/2007 users

- 1 Click **[Call from line1]** or **[Call from line2]** to select the desired line. ----(②)
- 2 Enter the phone number in the toolbar. ----(①)
 - Only the following keys are accepted (max. 24 digits):
0 to 9, *, #, p (Pause), and f (Flash)
- 3 Press the Enter key on your computer to dial the number.

Making a call from the redial list

When you are using functions other than the **contact list**, you can make a call from the redial list. Confirm **[Dial number]** is displayed in the toolbar. The last 10 phone numbers dialed are stored in the redial list (each 24 digits max.).

Microsoft Office Outlook 2010 users

- 1 Click **[▼]** displayed to the right of **[Dial number]**.
- 2 Click the phone number you want to call.
- 3 Click **[Call from line1]** or **[Call from line2]** to select the desired line.

Microsoft Office Outlook 2003/2007 users

- 1 Click **[Call from line1]** or **[Call from line2]** to select the desired line.
- 2 Click **[▼]** displayed to the right of **[Dial number]**.
- 3 Click the phone number you want to call.

Hanging up a call

When you finish a call, press **[⏏]** on the base unit or **[Disconnect line1]** or **[Disconnect line2]** in the toolbar.

“Telephone Plug-in” pop-up window for incoming call

When a call is received, “Telephone Plug-in” displays a pop-up window (Microsoft Office Outlook contact list) on your computer display to let you know there is an incoming call.

- If the caller’s phone number does not match a contact in the Microsoft Office Outlook contact list, a new contact window is displayed with the Caller ID information for the caller (if the Caller ID information contains the name and phone number). You can edit the contact information in the window and store it as a new contact.
- To call back the caller displayed on the pop-up window, click **[Call from line1]** or **[Call from line2]** to select the desired line.

Important:

- To use “Telephone Plug-in” features, you must subscribe to a Caller ID service. Contact your service provider/telephone company for details.

“Telephone Plug-in” toolbar settings

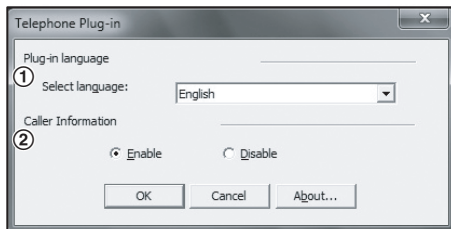

- 1 Click **[Options]** in the toolbar.
- 2 Change the following settings as necessary.
 - **Plug-in language** ----(①)
You can select “English”, “Français”, or “Español”.
 - **Caller Information** ----(②)
You can select whether the pop-up window is displayed or not.
“Enable” (default): Displays a Microsoft Office Outlook contact window.
“Disable”: Does not display a pop-up window.
- 3 Click **[OK]** to complete the changes.

Phonebook

Base unit/handset phonebook

The phonebook allows you to make calls without having to dial manually. You can add names and phone numbers to the base unit and handset phonebook independently, and assign each phonebook entry to the desired group.

- Base unit: up to 100 entries
- Handset: up to 100 entries

Important:

- Call Display subscribers can use group ringer tone features (page 33).

Adding entries

Base unit / Handset

- Proceed with the operation for your unit.
Base unit: [📖]
Handset: [MENU][#][2][8][0]
- [ADD]
- Enter the party's name (16 characters max.).
→ [OK]
- Enter the party's phone number (24 digits max.). → [OK]
- [↕]: Select the desired group. → [SELECT]
2 times
 - To add other entries, repeat from step 3.
- Proceed with the operation for your unit.
Base unit: [■] (EXIT)
Handset: [OFF]

Character table for entering names

While entering characters, you can switch between uppercase and lowercase by pressing [X] (A→a).

Key	Character
[1]	_ # & ' () * , - . / 1
[2]	A B C 2 a b c 2
[3]	D E F 3 d e f 3
[4]	G H I 4 g h i 4

Key	Character
[5]	J K L 5 j k l 5
[6]	M N O 6 m n o 6
[7]	P Q R S 7 p q r s 7
[8]	T U V 8 t u v 8
[9]	W X Y Z 9 w x y z 9
[0]	_ 0

- To enter another character that is located on the same dial key:
Base unit: Press [▶▶] to move the cursor to the next space.
Handset: Press [▶] to move the cursor to the next space.
- _ in the above table represents a single space.

Erasing the character or number

Base unit: Press [◀◀] or [▶▶]. → [CLEAR]

Handset: Press [◀] or [▶]. → [CLEAR]

- Press and hold [CLEAR] to erase all characters or numbers.

Groups

Groups can help you find entries in the phonebook quickly and easily. When adding an entry to the phonebook, you can assign it to one of 9 groups. You can change the names of groups assigned for phonebook entries ("Friends", "Family", etc.) and then search for phonebook entries by group. The group ringer tone feature is available for Call Display subscribers (page 33).

Changing group names

The default group name is "Group 1" to "Group 9".

Base unit / Handset

- Proceed with the operation for your unit.
Base unit: [📖]
Handset: [MENU][#][2][8][0]
- [MENU]
- [↕]: "Group" → [SELECT]

- 4 [↕]: Select the desired group. → [SELECT]
- 5 [↕]: "Group name" → [SELECT]
- 6 Edit the name (10 characters max.; page 24). → [SAVE]
- 7 Proceed with the operation for your unit.
Base unit: [■] (EXIT)
Handset: [OFF]

Finding and calling from a phonebook entry

Base unit / Handset

Once you have found the desired entry using one of the following 3 methods, make a call with your unit.

Base unit: Lift the corded handset.

- You can also make a call by pressing [LINE 1] or [LINE 2], then lifting the corded handset.

Handset: [↶]

- You can also make a call by pressing [CALL], then pressing [LINE 1] or [LINE 2].

Scrolling through all entries

- 1 Proceed with the operation for your unit.
Base unit: [📖]
Handset: [MENU]#|2|8|0
- 2 [↕]: Select the desired entry.

Searching by first character

- 1 Proceed with the operation for your unit.
Base unit: [📖]
Handset: [MENU]#|2|8|0
- 2 Press the dial key ([0] – [9]) which contains the character you are searching for (page 24).
 - Press the same dial key repeatedly to display the first entry corresponding to each character located on that dial key.
 - If there is no entry corresponding to the character you selected, the next entry is displayed.
- 3 [↕]: Scroll through the phonebook if necessary.

Searching by group

- 1 Proceed with the operation for your unit.
Base unit: [📖]
Handset: [MENU]#|2|8|0
- 2 [GROUP]

- 3 [↕]: Select the group you want to search. → [SELECT]
 - If you select "All groups", the unit ends the group search.
- 4 [↕]: Select the desired entry.

Editing entries

Base unit / Handset

- 1 Find the desired entry (page 25). → [MENU]
- 2 [↕]: "Edit" → [SELECT]
- 3 Edit the name if necessary (16 characters max.; page 24). → [OK]
- 4 Edit the phone number if necessary (24 digits max.). → [OK]
- 5 [↕]: Select the desired group (page 24). → [SELECT] 2 times
- 6 Proceed with the operation for your unit.
Base unit: [■] (EXIT)
Handset: [OFF]

Erasing entries

Base unit / Handset

Erasing an entry

- 1 Find the desired entry (page 25). → [MENU]
- 2 [↕]: "Erase" → [SELECT]
- 3 [↕]: "Yes" → [SELECT]
- 4 Proceed with the operation for your unit.
Base unit: [■] (EXIT)
Handset: [OFF]

Erasing all entries



- 1 Proceed with the operation for your unit.
Base unit: [📖]
Handset: [MENU]#|2|8|0
- 2 [MENU]
- 3 [↕]: "Erase all" → [SELECT]
- 4 [↕]: "Yes" → [SELECT]
- 5 [↕]: "Yes" → [SELECT]
- 6 Proceed with the operation for your unit.
Base unit: [■] (EXIT)
Handset: [OFF]

Phonebook



Chain dial

This feature allows you to dial phone numbers in the phonebook while you are on a call. This feature can be used, for example, to dial a calling card access number or bank account PIN that you have stored in the phonebook, without having to dial manually.

Base unit / Handset

- 1 Proceed with the operation for your unit.
During an outside call:
Base unit: [**]**
Handset: [**MENU**] → []: “Phonebook” → [**SELECT**]
- 2 []: Select the desired entry.
- 3 Press [**CALL**] to dial the number.

Note:

- When storing a calling card access number and your PIN in the phonebook as one phonebook entry, press [**PAUSE**] to add pauses after the number and PIN as necessary (page 16).
- If you have rotary/pulse service, you need to press [] (TONE) before pressing [] on the base unit or [**MENU**] on the handset in step 1 to change the dialing mode temporarily to tone. When adding entries to the phonebook, we recommend adding [] (TONE) to the beginning of phone numbers you wish to chain dial (page 24).

Copying phonebook entries



You can copy phonebook entries from the base unit to a handset or vice versa.

Important:

- Group ringer tones are not copied.
- You cannot copy the phonebook entries between handsets.

Copying an entry







Base unit

- 1 [**]**
- 2 []: Select the desired entry. → [**MENU**]
- 3 []: “Copy” → [**SELECT**]

- 4 Enter the handset number to copy to.
 - When an entry has been copied, “Completed” is displayed.
 - To continue copying another entry:
[]: “Yes” → [**SELECT**] → Find the desired entry (page 25). → [**SEND**]



- 5 [] (EXIT)

Handset





- 1 [**MENU**][**]**[**]**[**]**[**]**
- 2 []: Select the desired entry. → [**MENU**]
- 3 []: “Copy to base” → [**SELECT**]
 - When an entry has been copied, “Completed” is displayed.
 - To continue copying another entry:
[]: “Yes” → [**SELECT**] → Find the desired entry (page 25). → [**SEND**]
- 4 [**OFF**]

Copying all entries

Base unit

- 1 [**]** → [**MENU**]
- 2 []: “Copy all” → [**SELECT**]
- 3 Enter the handset number to copy to.
 - When all entries have been copied, “Completed” is displayed.
- 4 [] (EXIT)

Handset

- 1 [**MENU**][**]**[**]**[**]**[**]** → [**MENU**]
- 2 []: “Copy all to base” → [**SELECT**]
 - When all entries have been copied, “Completed” is displayed.
- 3 [**OFF**]

Programmable settings

You can customize the unit by programming the following features.
To access the features, there are 2 methods.

Base unit / Handset





■ Scrolling through the display menus

- 1 **[MENU]**
- 2 Proceed with the operation for your unit.
Base unit: Press **[▲]**, **[▼]**, **[◀]**, or **[▶]** to select the desired main menu. → **[SELECT]**
Handset: Press **[▲]**, **[▼]**, **[◀]**, or **[▶]** to select the desired main menu. → **[SELECT]**
- 3 Press **[▼]** or **[▲]** to select the desired item from the next sub-menus. → **[SELECT]**
- 4 Press **[▼]** or **[▲]** to select the desired setting. → **[SAVE]**
 - This step may vary depending on the feature being programmed.
 - To exit the operation, press **[■]** (EXIT) on the base unit or **[OFF]** on the handset.

■ Using the direct command code



- 1 **[MENU]** → Enter the desired code.
Example: Press **[MENU][#][1][1][0]**.
- 2 Select the desired setting. → **[SAVE]**
 - This step may vary depending on the feature being programmed.
 - To exit the operation, press **[■]** (EXIT) on the base unit or **[OFF]** on the handset.

Note:

- The unit column shows the unit(s) that can be used to program the item.
 - : Only the base unit can program the item.
 - : Only the handset can program the item.
 - : Both the base unit and handset can program the item.
- In the following table, < > indicates the default settings.
- In the following table,  indicates the reference page number.

Display the menu tree and direct command code table



Main menu:  "View Caller ID"

Operation	Code	Unit	
Viewing the caller list.	#213		33

Main menu:  "Phonebook"

Operation	Code	Unit	
Viewing and erasing the phonebook entry.	#280		25

(Base unit) Main menu:  "Set answering"

Sub-menu 1	Sub-menu 2	Settings	Code	Unit	
Record greeting	Line1&Line2	–	#302		36
	Line1	–			
	Line2	–			

Programming

Sub-menu 1	Sub-menu 2	Settings	Code	Unit	👉
Play greeting	Line1&Line2	–	#303		37
	Line1	–			
	Line2	–			
Ring count* ¹	–	Toll saver 2-7 rings <4 rings>	#211		40
Recording time* ¹	–	1 min 2 min <3 min>	#305		41
Remote code* ¹	–	<111>	#306		39
Call screening	–	<On> Off	#310		36



(Handset) Main menu: “Answering device”

Sub-menu 1	Sub-menu 2	Settings	Code	Unit	👉
Play new msg. (msg.: message)	–	–	#323		38
Play all msg.	–	–	#324		38
Erase all* ¹	–	–	#325		38
Settings	Ring count* ¹	Toll saver 2-7 rings <4 rings>	#211		40
	Recording time* ¹	1 min 2 min <3 min>	#305		41
	Remote code* ¹	<111>	#306		39
	Call screening	<On> Off	#310		36













Main menu: “Ringer settings”

Sub-menu 1	Sub-menu 2	Settings	Code	Unit	👉
Ringer volume* ²	Line1	Base unit: Level 1-3 <3> Off Handset: Level 1-6 <6> Off	#160		17
	Line2				
Ringer tone* ^{3, *4, *5}	Line1	Line1: <Tone 1> Line2: <Tone 2> Base unit: Tone 1-3 Melody 1-3 Handset: Tone 1-5 Melody 1-10	#161		–
	Line2				







Programming

Sub-menu 1	Sub-menu 2	Settings	Code	Unit	👉
Interrupt tone*6	-	<On> Off	#201		19, 43
Night mode	Start/End	<11:00 PM/06:00 AM>	#237		31
	On/Off	On <Off>	#238		31



Main menu: ☰☰ “Initial settings”

Sub-menu 1	Sub-menu 2	Settings	Code	Unit	👉
Set date & time	Date and time*1	-	#101		14
	Alarm	<Off> Once Daily	#720		31
	Time adjustment*1,*7	<Caller ID[auto]> Manual	#226		-
Contrast (Display contrast)	-	Level 1-6 <3>	#145		-
Key tone*8	-	<On> Off	#165		-
Auto talk*9	-	On <Off>	#200		17
Line select	-	<Auto> Line1 Line2	#250		15
Set tel line	Set dial mode*1	<Tone> Pulse	#120		15
	Set flash time*1,*10 - Line1 - Line2	80 ms 90 ms 100 ms 110 ms 160 ms 200 ms 250 ms 300 ms 400 ms 600 ms <700 ms> 900 ms	#121		18
	Set line mode*1,*11 - Line1 - Line2	A 	#122		-
	VM tone detect*1 (VM: Voice Mail)	<On> Off	#332		42
Privacy	-	On <Off>	#194		18

Programming

Sub-menu 1	Sub-menu 2	Settings	Code	Unit	
Registration	HS registration (HS: Handset)	–	#130		32
	Deregistration	–	#131		32
Change language	Display language	<English> Français	#110	 	15
	Voice prompt*1	<English> Français	#112	 	15

Main menu:  "Customer support"*12

Operation	Code	Unit	
Displaying customer support Web address.	#680	 	–

- *1 If you program these settings using one of the handsets, you do not need to program the same item using another handset.
- *2 Ringer volume cannot be turned off for alarm, intercom calls, and paging.
- *3 If you subscribe to a distinctive ring service, select a tone (base unit: tone 1 to 3/handset: tone 1 to 5). If you select a melody, you cannot distinguish lines by their ringers.
- *4 If you select one of the melody ringer tones, the ringer tone continues to play for several seconds even if the caller has already hung up. You may either hear a dial tone or no one on the line when you answer the call.
- *5 The preset melodies in this product are used with permission of © 2007 Copyrights Vision Inc.
- *6 This tone lets you know when you receive an outside call while you are on the other line or an intercom call. If you select "On", the tone sounds 2 times.
- *7 This feature allows the unit to automatically adjust the date and time each time caller information including date and time is received.
To turn this feature on, select "Caller ID[auto]". To turn this feature off, select "Manual". (Call Display subscribers only)
To use this feature, set the date and time first (page 14).
- *8 Turn this feature off if you prefer not to hear key tones while you are dialing or pressing any keys, including confirmation tones and error tones.
- *9 If you subscribe to a Call Display service and want to view the caller's information after lifting up the handset to answer a call, turn off this feature.
- *10 The flash time depends on your telephone exchange or host PBX. Contact your PBX supplier if necessary.
- *11 Generally, the line mode setting should not be changed. If the LINE 1 indicator or LINE 2 indicator does not light when another phone connected to the same line is in use, you need to change the line mode to "A".
- *12 The base unit and handset can display the Internet address where you can download the operating instructions or get further information for this product, using your computer.

Special programming

Night mode

Night mode allows you to select a period of time during which the unit will not ring for outside calls. This feature is useful for time periods when you do not want to be disturbed, for example, while sleeping. Night mode can be set independently for each base unit and handset.

Important:

- Set the date and time beforehand (page 14).
- If you have set the alarm, the alarm sounds even if the night mode is turned on.

Setting the start and end time

Base unit / Handset

- 1 **[MENU]** **[#]** **[2]** **[3]** **[7]**
- 2 Enter the desired hour and minute you wish to start this feature.
- 3 **[X]**: Select “AM” or “PM”. → **[OK]**
- 4 Enter the desired hour and minute you wish to end this feature.
- 5 **[X]**: Select “AM” or “PM”. → **[OK]**
- 6 Proceed with the operation for your unit.
Base unit: **[■]** (EXIT)
Handset: **[OFF]**

Turning night mode on/off

Base unit / Handset

- 1 **[MENU]** **[#]** **[2]** **[3]** **[8]**
- 2 **[↕]**: Select the desired setting. → **[SAVE]**
- 3 Proceed with the operation for your unit.
Base unit: **[■]** (EXIT)
Handset: **[OFF]**
 - When the night mode is set,  is displayed.

Alarm

An alarm sounds at the set time for 3 minutes once or daily. Alarm can be set for each handset.

Important:

- Set the date and time beforehand (page 14).

Handset

- 1 **[MENU]** **[#]** **[7]** **[2]** **[0]**
- 2 **[↕]**: Select the desired alarm option. → **[SELECT]**

Off	Turns alarm off. Go to step 7.
Once	An alarm sounds once at the set time.
Daily	An alarm sounds daily at the set time. Go to step 4.

- 3 Enter the desired month and date.
- 4 Set the desired time.
- 5 **[X]**: Select “AM” or “PM”. → **[OK]**
- 6 **[↕]**: Select the desired alarm tone. → **[SELECT]**
 - We recommend selecting a different ringer tone from the one used for outside calls.
- 7 **[SELECT]** → **[OFF]**
 - When the alarm is set,  is displayed.

Note:

- To stop the alarm, press **[OFF]** or place the handset on the charger.
- When the handset is in use, the alarm will not sound until the handset is in standby mode.
- When the ringer volume for outside calls of the 2 lines is set to off (page 28), the alarm sound is heard at a low level.

Programming

Registering a unit

Operating additional units

Additional handsets

Up to 6 handsets can be registered to the base unit.

Important:

- See page 4 for information on the available model.

Registering a handset to the base unit

The supplied handset and base unit are pre-registered. If for some reason the handset is not registered to the base unit, re-register the handset.

1 Handset:

[MENU][#][1][3][0]

2 Base unit:

Press and hold **[LOCATOR]** for about 5 seconds until the registration tone sounds.

- If all registered handsets start ringing, press **[LOCATOR]** again to stop, then repeat this step.
- The next step must be completed within 90 seconds.

3 Handset:

Press **[OK]**, then wait until a long beep sounds.

Note:

- When you purchase an additional handset, refer to the additional handset's installation manual for registration.

Deregistering a handset

A handset can cancel its own registration to the base unit, or other handsets registered to the same base unit. This allows the handset to end its wireless connection with the system.

1 [MENU][#][1][3][1]

2 [3][3][5] → [OK]

- All handsets registered to the base unit are displayed.

3 Select the handset you want to cancel by pressing the desired handset(s) number.

- The selected handset number(s) flashes.

- To cancel a selected handset number, press the number again. The number will stop flashing.

4 [OK] → [↕]: "Yes" → [SELECT]

- When you cancel a different handset than the one you are now using, press **[OFF]** to exit.

Using Call Display service

Important:

- This unit is Call Display compatible. To use Call Display features, you must subscribe to a Call Display service. Contact your service provider/ telephone company for details.

Call Display features

Base unit / Handset

When an outside call is being received, the caller's name and phone number are displayed.

Caller information for the last 50 callers is logged in the caller list from the most recent call to the oldest.

- If the unit cannot receive caller information, the following is displayed:
 - “**Unavailable Name & No.**”: The caller dials from an area which does not provide a Call Display service.
 - “**Private caller**”: The caller requests not to send caller information.
 - “**Long distance**”: The caller makes a long distance call.
- If the unit is connected to a PBX system, caller information may not be properly received. Contact your PBX supplier.

Missed calls

Base unit / Handset

If a call is not answered, the unit treats it as a missed call. The display shows “**Missed call**”. This lets you know if you should view the caller list to see who called while you were away.

Phonebook name display

When caller information is received and it matches a phone number stored in the phonebook, the stored name in the phonebook is displayed and logged in the caller list.

Ringer ID

This feature can help you identify who is calling by using different ringer tones for different groups of callers. When adding an entry to the phonebook, you can assign it to the desired group (page 24). When a call is received from a caller assigned to a group, the ringer you selected for that group rings

after caller information is displayed. If you select “**No ringer ID**” (default), the unit uses the ringer tone you selected on page 28 when calls from this group are received.

Base unit / Handset

- 1 Proceed with the operation for your unit.
Base unit: [📖]
Handset: [MENU]# [2] [8] [0]
- 2 [MENU]
- 3 [↕]: “Group” → [SELECT]
- 4 [↕]: Select the desired group. → [SELECT]
- 5 [↕]: Select the current setting of the ringer ID. → [SELECT]
- 6 [↕]: Select the desired ringer tone. → [SAVE]
- 7 Proceed with the operation for your unit.
Base unit: [■] (EXIT)
Handset: [OFF]

Caller list

Important:

- Only 1 person can access the caller list at a time.
- Make sure the unit's date and time setting is correct (page 14).

Viewing the caller list and calling back

Base unit / Handset

- 1 Proceed with the operation for your unit.
Base unit: [CID]
Handset: [MENU]# [2] [1] [3]
- 2 Press [▼] to search from the most recent call, or [▲] to search from the oldest call.
- 3 Proceed with the operation for your unit.
Base unit:
 - To call back, lift the corded handset.
 - To exit, press [■] (EXIT).**Handset:**
 - To call back, press [↩].
 - To exit, press [OFF].

Note:

- In step 2;
 - [1] and [2] indicate which line the caller information was received from.

Call Display Service

- If the entry has already been viewed or answered, “✓” is displayed, even if it was viewed or answered using another unit.
- In step 2, if ▶ is displayed, not all of the information is shown. To see the remaining information:
Base unit:
Press [▶▶]. To return to the previous screen, press [◀◀].
Handset:
Press [▶]. To return to the previous screen, press [◀].
- In step 3, the unit automatically uses the line you set in line selection mode (page 15) to call back. When the line selection mode is set to “Auto”, the indicated line (L1 or L2) is used for the call. If the indicated line is already being used or you want to select the other line:
Base unit: Press [LINE 1] or [LINE 2], then lift the corded handset.
Handset: Press [CALL], then press [LINE 1] or [LINE 2].

Editing a caller's phone number before calling back

You can edit a phone number in the caller list by adding the long distance code “1” or removing its area code.

Base unit / Handset

- 1 Proceed with the operation for your unit.
Base unit: [CID]
Handset: [MENU]# [2] [1] [3]
- 2 Proceed with the operation for your unit.
Base unit: [↕]: Select the desired entry.
Handset: [↕]: Select the desired entry. → [CALL]
- 3 Press [EDIT] repeatedly until the phone number is shown in the desired format.
 - ① 1 – Area code – Local phone number
Example: 1-555-321-5555
 - ② Local phone number
Example: 321-5555
 - ③ Area code – Local phone number
Example: 555-321-5555
- 4 Proceed with the operation for your unit.
Base unit: Lift the corded handset.
Handset: [↵]

- If the indicated line is already being used or you want to select the other line:
Base unit: Press [LINE 1] or [LINE 2], then lift the corded handset.
Handset: Press [LINE 1] or [LINE 2].

Note:

- The number edited in step 3 will not be saved in the caller list.

Erasing selected caller information

Base unit / Handset

- 1 Proceed with the operation for your unit.
Base unit: [CID]
Handset: [MENU]# [2] [1] [3]
- 2 [↕]: Select the desired entry.
- 3 [ERASE] (soft key) → [↕]: “Yes” → [SELECT]
- 4 Proceed with the operation for your unit.
Base unit: [■] (EXIT)
Handset: [OFF]

Erasing all caller information

Base unit / Handset

- 1 Proceed with the operation for your unit.
Base unit: [CID]
Handset: [MENU]# [2] [1] [3]
- 2 [ERASE] (soft key) → [↕]: “Yes” → [SELECT]
- 3 Proceed with the operation for your unit.
Base unit: [■] (EXIT)
Handset: [OFF]

Storing caller information to the phonebook

Base unit / Handset

- 1 Proceed with the operation for your unit.
Base unit: [CID]
Handset: [MENU]# [2] [1] [3]
- 2 Proceed with the operation for your unit.
Base unit: [↕]: Select the desired entry.
Handset: [↕]: Select the desired entry. → [SAVE]
 - To edit the number, press [EDIT] repeatedly until the phone number is shown in the desired format.

Call Display Service

- 3 [SAVE]**
- 4** Edit the name if necessary (16 characters max.; page 24). → **[OK]**
- 5** Edit the phone number if necessary (24 digits max.). → **[OK]**
- 6** **[↕]**: Select the desired group (page 24). → **[SELECT]** 2 times
- 7** Proceed with the operation for your unit.
Base unit: **[■]** (EXIT)
Handset: **[OFF]**

Answering System

Answering system

The answering system can answer and record calls for you when you are unavailable to answer the phone.

Important:

- Only 1 person can access the answering system (listen to messages, record a greeting message, etc.) at a time.
- When callers leave messages, the unit records the day and time of each message. Make sure the date and time have been set correctly (page 14).

Memory capacity (including your greeting message)

The total recording capacity is about 38 minutes. A maximum of 64 messages can be recorded.

Note:

- When message memory becomes full:
 - “**Messages full**” is shown on the base unit and handset display.
 - The ANSWER ON/OFF indicator on the base unit flashes rapidly if the answering system is turned on.
 - If you use the pre-recorded greeting message, the unit automatically switches to another pre-recorded greeting message asking callers to call again later.
 - If you recorded your own greeting message, the same message is still announced to callers even though their messages are not recorded.

Turning the answering system on/off

Base unit

- **To turn on:**
Press **[ANSWER SELECT]** repeatedly to select the desired line(s). → **[ANSWER ON/OFF]**
- **To turn off:**
Press **[ANSWER ON/OFF]**.

Note:

- When the answering system is turned on, the ANSWER ON/OFF indicator on the base unit lights up.

Call screening

Base unit / Handset

While a caller is leaving a message, you can listen to the call through the unit's speaker. To adjust the speaker volume, press **[▲]** or **[▼]** repeatedly. You can answer the call by lifting the corded handset from the base unit or pressing **[📞]** on the handset.

Call screening can be set for each unit. The default setting is “On”.

- 1 **[MENU]#310**
- 2 **[↕]**: Select the desired setting. → **[SAVE]**
- 3 Proceed with the operation for your unit.
Base unit: **[■]** (EXIT)
Handset: **[OFF]**

Greeting message

When the unit answers a call, a greeting message is played to callers.

You can use either:

- your own greeting message
- a pre-recorded greeting message

Recording your greeting message

Greeting messages can be recorded in one of the two following ways:

- for line 1 and line 2 with different greetings (2 minutes max. for each greeting)
- for line 1 and line 2 with the same greeting (2 minutes max.). Select “**Line1&Line2**” in step 2.

Base unit

- 1 **[MENU]#302**
- 2 **[↕]**: Select the desired line(s). → **[SELECT]**
- 3 After a beep sounds, hold the handset about 20 cm (8 inches) away and speak clearly into the microphone (2 minutes max.).
- 4 Press **[STOP]** to stop recording.
- 5 **[■]** (EXIT)

Using a pre-recorded greeting message

If you erase or do not record your own greeting message, the unit plays a pre-recorded greeting asking callers to leave a message.

Resetting to a pre-recorded greeting message

If you want to use a pre-recorded greeting message once you record your own greeting message, you need to erase your own greeting message.

Base unit

- 1 [MENU]#303
- 2 [↕]: Select the desired line(s). → [SELECT]
- 3 Press [ERASE] while your greeting message is playing.
- 4 [■] (EXIT)

Playing back the greeting message

Base unit

- 1 [MENU]#303
- 2 [↕]: Select the desired line(s). → [SELECT]
- 3 [■] (EXIT)

Listening to messages using the base unit

When new messages have been recorded:

- [▶] on the base unit flashes.
- "New message" is displayed.

Press [▶].

- If new messages have been recorded, the base unit plays back new messages.
- If there are no new messages, the base unit plays back all messages.

Playing back messages for the desired line(s)

Press [ANSWER SELECT] repeatedly to select the desired line(s), then press [▶].

Operating the answering system during playback

Key	Operation
[▲] or [▼]	Adjust the speaker volume
[◀◀]	Repeat message*1
[▶▶]	Skip message
[PAUSE]	Pause message To resume playback, press [▶].
[■] (STOP)	Stop playback
[ERASE]	Erase currently playing message

*1 If pressed within the first 5 seconds of a message, the previous message is played.

Calling back (Call Display subscribers only)

If caller information was received for the call, you can call the caller back while listening to a message.

- 1 Press [EDIT] during playback.
 - To edit the number before calling back, press [EDIT] repeatedly until the phone number is shown in the desired format (page 34).
- 2 Lift the corded handset.
 - The unit automatically uses the line you set in line selection mode (page 15) to call back. When the line selection mode is set to "Auto", the indicated line (L1 or L2) is used for the call. If the indicated line is already being used or you want to select the other line, press [LINE 1] or [LINE 2], then lift the corded handset.

Erasing all messages

Erasing all messages for both line 1 and line 2

- 1 [ERASE]
 - LINE1 and LINE2 are displayed.
- 2 Press [ERASE] again.

Erasing all messages for the desired line(s)

Press [ANSWER SELECT] repeatedly to select the desired line(s), then press [ERASE] 2 times.

Answering System

Listening to messages using the handset

When new messages have been recorded, “New message” is displayed.

1 To listen to new messages:

[MENU]#[3]2[3]

To listen to all messages:

[MENU]#[3]2[4]

2 When finished, press **[OFF]**.

Note:

- To switch to the receiver, press **[↶]**.

Playing back messages for the desired line(s)

1 **[MENU]** → **[↕]**: “Answering device” → **[SELECT]**

2 Press **[☺]** repeatedly to select the desired line(s).

3 **[↕]**: “Play new msg.” or “Play all msg.” → **[SELECT]**

4 When finished, press **[OFF]**.

Operating the answering system

[MENU] → **[↕]**: “Answering device” → **[SELECT]** → Press **[☺]** repeatedly to select the desired line(s) if necessary.

Key	Operation
[▲] or [▼]	Adjust the receiver/speaker volume (during playback)
[1] or [◀]	Repeat message (during playback)*1
[2] or [▶]	Skip message (during playback)
[3]	Enter the “Settings” menu
[4]	Play new messages
[5]	Play all messages
[PAUSE]	Pause message*2
[9] or [STOP]	Stop playback
[0]	Turn answering system off
[*]4	Erase currently playing message
[*]5	Erase all messages
#[1]→[8]*3	Turn answering system on for line 1 only

Key	Operation
#[2]→[8]*3	Turn answering system on for line 2 only
#[0]→[8]*3	Turn answering system on for both line 1 and line 2

*1 If pressed within the first 5 seconds of a message, the previous message is played.

*2 To resume playback:

[↕]: “Playback” → **[SELECT]**

*3 For English voice guidance only:

When you press a line selection number (**#[1]**, **#[2]**, or **#[0]**), the selected line(s) is announced, then press **[8]**.

Calling back (Call Display subscribers only)

If caller information is received for the call, you can call the caller back while listening to a message.

1 Press **[MENU]** during playback.

2 **[↕]**: “Edit & Call” → **[SELECT]**

- To edit the number before calling back, press **[EDIT]** repeatedly until the phone number is shown in the desired format (page 34).

3 **[↶]**

- The unit automatically uses the line you set in line selection mode (page 15) to call back. When the line selection mode is set to “Auto”, the indicated line (**[L1]** or **[L2]**) is used for the call. If the indicated line is already being used or you want to select the other line, press **[LINE 1]** or **[LINE 2]**.

Erasing all messages

Erasing all messages for both line 1 and line 2

1 **[MENU]#[3]2[5]**

2 **[↕]**: “Yes” → **[SELECT]** → **[OFF]**

Erasing all messages for the desired line(s)

1 **[MENU]** → **[↕]**: “Answering device” → **[SELECT]**

2 Press **[☺]** repeatedly to select the desired line(s).

3 **[↕]**: “Erase all” → **[SELECT]**

4 **[↕]**: “Yes” → **[SELECT]** → **[OFF]**

Remote operation

Using a touch-tone phone, you can call your phone number from outside and access the unit to listen to messages or change answering system settings. The unit's voice guidance prompts you to press certain dial keys to perform different operations.

Remote access code

A 3-digit remote access code must be entered when operating the answering system remotely. This code prevents unauthorized parties from listening to your messages remotely. The default setting is "111".

Program this setting using either the base unit or one of the handsets.

Important:

- To prevent unauthorized access to this product, we recommend that you regularly change the remote code.

 Base unit /  Handset

- [MENU][#][3][0][6]**
- Enter the desired 3-digit remote access code.
→ **[SAVE]**
- Proceed with the operation for your unit.
Base unit: [■] (EXIT)
Handset: [OFF]

Using the answering system remotely

- Dial your phone number from a touch-tone phone.
- After the greeting message starts, enter your remote access code.
- Follow the voice guidance prompts as necessary or control the unit using remote commands (page 39).
- When finished, hang up.

Voice guidance

During remote operation, the unit's voice guidance starts and prompts you to press **[1]** to perform a specific operation, or press **[2]** to listen to more available operations.

Note:

- If you do not press any dial keys within 10 seconds after a voice guidance prompt, the unit disconnects your call.

Remote commands

You can press dial keys to access certain answering system functions without waiting for the voice guidance to prompt you.

- Select the desired line(s) while you are accessing the answering system if necessary.
For line 1: **[#][1]**
For line 2: **[#][2]**
For line 1 and line 2: **[#][0]**
- Press the desired dial keys.

Key	Operation
[1]	Repeat message (during playback)*1
[2]	Skip message (during playback)
[4]	Play new messages
[5]	Play all messages
[6]	Play greeting message
[#][1][7]	Record a greeting message for line 1 only
[#][2][7]	Record a greeting message for line 2 only
[#][0][7]	Record a common greeting message for both line 1 and line 2
[#][1][8]	Turn answering system on for line 1 only
[#][2][8]	Turn answering system on for line 2 only
[#][0][8]	Turn answering system on for both line 1 and line 2
[9]	Stop recording Stop playback
[0]	Turn answering system off
[*][4]	Erase currently playing message
[*][5]	Erase all messages
[*][6]	Erase greeting message (during greeting message playback)
[*][#]	End remote operation (or hang up)

*1 If pressed within the first 5 seconds of a message, the previous message is played.

Answering System

Turning on the answering system remotely

If the answering system is off, you can turn it on remotely.

Important:

- The answering system can be remotely turned on only for the line which you have currently selected in "Turning the answering system on/off", page 36.
- 1 Dial your phone number from a touch-tone phone.
 - 2 Let the phone ring 15 times.
 - A long beep is heard.
 - 3 Enter your remote access code within 10 seconds after the long beep.
 - The greeting message is played back.
 - You can either hang up, or enter your remote access code again and begin remote operation (page 39).

Note:

- If you want to turn on the answering system for the line which has not been selected in "Turning the answering system on/off", page 36, enter the desired remote commands, **[#][1][8]**, **[#][2][8]**, or **[#][0][8]**, (page 39) to turn on and access the other line.

Answering system settings

Number of rings before the unit answers a call

You can change the number of times the phone rings "**Ring count**" before the unit answers calls. You can select 2 to 7 rings, or "**To11 saver**".

The default setting is "**4 rings**".

"**To11 saver**": The unit's answering system answers at the end of the 2nd ring when new messages have been recorded, or at the end of the 4th ring when there are no new messages. If you call your phone from outside to listen to new messages (page 39), you know that there are no new messages when the phone rings for the 3rd time. You can then hang up without being charged for the call.

Program this setting using either the base unit or one of the handsets.

Base unit / Handset

- 1 **[MENU][#][2][1][1]**
- 2 **[↕]**: Select the desired setting. → **[SAVE]**
- 3 Proceed with the operation for your unit.
Base unit: [■] (EXIT)
Handset: [OFF]

For Voice Mail service subscribers

If you subscribe to a flat-rate service package that includes Call Display, Call Waiting, Voice Mail, and unlimited local/regional/long distance calls, please note the following:

- To use the Voice Mail service provided by your service provider/telephone company rather than the unit's answering system, turn off the answering system (page 36).
- To use this unit's answering system rather than the Voice Mail service provided by your service provider/telephone company, please contact your service provider/telephone company to deactivate your Voice Mail service.

If your service provider/telephone company cannot do this:

- Set this unit's "**Ring count**" setting so that this unit's answering system answers calls before the Voice Mail service of your service provider/telephone company does. It is necessary to check the number of rings

required to activate the Voice Mail service provided by your service provider/telephone company before changing this setting.

- Change the number of rings of the Voice Mail service so that the answering system can answer the call first. To do so, contact your service provider/telephone company.

Caller's recording time

You can change the maximum message recording time allowed for each caller. The default setting is "3 min".

Program this setting using either the base unit or one of the handsets.

Base unit / Handset

- 1 **[MENU]** **#** **3** **0** **5**
- 2 **[↕]**: Select the desired setting. → **[SAVE]**
- 3 Proceed with the operation for your unit.
Base unit: **[■]** (EXIT)
Handset: **[OFF]**

Voice Mail Service

Voice Mail service

Voice Mail is an automatic answering service offered by your service provider/telephone company. After you subscribe to this service, your service provider/telephone company's Voice Mail system answers calls for you when you are unavailable to answer the phone or when your line is busy. Messages are recorded by your service provider/telephone company, not your telephone. Please contact your service provider/telephone company for details of this service.

Important:

- To use the Voice Mail service provided by your service provider/telephone company rather than the unit's answering system, turn off the answering system (page 36). For details, see page 40.

Voice Mail message indication

The unit lets you know that you have new Voice Mail messages by showing "VoiceMail:Line1" and/or "VoiceMail:Line2" on the display. To listen to your Voice Mail messages, you must dial your service provider/telephone company's Voice Mail access number.

Note:

- If the base unit or handset still indicates there are new messages even after you have listened to all new messages, turn it off by pressing and holding **[OFF]** on the handset until a beep sounds.
- If your Voice Mail service uses Voice Mail tones and the message is over 3 minutes long, the unit may not indicate new messages.

Voice Mail (VM) tone detection

Base unit / Handset

Your service provider/telephone company sends special signals (sometimes called "Voice Mail tones" or "stutter tones") to the unit to let you know you have new Voice Mail messages. If you hear a series of dial tones followed by a continuous dial tone after you lift the corded handset or press **[↶]** on the handset, you have new Voice Mail messages. Soon after you hang up a call or after the phone stops ringing, your unit checks the

phone line to see if new Voice Mail messages have been recorded.

Turn this feature off when:

- You do not subscribe to Voice Mail service.
- Your service provider/telephone company does not send Voice Mail tones.
- Your phone is connected to a PBX.

If you are not sure which setting is required, contact your service provider/telephone company.

Turning VM tone detection on/off

The default setting is "On".

Program this setting using either the base unit or one of the handsets.

Base unit / Handset

- 1 **[MENU]** **#** **3** **3** **2**
- 2 **[↕]**: Select the desired setting. → **[SAVE]**
- 3 Proceed with the operation for your unit.
Base unit: **[■]** (EXIT)
Handset: **[OFF]**

Intercom

Intercom calls can be made:

- between the base unit and a handset
- between handsets

Note:

- If you receive an outside call while talking on the intercom, you hear an interrupt tone (page 29).
 - To answer the call with the base unit, place the corded handset on the cradle, then lift it again. If the speakerphone is used, press [☎] 2 times. You can also answer the call by pressing [LINE 1] or [LINE 2] after hanging up the intercom.
 - To answer the call with the handset, press [OFF], then press [☎].
- When paging unit(s), the paged unit(s) beeps for 1 minute.

Making an intercom call

Base unit

- 1 Press [INTERCOM].

When 2 or more handsets are registered:

 - To page a specific handset, enter the handset number.
 - To page all handsets, press [0] or wait for a few seconds.
 - Lift the corded handset if needed.
 - To stop paging, press [INTERCOM].
- 2 When you finish talking, press [INTERCOM] or place the corded handset on the cradle.

Handset

- 1 Press [INTERCOM].
- 2 To page the base unit, press [0].
To page another handset, enter its extension number.
 - To stop paging, press [OFF].
- 3 When you finish talking, press [OFF].

Answering an intercom call

Base unit

- 1 Lift the corded handset or press [INTERCOM] to answer the page.
- 2 When you finish talking, place the corded handset on the cradle or press [INTERCOM].

Handset

- 1 Press [☎] to answer the page.
- 2 When you finish talking, press [OFF].

Note for base unit and handset:

- The ringer volume for intercom calls follows the higher volume level of the 2 lines (page 28).

Handset locator

You can locate a misplaced handset by paging it.

- 1 **Base unit:** Press [LOCATOR].
 - All registered handsets beep for 1 minute.
- 2 To stop paging:
Base unit: Press [LOCATOR].
Handset: Press [☎], then press [OFF].

Transferring calls

Outside calls can be transferred between 2 people.

Base unit

- 1 During an outside call, press [INTERCOM].
When 2 or more handsets are registered:
 - To page a specific handset, enter the handset number.
 - To page all handsets, press [0] or wait for a few seconds.
- 2 Wait for the paged party to answer.
 - If paged party does not answer, press the flashing [LINE 1] or [LINE 2] to return to the outside call.
- 3 Place the corded handset on the cradle.
 - The outside call is being routed to the handset.

Handset

- 1 During an outside call, press [INTERCOM] to put the call on hold.
- 2 To page the base unit, press [0].
To page another handset, enter its extension number.
- 3 Wait for the paged party to answer.
 - If the paged party does not answer, press [LINE 1] or [LINE 2] that is flashing on the handset to return to the outside call.

Intercom/Locator

- 4 Press **[OFF]**.
 - The outside call is being routed to the destination unit.

Answering a transferred call

Base unit

Lift the corded handset or press **[📞]** to answer the page.

Handset

Press **[📞]** to answer the page.

Conference calls

3 people can establish a conference call.

Conference call with 2 outside calls

While you are talking with an outside caller, you can make or answer a 2nd call on the other line, and then combine the calls to establish a conference call.

Base unit

- 1 During an outside call, press **[HOLD]**.
- 2 To answer a 2nd call, press **[LINE 1]** or **[LINE 2]**.
To make a 2nd call, press **[LINE 1]** or **[LINE 2]**, then dial the phone number.
- 3 When the 2nd call is connected, press **[MENU]** → **[↕]**: “Conference” → **[SELECT]**
 - The 2 calls are combined.
 - To hang up only one line, press **[LINE 1]** or **[LINE 2]** for the party with which you want to continue talking.
 - To put both lines on hold, press **[HOLD]**.
To talk with only one caller, press **[LINE 1]** or **[LINE 2]** for the party with which you want to continue talking. To resume both lines, press **[CONF]**.

Handset

- 1 During an outside call, press **[HOLD]** 2 times.
- 2 To answer a 2nd call, press **[LINE 1]** or **[LINE 2]**.
To make a 2nd call, press **[LINE 1]** or **[LINE 2]**, then dial the phone number.

- 3 When the 2nd call is connected, press **[MENU]** → **[↕]**: “Conference” → **[SELECT]**
 - The 2 calls are combined.
 - To hang up only one line, press **[LINE 1]** or **[LINE 2]** for the party with which you want to continue talking.
 - To put both lines on hold, press **[HOLD]**.
To talk with only one caller, press **[LINE 1]** or **[LINE 2]** for the party with which you want to continue talking. To resume both lines, press **[CONF]**.

Conference call with an outside call and an intercom call

While you are talking with an outside caller, one more extension can join the conversation and establish a conference call.

Base unit

- 1 During an outside call, press **[INTERCOM]**.
When 2 or more handsets are registered:
 - To page a specific handset, enter the handset number.
 - To page all handsets, press **[0]** or wait for a few seconds.
- 2 When the paged party answers, press **[CONF]**.
 - The 2 calls are combined.
 - To leave the conference, place the corded handset on the cradle. The other 2 parties can continue the conversation.

Handset

- 1 During an outside call, press **[INTERCOM]** once to put the call on hold.
- 2 To page the base unit, press **[0]**.
To page another handset, enter its extension number.
- 3 When the paged party answers, press **[CONF]**.
 - The 2 calls are combined.
 - To leave the conference, press **[OFF]**. The other 2 parties can continue the conversation.

Note for the base unit and handset:

- The outside call can be put on hold by pressing **[HOLD]**. Only the person who placed the call on hold can resume the full conference by pressing **[CONF]**.

Wall mounting

The base unit can be mounted on a wall by changing the wall mounting adaptor's position.

Note:

- Make sure that the wall and the fixing method are strong enough to support the weight of the unit.

Base unit

- 1 To remove the wall mounting adaptor, push down the release levers (1). Remove the adaptor (2).

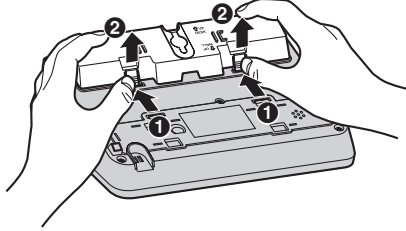

- 2 ① Turn the adaptor so that the words "UP WALL" are facing up.
② Tuck the telephone line cord inside the wall mounting adaptor.
③ Connect the AC adaptor cord and telephone line cord.

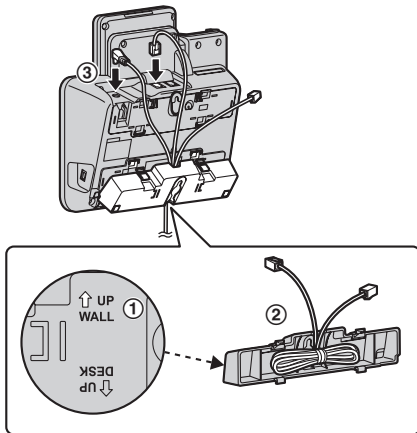

- 3 Insert the lower tabs of the adaptor into the unit's bottom slots (1), then insert by pushing down the levers of the adaptor into the upper slots (2).

- The words "UP WALL" should be facing up.

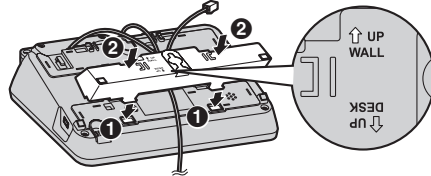

- 4 Mount the unit on a wall then slide down to secure in place.

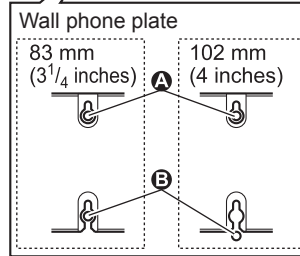
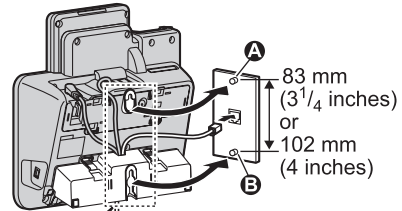

Charger

Drive the screws (not supplied) into the wall.

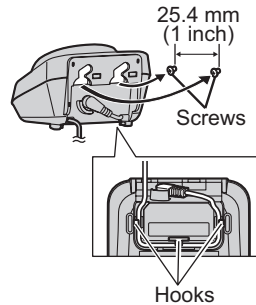

Useful Information

Error messages

Display message	Cause/solution
Busy	<ul style="list-style-type: none">• The called unit is in use.• Other units are in use and the system is busy. Try again later.• Privacy mode is on for the call you tried to join (page 18).• The handset you are using is too far from the base unit. Move closer and try again.
Check tel line 1 Check tel line 2	<ul style="list-style-type: none">• The supplied telephone line cord has not been connected yet or not connected properly. Check the connections (page 9).• If you use the unit as a single-line telephone only, erase the message as follows: To erase "Check tel line 1", press [MENU]. → [#][1][8][9] To erase "Check tel line 2", press [MENU]. → [#][1][9][0] When a power failure occurs, the message is displayed again. Erase again as above.
Error!!	<ul style="list-style-type: none">• Recording was too short. Try again.
Failed	<ul style="list-style-type: none">• Phonebook copy failed (page 26). Confirm the other unit (the receiver) is in standby mode and try again.
Incomplete	<ul style="list-style-type: none">• Phonebook copy is incomplete. The receiver's phonebook memory is full. Erase the unwanted phonebook entries (page 25) from the other unit (the receiver) and try again.
Memory full	<ul style="list-style-type: none">• The phonebook memory is full. Erase unwanted entries (page 25).• Message memory is full. Erase unwanted messages (page 37, 38).
Messages full	<ul style="list-style-type: none">• Message memory is full. Erase unwanted messages (page 37, 38).
No link to base. Reconnect AC adaptor.	<ul style="list-style-type: none">• The handset has lost communication with the base unit. Move closer to the base unit and try again.• Unplug the base unit's AC adaptor to reset the unit. Reconnect the adaptor and try again.• The handset's registration may have been cancelled. Re-register the handset (page 32).
Use rechargeable battery.	<ul style="list-style-type: none">• A wrong type of battery such as Alkaline or Manganese was inserted. Use only the rechargeable Ni-MH batteries noted on page 4,6.
You must first subscribe to Caller ID.	<ul style="list-style-type: none">• You must subscribe to a Call Display service. Once you receive caller information after subscribing to a Call Display service, this message will not be displayed.

Troubleshooting

If you still have difficulties after following the instructions in this section, disconnect the base unit's AC adaptor, then reconnect the base unit's AC adaptor. Remove the batteries from the handset, and then insert the batteries into the handset again.



General use

Problem	Cause/solution
The handset does not turn on even after installing charged batteries.	<ul style="list-style-type: none"> Place the handset on the charger to turn on the handset.
The unit does not work.	<ul style="list-style-type: none"> Make sure the batteries are installed correctly (page 10). Fully charge the batteries (page 11). Check the connections (page 9). Unplug the base unit's AC adaptor to reset the unit. Reconnect the adaptor and try again. The handset has not been registered to the base unit. Register the handset (page 32).
I cannot hear a dial tone.	<ul style="list-style-type: none"> The base unit's AC adaptor or telephone line cord is not connected. Check the connections. If you are using a splitter to connect the unit, remove the splitter and connect the unit to the wall jack directly. If the unit operates properly, check the splitter. Disconnect the base unit from the telephone line and connect the line to a known working telephone. If the working telephone operates properly, contact our service personnel to have the unit repaired. If the working telephone does not operate properly, contact your service provider/telephone company.

Programmable settings

Problem	Cause/solution
The display is in a language I cannot read.	<ul style="list-style-type: none"> Change the display language (page 15).
I cannot register a handset to a base unit.	<ul style="list-style-type: none"> The maximum number of handsets (6) is already registered to the base unit. Cancel unused handset registrations from the base unit (page 32).

Battery recharge

Problem	Cause/solution
The handset beeps and/or  flashes.	<ul style="list-style-type: none"> Battery charge is low. Fully charge the batteries (page 11).
I fully charged the batteries, but  still flashes.	<ul style="list-style-type: none"> Clean the battery ends (\oplus, \ominus) and the charge contacts with a dry cloth and charge again. It is time to replace the batteries (page 10).

Useful Information

Making/answering calls, intercom

Problem	Cause/solution
⏸ is flashing.	<ul style="list-style-type: none">• The handset is too far from the base unit. Move closer.• The base unit's AC adaptor is not properly connected. Reconnect AC adaptor to the base unit.• The handset is not registered to the base unit. Register it (page 32).
Noise is heard, sound cuts in and out.	<ul style="list-style-type: none">• You are using the base unit or handset in an area with high electrical interference. Re-position the base unit and use the handset away from sources of interference.• Move closer to the base unit.• If you use a DSL/ADSL service, we recommend connecting a DSL/ADSL filter between the base unit and the telephone line jack. Contact your DSL/ADSL provider for details.
The handset and/or base unit does not ring.	<ul style="list-style-type: none">• The ringer volume is turned off. Adjust the ringer volume (page 17).• Night mode is turned on. Turn it off (page 31).
I cannot make a call.	<ul style="list-style-type: none">• The dialing mode may be set incorrectly. Change the setting (page 15).• The handset is too far from the base unit. Move closer and try again.
I cannot make long distance calls.	<ul style="list-style-type: none">• Make sure that you have long distance service.

Call Display

Problem	Cause/solution
Caller information is not displayed.	<ul style="list-style-type: none">• You must subscribe to Call Display service. Contact your service provider/telephone company for details.• If your unit is connected to any additional telephone equipment such as a Call Display box or cordless telephone line jack, plug the unit directly into the wall jack.• If you use a DSL/ADSL service, we recommend connecting a DSL/ADSL filter between the base unit and the telephone line jack. Contact your DSL/ADSL provider for details.• The name display service may not be available in some areas. Contact your service provider/telephone company for details.• Other telephone equipment may be interfering with this unit. Disconnect the other equipment and try again.
Caller information is displayed late.	<ul style="list-style-type: none">• Depending on your service provider/telephone company, the unit may display or announce the caller's information at the 2nd ring or later.• Move closer to the base unit.
I cannot dial the phone number edited in the caller list.	<ul style="list-style-type: none">• The phone number you dialed might have been edited incorrectly (for example, the long distance "1" or the area code is missing). Edit the phone number with another pattern (page 34).
Time on the unit has shifted.	<ul style="list-style-type: none">• Incorrect time information from incoming Call Display changes the time. Set the time adjustment to "Manual" (off) (page 29).

Useful Information

Problem	Cause/solution
The 2nd caller's information is not displayed during an outside call. (Visual Call Waiting feature does not function.)	<ul style="list-style-type: none">● In order to use Call Display, Call Waiting, or Visual Call Waiting, you must first contact your service provider/ telephone company and subscribe to the desired service. After subscribing, you may need to contact your service provider/telephone company again to activate this specific service, even if you already subscribed to both Call Display and Visual Call Waiting services.

Answering system

Problem	Cause/solution
The unit does not record new messages.	<ul style="list-style-type: none">● The answering system is not turned on for the line you wish to record messages from. Select the desired line or both lines, then turn the answering system on (page 36).● The message memory is full. Erase unwanted messages (page 37).● The answering system is activated for both lines, and the 1st caller is leaving a voice message. The 2nd caller cannot leave a message, but the caller information will be stored (page 33).● If you subscribe to a Voice Mail service, messages are recorded by your service provider/telephone company, not your telephone. Change the unit's number of rings setting or contact your service provider/telephone company (page 40).
I cannot operate the answering system.	<ul style="list-style-type: none">● Someone is using the unit. Wait for the other user to finish.● A caller is leaving a message. Wait for the caller to finish.● The handset is too far from the base unit. Move closer.
I cannot operate the answering system remotely.	<ul style="list-style-type: none">● You are entering the wrong remote access code. If you have forgotten your remote access code, enter the remote access code setting to check your current code (page 39).● Press each key firmly.● The answering system is turned off. Turn it on (page 40).

Useful Information

Telephone Plug-in

Problem	Cause/solution
If the installer program does not start automatically.	<ul style="list-style-type: none"> ● Double click [Setup.exe] in your CD-ROM drive folder to start installing.
A pop-up window (Microsoft Office Outlook contact list) is not displayed when a call is received.	<ul style="list-style-type: none"> ● Caller information indication in the "Telephone Plug-in" setting is set to "Disable". Set it to "Enable" (page 23). ● If more than 5,000 entries are stored in the contact list, pop-up windows may not be displayed. Erase entries from the contact list so that the number of stored entries is 5,000 or less. ● The base unit is in use.
"Invalid phone number" is displayed and I cannot make a call from the Microsoft Outlook contact list.	<ul style="list-style-type: none"> ● If you entered 25 or more digits for the phone number in the toolbar, "Telephone Plug-in" cannot dial the phone number. Enter up to 24 digits for the phone number in the toolbar. ● Entries other than 0 to 9, *, #, p (Pause), f (Flash) are invalid. Enter only valid digits or characters.
I want to update "Telephone Plug-in".	<ul style="list-style-type: none"> ● Once uninstall "Telephone Plug-in", and then re-install the latest version of "Telephone Plug-in" (page 21). Visit our Web site below to download the latest version of "Telephone Plug-in". English:https://panasonic.ca/english/customer-care/downloads.asp French:https://panasonic.ca/french/serviceclient/telechargement.asp
The caller information shown on the unit's display (handset and base unit) differs from the information shown on the pop-up window on the computer.	<ul style="list-style-type: none"> ● When calls are received on LINE 1 and LINE 2 at the same time, the caller information shown on the pop-up window which appears at the front may differ from the information shown on the unit's display (handset and base unit). To answer the call that you want to pick up, check the caller information on the unit's display and press the appropriate line key based on that information. ● Depending on the Microsoft Office Outlook settings, an area code is automatically added for 7-digit phone numbers in the pop-up window. Edit the phone number if necessary. ● The phone number shown on the unit's display (handset and base unit) may differ from the information shown in the pop-up window on the computer when the phone number is not stored as 11 digits in the Microsoft Office Outlook contact list.

Useful Information

Liquid damage

Problem	Cause/solution
Liquid or other form of moisture has entered the base unit/handset.	<ul style="list-style-type: none">● Disconnect the AC adaptor and telephone line cord from the base unit. Remove the batteries from the handset and leave to dry for at least 3 days. After the base unit/handset are completely dry, reconnect the AC adaptor and telephone line cord. Insert the batteries and charge fully before use. If the unit does not work properly, contact an authorized service centre.

Caution:

- To avoid permanent damage, do not use a microwave oven to speed up the drying process.

Useful Information

Industry Canada Notices and other information

NOTICE:

This equipment meets the applicable Industry Canada Terminal Equipment Technical Specifications. This is confirmed by the registration number. The abbreviation, "IC:", before the registration number signifies that registration was performed based on a Declaration of Conformity indicating that Industry Canada technical specifications were met. It does not imply that Industry Canada approved the equipment. Users should ensure, for their own protection, that the electrical ground connections of the power utility, telephone lines and internal metallic water pipe system, if present, are connected together. This precaution may be particularly important in rural areas.

NOTICE:

The **Ringer Equivalence Number (REN)** assigned to each terminal device provides an indication of the maximum number of terminals allowed to be connected to a telephone interface. The termination on an interface may consist of any combination of devices subject only to the requirement that the sum of the Ringer Equivalence Numbers of all the devices does not exceed 5.

The Ringer Equivalence Number (REN) of this unit: (found on the bottom of the unit).

NOTICE:

Operation is subject to the following two conditions: (1) this device may not cause interference, and (2) this device must accept any interference, including interference that may cause undesired operation of the device.

Privacy of communications may not be ensured when using this telephone. Some cordless telephones operate at frequencies that may cause interference to nearby TVs and VCRs. To minimize or prevent such interference, the base of the cordless telephone should not be placed near, or on top of, a TV or VCR. If interference is experienced, move the cordless telephone further away from the TV or VCR. This will often reduce, or eliminate, interference.

RF Exposure Warning:

- This product complies with IC radiation exposure limits set forth for an uncontrolled environment.

- To comply with IC RF exposure requirements, the base unit must be installed and operated 20 cm (8 inches) or more between product and all person's body (excluding extremities of hands, wrist and feet).
- This product may not be collocated or operated in conjunction with any other antenna or transmitter.
- The handset may be carried and operated with only the specific provided belt-clip. Other non-tested belt-clips or similar body-worn accessories may not comply and must be avoided.

Warranty

Panasonic Canada Inc.
5770 Ambler Drive, Mississauga, Ontario L4W 2T3
PANASONIC PRODUCT - LIMITED WARRANTY

EXCHANGE PROGRAM

Panasonic Canada Inc. warrants this product to be free from defects in material and workmanship under normal use and for a period as stated below from the date of original purchase agrees to, at its option either (a) repair your product with new or refurbished parts, (b) replace it with a new or a refurbished equivalent value product, or (c) refund your purchase price. The decision to repair, replace or refund will be made by Panasonic Canada Inc.

Telephone Accessory / Product

One (1) year

This warranty is given only to the original purchaser, or the person for whom it was purchased as a gift, of a Panasonic brand product mentioned above sold by an authorized Panasonic dealer in Canada and purchased and used in Canada, which product was not sold "as is", and which product was delivered to you in new condition in the original packaging.

IN ORDER TO BE ELIGIBLE TO RECEIVE WARRANTY SERVICE HEREUNDER, A PURCHASE RECEIPT OR OTHER PROOF OF DATE OF ORIGINAL PURCHASE, SHOWING AMOUNT PAID AND PLACE OF PURCHASE IS REQUIRED

LIMITATIONS AND EXCLUSIONS

This warranty **ONLY COVERS** failures due to defects in materials or workmanship, and **DOES NOT COVER** normal wear and tear or cosmetic damage. The warranty **ALSO DOES NOT COVER** damages which occurred in shipment, or failures which are caused by products not supplied by Panasonic Canada Inc., or failures which result from accidents, misuse, abuse, neglect, mishandling, misapplication, alteration, faulty installation, set-up adjustments, misadjustment of consumer controls, improper maintenance, improper batteries, power line surge, lightning damage, modification, introduction of sand, humidity or liquids, commercial use such as hotel, office, restaurant, or other business or rental use of the product, or service by anyone other than a Authorized Servicer, or damage that is attributable to acts of God.

Rechargeable batteries are warranted for ninety (90) days from date of original purchase.

THIS EXPRESS, LIMITED WARRANTY IS IN LIEU OF ALL OTHER WARRANTIES, EXPRESS OR IMPLIED, INCLUDING ANY IMPLIED WARRANTIES OF MERCHANTABILITY AND FITNESS FOR A PARTICULAR PURPOSE. IN NO EVENT WILL PANASONIC CANADA INC. BE LIABLE FOR ANY SPECIAL, INDIRECT OR CONSEQUENTIAL DAMAGES RESULTING FROM THE USE OF THIS PRODUCT OR ARISING OUT OF ANY BREACH OF ANY EXPRESS OR IMPLIED WARRANTY. (As examples, this warranty excludes damages for lost time, travel to and from the Authorized Servicer, loss of or damage to media or images, data or other memory or recorded content. This list of items is not exhaustive, but for illustration only.)

In certain instances, some jurisdictions do not allow the exclusion or limitation of incidental or consequential damages, or the exclusion of implied warranties, so the above limitations and exclusions may not be applicable. This warranty gives you specific legal rights and you may have other rights which vary depending on your province or territory.

CONTACT INFORMATION

For product information and operation assistance, please contact:

Our Customer Care Centre: Telephone #: 1-800-561-5505
Fax #: (905) 238-2360
Email link: "Support → contact us → email" on www.panasonic.ca

For defective product exchange within the warranty period, please contact the original dealer or our Customer Care Centre.

Index

Index

- # 3-way conference: 18
- A** Additional handset: 32
 - Alarm: 31
 - Answering calls: 17
 - Answering system
 - Call screening: 36
 - Erasing messages: 37, 38, 39
 - Greeting message: 36
 - Listening to messages: 37, 38, 39
 - Number of rings: 40
 - Recording time: 41
 - Remote access code: 39
 - Remote operation: 39
 - Ring count: 40
 - Toll saver: 40
 - Turning on/off: 36, 39, 40
 - Auto talk: 17
- B** Battery: 10, 11
 - Belt clip: 13
- C** Call Display service: 33
 - Call share: 18
 - Call Waiting: 18
 - Caller list: 33
 - Caller list edit: 34
 - Chain dial: 26
 - Check tel line 1: 46
 - Check tel line 2: 10, 46
 - CID (Call Display): 33
 - Conference calls: 44
 - Control type: 12, 13
 - Customer support: 30
- D** Date and time: 14
 - Dialing mode: 15
 - Direct command code: 27
 - Display
 - Contrast: 29
 - Language: 15
- E** Error messages: 46
- F** Flash: 18, 29
- G** Groups: 24, 33
- H** Handset
 - Deregistration: 32
 - Locator: 43
 - Registration: 32
 - Hold: 17
- I** Intercom: 43
 - Interrupt tone: 29
- K** Key tone: 29
- L** Line mode: 29
 - Line selection mode: 15
- M** Making calls: 16
 - Missed calls: 33
 - Mute: 18
- N** Night mode: 31
- P** Pause: 16
 - Phonebook: 24
 - Phonebook copy: 26
 - Power failure: 11
- R** Redialing: 16
 - Ringer ID: 33
 - Ringer tone: 28, 33
 - Rotary/pulse service: 18
- S** SP-PHONE (Speakerphone): 16
- T** Telephone Plug-in
 - Installation: 20
 - Making calls: 21
 - mini USB cable: 21
 - Pop-up window: 23
 - System requirements: 20
 - Temporary tone dialing: 18
 - Transferring calls: 43
 - Troubleshooting: 47
- V** Visual Call Waiting: 18
 - VM (Voice Mail): 42
 - Voice guidance language: 15
 - Voice Mail: 40, 42
 - Volume
 - Receiver: 16
 - Ringer (Base unit): 17, 28
 - Ringer (Handset): 17, 28
 - Speaker: 16
- W** Wall mounting: 45

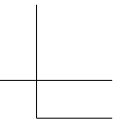
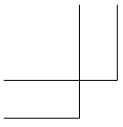

Notes

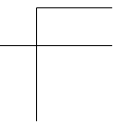
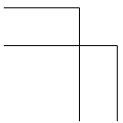
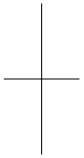

For your future reference

We recommend keeping a record of the following information to assist with any repair under warranty.

Serial No.	Date of purchase
(found on the bottom of the base unit)	
Name and address of dealer	



Panasonic Canada Inc.
 5770 Ambler Drive, Mississauga, Ontario L4W 2T3
 © Panasonic System Networks Co., Ltd. 2011

Printed in Malaysia



PNQX3180ZA TT0611MG0