

# Panasonic®

## Quick Guide

---

### Link2Cell Cordless Telephone with Digital Answering Machine

Model No. **KX-TG832SK**  
**KX-TG833SK**

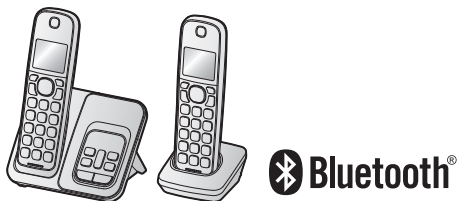

Model shown is KX-TG832.

#### **Thank you for purchasing a Panasonic product.**

Please read this document before using the unit and save it for future reference.

For assistance, visit our Web site: <http://shop.panasonic.com/support> for customers in the U.S.A.

**Please register your product: <http://shop.panasonic.com/support>**

For detailed information about the features of your phone system, refer to the Operating Instructions, which is available by visiting the support page for this product at the address below.

<http://shop.panasonic.com/support>



## **Table of Contents**

---

### **Introduction**

Accessory information .....	3
Graphical symbols for use on equipment and their descriptions .....	5

### **Important Information**

For your safety .....	6
Important safety instructions .....	7
Other information .....	7
Specifications .....	8

### **Getting Started**

Setting up .....	9
Controls .....	10
Display icons/Indicators .....	11
Language settings .....	12
Date and time .....	12
Recording your greeting message .....	12
Link to cell feature .....	12
Pairing a cellular phone .....	13
Link to cell settings .....	13
Making cellular calls .....	14
Making landline calls .....	14
Answering calls .....	14
Phonebook .....	15
Answering system for landline .....	15
Listening to messages .....	15
Copying phonebook from a cellular phone (phonebook transfer) .....	15
Using a Bluetooth headset (optional) .....	16

### **Useful Information**

Frequently asked questions .....	17
FCC and other information .....	19

### **Appendix**

Customer services .....	21
Limited Warranty (ONLY FOR U.S.A.) .....	22

## Accessory information

### Supplied accessories

No.	Accessory item/Part number	Quantity	
		KX-TG832SK	KX-TG833SK
①	AC adaptor/PNLV226-0X	1	1
②	Telephone line cord*1	1	1
③	Wall mounting adaptor*2	1	1
④	Rechargeable batteries/HHR-4DPA	4	6
⑤	Handset cover*3, *4	2	3
⑥	Charger*5	1	2

\*1 PNJA1186Z (Black cord), PNJA1193Z (Transparent cord)

\*2 PNKL1044Y2 (Black), PNKL1044Y1 (White)

\*3 The handset cover comes attached to the handset.

\*4 PNYNTGDA50BR (Black), PNYNTGDA50WR (White)

\*5 PNLC1077ZB (Black), PNLC1077ZW (White)

#### Note:

- Please read the operating instructions for additional/replacement accessories.

### Expanding your phone system



Handset (optional): KX-TGDA50/KX-TGDA51	
<p>You can expand your phone system by registering optional handsets (6 max.) to a single base unit.</p> <ul style="list-style-type: none"> <li>• Optional handsets may be a different color from that of the supplied handsets.</li> <li>• Optional handsets (KX-TGDA50) have a different key print from that of the supplied handsets.</li> <li>• To order, please visit <a href="http://shop.panasonic.com/support">http://shop.panasonic.com/support</a></li> </ul>	

## Introduction

---

### Bluetooth® devices

You can expand your phone system by pairing the following units to a single base unit.

<b>Your Bluetooth cellular phone*1:</b> 2 max. (for cellular calls)	
<b>Your Bluetooth headset*1:</b> 1 max. (for a wireless hands-free conversation)	













\*1 Your cellular phone and headset must be Bluetooth wireless technology compatible. For more details and the list of compatible cellular phones, please visit our Web site:  
<http://shop.panasonic.com/bluetooth-phone>

---

### Trademarks

- The Bluetooth® word mark and logos are registered trademarks owned by Bluetooth SIG, Inc., and any use of such marks by Panasonic Corporation is under license.
- iPhone is a registered trademark of Apple Inc.
- Android is a trademark of Google Inc.
- Gmail and Google Calendar are trademarks of Google Inc.
- Facebook is trademark of Facebook, Inc.
- Twitter is trademark of Twitter Inc.
- Instagram is trademark of Instagram, Inc.
- BlackBerry® is owned by Research In Motion Limited and is registered in the United States and may be pending or registered in other countries. Panasonic is not endorsed, sponsored, affiliated with or otherwise authorized by Research In Motion Limited.
- Siri is a registered trademark of Apple Inc.
- Google Now is a trademark of Google Inc.
- S Voice is a trademark of Samsung Electronics Co., Ltd.
- All other trademarks identified herein are the property of their respective owners.

## Graphical symbols for use on equipment and their descriptions

Symbol	Explanation	Symbol	Explanation
	Alternating current (A.C.)		Class II equipment (equipment in which protection against electric shock relies on Double Insulation or Reinforced Insulation)
	Direct current (D.C.)		"ON" (power)
	Protective earth		"OFF" (power)
	Protective bonding earth		Stand-by (power)
	Functional earth		"ON"/"OFF" (power; push-push)
	For indoor use only		Caution, risk of electric shock

## Important Information

### For your safety

To prevent severe injury and loss of life/property, read this section carefully before using the product to ensure proper and safe operation of your product.

#### WARNING

##### Power connection

- Use only the power source marked on the product.
- Do not overload power outlets and extension cords. This can result in the risk of fire or electric shock.
- Completely insert the AC adaptor/power plug into the power outlet. Failure to do so may cause electric shock and/or excessive heat resulting in a fire.
- Regularly remove any dust, etc. from the AC adaptor/power plug by pulling it from the power outlet, then wiping with a dry cloth. Accumulated dust may cause an insulation defect from moisture, etc. resulting in a fire.
- Unplug the product from power outlets if it emits smoke, an abnormal smell, or makes an unusual noise. These conditions can cause fire or electric shock. Confirm that smoke has stopped emitting and contact us at <http://shop.panasonic.com/support>
- Unplug from power outlets and never touch the inside of the product if its casing has been broken open.
- Never touch the plug with wet hands. Danger of electric shock exists.

##### Installation

- To prevent the risk of fire or electrical shock, do not expose the product to rain or any type of moisture.
- Do not place or use this product near automatically controlled devices such as automatic doors and fire alarms. Radio waves emitted from this product may cause such devices to malfunction resulting in an accident.

- Do not allow the AC adaptor or telephone line cord to be excessively pulled, bent or placed under heavy objects.

##### Operating safeguards

- Unplug the product from power outlets before cleaning. Do not use liquid or aerosol cleaners.
- Do not disassemble the product.
- Do not spill liquids (detergents, cleansers, etc.) onto the telephone line cord plug, or allow it to become wet at all. This may cause a fire. If the telephone line cord plug becomes wet, immediately pull it from the telephone wall jack, and do not use.

##### Medical

- Consult the manufacturer of any personal medical devices, such as pacemakers or hearing aids, to determine if they are adequately shielded from external RF (radio frequency) energy. (The product operates in the frequency range of 1.92 GHz to 1.93 GHz, and the RF transmission power is 115 mW (max.).)
- Do not use the product in health care facilities if any regulations posted in the area instruct you not to do so. Hospitals or health care facilities may be using equipment that could be sensitive to external RF energy.

#### CAUTION

##### Installation and location

- Never install telephone wiring during an electrical storm.
- Never install telephone line jacks in wet locations unless the jack is specifically designed for wet locations.
- Never touch uninsulated telephone wires or terminals unless the telephone line has been disconnected at the network interface.
- Use caution when installing or modifying telephone lines.
- The AC adaptor is used as the main disconnect device. Ensure that the AC outlet is installed near the product and is easily accessible.

## Important Information

- This product is unable to make calls when:
  - the handset batteries need recharging or have failed.
  - there is a power failure.

### Battery

- We recommend using the batteries noted in the operating instructions.
- Do not mix old and new batteries.
- Do not open or mutilate the batteries. Released electrolyte from the batteries is corrosive and may cause burns or injury to the eyes or skin. The electrolyte is toxic and may be harmful if swallowed.
- Exercise care when handling the batteries. Do not allow conductive materials such as rings, bracelets, or keys to touch the batteries, otherwise a short circuit may cause the batteries and/or the conductive material to overheat and cause burns.
- Charge the batteries provided with or identified for use with this product only, in accordance with the instructions and limitations specified in the operating instructions.
- Only use a compatible base unit (or charger) to charge the batteries. Do not tamper with the base unit (or charger). Failure to follow these instructions may cause the batteries to swell or explode.

#### Attention:



A nickel metal hydride battery that is recyclable powers the product you have purchased.  
Please call 1-800-8-BATTERY (1-800-822-8837) for information on how to recycle this battery.

## Important safety instructions

When using your product, basic safety precautions should always be followed to reduce the risk of fire, electric shock, and injury to persons, including the following:

1. Do not use this product near water for example, near a bathtub, washbowl, kitchen sink, or laundry tub, in a wet basement or near a swimming pool.
2. Avoid using a telephone (other than a cordless type) during an electrical storm. There may be a remote risk of electric shock from lightning.
3. Do not use the telephone to report a gas leak in the vicinity of the leak.
4. Use only the power cord and batteries indicated in the operating instructions. Do not dispose of batteries in a fire. They may explode. Check with local codes for possible special disposal instructions.

### SAVE THESE INSTRUCTIONS

## Other information

**CAUTION:** Risk of explosion if battery is replaced by an incorrect type. Dispose of used batteries according to the instructions.

## Important Information

### Notice

- This product is designed for use in the United States of America. Sale or use of this product in other countries may violate local laws.
- Cet appareil est conçu pour être utilisé aux États-Unis d'Amérique. La vente ou l'emploi de cet appareil dans certains autres pays peut constituer une infraction à la législation locale.
- Este producto está diseñado para usarse en los Estados Unidos de América. La venta o el empleo de este producto en ciertos países puede constituir violación de la legislación local.
- 本產品專為美國使用而設。若在其他國家銷售或使用，可能會違反當地法例。
- この製品は、日本国外での使用を目的として設計されており、日本国内での使用は法律違反となります。従って、当社では日本国内においては原則として修理などのサービスは致しかねます。

### Compliance with TIA-1083 standard

Telephone handsets identified with this logo have reduced noise and interference when used with T-Coil equipped hearing aids and cochlear implants.



### Specifications

- **Standard:**  
DECT 6.0 (Digital Enhanced Cordless Telecommunications 6.0)  
Bluetooth wireless technology 2.1
- **Frequency range:**  
1.92 GHz to 1.93 GHz (DECT)  
2.402 GHz to 2.48 GHz (Bluetooth)
- **RF transmission power:**  
115 mW (max.)
- **Power source:**  
120 V AC, 60 Hz
- **Power consumption:**  
**Base unit:**  
Standby: 1.2 W  
Maximum: 4.5 W  
**Charger:**  
Standby: 0.1 W  
Maximum: 1.8 W
- **Operating conditions:**  
0 °C – 40 °C (32 °F – 104 °F), 20 % – 80 % relative air humidity (dry)



### Setting up

#### Connections

- If you do not connect the telephone line cord and use only cellular lines, set the cellular line only mode to use this unit more conveniently (page 13).

#### ■ Base unit

- ① Connect the AC adaptor to the unit by pressing the plug firmly.
- ② Connect the AC adaptor to the power outlet.
- ③ Connect the telephone line cord to the unit, then to the single-line telephone jack (RJ11C) until you hear a click.
- ④ A DSL/ADSL filter (not supplied) is required if you have a DSL/ADSL service.

#### Note:

- Use only the supplied Panasonic AC adaptor PNLV226.

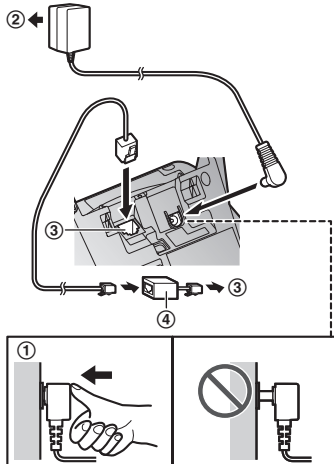

#### ■ Charger

- ① Connect the AC adaptor to the power outlet.

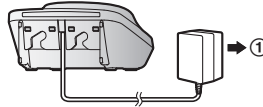

#### Battery installation

- USE ONLY rechargeable Ni-MH batteries AAA (R03) size (A).
- Do NOT use alkaline/manganese/Ni-Cd batteries.
- Confirm correct polarities (+, -).

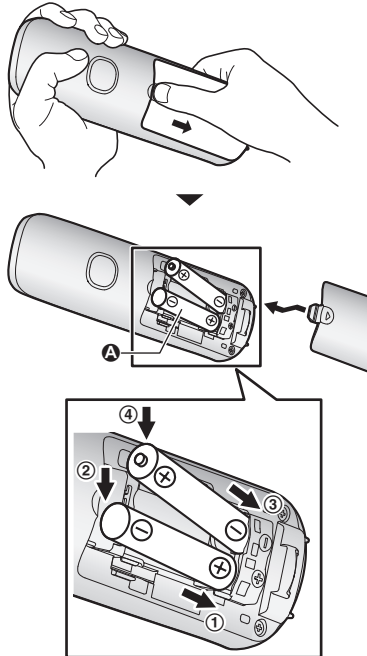

- Follow the directions on the display to set up the unit.

## Getting Started

### Removing the battery

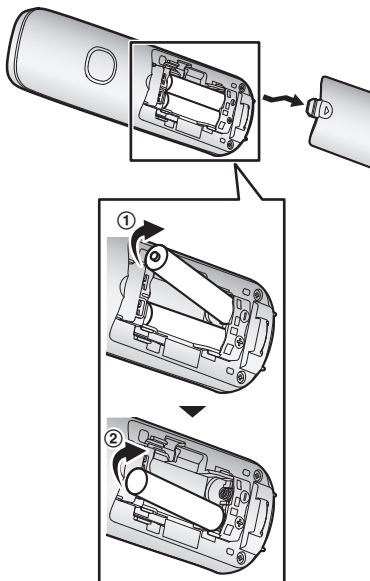

### Battery charging

Charge for about 7 hours.

- Confirm "Charging" is displayed (A).
- When the batteries are fully charged, "Fully charged" is displayed.

### Ni-MH battery performance (supplied batteries)

Operation	Operating time
In continuous use	10 hours max.*1
Not in use (standby)	5 days max.*1

\*1 If eco mode is on.

#### Note:

- Actual battery performance depends on usage and ambient environment.

## Controls

### Handset

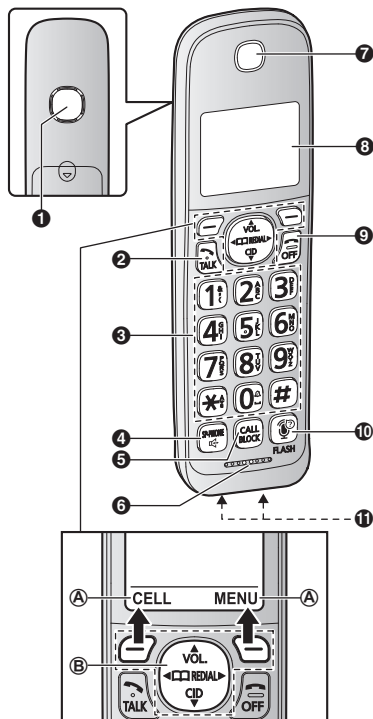

- 1 Speaker
- 2 [TALK]
- 3 Dial keypad
  - ☒: Temporary tone dialing
  - ☒: (X) Ringer off
- 4 [SP-PHONE: Speakerphone]
- 5 [CALL BLOCK]
- 6 Microphone
- 7 Receiver
- 8 Display
- 9 [OFF]

- 10 [ ] (Assist) [FLASH]
- You can use the handset to operate the voice recognition feature of your cellular phone by pressing [ ].

11 Charge contacts

■ Control type

Ⓐ Soft keys

By pressing a soft key, you can select the feature shown directly above it on the display. After a cellular phone is paired, [CELL] is displayed.

Ⓑ Navigator key

- [ ], [ ], [ ], or [ ]: Scroll through various lists and items.
- VOL. (Volume: [ ] or [ ]): Adjust the receiver or speaker volume while talking.
- [ ] □ □: View the phonebook entry.
- [ ] REDIAL: View the redial list.
- [ ] CID (Caller ID): View the caller list.

Base unit

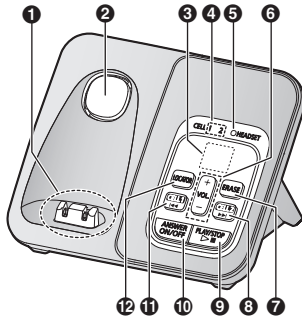

- 1 Charge contacts
- 2 Speaker
- 3 Message counter
- 4 CELL 1 indicator  
CELL 2 indicator
- 5 HEADSET indicator
- 6 [ + ]/[ - ] (VOL.: Volume up/down)
- 7 [ERASE]
- 8 [CELL 2] (For pairing)  
[ ] (Skip)
- 9 [ ] (PLAY/STOP)  
Message indicator [ ]
- 10 [ANSWER ON/OFF]

- 11 [CELL 1] (For pairing)  
[ ] (Repeat)
- 12 [LOCATOR]
  - You can locate a misplaced handset by pressing [LOCATOR].

Display icons/Indicators

Handset display items

Item	Meaning
	Within base unit range
	Out of base unit range
	The landline is in use. <ul style="list-style-type: none"> <li>When flashing: The call is on hold.</li> <li>When flashing rapidly: An incoming call is now being received.</li> </ul>
	- A cellular line is in use.*1 <ul style="list-style-type: none"> <li>When flashing: The cellular call is on hold.</li> <li>When flashing rapidly: A cellular call is being received.</li> </ul> - The remote voice assist feature is in use.
	A cellular phone is connected.*1 Ready to make/receive cellular calls. <ul style="list-style-type: none"> <li>When turned off: A cellular phone is not connected to the base unit. (page 13)</li> </ul>
	- A cellular call is in progress on that line.                     - The cellular line is selected for the setting.
	Speakerphone is on. (page 14)
	Ringer volume is off.*2 (page 14)
	Handset number
	Battery level

## Getting Started

- \*1 Corresponding lines (1, 2: cellular line) are indicated next to the item.
- \*2 Corresponding lines (1, 2: cellular line, L: landline) are indicated next to the item. If all lines are turned off, no line is indicated.

### CELL indicators on the base unit

Status	Meaning
On	A cellular phone is connected. Ready to make/receive cellular calls.
Flashing	<ul style="list-style-type: none"><li>– The cellular line is in use.</li><li>– Phonebook entries are being copied from a cellular phone (page 15).</li><li>– The base unit is searching for the paired cellular phone.</li><li>– The base unit is pairing a cellular phone.</li><li>– A cellular call is on hold.</li><li>– The remote voice assist feature is in use.</li></ul>
Flashing rapidly	A cellular call is being received.
Light off	<ul style="list-style-type: none"><li>– A cellular phone is not paired to the base unit.</li><li>– A cellular phone is not connected to the base unit (page 13).</li></ul>

## Language settings

### Display language

- 1 **[MENU]** **#** **1** **1** **0**
- 2 **[↕]**: Select the desired setting. → **[SAVE]** → **[OFF]**

### Voice announcement language

- 1 **[MENU]** **#** **1** **1** **2**
- 2 **[↕]**: Select the desired setting. → **[SAVE]** → **[OFF]**

## Date and time

- 1 **[MENU]** **#** **1** **0** **1**
- 2 Enter the current month, date, and year by selecting 2 digits for each.  
**Example:** July 12, 2018  
**0** **7** **1** **2** **1** **8**
- 3 **[OK]**
- 4 Enter the current hour and minute (12-hour clock format) by selecting 2 digits for each.  
**Example:** 9:30  
**0** **9** **3** **0**
- 5 **[X]**: Select “**AM**” or “**PM**”.
- 6 **[SAVE]** → **[OFF]**

## Recording your greeting message

- 1 **[MENU]** **#** **3** **0** **2**
- 2 **[↕]**: “**Yes**” → **[SELECT]**
- 3 Record a greeting message. → **[STOP]** → **[OFF]**

## Link to cell feature

You can connect your base unit and cellular phone using Bluetooth wireless technology, so that you can make or answer cellular calls using your phone system. For more details, please visit our Web site:

<http://shop.panasonic.com/bluetooth-phone>

- Locate your cellular phone near the base unit. If the cellular phone is too close to the base unit during a cellular call, you may hear noise. For best performance, we recommend placing the cellular phone between 0.6 m to 3 m (2 feet to 10 feet) away from the base unit.

### Pairing a cellular phone

- 1 Base unit:**

Press and hold [CELL 1] or [CELL 2] for about 5 seconds.

  - After the corresponding CELL indicator on the base unit starts flashing, the rest of the procedure must be completed within 5 minutes.
- 2 Your cellular phone:**

While the corresponding CELL indicator is flashing, follow the instructions of your cellular phone to enter the pairing mode.

  - Depending on your cellular phone, it may ask you to enter the Bluetooth PIN (default: "0000").
  - If your cellular phone prompts you to confirm the passkey, tap [OK] or otherwise to accept the pairing request.
- 3 Base unit:**

Wait until a long beep sounds.

  - It may take more than 10 seconds to complete pairing.
  - When the corresponding CELL indicator lights up, the cellular phone is connected to the base unit. You are ready to make cellular calls.

#### Note:

- If the cellular phone has already paired to the base unit, it is overwritten.
- Make sure that your cellular phone is set to connect to this product automatically. Refer to your cellular phone's operating instructions.

### Link to cell settings

#### Auto connection to the Bluetooth devices (cellular phones)

The unit connects to the Bluetooth devices at regular intervals if the connection is lost. To change the interval (default: "1 min"), see the operating instructions.

- When 3 Bluetooth devices (2 cellular phones and 1 headset) are paired to the base unit, only 2 Bluetooth devices can be

used with the unit at the same time, and the base unit loses its connection from other Bluetooth devices. To automatically resume the connection to Bluetooth devices, leave the auto connection on.

#### Connecting/disconnecting the cellular phone manually

If you will not be using the paired cellular phone's link to cell feature temporarily (for example, you do not want the unit to ring when your cellular line receives a call), you can disconnect your cellular phone from the base unit. If you want to use it again, reconnect the cellular phone to the base unit.

- After you disconnect a paired cellular phone from the base unit manually, it will automatically be connected to the base unit in 30 minutes. If you do not use the link to cell feature anymore, unpair the cellular phone.
- A disconnected cellular phone is not unpaired from the base unit, so pairing it to the base unit again is unnecessary.

#### 1 To connect/disconnect:

For CELL 1: [MENU] [6] [2] [5] [1]

For CELL 2: [MENU] [6] [2] [5] [2]

#### 2 [OFF]

#### Cellular line only mode (If you do not use the landline)

If you do not use the landline, we recommend setting the unit to the cellular line only mode. The default setting is "Off".

- If you turn on the "Cell line only mode", disconnect the telephone line cord from the base unit. Otherwise the "cell line only mode" cannot be activated.

#### 1 [MENU] [1] [5] [7]

#### 2 To turn on:

[↕]: "On" → [SELECT] → [↕]: "Yes" → [SELECT]

To turn off:

[↕]: "Off" → [SELECT]

## Getting Started

### Making cellular calls

- 1 Lift the handset and then dial the phone number.
- 2 **[CELL]**
  - The unit starts dialing immediately in the following situations.
    - Only 1 cellular phone is paired.
    - A specific line is set to make cellular calls.Go to step 4.
- 3 **[↕]**: Select the desired cellular phone. → **[SELECT]**
- 4 When you finish talking, press **[OFF]** or place the handset on the base unit or charger.

### Adjusting the receiver or speaker volume

Press **[▲]** or **[▼]** repeatedly while talking.

#### Note:

- The receiver\*1 or speaker volume you set is kept for each line (landline and cellular lines).

\*1 If the receiver volume is set to level 5 (max.), it will be changed to level 4 in the next call.

### Making a cellular call using the redial list

- 1 **[▶]** REDIAL
- 2 **[↕]**: Select the desired entry.
- 3 **[CELL]**
  - The unit starts dialing immediately in the following situations.
    - Only 1 cellular phone is paired.
    - A specific line is set to make cellular calls.
- 4 **[↕]**: Select the desired cellular phone. → **[SELECT]**

### Making landline calls

- 1 Lift the handset and then dial the phone number.
- 2 **[📞]/[📞]**
- 3 When you finish talking, press **[OFF]** or place the handset on the base unit or charger.

### Making a call using the redial list

- 1 **[▶]** REDIAL
- 2 **[↕]**: Select the desired entry.
- 3 **[📞]**

### Answering calls

- 1 Lift the handset and then press **[📞]** or **[📞]** when the unit rings.
  - To answer a cellular call, you can also press **[CELL]**.
- 2 When you finish talking, press **[OFF]** or place the handset on the base unit or charger.

### Adjusting the ringer volume

#### Handset

Press **[▲]** or **[▼]** repeatedly to select the desired volume while ringing.

- To turn the ringer off, press **[▼]** repeatedly.

#### Base unit

- **While the base unit is ringing for an incoming call:**  
Press **[+]** or **[-]** repeatedly to select the desired volume.
- **While the base unit is in standby mode:**  
Press **[+]** or **[-]** repeatedly to select the desired volume for landline call.
  - To turn the ringer off, press and hold **[-]** until the unit beeps.

## Phonebook

### Adding phonebook entries

- 1 [**◀**] □ → [MENU]
- 2 [**↕**]: "Add new entry" → [SELECT]
- 3 Enter the party's name. → [OK]
- 4 Enter the party's phone number. → [OK]
- 5 [**↕**]: Select the desired group. → [SELECT] 2 times → [OFF]

### Calling from a phonebook entry

- 1 [**◀**] □
- 2 [**↕**]: Select the desired entry.
- 3 ■ Using a cellular line:
  - ① [CELL]
    - The unit starts dialing immediately in the following situations.
      - Only 1 cellular phone is paired.
      - A specific line is set to make cellular calls.
  - ② [**↕**]: Select the desired cellular phone. → [SELECT]
- Using a landline:
  - [**↶**]

## Answering system for landline

### Turning the answering system on/off

#### Base unit

Press [ANSWER ON/OFF] to turn on/off the answering system.

#### Handset

- 1 To turn on:  
[MENU]#327  
To turn off:

- [MENU]#328
- 2 [OFF]

## Listening to messages

### Using the base unit

Press [**▶■**] (PLAY).

### Using the handset

- 1 To listen to new messages:  
[MENU]#323  
To listen to all messages:  
[MENU]#324
- 2 When finished, press [OFF].

## Copying phonebook from a cellular phone (phonebook transfer)

You can copy phonebook entries from the paired cellular phones or other cellular phones (not paired) to the unit's phonebook.

- 1 Handset:  
[MENU]#618
- 2 Handset:  
To copy from paired cellular phones:  
[**↕**]: Select the desired cellular phone. → [SELECT]
  - Copied items are stored to the group ("Cell 1" or "Cell 2") which the cellular phone is paired to.
 To copy from other cellular phones (not paired):  
[**↕**]: "Other cell" → [SELECT] → [**↕**]: Select the group you want to copy to. → [SELECT]
- 3 Handset:  
When "Use the cell to transfer phone book" is displayed:  
Go to step 4.  
When "Select mode" menu is displayed:

## Getting Started

[ $\updownarrow$ ]: Select "Auto" or "Manual". →  
[SELECT]

"Auto": Download all entries from the cellular phone automatically. Go to step 5.  
"Manual": Copy entries you selected.

- "Select mode" menu is displayed only when the cellular phone supports Phone Book Access Profile (PBAP) for Bluetooth connection.
- Some cellular phones may require you to perform an operation on the cellular phone even if you select "Auto".

### 4 Cellular phone:

Follow the instructions of your cellular phone to copy phonebook entries.

- For other cellular phones (not paired), you need to search for and select the base unit. The Bluetooth PIN (default: "0000") may be required.
- If your cellular phone prompts you to confirm the passkey, tap [OK] or otherwise to accept the pairing request.
- The entries being copied are displayed on the handset.

### 5 Handset:

Wait until "Completed" is displayed.

- You can continue copying other entries if necessary.

### 6 Handset: [OFF]

## Using a Bluetooth headset (optional)

By pairing a Bluetooth headset to the base unit, you can enjoy hands-free conversations when talking on landline calls.

- Only 2 Bluetooth devices can be used with the unit at the same time (for example, 2 cellular lines, or the headset and 1 cellular line).

## Pairing a Bluetooth headset to the base unit

### 1 Bluetooth headset:

Set your headset to pairing mode.

- Refer to the headset's operating instructions.

### 2 Handset:

[MENU]#6[2]1

### 3 If your headset PIN is "0000", go to step 4.

If your headset PIN is not "0000", press [CLEAR], then enter your headset's PIN.

- Typically, default PIN is "0000". Refer to the headset's operating instructions.

### 4 Press [OK], then wait until a long beep sounds.

### 5 [OFF]

- When the Bluetooth headset is ready for use, the HEADSET indicator on the base unit lights up.

## Operating a Bluetooth headset using a landline

### Important:

- Refer to your headset operating instructions for headset operations.

## Answering landline calls with your headset

To answer a landline call, press your headset's button referring to your headset's operating instructions.

When you finish talking, press your headset's button referring to your headset's operating instructions.

- If you cannot hang up the call using your headset, press [▶■] (STOP) on the base unit.

## Switching between the base unit and your headset

You can switch from the base unit to your headset while listening to messages recorded on the base unit answering system.

- You can only switch from the base unit to your headset.

### ■ To switch to your headset:

Turn on the headset referring to your headset operating instructions.



## Frequently asked questions

If you still have difficulties after following the instructions in this section, disconnect the base unit's AC adaptor, then reconnect the base unit's AC adaptor. Remove the batteries from the handset, and then insert the batteries into the handset again.

Question	Cause/solution
Why is  displayed?	<ul style="list-style-type: none"> <li>The handset is too far from the base unit. Move closer.</li> <li>The base unit's AC adaptor is not properly connected. Reconnect AC adaptor to the base unit.</li> <li>The handset is not registered to the base unit. Register it.               <ol style="list-style-type: none"> <li><b>Handset:</b> <b>[MENU]</b> <b>[#]</b> <b>[1]</b> <b>[3]</b> <b>[0]</b></li> <li><b>Base unit:</b> Press and hold <b>[LOCATOR]</b> for about 5 seconds.</li> <li><b>Handset:</b> Press <b>[OK]</b>, then wait until a long beep sounds.</li> </ol> </li> </ul>
"Main unit no power" or "No link." is displayed. How do I remove this message from the display?	<ul style="list-style-type: none"> <li>Confirm the base unit's AC adaptor is connected to the unit and the power outlet correctly.</li> <li>The handset has lost communication with the base unit. Move closer to the base unit and try again.</li> <li>Unplug the base unit's AC adaptor to reset the unit. Reconnect the adaptor and try again.</li> </ul>
Time on the unit has shifted.	<ul style="list-style-type: none"> <li>The unit automatically adjusts the date and time each time caller information including date and time is received. (Caller ID subscribers only) To adjust the time, wait for an incoming call.</li> <li>Incorrect time information from incoming Caller ID changes the time. Set the time adjustment to "Manual" (this will turn automatic adjust off)               <ol style="list-style-type: none"> <li><b>[MENU]</b> <b>[#]</b> <b>[2]</b> <b>[2]</b> <b>[6]</b></li> <li><b>[↕]</b>: Select the desired setting. → <b>[SAVE]</b> → <b>[OFF]</b></li> </ol> </li> </ul>
Why am I unable to pair a cellular phone to the base unit?	<ul style="list-style-type: none"> <li>Depending on the compatibility of the cellular phone, you may not be able to pair it to the base unit. For more information, please visit <a href="http://shop.panasonic.com/bluetooth-phone">http://shop.panasonic.com/bluetooth-phone</a></li> <li>Confirm that the Bluetooth feature of your cellular phone is turned on. You may need to turn this feature on depending on your cellular phone.</li> </ul>
How can I increase the handset volume level?	<ul style="list-style-type: none"> <li>Press the volume key <b>[▲]</b> repeatedly while talking.</li> </ul>
Why is the conversation noisy or cutting off?	<ul style="list-style-type: none"> <li>Try to relocate the base unit so that distance to the handset is minimized.</li> <li>If the same problem occurs even if the handset is next to the base unit, please visit: <a href="http://shop.panasonic.com/support">http://shop.panasonic.com/support</a></li> </ul>
Can I add another accessory handset to my base unit?	<ul style="list-style-type: none"> <li>Yes, you can add up to 6 handsets (including the handset(s) sold with your base unit) to a single base unit.</li> <li>To purchase additional accessory handset(s) (KX-TGDA50/KX-TGDA51), please visit: <a href="http://shop.panasonic.com/support">http://shop.panasonic.com/support</a></li> </ul> <p>TTY users (hearing or speech impaired users) can call 1-877-833-8855.</p>

## Useful Information

Question	Cause/solution
Can I keep the batteries charging all the time?	<ul style="list-style-type: none"> <li>You can leave the handset on the base unit or charger anytime. This will not harm the batteries.</li> </ul>
How can I answer a call waiting call (2nd call)?	<ul style="list-style-type: none"> <li>Press <b>[FLASH]</b> when you hear the call waiting tone.</li> </ul>
I want to setup the answering system or help recording the outgoing greeting message.	<ul style="list-style-type: none"> <li>Turn on the answering system (page 15).</li> <li>If you have unit's answering system set to on and also the voicemail enabled, the system with least amount of rings will record the message first. Contact your phone service provider or change the unit's answering system number of rings settings to a lower value using the following method.               <ol style="list-style-type: none"> <li><b>[MENU] [#] 2 1 1</b></li> <li><b>[↕]</b>: Select the desired setting. → <b>[SAVE]</b> → <b>[OFF]</b></li> </ol> </li> <li>To record an outgoing greeting message for your answering system, see page 12.</li> </ul>
I want to setup the voicemail service or help accessing messages.	<ul style="list-style-type: none"> <li>Voicemail service (provided by phone service provider) can record calls when you are on another call or if your answering system is off (page 15).</li> <li>Your phone service provider should provide you with an access number and password to retrieve your voicemail messages.</li> </ul>
"Voicemail msg. via phone co." is shown on the unit display and interrupted or busy dial tone is heard after pressing <b>[↶]</b> on the handset or <b>[↶]</b> on the base unit. How do I clear the voicemail notice and busy dial tone?	<ul style="list-style-type: none"> <li>Your phone service provider's voicemail service (not the unit's answering system) has recorded a message for you. Typically you can clear the voicemail notice and busy (stutter) dial tone by listening to the message. To listen to the voicemail message, dial the voicemail access number provided by your phone service provider, and follow the voice instructions. Depending on your phone service provider, you may need to remove all messages from your voice mailbox to clear the notification.</li> <li>You can remove this notification manually by pressing and holding <b>[#]</b> until the unit beeps.</li> </ul>

## FCC and other information

This equipment complies with Part 68 of the FCC rules and the requirements adopted by the ACTA. On the bottom of this equipment is a label that contains, among other information, a product identifier in the format US:ACJ-----.

If requested, this number must be provided to the telephone company.

- Registration No.....(found on the bottom of the unit)
- Ringer Equivalence No. (REN).....0.1B

A plug and jack used to connect this equipment to the premises wiring and telephone network must comply with the applicable FCC Part 68 rules and requirements adopted by the ACTA. A compliant telephone cord and modular plug is provided with the product. It is designed to be connected to a compatible modular jack that is also compliant.

The REN is used to determine the number of devices that may be connected to a telephone line. Excessive RENs on a telephone line may result in the devices not ringing in response to an incoming call. In most but not all areas, the sum of RENs should not exceed five (5.0). To be certain of the number of devices that may be connected to a line, as determined by the total RENs, contact the local telephone company. For products approved after July 23, 2001, the REN for the product is part of the product identifier that has the format US:AAAEQ##TXXXX. The digits represented by ## are the REN without a decimal point (e.g., 03 is a REN of 0.3).

If this equipment causes harm to the telephone network, the telephone company will notify you in advance that temporary discontinuance of service may be required. But if advance notice isn't practical, the telephone company will notify the customer as soon as possible. Also, you will be

advised of your right to file a complaint with the FCC if you believe it is necessary.

The telephone company may make changes in its facilities, equipment, operations or procedures that could affect the operation of the equipment. If this happens the telephone company will provide advance notice in order for you to make necessary modifications to maintain uninterrupted service.

If trouble is experienced with this equipment, for repair or warranty information, please contact a Factory Service Center or other Authorized Servicer. If the equipment is causing harm to the telephone network, the telephone company may request that you disconnect the equipment until the problem is resolved.

Connection to party line service is subject to state tariffs. Contact the state public utility commission, public service commission or corporation commission for information.

If your home has specially wired alarm equipment connected to the telephone line, ensure the installation of this equipment does not disable your alarm equipment. If you have questions about what will disable alarm equipment, consult your telephone company or a qualified installer.

This equipment is hearing aid compatible as defined by the FCC in 47 CFR Section 68.316.

When you hold the phone to your ear, noise might be heard in your Hearing Aid. Some Hearing Aids are not adequately shielded from external RF (radio frequency) energy. If noise occurs, use an optional headset accessory or the speakerphone option (if applicable) when using this phone. Consult with your audiologist or Hearing Aid

## Useful Information

---

manufacturer about the availability of Hearing Aids which provide adequate shielding to RF energy commonly emitted by digital devices.

### WHEN PROGRAMMING EMERGENCY NUMBERS AND/OR MAKING TEST CALLS TO EMERGENCY NUMBERS:

- 1) Remain on the line and briefly explain to the dispatcher the reason for the call.
- 2) Perform such activities in the off-peak hours, such as early morning or late evenings.

This device complies with Part 15 of the FCC Rules. Operation is subject to the following two conditions:

(1) This device may not cause harmful interference, and (2) this device must accept any interference received, including interference that may cause undesired operation.

Privacy of communications may not be ensured when using this phone.

### CAUTION:

Any changes or modifications not expressly approved by the party responsible for compliance could void the user's authority to operate this device.

### NOTE:

This equipment has been tested and found to comply with the limits for a Class B digital device, pursuant to Part 15 of the FCC Rules. These limits are designed to provide reasonable protection against harmful interference in a residential installation. This equipment generates, uses, and can radiate radio frequency energy and, if not installed and used in accordance with the instructions, may cause harmful interference to radio communications. However, there is no guarantee that interference will not occur in a particular installation. If this equipment does cause harmful interference to radio or television reception, which can be determined by turning the equipment off and on, the user is

encouraged to try to correct the interference by one or more of the following measures:

- Reorient or relocate the receiving antenna.
- Increase the separation between the equipment and receiver.
- Connect the equipment into an outlet on a circuit different from that to which the receiver is connected.
- Consult the dealer or an experienced radio/TV technician for help.

Some cordless telephones operate at frequencies that may cause interference to nearby TVs and VCRs. To minimize or prevent such interference, the base of the cordless telephone should not be placed near or on top of a TV or VCR. If interference is experienced, move the cordless telephone further away from the TV or VCR. This will often reduce or eliminate interference.

### FCC RF Exposure Warning:

- This product complies with FCC radiation exposure limits set forth for an uncontrolled environment.
- To comply with FCC RF exposure requirements, the base unit must be installed and operated 20 cm (8 inches) or more between the product and all person's body.
- This product may not be collocated or operated in conjunction with any other antenna or transmitter.
- For body-worn operation, the handset must be used only with a non-metallic accessory. Use of other accessories may not ensure compliance with FCC RF exposure requirements.

### Notice:

- FCC ID can be found inside the battery compartment or on the bottom of the units.

Customer services

**Shop**  
**Accessories!**

for all your Panasonic gear

Go to

<http://shop.panasonic.com/support>

Get everything you need to get the most out of  
your Panasonic products

Accessories & Parts for your Camera, Phone, A/V  
products, TV, Computers & Networking, Personal  
Care, Home Appliances, Headphones, Batteries,  
Backup Chargers & more...

**Customer Services Directory**

For Product Information, Operating Assistance,  
Parts, Owner's Manuals, Dealer and Service info  
go to <http://shop.panasonic.com/support>

For the hearing or speech impaired TTY: 1- 877-833-8855

As of June 2015

## Appendix

---

### Limited Warranty (ONLY FOR U.S.A.)

## Panasonic Products Limited Warranty

#### Limited Warranty Coverage (For USA Only)

If your product does not work properly because of a defect in materials or workmanship, Panasonic Corporation of North America (referred to as "the warrantor") will, for the length of the period indicated on the chart below, which starts with the date of original purchase ("warranty period"), at its option either (a) repair your product with new or refurbished parts, (b) replace it with a new or a refurbished equivalent value product, or (c) refund your purchase price. The decision to repair, replace or refund will be made by the warrantor.

Product or Part Name	Parts	Labor
Telephone	One (1) Year	One (1) Year

During the "Labor" warranty period there will be no charge for labor. During the "Parts" warranty period, there will be no charge for parts. This Limited Warranty excludes both parts and labor for non-rechargeable batteries, antennas, and cosmetic parts (cabinet). This warranty only applies to products purchased and serviced in the United States. This warranty is extended only to the original purchaser of a new product which was not sold "as is".

**Mail-In Service**--Online Repair Request

#### Online Repair Request

To submit a new repair request and for quick repair status visit our Web Site at <http://shop.panasonic.com/support>

When shipping the unit, carefully pack, include all supplied accessories listed in the Owner's Manual, and send it prepaid, adequately insured and packed well in a carton box. When shipping Lithium Ion batteries please visit our Web Site at <http://shop.panasonic.com/support> as Panasonic is committed to providing the most up to date information. Include a letter detailing the complaint, a return address and provide a daytime phone number where you can be reached. A valid registered receipt is required under the Limited Warranty.

**IF REPAIR IS NEEDED DURING THE WARRANTY PERIOD, THE PURCHASER WILL BE REQUIRED TO FURNISH A SALES RECEIPT/PROOF OF PURCHASE INDICATING DATE OF PURCHASE, AMOUNT PAID AND PLACE OF PURCHASE. CUSTOMER WILL BE CHARGED FOR THE REPAIR OF ANY UNIT RECEIVED WITHOUT SUCH PROOF OF PURCHASE.**

**Limited Warranty Limits and Exclusions**

This warranty ONLY COVERS failures due to defects in materials or workmanship, and DOES NOT COVER normal wear and tear or cosmetic damage. The warranty ALSO DOES NOT COVER damages which occurred in shipment, or failures which are caused by products not supplied by the warrantor, or failures which result from accidents, misuse, abuse, neglect, mishandling, misapplication, alteration, faulty installation, set-up adjustments, misadjustment of consumer controls, improper maintenance, power line surge, lightning damage, modification, introduction of sand, humidity or liquids, commercial use such as hotel, office, restaurant, or other business or rental use of the product, or service by anyone other than a Factory Service Center or other Authorized Servicer, or damage that is attributable to acts of God.

**THERE ARE NO EXPRESS WARRANTIES EXCEPT AS LISTED UNDER "LIMITED WARRANTY COVERAGE".**

**THE WARRANTOR IS NOT LIABLE FOR INCIDENTAL OR CONSEQUENTIAL DAMAGES RESULTING FROM THE USE OF THIS PRODUCT, OR ARISING OUT OF ANY BREACH OF THIS WARRANTY.**

(As examples, this excludes damages for lost time, travel to and from the servicer, loss of or damage to media or images, data or other memory or recorded content. The items listed are not exclusive, but for illustration only.)

**ALL EXPRESS AND IMPLIED WARRANTIES, INCLUDING THE WARRANTY OF MERCHANTABILITY, ARE LIMITED TO THE PERIOD OF THE LIMITED WARRANTY.**

Some states do not allow the exclusion or limitation of incidental or consequential damages, or limitations on how long an implied warranty lasts, so the exclusions may not apply to you. This warranty gives you specific legal rights and you may also have other rights which vary from state to state. If a problem with this product develops during or after the warranty period, you may contact your dealer or Service Center. If the problem is not handled to your satisfaction, then write to:

Consumer Affairs Department  
Panasonic Corporation of North America  
661 Independence Pkwy  
Chesapeake, VA 23320

**PARTS AND SERVICE, WHICH ARE NOT COVERED BY THIS LIMITED WARRANTY, ARE YOUR RESPONSIBILITY.**

As of June 2015

# IMPORTANT!

If your product is not working properly. . .

- ① **Reconnect AC adaptor to the base unit.**
- ② **Check if telephone line cord is connected.**
- ③ **Use rechargeable Ni-MH batteries.**  
(Alkaline/Manganese/Ni-Cd batteries CANNOT be used.)
- ④ Read **troubleshooting** page in the **Operating Instructions**.



Visit our Web site: <http://shop.panasonic.com/support>

- **FAQ and troubleshooting hints are available.**

#### For your future reference

We recommend keeping a record of the following information to assist with any repair under warranty.

Serial No.	Date of purchase
(found on the bottom of the base unit)	
Name and address of dealer	
Attach your purchase receipt here.	

Panasonic Corporation of North America

Two Riverfront Plaza, Newark, NJ 07102-5490

© Panasonic Corporation 2017

Printed in Malaysia



\*PNQW5507ZA\*

**PNQW5507ZA** PP1217ZU0