

Panasonic®

Operating Instructions

Expandable Digital Cordless Phone

Model No. **KX-TG6411C**
KX-TG6412C
KX-TG6413C
KX-TG6414C



Model shown is KX-TG6411.

Expandable Digital Cordless Answering System

Model No. **KX-TG6422C**
KX-TG6424C
KX-TG6431C
KX-TG6432C
KX-TG6433C
KX-TG6434C

Panasonic's environmental declaration labels
This mark is an environmental label
showing that the products are certified
as Panasonic's Green Products.

eco
ideas

Standby power consumption
reduced by 59%

Standby power consumption 1.1 W
Compared to the 2005 model KX-TG2431 (2.7 W)

Thank you for purchasing a Panasonic product.

This unit is compatible with Call Display. You must subscribe to the appropriate service offered by your service provider/telephone company.

Charge the batteries for about 7 hours before initial use.

Please read these operating instructions before using the unit and save them for future reference.

For assistance, please call **1-800-561-5505** or visit us at
www.panasonic.ca

Table of Contents

Introduction	
Model composition	3
Accessory information	4
Important Information	
For your safety	6
Important safety instructions	7
For best performance	7
Specifications	8
Other information	8
Getting Started	
Setting up	9
Note when setting up	10
Controls	11
Display	12
Initial settings	13
Making/Answering Calls	
Making calls	14
Answering calls	14
Useful features during a call	15
Shared Phonebook	
Shared phonebook	17
Programming	
Programmable settings	19
Special programming	24
Registering a unit	26
Call Display Service	
Using Call Display service	28
Caller list	30
Answering System	
Answering system	32
Turning the answering system on/off	32
Greeting message	33
Listening to messages using the base unit	33
Listening to messages using the handset	34
Remote operation	34
Answering system settings	36
Voice Mail Service	
Voice Mail service	38
Intercom/Locator	
Intercom	40
Handset locator	40
Transferring calls, conference calls	40
Useful Information	
Belt clip	41
Wall mounting	41
Error messages	43
Troubleshooting	44
Industry Canada Notices and other information	49
Warranty	50
Index	
Index	51

Introduction

Model composition

■ **KX-TG6411 series**

■ **KX-TG6421/KX-TG6431 series**



• Model shown is KX-TG6412.



• Model shown is KX-TG6422.

Series	Model No.	Base unit	Handset	
		Part No.	Part No.	Quantity
KX-TG6411 series	KX-TG6411	KX-TG6411	KX-TGA641	1
	KX-TG6412	KX-TG6411	KX-TGA641	2
	KX-TG6413	KX-TG6411	KX-TGA641	3
	KX-TG6414	KX-TG6411	KX-TGA641	4
KX-TG6421 series	KX-TG6422	KX-TG6421	KX-TGA642	2
	KX-TG6424	KX-TG6421	KX-TGA642	4
KX-TG6431 series	KX-TG6431	KX-TG6431	KX-TGA641	1
	KX-TG6432	KX-TG6431	KX-TGA641	2
	KX-TG6433	KX-TG6431	KX-TGA641	3
	KX-TG6434	KX-TG6431	KX-TGA641	4

- The suffix (C) in the following model numbers will be omitted in these instructions:
 KX-TG6411C/KX-TG6412C/KX-TG6413C/KX-TG6414C/KX-TG6422C/
 KX-TG6424C/KX-TG6431C/KX-TG6432C/KX-TG6433C/KX-TG6434C

Feature differences

Model No.	Answering system	Talking Call Display	Talking alert*1	Headset jack
KX-TG6411 series	–	–	–	●
KX-TG6421 series	●	–	●	–
KX-TG6431 series	●	●	●	●

*1 Talking battery alert (page 10)/Talking alarm clock (page 24)

Introduction

Accessory information

Supplied accessories

No.	Accessory item/ Part number	Quantity			
		KX-TG6411 KX-TG6431	KX-TG6412 KX-TG6422 KX-TG6432	KX-TG6413 KX-TG6433	KX-TG6414 KX-TG6424 KX-TG6434
①	AC adaptor/ PQLV219	1	2	3	4
②	Telephone line cord	1	1	1	1
③	Wall mounting adaptor	1	1	1	1
④	Rechargeable batteries ^{*1} / HHR-65AAABU or N4DHYYY00002	2	4	6	8
⑤	Handset cover ^{*2}	1	2	3	4
⑥	Belt clip	1	2	3	4
⑦	Charger	–	1	2	3

*1 See below for replacement battery information.

*2 The handset cover comes attached to the handset.

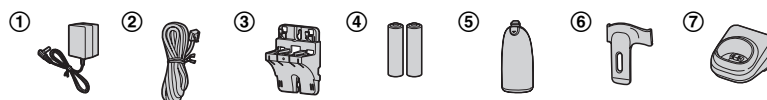

Additional/replacement accessories

Please contact your nearest Panasonic dealer for sales information.

Accessory item	Order number
Rechargeable batteries	HHR-4DPA ^{*1}
	Battery requirement: – Nickel metal hydride (Ni-MH) type battery – 2 AAA (R03) batteries for every handset
Headset	RP-TCA86, RP-TCA94, RP-TCA95



*1 Replacement batteries may have a different capacity from that of the supplied batteries.

Introduction**Expanding your phone system**

You can expand your phone system by registering optional handsets (6 max.) to a single base unit.

- Optional handsets may be a different colour from that of the supplied handsets.

Optional handset feature overview

Feature	KX-TGA641C	KX-TGA740C	KX-TGA840C
Handset			
Display colour/ size	Monochrome/ 1.8 inches	Monochrome/ 2.1 inches	Colour/ 2.0 inches
Control type	Navigator key (Up/down)	Joystick (Up/down/left/right)	Joystick (Up/down/left/right)
Display mode ^{*1}	–	●	●
Message list ^{*2}	–	●	●
Wallpaper	–	–	●
Colour ID ^{*3}	–	–	●
LCD backlight ^{*4}	–	–	●

*1 This feature allows you to select how the display shows:

- multiple items at a time
- 1 item at a time in large characters

*2 The unit displays a list of all recorded messages and allows you to select the item to play back.

*3 You can assign a different background colour to each phonebook entry. When a call is received from a caller stored in the phonebook, the assigned background colour is displayed.

*4 You can select whether the handset display backlight is dimmed or turned off completely after being placed on the base unit or charger.

Important Information

For your safety

To prevent severe injury and loss of life/property, read this section carefully before using the product to ensure proper and safe operation of your product.

WARNING

Power connection

- Use only the power source marked on the product.
- Do not overload power outlets and extension cords. This can result in the risk of fire or electric shock.
- Completely insert the AC adaptor/power plug into the power outlet. Failure to do so may cause electric shock and/or excessive heat resulting in a fire.
- Regularly remove any dust, etc. from the AC adaptor/power plug by pulling it from the power outlet, then wiping with a dry cloth. Accumulated dust may cause an insulation defect from moisture, etc. resulting in a fire.
- Unplug the product from power outlets if it emits smoke, an abnormal smell, or makes an unusual noise. These conditions can cause fire or electric shock. Confirm that smoke has stopped emitting and contact an authorized service centre.
- Unplug from power outlets and never touch the inside of the product if its casing has been broken open.
- Never touch the plug with wet hands. Danger of electric shock exists.

Installation

- To prevent the risk of fire or electrical shock, do not expose the product to rain or any type of moisture.
- Do not place or use this product near automatically controlled devices such as automatic doors and fire alarms. Radio waves emitted from this product may cause such devices to malfunction resulting in an accident.
- Do not allow the AC adaptor or telephone line cord to be excessively pulled, bent or placed under heavy objects.

Operating safeguards

- Unplug the product from power outlets before cleaning. Do not use liquid or aerosol cleaners.
- Do not disassemble the product.
- Do not spill liquids (detergents, cleansers, etc.) onto the telephone line cord plug, or allow it to become wet at all. This may cause a fire. If the telephone line cord plug becomes wet, immediately pull it from the telephone wall jack, and do not use.

Medical

- Consult the manufacturer of any personal medical devices, such as pacemakers or hearing aids, to determine if they are adequately shielded from external RF (radio frequency) energy. (The product operates in the frequency range of 1.92 GHz to 1.93 GHz, and the RF transmission power is 115 mW (max..))
- Do not use the product in health care facilities if any regulations posted in the area instruct you not to do so. Hospitals or health care facilities may be using equipment that could be sensitive to external RF energy.

CAUTION

Installation and relocation

- Never install telephone wiring during an electrical storm.
- Never install telephone line jacks in wet locations unless the jack is specifically designed for wet locations.
- Never touch uninsulated telephone wires or terminals unless the telephone line has been disconnected at the network interface.
- Use caution when installing or modifying telephone lines.
- The AC adaptor is used as the main disconnect device. Ensure that the AC outlet is installed near the product and is easily accessible.
- This product is unable to make calls when:
 - the handset batteries need recharging or have failed.
 - there is a power failure.

Important Information

Battery

- We recommend using the batteries noted on page 4. **USE ONLY rechargeable Ni-MH batteries AAA (R03) size.**
- Do not mix old and new batteries.
- Do not open or mutilate the batteries. Released electrolyte from the batteries is corrosive and may cause burns or injury to the eyes or skin. The electrolyte is toxic and may be harmful if swallowed.
- Exercise care when handling the batteries. Do not allow conductive materials such as rings, bracelets, or keys to touch the batteries, otherwise a short circuit may cause the batteries and/or the conductive material to overheat and cause burns.
- Charge the batteries provided with or identified for use with this product only, in accordance with the instructions and limitations specified in this manual.
- Only use a compatible base unit (or charger) to charge the batteries. Do not tamper with the base unit (or charger). Failure to follow these instructions may cause the batteries to swell or explode.

Attention:



A nickel metal hydride battery that is recyclable powers the product you have purchased. Please call 1-800-8-BATTERY (1-800-822-8837) for information on how to recycle this battery.

Important safety instructions

When using your product, basic safety precautions should always be followed to reduce the risk of fire, electric shock, and injury to persons, including the following:

1. Do not use this product near water for example, near a bathtub, washbowl,

2. kitchen sink, or laundry tub, in a wet basement or near a swimming pool.
2. Avoid using a telephone (other than a cordless type) during an electrical storm. There may be a remote risk of electric shock from lightning.
3. Do not use the telephone to report a gas leak in the vicinity of the leak.
4. Use only the power cord and batteries indicated in this manual. Do not dispose of batteries in a fire. They may explode. Check with local codes for possible special disposal instructions.

SAVE THESE INSTRUCTIONS

For best performance

Base unit location/avoiding noise

The base unit and other compatible Panasonic units use radio waves to communicate with each other.

- For maximum coverage and noise-free communications, place your base unit:
 - at a convenient, high, and central location with no obstructions between the handset and base unit in an indoor environment.
 - away from electronic appliances such as TVs, radios, personal computers, wireless devices, or other phones.
 - facing away from radio frequency transmitters, such as external antennas of mobile phone cell stations. (Avoid putting the base unit on a bay window or near a window.)
- Coverage and voice quality depends on the local environmental conditions.
- If the reception for a base unit location is not satisfactory, move the base unit to another location for better reception.

Environment

- Keep the product away from electrical noise generating devices, such as fluorescent lamps and motors.
- The product should be kept free from excessive smoke, dust, high temperature, and vibration.
- The product should not be exposed to direct sunlight.
- Do not place heavy objects on top of the product.

Important Information

- When you leave the product unused for a long period of time, unplug the product from the power outlet.
- The product should be kept away from heat sources such as heaters, kitchen stoves, etc. It should not be placed in rooms where the temperature is less than 0 °C (32 °F) or greater than 40 °C (104 °F). Damp basements should also be avoided.
- The maximum calling distance may be shortened when the product is used in the following places: Near obstacles such as hills, tunnels, underground, near metal objects such as wire fences, etc.
- Operating the product near electrical appliances may cause interference. Move away from the electrical appliances.

Routine care

- **Wipe the outer surface of the product with a soft moist cloth.**
- Do not use benzine, thinner, or any abrasive powder.

Notice for product disposal, transfer, or return

- This product can store your private/confidential information. To protect your privacy/confidentiality, we recommend that you erase information such as phonebook or caller list entries from the memory before you dispose of, transfer, or return the product.

Specifications

- **Standard:**
DECT 6.0 (Digital Enhanced Cordless Telecommunications 6.0)
- **Frequency range:**
1.92 GHz to 1.93 GHz
- **RF transmission power:**
115 mW (max.)
- **Power source:**
120 V AC, 60 Hz
- **Power consumption:**
Base unit:
Standby: Approx. 1.1 W
Maximum: Approx. 4.4 W
Charger:
Standby: Approx. 0.1 W
Maximum: Approx. 2.6 W

Operating conditions:

0 °C – 40 °C (32 °F – 104 °F), 20 % – 80 % relative air humidity (dry)

Note:

- Design and specifications are subject to change without notice.
- The illustrations in these instructions may vary slightly from the actual product.

Other information

CAUTION: Risk of explosion if battery is replaced by an incorrect type. Dispose of used batteries according to the instructions.

ENERGY STAR

As an ENERGY STAR® Partner, Panasonic has determined that this product meets the ENERGY STAR guidelines for energy efficiency. ENERGY STAR is a U.S. registered mark.



Getting Started

Setting up

Connections

- Use only the supplied Panasonic AC adaptor PQLV219.

■ **Base unit**

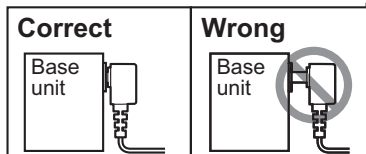
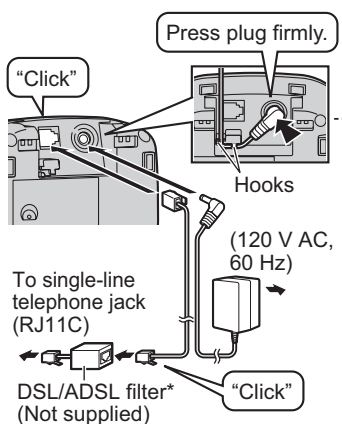

*For DSL/ADSL service users

■ **Charger**

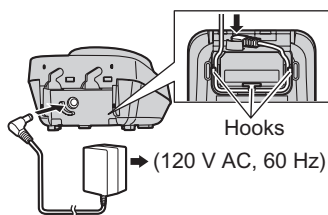

Battery installation

- USE ONLY Ni-MH batteries AAA (R03) size.
- Do NOT use Alkaline/Manganese/Ni-Cd batteries.
- Confirm correct polarities (\oplus , \ominus).

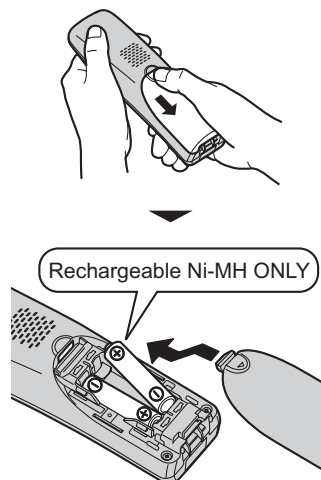

Battery charge

Charge for about 7 hours.

- When the batteries are fully charged, the charge indicator goes off.

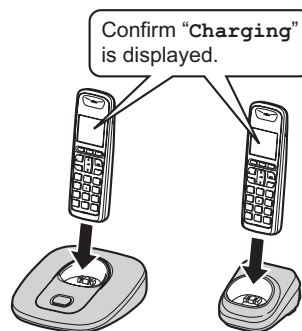

Getting Started

Note when setting up

Note for connections

- The AC adaptor must remain connected at all times. (It is normal for the adaptor to feel warm during use.)
- The AC adaptor should be connected to a vertically oriented or floor-mounted AC outlet. Do not connect the AC adaptor to a ceiling-mounted AC outlet, as the weight of the adaptor may cause it to become disconnected.

During a power failure

The unit will not work during a power failure. We recommend connecting a corded-type telephone (without AC adaptor) to the same telephone line or to the same telephone line jack using a T-adaptor.





Note for battery installation

- Use the supplied rechargeable batteries. For replacement, we recommend using the Panasonic rechargeable batteries noted on page 4, 7.
- Wipe the battery ends (⊕, ⊖) with a dry cloth.
- Avoid touching the battery ends (⊕, ⊖) or the unit contacts.

Note for battery charge

- It is normal for the handset to feel warm during charging.
- Clean the charge contacts of the handset, base unit, and charger with a soft and dry cloth once a month. Clean more often if the unit is exposed to grease, dust, or high humidity.

Battery level

Icon	Battery level
	High
	Medium
	Low
	Needs charging.
	Empty

Note:

- The batteries need to be charged if:
 - the handset alerts you with a voice announcement (**talking battery alert**) after you finish talking or listening to a message. (KX-TG6421/KX-TG6431 series: page 3)
 - the handset beeps while you are engaged in a call.
 - the handset beeps while you are operating the answering system remotely. (KX-TG6421/KX-TG6431 series: page 3)

Panasonic Ni-MH battery performance (supplied batteries)

Operation	Operating time
In continuous use	5 hours max.*1
Not in use (standby)	11 days max.

*1 When the clarity booster feature is turned on (page 16): 3 hours max.

Note:

- Actual battery performance depends on a combination of how often the handset is in use and how often it is not in use (standby).
- Even after the handset is fully charged, the handset can be left on the base unit or charger without any ill effect on the batteries.

Getting Started

- The battery level may not be displayed correctly after you replace the batteries. In this case, place the handset on the base unit or charger and let it charge for at least 7 hours.

Controls

Handset (KX-TGA641C)

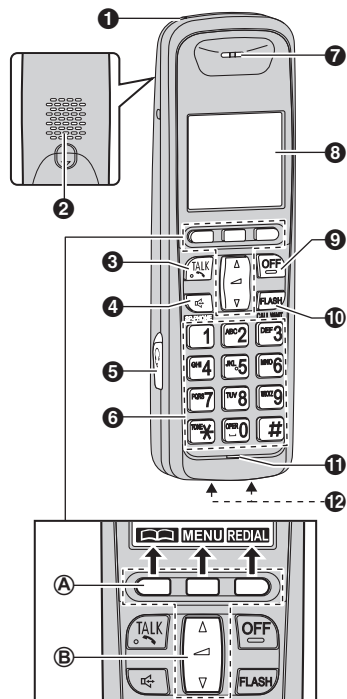

- 1 Charge indicator
Ringer indicator
Message indicator
- 2 Speaker
- 3 [TALK]
- 4 [SP-PHONE: Speakerphone]

- 5 Headset jack (KX-TG6411/
KX-TG6431 series: page 3)
- 6 Dial keypad ([*]: TONE)
- 7 Receiver
- 8 Display
- 9 [OFF]
- 10 [FLASH] [CALL WAIT]
- 11 Microphone
- 12 Charge contacts

Control type

A Soft keys

The handset features 3 soft keys. By pressing a soft key, you can select the feature shown directly above it on the display.

B Navigator key/ (Volume) key
By pressing this key ([▲] or [▼]) repeatedly, you can:

- scroll through (up or down) various lists or items
- adjust the receiver or speaker volume (up or down) while talking
- move the cursor (left or right) to edit number or name

Base unit

KX-TG6411 series (page 3)

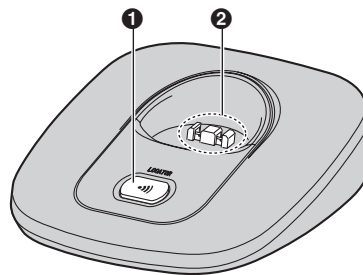

- 1 [LOCATOR]
- 2 Charge contacts

Getting Started

■ KX-TG6421/KX-TG6431 series (page 3)

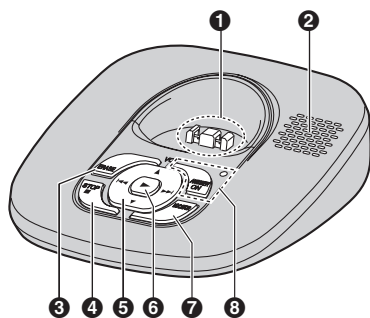

- ❶ Charge contacts
- ❷ Speaker
- ❸ [ERASE]
- ❹ [■] (STOP)
- ❺ [▲]/[▼] (VOL.: Volume up/down)
[◀◀]/[▶▶] (Repeat/Skip)
- ❻ [▶] (Play)
Message indicator
- ❼ [LOCATOR]
- ❽ [ANSWER ON]
ANSWER ON indicator

Display

Handset display items

Item	Meaning
☑	Within range of a base unit
☒	Out of range of a base unit
IN USE	The line is in use. <ul style="list-style-type: none"> • When flashing: <ul style="list-style-type: none"> – The call is put on hold. – The answering system is answering a call.*1 • When flashing rapidly: An incoming call is now being received.
🔊	Speaker is on. (page 14)
🔇	Ringer volume is off. (page 21)
🌙	Night mode is on. (page 25)
BOOST	Clarity booster is on. (page 16)
🕒	Alarm is on. (page 24)
📞	Handset number
🔋	Battery level
🚫	Blocked call (page 25)

*1 KX-TG6421/KX-TG6431 series: page 3

Getting Started**Initial settings****Symbol meaning:****Example:** [▼]/[▲]: "off"

Press [▼] or [▲] to select the words in quotations.

Display language

You can select either "English" or "Français" as the display language. The default setting is "English".

- 1 [MENU] → [⇄][1][1][0]
- 2 [▼]/[▲]: Select the desired setting.
- 3 Press the middle soft key to save.
→ [OFF]

Voice guidance language**Available for:**

KX-TG6421/KX-TG6431 series (page 3)

You can select either "English" or "Français" as the voice guidance language of the answering system. This setting also determines the voice announcement language of the talking alarm clock and talking battery alert. The default setting is "English".

- 1 [MENU] → [⇄][1][1][2]
- 2 [▼]/[▲]: Select the desired setting.
- 3 [SAVE] → [OFF]

Dialing mode

If you cannot make calls, change this setting according to your telephone line service. The default setting is "Tone".

"Tone": For tone dial service.
"Pulse": For rotary/pulse dial service.

- 1 [MENU] → [⇄][1][2][0]
- 2 [▼]/[▲]: Select the desired setting.

3 [SAVE] → [OFF]**Date and time**

- 1 [MENU] → [⇄][1][0][1]
- 2 Enter the current month, date, and year by selecting 2 digits for each.
Example: July 15, 2009
[0][7] [1][5] [0][9]
- 3 [OK]
- 4 Enter the current hour and minute (12-hour clock format) by selecting 2 digits for each.
Example: 9:30
[0][9] [3][0]
- 5 [AM/PM]: Select "AM" or "PM".
- 6 [SAVE] → [OFF]

Note:

- When English is selected as the display language, 12-hour clock format is used. When French is selected, 24-hour clock format is used.
- To correct a digit, press [▲] or [▼] to move the cursor to the digit, then make the correction.
- The date and time may be incorrect after a power failure. In this case, set the date and time again.

Making/Answering Calls

Making calls

- 1 Lift the handset and dial the phone number.
 - To correct a digit, press **[CLEAR]**.
- 2 Press **[↶]** or **[CALL]**.
- 3 When you finish talking, press **[OFF]** or place the handset on the base unit or charger.

Using the speakerphone

- 1 Dial the phone number and press **[☎]**.
 - Speak alternately with the other party.
- 2 When you finish talking, press **[OFF]**.

Note:

- For best performance, use the speakerphone in a quiet environment.
- To switch back to the receiver, press **[↶]**.

Adjusting the receiver or speaker volume

Press **[▲]** or **[▼]** repeatedly while talking.

Making a call using the redial list

The last 5 phone numbers dialed are stored in the redial list (each 48 digits max.).

- 1 **[REDIAL]**
- 2 **[▼]/[▲]**: Select the desired phone number.
- 3 **[↶]**

Erasing a number in the redial list

- 1 **[REDIAL]**
- 2 **[▼]/[▲]**: Select the desired phone number. → **[ERASE]**

- 3 **[▼]/[▲]**: "Yes" → **[SELECT]**
- 4 **[OFF]**

Pause (for PBX/long distance service users)

A pause is sometimes required when making calls using a PBX or long distance service. When storing a calling card access number and/or PIN in the phonebook, a pause is also needed (page 18).

Example: If you need to dial the line access number "9" when making outside calls with a PBX:

- 1 **[9]** → **[PAUSE]**
- 2 Dial the phone number. → **[↶]**

Note:

- A 3.5 second pause is inserted each time **[PAUSE]** is pressed. Repeat as needed to create longer pauses.

Answering calls

When a call is being received, the ringer indicator flashes rapidly.

- 1 Lift the handset and press **[↶]** or **[☎]** when the unit rings.
 - You can also answer the call by pressing any dial key from **[0]** to **[9]**, **[*]**, or **[#]**. (**Any key answer feature**)
- 2 When you finish talking, press **[OFF]** or place the handset on the base unit or charger.

Auto talk

You can answer calls simply by lifting the handset off the base unit or charger. You do not need to press **[↶]**. To turn this feature on, see page 21.

Making/Answering Calls

Adjusting the handset ringer volume

Press [**▲**] or [**▼**] repeatedly to select the desired volume while the handset is ringing for an incoming call.

Note:

- You can also program the handset ringer volume beforehand (page 21).

Temporary handset ringer off

While the handset is ringing for a call, you can turn the ringer off temporarily by pressing [**⌘**].

Adjusting the base unit ringer volume

Available for:

KX-TG6421/KX-TG6431 series (page 3)

Press [**▲**] or [**▼**] repeatedly to select the desired volume.

- To turn the ringer off, press and hold [**▼**] until the unit beeps 2 times.

Useful features during a call

Hold

This feature allows you to put an outside call on hold.

- 1 Press [**HOLD**], then press [**OFF**] during an outside call.
- 2 To release hold, press [**↶**].
 - Another handset user can take the call by pressing [**↶**].

Note:

- If a call is kept on hold for more than 9 minutes, an alarm tone starts to sound and the ringer indicator on the handset flashes rapidly. After 1

additional minute on hold, the call is disconnected.

- If another phone is connected to the same line (page 10), you can also take the call by lifting its handset.

Mute

While mute is turned on, you can hear the other party, but the other party cannot hear you.

- 1 Press [**MUTE**] during an outside call.
 - [**MUTE**] flashes.
- 2 To return to the conversation, press [**MUTE**] again.

Note:

- [**MUTE**] is a soft key visible on the handset display during a call.

Flash

[**FLASH**] allows you to use the special features of your host PBX such as transferring an extension call, or accessing optional telephone services.

Note:

- To change the flash time, see page 22.

For Call Waiting or Visual Call Waiting service users

To use Call Waiting, you must first subscribe to the Call Waiting service from your service provider/telephone company.

This feature allows you to receive calls while you are already talking on the phone. If you receive a call while on the phone, you will hear a Call Waiting tone.

If you subscribe to both Call Display and Visual Call Waiting services, the 2nd caller's information is displayed after you hear the Call Waiting tone on the handset.

Making/Answering Calls

- 1 Press **[CALL WAIT]** to answer the 2nd call.
- 2 To switch between calls, press **[CALL WAIT]**.

Note:

- Please contact your service provider/ telephone company for details and availability of this service in your area.

Temporary tone dialing (for rotary/pulse service users)

You can temporarily switch the dialing mode to tone when you need to access touch-tone services (for example, answering services, telephone banking services, etc.).

Press **[*]** (TONE) before entering access numbers which require tone dialing.

Handset clarity booster

This feature can improve sound clarity when the handset is used in an area where there may be interference. During an outside call, this feature is turned on automatically when necessary.

- When this feature is turned on, **BOOST** is displayed.
- While this feature is turned on, the battery operating time is shortened (page 10).

Call share

This feature allows you to join an existing outside call.

To join the conversation, press **[↶]** when the other handset is on an outside call.

Note:

- The possible number of participating parties depends on the series.
KX-TG6411 series (page 3):
 - 3 parties (including 1 outside party)KX-TG6421/KX-TG6431 series (page 3):
 - 4 parties (including 1 outside party)

Shared Phonebook

Shared phonebook

The shared phonebook allows you to make calls without having to dial manually. Any handset registered to the base unit can use the shared phonebook. You can add 50 names and phone numbers to the shared phonebook.

Important:

- Only 1 person can access the shared phonebook at a time.
- Call Display subscribers can use ringer ID features (page 29).

Adding entries

- 1
- 2 **[ADD]**
- 3 Enter the party's name (16 characters max.). → **[OK]**
- 4 Enter the phone number (32 digits max.). → **[OK]**
 - If you do not need to assign the ringer ID, go to step 7.
- 5 **[v]/[▲]**: "Set Ringer ID" → **[SELECT]**
- 6 **[v]/[▲]**: Select the desired setting (page 29). → **[OK]**
- 7 **[SAVE]**
 - To add other entries, repeat from step 2.
- 8 **[OFF]**

Note:

- If you select "No Ringer ID" (default), the handset uses the ringer tone you selected on page 21 when a call is received from that caller.
- When you assign the ringer ID to an entry in the shared phonebook using one handset, it is applied for all handsets.

Character table for entering names

Key	Character
[1]	& ' () , - . / 1
[2]	a b c A B C 2
[3]	d e f D E F 3
[4]	g h i G H I 4
[5]	j k l J K L 5
[6]	m n o M N O 6
[7]	p q r s P Q R S 7
[8]	t u v T U V 8
[9]	w x y z W X Y Z 9
[0]	Space 0
[*]	*
[#]	#
[v]	To move the cursor to the right
[▲]	To move the cursor to the left

- To enter another character that is located on the same dial key, first press **[v]** to move the cursor to the next space.

Correcting a mistake

Press **[▲]** or **[v]** to move the cursor to the character or number you want to erase, then press **[CLEAR]**. Enter the appropriate character or number.

- Press and hold **[CLEAR]** to erase all characters or numbers.

Finding and calling a phonebook entry

Scrolling through all entries

- 1
- 2 **[v]/[▲]**: Select the desired entry.
- 3

Shared Phonebook

Searching by first character (alphabetically)

- 1 **[☞]** → **[SEARCH]**
- 2 Press the dial key (**[0]** – **[9]**, **[*]**, or **[#]**) which contains the character you are searching for (page 17).
 - Press the same dial key repeatedly to display the first entry corresponding to each character located on that dial key.
 - If there is no entry corresponding to the character you selected, the next entry is displayed.
- 3 **[▼]/[▲]**: Scroll through the phonebook if necessary.
- 4 **[↶]**

Editing entries

- 1 Find the desired entry (page 17). → **[EDIT]**
- 2 **[▼]/[▲]**: Select the information you want to edit.
 - **To change the name or phone number:**
[▼]/[▲]: Select the name or phone number. → **[SELECT]**
 → Edit the information (page 17). → **[OK]**
 - **To change the ringer ID:**
[▼]/[▲]: Select the current ringer ID. → **[SELECT]** → Select the desired setting. → **[OK]**
 - To turn the ringer ID off, select “No Ringer ID”.
- 3 **[SAVE]** → **[OFF]**

Erasing entries

- 1 Find the desired entry (page 17).
- 2 **[ERASE]**

- 3 **[▼]/[▲]**: “Yes” → **[SELECT]** → **[OFF]**

Chain dial

This feature allows you to dial phone numbers in the phonebook while you are on a call. This feature can be used, for example, to dial a calling card access number or bank account PIN that you have stored in the phonebook, without having to dial manually.

- 1 During an outside call, press **[☞]**.
- 2 **[▼]/[▲]**: Select the desired entry.
- 3 Press **[CALL]** to dial the number.

Note:

- When storing a calling card access number and your PIN in the phonebook as one phonebook entry, press **[PAUSE]** to add pauses after the number and PIN as necessary (page 14).
- If you have rotary/pulse service, you need to press **[*]** (TONE) before pressing **[☞]** in step 1 to change the dialing mode temporarily to tone.

Programming

Programmable settings

You can customize the unit by programming the following features using the handset.

To access the features, there are 2 methods:

- scrolling through the display menus (page 19)
- using the direct commands (page 21)
- Direct command is the main method used in these operating instructions.

Programming by scrolling through the display menus

- 1 [MENU]**
- 2** Press [▼] or [▲] to select the desired main menu. → **[SELECT]**
- 3** Press [▼] or [▲] to select the desired item in sub-menu 1. → **[SELECT]**
 - In some cases, you may need to select from sub-menu 2. → **[SELECT]**
- 4** Press [▼] or [▲] to select the desired setting. → **[SAVE]**
 - This step may vary depending on the feature being programmed.
 - To exit the operation, press **[OFF]**.

Note:

- See page 21 for the default settings.

Main menu	Sub-menu 1	Sub-menu 2	Page	
Caller list →	–	–	30	
Set date / time Ⓟ (KX-TG6411 series: page 3)	Date and time ^{*1}	–	13	
	Alarm	–	24	
	Time adjust ^{*1}	–	–	
Answering device ☎ (KX-TG6421/ KX-TG6431 series: page 3)	Play new msg.	–	34	
	Play all msg.	–	34	
	Erase all msg. ^{*1}	–	34	
	Greeting	Record greeting ^{*1}		33
		Check greeting		33
		Pre-recorded ^{*1}		33
	Settings	Ring count ^{*1}		36
		Recording time ^{*1}		36
		Remote code ^{*1}		34
	Answer on ^{*1}	–		32
Answer off ^{*1}	–		32	
V.M. access ☒	–	–	39	

Programming

Main menu	Sub-menu 1	Sub-menu 2	Page
Intercom ☎)	–	–	40
Initial setting ☎	Ringer setting	Ringer volume	–
		Ringer tone	–
		Night mode – On / Off – Start / End	24
	Set date / time	Date and time ^{*1}	13
		Alarm	24
		Time adjust ^{*1}	–
	Talking CallerID (KX-TG6431 series: page 3)	Handset	28
		Base unit ^{*1}	
	Voice Mail	Store V.M. no. ^{*1}	38
		VM tone detect ^{*1}	38
	Call block ^{*1}	–	25
	Message alert	–	37
	Display setting	LCD contrast	–
	Key tone	–	–
	Auto talk	–	14
	Set tel line	Set dial mode ^{*1}	13
		Set flash time ^{*1}	15
		Set line mode ^{*1}	–
		C.WTG options ^{*1}	29
	Registration	Register handset	26
Deregistration		27	
Change language	Display	13	
	Voice prompt ^{*1} (KX-TG6421/ KX-TG6431 series: page 3)	13	
Customer support ?	–	–	–

*1 If you program these settings using one of the handsets, you do not need to program the same item using another handset.

Programming**Programming using the direct commands**

- 1 **[MENU]** → **[⇐]**
- 2 Enter the desired feature code.
- 3 Enter the desired setting code. → **[SAVE]**
 - This step may vary depending on the feature being programmed.
 - To exit the operation, press **[OFF]**.

Note:

- In the following table, < > indicates the default settings.

Feature	Feature code	Setting code	System setting ^{*1}	Page
Alarm	[7][2][0]	[1]: Once [2]: Daily [0]: <Off>	–	24
Auto talk ^{*2}	[2][0][0]	[1]: On [0]: <Off>	–	14
Block w/o num. (Block calls without phone number)	[2][4][0]	[1]: On [0]: <Off>	●	26
Call block	[2][1][7]	–	●	25
Caller list	[2][1][3]	–	–	30
Customer support ^{*3}	[6][8][0]	–	–	–
C.WTG options (Call Waiting Deluxe options)	[2][1][5]	[1]: On [0]: <Off>	●	29
Date and time	[1][0][1]	–	●	13
Deregistration	[1][3][1]	–	–	27
Display (Change language)	[1][1][0]	[1]: <English> [2]: Français	–	13
Intercom	[2][7][4]	–	–	40
Key tone ^{*4}	[1][6][5]	[1]: <On> [0]: Off	–	–
LCD contrast (Display contrast)	[1][4][5]	[1]–[6]: Level 1–6 <3>	–	–
Message alert	[3][4][0]	[1]: <On> [0]: Off	–	37
Register handset	[1][3][0]	–	–	26
Ringer tone ^{*5, *6} (Handset)	[1][6][1]	[1]–[3]: Tone <1>–3 [4]–[7]: Melody 1–4	–	–
Ringer volume ^{*7} (Handset)	[1][6][0]	[1]: Low [2]: Medium [3]: <High> [0]: Off	–	–
Set dial mode	[1][2][0]	[1]: Pulse [2]: <Tone>	●	13

Programming

Feature	Feature code	Setting code	System setting ^{*1}	Page
Set flash time ^{*8}	[1][2][1]	[0]: 900ms [1]: <700ms> [2]: 600ms [3]: 400ms [4]: 300ms [5]: 250ms [*]: 200ms [H]: 160ms [6]: 110ms [7]: 100ms [8]: 90ms [9]: 80ms	●	15
Set line mode ^{*9}	[1][2][2]	[1]: A [2]: 	●	-
Night mode (On/Off)	[2][3][8]	[1]: On [0]: <Off>	-	25
Night mode (Start/End)	[2][3][7]	<11:00 PM/06:00 AM>	-	25
Store V.M. no. (V.M.: Voice Mail)	[3][3][1]	-	●	38
Time adjust ^{*10} (Call Display subscribers only)	[2][2][6]	[1]: <Caller ID auto> [0]: Manual	●	-
V.M. access (V.M.: Voice Mail)	[3][3][0]	-	-	39
VM tone detect (VM: Voice Mail)	[3][3][2]	[1]: <On> [0]: Off	●	38

For the Talking Call Display feature (KX-TG6431 series: page 3)

Feature	Feature code	Setting code	System setting ^{*1}	Page
Talking CallerID (Talking Call Display) (Handset)	[1][6][2]	[1]: <On> [0]: Off	-	28
Talking CallerID (Talking Call Display) (Base unit)	[*][1][6] [2]	[1]: On [0]: <Off>	●	28

For the answering system (KX-TG6421/KX-TG6431 series: page 3)

Feature	Feature code	Setting code	System setting ^{*1}	Page
Answer off	[3][2][8]	-	●	32
Answer on	[3][2][7]	-	●	32
Check greeting	[3][0][3]	-	-	33
Erase all msg. (msg.: messages)	[3][2][5]	-	●	34

Programming

Feature	Feature code	Setting code	System setting ^{*1}	Page
Play all msg. (msg.: messages)	[3][2][4]	–	–	34
Play new msg. (msg.: messages)	[3][2][3]	–	–	34
Pre-recorded (Reset to pre-recorded greeting)	[3][0][4]	–	●	33
Record greeting	[3][0][2]	–	●	33
Recording time	[3][0][5]	[1]: 1min [2]: 2min [3]: <3min> [0]: Greeting only	●	36
Remote code	[3][0][6]	<111>	●	34
Ring count	[2][1][1]	[2]–[7]: 2–7 rings <4> [0]: Toll saver	●	36
Voice prompt (Change language)	[1][1][2]	[1]: <English> [2]: Français	●	13

*1 If “System setting” column is checked, you do not need to program the same item using another handset.

*2 If you subscribe to a Call Display service and want to view the caller’s information after lifting up the handset to answer a call, turn off this feature.

*3 The handset can display the Internet address where you can download the operating instructions or get further information for this product, using your computer.

*4 Turn this feature off if you prefer not to hear key tones while you are dialing or pressing any keys, including confirmation tones and error tones.

*5 If you subscribe to a distinctive ring service, select a tone (tone 1 to 3). If you select a melody, you cannot distinguish lines by their ringers.

*6 If you select one of the melody ringer tones, the ringer tone continues to play for several seconds even if the caller has already hung up. You may either hear a dial tone or no one on the line when you answer the call.

*7 When the ringer volume is turned off, M is displayed and the handset does not ring for outside calls.

However even when the ringer volume is set to off, the handset rings at the low level for alarm (page 24), intercom calls and paging (page 40).

*8 The flash time depends on your telephone exchange or host PBX. Contact your PBX supplier if necessary.

*9 Generally, the line mode setting should not be adjusted. If **IN USE** is not displayed when another phone connected to the same line is in use, you need to change the line mode to “A”.

*10 This feature allows the unit to automatically adjust the date and time setting when caller information is received. To use this feature, set the date and time first.

Programming

Special programming

Alarm

You can set one of 2 different alarm options (once or daily) at a time for each handset. An alarm sounds at the set time for 1 minute. The following alarm sounds are available:

■ **KX-TG6411 series: page 3**

You can choose an alarm sound from 3 tones and 4 melodies.

■ **KX-TG6421/KX-TG6431 series: page 3**

- "Tone/Melody": You can choose an alarm sound from 3 tones and 4 melodies.
- "Voice": You can choose one of the 7 pre-recorded announcements:
 - "Good morning"
 - "It's time for dinner"
 - "It's time for lunch"
 - "It's time for the game"
 - "It's time for your meeting"
 - "It's time to pick up the children"
 - "Happy birthday"

The unit makes the selected announcement at the set time (**talking alarm clock**).

Important:

- Set the date and time beforehand (page 13).

1 [MENU] → [⊕][7][2][0]

2 [▼]/[▲]: Select the desired alarm option. → [SELECT]

Off	Turns alarm off. Go to step 6.
Once	An alarm sounds once at the set time. Enter the desired month, date, and year. → [OK]

Daily	An alarm sounds daily at the set time.
-------	--

- 3** Set the desired time. → [OK]
 - KX-TG6411 series (page 3) users skip to step 5.
- 4** [▼]/[▲]: Select "Tone/Melody" or "Voice". → [SELECT]
- 5** [▼]/[▲]: Select the desired item. → [SAVE]
 - If you set a tone or melody, we recommend selecting a different one for outside calls.
- 6** [OFF]
 - When the alarm is set, ☺ is displayed.

Note:

- To stop the alarm, press any dial key or place the handset on the base unit or charger.
- When the handset is in use, the alarm will not sound until the handset is in standby mode.
- If the talking alarm clock is set at the same time for two or more handsets, the first handset makes the announcement, while the other handsets only sound the tone. (KX-TG6421/KX-TG6431 series: page 3)
- If the other unit is in use at the set time, the handsets sound the tone instead of the selected announcement. (KX-TG6421/KX-TG6431 series: page 3)
- If you select "Once", the setting changes to "Off" after the alarm sounds.

Night mode

Night mode allows you to select a period of time during which the handset will not ring for outside calls. This feature is

Programming

useful for time periods when you do not want to be disturbed, for example, while sleeping. Night mode can be set for each handset.

Important:

- Set the date and time beforehand (page 13).
- We recommend turning the base unit ringer off (page 15) and call screening off (page 32) in addition to turning the night mode on.
(KX-TG6421/KX-TG6431 series: page 3)
- If you have set the alarm, the alarm sounds even if the night mode is turned on.

Turning night mode on/off

- 1 **[MENU]** → **[#][2][3][8]**
- 2 **[v]/[^]**: Select "On" or "Off". → **[SAVE]**
 - If you select "Off", press **[OFF]** to exit.
- 3 Enter the desired hour and minute you wish to start this feature.
- 4 **[AM/PM]**: Select "AM" or "PM". → **[OK]**
- 5 Enter the desired hour and minute you wish to end this feature.
- 6 **[AM/PM]**: Select "AM" or "PM".
- 7 **[SAVE]** → **[OFF]**
 - When the night mode is set,  is displayed.

Note:

- To correct a digit, press **[^]** or **[v]** to move the cursor to the digit, then make the correction.

Changing the start and end time

- 1 **[MENU]** → **[#][2][3][7]**
- 2 Continue from step 3, "Turning night mode on/off", page 25.

Call block (Call Display subscribers only)

This feature allows the unit to reject calls when:

- the unit receives a call from a phone number stored in the call block list as unwanted ("Storing unwanted callers", page 25).
- the unit receives a call without phone number ("Block calls without phone number", page 26).

When a call is received, the unit rings for a short time while the caller is being identified. If the unit recognizes the call as unwanted, "Caller blocked" is displayed and the unit sends out a busy tone to the caller, and then disconnects the call.

Important:

- When the unit receives a call from a number that is stored in the call block list or a call without a recognized phone number, the call is logged in the caller list (page 30) with  after the call is disconnected.

Storing unwanted callers

You can store up to 30 phone numbers in the call block list by using the caller list or by entering the numbers directly.

Important:

- You must store the phone number with an area code (10 digits) in the call block list.

From the caller list:

- 1 **[MENU]** → **[#][2][1][3]**
- 2 **[v]/[^]**: Select the entry to be blocked.
 - To edit the number, press **[EDIT]** repeatedly until the phone number is shown in the 10-digit format.
- 3 **[SAVE]**

Programming

- 4 [▼]/[▲]: "Call block" → [SELECT]
- 5 [▼]/[▲]: "Yes" → [SELECT] → [OFF]

■ By entering phone numbers:

- 1 [MENU] → [⊕][2][1][7] → [ADD]
- 2 Enter the phone number (32 digits max.).
 - To erase a digit, press [CLEAR].
- 3 [SAVE] → [OFF]

Block calls without phone number

You can reject a call without phone number including "Unavailable Name & No.", "Private caller", or "Long distance".

- 1 [MENU] → [⊕][2][4][0]
- 2 [▼]/[▲]: Select the desired setting. → [SAVE] → [OFF]

Viewing/editing/erasing call block numbers

- 1 [MENU] → [⊕][2][1][7]
- 2 [▼]/[▲]: Select the desired entry.
 - To exit, press [OFF].
- 3 Proceed with the desired operation.
 - **Editing a number:**
[EDIT] → Edit the phone number. → [SAVE] → [OFF]
 - **Erasing a number:**
[ERASE] → [▼]/[▲]: "Yes" → [SELECT] → [OFF]

Note:

- When editing, press the desired dial key to add, [CLEAR] to erase.
- When viewing, [w/o NUM] appears if the block calls without phone number feature is turned on. To turn the feature off: [w/o NUM] → [▼] → [SAVE] → [OFF]

Registering a unit

Operating additional units

Additional handsets

Up to 6 handsets can be registered to the base unit.

Important:

- See page 5 for information on the available model.

Registering a handset to a base unit

The supplied handset and base unit are pre-registered. If for some reason the handset is not registered to the base unit, re-register the handset.

- 1 **Handset:**
[MENU] → [⊕][1][3][0]
- 2 **Base unit:**
 - **KX-TG6411 series: page 3**
Press and hold [LOCATOR] for about 4 seconds. (No registration tone)
 - **KX-TG6421/KX-TG6431 series: page 3**
Press and hold [LOCATOR] for about 4 seconds until the registration tone sounds.
 - If all registered handsets start ringing, press the same button to stop. Then repeat this step.
 - The next step must be completed within 90 seconds.
- 3 **Handset:**
Press [OK], then wait until a long beep sounds.
- 4 [OFF]

Programming

Note:

- While registering, “**Base registering**” (Base registering) is displayed on all registered handsets.
- When you purchase an additional handset, refer to the additional handset’s installation manual for registration.

Deregistering a handset

A handset can cancel its own registration (or the registration of another handset) that is stored to the base unit. This allows the handset to end its wireless connection with the system.

- 1 [MENU] → [⊕][1][3][1]**
- 2 [3][3][5] → [OK]**
- 3** Select the handset you want to cancel by pressing the desired handset number.
- 4 [▼]/[▲]: “Yes” → [SELECT]**

Call Display Service

Using Call Display service

Important:

- This unit is Call Display compatible. To use Call Display features, you must subscribe to a Call Display service. Contact your service provider/telephone company for details.

Call Display features

When an outside call is being received, the caller's name and phone number are displayed.

Caller information for the last 50 callers is logged in the caller list from the most recent call to the oldest.

- If the unit cannot receive caller information, the following is displayed:
 - **“Unavailable Name & No.”**: The caller dials from an area which does not provide a Call Display service.
 - **“Private caller”**: The caller requests not to send caller information.
 - **“Long distance”**: The caller makes a long distance call.
- If the unit is connected to a PBX system, caller information may not be properly received. Contact your PBX supplier.

Missed calls

If a call is not answered, the unit treats it as a missed call. The display shows **“Missed call”**. This lets you know if you should view the caller list to see who called while you were away.

Phonebook name display

When caller information is received and it matches a phone number stored in the

phonebook, the stored name in the phonebook is displayed and logged in the caller list.

Talking Call Display

Available for:

KX-TG6431 series (page 3)

This feature lets you know who is calling without looking at the display.

To use this feature, you must:

- subscribe to a Call Display service of your service provider/telephone company.
- turn this feature on (page 22).

When caller information is received, the handsets and base unit announce the caller's name or phone number received from your service provider/telephone company following every ring.

- Name pronunciation may vary. This feature may not pronounce all names correctly.
- Call Display service has a limit of how many characters can be displayed. If the caller's name is too long, the handset may not be able to display or announce the entire name.
- The announcement is heard at the same level as the ringer volume (page 15, 21).
- If you turn on the answering system and set the number of rings “2” (page 36), the unit does not announce the caller information. If **“To11 saver”** is selected and there is a new message, the unit does not announce the caller information.
- When you receive a call while on the phone, the 2nd caller's name is not announced even if you subscribe to both Call Display and Visual Call Waiting services.

Call Display Service

Phonebook name announcement

When caller information is received and it matches a phone number stored in the phonebook, the stored name in the phonebook is announced.

Ringer ID

This feature can help you identify who is calling by using different ringers for different callers stored in the phonebook (page 17). You can assign a different ringer to each phonebook entry. When a call is received from a caller stored in the phonebook, the assigned ringer rings after the caller information is displayed.

For Call Waiting Deluxe service users

To use Call Waiting Deluxe, you must subscribe to Call Waiting Deluxe service of your service provider/telephone company.

This feature not only allows your handset to display the 2nd caller's information, but also offers you a variety of ways to deal with the 2nd call.

Important:

- Please contact your service provider/telephone company for details and availability of this service in your area.
- This feature must be turned on before it can be used.

To turn Call Waiting Deluxe on/off

To use Call Waiting Deluxe, you must turn this feature on. The default setting is "Off".

- 1 **[MENU]** → **[#][2][1][5]**
- 2 **[▼]/[▲]**: Select the desired setting.
- 3 **[SAVE]** → **[OFF]**

Call Waiting Deluxe service options

When a 2nd call is received, you can choose how to handle the call by selecting an option shown on the handset display.

Note:

- Your service provider/telephone company may not offer all of the options (page 29).

Displayed option	Function
Answer	Answers the waiting call, while keeping the 1st call on hold.
Hold	Holds the waiting call. The caller will hear the pre-recorded hold message played by your service provider/telephone company.
Announce	The caller will hear the pre-recorded busy message played by your service provider/telephone company (for example, "We are not available now.") and will then be disconnected.
Forward	Forwards the waiting call to the Voice Mail service provided by your service provider/telephone company. You must subscribe to Voice Mail service to use this function.

Call Display Service

Displayed option	Function
Drop	Disconnects (drops) the current call and answers the waiting call.
Conference	Answers the waiting call and combines it with the current call to make a conference call (3-party call).
Return	Returns to the waiting caller while keeping the current call on hold.
Drop caller1	Disconnects (drops) the 1st call during a conference call.
Drop caller2	Disconnects (drops) the 2nd call during a conference call.

To use Call Waiting Deluxe service

- When you hear a Call Waiting tone during an outside call, press **[FLASH]**.
 - The option menu is displayed.
- [v]/[▲]**: Select the desired option. → **[SELECT]**
 - After selecting "Answer", "Hold", or "Conference", you can select another option. → **[FLASH]** → **[v]/[▲]**: Select the desired option. → **[SELECT]**

Note:

- To exit from the option menu, wait for 20 seconds.

Caller list

Important:

- Only 1 person can access the caller list at a time.
- Make sure the unit's date and time setting is correct (page 13).

Viewing the caller list and calling back

- [MENU]** → **[#][2][1][3]**
- Press **[v]** to search from the most recent call, or **[▲]** to search from the oldest call.
- To call back, press **[↶]**. To exit, press **[OFF]**.

Note:

- If the entry has already been viewed or answered, "✓" is displayed, even if it was viewed or answered using another handset.

Editing a caller's phone number before calling back

You can edit a phone number in the caller list by adding the long distance code "1" or removing its area code.

- [MENU]** → **[#][2][1][3]**
- [v]/[▲]**: Select the desired entry.
- Press **[EDIT]** repeatedly until the phone number is shown in the desired format.

- ① 1 – Area code – Local phone number

Example:

1-555-321-5555

Call Display Service

- ② Local phone number

Example:

321-5555

- ③ Area code – Local phone number

Example:

555-321-5555

- 4 

Note:

- The number edited in step 3 will not be saved in the caller list.

Erasing selected caller information

- 1 [MENU] → [⇄][2][1][3]
- 2 [▼]/[▲]: Select the desired entry.
- 3 [ERASE] → [▼]/[▲]: “Yes” → [SELECT] → [OFF]

Erasing all caller information

- 1 [MENU] → [⇄][2][1][3]
- 2 [ERASE] → [▼]/[▲]: “Yes” → [SELECT]

Storing caller information to the phonebook

- 1 [MENU] → [⇄][2][1][3]
- 2 [▼]/[▲]: Select the desired entry.
 - To edit the number, press [EDIT] repeatedly until the phone number is shown in the desired format.
- 3 [SAVE]
- 4 [▼]/[▲]: “Phonebook” → [SELECT]
- 5 Continue from step 2, “Editing entries”, page 18.

Answering System

Answering system

Available for:
KX-TG6421/KX-TG6431 series (page 3)

The answering system can answer and record calls for you when you are unavailable to answer the phone. You can also set the unit to play a greeting message but not to record caller messages by selecting “**Greeting only**” as the recording time setting (page 36).

Important:

- Only 1 person can access the answering system (listen to messages, record a greeting message, etc.) at a time.
- When callers leave messages, the unit records the day and time of each message. Make sure the date and time have been set correctly (page 13).

Memory capacity

The total recording capacity (including your greeting message) is about 16 minutes (KX-TG6421 series: about 10 minutes). A maximum of 64 messages can be recorded.

Note:

- If message memory becomes full:
 - “**Messages full**” is shown on the handset display.
 - The ANSWER ON indicator on the base unit flashes rapidly when the answering system is turned on.
- When the message memory becomes full:
 - If you use the pre-recorded greeting message, the unit automatically switches to another pre-recorded

greeting message asking callers to call again later.

- If you recorded your own greeting message, the same message is still announced to callers even though their messages are not recorded.

Turning the answering system on/off

Base unit

Press [**ANSWER ON**] to turn on/off the answering system.

Handset

■ **To turn on:**

- 1 [**MENU**] → [**#**][3][2][7]
- 2 [**OFF**]

■ **To turn off:**

- 1 [**MENU**] → [**#**][3][2][8]
- 2 [**OFF**]

Note for base unit and handset:

- When the answering system is turned on, the ANSWER ON indicator on the base unit lights up.

Call screening

While a caller is leaving a message, you can listen to the call through the base unit's speaker. To adjust the speaker volume, press [**▲**] or [**▼**] repeatedly. You can answer the call by pressing [**↶**] on the handset.

Turning off the call screening feature

While screening a call, press and hold [**▼**] until the sound goes off.

Note:

- If you adjust the speaker volume while listening to messages, the speaker

Answering System

volume for call screening is turned on again.

Greeting message

When the unit answers a call, a greeting message is played to callers.

You can use either:

- your own greeting message
- a pre-recorded greeting message

Recording your greeting message using the handset

- 1 [MENU] → [Ⓜ][3][0][2]
- 2 [▼]/[▲]: "Yes" → [SELECT]
- 3 After a beep sounds, speak clearly (2 minutes max.).
- 4 Press [STOP] to stop recording.
- 5 [OFF]

Using a pre-recorded greeting message

The unit provides 2 pre-recorded greeting messages:

- If you erase or do not record your own greeting message, the unit plays a pre-recorded greeting asking callers to leave a message.
- If the message recording time (page 36) is set to "Greeting only", callers' messages are not recorded and the unit plays a different pre-recorded greeting message asking callers to call again.

Erasing your greeting message (Resetting to a pre-recorded greeting message)

If you want to use a pre-recorded greeting message once you record your

own greeting message, you need to erase your own greeting message.

- 1 [MENU] → [Ⓜ][3][0][4]
- 2 [YES] → [OFF]

Playing back the greeting message

- 1 [MENU] → [Ⓜ][3][0][3]
- 2 [OFF]

Listening to messages using the base unit

When new messages have been recorded, the message indicator on the base unit flashes.

Press [▶].

- If new messages have been recorded, the base unit plays back new messages.
- If there are no new messages, the base unit plays back all messages.

Operating the answering system during playback

Key	Operation
[▲] or [▼]	Adjust the speaker volume
[◀◀]	Repeat message*1
[▶▶]	Skip message
[■] (STOP)	Pause message - To resume playback, press [▶]. - To stop playback completely, press [■] (STOP) again.
[ERASE]	Erase currently playing message

Answering System

*1 If pressed within the first 5 seconds of a message, the previous message is played.

Erasing all messages

Press **[ERASE]** 2 times while the unit is not in use.

Listening to messages using the handset

When new messages have been recorded:

- "New message" is displayed.
- The message indicator on the handset flashes slowly if the message alert feature is turned on (page 37).

1 [MENU] → [PLAY]

- If new messages have been recorded, the handset plays back new messages.
- If there are no new messages, the handset plays back all messages.

2 When finished, press **[OFF]**.

Note:

- In step 1, you can also perform the desired operation.
 - **To listen to new messages:**
[MENU] → [≡][3][2][3]
 - **To listen to all messages:**
[MENU] → [≡][3][2][4]
- To switch to the receiver, press **[↶]**.

Operating the answering system during playback

Key	Operation
[▲] or [▼]	Adjust the receiver/speaker volume
[1]	Repeat message*1

Key	Operation
[2]	Skip message
[STOP]	Stop playback
[ERASE]	Erase currently playing message

*1 If pressed within the first 5 seconds of a message, the previous message is played.

Calling back (Call Display subscribers only)

If caller information is received for the call, you can call the caller back while listening to a message.

- 1** Press **[SELECT]** during playback.
 - To edit the number before calling back, press **[EDIT]** repeatedly until the phone number is shown in the desired format (page 30).

2 [↶]

Erasing all messages

- 1 [MENU] → [≡][3][2][5]**
- 2 [▼]/[▲] "Yes" → [SELECT] → [OFF]**

Remote operation

Using a touch-tone phone, you can call your phone number from outside and access the unit to listen to messages or change answering system settings. The unit's voice guidance prompts you to press certain dial keys to perform different operations.

Remote access code

A 3-digit remote access code must be entered when operating the answering system remotely. This code prevents

Answering System

unauthorized parties from listening to your messages remotely. The default setting is "111".

- 1 **[MENU]** → **[#][3][0][6]**
- 2 Enter the desired 3-digit remote access code. → **[SAVE]** → **[OFF]**

Using the answering system remotely

- 1 Dial your phone number from a touch-tone phone.
- 2 After the greeting message starts, enter your remote access code.
 - The unit plays back new messages.
- 3 Follow the voice guidance prompts as necessary or control the unit using remote commands (page 35).
- 4 When finished, hang up.

Note:

- You can also leave a message just as any outside caller can. After the greeting message starts, press **[*]** to skip the greeting message and record your message after the beep.

Voice guidance

During remote operation, the unit's voice guidance starts and prompts you to press **[1]** to perform a specific operation, or press **[2]** to listen to more available operations. Operations are presented by voice guidance in the following order:

- Play back all messages
- Play back new messages
- Record your message
- Erase all messages

Note:

- If you do not press any dial keys within 10 seconds after a voice guidance prompt, the unit disconnects your call.

Remote commands

You can press dial keys to access certain answering system functions without waiting for the voice guidance to prompt you.

Key	Operation
[1]	Repeat message (during playback) ^{*1}
[2]	Skip message (during playback)
[4]	Play new messages
[5]	Play all messages
[9]	Stop playback ^{*2}
[0]	Turn answering system off
[*][4]	Erase currently playing message
[*][5]	Erase all messages

^{*1} If pressed within the first 5 seconds of a message, the previous message is played.

^{*2} To resume operation, enter a remote command within 15 seconds, or the voice guidance starts.

Turning on the answering system remotely

If the answering system is off, you can turn it on remotely.

- 1 Dial your phone number from a touch-tone phone.
- 2 Let the phone ring 15 times.
 - A long beep is heard.

Answering System

- 3** Enter your remote access code within 10 seconds after the long beep.
- The greeting message is played back.
 - You can either hang up, or enter your remote access code again and begin remote operation (page 34).

Answering system settings

Number of rings before the unit answers a call

You can change the number of times the phone rings “**Ring count**” before the unit answers calls. You can select 2 to 7 rings, or “**Toll saver**”.

The default setting is “**4**”.

“**Toll saver**”: The unit’s answering system answers at the end of the 2nd ring when new messages have been recorded, or at the end of the 4th ring when there are no new messages. If you call your phone from outside to listen to new messages (page 34), you know that there are no new messages when the phone rings for the 3rd time. You can then hang up without being charged for the call.

- 1** [MENU] → [⊕][2][1][1]
- 2** [▼]/[▲]: Select the desired setting.
→ [SAVE] → [OFF]

For Voice Mail service subscribers

If you subscribe to a flat-rate service package that includes Call Display, Call Waiting, Voice Mail, and unlimited local/regional/long distance calls, please note the following:

- To use the Voice Mail service provided by your service provider/telephone company rather than the unit’s answering system, turn off the answering system (page 32).
- To use this unit’s answering system rather than the Voice Mail service provided by your service provider/telephone company, please contact your service provider/telephone company to deactivate your Voice Mail service.

If your service provider/telephone company cannot do this:

- Set this unit’s “**Ring count**” setting so that this unit’s answering system answers calls before the Voice Mail service of your service provider/telephone company does. It is necessary to check the number of rings required to activate the Voice Mail service provided by your service provider/telephone company before changing this setting.
- Change the number of rings of the Voice Mail service so that the answering system can answer the call first. To do so, contact your service provider/telephone company.

Caller’s recording time

You can change the maximum message recording time allotted to each caller.

You can also select “**Greeting only**” which sets the unit to greet callers but not record messages. The default setting is “**3min**”.

- 1** [MENU] → [⊕][3][0][5]
- 2** [▼]/[▲]: Select the desired setting.
→ [SAVE] → [OFF]

Answering System

Note:

- If you want to select “**Greeting only**”, follow the steps above and press **[0]** in step 2.
- When you select “**Greeting only**”:
 - If you do not record your own message, the unit will play the pre-recorded greeting-only message asking callers to call again later.
 - If you use your own message, record the greeting-only message asking callers to call again later (page 33).

Message alert

You can select whether or not the message indicator on the handset flashes slowly when new messages are recorded. The default setting is “**On**”.

Important:

- If you stored the Voice Mail access number (page 38), the message indicator also flashes for newly recorded Voice Mail messages (page 39).

- 1 **[MENU]** → **[#][3][4][0]**
- 2 **[v]/[▲]**: Select the desired setting.
→ **[SAVE]** → **[OFF]**

Note:

- While message alert is on, battery operating time is shortened (page 10).

Voice Mail Service

Voice Mail service

Voice Mail is an automatic answering service offered by your service provider/telephone company. After you subscribe to this service, your service provider/telephone company's Voice Mail system answers calls for you when you are unavailable to answer the phone or when your line is busy. Messages are recorded by your service provider/telephone company, not your telephone. Please contact your service provider/telephone company for details of this service.

Important:

- To use the Voice Mail service provided by your service provider/telephone company rather than the unit's answering system, turn off the answering system (page 32). For details, see page 36.
(KX-TG6421/KX-TG6431 series: page 3)
- You need to store the Voice Mail access number to activate the message alert feature (page 37) for Voice Mail service.

Storing the Voice Mail (VM) access number

In order to listen to your Voice Mail messages, you must dial your service provider/telephone company's Voice Mail access number. Once you have stored your Voice Mail access number, you can dial it automatically (page 39).

- 1 **[MENU]** → **[#][3][3][1]**
- 2 Enter your access number (32 digits max.). → **[SAVE]** → **[OFF]**

Note:

- When storing your Voice Mail access number and your mailbox password,

press **[PAUSE]** to add pauses (page 14) between the access number and the password as necessary. Contact your service provider/telephone company for the required pause time.

Example:

1-222-333-4444	PPPP	8888
VM access	Pauses	Password
number		

To erase the Voice Mail access number

- 1 **[MENU]** → **[#][3][3][1]**
- 2 Press and hold **[CLEAR]** until all digits are erased. → **[SAVE]** → **[OFF]**

Voice Mail (VM) tone detection

Your service provider/telephone company sends special signals (sometimes called "Voice Mail tones" or "stutter tones") to the unit to let you know you have new Voice Mail messages. If you hear a series of dial tones followed by a continuous dial tone after you press **[↶]**, you have new Voice Mail messages. Minutes after you hang up a call or after the phone stops ringing, your unit checks the phone line to see if new Voice Mail messages have been recorded.

Turn this feature off when:

- You do not subscribe to Voice Mail service.
- Your service provider/telephone company does not send Voice Mail tones.
- Your phone is connected to a PBX.

If you are not sure which setting is required, contact your service provider/telephone company.

Voice Mail Service

Turning VM tone detection on/off

The default setting is "on".

- 1 **[MENU]** → **[*][3][3][2]**
- 2 **[v]/[▲]**: Select the desired setting.
→ **[SAVE]** → **[OFF]**

Listening to Voice Mail messages

The unit lets you know that you have new Voice Mail messages in the following ways:

- "New Voice Mail" is displayed on the handset if message indication service is available.
- The message indicator on the handset flashes slowly if message alert feature is turned on ("Message alert"; page 37).

- 1 Press **[↶]**, then press **[VM]** within 15 seconds.
OR
[MENU] → **[*][3][3][0]**
 - The speakerphone turns on.
- 2 Follow the pre-recorded instructions.
- 3 When finished, press **[OFF]**.

Note:

- If **[VM]** is not displayed, the Voice Mail access number has not been stored. Store the number (page 38).
- If the handset still indicates there are new messages even after you have listened to all new messages, turn it off by pressing and holding **[OFF]** until the handset beeps.
- If your Voice Mail service uses Voice Mail tones and a message is over 3 minutes long, the handset may not indicate new messages.
- If your Voice Mail service uses Voice Mail tones, the tones are heard from any phone connected to the same

line. If you want to use another phone to listen to Voice Mail messages, you have to dial your access number manually.

Intercom/Locator

Intercom

Intercom calls can be made between handsets.

Note:

- If you receive an outside call while talking on the intercom, you hear 2 tones.
To answer the call with the handset, press **[OFF]**, then press **[↶]**.
- When paging unit(s), the paged unit(s) beeps for 1 minute.

Making an intercom call

- 1 **[MENU]** → **[#][2][7][4]**
- 2 **[▼]/[▲]**: Select the desired unit. → **[CALL]**
 - To stop paging, press **[OFF]**.
- 3 When you finish talking, press **[OFF]**.

Answering an intercom call

- 1 Press **[↶]** to answer the page.
- 2 When you finish talking, press **[OFF]**.

Handset locator

You can locate a misplaced handset by pressing **[LOCATOR]** on the base unit. To stop paging, press it again or **[OFF]** on the handset.

Transferring calls, conference calls

Outside calls can be transferred or a conference call with an outside party can be made between 2 handsets.

Example: When handset 1 transfers a call to handset 2 and/or establishes a conference call.

- 1 **Handset 1:**
During an outside call, press **[HOLD]** to put the call on hold.
- 2 **Handset 1:**
[▼]/[▲]: Select the desired unit. → **[CALL]**
 - If the paged party does not answer, press **[↶]** to return to the outside call.
- 3 **Handset 2 (Receiver):**
Press **[↶]** to answer the page.
 - Handset 2 can talk with handset 1.
- 4 Proceed with the desired operation.
 - **To transfer the call:**
 - ① **Handset 1:**
Press **[OFF]**.
 - ② **Handset 2 (Receiver):**
Press **[↶]**.
 - Handset 2 can talk with the outside caller.
 - **To establish a conference call:**

Handset 1:
Press **[CONF]**.

 - To leave the conference, press **[OFF]**. The other parties can continue the conversation.
 - To put the outside call on hold, press **[HOLD]**. To resume the conference, press **[CONF]**.

Belt clip

- To attach
- To remove

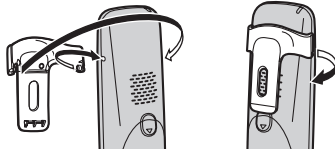

Wall mounting

Base unit

- 1 Lead the AC adaptor cord and telephone line cord through the hole in the wall mounting adaptor in the direction of the arrow.

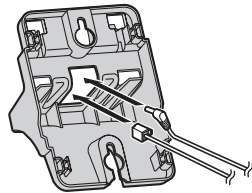

- 2 Tuck the telephone line cord inside the wall mounting adaptor (1). Connect the AC adaptor cord and telephone line cord (2).

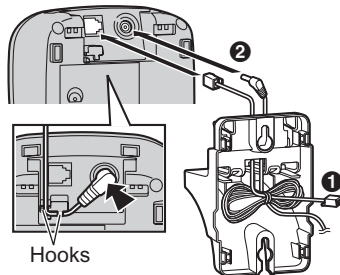

Useful Information

- 3 Insert the hooks on the wall mounting adaptor into holes A and B on the base unit.

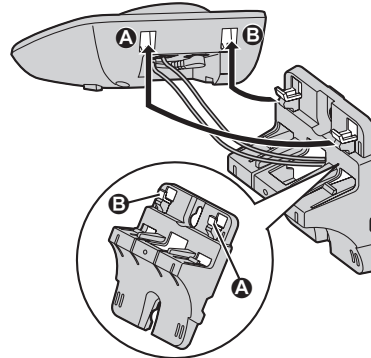

- 4 Adjust the adaptor to hold the base unit, then push it in the direction of the arrow until it clicks into place.

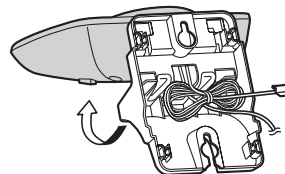
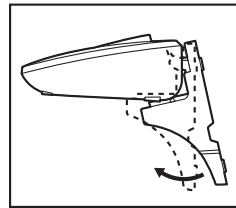

Useful Information

- 5** Connect the telephone line cord. Mount the unit by inserting the mounting pins into the round openings on the adaptor (for pin **B**, use the round cut out at the bottom of the adaptor if you are using the 4 inch phone plate), then slide the unit down to secure it. Connect the AC adaptor to power outlet (page 9).
- There are 2 common types of wall phone plates. The distance between **A** and **B** may vary depending on the size of the wall phone plate installed.

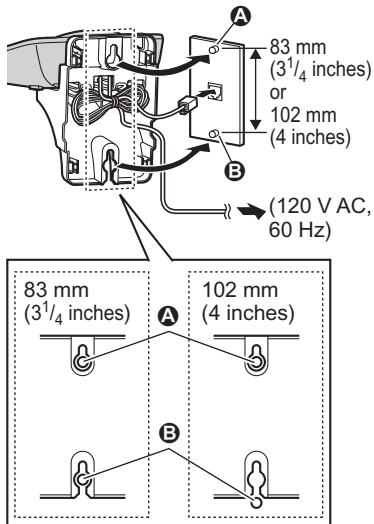

To remove the wall mounting adaptor

While pushing down the release levers (**1**), remove the adaptor (**2**).

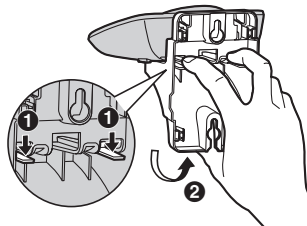

Charger

- 1** Drive the screws (not supplied) into the wall.

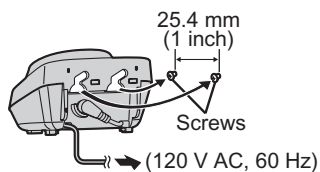

- 2** Mount the charger (**1**), then slide it down (**2**) and to the right (**3**) until it is secure.

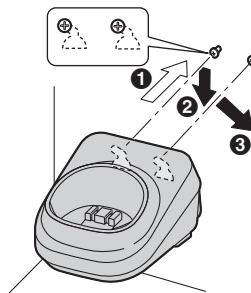

Useful Information**Error messages**

If the unit detects a problem, one of the following messages is shown on the display.

Display message	Cause/solution
Busy or System busy. Try again later.	<ul style="list-style-type: none"> • The called unit is in use. • Other units are in use and the system is busy. Try again later. • The handset you are using is too far from the base unit. Move closer and try again. • The handset's registration may have been cancelled. Re-register the handset (page 26).
Check tel line	<ul style="list-style-type: none"> • The supplied telephone line cord has not been connected yet or not connected properly. Check the connections (page 9).
Use rechargeable battery.	<ul style="list-style-type: none"> • A wrong type of battery such as Alkaline or Manganese was inserted. Use only the rechargeable Ni-MH batteries noted on page 4, 7.
Error!!	<ul style="list-style-type: none"> • The handset's registration has failed. Move the handset and base unit away from all electrical appliances and try again.
Invalid	<ul style="list-style-type: none"> • There is no handset registered to the base unit matching the handset number you entered. • The handset is not registered to the base unit. Register the handset (page 26).
No link. Reconnect base AC adaptor.	<ul style="list-style-type: none"> • The handset has lost communication with the base unit. Move closer to the base unit and try again. • Unplug the base unit's AC adaptor to reset the unit. Reconnect the adaptor and try again. • The handset's registration may have been cancelled. Re-register the handset (page 26).
Requires subscription to Caller ID.	<ul style="list-style-type: none"> • You must subscribe to a Call Display service. Once you receive caller information after subscribing to a Call Display service, this message will not be displayed.
Store V.M. no.	<ul style="list-style-type: none"> • You have not stored the Voice Mail access number. Store the number (page 38).

Useful Information

Troubleshooting

If you still have difficulties after following the instructions in this section, disconnect the base unit's AC adaptor, then reconnect the base unit's AC adaptor. Remove the batteries from the handset, and then insert the batteries into the handset again.

General use

Problem	Cause/solution
The unit does not work.	<ul style="list-style-type: none"> • Make sure the batteries are installed correctly (page 9). • Fully charge the batteries (page 9). • Check the connections (page 9). • Unplug the base unit's AC adaptor to reset the unit. Reconnect the adaptor and try again. • The handset has not been registered to the base unit. Register the handset (page 26).
I cannot hear a dial tone.	<ul style="list-style-type: none"> • The base unit's AC adaptor or telephone line cord is not connected. Check the connections. • If you are using a splitter to connect the unit, remove the splitter and connect the unit to the wall jack directly. If the unit operates properly, check the splitter. • Disconnect the base unit from the telephone line and connect the line to a known working telephone. If the working telephone operates properly, contact our service personnel to have the unit repaired. If the working telephone does not operate properly, contact your service provider/telephone company.
The indicator on the handset flashes slowly.	<ul style="list-style-type: none"> • New messages have been recorded. Listen to the new messages (page 34).^{*1} • New Voice Mail messages have been recorded. Listen to the new Voice Mail messages (page 39).

*1 KX-TG6421/KX-TG6431 series: page 3



Programmable settings

Problem	Cause/solution
I have changed the display language to a language I cannot read.	<ul style="list-style-type: none"> • Change the display language (page 13).

Useful Information

Problem	Cause/solution
While programming, the handset starts to ring.	<ul style="list-style-type: none"> • A call is being received. Answer the call and start again after hanging up.
I cannot register a handset to a base unit.	<ul style="list-style-type: none"> • The maximum number of handsets (6) is already registered to the base unit. Cancel unused handset registrations from the base unit (page 27). • Place the handset and the base unit away from other electrical appliances.

Battery recharge

Problem	Cause/solution
The handset beeps and/or  flashes.	<ul style="list-style-type: none"> • Battery charge is low. Fully charge the batteries (page 9).
I fully charged the batteries, but  still flashes or  is displayed.	<ul style="list-style-type: none"> • Clean the charge contacts and charge again (page 10). • It is time to replace the batteries (page 9).
I fully charged the batteries, but the operating time seems to be shorter.	<ul style="list-style-type: none"> • Clean the battery ends (+, -) and the charge contacts with a dry cloth and charge again.

Making/answering calls, intercom

Problem	Cause/solution
 is displayed.	<ul style="list-style-type: none"> • The handset is too far from the base unit. Move closer. • The base unit's AC adaptor is not properly connected. Reconnect AC adaptor to the base unit. • You are using the handset or base unit in an area with high electrical interference. Re-position the base unit and use the handset away from sources of interference. • The handset is not registered to the base unit. Register it (page 26).

Useful Information

Problem	Cause/solution
Noise is heard, sound cuts in and out.	<ul style="list-style-type: none"> You are using the handset or base unit in an area with high electrical interference. Re-position the base unit and use the handset away from sources of interference. Move closer to the base unit. If you use a DSL/ADSL service, we recommend connecting a DSL/ADSL filter between the base unit and the telephone line jack. Contact your DSL/ADSL provider for details.
The handset does not ring.	<ul style="list-style-type: none"> The ringer volume is turned off. Adjust the ringer volume (page 21). Night mode is turned on. Turn it off (page 25).
The base unit does not ring.*1	<ul style="list-style-type: none"> The ringer volume is turned off. Adjust the ringer volume (page 15).
I cannot make a call.	<ul style="list-style-type: none"> The dialing mode may be set incorrectly. Change the setting (page 13). The handset is too far from the base unit. Move closer and try again.
I cannot make long distance calls.	<ul style="list-style-type: none"> Make sure that you have long distance service.

*1 KX-TG6421/KX-TG6431 series: page 3

Call Display/Talking Call Display*1

Problem	Cause/solution
Caller information is not displayed.	<ul style="list-style-type: none"> You must subscribe to Call Display service. Contact your service provider/telephone company for details. If your unit is connected to any additional telephone equipment such as a Call Display box or cordless telephone line jack, plug the unit directly into the wall jack. If you use a DSL/ADSL service, we recommend connecting a DSL/ADSL filter between the base unit and the telephone line jack. Contact your DSL/ADSL provider for details. The name display service may not be available in some areas. Contact your service provider/telephone company for details. Other telephone equipment may be interfering with this unit. Disconnect the other equipment and try again.

Useful Information

Problem	Cause/solution
Caller information is displayed or announced late.*1	<ul style="list-style-type: none"> • Depending on your service provider/telephone company, the unit may display or announce the caller's information at the 2nd ring or later. • Move closer to the base unit.
Caller information is not announced.*1	<ul style="list-style-type: none"> • The handset or base unit's ringer volume is turned off. Adjust it (page 15, 21). • The Talking Call Display feature is turned off. Turn it on (page 22). • The number of rings for the answering system is set to "2" or "To11 saver". Select a different setting (page 36).
I cannot dial the phone number edited in the caller list.	<ul style="list-style-type: none"> • The phone number you dialed might have been edited incorrectly (for example, the long distance "1" or the area code is missing). Edit the phone number with another pattern (page 30).
Time on the unit has shifted.	<ul style="list-style-type: none"> • Incorrect time information from incoming Call Display changes the time. Set the time adjustment to "Manua1" (off) (page 22).
The 2nd caller's information is not displayed during an outside call. (Visual Call Waiting feature does not function.)	<ul style="list-style-type: none"> • In order to use Call Display, Call Waiting, or Visual Call Waiting, you must first contact your service provider/telephone company and subscribe to the desired service. After subscribing, you may need to contact your service provider/telephone company again to activate this specific service, even if you already subscribed to both Call Display and Visual Call Waiting services.

*1 KX-TG6431 series: page 3

Answering system (KX-TG6421/KX-TG6431 series: page 3)

Problem	Cause/solution
I cannot operate the answering system.	<ul style="list-style-type: none"> • Someone is using the unit. Wait for the other user to finish. • A caller is leaving a message. Wait for the caller to finish. • The handset is too far from the base unit. Move closer.

Useful Information

Problem	Cause/solution
The unit does not record new messages.	<ul style="list-style-type: none"> • The answering system is turned off. Turn it on (page 32). • The message memory is full. Erase unnecessary messages (page 33). • The recording time is set to "Greeting only". Change the setting (page 36). • If you subscribe to a Voice Mail service, messages are recorded by your service provider/telephone company, not your telephone. Change the unit's number of rings setting or contact your service provider/telephone company (page 36).
I cannot operate the answering system remotely.	<ul style="list-style-type: none"> • You are entering the wrong remote access code. If you forgot the remote access code, store a new remote access code (page 34). • Press each key firmly. • The answering system is turned off. Turn it on (page 35). • You are using a rotary/pulse telephone. Try again using a touch-tone phone.
While recording a greeting message or listening to messages, the unit rings and the operation stops.	<ul style="list-style-type: none"> • A call is being received. Answer the call and try again later.

Liquid damage

Problem	Cause/solution
Liquid or other form of moisture has entered the handset/base unit.	<ul style="list-style-type: none"> • Disconnect the AC adaptor and telephone line cord from the base unit. Remove the batteries from the handset and leave to dry for at least 3 days. After the handset/base unit are completely dry, reconnect the AC adaptor and telephone line cord. Insert the batteries and charge fully before use. If the unit does not work properly, contact an authorized service centre.

Caution:

- To avoid permanent damage, do not use a microwave oven to speed up the drying process.

Useful Information

Industry Canada Notices and other information

NOTICE:

This equipment meets the applicable Industry Canada Terminal Equipment Technical Specifications. This is confirmed by the registration number. The abbreviation, "IC:", before the registration number signifies that registration was performed based on a Declaration of Conformity indicating that Industry Canada technical specifications were met. It does not imply that Industry Canada approved the equipment.

And, the term "IC:" signifies that Industry Canada radio technical specifications were met.

Before installing this equipment, users should ensure that it is permissible to be connected to the facilities of the local telecommunications company. The equipment must also be installed using an acceptable method of connection. The customer should be aware that compliance with the above conditions may not prevent degradation of service in some situations.

Repairs to certified equipment should be coordinated by a representative designated by the supplier. Any repairs or alterations made by the user to this equipment, or equipment malfunctions, may give the telecommunications company cause to request the user to disconnect the equipment.

Users should ensure, for their own protection, that the electrical ground connections of the power utility, telephone lines and internal metallic water pipe system, if present, are connected together. This precaution may be particularly important in rural areas.

Caution:

Users should not attempt to make such connections themselves, but should contact the appropriate electric inspection authority, or electrician, as appropriate.

NOTICE:

The **Ringer Equivalence Number (REN)** assigned to each terminal device provides an indication of the maximum number of terminals allowed to be connected to a telephone interface. The termination on an interface may consist of any combination of

devices subject only to the requirement that the sum of the Ringer Equivalence Numbers of all the devices does not exceed 5.

The Ringer Equivalence Number (REN) of this unit:
(found on the bottom of the unit).

NOTICE:

Operation is subject to the following two conditions: (1) this device may not cause interference, and (2) this device must accept any interference, including interference that may cause undesired operation of the device.

Privacy of communications may not be ensured when using this telephone.

Some cordless telephones operate at frequencies that may cause interference to nearby TVs and VCRs. To minimize or prevent such interference, the base of the cordless telephone should not be placed near, or on top of, a TV or VCR. If interference is experienced, move the cordless telephone further away from the TV or VCR. This will often reduce, or eliminate, interference.

RF Exposure Warning:

- This product complies with IC radiation exposure limits set forth for an uncontrolled environment.
- To comply with IC RF exposure requirements, the base unit must be installed and operated 20 cm (8 inches) or more between product and all person's body (excluding extremities of hands, wrist and feet).
- This product may not be collocated or operated in conjunction with any other antenna or transmitter.
- The handset may be carried and operated with only the specific provided belt-clip. Other non-tested belt-clips or similar body-worn accessories may not comply and must be avoided.

Useful Information

Warranty

Panasonic Canada Inc.
5770 Ambler Drive, Mississauga, Ontario L4W 2T3
PANASONIC PRODUCT - LIMITED WARRANTY
EXCHANGE PROGRAM

Panasonic Canada Inc. warrants this product to be free from defects in material and workmanship and agrees to replace the product for a period as stated below from the date of original purchase.

Telephone Accessory / Product One (1) year

LIMITATIONS AND EXCLUSIONS

This warranty does not apply to products purchased outside Canada or to any product which has been improperly installed, subjected to usage for which the product was not designed, misused or abused, damaged during shipping, or which has been altered or repaired in any way that affects the reliability or detracts from the performance, nor does it cover any product which is used commercially. This warranty is extended to the original end user purchaser only. A purchase receipt or other proof of date of original purchase is required before warranty service is performed.

THIS EXPRESS, LIMITED WARRANTY IS IN LIEU OF ALL OTHER WARRANTIES, EXPRESS OR IMPLIED, INCLUDING ANY IMPLIED WARRANTIES OF MERCHANTABILITY AND FITNESS FOR A PARTICULAR PURPOSE.

IN NO EVENT WILL PANASONIC CANADA INC. BE LIABLE FOR ANY SPECIAL, INDIRECT OR CONSEQUENTIAL DAMAGES.

In certain instances, some jurisdictions do not allow the exclusion or limitation of incidental or consequential damages, or the exclusion of implied warranties, so the above limitations and exclusions may not be applicable.

CONTACT INFORMATION

For product information and operation assistance, please contact:

Our Customer Care Centre: Telephone #: (905) 624-5505
1-800 #: 1-800-561-5505
Fax #: (905) 238-2360
Email link: "customer support" on
www.panasonic.ca

For defective product exchange within the warranty period, please contact the original dealer or our Customer Care Centre.

Index

- A** Additional handset: 26
 Alarm: 24
 Answering calls: 14
 Answering system
 Call screening: 32
 Erasing messages: 33, 34, 35
 Greeting only: 36
 Listening to messages: 33, 34, 35
 Number of rings: 36
 Recording time: 36
 Remote access code: 34
 Remote operation: 34
 Ring count: 36
 Toll saver: 36
 Turning on/off: 32, 35
 Auto talk: 14
- B** Battery: 9, 10
 Belt clip: 41
 Booster (Clarity booster): 16
- C** Call block: 25
 Call Display service: 28
 Caller list: 30
 Caller list edit: 30
 Call share: 16
 Call Waiting: 15
 Chain dial: 18
 Conference calls: 40
 Control type: 11
 Customer support: 21
 C.WTG (Call Waiting Deluxe): 29
- D** Date and time: 13
 Dialing mode: 13
 Direct commands: 21
 Display
 Contrast: 21
 Language: 13
- E** Error messages: 43
- F** Flash: 15, 22
- G** Greeting message: 33
- H** Handset
 Deregistration: 27
 Locator: 40
 Registration: 26
 Hold: 15
- I** Intercom: 40
- K** Key tone: 21
- L** Line mode: 22
- M** Making calls: 14
 Missed calls: 28
 Mute: 15
- N** Night mode: 24
- P** Pause: 14
 Phonebook: 17
 Power failure: 10
- R** Redialing: 14
 Ringer tone: 21
 Rotary/pulse service: 16
- S** SP-PHONE (Speakerphone): 14
- T** Talking alarm clock: 24
 Talking battery alert: 10
 Talking Call Display: 28
 Temporary tone dialing: 16
 Time adjustment: 22
 Transferring calls: 40
 Troubleshooting: 44
- V** Visual Call Waiting: 15
 VM (Voice Mail): 38
 Voice guidance language: 13
 Voice Mail: 36, 38
 Volume
 Receiver: 14
 Ringer (Base unit): 15
 Ringer (Handset): 15, 21
 Speaker: 14
- W** Wall mounting: 41

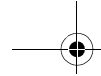

For your future reference

We recommend keeping a record of the following information to assist with any repair under warranty.

Serial No.

Date of purchase

(found on the bottom of the base unit)

Name and address of dealer

Attach your purchase receipt here.

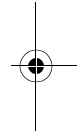
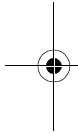

Panasonic Canada Inc.

5770 Ambler Drive, Mississauga, Ontario L4W 2T3

Copyright:

This material is copyrighted by Panasonic Communications Co., Ltd., and may be reproduced for internal use only. All other reproduction, in whole or in part, is prohibited without the written consent of Panasonic Communications Co., Ltd.

© Panasonic Communications Co., Ltd. 2008



TG6411C

PNQX1625ZA CC1208DC0

