

Panasonic®

Operating Instructions

5.8 GHz Expandable Digital Cordless Phone

Model No. **KX-TG6021C**

with 2 Handsets

Model No. **KX-TG6022C**

with 3 Handsets

Model No. **KX-TG6023C**

5.8 GHz Expandable Digital Cordless Answering System

Model No. **KX-TG6031C**

Model No. **KX-TG6051C**

with 2 Handsets

Model No. **KX-TG6032C**

Model No. **KX-TG6052C**

with 3 Handsets

Model No. **KX-TG6033C**

Model No. **KX-TG6053C**

5.8 GHz Digital Cordless Answering System

with 4 Handsets

Model No. **KX-TG6034C**

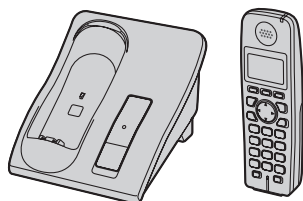

Model shown is KX-TG6021C.

This unit is compatible with Call Display. To use this feature, you must subscribe to the appropriate service offered by your telephone service provider.

Charge the handset battery for 7 hours before initial use.

Please read these Operating Instructions before using the unit and save for future reference.

For assistance, please call **1-800-561-5505** or visit us at **www.panasonic.ca**

Table of Contents

Introduction	
Product information	3
Accessory information	5
Important safety instructions	7
For best performance	9
Preparation	
Setting up the base unit	10
Setting up the handset	10
Controls	13
Display	14
Setting the unit before use	15
Making/Answering Calls	
Making calls	17
Answering calls	18
Useful features during a call	18
Phonebook	
Handset phonebook	21
Copying handset phonebook items	22
Call Display Service	
Using Call Display service	23
Caller list	26
Programming	
Programmable settings	27
Answering System	
Answering system	33
Turning the answering system on/off	33
Greeting message	34
Listening to messages using the base unit	34
Listening to messages using the handset	35
Remote operation	36
Answering system settings	37
Voice Mail Service	
Using Voice Mail service	39
Multi-unit Operation	
Intercom	41
Transferring calls between handsets, conference calls	42
Registering a handset	42
Useful Information	
Wall mounting	43
Headset (optional)	44
Lanyard/strap eyelet	44
Error messages	45
Troubleshooting	46
Important information	51
Specifications	53
Warranty	54
Index	
Index	55

Introduction

Product information

Thank you for purchasing a Panasonic cordless telephone.

These operating instructions can be used for the following models:

KX-TG6021

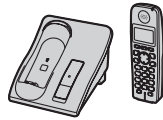

KX-TG6022



KX-TG6023



KX-TG6031/KX-TG6051

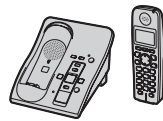

KX-TG6032/KX-TG6052



KX-TG6033/KX-TG6053



KX-TG6034



Important:

- The suffix (C) in the following model numbers will be omitted in these instructions:





KX-TG6021C/KX-TG6022C/KX-TG6023C

KX-TG6031C/KX-TG6032C/KX-TG6033C/KX-TG6034C

KX-TG6051C/KX-TG6052C/KX-TG6053C

Introduction

Notable feature differences among the following models

Model no.	Answering system	Talking Call Display	Slow talk®	Intercom	
				 ↔  *1	 ↔  *2
KX-TG6021	–	–	–	–	–*3
KX-TG6022	–	–	–	–	●
KX-TG6023	–	–	–	–	●
KX-TG6031	●	–	●	●	–*3
KX-TG6032	●	–	●	●	●
KX-TG6033	●	–	●	●	●
KX-TG6034	●	–	●	●	●
KX-TG6051	●	●	●	●	–*3
KX-TG6052	●	●	●	●	●
KX-TG6053	●	●	●	●	●

*1 Intercom calls can be made between the handset and base unit.

*2 Intercom calls can be made between the handsets.

*3 Intercom calls can be made between the handsets by purchasing and registering 1 or more optional handsets (KX-TGA601C, page 6).

Special features

■ Handset voice enhancer

This feature clarifies the voice of the person you are talking to, reproducing a more natural-sounding voice that is easier to hear and understand (page 19).

■ Talking Call Display*1

This feature allows the handset to announce the displayed caller name or phone number when a call is received (page 23).

■ Slow Talk*2

You can slow down the voice of the person you are talking to, making it easier to hear and understand (page 20).

SlowTalk

*1 KX-TG6051/KX-TG6052/KX-TG6053

*2 KX-TG6031/KX-TG6032/KX-TG6033/KX-TG6034/KX-TG6051/KX-TG6052/
KX-TG6053

Introduction

Accessory information

Included accessories

No.	Accessory item	Quantity			
		KX-TG6021/ KX-TG6031/ KX-TG6051	KX-TG6022/ KX-TG6032/ KX-TG6052	KX-TG6023/ KX-TG6033/ KX-TG6053	KX-TG6034
①	AC adaptor for base unit	1	1	1	1
②	Telephone line cord	1	1	1	1
③	Wall mounting adaptor	1	1	1	1
④	Battery	1	2	3	4
⑤	Handset cover*1	1	2	3	4
⑥	Charger	–	1	2	3
⑦	AC adaptor for charger	–	1	2	3

*1 The handset cover comes attached to the handset.

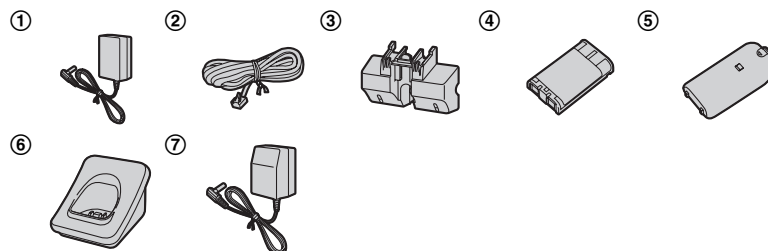

Introduction

Expanding your phone system

You can expand the phone system by registering optional handsets to a single base unit.

- A maximum of 4 total handsets (included and optional) can be registered to a single base unit.
- KX-TG6034:
An additional handset cannot be registered.

Handset (optional): KX-TGA601C



Additional/replacement accessories

Accessory item	Order number
Rechargeable nickel metal hydride (Ni-MH) battery	HHR-P107
Accessory handset with charger	KX-TGA601C
Headset	RP-TCA86, RP-TCA91, RP-TCA92, RP-TCA94, or RP-TCA95

Introduction

Important safety instructions

When using the product, basic safety precautions should always be followed to reduce the risk of fire, electric shock, or personal injury.

1. Read all instructions carefully.
2. Follow all warnings and instructions marked on the product.
3. Unplug the product from power outlets before cleaning. Do not use liquid or aerosol cleaners. Use a moist cloth for cleaning.
4. Do not use the product near water, for example near a bathtub, wash bowl, kitchen sink, etc.
5. Place the product securely on a stable surface. Serious damage and/or injury may result if the product falls.
6. Do not cover slots and openings on the product. They are provided for ventilation and protection against overheating. Never place the product near radiators, or in a place where proper ventilation is not provided.
7. Use only the power source marked on the product. If you are not sure of the type of power supplied to your home, consult your dealer or local power company.
8. Do not place objects on the power cord. Install the product where no one can step or trip on the cord.
9. Do not overload power outlets and extension cords. This can result in the risk of fire or electric shock.
10. Never push any objects through slots in the product. This may result in the risk of fire or electric shock. Never spill any liquid on the product.
11. To reduce the risk of electric shock, do not disassemble the product. Take the product to an authorized service centre when service is required. Opening or removing covers may expose you to dangerous voltages or other risks. Incorrect reassembly can cause electric shock when the product is subsequently used.
12. Unplug the product from power outlets and take to an authorized service centre when the following conditions occur:
 - A. When the power cord is damaged or frayed.
 - B. If liquid has been spilled into the product.
 - C. If the product has been exposed to rain or water.
 - D. If the product does not work normally by following the operating instructions. Adjust only controls covered by the operating instructions. Improper adjustment may require extensive work by an authorized service centre.
 - E. If the product has been dropped or physically damaged.
 - F. If the product exhibits a distinct change in performance.
13. During thunderstorms, avoid using telephones except cordless types. There may be a remote risk of an electric shock from lightning.
14. Do not use the product to report a gas leak, when in the vicinity of the leak.

**SAVE THESE
INSTRUCTIONS**

Introduction

WARNING:

- To prevent the risk of fire or electrical shock, do not expose the product to rain or any type of moisture.
- Unplug the product from power outlets if it emits smoke, an abnormal smell, or makes an unusual noise. These conditions can cause fire or electric shock. Confirm that smoke has stopped emitting and contact an authorized service centre.
- Do not spill liquids (detergents, cleansers, etc.) onto the telephone line cord plug, or allow it to become wet at all. This may cause a fire. If the telephone line cord plug becomes wet, immediately pull it from the telephone wall jack, and do not use.
- Do not place or use this product near automatically controlled devices such as automatic doors and fire alarms. Radio waves emitted from this product may cause such devices to malfunction resulting in an accident.
- Completely insert the AC adaptor/power plug into the power outlet. Failure to do so may cause electric shock and/or excessive heat resulting in a fire.
- Regularly remove any dust, etc. from the AC adaptor/power plug by pulling it from the power outlet, then wiping with a dry cloth. Accumulated dust may cause an insulation defect from moisture, etc. resulting in a fire.

CAUTION:

Installation

- Never install telephone wiring during a lightning storm.
- Never install telephone line jacks in wet locations unless the jack is specifically designed for wet locations.

- Never touch uninsulated telephone wires or terminals unless the telephone line has been disconnected at the network interface.
- Use caution when installing or modifying telephone lines.
- Do not touch the plug with wet hands.
- The AC adaptor is used as the main disconnect device. Ensure that the AC outlet is installed near the product and is easily accessible.

Battery

To reduce the risk of fire or injury to persons, read and follow these instructions.

- Use only the battery(ies) specified.
- Do not dispose of the battery(ies) in a fire. They may explode. Check with local waste management codes for special disposal instructions.
- Do not open or mutilate the battery(ies). Released electrolyte is corrosive and may cause burns or injury to the eyes or skin. The electrolyte may be toxic if swallowed.
- Exercise care when handling the battery(ies). Do not allow conductive materials such as rings, bracelets or keys to touch the battery(ies), otherwise a short circuit may cause the battery(ies) and/or the conductive material to overheat and cause burns.
- Charge the battery(ies) provided, or identified for use with the product only, in accordance with the instructions and limitations specified in this manual.

Medical

- Consult the manufacturer of any personal medical devices, such as pacemakers or hearing aids, to determine if they are adequately

Introduction

shielded from external RF (radio frequency) energy. (The product operates in the frequency range of 5.76 GHz to 5.84 GHz, and the power output is 200 mW (max.)) Do not use the product in health care facilities if any regulations posted in the area instruct you not to do so. Hospitals or health care facilities may be using equipment that could be sensitive to external RF energy.

For best performance

Base unit location/avoiding noise

The base unit and other compatible Panasonic units use radio waves to communicate with each other.

- For maximum coverage and noise-free communications, place your base unit:
 - at a convenient, high, and central location with no obstructions between the handset and base unit in an indoor environment.
 - away from electronic appliances such as TVs, radios, personal computers, wireless devices or other phones.
 - avoid facing radio frequency transmitters, such as external antennas of mobile phone cell stations (avoid putting the base unit on a bay window or near a window).
- Coverage and voice quality depends on the local environmental conditions.
- If the reception for a base unit location is not satisfactory, move the base unit to another location for better reception.

Environment

- Keep the product away from electrical noise generating devices, such as fluorescent lamps and motors.
- The product should be kept free from excessive smoke, dust, high temperature, and vibration.
- The product should not be exposed to direct sunlight.
- Do not place heavy objects on top of the product.
- When you leave the product unused for a long period of time, unplug the product from the power outlet.
- The product should be kept away from heat sources such as heaters, kitchen stoves, etc. It should not be placed in rooms where the temperature is less than 5 °C (41 °F) or greater than 40 °C (104 °F). Damp basements should also be avoided.
- The maximum calling distance may be shortened when the product is used in the following places: Near obstacles such as hills, tunnels, underground, near metal objects such as wire fences, etc.
- Operating the product near electrical appliances may cause interference. Move away from the electrical appliances.

Routine care

- Wipe the outer surface of the product with a soft moist cloth. Do not use benzine, thinner, or any abrasive powder.

Preparation

Setting up the base unit

Connecting the AC adaptor and telephone line cord

Connect the telephone line cord until it clicks into the base unit and telephone line jack (1). Connect the AC adaptor cord (2) by pressing the plug firmly (3).

- Use only the included Panasonic AC adaptor PQLV203.

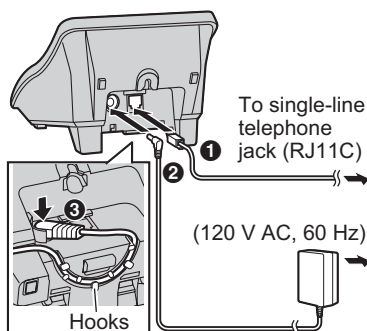

Note:

- The AC adaptor must remain connected at all times. (It is normal for the adaptor to feel warm during use.)
- The AC adaptor should be connected to a vertically oriented or floor-mounted AC outlet. Do not connect the AC adaptor to a ceiling-mounted AC outlet, as the weight of the adaptor may cause it to become disconnected.
- The unit will not work during a power failure. We recommend connecting a corded telephone to the same telephone line or to the same telephone line jack using a T-adaptor.

If you subscribe to a DSL service

Please attach a noise filter (contact your DSL provider) to the telephone line between the base unit and the telephone line jack in the event of the following:

- Noise is heard during conversations.
- Call Display features do not function properly.

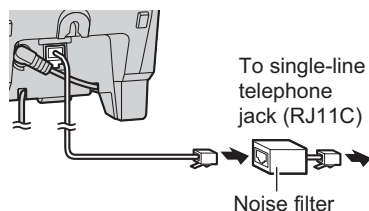

Setting up the handset

Connecting the AC adaptor

Available model:

KX-TG6022/KX-TG6023/KX-TG6032/
KX-TG6033/KX-TG6034/KX-TG6052/
KX-TG6053

- Use only the included Panasonic AC adaptor PQLV208.

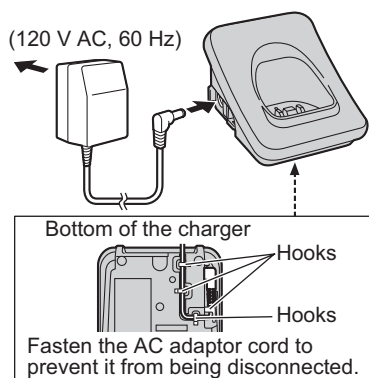

Preparation

Battery installation/ replacement

- 1 Press the notch of the handset cover firmly, and slide it in the direction of the arrow.
 - If necessary, remove the old battery.

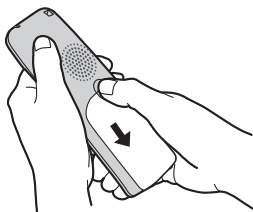

- 2 Insert the battery (1), and press it down until it snaps into position (2). Then close the handset cover (3, 4).

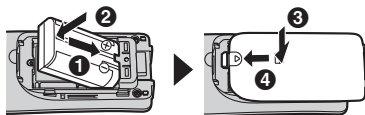

Important:

- Use only the rechargeable Panasonic battery noted on page 6.

Attention:



A nickel metal hydride battery that is recyclable powers the product you have purchased. Please call 1-800-8-BATTERY (1-800-822-8837) for information on how to recycle this battery.

Battery charge

Place the handset on the base unit or charger for **7 hours** before initial use.

- While charging, "Charging" is displayed and the charge indicator on the handset lights in amber. When the battery is fully charged, "Charge completed" is displayed and the indicator lights in green.

Base unit:

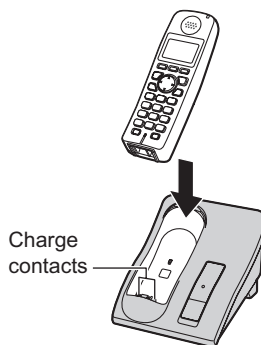

- Model shown is KX-TG6021.

Charger:

Available model:

KX-TG6022/KX-TG6023/KX-TG6032/
KX-TG6033/KX-TG6034/KX-TG6052/
KX-TG6053

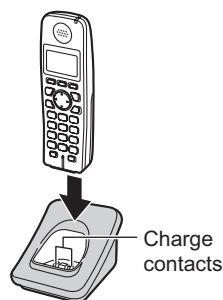





Preparation

Note:

- If you want to use the handset immediately, charge the battery for at least 15 minutes.
- To ensure that the battery charges properly, clean the charge contacts of the handset, base unit, and charger with a soft, dry cloth once a month. Clean more often if the unit is subject to the exposure of grease, dust, or high humidity.
- When the battery is empty, "Charge for 7h" is displayed and the charge indicator does not light for about 5 minutes to concentrate on charging.

Battery level

Battery icon	Battery level
	Fully charged
	Medium
	Low Flashing: needs to be recharged.
	Empty

Note:

- When the battery needs to be charged, the handset beeps intermittently during use.

Panasonic battery performance

Operation	Operating time
While in use (talking)	Up to 5 hours
While not in use (standby)	Up to 11 days
While using the clarity booster feature (page 19)	Up to 3 hours

Note:

- Battery operating time may be shortened over time depending on usage conditions and surrounding temperature.
- Battery power is consumed whenever the handset is off the base unit or charger, even when the handset is not in use.
- After the handset is fully charged, displaying "Charge completed", it may be left on the base unit or charger without any ill effect on the battery.
- The battery level may not be displayed correctly after you replace the battery. In this case, place the handset on the base unit or charger and let it charge for 7 hours.

Symbols used in these operating instructions

Symbol	Meaning
[] Button name/ soft key name	The words in the brackets indicate button names/soft key names on the handset and base unit. Example: Unit keys: [↶], [OFF] Soft keys: [View CID], [Phonebook]
→	Proceed to the next operation.
" "	The words in quotations indicate the menu on the display. Example: "Alarm"
Example: [▼]/[▲]: "Off"	Press [▼] or [▲] to select "off".

Preparation

Controls

Base unit (KX-TG6021/KX-TG6022/KX-TG6023)

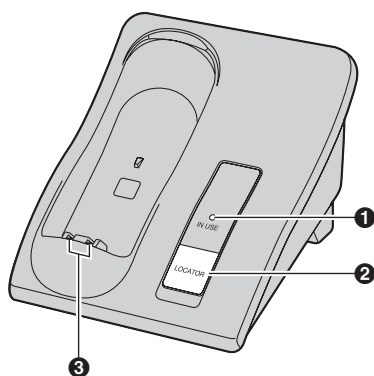

- ① IN USE indicator
- ② [LOCATOR]
- ③ Charge contacts

Base unit (KX-TG6031/KX-TG6032/KX-TG6033/KX-TG6034/KX-TG6051/KX-TG6052/KX-TG6053)

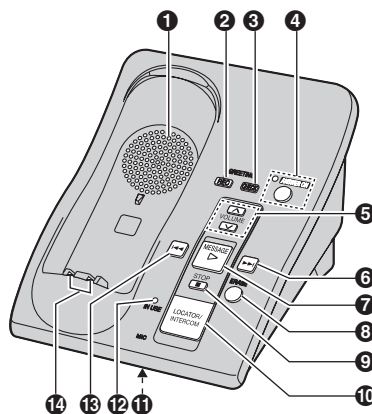

- ① Speaker
- ② [GREETING REC] (Recording)
- ③ [GREETING CHECK]
- ④ [ANSWER ON]
ANSWER ON indicator
- ⑤ VOLUME [^] [v]
- ⑥ [▶▶] (SKIP)
- ⑦ [MESSAGE]
MESSAGE indicator
- ⑧ [ERASE]
- ⑨ [STOP]
- ⑩ [LOCATOR] [INTERCOM]
- ⑪ MIC (Microphone)
- ⑫ IN USE indicator
- ⑬ [◀◀] (REPEAT)
- ⑭ Charge contacts

Preparation

Handset

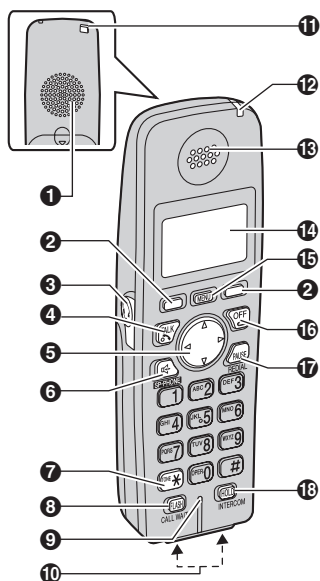

- 1 Speaker
- 2 Soft keys
- 3 Headset jack
- 4 [TALK]
- 5 Navigator key ([UP] [DOWN] [LEFT] [RIGHT])
- 6 [SP-PHONE]
- 7 [*] (TONE)
- 8 [FLASH] [CALL WAIT]
- 9 Microphone
- 10 Charge contacts
- 11 Lanyard/strap eyelet
- 12 Charge indicator
Ringer indicator
Message indicator
- 13 Receiver
- 14 Display
- 15 [MENU]
- 16 [OFF]
- 17 [PAUSE] [REDIAL]
- 18 [HOLD] [INTERCOM]

Using the navigator key

The handset navigator key can be used to navigate through menus and to select items shown on the display by pressing [UP], [DOWN], [LEFT], or [RIGHT].

Adjusting audio volume

Press [UP] or [DOWN] repeatedly while talking.

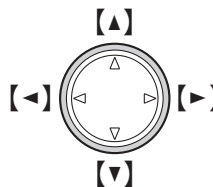

Using the soft keys

The handset features 2 soft keys. By pressing a soft key, you can select the feature shown directly above it on the display.

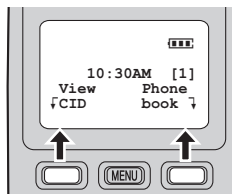

Display

Handset display items

Displayed item	Meaning
(((V)))	Voice enhancer is on.
■■■■	Battery level
Example: [1]	The handset's extension number (example shown here: handset 1)

Preparation

Setting the unit before use

Important:

- To program features by scrolling through the display menus, see page 27.

Display language

You can select either "English" or "Français" as the display language. The default setting is "English".

- [MENU]** → **[0][8]**
 KX-TG6021/KX-TG6022/
 KX-TG6023
 KX-TG6031/KX-TG6032/
 KX-TG6033/KX-TG6034/
 KX-TG6051/KX-TG6052/
 KX-TG6053
[MENU] → **[0][8][1]**
- [▼]/[▲]**: Select the desired setting.
- Press the right soft key to save. → **[OFF]**

Voice guidance language

Available model:

KX-TG6031/KX-TG6032/KX-TG6033/
 KX-TG6034/KX-TG6051/KX-TG6052/
 KX-TG6053

You can select either "English" or "Français" as the voice guidance language of the answering system. The default setting is "English".

- [MENU]** → **[0][8][2]**
- [▼]/[▲]**: Select the desired setting.
- [Save]** → **[OFF]**

Dialing mode

If you cannot make calls, change this setting according to your telephone line service. The default setting is "Tone".
 "Tone": For tone dial service.
 "Pulse": For rotary/pulse dial service.

- [MENU]** → **[0][5][1]**
- [▼]/[▲]**: Select the desired setting.
- [Save]** → **[OFF]**

Date and time

Set the correct date and time.

- To use the available alarm function (page 32).
- When you play back a message from the answering system (page 34), the unit announces the day and time it was recorded. (KX-TG6031/KX-TG6032/KX-TG6033/KX-TG6034/KX-TG6051/KX-TG6052/KX-TG6053)

- [MENU]** → **[4][1]**
- Enter the current month, day, and year by selecting 2 digits for each.
Example: August 15, 2007
[0][8] [1][5] [0][7]
- Enter the current hour and minute (12-hour clock format) by selecting 2 digits for each.
Example: 9:30
[0][9] [3][0]
- [AM/PM]**: Select "AM" or "PM".
- [Save]** → **[OFF]**

Note:

- When English is selected as the display language, 12-hour clock format is used. When French is selected, 24-hour clock format is used.
- If you make a mistake when entering the date and time, press **[◀]**, **[▶]**,

Preparation

- 【▲】, or 【▼】 to move the cursor, then make the correction.
- The date and time may be incorrect after a power failure. In this case, set the date and time again.

Making/Answering Calls

Making calls

- 1 Dial the phone number.
 - To correct a digit, press **[Clear]**.
- 2 Press **[↶]** or **[Call]**.
- 3 When you finish talking, press **[OFF]** or place the handset on the base unit or charger.

Note:

- "Line in use" is displayed when someone is talking on the handset or another phone.

Using the speakerphone

- 1 Dial the phone number, and press **[☎]**.
 - Speak alternately with the other party.
- 2 When you finish talking, press **[OFF]**.

Note:

- Use the speakerphone in a quiet environment.
- To switch to the receiver, press **[↶]**.

Adjusting the receiver/speaker volume

Press **[▲]** or **[▼]** repeatedly while talking.

Making a call using the redial list

The last 5 phone numbers dialed are stored in the redial list (each 48 digits max.).

- 1 **[REDIAL]**
- 2 **[▼]/[▲]**: Select the desired phone number.
- 3 **[↶]**

Erasing a number in the redial list

- 1 **[REDIAL]**
- 2 **[▼]/[▲]**: Select the desired phone number.
- 3 **[Erase]** → **[Yes]** → **[OFF]**

PAUSE button (for PBX/long distance service users)

A pause is sometimes required when making calls using a PBX or long distance service. When storing a calling card access number and/or PIN in the phonebook, a pause is also needed (page 22).

For example, if you need to dial the line access number "9" when making outside calls with a PBX:

- 1 **[9]** → **[PAUSE]** → Dial the phone number.
- 2 **[↶]**

Note:

- A 3.5 second pause is inserted each time **[PAUSE]** is pressed. Press repeatedly to insert longer pauses.

Making/Answering Calls

Answering calls

When a call is being received, the ringer indicator flashes rapidly.

- 1 Press [**ANS**] or [**END**].
 - You can also answer the call by pressing any dial key from [**0**] to [**9**], [*****], [**#**], or [**INTERCOM**].
(Any key talk feature)
- 2 When you finish talking, press [**OFF**].

Note:

- You can change the ringer indicator colour and the ringer tone (page 30). You can also adjust the handset ringer volume (page 30).

Auto talk

This feature allows you to answer a call by simply lifting the handset off the base unit or charger. You do not need to press [**ANS**]. To activate this feature, see page 29.

Temporary ringer off

While the handset is ringing for an outside call, you can turn the ringer off temporarily by pressing [**OFF**].

Adjusting the base unit ringer volume

Available model:

KX-TG6031/KX-TG6032/KX-TG6033/
KX-TG6034/KX-TG6051/KX-TG6052/
KX-TG6053

Press [**^**] or [**v**] repeatedly to select the desired volume.

- To turn the ringer off, press and hold [**v**] until the unit beeps 2 times.

Useful features during a call

HOLD button

This feature allows you to put an outside call on hold. Press [**HOLD**] 2 times during an outside call.

- To release the hold, press [**ANS**].
- Another handset user can take the call by pressing [**ANS**].

Note:

- If another phone is connected to the same line (page 10), you can also take the call by lifting its handset.
- If a call is kept on hold for more than 6 minutes, an alarm tone starts to sound and the ringer indicator flashes rapidly. After 4 additional minutes on hold, the call is disconnected.

Mute button

While mute is turned on, you can hear the other party, but the other party cannot hear you.

To mute your voice, press [**Mute**].

- To return to the conversation, press [**Mute**] or [**ANS**].

Note:

- When this feature is turned on, [**Mute**] flashes.
- [**Mute**] is a soft key visible on the handset display during a call.

FLASH button

Pressing [**FLASH**] allows you to use special features of your host PBX such as transferring an extension call, or accessing optional telephone services such as Call Waiting.

Making/Answering Calls

Note:

- To change the flash time, see page 30.

For Call Waiting service users

To use Call Waiting, you must subscribe to Call Waiting service of your telephone service provider.

This feature allows you to receive calls while you are already talking on the phone. If you receive a call while on the phone, you will hear a Call Waiting tone. Please contact your telephone service provider for details and availability of this service in your area.

Press **[CALL WAIT]** to answer the 2nd call.

- To switch between calls, press **[CALL WAIT]**.

Temporary tone dialing (for rotary/pulse service users)

You can temporarily switch the dialing mode to tone when you need to access touch tone services (for example, answering services, telephone banking services, etc.).

Press **[*]** (TONE) before entering access numbers which require tone dialing.

Handset clarity booster

This feature can improve sound clarity when the handset is used in an area where there may be interference.

During an outside call, this feature is turned on automatically when necessary. You can also turn this feature on or off manually.

- 1 Press **[MENU]** during an outside call.

- 2 **[v]/[^]**: Select "Booster on" or "Booster off". → **[Select]**

Note:

- When this feature is turned on, "BOOST" flashes.
- When this feature is turned off manually during a call, it does not turn on automatically during the same call.
- While this feature is turned on;
 - the battery operating time is shortened (page 12).
 - the maximum number of extensions that can be used at a time may decrease.

Handset voice enhancer

This feature clarifies the voice of the person you are talking to, reproducing a more natural-sounding voice that is easier to hear and understand (page 30).

KX-TG6021/KX-TG6022/KX-TG6023

Press **[(VE)]** during an outside call to turn this feature on or off.

KX-TG6031/KX-TG6032/KX-TG6033/

KX-TG6034/KX-TG6051/KX-TG6052/

KX-TG6053

- 1 Press **[MENU]** during an outside call.

- 2 **[v]/[^]**: Select "V.E. on" or "V.E. off". → **[Select]**

Note:

- When this feature is turned on, **[(VE)]** is displayed.
- Depending on the condition and quality of your telephone line, this feature may emphasize existing line noise. If it becomes difficult to hear, turn this feature off.

Making/Answering Calls

Slow Talk

Available model:

KX-TG6031/KX-TG6032/KX-TG6033/
KX-TG6034/KX-TG6051/KX-TG6052/
KX-TG6053

This feature works to help slow down the incoming audio when you are having a conversation with an outside party.

Important:

- You cannot use this feature when;
 - the handset announces names or phone numbers while receiving a call.
 - you are on an intercom call.
 - you are on a conference call.
 - you are listening to messages in the answering system.
 - another unit is using the answering system.
 - another handset is having an intercom call with the base unit.

To turn this feature on or off, press **[Slow]** during an outside call.

Note:

- When this feature is turned on, **[Slow]** flashes.
- This feature turns off if another handset starts to have an intercom call with the base unit, or another unit starts to use the answering system.
- **[Slow]** is a soft key visible on the handset display during a call.
- This feature turns off after you hang up the call.
- The speed may become close to normal when the handset receives constant incoming audio for a period of time.

Call share

This feature allows the handset to join an existing outside call.
To join the conversation, press **[↶]** when the other handset is on an outside call.

Note:

- The possible number of participating parties depends on the model.
 - KX-TG6021/KX-TG6022/
KX-TG6023:
 - 3 parties (including 1 outside party)
 - KX-TG6031/KX-TG6032/
KX-TG6033/KX-TG6034/
KX-TG6051/KX-TG6052/
KX-TG6053:
 - 4 parties (including 1 outside party)

Phonebook

Handset phonebook

You can add up to 50 items to the handset phonebook and search for phonebook items by name.

Adding items to the phonebook

- 1 **[Phonebook]**
- 2 **[Add]**
- 3 Enter the name (max. 16 characters). → **[Next]**
- 4 Enter the phone number (max. 32 digits). → **[Next]** → **[Save]**
 - To add other items, repeat from step 2.
- 5 **[OFF]**

Note:

- Call Display subscribers can use ringer ID and light-up ID features (page 24).

Character table for entering names

Key	Character
[1]	& ' () , - . / 1
[2]	a b c A B C 2
[3]	d e f D E F 3
[4]	g h i G H I 4
[5]	j k l J K L 5
[6]	m n o M N O 6
[7]	p q r s P Q R S 7
[8]	t u v T U V 8
[9]	w x y z W X Y Z 9
[0]	0 Space
[*]	*
[#]	#

- To enter another character that is located on the same dial key, first press **[▶]** to move the cursor to the next space.

Editing/correcting a mistake

Press **[◀]** or **[▶]** to move the cursor to the character or number you want to erase, then press **[Clear]**. Enter the appropriate character or number.

- Press and hold **[Clear]** to erase all characters or numbers.

Finding and calling a phonebook item

Searching for a name alphabetically by scrolling through all items

- 1 **[Phonebook]** → **[Search]**
- 2 **[▼]/[▲]**: Select the desired item.
- 3 Press **[↵]** to dial the phone number.

Searching for a name by initial

- 1 **[Phonebook]** → **[Search]**
- 2 Press the dial key (**[0]** – **[9]**, **[*]**, or **[#]**) that corresponds to the first letter you are searching for (see the character table, page 21).

Example: "LISA"

Press **[5]** repeatedly to display the first phonebook entry starting with the initial "L" and go to step 3.

- If there is no item corresponding to the letter you selected, the next item is displayed.

- 3 Press **[▼]** to select the desired item.
- 4 Press **[↵]** to dial the phone number.

Phonebook

Editing items in the phonebook

- 1 Find the desired item (page 21). → **[Option]**
- 2 **[▼]/[▲]**: "Edit" → **[Select]**
- 3 Edit the name if necessary (see the character table, page 21). → **[Next]**
- 4 Edit the phone number if necessary. → **[Next]** → **[Save]** → **[OFF]**

Erasing items in the phonebook

- 1 Find the desired item (page 21).
- 2 **[Erase]** → **[Yes]** → **[OFF]**

Chain dial

This feature allows you to dial phone numbers in the handset phonebook while you are on a call. This feature can be used, for example, to dial a calling card access number or bank account PIN that you have stored in the handset phonebook, without having to dial manually.

- 1 During an outside call, press **[MENU]**.
- 2 **[▼]/[▲]**: "Phonebook" → **[Select]**
- 3 Find the desired item (page 21). → **[Call]**

Note:

- When storing a calling card access number and your PIN in the phonebook as one phonebook item, press **[PAUSE]** to add pauses after the number and PIN as necessary (page 17).
- If you have rotary/pulse service, you need to press **[*]** before pressing

[MENU] in step 1 to change the dialing mode temporarily to tone.

Copying handset phonebook items

You can copy one or all of the phonebook items from one handset to another.

Important:

- Ringer ID and light-up ID for phonebook items are not copied.

Copying an item

- 1 **[MENU]** → **[#][1]**
- 2 **[▼]/[▲]**: Select the handset to copy to. → **[Next]**
- 3 **[▼]/[▲]**: Select the desired item. → **[Send]**
- 4 Press **[OFF]** after the long beep.

Copying all items

- 1 **[MENU]** → **[#][2]**
- 2 **[▼]/[▲]**: Select the handset to copy to. → **[Send]**
- 3 Press **[OFF]** after the long beep.

Call Display Service

Using Call Display service

This unit is Call Display compatible. To use Call Display features, you must subscribe to Call Display service of your telephone service provider.

Call Display features

When an outside call is being received, the calling party's name and phone number are displayed.

Caller information for the last 50 callers is logged in the caller list by the most recent call to the oldest.

- Generally caller information is displayed from the 2nd ring.
- If the unit cannot receive caller information, the following is displayed:
 - “**Unavailable Name & No.**”/ “**Unavailable**”^{*1}: The caller dialed from an area which does not provide Call Display service.
 - “**Private caller**”: The caller requested not to send caller information.
 - “**Long distance**”: The caller called you long distance.
- If the unit is connected to a PBX system, caller information may not be received properly. Consult your PBX supplier.

*1 Shown while viewing the caller list.

Missed calls

If a call is not answered, the unit treats the call as a missed call. You can view the number of missed calls by pressing **[View CID]**.

Custom name display

When the Call Display number is received and it matches a phone number stored in the phonebook, the stored name from the phonebook is displayed and logged in the caller list.

Talking Call Display

Available model:

KX-TG6051/KX-TG6052/KX-TG6053

This feature lets you know who is calling without looking at the display. When a call comes in, the handset and base unit announce the caller's name or phone number displayed on the handset following every ring.

To use this feature, you must subscribe to Call Display service of your telephone service provider.

- If the caller's phone number is stored in the phonebook of the handset 1 (extension No. 1), all handsets and the base unit announce the name stored in handset 1 phonebook. If handset 1 does not have a link to the base unit (battery is empty, for instance), remaining handsets and the base unit announce the Call Display name or number received from the telephone service provider.
- Name pronunciation may vary. This feature may not pronounce all names correctly.
- Call Display supports names of up to 15 letters. If the caller's name has more than 15 letters, the name is not displayed or announced correctly.
- Usually the unit announces the caller's name after the 2nd ring. If you turn on the answering system and set the ring count to “2” (page 37), the unit does not announce the caller's name. If “**To11 saver**” is selected

Call Display Service

and there is a new message, the unit does not announce the caller's name.

- When you receive a call while on the phone, the 2nd caller's name is not announced even if you subscribe to both Call Display and Visual Call Waiting services.
- The announcement is heard at the ringer volume (page 18, 30).
- This feature can be turned on or off (page 31).

Ringer ID/Light-up ID

This feature can help you identify who is calling by using different ringers and ringer indicator colours for different callers stored in the phonebook. You can assign a different ringer and indicator colour to each phonebook item. When a call is received from a caller stored in the phonebook, the assigned ringer rings and the assigned ringer indicator colour flashes after caller information is displayed.

If you select "No Ringer ID" (default) or "No Light-up ID" (default), the handset uses the ringer tone or ringer indicator colour you selected on page 30 when a call is received from that caller.

- 1 Find the desired item (page 21). → **[Option]**
- 2 To assign a ringer:
[v]/[▲]: Select "Ringer ID". → **[Select]**
To assign a ringer indicator colour:
[v]/[▲]: Select "Light-up ID". → **[Select]**
- 3 **[v]/[▲]**: Select the desired setting.
- 4 **[Save]** → **[OFF]**

Visual Call Waiting service

If you subscribe to both Call Display and Visual Call Waiting services, the 2nd caller's information is displayed after you hear a Call Waiting tone (page 19). Please contact your telephone service provider for details and availability of this service in your area.

For Call Waiting Deluxe service users

To use Call Waiting Deluxe, you must subscribe to Call Waiting Deluxe service of your telephone service provider.

This feature not only allows your handset to display the 2nd caller's information, but also offers you a variety of ways to deal with the 2nd call.

Important:

- Please contact your telephone service provider for details and availability of this service in your area.
- This feature must be turned on before it can be used.

To turn Call Waiting Deluxe on/off

To use Call Waiting Deluxe, you must turn this feature on. The default setting is "off".

- 1 **[MENU]** → **[0][5][4]**
- 2 **[v]/[▲]**: Select the desired setting.
- 3 **[Save]** → **[OFF]**

Call Waiting Deluxe service options

When a 2nd call is received, you can choose how to handle the call by selecting an option shown on the handset display.

Note:

- Your telephone service provider may not offer all of the options (page 25).

Call Display Service

Displayed option	Function
Answer	Answers the waiting call, while keeping the 1st call on hold.
Hold	Holds the waiting call. The caller will hear the prerecorded hold message played by your telephone service provider.
Announcement	The caller will hear the prerecorded busy message played by your telephone service provider (for example, "We are not available now.") and will then be disconnected.
Forward	Forwards the waiting call to the Voice Mail service provided by your telephone service provider. You must subscribe to Voice Mail service to use this function.
Drop	Disconnects (drops) the current call and answers the waiting call.

Displayed option	Function
Conference	Answers the waiting call and combines it with the current call to make a conference call (3-party call).
Return	Returns to the waiting caller while keeping the current call on hold.
Drop caller1	Disconnects (drops) the 1st call during a conference call.
Drop caller2	Disconnects (drops) the 2nd call during a conference call.

To use Call Waiting Deluxe service

- 1** When you hear a Call Waiting tone during an outside call, press **[FLASH]**.
 - The option menu is displayed.
- 2** **[▼]/[▲]**: Select the desired option.
 - **[Select]**
 - After selecting "Answer", "Hold", or "Conference", you can select another option. → **[FLASH]** → **[▼]/[▲]**: Select the desired option.
 - **[Select]**

Note:

- To exit from the option menu, wait for 20 seconds.

Call Display Service

Caller list

Viewing the caller list and calling back

- 1 **[View CID]**
- 2 Press **[v]** to search from the most recent call, or **[^]** to search from the oldest call.
- 3 To call back, press **[↶]**.
To exit, press **[OFF]**.

Note:

- Each handset has its own caller list. The number of missed calls may differ between handsets. Even if you viewed the caller list or answered a call on one handset, the same information is still recognized as a missed call in the other handsets.
- A ✓ is displayed in caller information which has already been viewed or answered.

Editing a caller's phone number before calling back

You can edit a phone number in the caller list by adding the long distance code "1" or removing its area code.

- 1 **[View CID]**
- 2 **[v]/[^]**: Select the desired item. → **[Select]**
- 3 Press **[Edit]** repeatedly until the phone number is shown in the desired format.

- ① 1 – Area code – Local phone number

Example:

1-555-321-5555

- ② Local phone number

Example:

321-5555

- ③ Area code – Local phone number

Example:

555-321-5555

4 **[↶]**

Note:

- The number edited in step 3 will not be saved in the caller list.

Storing caller information into the phonebook

- 1 **[View CID]**
- 2 **[v]/[^]**: Select the desired item. → **[Select]**
 - To edit the number, press **[Edit]** repeatedly until the phone number is shown in the desired format.
- 3 **[Save]**
 - If there is name information for the caller, skip to step 5.
- 4 Enter the name (see the character table, page 21). → **[Next]** → **[Save]**
- 5 **[OFF]**

Erasing selected caller information

- 1 **[View CID]**
- 2 **[v]/[^]**: Select the desired item.
- 3 **[Erase]** → **[Yes]** → **[OFF]**

Erasing all caller information

- 1 **[View CID]**
- 2 **[All erase]** → **[Yes]**

Programming

Programmable settings

You can customize the unit by programming the following features using the handset.

To access the features, there are 2 methods:

- scrolling through the display menus (page 27)
- using the direct commands (page 29)
- Mainly the direct command method is used in these operating instructions.

Programming by scrolling through the display menus

1 [MENU]

2 Press [▼] or [▲] to select the desired menu. → [Select]

- If there is a sub-menu(s), press [▼] or [▲] to select the desired item. → [Select]

3 Press [▼] or [▲] to select the desired setting. → [Save]

- This step may vary depending on the feature being programmed.

4 [OFF]

Main menu	Sub-menu 1	Sub-menu 2	Page
Message play (KX-TG6031/ KX-TG6032/ KX-TG6033/ KX-TG6034/ KX-TG6051/ KX-TG6052/ KX-TG6053)	-	-	35
V.M. access	-	-	40
Alarm	-	-	32
Ringer setting	Ringer volume	-	-
	Ringer tone	-	-
	Ring colour	-	-
Set date & time	Date and time ^{*1}	-	15
	Time adjustment ^{*1}	-	-
Voice enhancer	-	-	19
Copy phonebook	Copy 1 item	-	22
	Copy all items	-	22

Programming

Main menu	Sub-menu 1	Sub-menu 2	Page
Talking CallerID (KX-TG6051/ KX-TG6052/ KX-TG6053)	-	-	23
Customer support	-	-	32
Initial setting	Set answering (KX-TG6031/ KX-TG6032/ KX-TG6033/ KX-TG6034/ KX-TG6051/ KX-TG6052/ KX-TG6053)	Ring count ^{*1}	37
		Recording time ^{*1}	38
		Remote code ^{*1}	37
	Voice Mail	Store VM access# ^{*1}	39
		VM tone detect ^{*1}	39
	Message alert	-	38, 40
	LCD contrast	-	-
	Key tone	-	-
	Auto talk	-	18
	Set tel line	Set dial mode ^{*1}	15
		Set flash time ^{*1}	18
		Set line mode ^{*1}	-
		C.WTG options ^{*1}	24
	Set base unit (KX-TG6031/ KX-TG6032/ KX-TG6033/ KX-TG6034/ KX-TG6051/ KX-TG6052/ KX-TG6053)	Ringer tone ^{*1}	-
Talking CallerID ^{*1} (KX-TG6051/ KX-TG6052/ KX-TG6053)		23	
Registration	HS registration	42	
	Deregistration	42	
Change language	Display	15	

Programming

Main menu	Sub-menu 1	Sub-menu 2	Page
Initial setting	Change language	Voice prompt* ¹ (KX-TG6031/ KX-TG6032/ KX-TG6033/ KX-TG6034/ KX-TG6051/ KX-TG6052/ KX-TG6053)	15

*1 If you program these settings using one of the handsets, you do not need to program the same item using another handset.

Programming using the direct commands

1 [MENU]

2 Enter the desired feature code.

3 Enter the desired setting code. → **[Save]**

- This step may vary depending on the feature being programmed.

4 [OFF]

Note:

- In the following table, < > indicates the default setting.
- If you make a mistake or enter the wrong code, press **[OFF]**, then start again from step 1.

Feature	Feature code	Setting code	System setting* ¹	Page
Alarm	[8]	[1]: Once [0]: <Off>	–	32
Auto talk* ²	[0][3]	[1]: On [0]: <Off>	–	18
Copy phonebook (1 item)	[*][1]	–	–	22
Copy phonebook (all items)	[*][2]	–	–	22
C.WTG options (Call Waiting options)	[0][5][4]	[1]: On [0]: <Off>	●	24
Date and time	[4][1]	–	●	15
Deregistration	[0][0][2]	–	–	42
HS registration	[0][0][1]	–	–	42

Programming

Feature	Feature code	Setting code	System setting* ¹	Page
Key tone* ³	[0][2]	[1]: <On> [0]: Off	–	–
LCD contrast (Display contrast)	[0][1]	[1]–[6]: Level 1–6 <3>	–	–
Message alert	[0][†]	[1]: On [0]: <Off>	–	38, 40
Ring colour (Ringer indicator colour)	[1][4]	[1]: <Colour1>=Amber [2]: Colour2=Green [3]: Colour3=Red [4]: Multicolour	–	–
Ringer tone* ⁴ (Handset)	[1][2]	[1]–[3]: Tone <1>–3 [4]–[7]: Melody 1–4	–	–
Ringer volume (Handset)	[1][1]	[1]: Low [2]: Medium [3]: <High> [0]: Off	–	–
Set dial mode	[0][5][1]	[1]: Pulse [2]: <Tone>	●	15
Set flash time* ⁵	[0][5][2]	[1]: <700ms> [2]: 600ms [3]: 400ms [4]: 300ms [5]: 250ms [6]: 110ms [7]: 100ms [8]: 90ms	●	18
Set line mode* ⁶	[0][5][3]	[1]: A [2]: 	●	–
Store VM access#	[0][7][1]	–	●	39
Time adjustment* ⁷ (Call Display subscribers only)	[4][2]	[1]: <Caller ID[auto]> [0]: Manual	●	–
V.M. access	[3]	–	–	40
VM tone detect	[0][7][2]	[1]: <On> [0]: Off	●	39
Voice enhancer	[5]	[1]: On [0]: <Off>	–	19

KX-TG6021/KX-TG6022/KX-TG6023 only

Feature	Feature code	Setting code	System setting* ¹	Page
Change language (Display language)	[0][8]	[1]: <English> [2]: Français	–	15

Programming

KX-TG6031/KX-TG6032/KX-TG6033/KX-TG6034/KX-TG6051/KX-TG6052/ KX-TG6053 only

Feature	Feature code	Setting code	System setting* ¹	Page
Display (Change language)	[0][8][1]	[1]: <English> [2]: Français	-	15
Message play	[2]	-	-	35
Recording time	[0][6][2]	[1]: 1min [2]: 2min [3]: <3min>	●	38
Remote code	[0][6][3]	Default: 11	●	37
Ring count	[0][6][1]	[2]-[7]: 2-7 rings <4> [0]: Toll saver	●	37
Ringer tone (Base unit)	[0][*][1]	[1]-[3]: Tone <1>-3	●	-
Talking CallerID* ⁸ (Handset)	[9]	[1]: <On> [0]: Off	-	23
Talking CallerID* ⁸ (Base unit)	[0][*][4]	[1]: <On> [0]: Off	●	23
Voice prompt (Change language)	[0][8][2]	[1]: <English> [2]: Français	●	15

*1 If "System setting" column is checked, you do not need to program the same item using another handset.

*2 If you subscribe to Call Display service and want to view the caller's information after lifting up the handset to answer a call, turn off this feature.

*3 Turn this feature off if you prefer not to hear key tones while you are dialing or pressing any keys, including confirmation tones and error tones.

*4 If you subscribe to a distinctive ring service, select a tone (tone 1 to 3). If you select a melody, you cannot distinguish lines by their ringers.

*5 The flash time depends on your telephone exchange or host PBX. Consult your PBX supplier if necessary.

*6 Generally, the line mode setting should not be adjusted. If "Line in use" is not displayed when another phone connected to the same line is in use, you need to change the line mode to "A".

*7 This feature allows the unit to automatically adjust the date and time setting when caller information is received. To use this feature, set the date and time first.

*8 KX-TG6051/KX-TG6052/KX-TG6053

Programming

Alarm

An alarm will sound once for 3 minutes at the set time.

Set the date and time beforehand (page 15).

- 1 **[MENU]** → **[8]**
- 2 **[▼]/[▲]**: "Once" → **[Select]**
 - To turn off the alarm, select "off". → **[Select]** → **[OFF]**
- 3 Set the desired date and time. → **[Save]**
- 4 **[▼]/[▲]**: Select the desired ringer tone. → **[Save]**
 - We recommend selecting a different ringer tone from outside call.
- 5 **[OFF]**

Note:

- To stop the alarm, press any dial key or place the handset on the base unit or charger.
- When the handset is in use, the alarm will not sound until the handset is in standby mode.

Customer support

The handset can display the Internet address where you can download the operating instructions or get further information for this product using your computer.

[MENU] → **[▼]/[▲]**: "Customer support" → **[Select]** → **[OFF]**

Answering System

Answering system

Available model:

KX-TG6031/KX-TG6032/KX-TG6033/
KX-TG6034/KX-TG6051/KX-TG6052/
KX-TG6053

This unit contains an answering system which can answer and record calls for you when you are unavailable to answer the phone.

Important:

- Only 1 person can access the answering system at a time.
- When callers leave messages, the unit records the day and time of each message. Make sure the date and time have been correctly set (page 15).

Memory capacity

The total recording capacity (including your greeting message) is:

- about 10 minutes for KX-TG6031/
KX-TG6032/KX-TG6033/KX-TG6034
- about 16 minutes for KX-TG6051/
KX-TG6052/KX-TG6053

A maximum of 64 messages can be recorded.

- If the message memory becomes full, the ANSWER ON indicator flashes rapidly (if the answering system is turned on). Erase unnecessary messages (page 34).
- When the message memory becomes full, the greeting message is different depending on your situation:
 - If you use the prerecorded greeting message, the unit automatically switches to another prerecorded greeting message asking callers to call again later.

- If you recorded your own greeting message, the same message is still announced to callers even though their messages are not recorded.

Turning the answering system on/off

Press [**ANSWER ON**] to turn on/off the answering system.

- When the answering system is turned on, the ANSWER ON indicator lights.
- When the answering system is turned off, the ANSWER ON indicator turns off.

Screening calls

While a caller is leaving a message, you can listen to the call through the base unit's speaker. To adjust the speaker volume, press [**^**] or [**v**] repeatedly. You can answer the call by pressing [**hook**] on the handset.

Turning off the call screening feature

When the base unit is not in use, press [**GREETING CHECK**], then press and hold [**v**] until the base unit beeps.

OR

While screening a call, press and hold [**v**] until the sound goes off.

Note:

- If you adjust the speaker volume while listening to messages or talking on the intercom, the speaker volume for call screening is turned on again.

Answering System

Greeting message

When the unit answers a call, callers are greeted by a greeting message. You can record your own greeting message or use a prerecorded greeting message.

Recording your greeting message

You can record your own greeting message (max. 2 minutes). If you do not record a greeting message, a prerecorded greeting message is used.

- 1 **[GREETING REC]**
- 2 Within 10 seconds, press **[GREETING REC]** again.
- 3 After the base unit beeps, speak clearly about 20 cm (8 inches) away from the MIC.
- 4 To stop recording, press **[STOP]**.

Using a prerecorded greeting message

If you erase or do not record your own greeting message, the unit plays a prerecorded greeting message for callers and ask them to leave messages.

Playing back the greeting message

Press **[GREETING CHECK]**.

Erasing your greeting message

Press **[GREETING CHECK]**, and then press **[ERASE]** while your greeting message is playing.

Listening to messages using the base unit

When new messages have been recorded, the MESSAGE indicator on the base unit flashes.

Press **[MESSAGE]**.

- The base unit plays new messages.
- When you have no new messages, the base unit plays back all messages.

Operating the answering system

Key	Operation
[^] or [v]	Adjust the speaker volume
[<<]	Repeat message (during playback) *1
[>>]	Skip message (during playback)
[STOP]	Pause message – To resume playback, press [MESSAGE] . – To stop playback completely, press [STOP] again.
[ERASE]	Erase message currently playing

*1 If pressed within the first 5 seconds of a message, the previous message is played.

Erasing all messages

Press **[ERASE]** 2 times while the unit is not being used.

Answering System

Listening to messages using the handset

When new messages have been recorded:

- "New message" is displayed.
- The message indicator on the handset flashes slowly if the message alert feature is turned on (page 38).

1 [MENU]

2 [▼]/[▲]: "Message play" → [Select]

- The handset plays new messages.
- When you have no new messages, the handset plays back all messages.

3 When finished, press **[OFF]**.

Note:

- To switch to the receiver, press **[↶]**.

Voice guidance

If you do not press any buttons after the last message is played back, the handset's voice guidance starts. Operate the answering system by following the guidance as necessary.

Calling back (Call Display subscribers only)

If caller information was received for the call, you can call the caller back while listening to the message.

- 1** Press **[Select]** during playback.
 - To edit the number before calling back, press **[Edit]** repeatedly to select the desired format (page 26).

2 [Call]

Operating the answering system

You can also operate the answering system by pressing dial keys on the handset during playback.

Key	Operation
[▲] or [▼]	Adjust the receiver/speaker volume
[1] or [←]	Repeat message (during playback)*1
[2] or [→]	Skip message (during playback)
[4]	Play new messages
[5]	Play all messages
[8]	Turn answering system on
[9]	Stop playback*2
[0]	Turn answering system off
[*][4] or [Erase]	Erase message currently playing
[*][5]	Erase all messages

*1 If pressed within the first 5 seconds of a message, the previous message is played.

*2 To resume operation, press a command key within 15 seconds, or the voice guidance will start.

Answering System

Remote operation

Using a touch tone phone, you can call your phone number from outside and access the unit to listen to messages. The unit's voice guidance prompts you to press certain dial keys to perform different operations.

Important:

- In order to operate the answering system remotely, you must first set a remote code (page 37). This code must be entered each time you operate the answering system remotely.

Using the answering system remotely

- 1 Dial your phone number from a touch tone phone.
- 2 After the greeting message starts, enter your remote code (page 37).
 - The unit plays back new messages.
 - The voice guidance informs you of the available commands.
- 3 Control the unit using remote commands (page 36).
- 4 When finished, hang up.

Voice guidance

During remote operation, the unit's voice guidance starts and prompts you to press **[1]** to perform a specific operation, or press **[2]** to listen to more available operations. Operations are presented by voice guidance in the following order:

- Play back all messages
- Play back new messages
- Record a message
- Erase all messages

Note:

- If you do not press any dial keys within 10 seconds after a voice guidance prompt, the unit disconnects your call.

Remote commands

You can press dial keys to access certain answering system functions without waiting for the voice guidance to prompt you.

Key	Remote command
[1]	Repeat message (during playback)*1
[2]	Skip message (during playback)
[4]	Play new messages
[5]	Play all messages
[9]	Stop playback*2
[0]	Turn answering system off
[*][4]	Erase message currently playing
[*][5]	Erase all messages

*1 If pressed within the first 5 seconds of a message, the previous message is played.

*2 To resume operation, enter a remote command within 15 seconds, or the voice guidance starts.

Turning on the answering system remotely

If the answering system is off, you can turn it on remotely.

- 1 Dial your phone number.
- 2 Let the phone ring 15 times.
 - The unit answers your call with the greeting message.

Answering System

- You can hang up, or if you call from a touch tone phone, you can enter your remote code and begin remote operation (page 36).

Skipping the greeting message to leave a message

You can leave a message just as any outside caller can. Call your phone number. When the answering system picks up, press [*] to skip the greeting message and record your message after the beep.

Answering system settings

Remote code

A remote code must be entered when operating the answering system remotely. This code prevents unauthorized parties from listening to your messages remotely. The default setting is "11".

- [MENU] → [0][6][3]**
- Enter the desired 2-digit remote code. → **[Save] → [OFF]**

Ring count

You can change the number of times the phone rings before the unit answers calls.

The default setting is "4".

"Toll saver": The unit answers on the 2nd ring when new messages have been recorded, and on the 4th ring when there are no new messages. If you call your phone from outside to listen to new messages (page 36), you will know that there are no new messages when the phone rings for the

3rd time. You can then hang up without being charged for the call.

- [MENU] → [0][6][1]**
- [▼]/[▲]**: Select the desired setting.
- [Save] → [OFF]**

For Voice Mail service subscribers

If you subscribe to a flat-rate service package that includes Call Display, Call Waiting, Voice Mail, and unlimited local/regional/long distance calls, please note the following:

- To use the Voice Mail service provided by your telephone service provider rather than the unit's answering system, turn off the answering system (page 33).
- To use this unit's answering system rather than the Voice Mail service provided by your telephone service provider, please contact your telephone service provider to deactivate your Voice Mail service. If your telephone service provider cannot do this:
 - Set this unit's **"Ring count"** setting so that this unit's answering system answers calls before the Voice Mail service of your telephone service provider does. It is necessary to check the ring count required to activate the Voice Mail service provided by your telephone service provider before changing this setting.
 - Change the ring count of the Voice Mail service so that the answering system can answer the call first. To do so, consult your telephone service provider.

Answering System

Caller's recording time

You can change the maximum message recording time allotted to each caller.

The default setting is "3min".

- 1 [MENU] → [0][6][2]
- 2 [▼]/[▲]: Select the desired setting.
- 3 [Save] → [OFF]

Message alert

You can select whether or not the message indicator on the handset flashes slowly when new messages are recorded. The default setting is "OFF".

Important:

- If there are new Voice Mail messages present (page 39), the message indicator also flashes slowly.

- 1 [MENU] → [0][#]
- 2 [▼]/[▲]: Select the desired setting.
- 3 [Save] → [OFF]

Note:

- While message alert is on, battery operating time is shortened (page 12).

Voice Mail Service

Using Voice Mail service

Voice Mail is an automatic answering service offered by your telephone service provider. After you subscribe to this service, the telephone service provider's Voice Mail system will answer calls for you when you are unavailable to answer the phone or when your line is busy. Messages are recorded by the telephone service provider, not your telephone.

Important:

- To use the Voice Mail service provided by your telephone service provider rather than the unit's answering system, turn off the answering system (page 33).

Storing the Voice Mail (VM) access number

In order to listen to your Voice Mail messages, you must dial your telephone service provider's Voice Mail access number. Once you have stored your Voice Mail access number, you can dial it automatically (page 40).

- 1 **[MENU]** → **[0][7][1]**
- 2 Enter your access number (max. 32 digits). → **[Save]** → **[OFF]**

Note:

- When storing your Voice Mail access number and your mailbox password, press **[PAUSE]** to add pauses (page 17) between the access number and the password as necessary. Consult your telephone service provider for the required pause time.

Example:

1-222-333-4444	PPPP	8888
VM access number	Pauses	Password

To erase the Voice Mail access number

Repeat step 1, then press and hold **[Clear]** until all digits are erased. Press **[Save]**, then press **[OFF]**.

Voice Mail (VM) tone detection

Your telephone service provider sends special signals (sometimes called "Voice Mail tones" or "stutter tones") to the unit to let you know you have new Voice Mail messages. If you hear a series of dial tones followed by a continuous dial tone after you press **[↶]**, you have new Voice Mail messages. Minutes after you hang up a call or after the phone stops ringing, your unit will check the phone line to see if new Voice Mail messages have been recorded.

Turn this feature off when:

- You do not subscribe to Voice Mail service.
 - Your telephone service provider does not send Voice Mail tones.
 - Your phone is connected to a PBX.
- If you are not sure which setting is required, consult your telephone service provider.

Turning VM tone detection on/off

The default setting is "on".

- 1 **[MENU]** → **[0][7][2]**
- 2 **[▼]/[▲]**: Select the desired setting.
- 3 **[Save]** → **[OFF]**

Voice Mail Service

Listening to Voice Mail messages

The unit lets you know that you have new Voice Mail messages in the following ways:

- "New Voice Mail" is displayed on the handset.
- The message indicator on the handset flashes slowly if message alert feature is turned on (page 40).

1 Press **[↶]**, then press **[VM]** within 15 seconds.

OR

[MENU] → **[▼]/[▲]**: "v.m. access" → **[Select]**

- The speakerphone turns on.

2 Follow the prerecorded instructions.

3 When finished, press **[OFF]**.

Note:

- If **[VM]** is not displayed, the Voice Mail access number has not been stored. Store the number (page 39).
- If the handset still indicates there are new messages even after you have listened to all new messages, turn it off by pressing and holding **[OFF]** until the handset beeps.
- If your Voice Mail service uses Voice Mail tones and the message is over 3 minutes long, the handset may not indicate new messages.
- If your Voice Mail service uses Voice Mail tones, the tones are heard from any phone connected to the same line. If you want to use another phone to listen to Voice Mail messages, you have to dial your access number manually.

Message alert

You can select whether or not the message indicator on the handset flashes slowly when there are new recorded messages in the Voice Mail system.

The default setting is "Off".

Important:

- KX-TG6031/KX-TG6032/
KX-TG6033/KX-TG6034/
KX-TG6051/KX-TG6052/
KX-TG6053 only
- If there are new answering system messages present (page 33), the message indicator also flashes slowly.

1 **[MENU]** → **[0][#]**

2 **[▼]/[▲]**: Select the desired setting.

3 **[Save]** → **[OFF]**

Note:

- While message alert is on, battery operating time is shortened (page 12).

Multi-unit Operation

Intercom

Intercom calls can be made:

- between handsets
- between the handset and base unit (KX-TG6031/KX-TG6032/ KX-TG6033/KX-TG6034/ KX-TG6051/KX-TG6052/ KX-TG6053)

Note:

- If you receive an outside call while talking on the intercom, you hear 2 tones. To answer the call, press [OFF], then press [↶].
- When paging a unit for an intercom call, the paged unit beeps for 1 minute.

Making an intercom call

Handset

- 1 [INTERCOM]
- 2 [▼]/[▲]: Select the desired unit. → [Select]
 - To stop paging, press [OFF].
- 3 When you finish talking, press [OFF].

Base unit

KX-TG6031/KX-TG6032/KX-TG6033/
KX-TG6034/KX-TG6051/KX-TG6052/
KX-TG6053

- 1 [INTERCOM]
 - All the registered handsets beep for 1 minute.
 - To stop paging, press [INTERCOM].
- 2 When you finish talking, press [INTERCOM].

Answering an intercom call

Handset

- 1 Press [↶] or [↷] to answer the page.
- 2 When you finish talking, press [OFF].

Base unit

KX-TG6031/KX-TG6032/KX-TG6033/
KX-TG6034/KX-TG6051/KX-TG6052/
KX-TG6053

- 1 Press [INTERCOM] to answer the page.
- 2 When you finish talking, press [INTERCOM].

Note:

- When the ringer volume is set to off, the handset or the base unit rings at a low level for intercom calls.

Handset locator

You can locate a misplaced handset by paging it.

- 1 **Base unit:** [LOCATOR]
 - The handset beeps for 1 minute.

- 2 To stop paging:

Base unit:
Press [LOCATOR].

Handset:
KX-TG6021/KX-TG6022/
KX-TG6023
Press [OFF].

KX-TG6031/KX-TG6032/
KX-TG6033/KX-TG6034/
KX-TG6051/KX-TG6052/
KX-TG6053
Press [INTERCOM], then press [OFF].

Multi-unit Operation

Transferring calls between handsets, conference calls

Outside calls can be transferred between 2 handsets. 2 handsets can have a conference call with an outside party.

- 1 During an outside call, press **[INTERCOM]** to put the call on hold.
- 2 **[▼]/[▲]**: Select the desired unit. → **[Transfer]**
- 3 Wait for the paged party to answer.
 - If the paged party does not answer, press **[↶]** to return to the outside call.
- 4 **To complete the transfer:**
Press **[OFF]**.
 - The outside call is being routed to the handset.**To establish a conference call:**
Press **[Conf]**.
 - To leave the conference, press **[OFF]**. The other parties can continue the conversation.
 - To put the outside call on hold, press **[HOLD]**. To resume the conference, press **[Conf]**.

Answering transferred calls

- Press **[↶]** to answer the page.
- After the paging party disconnects, you can talk to the outside caller.

Registering a handset

The included handset and base unit are preregistered. If for some reason the handset is not registered to the base unit, register the handset.

- 1 **Handset:**
[MENU] → **[0][0][1]**
- 2 **Base unit:**
**KX-TG6021/KX-TG6022/
KX-TG6023**
Press and hold **[LOCATOR]** until the IN USE indicator flashes.
**KX-TG6031/KX-TG6032/
KX-TG6033/KX-TG6034/
KX-TG6051/KX-TG6052/
KX-TG6053**
Press and hold **[LOCATOR/
INTERCOM]** until the IN USE indicator flashes.
 - After the IN USE indicator starts flashing, the rest of the procedure must be completed within 1 minute.
- 3 **Handset:**
Press **[OK]**, then wait until a beep sounds.
- 4 **[OFF]**

Registering an additional handset

See page 6 for information on the available model.
Start from step 2.

Deregistering a handset

- 1 **[MENU]** → **[0][0][2]**
- 2 **[3][3][5]** → **[OK]**
- 3 Select the handset you want to cancel by pressing the desired handset number (**[1]** – **[4]**).

Useful Information

Wall mounting

Base unit

1 Insert the hooks on the wall mounting adaptor into the holes **A** and **B** on the base unit.

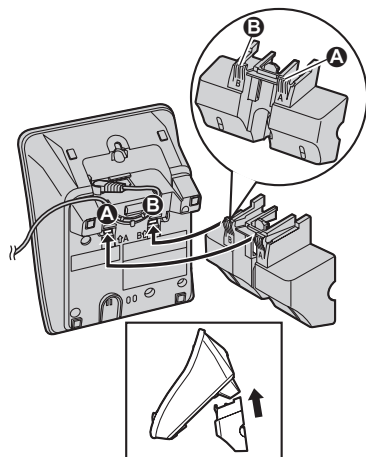

2 While pressing down the lever **(1)**, press it in the direction of the arrow **(2)** until it is secure.

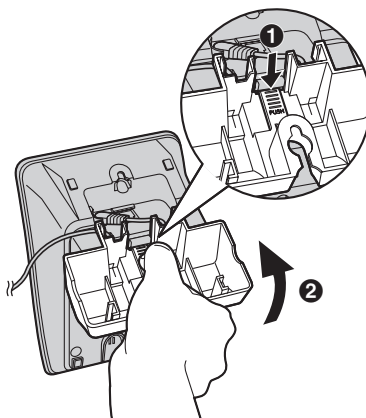

3 Tuck the telephone line cord inside the wall mounting adaptor and connect the cord. Mount the unit by inserting the mounting pins into the round openings on the adaptor (for pin **B**, use round cut out at the bottom of the adaptor if you are using the 4 inches phone plate), then sliding the unit down to secure it. Connect the AC adaptor to power outlet (page 10).

- There are two common types of wall phone plates. The distance between **A** and **B** may vary depending on the size of the wall phone plate installed.

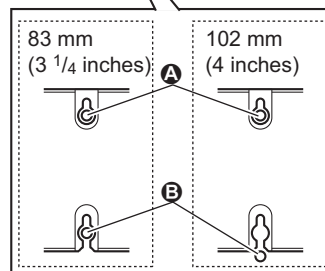
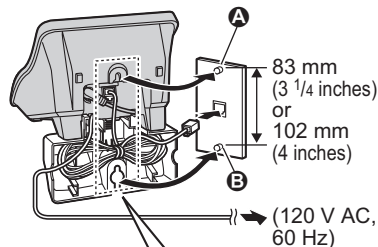
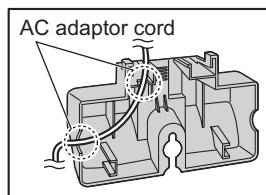

Useful Information

To remove the wall mounting adaptor

While pushing down the lever (1), remove the adaptor (2).

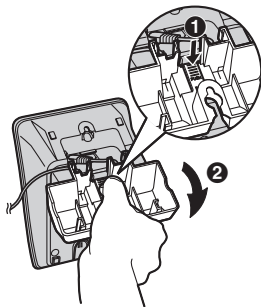

Charger

Available model:

KX-TG6022/KX-TG6023/KX-TG6032/
KX-TG6033/KX-TG6034/KX-TG6052/
KX-TG6053

- 1 Drive the screws (not included) into the wall.

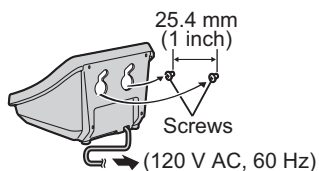

- 2 Mount the charger (1), then slide it down (2) and to the right (3) until it is secure.

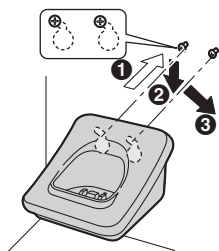

Headset (optional)

Connecting a headset to the handset allows hands-free phone conversations. We recommend using the Panasonic headset noted on page 6.



- Headset shown is RP-TCA86.

Switching a call between the headset and handset speakerphone

To switch to the handset speakerphone, press [4].

To return to the headset, press [5].

Lanyard/strap eyelet

If you have a lanyard/strap (not included), you can hang your handset from your neck or wrist. Thread it through the eyelet as shown and pull to tighten it.

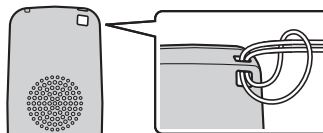

Useful Information

Error messages

If the unit detects a problem, one of the following messages is shown on the display.

Display message	Cause/solution
All handsets are registered.	<ul style="list-style-type: none"> 4 handsets have already been registered to the base unit. A previously deregistered handset number may still be retained in the base unit. To register an additional handset, erase the unnecessary handset number (page 42).
Busy	<ul style="list-style-type: none"> The called unit is in use. The handset you tried to copy phonebook items to is in use. Try again later. The handset you are calling is too far from the base unit.
Error!!	<ul style="list-style-type: none"> The handset's registration has failed. Move the handset and base unit away from all electrical appliances and try again. Another handset user tried to send phonebook items to you but there was an error. Have the other handset user re-send the items to you (page 22).
---Incomplete--- Phonebook full	<ul style="list-style-type: none"> The destination handset's phonebook memory is full. Erase unnecessary items from the destination handset's phonebook (page 22).
Invalid	<ul style="list-style-type: none"> There is no handset registered to the base unit matching the extension number you entered.
No items stored	<ul style="list-style-type: none"> Your phonebook or redial list is empty.
No link to base. Move closer to base, try again.	<ul style="list-style-type: none"> The handset has lost communication with the base unit. Move closer to the base unit, and try again. Confirm that the base unit's AC adaptor is plugged in. The handset's registration may have been cancelled. Re-register the handset (page 42).
Phonebook full	<ul style="list-style-type: none"> There is no space to store new items in the phonebook. Erase unnecessary items (page 22).
Please lift up and try again.	<ul style="list-style-type: none"> A handset button was pressed while the handset was on the base unit or charger. Lift the handset and press the button again.

Useful Information

Display message	Cause/solution
System is busy. Please try again later.	<ul style="list-style-type: none"> • Other units are in use and the system is busy. Try again later. • Another user is listening to messages. Try again later.*¹ • The handset's registration may have been cancelled. Re-register the handset (page 42).
Store VM access#	<ul style="list-style-type: none"> • You have not stored the Voice Mail access number. Store the number (page 39).

*1 KX-TG6031/KX-TG6032/KX-TG6033/KX-TG6034/KX-TG6051/KX-TG6052/
KX-TG6053

Troubleshooting

General use

Problem	Cause/solution
The unit does not work.	<ul style="list-style-type: none"> • Make sure the battery is installed correctly and fully charged (page 11). • Check the connections (page 10). • Unplug the base unit's AC adaptor to reset the unit. Reconnect the adaptor and try again. • The handset has not been registered to the base unit. Register the handset (page 42).
I cannot hear a dial tone.	<ul style="list-style-type: none"> • Confirm the telephone line cord is properly connected (page 10). • Disconnect the unit from the telephone line and connect a known working telephone. If the working telephone operates properly, contact our service personnel to have the unit repaired. If the working telephone does not operate properly, contact your telephone service provider.
The indicator on the top right of the handset flashes slowly.	<ul style="list-style-type: none"> • New messages have been recorded. Listen to the new messages (page 34).*¹ • New Voice Mail messages have been recorded. Listen to the new Voice Mail messages (page 40).



*1 KX-TG6031/KX-TG6032/KX-TG6033/KX-TG6034/KX-TG6051/KX-TG6052/
KX-TG6053

Useful Information

Programmable settings

Problem	Cause/solution
I cannot program items.	<ul style="list-style-type: none"> • Programming is not possible while either the base unit or another handset is being used. Try again later.
I cannot set the alarm.	<ul style="list-style-type: none"> • In order to set the alarm, you must first set the date and time (page 15). • The handset has lost communication with the base unit. Move closer to the base unit, and try again.
While programming, the handset starts to ring.	<ul style="list-style-type: none"> • A call is being received. Answer the call and start again after hanging up.

Battery recharge

Problem	Cause/solution
I fully charged the battery, but  continues to flash, or  is displayed.	<ul style="list-style-type: none"> • Clean the charge contacts and charge again (page 12). • The battery may need to be replaced with a new one (page 11).
The handset display is blank.	<ul style="list-style-type: none"> • Confirm that the battery is properly installed. • Fully charge the battery (page 11).
While charging, the charge indicator does not light and "Charge for 7h" is displayed.	<ul style="list-style-type: none"> • The battery is empty. The charge indicator does not light in order to concentrate on charging. After about 5 minutes, the charge indicator lights and "charging" is displayed.

Useful Information

Making/answering calls, intercom

Problem	Cause/solution
Static is heard, sound cuts in and out. Interference from other electrical units.	<ul style="list-style-type: none"> ● Move the handset and base unit away from other electrical appliances. ● Move closer to the base unit. ● Turn on the clarity booster feature (page 19). ● If your unit is connected to a telephone line with DSL service, we recommend connecting a noise filter between the base unit and the telephone line jack. Contact your DSL provider for details.
The handset does not ring.	<ul style="list-style-type: none"> ● The ringer volume is turned off. Adjust it (page 30).
The base unit does not ring.*1	<ul style="list-style-type: none"> ● The ringer volume is turned off. Adjust it (page 18).
I cannot make a call.	<ul style="list-style-type: none"> ● The dialing mode may be set incorrectly. Change the setting (page 15). ● Another handset is in use. Try again later.
I cannot have a conversation using the headset.	<ul style="list-style-type: none"> ● Make sure that an optional headset is connected properly (page 44). ● If "SP-phone" is displayed on the handset, press [↶] to switch to the headset.
I cannot make long distance calls.	<ul style="list-style-type: none"> ● Make sure that you have long distance service.
I cannot page the handset.	<ul style="list-style-type: none"> ● The called handset is too far from the base unit. ● The called handset is in use. Try again later.
I cannot page the base unit.*1	<ul style="list-style-type: none"> ● The base unit is in use. Try again later.
The Slow Talk feature does not work.*1	<ul style="list-style-type: none"> ● If you are on a conference call, you cannot use the Slow Talk feature.

*1 KX-TG6031/KX-TG6032/KX-TG6033/KX-TG6034/KX-TG6051/KX-TG6052/
KX-TG6053

Useful Information

Call Display

Problem	Cause/solution
<p>The handset does not display the caller's name and/or phone number.</p>	<ul style="list-style-type: none"> ● You have not subscribed to Call Display service. Contact your telephone service provider to subscribe. ● If your unit is connected to any additional telephone equipment such as a Call Display box or cordless telephone line jack, disconnect the unit from the equipment and plug the unit directly into the wall jack. ● If your unit is connected to a telephone line with DSL service, we recommend connecting a noise filter between the base unit and the telephone line jack. Contact your DSL provider for details. ● The name display service may not be available in some areas. Contact your telephone service provider for details. ● Other telephone equipment may be interfering with this unit. Disconnect the other equipment and try again. ● The caller requested not to send caller information (page 23). ● Generally, caller information is displayed from the 2nd ring.
<p>The handset or base unit does not announce the displayed caller names or phone numbers.*1</p>	<ul style="list-style-type: none"> ● The handset or base unit's ringer volume is turned off. Adjust it (page 18, 30). ● The Talking Call Display feature is turned off. Turn it on (page 31). ● The ring count for the answering system is set to "2" or "To11 saver". Select a different setting (page 37). ● If the base unit and another handset are having an intercom call, your handset does not announce caller information.
<p>I cannot dial the phone number edited in the caller list.</p>	<ul style="list-style-type: none"> ● The phone number you dialed might have an incorrectly edited pattern (for example, the long distance "1" or the area code is missing). Edit the phone number with another pattern (page 26).

Useful Information

Problem	Cause/solution
The 2nd caller's information is not displayed during an outside call. (Visual Call Waiting feature does not function.)	<ul style="list-style-type: none"> ● In order to use Call Display, Call Waiting, or Visual Call Waiting, you must first contact your telephone service provider and subscribe to the desired service. ● After subscribing, you may need to contact your telephone service provider again to activate this specific service, even if you already subscribed to both Call Display and Visual Call Waiting services.

*1 KX-TG6051/KX-TG6052/KX-TG6053

Answering system (KX-TG6031/KX-TG6032/KX-TG6033/KX-TG6034/ KX-TG6051/KX-TG6052/KX-TG6053)

Problem	Cause/solution
I cannot listen to messages from a remote location.	<ul style="list-style-type: none"> ● A touch tone phone is required for remote operation. ● Enter the remote code correctly (page 37). ● The answering system is off. Turn it on (page 36).
The unit does not record new messages.	<ul style="list-style-type: none"> ● The answering system is off. Turn it on (page 33, 36). ● The message memory is full. Erase unnecessary messages (page 34, 35). ● If you subscribe to the Voice Mail service, messages are recorded by the telephone service provider not your telephone (page 37).
I cannot operate the answering system.	<ul style="list-style-type: none"> ● Someone is operating the answering system. ● If someone is talking on a conference call, you cannot operate the answering system. Try again later.

Useful Information

Important information

NOTICE:

This equipment meets the applicable Industry Canada Terminal Equipment Technical Specifications. This is confirmed by the registration number. The abbreviation, "IC:", before the registration number signifies that registration was performed based on a Declaration of Conformity indicating that Industry Canada technical specifications were met. It does not imply that Industry Canada approved the equipment.

And, the term "IC:" signifies that Industry Canada radio technical specifications were met.

Before installing this equipment, users should ensure that it is permissible to be connected to the facilities of the local telecommunications company. The equipment must also be installed using an acceptable method of connection. The customer should be aware that compliance with the above conditions may not prevent degradation of service in some situations.

Repairs to certified equipment should be coordinated by a representative designated by the supplier. Any repairs or alterations made by the user to this equipment, or equipment malfunctions, may give the telecommunications company cause to request the user to disconnect the equipment.

Users should ensure, for their own protection, that the electrical ground connections of the power utility, telephone lines and internal metallic water pipe system, if present, are

connected together. This precaution may be particularly important in rural areas.

Caution:

Users should not attempt to make such connections themselves, but should contact the appropriate electric inspection authority, or electrician, as appropriate.

NOTICE:

The **Ringer Equivalence Number (REN)** assigned to each terminal device provides an indication of the maximum number of terminals allowed to be connected to a telephone interface. The termination on an interface may consist of any combination of devices subject only to the requirement that the sum of the Ringer Equivalence Numbers of all the devices does not exceed 5.

The Ringer Equivalence Number (REN) of this unit:
(found on the bottom of the unit).

NOTICE:

Operation is subject to the following two conditions: (1) this device may not cause interference, and (2) this device must accept any interference, including interference that may cause undesired operation of the device.

Privacy of communications may not be ensured when using this telephone.

Some cordless telephones operate at frequencies that may cause interference to nearby TVs and VCRs. To minimize or prevent such interference, the base of the cordless telephone should not be placed near, or on top of, a TV or VCR. If

Useful Information

interference is experienced, move the cordless telephone further away from the TV or VCR. This will often reduce, or eliminate, interference.

RF Exposure Warning:

- This product complies with IC radiation exposure limits set forth for an uncontrolled environment.
- To comply with IC RF exposure requirements, the base unit must be installed and operated 20 cm (8 inches) or more between product and all person's body (excluding extremities of hands, wrist and feet).
- This product may not be collocated or operated in conjunction with any other antenna or transmitter.
- For body-worn operation, the handset must be used only with a non-metallic accessory. Use of other accessories may not ensure compliance with IC RF exposure requirements.

Useful Information

Specifications

General

Operating environment	5 °C – 40 °C (41 °F – 104 °F)
Frequency	5.76 GHz – 5.84 GHz

Base unit

Dimensions	Approx. height 97 mm × width 120 mm × depth 144 mm (3 ¹³ / ₁₆ inches × 4 ²³ / ₃₂ inches × 5 ²¹ / ₃₂ inches)
Mass (Weight)	Approx. 220 g (0.49 lb.) ^{*1} /Approx. 270 g (0.60 lb.) ^{*2}
Power consumption	Standby: Approx. 1.3 W Maximum: Approx. 4.1 W ^{*1} /Maximum: Approx. 4.5 W ^{*2}
Power output	200 mW (max.)
Power supply	AC adaptor (120 V AC, 60 Hz)

*1 KX-TG6021/KX-TG6022/KX-TG6023

*2 KX-TG6031/KX-TG6032/KX-TG6033/KX-TG6034/KX-TG6051/KX-TG6052/
KX-TG6053

Handset

Dimensions	Approx. height 156 mm × width 48 mm × depth 33 mm (6 ¹ / ₈ inches × 1 ⁷ / ₈ inches × 1 ⁵ / ₁₆ inches)
Mass (Weight)	Approx. 155 g (0.34 lb.)
Power output	200 mW (max.)
Power supply	Ni-MH battery (3.6 V, 650 mAh)

Charger (KX-TG6022/KX-TG6023/KX-TG6032/KX-TG6033/KX-TG6034/ KX-TG6052/KX-TG6053)

Dimensions	Approx. height 68 mm × width 82 mm × depth 87 mm (2 ¹¹ / ₁₆ inches × 3 ⁷ / ₃₂ inches × 3 ⁷ / ₁₆ inches)
Mass (Weight)	Approx. 80 g (0.18 lb.)
Power consumption	Standby: Approx. 0.4 W Maximum: Approx. 3.3 W
Power supply	AC adaptor (120 V AC, 60 Hz)

Note:

- Design and specifications are subject to change without notice.
- The illustrations in these instructions may vary slightly from the actual product.

Useful Information

Warranty

Panasonic Canada Inc.

5770 Ambler Drive, Mississauga, Ontario L4W 2T3

PANASONIC PRODUCT - LIMITED WARRANTY

Panasonic Canada Inc. warrants this product to be free from defects in material and workmanship and agrees to remedy any such defect for a period as stated below from the date of original purchase.

Telephone Accessory / Product - One (1) year, parts and labour

LIMITATIONS AND EXCLUSIONS

This warranty does not apply to products purchased outside Canada or to any product which has been improperly installed, subjected to usage for which the product was not designed, misused or abused, damaged during shipping, or which has been altered or repaired in any way that affects the reliability or detracts from the performance, nor does it cover any product which is used commercially. Dry cell batteries are also excluded from coverage under this warranty. Rechargeable batteries are warranted for ninety (90) days from date of original purchase.

This warranty is extended to the original end user purchaser only. A purchase receipt or other proof of date of original purchase is required before warranty service is performed.

THIS EXPRESS, LIMITED WARRANTY IS IN LIEU OF ALL OTHER WARRANTIES, EXPRESS OR IMPLIED, INCLUDING ANY IMPLIED WARRANTIES OF MERCHANTABILITY AND FITNESS FOR A PARTICULAR PURPOSE.

IN NO EVENT WILL PANASONIC CANADA INC. BE LIABLE FOR ANY SPECIAL, INDIRECT OR CONSEQUENTIAL DAMAGES.

In certain instances, some jurisdictions do not allow the exclusion or limitation of incidental or consequential damages, or the exclusion of implied warranties, so the above limitations and exclusions may not be applicable.

WARRANTY SERVICE

FOR PRODUCT OPERATION ASSISTANCE, please contact:

Our Customer Care Centre: Telephone #: (905) 624-5505
1-800 #: 1-800-561-5505
Fax #: (905) 238-2360
Email link: "Contact Us" on www.panasonic.ca

FOR PRODUCT REPAIRS, please locate your nearest Authorized Servicentre at www.panasonic.ca :

Link : "Servicentres™ locator" under "Customer support"

IF YOU SHIP THE PRODUCT TO A SERVICENTRE

Carefully pack and send prepaid, adequately insured and preferably in the original carton. Include details of the defect claimed, and proof of date of original purchase.

Index

Index

- A** Alarm: 32
- Answering calls: 18
- Answering system
 - Erasing messages: 34, 35, 36
 - Listening to messages: 34, 35, 36
 - Turning on/off: 33, 35, 36
- Auto talk: 18
- B** Battery: 11, 12
- Booster (Clarity booster): 19
- C** Call Display service: 23
- Call screening: 33
- Call share: 20
- Call Waiting: 19
- Caller list: 26
- Chain dial: 22
- CID (Call Display): 26
- Conference calls: 42
- Connections: 10
- Customer support: 32
- C.WTG (Call Waiting Deluxe): 24
- D** Date and time: 15
- Deregistration: 42
- Dialing mode: 15
- Display
 - Contrast: 30
 - Language: 15
- E** Error messages: 45
- F** Flash: 18
- Flash time: 30
- G** Greeting message: 34
- H** Handset locator: 41
- Headset, optional: 44
- Hold: 18
- I** Intercom: 41
- K** Key tone: 30
- L** Light-up ID: 24
- Line mode: 30
- M** Making calls: 17
- Memory capacity (message recording): 33
- Message alert: 38, 40
- Missed calls: 23
- Mute: 18
- N** Navigator key: 14
- P** Pause: 17
- Phonebook: 21
- Phonebook copy: 22
- Power failure: 10
- Pulse service: 19
- R** Recording time: 38
- Redial list: 17
- Registration: 42
- Remote code: 37
- Remote operation: 36
- Ring colour: 30
- Ring count: 37
- Ringer ID: 24
- Ringer off: 18, 30
- Ringer tone: 30, 31
- Rotary service: 19
- S** Slow Talk: 20
- Soft keys: 14
- SP-phone: 17
- T** Talking Call Display: 23
- Time adjustment: 30
- Toll saver: 37
- Tone: 15, 19
- Transferring calls: 42
- Troubleshooting: 46
- V** VE (Voice Enhancer): 19
- Visual Call Waiting: 24
- VM (Voice Mail): 39
- Voice guidance: 35, 36
- Voice guidance language: 15
- Voice Mail access number: 39
- Volume
 - Base unit ringer: 18
 - Handset ringer: 30
 - Receiver: 17
 - Speaker: 17
- W** Wall mounting: 43, 44
- Warranty: 54

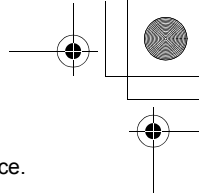
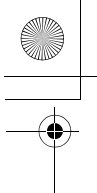

We recommend keeping a record of the following information for future reference.

Serial No. _____ Date of purchase _____
(found on the bottom of the base unit)

Name and address of dealer _____

Attach your purchase receipt here.

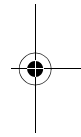
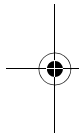

Panasonic Canada Inc.
5770 Ambler Drive, Mississauga, Ontario L4W 2T3

Copyright:
This material is copyrighted by Panasonic Communications Co., Ltd., and may be reproduced for internal use only. All other reproduction, in whole or in part, is prohibited without the written consent of Panasonic Communications Co., Ltd.
© 2007 Panasonic Communications Co., Ltd. All Rights Reserved.



TG6021 C

Printed in U.S.A.

PQQX15814ZA-AK DA1206PF0

