

# Panasonic<sup>®</sup>

5.8 GHz Expandable Cordless Phone System

## Operating Instructions



Model No. **KX-TG5240**

**KX-TG5243**

Pulse-or-tone dialing capability

Model shown is KX-TG5240.



The unit is Caller ID compatible. To display the caller's name and phone number, you must subscribe to Caller ID service.

**PLEASE READ BEFORE USE AND SAVE.**

**Charge the battery for 6 hours before initial use.**

**Panasonic World Wide Web address: <http://www.panasonic.com>**  
for customers in the USA or Puerto Rico

**Thank you for purchasing your new Panasonic cordless telephone.**

Please read the IMPORTANT SAFETY INSTRUCTIONS on page 94 before use. Read and understand all instructions.

Caller ID and Call Waiting Service, where available, are telephone company services. After subscribing to Caller ID this phone will display a caller's name and phone number. Call Waiting Caller ID, which displays a second caller's name and phone number while the user is on another call, requires a subscription to both Caller ID and Call Waiting with Caller ID services (CWID).

**Attach your purchase receipt here.**





**Trademarks:**

openLCR, openLCR.com, and the openLCR logo are the trademarks of openLCR.com, Inc.

**Accessories (included)**

For extra orders, call 1-800-332-5368.

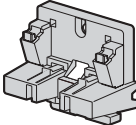
For hearing or speech impaired TTY users, call 1-866-605-1277.

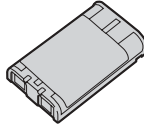
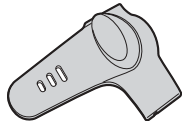
<p><b>A</b> AC Adaptor for Base Unit (p. 12) Order No. PQLV1Z (PQLV1)</p>  <p>one</p>	<p><b>A</b> Telephone Line Cord (p. 12) Order No. PQJA10075Z</p>  <p>one</p>	<p><b>A</b> Wall Mounting Adaptor (p. 74) Order No. PQKL10063Z1</p>  <p>one</p>
<p><b>A</b> Handset Cover (p. 13) Order No. PQKK10142Z1</p>  <p>KX-TG5240: one KX-TG5243: three</p>	<p><b>A</b> Battery (p. 13) Order No. HHR-P104</p>  <p>KX-TG5240: one KX-TG5243: three</p>	<p><b>A</b> Belt Clip (p. 77) Order No. PQKE10377Z1</p>  <p>KX-TG5240: one KX-TG5243: three</p>

**A** Charger Unit (p. 12) (KX-TG5243 only)  
Order No. PQLV30024ZM  
AC Adaptor Order No. KX-TCA1-G (KX-TCA1)

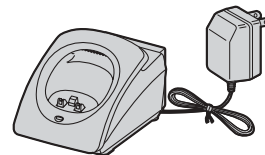

KX-TG5243: two charger units

## Expanding Your Phone

### For KX-TG5240 users

KX-TG5240 includes one handset and one base unit. You can expand the system by adding up to 3 accessory handsets, sold separately. A maximum of 4 handsets can be registered to the base unit.

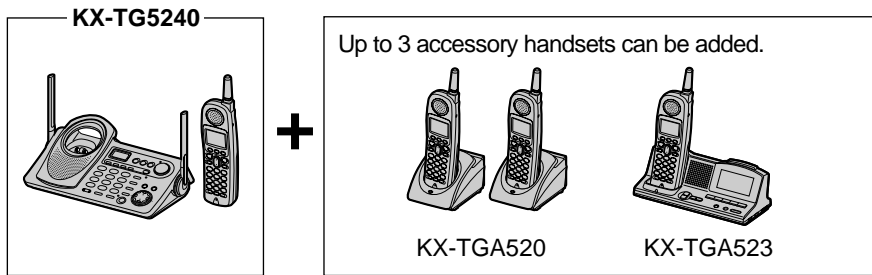

- The included handset is pre-registered at the factory and assigned the extension number 1.

### For KX-TG5243 users

KX-TG5243 includes three handsets, two charger units and one base unit. You can add one more accessory handset, sold separately.

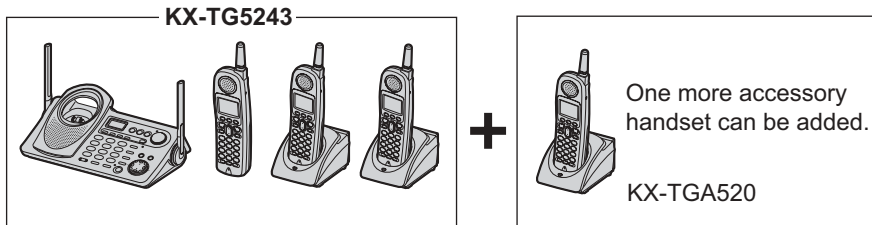

- The included handsets are pre-registered at the factory and assigned extension numbers 1, 2 and 3.

The model numbers of the accessory handsets are KX-TGA520 and KX-TGA523. A charger unit is included with each accessory handset. KX-TGA523 has a charger unit with a clock radio. To order, contact your dealer or call 1-800-211-PANA(7262) to locate a dealer.

After purchasing accessory handsets, you must register each to the base unit. (Please read the accessory handset's Installation Manual.)

For assistance, please call: 1-800-211-PANA(7262)

# Contents

<b>Preparation</b>	
<b>For Best Performance</b>	<b>6</b>
<b>Location of Controls</b>	<b>7</b>
<b>Displays</b>	<b>10</b>
<b>Installation</b>	<b>12</b>
Connections	12
Installing the Battery in the Handset	13
Battery Charge	13
<b>Programmable Settings</b>	<b>15</b>
Programming Guidelines	15
Function Menu Table	16
Date and Time	17
Display Language	18
Dialing Mode	18
Line Mode	19
Auto Talk	19
Ringer Volume	20
Ringer Tone	21
LCD Contrast	22
<b>Preparing the Answering System</b>	<b>23</b>
Greeting Message	23
Caller's Recording Time	24
Number of Rings	25
Recording Mode	26
Message Alert	26
<b>Telephone System</b>	
<b>Making Calls</b>	<b>27</b>
Using the Handset	27
Using the Base Unit	30
<b>Answering Calls</b>	<b>31</b>
<b>Caller ID Service</b>	<b>32</b>
Talking Caller ID	33

<b>Using the Caller List</b>	<b>34</b>
Viewing the Caller List	35
Calling Back from the Caller List	35
Editing the Caller's Phone Number	36
Caller ID Number Auto Edit	37
Storing Caller Information in the Phone Book	38
Erasing Caller Information	38
<b>Phone Book</b>	<b>39</b>
Storing Names and Numbers	39
Dialing from the Phone Book	41
Chain Dial	42
Editing an Item in the Phone Book	43
Erasing an Item in the Phone Book	43
Copying Items in the Phone Book	44
<b>Speed Dialer</b>	<b>46</b>
Storing Phone Numbers	46
Dialing a Stored Phone Number	46
<b>Intercom</b>	<b>47</b>
Making Intercom Calls	47
Answering Intercom Calls	48
Voice Paging	49
<b>Transferring a Call</b>	<b>50</b>
<b>Conference Calls</b>	<b>53</b>
Call Share	53
<b>Room Monitor</b>	<b>54</b>
<b>Special Features</b>	<b>56</b>
Muting Your Conversation	56
Call Privacy	56
Using the PAUSE Button (For PBX Line/Long Distance Calls)	56

## Contents

Temporary Tone Dialing (For Rotary or Pulse Service Users) . . . 57	Direct Remote Operation . . . . . 73
For Call Waiting Service Users . . . . . 57	
FLASH Button . . . . . 58	<b>Useful Information</b>
Incoming Call Tone . . . . . 59	<b>Wall Mounting . . . . . 74</b>
Key Tone . . . . . 60	<b>Belt Clip . . . . . 77</b>
	<b>Optional Headset . . . . . 77</b>
	<b>Direct Commands . . . . . 78</b>
<b>Answering System</b>	<b>Canceling Registration/ Re-registration . . . . . 80</b>
<b>Mailbox Features . . . . . 61</b>	Canceling the Handset Registration . . . . . 80
Setting the Mailbox Password (for Mailbox 2 and 3) . . . . . 62	Re-registering the Handset . . . 80
<b>Automatic Answering Operation . . . . . 63</b>	<b>If the Following Appear on Your Display... . . . . 82</b>
Setting the Unit to Answer Calls . . . . . 63	<b>Troubleshooting . . . . . 84</b>
Monitoring Incoming Calls . . . 63	<b>openLCR Service for Caller IQ . . . . . 90</b>
<b>Listening to Messages . . . . . 64</b>	Turning on or off Caller IQ Feature . . . . . 90
Using the Base Unit . . . . . 64	Downloading Data . . . . . 91
Using the Handset (Remote Operation) . . . . . 65	<b>Important Safety Instructions . . . . . 94</b>
<b>Erasing Messages . . . . . 67</b>	<b>FCC and Other Information . . . 96</b>
<b>Recording a Memo Message . . . . . 68</b>	<b>Index . . . . . 99</b>
<b>Transferring a Call to a Mailbox . . . . . 69</b>	<b>Warranty . . . . . 101</b>
<b>Remote Operation from a Touch Tone Phone . . . . . 70</b>	<b>Specifications . . . . . 103</b>
Remote Code . . . . . 71	
Voice Menu . . . . . 72	

Preparation

Telephone System

Answering System

Useful Information

**Important**  
 Throughout these Operating Instructions, **Handset** and **Base Unit** are used to indicate with which unit an operation can be performed.

**Handset** : Perform with the handset.  
**Base Unit** : Perform with the base unit.  
**Handset Base Unit** : Perform with the handset and base unit separately.  
**Handset & Base Unit** : Perform with the handset and base unit together.

For assistance, please call: 1-800-211-PANA(7262)

## For Best Performance

### Battery charge

The handset is powered by a rechargeable Nickel-Metal Hydride (Ni-MH) battery. Charge the battery for **6 hours** before initial use (p. 13).

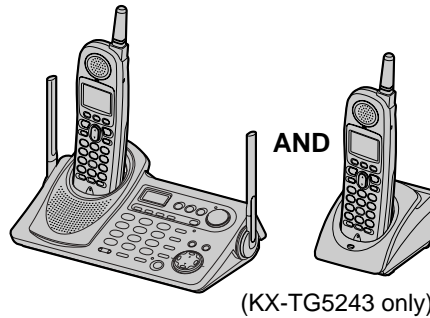

### Base unit location/Noise

Calls are transmitted between the base unit and handset using wireless radio waves. **For maximum distance and noise-free operation**, the recommended base unit location is:

Away from electrical appliances such as a TV, personal computer or another cordless phone.

In a HIGH and CENTRAL location with no obstructions such as walls.

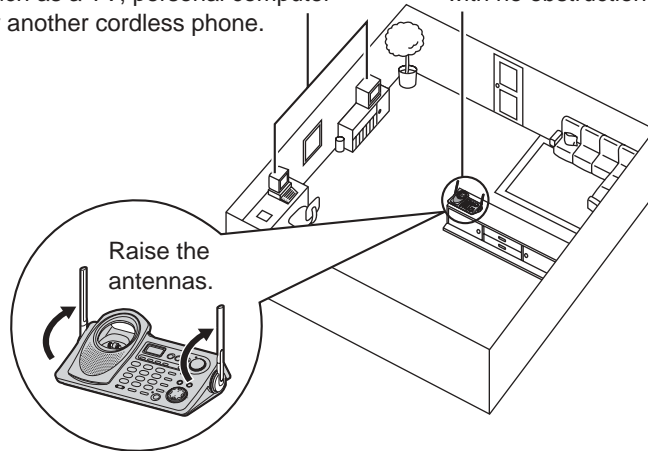

#### Note:

- If you use the handset near a microwave oven which is being used, noise may be heard from the receiver or the speaker. Move away from the microwave oven and closer to the base unit.
- If you use the handset near another cordless phone's base unit, noise may be heard. Move away from the other cordless phone's base unit and closer to your base unit.

# Location of Controls

## Base unit

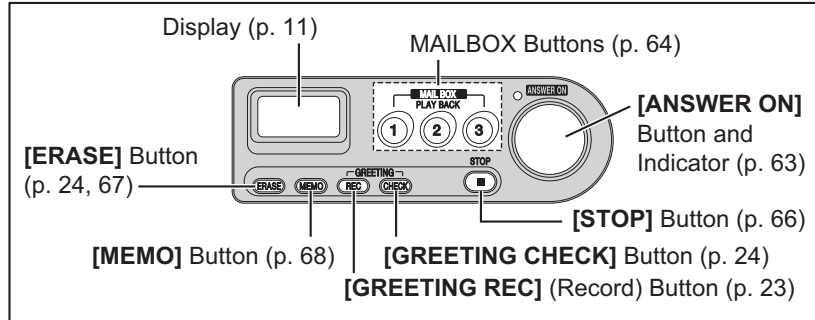

Preparation

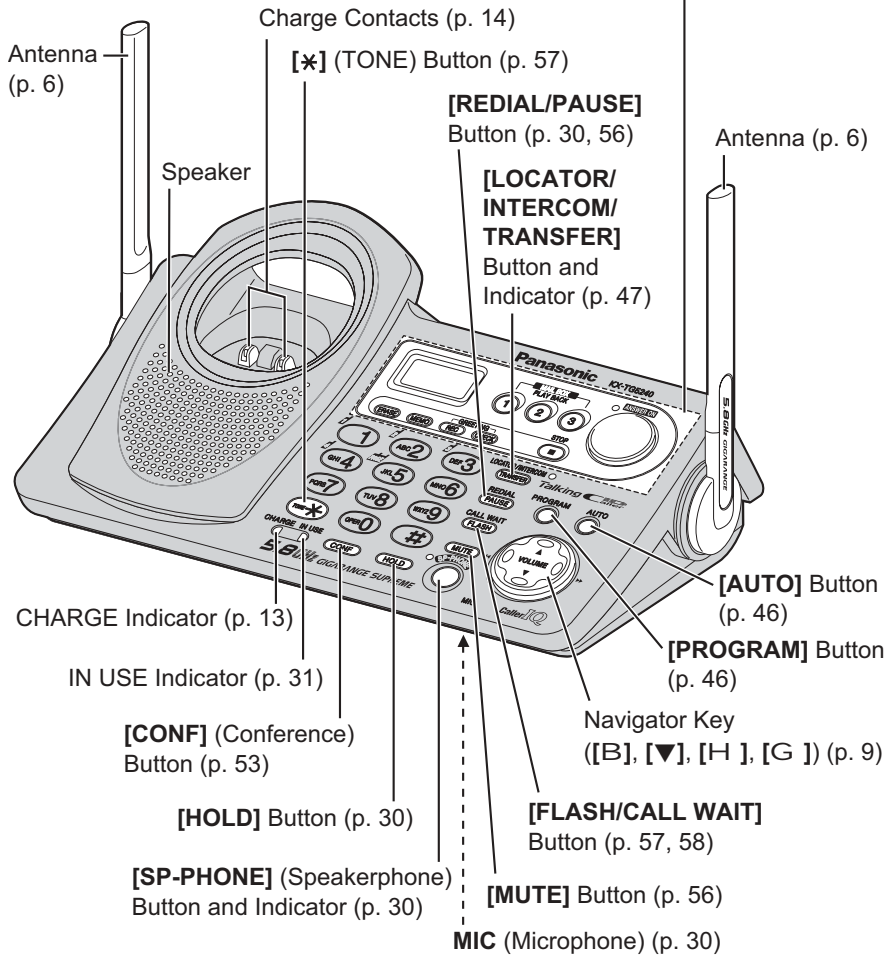

For assistance, please call: 1-800-211-PANA(7262)

## Location of Controls

### Handset

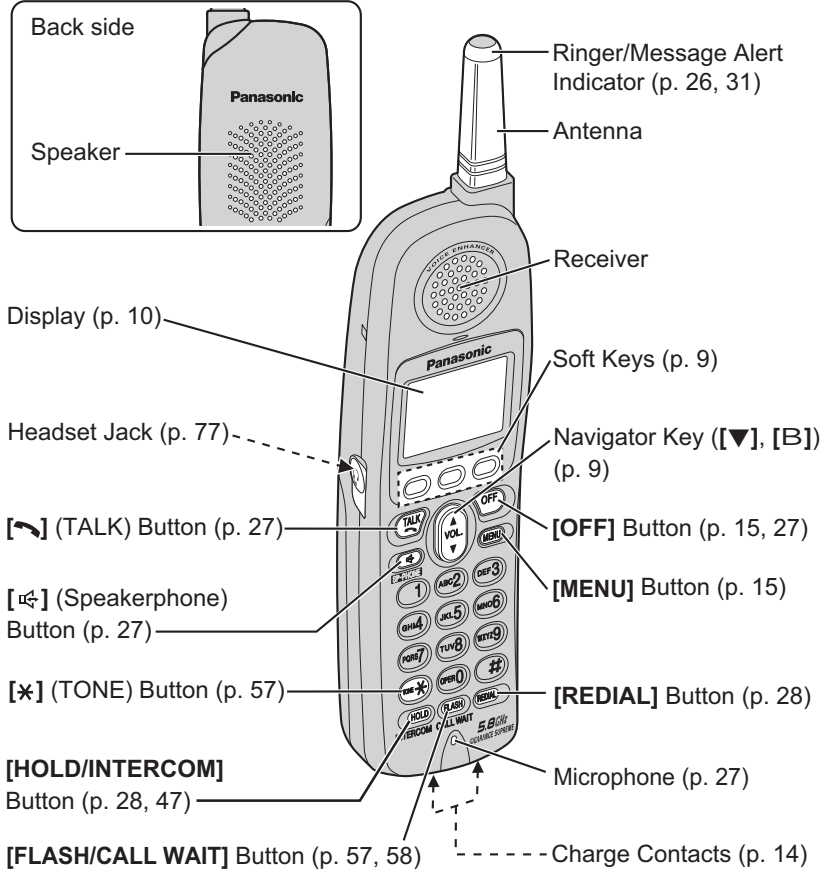

### Charger unit (KX-TG5243 only)

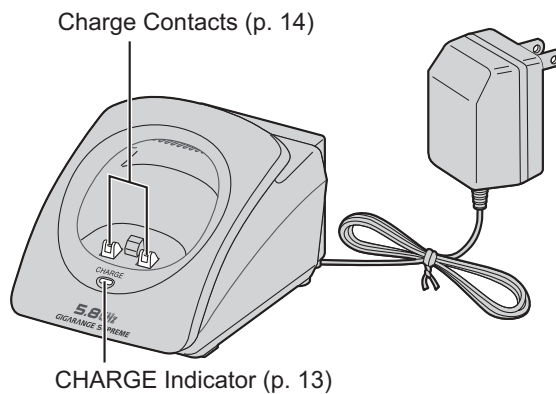



## Location of Controls

### How to use the soft keys/navigator keys

#### Handset soft keys

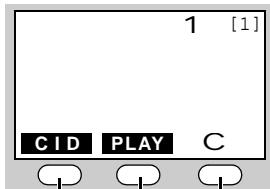

Three soft keys are used to select functions displayed directly above each key. Functions displayed above each key will change depending on the state of use.

On this sample display, “**CID**”, “**PLAY**” and “**C**” are displayed above the soft keys.

Pressing the right soft key selects the Phone Book “**C**”.

Pressing the middle soft key selects message playback “**PLAY**”.

Pressing the left soft key reviews Caller ID information in the Caller List “**CID**”.

- When a function name does not appear above a soft key, the soft key has no function.

Throughout these Operating Instructions, the soft keys are indicated by their icons, such as **CID**, **PLAY** and **C**.

Preparation

#### Handset navigator key



Scrolls up [**B**] and down [**d**] the function menu, the Caller List and the phone book.

Increases [**B**] or decreases [**d**] the handset ringer and receiver/speaker volumes.

Throughout these Operating Instructions, the handset navigator key is indicated by the arrows [**d**] or [**B**].

#### Base unit navigator key

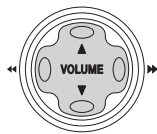

Increases [**B**] or decreases [**d**] the base unit ringer and speaker volumes.

Selects the base unit ringer tone [**H**] and [**G**].  
Repeats [**H**] or skips [**G**] recorded messages.

Throughout these Operating Instructions, the base unit navigator key is indicated by the arrows [**d**], [**B**], [**H**] or [**G**].

For assistance, please call: 1-800-211-PANA(7262)

# Displays

## Handset

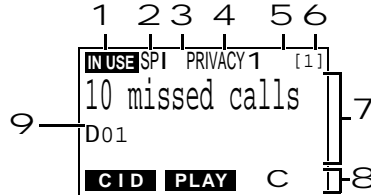

1 “**IN USE**” functions as follows.

Off (invisible)	The line is free.
On	The line is being used.
Flashing	A call is on hold on the handset or base unit, or the Answering System is answering a call (p. 63).
Flashing rapidly	A call is being received.

2 “SP” is shown when you are using the handset speakerphone.

3 “**VE**” indicates Voice Enhancer mode is on (p. 29).

4 “PRIVACY” indicates Call Privacy mode is on (p. 56). Other extension users cannot join your conversation.

5 The battery icon indicates battery strength (p. 13).

6 The extension number of your handset is displayed if it has been registered to the base unit (p. 3, 80, 81).

7 The display shows the dialed number, call status, programming options, phone book items, Caller ID information, etc.

8 The icons on the bottom line indicate the functions of the corresponding soft keys which are located directly below the display (p. 9).

Ex. The soft key below “C ” (phone book icon) is used when storing or viewing phone book items (p. 39, 41).

9 “D” (extension icon) and extension numbers are displayed (ex. base unit=“0”, handset 1= “1”)

a) during an intercom call (p. 47) or a conference call (p. 53);

b) while monitoring a room (p. 55).

## Displays

### Base unit

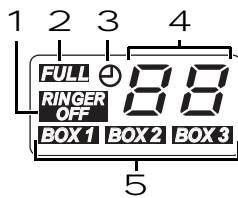

- 1 "RINGER OFF" indicates the base unit ringer is off (p. 21).
  - 2 "FULL" flashes when no new messages can be recorded. Erase unnecessary messages (p. 67).
  - 3 "E" flashes until you set the date and time, and flashes after a power failure. If it is flashing, set the date and time (p. 17).
- 4 Message counter shows:
- the total number of recorded messages in all mailboxes. If the recording time is set to "Greeting only", "G" will be displayed (p. 25).
  - the selected volume level while you are adjusting the speaker volume (p. 24, 30).
  - "P" when [PROGRAM] is pressed to store a phone number (p. 46).
  - "E" when your greeting message or memo message was not recorded correctly (p. 23, 68).
- 5 If there are new messages in a mailbox, its icon will flash. If there are only old messages, the icon will be lit. If there are no messages in a mailbox, its icon will not be shown.

Preparation

# Installation

## Connections

### Base unit

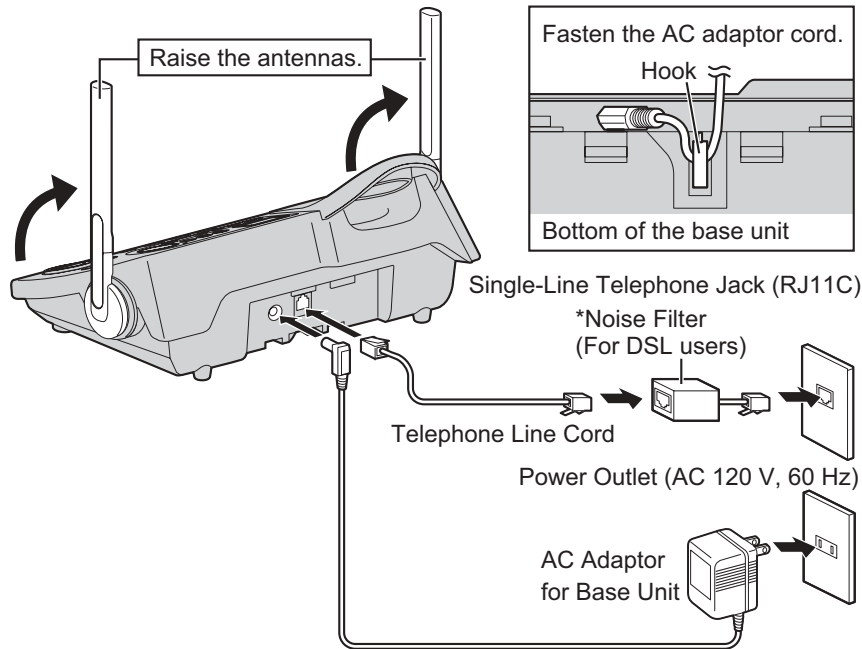

- Base unit: USE ONLY WITH Panasonic AC ADAPTOR PQLV1 (Order No. PQLV1Z).
- The AC adaptor must remain connected at all times. (It is normal for the adaptor to feel warm during use.)
- If your unit is connected to a PBX which does not support Caller ID, you cannot access Caller ID services.
- This unit will not function during a power failure. We recommend connecting a standard telephone to the same telephone line or to the same telephone jack using the Panasonic KX-J66 T-adaptor.
- \* If the unit is connected to a telephone line with DSL service, you may hear noise from the receiver or speaker during conversations or the unit may not display caller's name and/or phone number properly. We recommend connecting a noise filter (contact your DSL service provider) to the telephone line between the base unit and the telephone line jack.

### Charger unit (KX-TG5243 only)

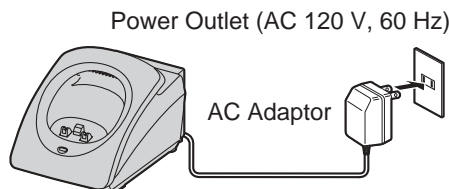

- Charger unit: USE ONLY WITH Panasonic AC ADAPTOR KX-TCA1 (Order No. KX-TCA1-G).
- The AC adaptor must remain connected at all times. (It is normal for the adaptor to feel warm during use.)

## Installation

### Installing the Battery in the Handset

Insert the battery (1), and press it down until it snaps into the compartment (2). Close the cover.

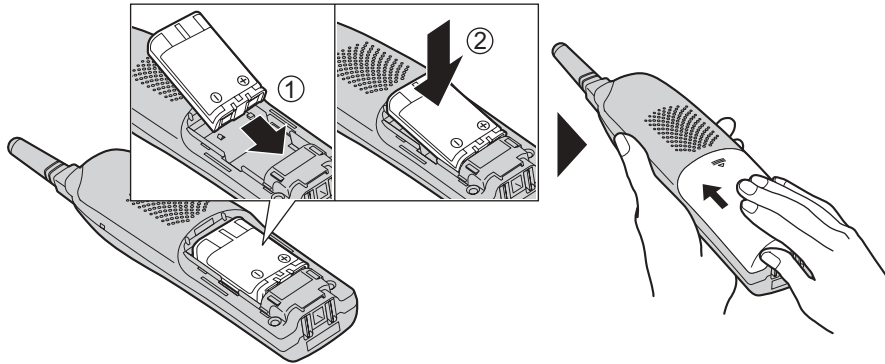

Preparation

#### To replace the battery:

Press the notch on the cover firmly and slide it as indicated by the arrow. Replace the old battery with a new one (p. 14). Close the cover and charge the handset for 6 hours.



### Battery Charge

Place the handsets on the base unit and charger for **6 hours** before initial use.

- The unit beeps once, the CHARGE indicator lights and "Charging" is displayed.
- When the battery is fully charged, "Charge completed" is displayed if there are no new calls in the Caller List.

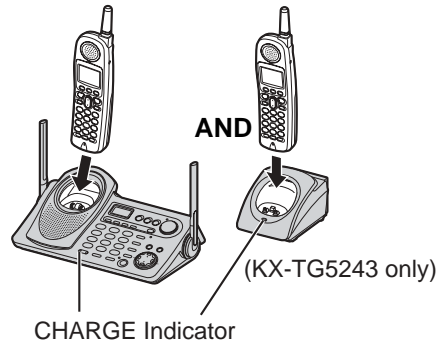

### Battery strength

You can confirm the battery strength on the handset display. Battery strength is indicated by the icons shown in the chart to the right.

Display prompt	Battery strength
1	Fully charged
2	Medium
3	Low
3 (flashing)	Needs to be recharged.
4	Discharged

For assistance, please call: 1-800-211-PANA(7262)

## Installation

### Recharge

Recharge the battery when:

- “**Recharge battery**” is displayed on the handset,
- “3” flashes, or
- the handset beeps intermittently while it is in use.

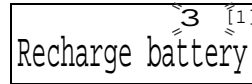

- The display will continually indicate “**Recharge battery**” and/or “3” will flash when the handset battery is charged for less than 15 minutes and the handset is lifted off the base unit or charger.
- If the battery has been discharged, the handset will display “**Charge for 6 HRS**” and “4” when you place the handset on the base unit or charger. The handset will not work unless the battery is charged. Continue charging.

#### Battery replacement:

If you cleaned the charge contacts and fully charged the battery, but after a few telephone calls, “**Recharge battery**” is displayed and/or “3” continues to flash, or “**Charge for 6 HRS**” and “4” are displayed, the battery may need to be replaced. Please order a new Panasonic HHR-P104 battery at the telephone number shown on page 2. To replace the battery, see page 13.

A nickel metal hydride battery that is recyclable powers the product you have purchased. Please call 1-800-8-BATTERY for information on how to recycle this battery.



### Battery information

After your Panasonic battery is fully charged, you can expect the following performance:

Operation	Operating time
While in use (TALK)	Up to 5 hours
While not in use (Standby)	Up to 11 days
While using the Clarity Booster feature (p. 29)	Up to 3 hours

- A fully charged battery will give you up to 5 hours of continuous talk time, or keep your handset in Standby mode to receive incoming calls for up to 11 days (if no phone calls are made). Battery power is consumed whenever the handset is off of the base unit or charger, even when the handset is not in use. The longer you leave the handset off of the base unit or charger, the time you can actually talk on the handset will be shortened. Actual battery performance depends on a combination of how often the handset is in TALK mode and how often it is in Standby mode.
- **Clean the charge contacts of the handset, the base unit and charger with a soft, dry cloth once a month. Clean more often if the unit is subject to grease, dust or high humidity.** Otherwise the battery may not charge properly.
- If the battery is fully charged, you do not have to place the handset on the base unit or charger until “**Recharge battery**” is displayed and/or “3” flashes. This will maximize the battery life.
- If you want to keep the battery fully charged at all times, place the handset on the base unit or charger when the handset is not used. The battery cannot be overcharged.
- When the Clarity Booster feature is turned on automatically or manually, battery operating time may be shortened (p. 29).

# Programmable Settings

## Programming Guidelines **Handset**

The unit has several programmable functions which can be selected from the function menu on the display (p. 16).

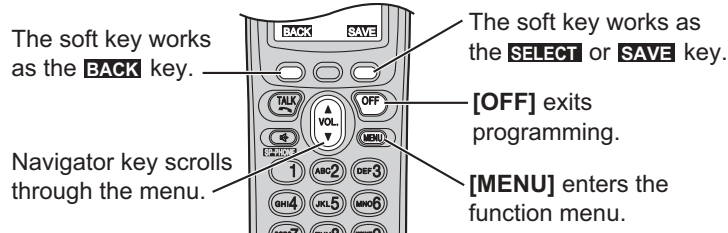

Preparation

### How to select a function item from the menu

**Make sure the handset and base unit are not being used. The handset must be operated near the base unit and while off the base unit.**

**1** Press **[MENU]**.

- The main menu is displayed (p. 16).

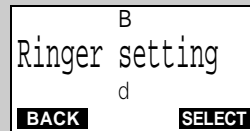

**2** Scroll to the desired item by pressing **[d]** or **[B]**.

**3** Press the soft key (**SELECT**) to select the desired item.

- 4** If the item has a sub-menu, select the menu item (p. 16). Repeat steps 2 and 3 until the desired item is displayed. If the item has no sub-menu, go to step 5.

**5** Select the desired setting by pressing **[d]** or **[B]**, then press the soft key (**SAVE**).

- A confirmation tone will be heard and the setting will be saved.

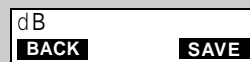

**6** Press **[OFF]** to exit programming mode.

- To go back to the previous menu, press the soft key (**BACK**), or press the soft key (**SELECT**) while "--- (Go back) ---" is displayed. If you press this key in the main menu, the unit will exit programming mode.
- After programming is complete, the display will return to the main menu or the sub-menu depending on which menu the selected item is located. (See the menu table on page 16.)
- You can exit programming mode at any time by pressing **[OFF]**.
- If you do not press any buttons for 60 seconds, the unit will exit programming mode.
- If the unit detects a problem, an error message will be displayed (p. 82–84) and/or error beeps will sound.

**For assistance, please call: 1-800-211-PANA(7262)**

## Programmable Settings

### Function Menu Table **Handset**

You can use the following functions to customize your unit. See the corresponding pages for function details.

- After pressing **[MENU]**, you can also program menu items directly by pressing (**[0]** to **[9]**, **[\*]** and **[#]**) instead of using the soft keys (p. 78–79).

Main menu	Sub-menu I	Sub-menu II
Ringer setting	Ringer volume p. 20	
Date and time p. 17	Ringer tone p. 21	
Voice enhancer p. 29	Incoming call. p. 59	
Caller IQ	*View Info.? p. 93	*"Activate CIQ?" is displayed if you have not subscribed to openLCR service.
	Get new Info.? p. 92	"Turn CIQ on?" is displayed when Caller IQ is turned off (p. 90).
	Turn CIQ off? p. 90	
Copy phone book	Copy 1 item p. 44	
Talk Caller ID p. 33	Copy all items p. 45	
Initial setting	Set answering	Number of rings p. 25
	Message alert p. 26	Recording time p. 24
	LCD contrast p. 22	Remote code p. 71
	Key tone p. 60	Set mailbox2&3 p. 62
	Auto talk p. 19	Recording mode p. 26
	Room monitor p. 54	
	Caller ID edit p. 37	Set dial mode p. 18
	Set tel line	Set flash time p. 58
		Set line mode p. 19
	Set base unit	Ringer tone p. 22
		Incoming call. p. 59
		Room monitor p. 54
		Talk Caller ID p. 34
	Registration	HS registration p. 81
		Deregistration p. 80
	Change language p. 18	

- If you program the date and time, dialing mode, flash time, line mode, number of rings, recording time, recording mode, mailbox passwords or the remote code using one of the handsets, you will not need to program the same item using another handset.



## Programmable Settings

### Date and Time **Handset**

We recommend you set the date and time so that the unit will announce the day and time each message was recorded when you play back messages.

**1** Press **[MENU]**.

**2** Scroll to "Date and time" by pressing **[d]** or **[B]**, then press the soft key **(SELECT)**.

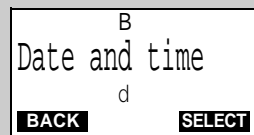

B  
Date and time  
d  
**BACK** **SELECT**

**3** (1) Enter 2 digits each for the month, day and year. (Ex. To set May 15, 2004, enter "05 15 04".)

(2) Enter 4 digits for the time (hour and minute). (Ex. To set 9:30, enter "0930".)

- If you enter a wrong number, press the soft key **(f)** or **(g)**, or press **[B]** or **[d]** to move the cursor to the incorrect number. Enter the correct number.

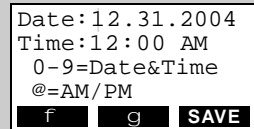

Date: 12.31.2004  
Time: 12:00 AM  
0-9=Date&Time  
@=AM/PM  
**f** **g** **SAVE**

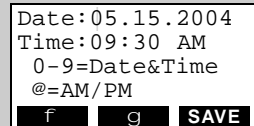

Date: 05.15.2004  
Time: 09:30 AM  
0-9=Date&Time  
@=AM/PM  
**f** **g** **SAVE**

**4** Select "AM" or "PM" by pressing **[\*]**.

**5** Press the soft key **(SAVE)**.

- The date and time are set and "E" disappears from the base unit display.
- If the handset beeps 3 times, the date and time were not set correctly. Start again from step 3.

**6** Press **[OFF]**.

- When entering the time, you cannot enter numbers greater than 12. **Do not use military time.** (To set 13:00 hours, enter "0100", and select "PM" in step 4.)

The date and time may be incorrect after a power failure. When "E" flashes on the base unit display, set the date and time again.

**To confirm the date and time**, repeat steps 1 and 2.

- The current date and time are displayed. When finished, press **[OFF]**.

#### For Caller ID service users (p. 32)

- When a call is received, Caller ID information adjusts the date and time if the time is incorrect.
- Caller ID information will automatically adjust the date and time for daylight saving time.
- If the date and time have not been previously set, Caller ID information will not adjust the date and time.

For assistance, please call: 1-800-211-PANA(7262)

## Programmable Settings

### Display Language **Handset**

You can select either “English” or “Spanish” as the display language. The factory preset is “English”.

1 Press **[MENU]**.

2 Scroll to “**Initial setting**” by pressing **[d]** or **[B]**, then press the soft key (**SELECT**).

Initial setting

3 Scroll to “**Change language**” by pressing **[d]** or **[B]**, then press the soft key (**SELECT**).

Change language

4 To change from English to Spanish, press the soft key (**ESPAÑOL**).  
To change from Spanish to English, press the soft key (**ENGLISH**).

Display  
:English

- The display changes to the selected language.
- You can also select the display language by pressing **[d]** or **[B]**.

5 When Spanish is selected, press the soft key (**GUARDAR**), then press **[OFF]**.  
When English is selected, press the soft key (**SAVE**), then press **[OFF]**.

- If you select a language you cannot read, change the display language again using direct commands (p. 79).

### Dialing Mode **Handset**

If you have touch tone service, set the dialing mode to “Tone”. For rotary or pulse service, set to “Pulse”. The factory preset is “Tone”.

1 Press **[MENU]**.

2 Scroll to “**Initial setting**” by pressing **[d]** or **[B]**, then press the soft key (**SELECT**).

Initial setting

3 Scroll to “**Set tel line**” by pressing **[d]** or **[B]**, then press the soft key (**SELECT**).

Set tel line

4 Press the soft key (**SELECT**) at “**Set dial mode**”.

Set dial mode

5 Select “**Pulse**” or “**Tone**” by pressing **[d]** or **[B]**.

Set dial mode  
:Tone

6 Press the soft key (**SAVE**), then press **[OFF]**.

## Programmable Settings

### Line Mode **Handset**

The line mode is preset to "B" and generally should not be adjusted. If "IN USE" is not displayed on the handset properly, the line mode selection is incorrect. Set line mode to "A".

Preparation

1 Press **[MENU]**.

2 Scroll to "Initial setting" by pressing [d] or [B], then press the soft key **(SELECT)**.

Initial setting

3 Scroll to "set tel line" by pressing [d] or [B], then press the soft key **(SELECT)**.

Set tel line

4 Scroll to "set line mode" by pressing [d] or [B], then press the soft key **(SELECT)**.

Set line mode

5 Select "A" or "B" by pressing [d] or [B].

Set line mode  
:B

6 Press the soft key **(SAVE)**, then press **[OFF]**.

### Auto Talk **Handset**

The Auto Talk feature allows you to answer calls by simply lifting the handset off the base unit or charger (for KX-TG5243 or accessory handset users, p. 3). You do not need to press [C] or [S]. The factory preset is OFF.

1 Press **[MENU]**.

2 Scroll to "Initial setting" by pressing [d] or [B], then press the soft key **(SELECT)**.

Initial setting

3 Scroll to "Auto talk" by pressing [d] or [B], then press the soft key **(SELECT)**.

Auto talk

4 Select "on" or "off" by pressing [d] or [B].

Auto talk  
:Off

5 Press the soft key **(SAVE)**, then press **[OFF]**.

- In order to view Caller ID information after you lift the handset to answer a call, leave the Auto Talk feature turned off.

## Programmable Settings

### Ringer Volume

You can set the handset and base unit ringer volumes to high, medium, low, or off. The factory preset is HIGH. If the handset or base unit ringer is turned off, the handset or base unit will ring at the low level for intercom calls, and will not ring for outside calls. Caller names will not be announced even if the Talking Caller ID feature is turned on (p. 33, 34).

#### Handset ringer volume **Handset**

1 Press **[MENU]**.

2 Press the soft key (**SELECT**) at “Ringer setting”.

Ringer setting

3 Press the soft key (**SELECT**) at “Ringer volume”.

Ringer volume

4 Select the desired volume by pressing **[d ]** or **[B]**.

- The volume will change and ring.
- The number of steps indicates the volume level.
- **To turn the ringer off**, press **[d ]** repeatedly until “off ?” is displayed.

Ex. High

Ringer volume  
Low  High

Ex. Off

Ringer volume  
Off ?

5 Press the soft key (**SAVE**).

- If the handset ringer is turned off, the handset displays “Ringer off” while not in use.
- You can also adjust the ringer volume while an outside call is ringing. Press **[d ]** or **[B]** while the handset is ringing.

#### Temporary ringer off

While the handset is ringing for an outside call, you can turn the ringer off temporarily by pressing **[OFF]**. The handset will ring again as normal the next time a call is received.

## Programmable Settings

### Base unit ringer volume **Base Unit**

Make sure the base unit is not being used.

To set the ringer volume to high (preset), medium, or low, press [d] or [B].

- To increase volume, press [B]. To decrease volume, press [d].
- To stop ringing, press [STOP].

To turn the ringer off, press and hold [d] until 2 beeps sound.

- "RINGER OFF" is displayed.

To turn the ringer on, press [d] or [B].

- The base unit will ring at the low level.
- You can adjust the ringer volume while an outside call is ringing. Press [d] or [B] while the base unit is ringing. To turn the ringer off, press and hold [d] until 2 beeps sound. "RINGER OFF" is displayed.

Preparation

### Ringer Tone

You can set the handset and base unit ringers to use one of 7 ringer patterns for outside calls. "Tone 1" to "Tone 3" are bell ringer patterns. "Melody 1" to "Melody 4" are preset melody patterns. The factory preset is "Tone 1".

- You cannot change the ringer tone for intercom calls.
- If you subscribe to a Distinctive Ring Service (such as IDENTA-RING) from your telephone company with 2 or 3 consecutive rings, select a bell ringer pattern (Tone 1 to 3). If you select a melody pattern, you will not be able to distinguish lines by their ringers.
- If you select one of the melody ringer patterns, the ringer will continue to sound for several seconds if:
  - the caller hangs up before you answer the call, or
  - another person answers the call using another phone connected on the same line.

### Handset ringer tone **Handset**

1 Press [MENU].

2 Press the soft key (SELECT) at "Ringer setting".

Ringer setting

3 Scroll to "Ringer tone" by pressing [d] or [B], then press the soft key (SELECT).

Ringer tone

4 Select the desired ringer tone by pressing [d] or [B].

Ringer tone  
1:Tone 1

- The handset will ring and the ringer tone will change. If the ringer volume has been turned off, the handset will not ring (p. 20).
- You can also select the ringer tone by pressing [1] to [7].

5 Press the soft key (SAVE), then press [OFF].

For assistance, please call: 1-800-211-PANA(7262)

## Programmable Settings

### Base unit ringer tone (use either the handset or the base unit)

#### Base Unit

Make sure the base unit is not being used.

- 1 Press [H ] or [G ].
  - The base unit will ring using the current ringer tone. If the ringer volume has been turned off, the base unit will not ring (p. 21).
- 2 Press [H ] or [G ] repeatedly to select the desired tone.
  - Each time you press [H ] or [G ], another ringer tone will be heard and selected.
  - To stop ringing, press [STOP].
  - You can also select the ringer tone by pressing [1] to [7].
    - [1] to [3]: Bell ringer patterns      [4] to [7]: Melody patterns

#### Selecting the base unit ringer tone by using the Handset

- 1 Press [MENU].
- 2 Scroll to "Initial setting" by pressing [d ] or [B], then press the soft key [SELECT].
- 3 Scroll to "set base unit" by pressing [d ] or [B], then press the soft key [SELECT].
- 4 Press the soft key [SELECT] at "Ringer tone".
- 5 Follow steps 4 and 5 of "Handset ringer tone" on page 21.
  - When selecting the ringer tone, the base unit will ring. If the base unit ringer volume has been turned off (p. 21), the base unit will not ring.

### LCD Contrast Handset

There are 6 levels of LCD contrast. The factory preset is "level 3".

- 1 Press [MENU].
- 2 Scroll to "Initial setting" by pressing [d ] or [B], then press the soft key [SELECT].
- 3 Scroll to "LCD contrast" by pressing [d ] or [B], then press the soft key [SELECT].
- 4 Select the desired contrast by pressing [d ] or [B].
  - The contrast will change.
  - The number of steps indicates the contrast level.
- 5 Press the soft key [SAVE], then press [OFF].

Initial setting

LCD contrast

Ex. Level 3

LCD contrast  
Low █ High

## Preparing the Answering System

### Greeting Message **Base Unit**

You can record a personal greeting message of **up to 2 minutes**. If you do not record your own message, one of two pre-recorded greetings will be played for callers (p. 24).

The total recording time of all messages (greeting, incoming and memo) is **about 16 minutes**. We recommend you record a **brief greeting message** in order to leave more time for recording new messages.

- You can use the enhanced recording mode for clearer sound, if necessary (p. 26).

### To record a greeting message

#### Greeting message samples

N "Hello, this is (your name and/or number). Sorry, I cannot take your call. Please leave a message after the beep. Thank you."

N **To instruct callers to leave a message in a specific mailbox (Mailbox 1, Mailbox 2, or Mailbox 3) (for mailboxes see page 61):**

"Hello, this is (your name and/or number). Sorry, we cannot take your call. If you have a message, for John press [#] and [1], for Jane press [#] and [2], for Jack press [#] and [3], before the beep. Or just stay on the line and leave a message after the beep. Thank you."

#### 1 Press **[GREETING REC]**.

- "To record greeting, press RECORD again" is heard.

#### 2 Within 10 seconds, press **[GREETING REC]** again to record your greeting.

#### 3 After the long beep, talk clearly, about 20 cm (8 inches) away from the **MIC** (microphone).

- The elapsed recording time is displayed.
- If you record for over 2 minutes, the unit will stop recording.

#### 4 When finished, press **[GREETING REC]** or **[STOP]**.

- To change the greeting, start again from step 1.

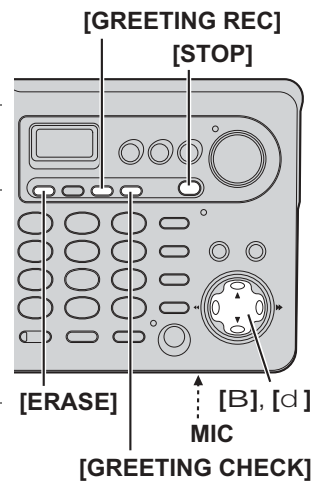

- If "E" is displayed, 6 beeps sound and "Your greeting was not recorded. Record your greeting again." is announced, start again from step 1.

## Preparing the Answering System

### To review the greeting

Press **[GREETING CHECK]**.

**To adjust the speaker volume**, press **[d ]** or **[B]** during playback.

- 9 levels (0–8) are available while using the Answering System. The level is displayed on the base unit.

### To erase the greeting

Press **[GREETING CHECK]**, then press **[ERASE]** while the recorded message is being played.

- The unit will answer calls with a pre-recorded greeting (see below).

### Pre-recorded greeting

If you do not record a greeting (p. 23), one of two greetings will be played when a call is received, depending on the caller's recording time (see below).

**To review the pre-recorded greeting**, press **[GREETING CHECK]**.

- A pre-recorded greeting will be played as follows:

N When the recording time is set to "1 minute", "2 minutes" or "3 minutes":

"Hello, we are not available now. Please leave your name and phone number after the beep. We will return your call."

- If recording time runs out, the unit will automatically switch to the "Greeting only" mode (see below), and no new messages will be recorded.

N When the recording time is set to "Greeting only": "Hello, we are not available now. Please call again. Thank you for your call."

#### Flash Memory Message Backup (Message storage)

Messages stored in memory will not be affected by power failures. All messages are saved until you erase them.

### Caller's Recording Time **Handset**

You can select "1 minute", "2 minutes", "3 minutes" or "Greeting only" for the caller's recording time. The factory preset is "3 minutes".

**1** Press **[MENU]**.

**2** Scroll to "Initial setting" by pressing **[d ]** or **[B]**, then press the soft key **(SELECT)**.

Initial setting

**3** Press the soft key **(SELECT)** at "Set answering".

Set answering



## Preparing the Answering System

- 4** Scroll to “**Recording time**” by pressing [c] or [B], then press the soft key (**SELECT**).

Recording time

- 5** Select the recording time by pressing [c] or [B].

- You can also select the recording time by pressing [1], [2], [3], or [0] (Greeting only).

Recording time  
:3min

- 6** Press the soft key (**SAVE**), then press [OFF].

If you select “**Greeting only**”, the unit will answer a call with the greeting message, and then hang up. The unit will not record any incoming messages. The base unit will display “☐☐” instead of the number of messages.

Preparation

### Number of Rings **Handset**

You can select the number of times the unit rings before the Answering System answers a call, from “2” to “7” or “Toll saver”\*. The factory preset is “4”.

- 1** Press [MENU].

- 2** Scroll to “**Initial setting**” by pressing [c] or [B], then press the soft key (**SELECT**).

- 3** Press the soft key (**SELECT**) at “**Set answering**”.

- 4** Press the soft key (**SELECT**) at “**Number of rings**”.

Number of rings

- 5** Select the number of rings by pressing [c] or [B].

- You can also select the number of rings by pressing [0] (Toll saver\*), or [2] to [7].
- The unit will announce a caller’s name after the 2nd ring (Talking Caller ID, p. 32, 33). To listen to the name announcements, do not select “2”.

Number of rings  
:4

- 6** Press the soft key (**SAVE**), then press [OFF].

#### \*Toll saver

When you call the unit from a remote location, the number of rings will tell you if there are any new messages. If the unit answers on the 2nd ring, there is at least one new message. If the unit answers on the 4th ring, there are no new messages. To save the toll charges for the call, hang up immediately when you hear the 3rd ring. The 3rd ring indicates that there are no new messages.

- The unit will announce a caller’s name after the 2nd ring (Talking Caller ID, p. 32, 33). If “Toll saver” is selected, and there is a new message, the unit will not announce the caller’s name.

For assistance, please call: 1-800-211-PANA(7262)

## Preparing the Answering System

### Recording Mode **Handset**

Two recording modes are available. The factory preset is “Standard recording (16 min)”, which provides more recording time (16 min) and standard sound quality. “Enhanced recording (8 min)” provides less recording time (8 min) but clearer sound quality.

- 1 Press **[MENU]**.
- 2 Scroll to “**Initial setting**” by pressing **[d ]** or **[B]**, then press the soft key **(SELECT)**.
- 3 Press the soft key **(SELECT)** at “**set answering**”.
- 4 Scroll to “**Recording mode**” by pressing **[d ]** or **[B]**, then press the soft key **(SELECT)**.
 

Recording mode
----------------
- 5 Select the recording mode by pressing **[d ]** or **[B]**.
  - You can also select the recording mode by pressing **[1]** (Standard) or **[2]** (Enhanced).

Recording mode :Standard recording 16min
--
- 6 Press the soft key **(SAVE)**, then press **[OFF]**.

### Message Alert **Handset**

You can select whether or not the Ringer/Message Alert indicator on the handset will flash slowly when new messages have been recorded (p. 64). The factory preset is OFF.

- 1 Press **[MENU]**.
- 2 Scroll to “**Initial setting**” by pressing **[d ]** or **[B]**, then press the soft key **(SELECT)**.
- 3 Scroll to “**Message alert**” by pressing **[d ]** or **[B]**, then press the soft key **(SELECT)**.
 

Message alert
---------------
- 4 Select “**on**” or “**off**” by pressing **[d ]** or **[B]**.
 

Message alert :Off
-----------------------
- 5 Press the soft key **(SAVE)**, then press **[OFF]**.

- The Ringer/Message Alert indicator will not flash for new messages while the handset is in use.
- The Ringer/Message Alert indicator acts as a ringer indicator and as a message alert indicator. This indicator will flash rapidly when a call is received whether this feature is on or off.
- Battery operating time may be shortened when using this feature (p. 14).

## Making Calls

### System capabilities (Operating more than one handset, p. 3)

Up to 3 extensions (3 handsets or 2 handsets and the base unit) can operate at a time. The maximum operating number may decrease depending on the state of use.

### Using the Handset **Handset**

- 1 Press [C ].
  - "Ta1k" is displayed.
- 2 Dial a phone number.
  - The dialed number is displayed.
  - After a few seconds, the display will show the length of the call.
- 3 To hang up, press [OFF] or place the handset on the base unit or charger (for KX-TG5243 or accessory handset users, p. 3).

### To have a hands-free phone conversation

- 1 Press [S ].
  - "SP-phone" is displayed.
- 2 Dial a phone number.
  - The dialed number is displayed.
  - After a few seconds, the display will show the length of the call.
- 3 When the other party answers, talk into the microphone.
- 4 To hang up, press [OFF] or place the handset on the base unit or charger.

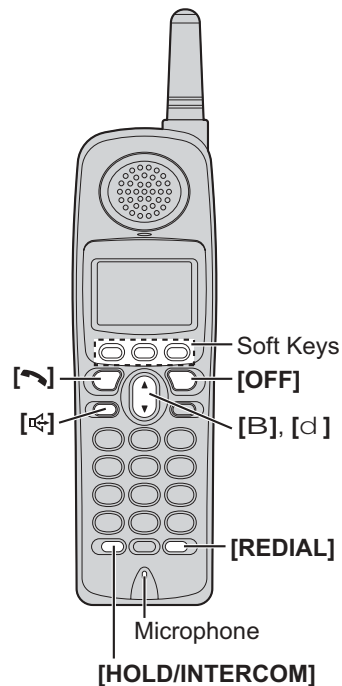

Telephone System

### Hands-free Digital Duplex Speakerphone

For best performance, please note the following:

- Talk alternately with the other party in a quiet room.
- If you or the other party has difficulty hearing, press [d ] to decrease the speaker volume.
- While talking using [C ], you can switch to a hands-free phone conversation by pressing [S ]. To switch back to the receiver, press [C ].

For assistance, please call: 1-800-211-PANA(7262)

## Making Calls

### To dial after confirming the entered number

1. Enter a phone number.

3334444

- If you misdial, press the soft key **(CLEAR)**. Enter the correct phone number.
  - If a pause is required when dialing, press the soft key **(PAUSE)** where needed (p. 56).
  - To cancel, press **[OFF]**.
2. Press **[C ]** or **[S]**.
  3. To hang up, press **[OFF]** or place the handset on the base unit or charger.

### To adjust the receiver/speaker volume during a conversation

There are 3 volume levels for the receiver and 6 volume levels for the speaker.

To increase volume, press **[B]**.  
To decrease volume, press **[d ]**.

Ex. Receiver volume: High  
Speaker volume: Level 6

Volume  
Low  High  
dB

- The display shows the current volume setting.
- If you try to increase/decrease volume when it is at the maximum/minimum level, the handset will beep 3 times.

### To redial the last number dialed

Press **[C ]** or **[S]**, then press **[REDIAL]**.

### To redial using the redial list (Memory Redial)

The last 5 phone numbers dialed are stored in the redial list.

1. Press **[REDIAL]**.
  - The last number dialed is displayed.
2. Scroll to the desired number by pressing **[d ]** or **[B]**.
  - You can also scroll down through the list by pressing **[REDIAL]**.
  - To exit the list, press **[OFF]**.
3. Press **[C ]** or **[S]**.
  - **To erase an item**, scroll to the item then press the soft key **(ERASE)**.
  - If "No items stored" is displayed, the list is empty.

### To put a call on hold

1. Press **[HOLD/INTERCOM]** during a conversation.
  - "Press extension# to transfer" is displayed.
  - To transfer the call to the base unit or another handset, see page 50; to transfer to a mailbox, see page 69.
2. Press **[HOLD/INTERCOM]** again.
  - "Hold" is displayed.

**To return to the call**, press **[C ]** or **[S]**.

- The base unit user can also take the call by pressing **[SP-PHONE]**.
- Another handset user can also take the call by pressing **[C ]** or **[S]**.
- If another phone is connected on the same line (p. 12), you can also take the call by lifting its handset.
- If a call is kept on hold for 6 minutes, an alarm tone will start to sound and the Ringer/Message Alert indicator will start to flash rapidly. After 4 additional minutes on hold, the call will be disconnected.

## Making Calls

### Voice Enhancer Technology

Panasonic's Voice Enhancer Technology clarifies the voice of the person you are talking to, reproducing a more natural-sounding voice that is easier to hear and understand. Voice Enhancer Technology can be turned on or off. The factory preset is OFF.

- Depending on the condition and quality of your telephone line, this feature may emphasize existing line noise. If it becomes difficult to hear, turn this feature off.

**To turn this feature on**, press the soft key **(VE)** during a conversation.

- **"VE"** is displayed.
- **To turn this feature off**, press the soft key **(VE)** again. **"VE"** disappears from the display.

- After hanging up a call, the on/off setting will be retained.

When the handset is not in use, you can also turn this feature on or off by programming as follows:

1. Press **[MENU]**.
2. Scroll to **"voice enhancer"** by pressing **[d]** or **[B]**, then press the soft key **(SELECT)**.
3. Select **"on"** or **"off"** by pressing **[d]** or **[B]**.
4. Press the soft key **(SAVE)**, then press **[OFF]**.

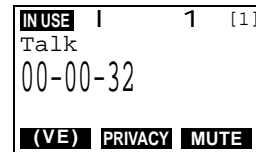

### Clarity Booster

This feature can improve sound clarity when the handset is used in an area where there may be interference. During an outside call, this feature will be turned on automatically when necessary. This feature will turn off when you hang up, put a call on hold, or make a conference call. It will not turn off automatically during a call. You can also turn this feature on or off manually.

1. Press **[MENU]** during an outside call.
2. Press **[2]** to select **"2=Booster on"** or **"2=Booster off"**.

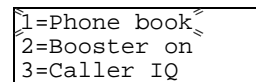

- You can also select **"2=Booster on"** or **"2=Booster off"** by pressing **[d]** then pressing the soft key **(SELECT)**.
- While this feature is turned on, **"Booster on"** will flash during a conversation.
- If this feature is turned off manually during a call, it will not be turned on automatically during the same call.
- When this feature is turned on automatically or manually, battery operating time may be shortened (p. 14).
- The maximum number of extensions which can be used at a time may decrease when using this feature.

### Backlit LCD display/Lighted handset keypad

The handset display and dialing buttons will light for a few seconds after pressing a button or lifting the handset off the base unit or charger (for KX-TG5243 or accessory handset users, p. 3). They will also light when an intercom/outside call is being received.

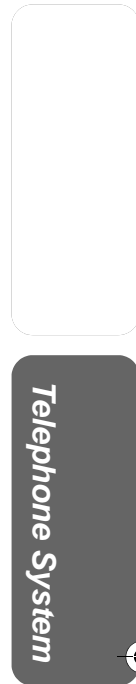

## Making Calls

### Using the Base Unit **Base Unit**

- 1 Press **[SP-PHONE]**.
  - The indicator lights.
- 2 Dial a phone number.
  - If you misdial, press **[SP-PHONE]** and start again from step 1.
- 3 When the other party answers, talk into the **MIC** (microphone).
- 4 To hang up, press **[SP-PHONE]**.
  - The indicator light goes out.

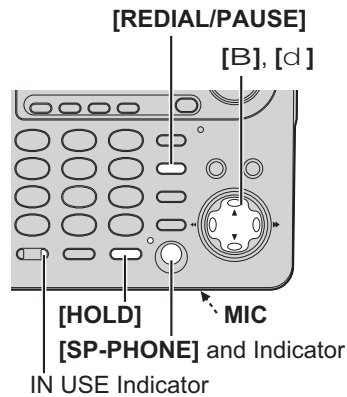

- To switch to the handset while using the base unit speakerphone:
  - If the handset is off the base unit, press **[C]** or **[S]** on the handset, then press **[SP-PHONE]** on the base unit.
  - If the handset is on the base unit, just lift up.

#### Hands-free Digital Duplex Speakerphone

For best performance, please note the following:

- Talk alternately with the other party in a quiet room.
- If you or the other party has difficulty hearing, press **[d]** to decrease the speaker volume.

#### To adjust the speaker volume during a conversation

To increase volume, press **[B]**. To decrease volume, press **[d]**.

- There are 8 volume levels. If you try to increase/decrease volume when it is at the maximum/minimum level, the base unit beeps 3 times. The level is displayed on the base unit.

#### To redial the last number dialed

Press **[SP-PHONE]**, then press **[REDIAL/PAUSE]**.

#### To put a call on hold

Press **[HOLD]** during a conversation.

- The SP-PHONE indicator and IN USE indicator flash.

To return to the call, press **[SP-PHONE]**.

- The handset users can also take the call by pressing **[C]** or **[S]**.
- If another phone is connected on the same line (p. 12), you can also take the call by lifting its handset.
- If a call is kept on hold for 6 minutes, an alarm tone will start to sound. After 4 additional minutes on hold the call will be disconnected.

## Answering Calls

When a call is received, the unit rings, "Incoming call" is displayed, and the Ringer/Message Alert indicator on the handset and the IN USE indicator on the base unit flash rapidly.

### Handset

- 1 Press [C ] or [S].
  - You can also answer a call by pressing any button except [d ], [B] or [OFF].
- 2 To hang up, press [OFF] or place the handset on the base unit or charger.

### Auto Talk

If the Auto Talk feature is turned on (p. 19), you can answer a call by simply lifting the handset off the base unit or charger (for KX-TG5243 or accessory handset users, p. 3).

### Temporary ringer off

While the handset is ringing for an outside call, you can turn the ringer off temporarily by pressing [OFF]. The handset will ring again as normal the next time a call is received.



### Base Unit

- 1 Press [SP-PHONE].
- 2 Talk into the MIC.
- 3 To hang up, press [SP-PHONE].

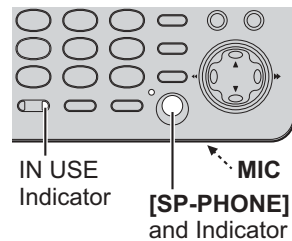

- To transfer the call to another extension, see page 50.
- To transfer the call to a mailbox to allow the caller to leave a message, see page 69.
- If the ringer volume is turned off, the unit will not ring (p. 20, 21).

Telephone System

## Caller ID Service

This unit is compatible with Caller ID services offered by your telephone company. If you subscribe to Caller ID, caller names and phone numbers will be displayed and recorded in the Caller List.

### How Caller ID information is displayed and announced

When a call comes in, the unit will ring and Caller ID information will be received. The handset display will show the caller's information, then the handset and base unit will announce the displayed name (ex. "Call from ROBINSON, TINA") following every ring (**Talking Caller ID feature**, p. 33).

Example

ROBINSON, TINA
1-555-222-3333

- The handset and base unit announce the caller's name repeatedly until the call is answered.
- After you answer the call, the display will show the length of the call.
- If the unit does not receive Caller ID information, one of the following will be displayed:

Display	Meaning
Out of area	The caller dialed from an area which does not provide Caller ID service.
Private caller	The caller requested not to send his/her information.
Long distance	The caller made a long distance call.

- Depending on radio communications with the base unit, the handset may not display Caller ID information immediately after the first ring.
- If your unit is connected to a PBX which does not support Caller ID, you cannot access Caller ID service.
- Name display service may not be available in some areas. For further information, please contact your telephone company.
- If you subscribe to both Caller ID and Call Waiting with Caller ID service (CWID), when a second call is received while talking, a call waiting tone will be heard and the second caller's information will be displayed (p. 57). Contact your telephone company for details about availability in your area, and to verify that CWID service is activated on your telephone line.



## Caller ID Service

### Talking Caller ID **Handset** **Base Unit**

To use this feature, you need to subscribe to Caller ID. For further information, please contact your telephone company.

- If the unit does not receive Caller ID information, the unit will announce “Call from out of area”, “Call from private caller”, or “Call from long distance”. If a call is received from an area where name display service is not available, “Number available” will be announced.
- If the ringer volume of the handset and the base unit is off, caller names will not be announced. The announcement is heard at the handset or base unit ringer volume (p. 20, 21).
- If this feature is not turned on, caller names will not be announced (see below and page 34).
- If an outside call is received while on an intercom call between the handset and base unit, other handsets will ring, but the caller’s name will not be announced.
- If you have Call Waiting service, the second caller’s information will be displayed but not announced (For Call Waiting Service Users, p. 57).
- Name pronunciation may vary. Name pronunciation quality is based on names most commonly used in the United States.
- The unit will announce each letter of abbreviations, such as “Co.” and “Inc.”.
- Caller ID supports names of up to 15 letters. If the caller’s name has more than 15 letters, the name will not be displayed or announced correctly.
- If you subscribe to a Distinctive Ring Service (such as IDENTA-RING) from your telephone company with 2 or 3 consecutive rings, your unit may mute one or more of the rings in order to announce the name of the caller.
- The unit will announce the caller’s name after the 2nd ring. If you turn on the Answering System (p. 63), and set the number of times the unit rings to “2” (p. 25), the unit will not announce the caller’s name. If “Toll saver” is selected (p. 25), and there is a new message, the unit will not announce the caller’s name.

Telephone System

### To turn on or off Talking Caller ID feature

You can turn on or off Talking Caller ID feature for the handset and base unit separately. If this feature is turned off, the unit will not announce caller names. The factory preset is ON.

#### Handset Talking Caller ID feature **Handset**

1 Press **[MENU]**.

2 Scroll to “**Talk Caller ID**” by pressing **[d ]** or **[B]**, then press the soft key **(SELECT)**.

Talk Caller ID

3 Select “**off**” or “**on**” by pressing **[d ]** or **[B]**.

Talk Caller ID  
:On

4 Press the soft key **(SAVE)**, then press **[OFF]**.

For assistance, please call: 1-800-211-PANA(7262)

## Caller ID Service

### Base unit Talking Caller ID feature **Handset**

This feature must be turned on or off for the base unit by using the handset.

1 Press **[MENU]**.

2 Scroll to "Initial setting" by pressing **[d]** or **[B]**, then press the soft key **(SELECT)**.

Initial setting

3 Scroll to "set base unit" by pressing **[d]** or **[B]**, then press the soft key **(SELECT)**.

Set base unit

4 Scroll to "Talk Caller ID" by pressing **[d]** or **[B]**, then press the soft key **(SELECT)**.

Talk Caller ID

5 Select "off" or "on" by pressing **[d]** or **[B]**.

Talk Caller ID  
:On

6 Press the soft key **(SAVE)**, then press **[OFF]**.

## Using the Caller List

The unit can record information up to 50 different callers and store this information in the Caller List. Caller information is sorted by the most recent call to the oldest. When the 51<sup>st</sup> call is received, the information from the 1<sup>st</sup> call is deleted.

The unit will also tell you how many calls you missed while you were out or unavailable to answer the phone.



2 Stands for Caller ID

1 The handset display will show the number of calls you missed.

2 Press the soft key **(CID)**, **[d]**, or **[B]** to review other calls logged in the Caller List.

- If there are no items in the Caller List, "**CID**" will not be displayed.
- After viewing the missed call entries, "missed calls" will disappear from the display.

## Using the Caller List

### Viewing the Caller List **Handset**

- 1 Press the soft key (**CID**), [d ], or [B ] to enter the Caller List.

Ex. 10 calls missed.

```

Caller list
10 missed calls
dB=Scroll list
    
```

- 2 To search from the most recent call, press [d ]. To search from the oldest call, press [B ].
  - The caller's name, number and the time and date of the call are displayed.

Example

```

SMITH, JACK
1-555-333-4444
3:10P JUN.10
    
```

- 3 Press [OFF] to exit the list.

- If there is no name information for a caller, the display will only show the phone number.
- Each handset has its own Caller List. If you viewed the Caller List or answered a call on one handset, the same information in the other handsets will be displayed as "missed".
- If you do not press any buttons for 60 seconds, the unit will exit the Caller List.

#### What "√" means

"√" indicates you have already viewed this calling information or answered the call. If the same caller calls again, the call entry with the "√" will be replaced with the new call entry.

```

SMITH, JACK
1-555-333-4444
3:10P JUN.10 √
    
```

#### If a caller calls more than once

The number of times the same caller called is displayed ("x2" to "x9"). The date and time of the most recent call will be recorded. After viewing a caller's information, "x2" to "x9" will be replaced with "√".

Ex. Called 3 times.

```

TURNER, CINDY
1-555-456-7890
11:20A JAN.12 x3
    
```

### Calling Back from the Caller List **Handset**

- 1 Press the soft key (**CID**), [d ], or [B ] to enter the Caller List.
- 2 Scroll to the desired caller by pressing [d ] or [B ].
- 3 Press [C ] or [S ].
  - The phone number is dialed.

- In some cases, you may have to edit the number before dialing (p. 36). (Ex. You may have to delete "1" and the area code.)
- If a phone number is not displayed in the caller information, you cannot call that caller back from the Caller List.

For assistance, please call: 1-800-211-PANA(7262)

## Using the Caller List

### Editing the Caller's Phone Number **Handset**

You can edit a phone number in the Caller List by removing its area code and/or the long distance code "1".

Once you call back an edited number, this unit can automatically edit incoming phone numbers from the same area code in the Caller List and each time you receive a call (**Caller ID Number Auto Edit**, p. 37).

**1** Press the soft key (**CID**), [d], or [B] to enter the Caller List.

**2** Scroll to the desired caller by pressing [d] or [B].

PARKER, FRED  
1-555-321-5555

**3** Press the soft key (**EDIT**) repeatedly until the number is shown in the desired format.

- Each time you press the soft key (**EDIT**), the number is rearranged into one of 3 patterns.

F [Phone no.]

G [Area code] - [Phone no.]

H 1- [Area code] - [Phone no.]

- The order in which patterns F -H are displayed depends on how the telephone number is displayed in step 2.

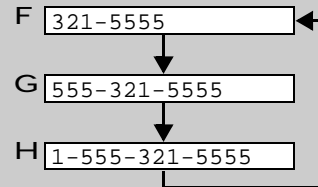

**4** To call the edited number, press [C] or [S].

- If Caller ID Number Auto Edit feature is turned on (factory preset is on), phone numbers with the same area code as the number you edited will now be updated in the Caller List and each time you receive a call.
- You can press [OFF] immediately after pressing [C] or [S] if you wish to activate the Auto Edit feature without actually dialing the number you just edited.

To save the edited number into the phone book, press the soft key (**SAVE**).

- If there is no name information, see "Storing Caller Information in the Phone Book" on page 38, from step 3.
- Even if the Auto Edit feature is turned on, phone numbers in the Caller List and the phone book will not be updated. To update the numbers in the phone book, it is necessary to manually store the phone numbers from Caller List to the phone book (p. 38).

## Using the Caller List

### Caller ID Number Auto Edit **Handset**

Once you call back an edited number (p. 36), this unit can automatically edit incoming phone numbers from the same area code in the Caller List and each time you receive a call. For example, it can ignore the area code of calls originating from your area code, so that you can call these numbers from the Caller List without dialing the area code.

**To activate this feature**, you must edit a caller's phone number in the Caller List (p. 36) by selecting pattern **F**, **G**, or **H**, then make a call to that number. Calls from numbers in that area code will be edited automatically. The unit can remember up to 4 area codes to be edited according to patterns **F** and **G**.

When more than 5 area codes are edited, older area codes are reset to pattern **H**. Phone numbers from the 4 most recently edited area codes will be automatically edited.

You can turn this feature on or off using the handset. The factory preset is **ON**.

### To turn on or off Caller ID Number Auto Edit feature

**1** Press **[MENU]**.

**2** Scroll to "Initial setting" by pressing **[d]** or **[B]**, then press the soft key **(SELECT)**.

Initial setting

**3** Scroll to "Caller ID edit" by pressing **[d]** or **[B]**, then press the soft key **(SELECT)**.

Caller ID edit

**4** Select "off" or "on" by pressing **[d]** or **[B]**.

Auto edit  
:On

**5** Press the soft key **(SAVE)**, then press **[OFF]**.

- If you fail to reach your destination when making a call, the phone number you dialed might have an incorrect pattern. Edit the phone number with another pattern (p. 36).
- When this feature is turned off, the unit will still be able to display Caller ID, but incoming Caller ID numbers will not be automatically edited.
- If you move to another area you may need to turn this feature off to erase the previously edited area codes. To use this feature again, turn it on and reprogram the area codes you want to be edited once again.

## Using the Caller List

### Storing Caller Information in the Phone Book **Handset**

Caller names and phone numbers that are in the Caller List can be stored in the phone book.

- 1 Press the soft key (**CID**), [d ], or [B] to enter the Caller List.
- 2 Scroll to the desired caller by pressing [d ] or [B].
  - If the number requires editing, see page 36.
- 3 Press the soft key (**SAVE**).
  - If there is no name information for the caller, "Enter name" will be displayed.
    - You can enter a name by performing the following steps:
      - (1) enter the name (p. 40),
      - (2) press [d ], and
      - (3) press the soft key (**SAVE**).
    - If a name is not required, press [d ], then press the soft key (**SAVE**).
  - To continue storing other items, repeat from step 2.
  - To exit programming mode, press **[OFF]**.

- You cannot store Caller List items in the phone book if a phone number is not displayed.

### Erasing Caller Information **Handset**

#### To erase a specific caller

- 1 Press the soft key (**CID**), [d ], or [B] to enter the Caller List.
- 2 Scroll to the desired caller by pressing [d ] or [B].
- 3 Press the soft key (**ERASE**).
  - "Erased" is displayed.
  - To erase other items, repeat from step 2.
  - To exit the Caller List, press **[OFF]**.

#### To erase all entries

- 1 Press the soft key (**CID**), [d ], or [B] to enter the Caller List.
  - Before erasing all entries, make sure that "0 missed call" is displayed.
- 2 Press the soft key (**ERASE**).
  - "All erase?" is displayed.
  - To cancel erasing, press the soft key (**NO**).
- 3 Press the soft key (**YES**).
  - "All erased" is displayed and all entries in your Caller List are erased.

## Phone Book

The handset can store up to 50 names and phone numbers in its phone book. You can make a call by selecting a name or number from the phone book, and copy phone book items from one handset to another (p. 44, 45).

### Storing Names and Numbers **Handset**

**1** Press the soft key ( **C** ).

- The display will show the number of stored items.

```
Phone book
 10 items
0-9=Name search
dB=Scroll list
```

**2** Press the soft key ( **ADD** ).

**3** Enter a name of up to 16 characters with the dialing buttons (**[0]** to **[9]**) (p. 40), then press **[d]**.

- To move the cursor, press the soft key ( **f** ) or ( **g** ).
- If a name is not required, press **[d]** then go to step 4.

```
Enter name
Tom
d=Next
```

**4** Enter a phone number of up to 32 digits.

- To delete a digit, press the soft key ( **CLEAR** ).
- To erase all of the digits, press and hold the soft key ( **CLEAR** ).

```
Enter phone no.
5557654321
d=Next
```

**5** Press **[d]**.

- If you want to change the name, press the soft key ( **EDIT** ). The display returns to step 3. Change the name.
- If you want to change the number, press **[B]**. The display returns to step 4. Change the number.

```
Tom
555-765-4321
```

**6** Press the soft key ( **SAVE** ).

- To continue storing other items, repeat from step 2.

**7** Press **[OFF]**.

- If a pause is required when dialing, press the soft key ( **PAUSE** ) in step 4. A pause is stored in a phone number as one digit (p. 56).
- To store numbers for calling card access (see "Chain Dial" on page 42), we recommend you add pauses after each item. Storing pauses with numbers will prevent misdialing (p. 56). The delay time necessary will depend on your telephone company.

Telephone System

## Phone Book

### Selecting characters to enter names

Enter names using the dialing buttons. Press each button until the desired character is displayed.

- Pressing each button selects a character in the order shown below.

Keys	Characters	Keys	Characters
[1]	# & ' ( ) ; , - . / 1	[6]	m n o M N O 6
[2]	a b c A B C 2	[7]	p q r s P Q R S 7
[3]	d e f D E F 3	[8]	t u v T U V 8
[4]	g h i G H I 4	[9]	w x y z W X Y Z 9
[5]	j k l J K L 5	[0]	0 Space
<b>f</b>	Moves the cursor to the left.		
<b>g</b>	Moves the cursor to the right. (To enter another character using the same number key, move the cursor to the next space.)		

**For example, to enter "Tom":**

- Press [8] four times.
- Press [6] three times, then press the soft key (**g**) to move the cursor.
- Press [6] once.

T
To
Tom

### If you make a mistake while entering a name or number

- Press the soft key (**f**) or (**g**) to move the cursor to the incorrect character.
- Press the soft key (**CLEAR**) to delete the character.
  - Each time you press the soft key (**CLEAR**), a character is erased.
  - To erase all characters, press and hold the soft key (**CLEAR**).
- Enter the correct character.



## Phone Book

### Dialing from the Phone Book **Handset**

- 1 Press the soft key (C ).
  - The display shows the number of stored items.
  - You can press the soft key (**SEARCH**) to view the first item.

Phone book  
10 items  
0-9=Name search  
dB=Scroll list

- 2 Scroll to the desired item. To scroll down, press [d ]. To scroll up, press [B].

Phone book items are sorted in the following order:

1	Alphabet letters (Alphabetical)
2	Space & ' ( ) , - . /
3	Numbers 0 to 9
4	# ;
5	Telephone numbers (If no name is stored)

Frank  
555-456-7890

- 3 Press [C ], [S], or the soft key (**CALL**).
  - The phone number is dialed.

- If "No items stored" is displayed in step 1, the phone book is empty.
- To exit the phone book, press [**OFF**].

#### To search for a name by initial

1. Press the soft key (C ).
2. Press the dialing button for the first letter of the desired name until any name with the same initial is displayed (see the Index table below).  
Ex. To find "Frank", press [3] repeatedly until the first item under "F" is displayed.
  - If there are no items beginning with the character you selected, the first item in the next alphabetical index will be displayed.
3. Press [d ] repeatedly until the desired name is displayed.

#### Index table

Keys	Index	Keys	Index
[1]	Symbols, 1	[6]	M, N, O, 6
[2]	A, B, C, 2	[7]	P, Q, R, S, 7
[3]	D, E, F, 3	[8]	T, U, V, 8
[4]	G, H, I, 4	[9]	W, X, Y, Z, 9
[5]	J, K, L, 5	[0]	0, Space

For assistance, please call: 1-800-211-PANA(7262)

## Phone Book

### Chain Dial **Handset**

You can dial a combination of phone book or manual key pad entries while making a call. This feature can be used, for example, to first automatically dial a calling card access number that you have stored in the phone book, then manually or automatically dial your PIN and then automatically dial the destination number from the phone book.

Ex. Using a long distance calling card

- To prevent misdialing, we recommend you add pauses where needed when storing numbers. For example, add pauses after a calling card access number and your PIN when storing in the phone book (p. 39).
1. Search and dial from the phone book: 1-800-012-3456 (Calling card access number)
    - The voice guidance may be announced.
  2. Search and dial from the phone book: 1234 (Calling card PIN)
  3. Search and dial from the phone book: 1-555-012-3456 (Destination Number)

**1** While you are on a call;  
Press **[MENU]**.

1=Phone book  
2=Booster on  
3=Caller IQ

**2** Press the soft key (**SELECT**) at “1=Phone book”, or press **[1]**.

Phone book  
30 items  
0-9=Name search  
dB=Scroll list

**3** Search for the desired item by pressing **[d]** or **[B]**.  
• To search for an item by initial, see page 41.

Alan  
1-555-012-3456

**4** Press the soft key (**CALL**).  
• The phone number is dialed.  
• If required, repeat steps 1 to 4 for any remaining numbers.

- If you have rotary or pulse service, you need to press **[\*]** before pressing **[MENU]** in step 1 to change the dialing mode temporarily to tone.

## Phone Book

### Editing an Item in the Phone Book **Handset**

1 Press the soft key ( **C** ).

2 Scroll to the desired item by pressing [ **d** ] or [ **B** ].

- To search for the item by initial, see page 41.

Jane  
456-7890

3 Press the soft key ( **EDIT** ).

Enter name  
Jane  
d=Next

4 Edit the name (p. 40), then press [ **d** ].

- If you do not need to change the name, press [ **d** ] then go to step 5.
- To move the cursor, press the soft key ( **f** ) or ( **g** ).

Enter name  
Jane Walker  
d=Next

5 Edit the phone number, then press [ **d** ].

- If you do not need to change the number, press [ **d** ] then go to step 6.
- To delete a digit, press the soft key ( **CLEAR** ).  
To delete all of the digits, press and hold the soft key ( **CLEAR** ).

Enter phone no.  
5554567890  
d=Next

6 Press the soft key ( **SAVE** ).

- To continue editing other items, repeat from step 2.

7 Press [ **OFF** ].

### Erasing an Item in the Phone Book **Handset**

1 Press the soft key ( **C** ).

2 Scroll to the desired item by pressing [ **d** ] or [ **B** ].

- To search for the item by initial, see page 41.

3 Press the soft key ( **ERASE** ).

- To cancel erasing, press the soft key ( **NO** ).

Erase?

4 Press the soft key ( **YES** ).

- To erase other items, repeat from step 2.

Erased

5 Press [ **OFF** ].

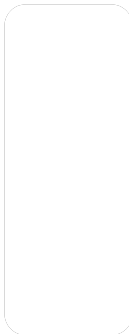

## Phone Book

### Copying Items in the Phone Book **Handset** (When the System Has Two or More Handsets)

You can copy one or all phone book items between two handsets. The destination handset will save the items in its phone book.

- If an outside call is received during the phone book copy, copying will stop. You will need to re-send the item(s) later.
- After the copy has started, do not place your handset on the base unit or charger (for KX-TG5243 or accessory handset users, p. 3) until copying finishes, otherwise copying will stop.

#### To copy one phone book item to another handset

Make sure the destination handset is not in use.

1 Press **[MENU]**.

2 Scroll to "Copy phone book" by pressing **[d]** or **[B]**, then press the soft key **(SELECT)**.

Copy phone book

3 Press the soft key **(SELECT)** at "Copy 1 item".

Copy 1 item

4 Select the destination extension number (1 to 4) by pressing **[d]** or **[B]**.

- You can also select the extension number by pressing **[1]** to **[4]**.

Enter extension#  
:2  
dB

5 Press the soft key **(NEXT)**.

Select item

6 Scroll to the desired phone book item by pressing **[d]** or **[B]**.

- To search for the item by initial, see page 41.

7 Press the soft key **(SEND)**.

- To continue copying other items, repeat from step 6.

Complete

8 Press **[OFF]**.

## Phone Book

### To copy all of the items in your phone book to another handset

Make sure the destination handset is not in use.

**1** Press **[MENU]**.

**2** Scroll to "Copy phone book" by pressing **[d]** or **[B]**, then press the soft key **(SELECT)**.

Copy phone book

**3** Scroll to "Copy all items" by pressing **[d]** or **[B]**, then press the soft key **(SELECT)**.

Copy all items

**4** Select the destination extension number (1 to 4) by pressing **[d]** or **[B]**.

- You can also select the extension number by pressing **[1]** to **[4]**.

Enter extension#  
:2  
dB

**5** Press the soft key **(SEND)**.

- When all items have been copied, "Complete" is displayed.
- The destination handset displays "Phone book Receiving" then "Phone book Received".
- To continue copying items to another extension, repeat from step 3.

Ex. Copying 1st item out of 10 items

Tom Jones  
555-765-4321  
01/10

**6** Press **[OFF]**.

- You can exit phone book copying mode by pressing **[OFF]**.

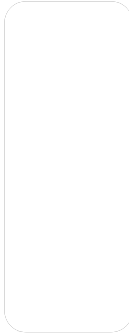

## Speed Dialer

### Storing Phone Numbers **Base Unit**

You can store up to 10 phone numbers in the base unit. The dialing buttons ([0] to [9]) function as memory stations.

**Make sure the base unit is not being used.**

- 1 Press **[PROGRAM]**.
  - The IN USE indicator flashes and “P” is displayed.

- 2 Enter a phone number of up to 32 digits.
  - The last digit of the entered number is displayed.
  - If you misdial, press **[PROGRAM]**, and start again from step 1.

- 3 Press **[AUTO]**.

- 4 Press a memory station number ([0] to [9]).
  - A long beep sounds and the phone number is saved.
  - To store other numbers, repeat from step 1.

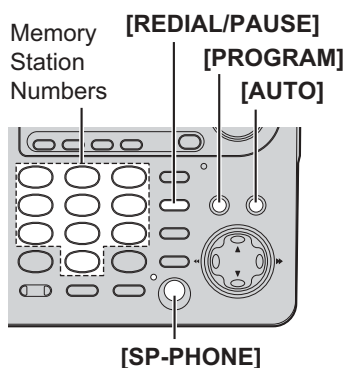

- If a pause is required when dialing, press **[REDIAL/PAUSE]** where needed. “P” is displayed when **[REDIAL/PAUSE]** is pressed. A pause counts as one digit (p. 56).
- When [\* ] is pressed, “\*” is displayed. When [#] is pressed, “#” is displayed.
- If a phone number is stored in a memory location which already contains a phone number, the old number will be erased.
- We recommend you make a note of which phone numbers are stored in which memory locations.

### To erase a stored number

1. Press **[PROGRAM]**, then press **[AUTO]**.
2. Press the memory station number ([0] to [9]) for the phone number to be erased.
  - A long beep sounds and the phone number is erased.

### Dialing a Stored Phone Number **Base Unit**

- 1 Press **[SP-PHONE]**.
- 2 Press **[AUTO]**.
- 3 Press a memory station number ([0] to [9]).
  - The stored number is dialed.

- Speed dial numbers stored in the base unit can only be dialed from the base unit.

# Intercom

Intercom calls can be made between a handset and the base unit, and between two handsets (when the system has two or more handsets, p. 3). You can page all handsets at once from the base unit, and announce the page to all handsets (**Voice Paging**, p. 49).

Page the desired unit(s) by entering the extension number, shown in the top right of each handset's display. The base unit's extension number is 0.

## Making Intercom Calls

### From **Handset**

<p><b>1</b> Press [<b>HOLD/INTERCOM</b>].</p>	<p>Press extension# to call 1-4=Handset 0=Base</p>
<p><b>2</b> To page the base unit, press [<b>0</b>]. To page another handset, press its extension number (<b>[1]</b> to <b>[4]</b>).</p> <ul style="list-style-type: none"> <li>• The paged unit will ring for 1 minute.</li> <li>• To stop paging, press [<b>OFF</b>].</li> </ul>	<p>Ex. Calling Base unit Calling Base</p> <p>Ex. Calling Handset 2 Calling HS[2]</p>
<p><b>3</b> When the paged party answers, start talking.</p> <ul style="list-style-type: none"> <li>• You can switch to the speaker by pressing [<b>S</b>]. To switch back to the receiver, press [<b>C</b>].</li> </ul>	<p>Ex. Intercom between Handset 1 &amp; Base unit</p> <p>Intercom 00-00-05 D01</p>
<p><b>4</b> To disconnect the intercom, press [<b>OFF</b>].</p>	

### From **Base Unit**

Using this feature, you can also locate a misplaced handset.

<p><b>1</b> Press [<b>LOCATOR/INTERCOM/TRANSFER</b>].</p> <ul style="list-style-type: none"> <li>• The LOCATOR/INTERCOM/TRANSFER and SP-PHONE indicators light.</li> </ul>
<p><b>2</b> To page all handsets, press [<b>0</b>]. To page a specified handset, press its extension number <b>[1]</b> (<i>/</i>) to <b>[4]</b> (<i>/</i>).</p> <ul style="list-style-type: none"> <li>• The handset(s) will ring for 1 minute.</li> <li>• To stop paging, press [<b>SP-PHONE</b>] or [<b>LOCATOR/INTERCOM/TRANSFER</b>].</li> </ul>
<p><b>3</b> When the paged party answers, talk into the <b>MIC</b>.</p>
<p><b>4</b> To disconnect the intercom, press [<b>SP-PHONE</b>] or [<b>LOCATOR/INTERCOM/TRANSFER</b>].</p> <ul style="list-style-type: none"> <li>• The indicator lights go out.</li> </ul>



## Intercom

### During an intercom call:

- If you have difficulty hearing while using the speakerphone on the handset or base unit, decrease the speaker volume by pressing [d].
- If an incoming call is being received, you will hear two tones (incoming call tone, p. 59) and the IN USE indicator on the base unit will flash rapidly.  
To answer the call;
  - if using the handset, press [OFF], then press [C] or [S].
  - if using the base unit, press [SP-PHONE] twice.

## Answering Intercom Calls

### Handset

When a handset is paged, it rings and the Ringer/Message Alert indicator flashes rapidly. The display shows the calling extension.

#### 1 Press [C], [S] or [HOLD/INTERCOM].

- You can also answer a page by pressing any button except [d], [B] or [OFF].

Ex. Base calling

Call from Base

Ex. Handset 2 calling

Call from HS[2]

#### 2 To disconnect the intercom, press [OFF].

- If the Auto Talk feature is turned on (p. 19), you can also answer a page by simply lifting the handset off the base unit or charger (for KX-TG5243 or accessory handset users, p. 3).

### Base Unit

When the base unit is being paged, it rings and the LOCATOR/INTERCOM/TRANSFER indicator flashes.

#### 1 Press [SP-PHONE] or [LOCATOR/INTERCOM/TRANSFER].

#### 2 To disconnect the intercom, press [SP-PHONE] or [LOCATOR/INTERCOM/TRANSFER].

- When the ringer volume is turned off (p. 20, 21), the handset and the base unit will ring at the low level for intercom calls.
- You cannot change the ringer tone for intercom calls.
- When the base unit user pages all handsets, only the handset user who answers first can talk with the base unit user.



## Intercom

### Voice Paging **Base Unit**

The base unit user can make a voice announcement that is heard through the speakers of all handsets.

- When 4 handsets are registered to the base unit, and if one handset user is on conversation using the Booster feature, 1 of the remaining 3 handsets will not receive the voice announcement.

**1** Press [**LOCATOR/INTERCOM/TRANSFER**].

- The LOCATOR/INTERCOM/TRANSFER and SP-PHONE indicators light.

**2** To make a voice announcement to all handsets, press [**5**] (*PAGE*).

- You will hear a ringback tone (two short beeps) and the SP-PHONE indicator flashes.

**3** When the SP-PHONE indicator stops flashing, speak into the **MIC**.

- All handset users will hear your voice through their speakers after beeps, "Ca11 from Base" will be displayed and the Ringer/Message Alert indicator will flash rapidly on the handsets.
- The handset on the base unit will not be paged.

**4** When finished, press [**SP-PHONE**] or [**LOCATOR/INTERCOM/TRANSFER**].

OR

After one of the handsets answers, talk into the **MIC**.

To disconnect the intercom, press [**SP-PHONE**] or [**LOCATOR/INTERCOM/TRANSFER**].

- Only the handset user who answers first can talk with the base unit user.
- To answer the page from the handsets, see "Answering Intercom Calls" on page 48.
- If a handset is too close to the base unit, you may hear feedback while making the voice announcement. Place the handset on the base unit or charger (for KX-TG5243 or accessory handset users, p. 3) or press [**OFF**].
- It is not possible to specify which handset(s) will hear the voice announcement.
- The announcement is heard at the handset ringer volume (p. 20).

Telephone System

## Transferring a Call

You can transfer an outside call to the base unit or a handset.

### From the **Handset** to the **Base Unit**

#### 1 Handset:

- (1) During a call, press **[HOLD/INTERCOM]**.
  - The call is put on hold.
- (2) To page the base unit, press **[0]**.
- (3) Wait for the paged party to answer, then you can announce the transfer.
  - If the paged party does not answer, press **[C ]** or **[S ]** to return to the outside call.

Press extension#  
to transfer  
1-4=Handset  
0=Base 9=Mailbox

#### 2 Base unit: Press **[SP-PHONE]** or **[LOCATOR/INTERCOM/TRANSFER]** to answer the page.

#### 3 Handset: To complete the transfer, press **[OFF]**.

### From the **Base Unit** to the **Handset**

#### 1 Base unit:

- (1) During a call, press **[LOCATOR/INTERCOM/TRANSFER]**.
  - The call is put on hold.
- (2) To page a specified handset, press its extension number **[1] ( / )** to **[4] ( / )**.  
To page all handsets, press **[0]**.  
Wait for the handset user to answer, then you can announce the transfer.  
OR  
To make a voice announcement to all handsets, press **[5] ( /PAGE )**, then speak into the **MIC** when the SP-PHONE indicator stops flashing.
  - If the paged party does not answer, press **[LOCATOR/INTERCOM/TRANSFER]** to return to the outside call.

#### 2 Handset: Press **[C ]**, **[S ]**, or **[HOLD/INTERCOM]** to answer the page.

- You can also answer a page by pressing any button except **[d ]**, **[B ]** or **[OFF]**.

#### 3 Base unit: To complete the transfer, press **[SP-PHONE]**.

- When the base unit user calls all handsets, only the handset user who answers first can take the transferred call.

## Transferring a Call

### From a **Handset** to another **Handset** (when the system has two or more handsets)

- 1 During a call, press **[HOLD/INTERCOM]**, then page another handset by pressing its extension number (**[1]** to **[4]**).
- 2 Wait for the paged party to answer, then you can announce the transfer.
  - The paged handset user can answer by pressing **[C ]**, **[S]**, or **[HOLD/INTERCOM]**. (Any button except **[d ]**, **[B]** or **[OFF]** can be pressed to answer the page.)
  - If the paged party does not answer, press **[C ]** or **[S]** to return to the outside call.
- 3 To complete the transfer, press **[OFF]**.

- If the Auto Talk feature is turned on (p. 19), the paged handset user can also answer a page by simply lifting the handset off the base unit or charger (for KX-TG5243 or accessory handset users, p. 3).
- Any user can answer a transferred call by pressing **[C ]**, **[S]**, or **[SP-PHONE]**.
- If you call an extension from the handset in step 1, and the extension is in use, the display will show **"Busy"** then **"Hold"**.  
Press **[C ]** or **[S]** to return to the outside call.  
To transfer the call to another extension, repeat from step 1.  
OR  
To transfer the call to a mailbox to allow the caller to leave a message, perform the following three steps:
  - (1) Tell the caller to press the # (pound sign) and the mailbox number of the person they want to leave a message for after you end the call (p. 61).
  - (2) Press **[HOLD/INTERCOM]**.
  - (3) Press **[9]** to transfer the caller to the Answering System greeting (p. 69).  
(The caller will hear the greeting and can select the appropriate mailbox.)

Telephone System

## Transferring a Call

### Quick call transfer

You can transfer a call without waiting for the paged party to answer.

#### Handset

1. During a call, press **[HOLD/INTERCOM]**.
2. Press the extension number (**[0]** for the base unit, **[1]** to **[4]** for the handset).
3. Press **[OFF]** to hang up.

#### Base Unit

1. During a call, press **[LOCATOR/INTERCOM/TRANSFER]**.
2. Press the extension number **[1]** ( / ) to **[4]** ( / ), or press **[0]** to page all handsets.
3. Press **[SP-PHONE]** to hang up.
  - The call will be transferred directly.
  - The paged party can answer the transferred call by pressing **[C ]**, **[S]**, or **[SP-PHONE]**.
  - After the paged party answers, the transfer is complete.
  - If the paged party does not answer:
    - for the handset, press **[C ]** or **[S]** to return to the outside call.
    - for the base unit, press **[SP-PHONE]** to return to the outside call.

- If the paged party does not answer within 60 seconds after you hang up, your phone will ring and the call will be returned to your phone. You may speak to the caller again by pressing **[C ]**, **[S]**, or **[SP-PHONE]**.

If you do not answer the call within 4 minutes, the call will be disconnected.

After speaking to the caller, you may also **transfer the caller to a mailbox** by performing the following three steps:

- (1) Tell the caller to press the # (pound sign) and the mailbox number of the person they want to leave a message for after you end the call (p. 61).
- (2) Press **[HOLD/INTERCOM]** on the handset or **[LOCATOR/INTERCOM/TRANSFER]** on the base unit.
- (3) Press **[9]** to transfer the caller to the Answering System greeting (p. 69).  
(The caller will hear the greeting and can select the appropriate mailbox.)

## Conference Calls

While you are talking with an outside caller, the base unit user or a handset user can join the conversation and establish a conference call.

### Handset

- 1 During a call, press **[HOLD/INTERCOM]**.
  - The call is put on hold.
- 2 To page the base unit, press **[0]**.  
To page another handset, press the extension number **[1] to [4]**.
- 3 When the paged party answers, press the soft key **(CONF)** on your unit to make a conference call.

### Base Unit

- 1 During a call, press **[LOCATOR/INTERCOM/TRANSFER]**.
  - The call is put on hold.
- 2 To page a handset, press the extension number **[1] (/)** to **[4] (/)**.
- 3 When the paged party answers, press **[CONF]** on your unit to make a conference call.

- To leave the conference, press **[OFF]** on the handset or press **[SP-PHONE]** on the base unit. The two other parties can continue the conversation.
- During a conference, the outside call can be placed on hold by pressing **[HOLD/INTERCOM]** on the handset or **[HOLD]** on the base unit. Internal communications between extensions are not suspended. Only the person who placed the call on hold can resume the full conference by pressing the soft key **(CONF)** on the handset or **[CONF]** on the base unit.
- One more extension can join the conference call. To join the conference call, press **[C ]**, **[s]**, or **[SP-PHONE]**. A maximum of four parties including the outside party can take part in a conference call.

## Call Share

This feature allows the base unit or the handset to join an existing outside call.

- To prevent other users from joining your conversation, turn the Call Privacy feature on (p. 56).

### To join a conversation (Call Share)

**Handset** Press **[C ]** or **[s]**.

- “Conference” is displayed.

**Base Unit** Press **[SP-PHONE]**.

- A maximum of four parties including the outside party can join a conversation.

## Room Monitor

This feature allows you to monitor a room by using the intercom feature. For example, you can monitor a baby from different areas of the house. You can call the destination unit to monitor the room. The called unit will not ring. When the system has two or more handsets (p. 3), you can monitor one handset using another. To allow other users to monitor through your unit, turn this feature on. If you want to prevent your unit from being monitored by other extensions, leave this feature off. Using the handset, this feature can be turned on or off separately for the handset and base unit. The factory preset is OFF.

### To turn Room Monitor on for the handset **Handset** (to allow other users to monitor through your handset)

1 Press **[MENU]**.

2 Scroll to "Initial setting" by pressing **[d]** or **[B]**, then press the soft key **(SELECT)**.

Initial setting

3 Scroll to "Room monitor" by pressing **[d]** or **[B]**, then press the soft key **(SELECT)**.

Room monitor

4 Select "On" by pressing **[d]** or **[B]**.

Room monitor  
:On

5 Press the soft key **(SAVE)**, then press **[OFF]**.

- To prevent your handset from being monitored, select "OFF" in step 4.

### To turn Room Monitor on for the base unit **Handset** (to allow other users to monitor through your base unit)

1 Follow steps 1 and 2 of "To turn Room Monitor on for the handset" above.

2 Scroll to "Set base unit" by pressing **[d]** or **[B]**, then press the soft key **(SELECT)**.

Set base unit

3 Scroll to "Room monitor" by pressing **[d]** or **[B]**, then press the soft key **(SELECT)**.

Room monitor

4 Select "On" by pressing **[d]** or **[B]**.

Room monitor  
:On

5 Press the soft key **(SAVE)**, then press **[OFF]**.

- To prevent your base unit from being monitored, select "Off" in step 4.

## Room Monitor

### To monitor with **Handset**

The unit to be monitored must not be in use and the handset to be monitored must be off the base unit.

**1** Press [**HOLD/INTERCOM**], then press the soft key (**MONITOR**).

**2** To call the base unit, press [**0**].  
To call another handset, press its extension number (**[1]** to **[4]**).

- To monitor from the speaker, press [**S**]. If the handset is placed on the base unit, monitoring will be stopped. You can place the handset on the charger and continue monitoring. To switch back to the receiver, press [**C**].

```
Press extension#
for room monitor
1-4=Handset
0=Base
```

```
Room monitor
00-00-05
D01
```

**3** To end monitoring, press [**OFF**].

- The monitored user can stop being monitored by:
  - on the handset, press [**OFF**] or place the handset on the base unit.
  - on the base unit, press [**LOCATOR/INTERCOM/TRANSFER**] or [**SP-PHONE**].
- “Room monitor” is also displayed on the monitored handset.
- While the base unit is monitoring or being monitored, the LOCATOR/INTERCOM/TRANSFER indicator light flashes and the SP-PHONE indicator lights.

### To monitor with **Base Unit**

The handset to be monitored must not be in use and off the base unit.

**1** Press [**LOCATOR/INTERCOM/TRANSFER**], then press [**MUTE**].

- The LOCATOR/INTERCOM/TRANSFER indicator flashes.

**2** To call the handset, press its extension number [**1**] (**/**) to [**4**] (**/**).

**3** To end monitoring, press [**LOCATOR/INTERCOM/TRANSFER**] or [**SP-PHONE**].

- The indicator light goes out.

- If the Room Monitor feature of the destination handset is off or the handset is on the base unit, busy tones will sound.

Telephone System

## Special Features

### Muting Your Conversation

During a call, you can mute your phone so the other party cannot listen to you. When muting your conversation, you can hear the other party.

**Handset** Press the soft key (**MUTE**).

- “**Mute**” will be displayed for a few seconds and “**MUTE**” will flash.
- **To release the mute**, press the soft key (**MUTE**) again.
- If you press [C ] or [S ] to switch between the receiver and speaker, the mute will be released.

**Base Unit** Press [MUTE].

- The SP-PHONE indicator flashes.
- **To release the mute**, press [MUTE] again.

### Call Privacy **Handset**

Call Privacy allows you to prevent other users from joining your conversation with an outside caller. To allow other users to join your conversation, leave this feature off. This feature is only available for the handset.

**To turn on the Call Privacy feature:**

Press the soft key (**PRIVACY**) during a conversation.

- “**PRIVACY**” will be displayed.
- To turn this feature off, press the soft key (**PRIVACY**) again during a conversation.
- While the Call Privacy feature is turned on, other users cannot join the conversation.
- Call Privacy will turn off after you hang up the call.

### Using the PAUSE Button (For PBX Line/Long Distance Calls)

**Handset Base Unit**

We recommend you press the soft key (**PAUSE**) on the handset or press [REDIAL/PAUSE] on the base unit if a pause is required for dialing with a PBX or to make a long distance call.

- “**PAUSE**” is displayed on the handset only when dialing before pressing [C ] or [S ] (p. 28), or storing numbers in the phone book (p. 39).

Ex. Line access number [9] (PBX)

[9] N Soft key (**PAUSE**) or [REDIAL/PAUSE] N

- Pressing the soft key (**PAUSE**) on the handset or [REDIAL/PAUSE] on the base unit once creates a 3.5 second pause. This prevents misdialing when you dial after confirming the entered number (p. 28) or dial a stored number (p. 41, 42, 46).
- Pressing the soft key (**PAUSE**) on the handset or [REDIAL/PAUSE] on the base unit more than once increases the length of the pause between numbers.



## Special Features

### Temporary Tone Dialing

(For Rotary or Pulse Service Users) **Handset** **Base Unit**

Press [ \* ] (TONE) before entering access numbers which require tone dialing.

- The dialing mode changes to tone. You can enter numbers to access an answering service, electronic banking service, etc. When you hang up, the dialing mode will return to pulse.

### For Call Waiting Service Users **Handset** **Base Unit**

Press [FLASH/CALL WAIT] if you hear a call waiting tone during a conversation.

- The first call is put on hold and you can answer the second call.
- To return to the first caller, press [FLASH/CALL WAIT] again.
- Call Waiting service cannot be used when the first call is put on hold or the Answering System is handling a call.
- If this function does not operate properly, consult your telephone company for details.

### Call Waiting Caller ID display **Handset**

If you subscribe to both Caller ID and Call Waiting with Caller ID services (CWID), when a second call is received while talking, the second caller's information will be displayed. After you hear a call waiting tone while talking, the display shows the caller's name with the phone number and "waiting".

BROWN, NANCY
1-555-666-7777
----Waiting-----

- Contact your telephone company for details about availability in your area, and to verify that CWID service is activated on your telephone line.
- The caller's information will only be shown on the display of the handset which is on the outside call.
- The second caller's name will not be announced even if the Talking Caller ID feature is on (p. 33).

Telephone System

## Special Features

### FLASH Button **Handset** **Base Unit**

Pressing **[FLASH/CALL WAIT]** allows you to use special features of your host PBX such as transferring an extension call, or accessing optional telephone services such as call waiting.

- Pressing **[FLASH/CALL WAIT]** cancels the mute or the Temporary Tone Dialing mode (p. 56, 57).

### Selecting the flash time **Handset**

The flash time depends on your telephone exchange or host PBX.

You can select the following flash times: "700, 600, 400, 300, 250, 110, 100 or 90 ms (milliseconds)". The factory preset is "700 ms".

- If PBX functions do not work correctly, consult your PBX supplier for the correct settings.

1 Press **[MENU]**.

2 Scroll to "Initial setting" by pressing **[d]** or **[B]**, then press the soft key **(SELECT)**.

Initial setting

3 Scroll to "set tel line" by pressing **[d]** or **[B]**, then press the soft key **(SELECT)**.

Set tel line

4 Scroll to "set flash time" by pressing **[d]** or **[B]**, then press the soft key **(SELECT)**.

Set flash time

5 Select the flash time by pressing **[d]** or **[B]**.

Set flash time  
:700ms

6 Press the soft key **(SAVE)**, then press **[OFF]**.

## Special Features

### Incoming Call Tone **Handset** **Base Unit**

During an intercom call (p. 47) or while using the Room Monitor feature, you can be informed of incoming calls by two tones.

If this feature is turned on, incoming call tones will be heard for as long as the line is ringing. If this feature is set to "2", incoming call tones will be heard only 2 times. If this feature is turned off, no tones will be heard. This factory preset is "2".

Using the handset, this feature can be set separately for the handset and base unit.

### Handset incoming call tone **Handset**

1 Press **[MENU]**.

2 Press the soft key (**SELECT**) at "Ringer setting".

Ringer setting

3 Scroll to "Incoming call." by pressing **[d]** or **[B]**, then press the soft key (**SELECT**).

Incoming call.

4 Select "on", "off" or "2" by pressing **[d]** or **[B]**.

Incoming call  
tone :2

5 Press the soft key (**SAVE**), then press **[OFF]**.

Telephone System

### Base unit incoming call tone **Handset**

1 Press **[MENU]**.

2 Scroll to "Initial setting" by pressing **[d]** or **[B]**, then press the soft key (**SELECT**).

Initial setting

3 Scroll to "set base unit" by pressing **[d]** or **[B]**, then press the soft key (**SELECT**).

Set base unit

4 Scroll to "Incoming call." by pressing **[d]** or **[B]**, then press the soft key (**SELECT**).

Incoming call.

5 Select "on", "off" or "2" by pressing **[d]** or **[B]**.

Incoming call  
tone :2

6 Press the soft key (**SAVE**), then press **[OFF]**.

## Special Features

### Key Tone **Handset**

You can select whether or not the handset keys will sound tones (key tone, confirmation tone, error tone). The factory preset is ON.

1 Press **[MENU]**.

2 Scroll to "**Initial setting**" by pressing **[d]** or **[B]**, then press the soft key (**SELECT**).

Initial setting

3 Scroll to "**key tone**" by pressing **[d]** or **[B]**, then press the soft key (**SELECT**).

Key tone

4 Select "**off**" or "**on**" by pressing **[d]** or **[B]**.

Key tone  
:On

5 Press the soft key (**SAVE**), then press **[OFF]**.

## Mailbox Features

The Answering System provides three voice mailboxes. You can share these mailboxes with other members of your family or office as you wish. Callers from touch tone phones can specify a mailbox in which to leave a message. If callers do not specify a mailbox or call from rotary telephones, messages will be recorded into Mailbox 1.

### When someone calls

When the Answering System is on (p. 63), callers will hear a greeting message (p. 23).

- While or after hearing the greeting, callers can specify a mailbox by pressing **#[#][1]** (Mailbox 1), **#[#][2]** (Mailbox 2) or **#[#][3]** (Mailbox 3). They will then hear “Please leave your message”, and they can start recording a message.
  - If you would like callers to leave messages in a specific mailbox, we recommend you record a greeting message such as: “Hello, this is (your name and/or number). Sorry, we cannot take your call. If you have a message, for John press **#[#]** and **[1]**, for Jane press **#[#]** and **[2]**, for Jack press **#[#]** and **[3]**, before the beep. Or just stay on the line and leave a message after the beep. Thank you.”
- Callers wait until the greeting ends, then they can leave a message. Messages will be automatically recorded into Mailbox 1 if no mailbox is specified.

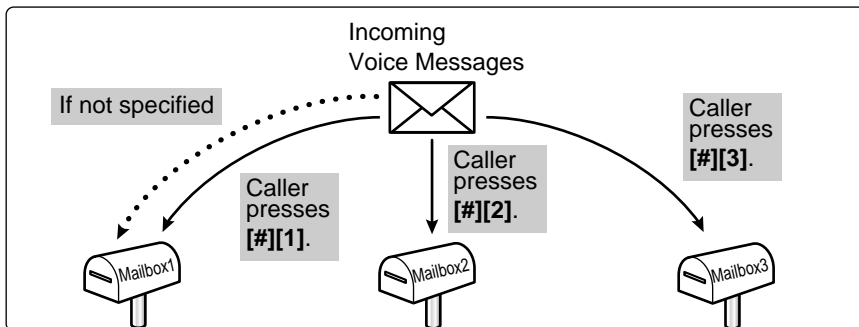

- The total recording time of all messages (greeting, incoming and memo) is **about 16 minutes** (about 8 minutes in “Enhanced recording” mode, p. 26). If messages are recorded in noisy rooms, the time may be shortened by up to 3 minutes.
- To select the caller’s recording time, see page 24.
- A maximum of 64 messages (including the greeting and memo messages) can be recorded.

### Useful information

- You can leave a memo message for other users in a mailbox with the base unit (p. 68).
- You can transfer a call to one of the mailboxes, in which callers can leave a message (p. 69).
- If you want to prevent unauthorized people from listening to messages in Mailbox 2 or 3, you can assign a password to each mailbox (p. 62).

**For assistance, please call: 1-800-211-PANA(7262)**

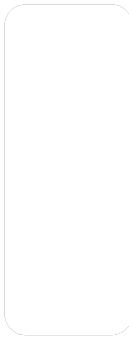

## Mailbox Features

### Setting the Mailbox Password (for Mailbox 2 and 3)

#### Handset

You can use Mailbox 2 or 3 as personal mailboxes. To prevent unauthorized people from accessing your mailbox and listening to your messages, assign a 2-digit password (00–99) to Mailbox 2 or 3. Each password and the remote code (p. 71) must be unique. Once a password is assigned to Mailbox 2 or 3, no one can listen to messages without entering the password.

**1** Press **[MENU]**.

**2** Scroll to “**Initial setting**” by pressing **[d]** or **[B]**, then press the soft key **(SELECT)**.

Initial setting

**3** Press the soft key **(SELECT)** at “**Set answering**”.

Set answering

**4** Scroll to “**Set mailbox2&3**” by pressing **[d]** or **[B]**, then press the soft key **(SELECT)**.

Set mailbox2&3

**5** Select the mailbox by pressing **[B]** (Mailbox 2) or **[d]** (Mailbox 3).

Set password  
 ^=Mailbox2  
 V=Mailbox3

**6** Enter a **2-digit password (00–99)**.

- If you entered the wrong password, re-enter the correct one.

Ex. Entered 22.

Set password  
 Mailbox2 :22

**7** Press the soft key **(SAVE)**.

- If the handset beeps 3 times, you entered the same password as the other mailbox or the remote code (p. 71), or you entered a one-digit password. Start again from step 6 and select another password.

**8** Press **[OFF]**.

**To confirm the password**, repeat steps 1 to 5.

- The password is displayed. When finished, press **[OFF]**.

#### To erase the password

Press the soft key **(CLEAR)** in step 6, press the soft key **(SAVE)**, and press **[OFF]**.

- You can access the mailbox without entering the password.

## Automatic Answering Operation

The Answering System allows the unit to answer calls with a greeting message. Callers can then leave a message in a mailbox (p. 61).

### Setting the Unit to Answer Calls **Base Unit**

Press **[ANSWER ON]** to turn on the Answering System.

- The indicator lights and the unit announces “Answer set” and the current day and time. If “Answer set. Set time” is heard, set the date and time (p. 17).
- The unit will announce the remaining recording time if it is less than 3 minutes.
- When no recording time is available, you will need to erase any unnecessary messages before new messages can be recorded (p. 67). The unit can indicate that memory is full in the following ways:
  - “**FULL**” will flash on the base unit and the ANSWER ON indicator will flash rapidly.
  - The unit will announce “Memory full” when you press **[ANSWER ON]**, **[GREETING REC]**, or **[MEMO]**, and after playing back messages or recording a message.
- If you do not want the unit to answer calls, press **[ANSWER ON]** again to turn off the Answering System. The indicator goes out and “Answer off” is heard.
- You can also turn on the Answering System remotely from an outside phone (p. 73).
- If you subscribe to Caller ID (p. 32), Caller ID information automatically adjusts the date and time when a call is received, provided you have already set the date and time manually (p. 17).

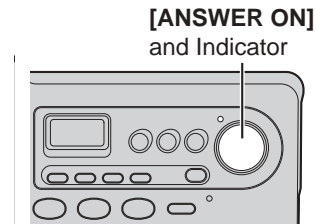

### Monitoring Incoming Calls **Base Unit**

While a caller is leaving a message, you can monitor the call through the base unit speaker.

- To increase the speaker volume while monitoring, press **[B]**. To decrease volume, press **[d]**.

To answer a call while monitoring, press **[SP-PHONE]** on the base unit or press **[C]** or **[S]** on the handset.

#### To turn the incoming call monitoring feature off

When the base unit is not in use, press **[GREETING CHECK]**, then press **[d]** repeatedly until “0” is displayed. (Make sure the Answering System is turned on.)  
OR

While monitoring, press **[d]** repeatedly until “0” is displayed.

- If the incoming call monitoring feature is turned off, it will remain off when the next call is monitored.
- If you adjust the speaker volume while playing back messages or using the speakerphone, the speaker volume for monitoring will be turned on again. To turn the speaker volume off, see “To turn the incoming call monitoring feature off” of above step.

Answering System

For assistance, please call: 1-800-211-PANA(7262)

## Listening to Messages

**Voice Day/Time Stamp:** During playback, the unit will announce the day and time when each message was recorded (p. 17).

### Using the Base Unit **Base Unit**

You can see the total number of recorded messages on the base unit display. If the ANSWER ON indicator flashes, new messages have been recorded. The mailbox icons (**BOX 1**, **BOX 2** and **BOX 3**) which have new messages also flash on the base unit display.

Ex. Mailbox 1 has new messages;  
Mailbox 2 has old messages;  
Mailbox 3 has no messages.



- If only old messages exist in a mailbox, the mailbox icon will be displayed but will not flash.
- If the Message Alert is turned on (p. 26), the Ringer/Message Alert indicator on the handset will flash slowly when new messages have been recorded and the handset is not in use.

### To play back messages

Press the MAILBOX button ([MAILBOX 1], [MAILBOX 2], or [MAILBOX 3]).

- The unit announces "Mailbox (No.)" and the number of new messages in the mailbox, then plays back the new messages.
- If the mailbox also contains old messages, only new messages will be played back.
- **When the mailbox has no new messages**, the unit announces "Mailbox (No.)" and "No new messages. All message playback", then plays back all messages in the mailbox.

#### When Mailbox 2 or 3 has a password

1. Press [MAILBOX 2] or [MAILBOX 3].

- "Enter Mailbox password" will be heard.

2. Enter the Mailbox password (p. 62).

- The unit announces "Mailbox (No.)" and the number of new messages in the mailbox, then plays back the new messages.
- If the mailbox also contains old messages, only new messages will be played back.
- **When the mailbox has no new messages**, the unit announces "Mailbox (No.)" and "No new messages. All message playback", then plays back all messages in the mailbox.

Ex. Mailbox 2



- During playback, the display shows the message number of the mailbox and the mailbox icon.
- At the end of the last message of the mailbox, "End of final message" is heard. The unit will announce the remaining recording time if it is less than 3 minutes.
- When the mailbox has no messages, the unit announces "Mailbox (No.)" and "No messages".
- If a call is received during playback, the unit rings and playback stops. To answer the call, press [SP-PHONE]. For playback, start again from the beginning after hanging up.



## Listening to Messages

### Using the Handset (Remote Operation) **Handset**

If "**PLAY**" flashes, there are new messages. If there are only old messages "**PLAY**" is displayed but will not flash.

- If the Message Alert is turned on (p. 26), the Ringer/Message Alert indicator on the handset will flash slowly when new messages have been recorded and the handset is not in use.

### To play back messages

#### 1 Press the soft key (**PLAY**).

- A beep sounds and "Please select Mailbox" will be heard from the speaker. To switch to the receiver, press [C]. To switch back to the speaker, press [S].
- The icons for mailboxes that have new messages will flash.

Ex. New messages exist.

7 missed calls

C ID PLAY C

#### 2 Press the soft key (**BOX1**, **BOX2**, or **BOX3**).

- If "Enter Mailbox password" is announced and displayed, Mailbox 2 or 3 has a password. Enter the password (p. 62).
- "Mailbox (No.)" and the number of new messages will be announced, and new messages will be played.
- When the mailbox has no new messages, the unit announces "Mailbox (No.)" and "No new messages. All message playback", and plays back all messages in the mailbox.
- To play all messages in the mailbox, press [5].
- If you do not press any button, the voice menu will start (p. 66).

Ex. Mailbox 1 has new messages.

Remote operation

BOX 1 BOX 2 BOX 3

#### 3 To end remote operation, press [OFF].

- If you do not select a mailbox in step 2, messages in Mailbox 1 will be played.
- "**PLAY**" will remain on the display after listening to messages.
- You can switch to another mailbox by pressing [#] and the mailbox number ([1] to [3]) during the remote operation.
- If a call is received during playback, the unit rings and playback stops. To answer the call, press [C] or [S]. For playback, start again from the beginning after hanging up.
- At the end of the last message, "End of final message" is heard. The unit will announce the remaining recording time if it is less than 3 minutes.
- If you hear "Memory full" after playback, erase unnecessary messages (p. 67).
- When memo messages are played (p. 68), "**MEMO**" is displayed.
- When the mailbox has no messages, the unit announces "Mailbox (No.)" and "No messages".
- During playback, you can turn the Answering System on or off. To turn the system on, press [8] during playback. To turn off, press [0].

Answering System

## Listening to Messages

### Voice menu

If you do not press any buttons at the end of the last message, the unit will announce "End of final message" and the voice menu will begin.

The unit announces, "Press 4 to play back new messages. Press 5 to play back all messages."

- You can press buttons for other playback options (see below) or select another mailbox by pressing [#] and the mailbox number ([1] to [3]) even if the voice menu has started.
- If you do not press any button within 10 seconds after the voice menu, the handset will exit remote operation.

#### For Caller ID service users (p. 32)

During playback, the handset display shows the name and/or number of the caller whose message is being played.

#### To call the displayed number:

1. Press the soft key (**CALL**).
  - The unit stops playback.
  - If you need to edit the phone number to call back, see page 36.
2. Press the soft key (**CALL**), [C ], or [S].
  - The unit dials the phone number.

### During playback **Base Unit** **Handset**

<b>To adjust the speaker volume</b>	To increase, press [B]. To decrease, press [d ]. <ul style="list-style-type: none"> <li>• You can also adjust the receiver volume on the handset.</li> </ul>
<b>To repeat a message</b>	<i>Base unit:</i> Press [H ]. <i>Handset:</i> Press the soft key ( <b>REPEAT</b> ) or [1]. <ul style="list-style-type: none"> <li>• If pressed within the first 5 seconds of playback, the previous message will be played.</li> </ul>
<b>To skip a message</b>	<i>Base unit:</i> Press [G ]. <i>Handset:</i> Press the soft key ( <b>SKIP</b> ) or [2].
<b>To stop playback</b>	<i>Base unit:</i> Press [STOP]. <ul style="list-style-type: none"> <li>• To resume playback, press the MAILBOX button ([MAILBOX 1], [MAILBOX 2], or [MAILBOX 3]) of the message that is being played.</li> <li>• If you do not press any button for 60 seconds or if you press [STOP] again, playback mode will be canceled.</li> </ul> <i>Handset:</i> Press [9]. <ul style="list-style-type: none"> <li>• If you do not press any button within 15 seconds after stopping playback, the voice menu will start (see above).</li> </ul>

## Erasing Messages

The unit will announce the remaining recording time after playback if it is less than 3 minutes. New messages cannot be recorded when:

- “Memory full” is heard.
  - “**FULL**” flashes on the base unit.
  - ANSWER ON indicator flashes rapidly (when the Answering System is on).
- Erase unnecessary messages. We recommend you erase unnecessary messages after each playback.

### Erasing a specific message

#### Base Unit

Press [**ERASE**] while the message you want to erase is being played.

- A beep sounds, then the next message is played. To exit playback mode, press [**STOP**] twice.

#### Handset

Press [**\***] [**4**] while the message you want to erase is being played.

- A beep sounds, then the next message is played. To exit remote operation mode, press [**OFF**].

### Erasing all messages in the mailbox

All recorded messages, except the greeting message, can be erased at one time.

#### Base Unit

- 1 Press [**ERASE**] while the base unit is not being used.
  - “To erase all messages, please select Mailbox” is heard.
- 2 Within 10 seconds, press the MAILBOX button (**[MAILBOX 1]**, **[MAILBOX 2]**, or **[MAILBOX 3]**).
  - You can also select the mailbox by pressing the mailbox number (**[1]** to **[3]**).
  - If Mailbox 2 or 3 has a password, enter it (p. 62).
  - A long beep sounds, then “Mailbox (No.)” and “No messages” are heard.

#### Handset

- 1 Press the soft key (**PLAY**).
- 2 Press the soft key (**BOX 1**, **BOX 2**, or **BOX 3**).
  - If Mailbox 2 or 3 has a password, enter it (p. 62).
- 3 Press [**\***] [**5**] to erase all messages in the mailbox.
  - A long beep sounds, then “Mailbox (No.)” and “No messages” are heard.
  - To end remote operation, press [**OFF**].

- Information in the Caller List will not be erased. To erase caller information, see page 38.

For assistance, please call: 1-800-211-PANA(7262)

## Recording a Memo Message

### Base Unit

You can record a voice memo message of up to 3 minutes in the desired mailbox for other users or yourself.

**1** Press **[MEMO]**.

- “Please select Mailbox” is heard.

**2** Within 10 seconds, press a MAILBOX button (**[MAILBOX 1]**, **[MAILBOX 2]** or **[MAILBOX 3]**).

- You can also select a mailbox by pressing the mailbox number (**[1]** to **[3]**).

After the long beep, talk clearly 20 cm (8 inches) away from the **MIC**.

- The base unit display shows the elapsed recording time.
- If the elapsed recording time exceeds 99 seconds, the counter continues from 00 to indicate 100 seconds.

**3** When finished, press **[MEMO]** or **[STOP]**.

- The ANSWER ON indicator, the mailbox icon (**BOX1**, **BOX2**, or **BOX3**) on the base unit and “**PLAY**” on the handset flash.

- If you record for over 3 minutes in step 2, the unit will stop recording.
- If “E” is displayed, 6 beeps sound and “Your message was not recorded. Record your message again.” is announced, start again from step 1.

## Transferring a Call to a Mailbox

### Base Unit Handset

When you answer a call and the caller wants to talk to someone who is not available, you can place the caller into one of the mailboxes, where the caller can leave a message.

Tell the outside caller you will transfer him or her to the desired party's mailbox. Remind the caller to press # (the pound sign) and the mailbox number of the desired party (if necessary).

#### 1 Base unit:

Press **[LOCATOR/INTERCOM/TRANSFER]** during a call.

*Handset:* Press **[HOLD/INTERCOM]** during a call.

- The call is put on hold.

#### Handset display

```
Press extension#
to transfer
1-4=Handset
0=Base 9=Mailbox
```

#### 2 Press **[9]** to hang up the call.

**After you press [9]:** The caller will then hear the greeting (p. 23), and while that message is playing the caller can press **[#]** and the mailbox number (**[1]** to **[3]**). Then the caller will hear "Please leave your message". The caller can leave a message in the mailbox.

OR

If the caller does not specify the mailbox, the caller can leave a message in Mailbox 1 after the greeting.

- Even if you subscribe to Caller ID service (p. 32), Caller ID information will not be displayed while the message is being played. The Caller ID information will be recorded in the Caller List (p. 34) if the transferred call is an incoming call.

### Interrupting remote operation

If another user is calling from a remote location to access a mailbox and you mistakenly answer the call, repeat steps 1 and 2 above.

- The user can then access a mailbox, by entering the remote code or the mailbox password (see "Remote Operation from a Touch Tone Phone" on page 70).

## Remote Operation from a Touch Tone Phone

While outside, you can operate the Answering System from any touch tone phone. A synthesized voice menu will guide you through the Answering System (p. 72).

- To skip the voice menu and operate the unit directly, see page 73.



### Summary of remote operation

Call your unit from a touch tone phone.

Enter the remote code (p. 71) during or after the greeting.

- “Mailbox 1” and the number of new messages of Mailbox 1 are heard, and the new messages will be played.

To access Mailbox 2 or 3, press **[#]** and the mailbox number (**[2]** or **[3]**) after entering the remote code.\*

- The mailbox number and the number of new messages in the mailbox are heard, and the new messages will be played.

If Mailbox 2 or 3 has a password (p. 62), you can enter the password during or after the greeting, to access the mailbox directly.

- The mailbox number and the number of new messages of the mailbox are heard, and the new messages will be played.

After 3 seconds, the voice menu will start (p. 72). Follow the menu or enter direct commands (p. 73).

To end remote operation, hang up.

To listen to messages in another mailbox, press **[#]** and the mailbox number (**[1]** to **[3]**).\*

\* If you hear “Enter Mailbox password” after selecting mailbox 2 or 3, enter the password for the mailbox.

- The unit will announce the remaining recording time after playback if it is less than 3 minutes.
- The messages are saved.
- If the unit announces “No new messages”, the mailbox has only old messages. If “No messages” is announced, the mailbox has no messages.

## Remote Operation from a Touch Tone Phone

### Remote Code **Handset**

The remote code prevents unauthorized people from accessing your unit and listening to your messages. Choose any **2-digit number (00–99)** for your remote code.

The factory preset remote code is "11". If you do not program your own remote code, you can use "11".

**1** Press **[MENU]**.

**2** Scroll to "Initial setting" by pressing **[d]** or **[B]**, then press the soft key **(SELECT)**.

Initial setting

**3** Press the soft key **(SELECT)** at "Set answering".

Set answering

**4** Scroll to "Remote code" by pressing **[d]** or **[B]**, then press the soft key **(SELECT)**.

Remote code

**5** Enter a **2-digit remote code (00–99)**.

Ex. Entered 35.

Remote code  
:35

**6** Press the soft key **(SAVE)**.

- If the handset beeps 3 times, the entered remote code is the same as the password (p. 62) and cannot be used. Start again from step 5 and select another code.

**7** Press **[OFF]**.

**To confirm the remote code**, repeat steps 1 to 4.

- The remote code is displayed. When finished, press **[OFF]**.

Answering System

## Remote Operation from a Touch Tone Phone

### Voice Menu

The shaded parts are voice prompts.

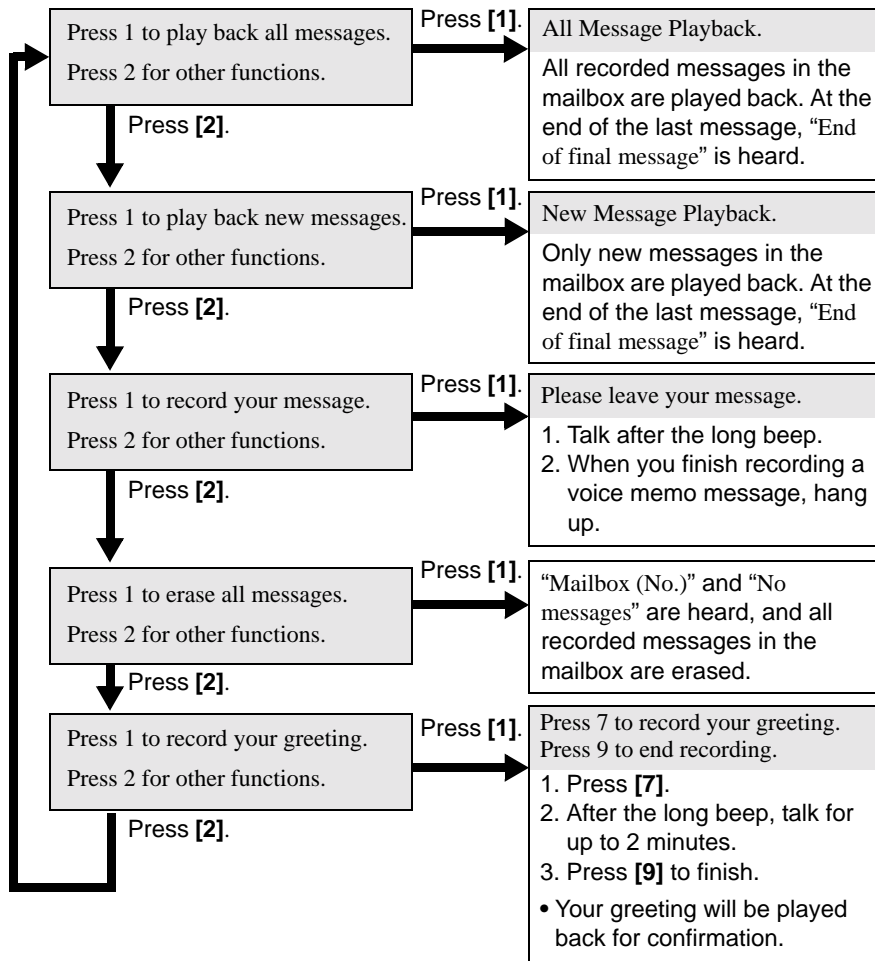

- 3 seconds after playback, the voice menu will start again from the beginning.
- The unit will announce the remaining recording time after playback if it is less than 3 minutes.
- If you hear "Memory full" after playback, erase unnecessary messages (p. 73).
- To switch to another mailbox to listen to messages, press **#** and the mailbox number (**[1]** to **[3]**) during remote operation. If you hear "Enter Mailbox password", Mailbox 2 or 3 has a password (p. 62) which must be entered.
- If you do not press any buttons within 10 seconds after a voice prompt, "Thank you for your call" will be heard and the call will be disconnected.



## Remote Operation from a Touch Tone Phone

### Direct Remote Operation

Once you have accessed one of the mailboxes (p. 70), you can also control your unit by direct commands instead of using the voice menu. To end the remote operation, hang up at anytime.

#### Direct commands

<b>[4]:</b> Plays back new messages.	<b>[* ] [4]:</b> Erases the current message. • A beep will sound and the next message will be played.
<b>[5]:</b> Plays back all messages.	
<b>[1]:</b> Repeats the current message. • If pressed within the first 5 seconds of playback, the previous message will be played.	<b>[* ] [5]:</b> Erases all messages in the mailbox. • A long beep will sound, and "Mailbox (No.)" and "No messages" will be heard.
<b>[2]:</b> Skips the current message.	<b>[#] [1]:</b> Selects Mailbox 1.
<b>[9]:</b> Stops the current operation. • To resume, enter a direct command within 15 seconds, or the voice menu will start (p. 72).	<b>[#] [2]:</b> Selects Mailbox 2.
	<b>[#] [3]:</b> Selects Mailbox 3. • If Mailbox 2 or 3 has a password (p. 62), enter it.
<b>[7] :</b> Records a greeting message. ↓ After the long beep, talk for up to 2 minutes.	<b>[0]:</b> Turns off the Answering System. • The unit hangs up.
<b>[9]:</b> Recording is stopped. • The greeting is played.	

Answering System

### Turning on the Answering System

Call your unit and wait for 15 rings.

- The unit will answer and the greeting will be played.
- The Answering System will be turned on. Hang up or enter the remote code for other options.
- When turning on the Answering System using a rotary or pulse service telephone, you cannot enter the remote code for other options.

### Skipping the greeting

After calling your unit, press [\* ] during the greeting.

- The unit skips the rest of the greeting and you can start recording your message after the long beep.

For assistance, please call: 1-800-211-PANA(7262)

## Wall Mounting

This unit can be mounted on a wall phone plate.

- 1 Connect the AC adaptor.

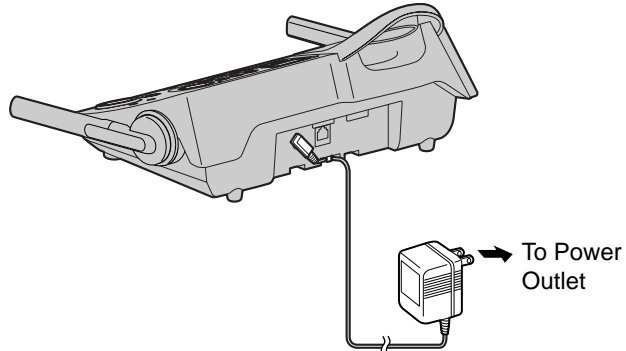

- 2 Tuck the telephone line cord inside the wall mounting adaptor (A).  
Connect the telephone line cord (B).

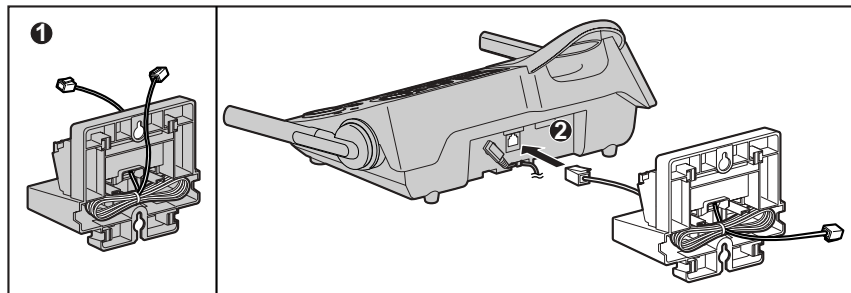

- 3 Insert the hooks on the wall mounting adaptor into the holes (A) and (B) on the base unit.

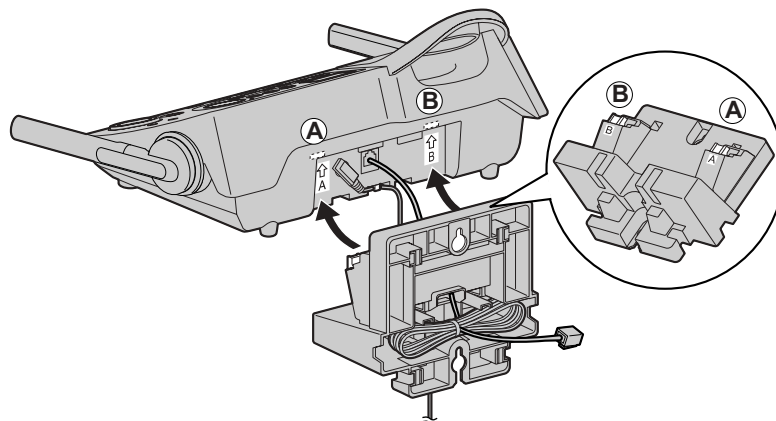

## Wall Mounting

- 4** Adjust the adaptor to hold the base unit, then push it in the direction of the arrow until it clicks into place.

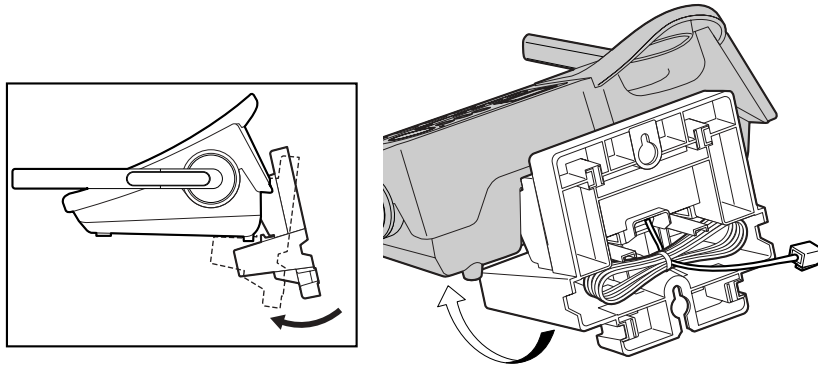

- 5** Connect the telephone line cord. Mount the unit, then slide it down.  
• Raise the antennas.

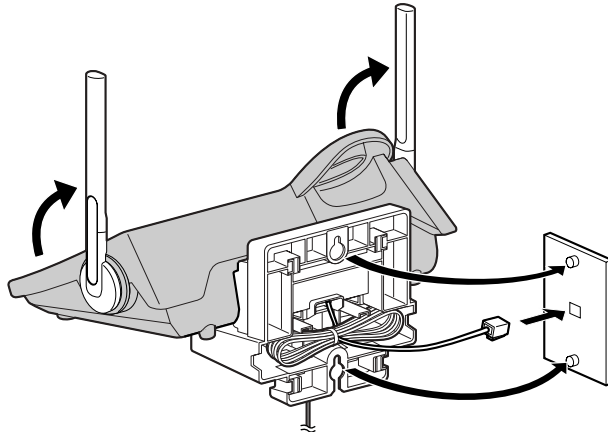

- 6 To charge the handset battery:**  
Place the handset on the base unit.  
• The unit beeps once and the CHARGE indicator lights.

Useful Information

For assistance, please call: 1-800-211-PANA(7262)

## Wall Mounting

### To remove the wall mounting adaptor

While pushing down the RELEASE LEVERS (A), remove the adaptor (B).

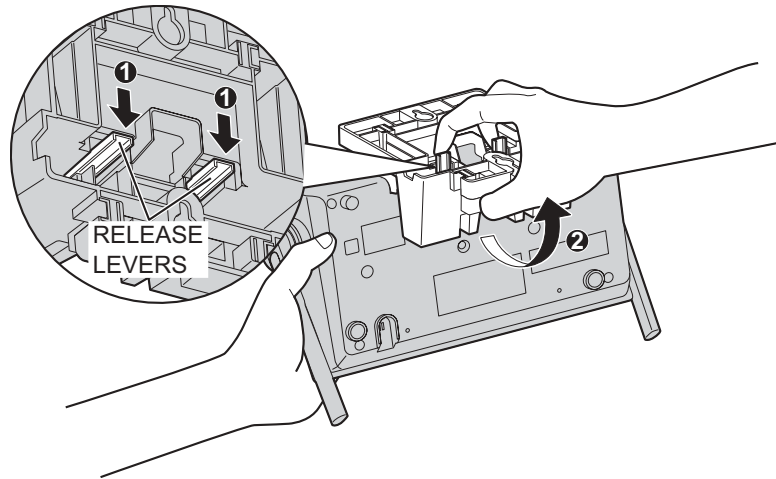

### Charger unit (KX-TG5243 only)

The charger can be wall mounted. Connect the AC adaptor. Install screws using the wall template (see below). Mount the charger (A). Slide it down (B), then slide down to the right (C) until it is secured.

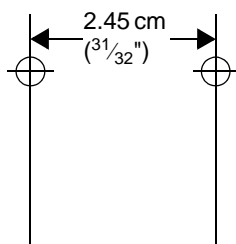
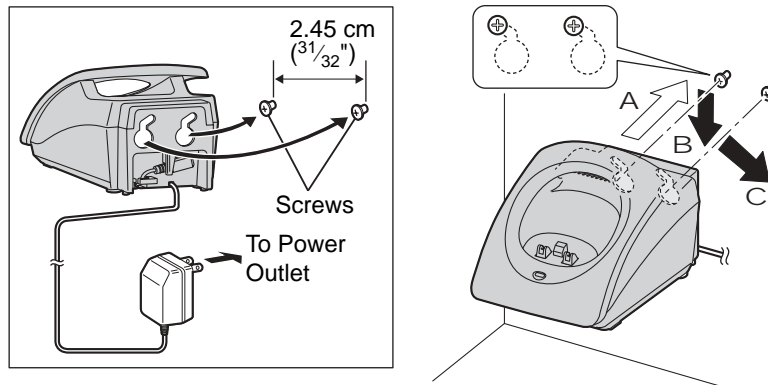

Wall Template for the Charger unit

## Belt Clip

You can hang the handset on your belt or pocket using the included belt clip.

### To attach the belt clip

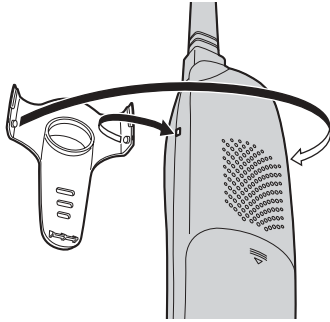

### To remove the belt clip

While pressing the top of the clip (1), pull the right edge in the direction of the arrow (2).

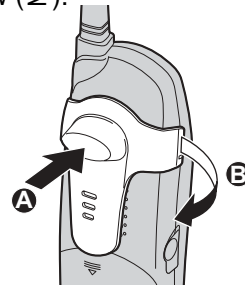

## Optional Headset

Connecting an optional headset to the handset allows hands-free phone conversation. Please use only a Panasonic KX-TCA60, KX-TCA86, KX-TCA88, KX-TCA88HA, KX-TCA91, KX-TCA92, or KX-TCA98 headset. To order, call the accessories telephone number on page 2.

### Connecting an optional headset

Open the headset jack cover, and insert the headset plug into the headset jack as shown below.

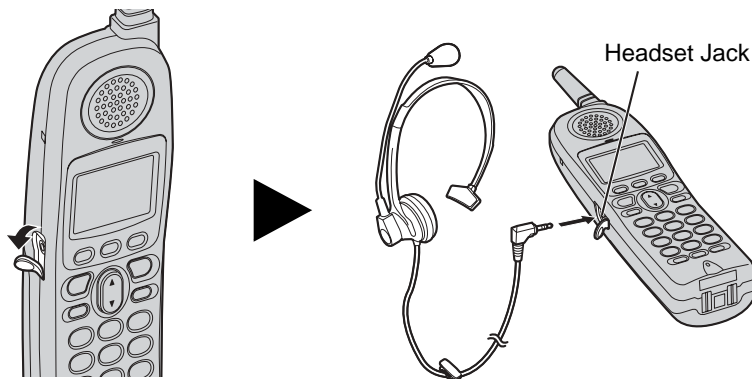

- Headset sold separately. Model shown here is KX-TCA88.

#### To switch to the speakerphone while using the headset:

Press [S]. To return to the headset, press [C].

Useful Information

For assistance, please call: 1-800-211-PANA(7262)

## Direct Commands

### Handset

After pressing **[MENU]**, you can also program menu items directly by pressing (**[0]** to **[9]**, **[\* ]** and **[#]**) instead of using the soft keys.

Menu item	Command	Selection items	Page
Ringer volume	[1] [1]	[0] : Off [1] : Low [2] : Medium [3] : High	p. 20
Ringer tone (Handset)	[1] [2]	[1]–[3] : Tone pattern 1–3 [4]–[7] : Melody pattern 1–4 [8]–[9] : Downloaded melody pattern 1–2 * <sup>1</sup>	p. 21
Incoming call tone (Handset)	[1] [3]	[1] : On [2] : Twice [0] : Off	p. 59
Date and time	[4]	Go to Step 3 on page 17.	–
Voice enhancer	[5]	[1] : On [0] : Off	p. 29
Activate Caller IQ * <sup>2</sup>	[7] [1]		–
View information * <sup>4</sup>	[7] [2] * <sup>5</sup>	Go to Step 4 on page 93.	–
Get new information * <sup>3</sup>	[7] [3] * <sup>5</sup>	Go to Step 4 on page 92.	–
Turn Caller IQ off * <sup>3</sup>	[7] [4] * <sup>5</sup>		p. 90
Turn Caller IQ on * <sup>3</sup>	[7] [5] * <sup>5</sup>		p. 90
Talking Caller ID (Handset)	[9]	[1] : On [0] : Off	p. 33
Copy phone book –Copy 1 item	[#] [1]	Go to Step 4 on page 44.	–
Copy phone book –Copy all items	[#] [2]	Go to Step 4 on page 45.	–
LCD contrast	[0] [1]	[1]–[6] : Level 1–6	p. 22
Key tone	[0] [2]	[1] : On [0] : Off	p. 60
Auto talk	[0] [3]	[1] : On [0] : Off	p. 19
Caller ID Number Auto Edit	[0] [4]	[1] : On [0] : Off	p. 37
Set dial mode	[0] [5] [1]	[1] : Pulse [2] : Tone	p. 18
Set flash time	[0] [5] [2]	[1] : 700 ms [2] : 600 ms [3] : 400 ms [4] : 300 ms [5] : 250 ms [6] : 110 ms [7] : 100 ms [8] : 90 ms	p. 58
Set line mode	[0] [5] [3]	[1] : A [2] : B	p. 19

## Direct Commands

Menu item	Command	Selection items	Page
Number of rings	[0] [6] [1]	[2]–[7] : 2–7 rings [0] : Toll saver	p. 25
Recording time	[0] [6] [2]	[1] : 1 minute [2] : 2 minutes [3] : 3 minutes [0] : Greeting only	p. 24
Remote code	[0] [6] [3]	Go to Step 5 on page 71.	–
Recording mode	[0] [6] [4]	[1] : Standard recording [2] : Enhanced recording	p. 26
Mailbox 2&3 passwords	[0] [6] [5]	Go to Step 5 on page 62.	–
Change language	[0] [8]	[1] : English [2] : Spanish	p. 18
Room monitor (Handset)	[0] [9]	[1] : On [0] : Off	p. 54
Message alert	[0] [#]	[1] : On [0] : Off	p. 26
Ringer tone (Base unit)	[0] [* ] [1]	[1]–[3] : Tone pattern 1–3 [4]–[7] : Melody pattern 1–4 [8]–[9] : Downloaded melody pattern 1–2 * <sup>1</sup>	p. 22
Incoming call tone (Base unit)	[0] [* ] [2]	[1] : On [2] : Twice [0] : Off	p. 59
Room monitor (Base unit)	[0] [* ] [3]	[1] : On [0] : Off	p. 54
Handset registration	[0] [0] [1]	Go to Step 5 on page 81.	–
Handset deregistration	[0] [0] [2]	[3] [3] [5]	p. 80
Talking Caller ID (Base unit)	[0] [* ] [4]	[1] : On [0] : Off	p. 34

### During programming:

When "**SAVE**" or "**OK**" is displayed, press the right soft key to **save the new settings**.

To exit programming, press **[OFF]**.

- If you press the direct command incorrectly, press **[OFF]**, then re-enter programming mode by pressing **[MENU]**.
- For function details, see the corresponding pages.

\*<sup>1</sup>You need to first download melody data from the openLCR web site.

\*<sup>2</sup>This feature can be used to activate Caller IQ. See the leaflet included with this unit for more information.

\*<sup>3</sup>For openLCR subscribers only.

\*<sup>4</sup>For openLCR subscribers only. If information is not downloaded to your unit, "**Get new Info.?**" will be displayed. To download information, see page 92.

\*<sup>5</sup>After pressing **[7]**, make sure "**view Info.?**" is displayed, then press the next command. If Caller IQ is turned off, "**Turn CIQ on?**" is displayed after pressing **[7]**.

For assistance, please call: 1-800-211-PANA(7262)

## Canceling Registration/Re-registration

### Canceling the Handset Registration **Handset**

If you no longer need to use the handset or if you want to use the handset with a different base unit of the same model, it is necessary to cancel the handset's registration from the current base unit.

Only one handset can be canceled at a time.

**Make sure the handset and the base unit near each other and are not being used.**

1 Press **[MENU]**.

2 Scroll to "Initial setting" by pressing **[d]** or **[B]**, then press the soft key **(SELECT)**.

Initial setting

3 Scroll to "Registration" by pressing **[d]** or **[B]**, then press the soft key **(SELECT)**.

Registration

4 Scroll to "Deregistration" by pressing **[d]** or **[B]**, then press the soft key **(SELECT)**.

Deregistration

5 Press **[3][3][5]** to delete the registration memory.

- If you enter a wrong code, re-enter **[3][3][5]**.

Deregistration  
Enter code:335  
:335

6 Press the soft key **(OK)**.

- The registration memory will be erased on both the handset and the base unit.
- If the handset beeps 3 times, you entered a wrong code. Enter "335", then press the soft key **(OK)**.
- To register the handset to another base unit of the same model, start from step 5 on page 81.

Ex. Extension number 2

Handset [2] <sup>1</sup> [-]  
Deregistered

- "[ - ]" is shown on the top right of the display.
- After canceling registration, the handset cannot be used. If you want to use it again, register the handset to the base unit by performing steps 5 and 6 on page 81.

### Re-registering the Handset **Handset & Base Unit**

If you want to re-register the handset to the base unit or a different base unit of the same model, you need to register it to that base unit. The handset will be given a new extension number of that base unit. Only one handset can be registered at a time near the base unit.



## Canceling Registration/Re-registration

**Make sure the base unit and the other handsets are not being used. Have both the handset and base unit nearby during registration.**

If you have canceled handset registration at a previous base unit (p. 80), start from step 5.

**1 Handset:** Press **[MENU]**.

**2 Handset:** Scroll to "Initial setting" by pressing [c] or [B], then press the soft key **(SELECT)**.

Initial setting

**3 Handset:** Scroll to "Registration" by pressing [c] or [B], then press the soft key **(SELECT)**.

Registration

**4 Handset:** Press the soft key **(SELECT)** at "HS registration".

HS registration

**5 Base unit:**

Press and hold **[LOCATOR/INTERCOM/TRANSFER]** for 3 seconds.

- The CHARGE indicator flashes. After the CHARGE indicator starts flashing, the rest of the procedure must be completed within 1 minute.

**6 Handset:**

- (1) Press the soft key **(OK)**.
- (2) Wait until a long beep sounds and the display shows the new extension number (ex. extension number 2).

- Registration is complete.

Press LOCATOR  
on base unit  
for 3 sec.  
Then press OK

1 [2]  
Handset [2]  
Registered

- You can stop registration by pressing **[OFF]** on the handset and pressing **[LOCATOR/INTERCOM/TRANSFER]** on the base unit.
- If "Wrong handset Refer to manual" is displayed, the handset you tried to register is not for this base unit. This handset is for KX-TG6500 base unit. The accessory handsets for this base unit are KX-TGA520 and KX-TGA523. To order, see page 3.

If you have not canceled the handset's registration at the previous base unit (p. 80), the handset number remains in that base unit's memory. To erase the handset number from the previous base unit, see the base unit's Operating Instructions. For the KX-TG5240/KX-TG5243 base unit: (1) Press and hold **[LOCATOR/INTERCOM/TRANSFER]** for 3 seconds, and (2) Press and hold the handset number **[1]** ( / ) to **[4]** ( / ) that you do not want for 5 seconds. A long beep sounds, then the handset number is erased.

Useful Information

For assistance, please call: 1-800-211-PANA(7262)

## If the Following Appear on Your Display...

The following will be displayed on the handset when the unit needs your attention.

Display message	Cause & Remedy
Recharge battery	<ul style="list-style-type: none"> <li>The battery needs to be charged. Recharge the battery (p. 14).</li> </ul>
Charge for 6 HRS	<ul style="list-style-type: none"> <li>The battery has been discharged. The handset will not work. Fully charge the battery (p. 13).</li> </ul>
No link to base. Move closer to base and try again.	<ul style="list-style-type: none"> <li>The handset has lost communication with the base unit. Walk closer to the base unit, and try again.</li> <li>Confirm the base unit's AC adaptor is plugged in.</li> <li>Raise the base unit antennas.</li> <li>The handset's registration may have been canceled. Re-register the handset (p. 80, 81).</li> </ul>
Please lift up and try again.	<ul style="list-style-type: none"> <li>A handset button was pressed while the handset was on the base unit or charger (for KX-TG5243 or accessory handset users, p. 3). Lift the handset and press the button again.</li> </ul>
Busy	<ul style="list-style-type: none"> <li>The called base unit or handset is in use.</li> <li>Privacy mode is on for the call you tried to join (p. 56).</li> <li>The handset you tried to send phone book items to is in use.</li> <li>The handset you are calling is too far from the base unit.</li> </ul>
Invalid	<ul style="list-style-type: none"> <li>The called handset has not been registered to the base unit.</li> <li>You selected your own extension number.</li> </ul>
Error!!	<ul style="list-style-type: none"> <li>When you tried to register or deregister the handset, the handset and base unit could not link for some reason, such as interference from electrical appliances. Move the handset and base unit away from any electrical appliances and try again.</li> <li>If more than one handset is in use, you may not be able to register/deregister. Try again later.</li> <li>Another handset tried to send phone book items to you but copying stopped. Have the other handset user re-send the items to you (p. 44, 45).</li> </ul>
System is busy. Please try again later.	<ul style="list-style-type: none"> <li>If more than one other user is using the handset and/or base unit, such as conducting outside/intercom calls or listening to messages, you may not be able to use the handset. Try again later.</li> <li>The Answering System is in use (answering a call or playing back messages). Try again later.</li> <li>The handset has lost communication with the base unit. Walk closer to the base unit and try again.</li> </ul>

## If the Following Appear on Your Display...

Display message	Cause & Remedy
Phone book full	<ul style="list-style-type: none"> <li>When you tried to store an item in the phone book, the phone book memory was full. Press <b>[OFF]</b> to exit programming mode. To erase other items from the phone book, see page 43.</li> </ul>
---Incomplete--- Tom Jones 098-765-4321 Phone book full (The name/number is an example.)	<ul style="list-style-type: none"> <li>When the displayed item was sent to the destination handset, the phone book memory was full and copying stopped. If you tried to send all of the items, the item displayed with "Incomplete" and items after it have not been copied to the destination handset. Press <b>[OFF]</b> to exit (p. 44, 45). To erase items from the destination handset phone book, see page 43. You can copy all of the items again or copy the items which have not been copied one by one (p. 44, 45).</li> </ul>
---Incomplete--- Tom Jones 555-765-4321 (The name/number is an example.)	<ul style="list-style-type: none"> <li>The destination handset is out of area.</li> <li>The destination handset user may have pressed <b>[C ]</b> or <b>[s]</b>.</li> </ul>
Phone book No items stored	<ul style="list-style-type: none"> <li>Your phone book is empty. No items were copied to the destination unit.</li> </ul>
Denied	<ul style="list-style-type: none"> <li>The Room Monitor feature is turned off on the destination handset or base unit and cannot be monitored (p. 54).</li> <li>The called handset was on the base unit. The handset must be off the base unit to be monitored.</li> </ul>
Invalid. Please register to the base unit	<ul style="list-style-type: none"> <li>The handset you tried to call has not been registered to the base unit. Register the handset (p. 81, steps 5 and 6).</li> </ul>
Error!! 4 handsets have already been registered.	<ul style="list-style-type: none"> <li>4 handsets have already been registered to the base unit. To cancel a handset's registration, see page 80.</li> <li>You may have registered one of your handsets to another base unit without deleting its registration to this base unit. Erase the handset's registration from the base unit.                      For the KX-TG5240/KX-TG5243 base unit:                      (1) Press and hold <b>[LOCATOR/INTERCOM/TRANSFER]</b> for 3 seconds, and (2) Press and hold the handset number <b>[1] ( / )</b> to <b>[4] ( / )</b> that you do not want for 5 seconds. A long beep sounds, then the handset number is erased.</li> </ul>



**Useful Information**

For assistance, please call: 1-800-211-PANA(7262)

## If the Following Appear on Your Display...

Display message	Cause & Remedy
Wrong handset Refer to manual	<ul style="list-style-type: none"> <li>This handset is not for this base unit. This handset is for KX-TG6500 base unit. The accessory handsets for this base unit are KX-TGA520 and KX-TGA523. To order, see page 3.</li> </ul>

## Troubleshooting

If the handset display shows error messages, see “If the Following Appear on Your Display...” (p. 82–84) for the Cause & Remedy.

### Telephone System

Problem	Cause & Remedy
“No link to base. Move closer to base and try again.” is displayed and an alarm tone sounds.	<ul style="list-style-type: none"> <li>The handset has lost communication with the base unit. Walk closer to the base unit, and try again.</li> <li>Confirm the base unit’s AC adaptor is plugged in.</li> <li>Raise the base unit antennas.</li> <li>The handset’s registration may have been canceled. Re-register the handset (p. 80, 81).</li> </ul>
Static, sound cuts in/out, fades. Interference from other electrical units.	<ul style="list-style-type: none"> <li>Move the handset and base unit away from other electrical appliances (p. 6).</li> <li>Walk closer to the base unit.</li> <li>Raise the base unit antennas.</li> <li>Turn on the Clarity Booster feature (p. 29).</li> <li>If the unit is connected to a telephone line with DSL service, you may hear noise from the receiver or speaker during conversations. We recommend connecting a noise filter (contact your DSL service provider) to the telephone line between the unit and the telephone line jack.</li> </ul>
The base unit and/or handset does not ring.	<ul style="list-style-type: none"> <li>The ringer volume is turned off. Set to high, medium, or low (p. 20, 21).</li> <li>If more than one other user is using the handset and/or base unit, the handset/base unit may not ring. Users will hear incoming call tones (p. 59).</li> </ul>
The handset display is blank.	<ul style="list-style-type: none"> <li>If the handset display is blank, fully charge the battery (p. 13).</li> </ul>
You cannot program any function items.	<ul style="list-style-type: none"> <li>Programming is not possible while the handset and/or base unit is being used.</li> <li>Do not pause for over 60 seconds while programming.</li> <li>Walk closer to the base unit.</li> <li>While another user is listening to messages or the Answering System is handling a call, you cannot program. Try again later.</li> </ul>

## Troubleshooting

Problem	Cause & Remedy
While programming or searching, the handset or base unit starts to ring and the program/search stops.	<ul style="list-style-type: none"> <li>• A call is coming in. To answer the call, press <b>[C ]</b>, <b>[S]</b> or <b>[SP-PHONE]</b>. Start again from the beginning after hanging up.</li> </ul>
You cannot make an intercom/outside call.	<ul style="list-style-type: none"> <li>• If more than one other user is using the handset and/or base unit, you may not be able to make a call. Try again later.</li> <li>• Your handset is in remote operation mode (p. 65). Exit by pressing <b>[OFF]</b>.</li> <li>• The handset you called is too far from the base unit.</li> </ul>
You cannot redial.	<ul style="list-style-type: none"> <li>• If the last number dialed was more than 48 digits long, the number will not be redialed correctly.</li> <li>• The <b>[REDIAL/PAUSE]</b> button on the base unit functions as either redial or pause. It will redial the last number dialed if pressed before dialing any digits (p. 30). If another number has been dialed first, it will operate as a pause button (p. 56).</li> </ul>
You cannot make long distance calls.	<ul style="list-style-type: none"> <li>• Please make sure you have long distance service.</li> <li>• Check if Caller IQ feature is turned on. Turn Caller IQ feature off (p. 90).</li> </ul>
The handset does not display the caller's name and/or phone number.	<ul style="list-style-type: none"> <li>• You need to subscribe to Caller ID.</li> <li>• Other telephone equipment may be interfering with your phone. Disconnect it and try again.</li> <li>• Other electrical appliances connected to the same outlet may be interfering with Caller ID.</li> <li>• Telephone line noise may be affecting Caller ID.</li> <li>• The caller requested not to send his/her Caller ID information (p. 32).</li> <li>• If a call is being transferred to you, the Caller ID information will not be displayed.</li> <li>• If a (separate) Caller ID box is connected between the base unit and the telephone wall jack, disconnect the Caller ID box or plug the unit directly into the wall jack.</li> <li>• If the unit is connected to a telephone line with DSL service, the unit may not display caller's name and/or phone number properly. We recommend connecting a noise filter (contact your DSL service provider) to the telephone line between the unit and the telephone line jack.</li> </ul>

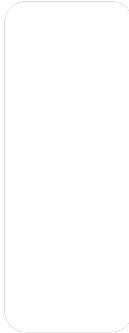

For assistance, please call: 1-800-211-PANA(7262)

## Troubleshooting

Problem	Cause & Remedy
The handset and/or base unit does not announce the displayed caller's name.	<ul style="list-style-type: none"> <li>• The handset and/or base unit ringer volumes are turned off. Set to high, medium, or low (p. 20, 21).</li> <li>• The Talking Caller ID feature is turned off. Turn it on (p. 33, 34).</li> </ul>
The handset and/or base unit does not announce the displayed caller's name properly.	<ul style="list-style-type: none"> <li>• Name pronunciation may vary. Name pronunciation quality is based on names most commonly used in the United States.</li> <li>• The handset and/or base unit will announce each letter of abbreviations, such as "Co." and "Inc."</li> <li>• Caller ID supports names of up to 15 letters. If the caller's name has more than 15 letters, the name will not be announced correctly.</li> </ul>
The handset cannot automatically edit the Caller List/incoming phone numbers.	<ul style="list-style-type: none"> <li>• The Caller ID Number Auto Edit feature is turned off. Turn it on (p. 37) and try again.</li> <li>• You need to press [C ] or [S] after editing the number.</li> </ul>
The handset display exits the Caller List or phone book.	<ul style="list-style-type: none"> <li>• Do not pause for over 60 seconds while searching.</li> </ul>
The Ringer/Message Alert indicator flashes slowly when the handset is not ringing and in use.	<ul style="list-style-type: none"> <li>• The Message Alert is turned on and new messages have been recorded. Turn the Message Alert off (p. 26) or listen to the new messages (p. 64, 65, 70).</li> </ul>
You cannot have a conversation using the headset.	<ul style="list-style-type: none"> <li>• Make sure the optional headset is connected properly (p. 77).</li> <li>• If "SP-phone" is displayed on the handset, press [C ] to switch to the headset.</li> </ul>

## Troubleshooting

### Answering System

Problem	Cause & Remedy
The Answering System is on, but incoming messages are not recorded.	<ul style="list-style-type: none"> <li>The recording time is set to "Greeting only". Select "1 minute", "2 minutes" or "3 minutes" (p. 24).</li> <li>Memory is full. Erase unnecessary messages (p. 67).</li> </ul>
" <b>FULL</b> " flashes and the ANSWER ON indicator flashes rapidly. No new messages are recorded.	<ul style="list-style-type: none"> <li>Memory is full. Erase unnecessary messages (p. 67).</li> </ul>
You cannot access a mailbox from the base unit or the handset.	<ul style="list-style-type: none"> <li>If more than one other user is using the handset and/or base unit, you may not be able to access the mailbox. Try again later.</li> <li>If another user is listening to messages or the Answering System is handling a call, you cannot access the mailbox. Try again later.</li> </ul>
You cannot access a mailbox from a touch tone phone.	<ul style="list-style-type: none"> <li>Make sure you entered the correct remote code (p. 71).</li> <li>If "Enter Mailbox password" is heard, Mailbox 2 or 3 has a password which must be entered (p. 62).</li> <li>The Answering System may not respond if the tones are too short to activate the unit. Press each button firmly.</li> <li>The Answering System is off. Turn it on (p. 73).</li> </ul>
When you play back messages or turn on the Answering System, the base unit and handset announce the wrong day and time.	<ul style="list-style-type: none"> <li>The date and time may be set incorrectly. Set the date and time again (p. 17).</li> </ul>
Caller ID information is not displayed during message playback (p. 66).	<ul style="list-style-type: none"> <li>Caller ID information will not be displayed                             <ul style="list-style-type: none"> <li>— if a message is recorded by using <b>[MEMO]</b> (p. 68), or</li> <li>— if a call is transferred to a mailbox and the caller leaves a message (p. 69).</li> </ul> </li> </ul>

Useful Information

For assistance, please call: 1-800-211-PANA(7262)

## Troubleshooting

Problem	Cause & Remedy																																
You cannot remember your mailbox password. You cannot retrieve the messages from your mailbox.	<ul style="list-style-type: none"> <li>• Confirm the mailbox password using the handset (p. 62).</li> <li>• If you cannot use the handset, you can retrieve the messages from your mailbox after erasing the password, using the base unit; Press <b>[PROGRAM]</b>, <b>[MUTE]</b>, <b>[#]</b>, and <b>[9][0][0][0]</b>. Please note that the following settings will return to the factory preset with the Mailbox 2 and 3 passwords.</li> </ul> <table border="1" style="width: 100%; border-collapse: collapse;"> <thead> <tr> <th style="width: 60%;">Function</th> <th style="width: 40%;">Factory preset</th> </tr> </thead> <tbody> <tr> <td>Date &amp; time</td> <td>—</td> </tr> <tr> <td>Dialing mode</td> <td>Tone</td> </tr> <tr> <td>Flash time</td> <td>700ms</td> </tr> <tr> <td>Line mode</td> <td>B mode</td> </tr> <tr> <td>Answering System</td> <td>On</td> </tr> <tr> <td>Number of rings</td> <td>4</td> </tr> <tr> <td>Recording time</td> <td>3 min</td> </tr> <tr> <td>Remote code</td> <td>11</td> </tr> <tr> <td>Recording mode</td> <td>Standard (16 min)</td> </tr> <tr> <td>Base unit ringer volume</td> <td>High</td> </tr> <tr> <td>Base unit ringer tone</td> <td>Tone 1</td> </tr> <tr> <td>Base unit incoming call tone</td> <td>2</td> </tr> <tr> <td>Base unit room monitor mode</td> <td>Off</td> </tr> <tr> <td>Base unit Talking Caller ID</td> <td>On</td> </tr> <tr> <td>Caller IQ feature</td> <td>Off</td> </tr> </tbody> </table>	Function	Factory preset	Date & time	—	Dialing mode	Tone	Flash time	700ms	Line mode	B mode	Answering System	On	Number of rings	4	Recording time	3 min	Remote code	11	Recording mode	Standard (16 min)	Base unit ringer volume	High	Base unit ringer tone	Tone 1	Base unit incoming call tone	2	Base unit room monitor mode	Off	Base unit Talking Caller ID	On	Caller IQ feature	Off
Function	Factory preset																																
Date & time	—																																
Dialing mode	Tone																																
Flash time	700ms																																
Line mode	B mode																																
Answering System	On																																
Number of rings	4																																
Recording time	3 min																																
Remote code	11																																
Recording mode	Standard (16 min)																																
Base unit ringer volume	High																																
Base unit ringer tone	Tone 1																																
Base unit incoming call tone	2																																
Base unit room monitor mode	Off																																
Base unit Talking Caller ID	On																																
Caller IQ feature	Off																																

### General

Problem	Cause & Remedy
The handset and/or base unit does not work.	<ul style="list-style-type: none"> <li>• Check the settings (p. 12–14).</li> <li>• Check whether the dialing mode setting is correct (p. 18).</li> <li>• Fully charge the battery (p. 13).</li> <li>• Clean the charge contacts and charge again (p. 14).</li> <li>• Check battery installation (p. 13).</li> <li>• Unplug the base unit's AC adaptor to reset it. Plug in, and try again.</li> <li>• The handset has not been registered to the base unit. Register the handset (p. 81, steps 5 and 6).</li> <li>• Re-install the battery (p. 13) and fully charge it.</li> </ul>



## Troubleshooting

Problem	Cause & Remedy
"Recharge battery" is displayed, "3" flashes, or the handset beeps intermittently.	<ul style="list-style-type: none"> <li>Fully charge the battery (p. 13).</li> </ul>
"Charge for 6 HRS" and "4" are displayed and the handset does not work.	<ul style="list-style-type: none"> <li>The battery has been discharged. Fully charge the battery (p. 14).</li> </ul>
You charged the battery fully, but "Recharge battery" is still displayed and/or "3" continues to flash, or "Charge for 6 HRS" and "4" are displayed.	<ul style="list-style-type: none"> <li>Clean the charge contacts and charge again (p. 14).</li> <li>The battery may need to be replaced. If you install a new battery, fully charge it (p. 13, 14).</li> </ul>
The CHARGE indicator does not go out after the battery has been charged.	<ul style="list-style-type: none"> <li>This is normal.</li> </ul>
If you cannot solve your problem	<ul style="list-style-type: none"> <li>Visit our website: <a href="http://www.panasonic.com/support">http://www.panasonic.com/support</a></li> <li>Contact us via the web at: <a href="http://www.panasonic.com/contactinfo">http://www.panasonic.com/contactinfo</a></li> <li>Call our customer call center at: 1-800-211-PANA(7262)</li> </ul>

### openLCR service for Caller IQ

Problem	Cause & Remedy
When you try to download the data from openLCR, the voice prompt is not announced from the handset while "Listen & follow phone guidance." is being displayed.	<ul style="list-style-type: none"> <li>Check the settings (p. 12–14).</li> <li>Dialing to openLCR may have been disconnected. Try again (p. 92).</li> <li>If you cannot solve a problem, consult openLCR (see below).</li> </ul>
For more information about Caller IQ	<ul style="list-style-type: none"> <li>Call openLCR's customer service department at 1-866-openLCR(1-866-673-6527).</li> <li>openLCR's web site: <a href="http://www.openLCR.com">www.openLCR.com</a></li> </ul>

Useful Information

For assistance, please call: 1-800-211-PANA(7262)

For assistance, please call openLCR: 1-866-openLCR(1-866-673-6527)

## openLCR Service for Caller IQ

The unit is compatible with services provided by openLCR.

### Important:

- If you have any questions regarding the openLCR service, call openLCR's customer service department at 1-866-openLCR(1-866-673-6527).
- NEITHER PANASONIC COMMUNICATIONS CO., LTD. (PCC) NOR MATSUSHITA ELECTRIC CORPORATION OF AMERICA (MECA) IS IN ANY WAY AFFILIATED WITH, OR RESPONSIBLE FOR THE ACTS OR OMISSIONS OF, OPENLCR.COM, INC. (OPENLCR). NEITHER PCC NOR MECA NOR ANY OF THEIR EMPLOYEES OR AFFILIATES OR CUSTOMERS MAKE ANY WARRANTIES OR REPRESENTATIONS, EITHER EXPRESS OR IMPLIED, TO ANY CUSTOMER OR ANY OTHER THIRD PARTY WITH RESPECT TO ANY OF THE SERVICES PROVIDED BY OPENLCR, NOR ASSUME NOR CREATE ANY OTHER OBLIGATION OF ANY KIND ON BEHALF OF OPENLCR.

### Turning on or off Caller IQ Feature **Handset**

After the first download to your phone, Caller IQ features are automatically turned on. If you wish, you can turn off Caller IQ.

- When Caller IQ is on, "[CIQ]" is displayed while talking.

#### To turn off Caller IQ feature (when it is already on.)

1 Press **[MENU]**.

2 Scroll to "Caller IQ" by pressing **[d]** or **[B]**, then press the soft key (**SELECT**).

Caller IQ

3 Scroll to "Turn CIQ off?" by pressing **[d]** or **[B]**, then press the soft key (**YES**).

Turn CIQ off?

- "Caller IQ off" is displayed.

4 Press **[OFF]**.

#### To turn on Caller IQ feature (after it was turned off)

1 Follow steps 1 to 2 of "To turn off Caller IQ feature" above.

2 Press the soft key (**YES**) at "Turn CIQ on?".

Turn CIQ on?

- "Caller IQ on" is displayed.

3 Press **[OFF]**.

- If you turn on or off Caller IQ feature using one of the handsets, you will not need to turn on or off using another handset.

## openLCR Service for Caller IQ

### Downloading Data

You can download the following data to your unit from the openLCR web site.

- Phone book data
- Ringer melodies (Custom ringtone)
- Function setup for your unit
- Information such as weather forecasts, stock quotes, lottery results, sports scores and horoscopes (Internet content)

Accessing the openLCR web site can be done from any computer with Internet access.

- While downloading from openLCR, “DL” flashes on the base unit display.

### To create data on the openLCR web site

**1** Access the openLCR’s web site at **www.openLCR.com** and click on the “Manage Account/Login” tab.

**2** Enter your Telephone Number and Password, then click .

**3** Follow the on-screen instructions.

**Phone book data:**

- To create the phone book data, enter a name of up to 16 characters, and a phone number of up to 32 digits.

**Ringer melodies:**

- The unit stores up to 2 ringer melodies in the handset and base unit separately and you can select up to 2 ringer melodies as ringer tone (p. 78, 79, 93).

**Function setup:**

- See openLCR’s web site for function items available for download.

**Information:**

- You can select the information which you want to show on the handset display.

- The description on the openLCR web screen is subject to change without notice.

## openLCR Service for Caller IQ

### To download data from openLCR **Handset**

Each time you download data (p. 91) from openLCR, the information stored in your unit will be updated. To view up-to-date information, you will need to download it to your unit.

- You can select the items of information on the web site which you want to view.
- Each handset can download its own data only.  
One handset can be used to download data for the base unit.
- Horoscopes are for entertainment purposes only.

**1** Press **[MENU]**.

**2** Scroll to "Caller IQ" by pressing **[d ]** or **[B]**, then press the soft key **(SELECT)**.

**3** Scroll to "Get new Info.?" by pressing **[d ]** or **[B]**, then press the soft key **(YES)**.

- The unit will dial openLCR automatically.
- A voice prompt will be heard.

If you live in or move from another area to Fort Collins, Colorado, press **[#]** before pressing the soft key **(YES)**.

Get new Info.?



Listen & follow  
phone guidance.

**4** Follow the voice prompt to start downloading.

- If you have rotary or pulse service, you need to press **[\* ]** to change the dialing mode temporarily to tone, before following the voice prompt.
- After downloading starts, the handset must be off-hook. **DO NOT PLACE** the handset on the base unit or charger (for KX-TG5243 or accessory handset users, p. 3). Placing the handset on the base unit or charger will terminate the download process. **DO NOT PRESS [OFF]** (pressing **[OFF]** will terminate the download process).

**5** When downloading is complete, a beep sounds.

[Caller IQ on]  
Download OK!

- You can also go to the Caller IQ menu after pressing **[C ]** or **[S]**. Press **[MENU]**, then **[3]** to select "3=Caller IQ". Follow steps 3 to 5 above.
- If the handset beeps 3 times and the following is displayed, the unit has lost communication with openLCR. Store items by following the steps below.
  1. Access the openLCR web site.
  2. Go to the web screen to create the data.
    - To download the phone book data, check the "Re-Download All" box, then click **[Save]**. Then go to step 3.
  3. Start again from step 1 ("To download data from openLCR").

Download  
incomplete.  
Try again.

## openLCR Service for Caller IQ

- If the handset beeps 3 times and the following is displayed, some items could not be stored in the phone book. Store items by following the steps below.
 

Download incomplete.  
Phone book full.

  1. Erase items which do not exist on the web from the phone book of the unit (p. 43).
  2. Access the openLCR web site.
  3. Go to the web screen to create the phone book data.
  4. Check the "Re-Download All" box, then click **[Save]**.
  5. Start again from step 1 ("To download data from openLCR" on page 92).
- You cannot access the openLCR server if a telephone or fax machine on the same phone line is in use simultaneously.
- While the unit is downloading data from openLCR, the Call Waiting Service cannot be used.

### To use downloaded melodies as the ringer tone

The melody(ies) you download from openLCR are stored in the base unit and handsets and will be heard when you receive an outside call. The names of each melody (up to 14 characters) are also downloaded.

To select the desired melody, go to the Ringer tone menu in the Ringer setting menu (p. 21). Downloaded melody 1 and 2 can also be selected by:

- If using the handset, press **[d]**, **[B]**, **[8]** or **[9]**.
- If using the base unit, press **[H]**, **[G]**, **[8]** or **[9]**.

### To view information

**1** Press **[MENU]**.

**2** Scroll to "Caller IQ" by pressing **[d]** or **[B]**, then press the soft key **(SELECT)**.

Caller IQ

**3** Press the soft key **(YES)** at "View Info.?"

View Info.?

- The items of information which you selected on the web are displayed.
- If information is not downloaded to your unit, "Get new Info.?" will be displayed. To download information, see page 92.

**4** Scroll to the desired information by pressing **[d]** or **[B]**.

- You can also select the desired information by pressing dialing buttons.

**5** When finished, press **[OFF]** or place the handset on the base unit or charger.

Useful Information

For assistance, please call openLCR: 1-866-openLCR(1-866-673-6527)

## Important Safety Instructions

---

When using this unit, basic safety precautions should always be followed to reduce the risk of fire, electric shock, or personal injury.

1. Read and understand all instructions.
2. Follow all warnings and instructions marked on this unit.
3. Unplug this unit from AC outlets before cleaning. Do not use liquid or aerosol cleaners. Use a damp cloth for cleaning.
4. Do not use this unit near water, for example, near a bathtub, washbowl, kitchen sink, or the like.
5. Place this unit securely on a stable surface. Serious damage and/or injury may result if the unit falls.
6. Do not cover slots and openings on the unit. They are provided for ventilation and protection against overheating. Never place the unit near radiators, or in a place where proper ventilation is not provided.
7. Use only the power source marked on the unit. If you are not sure of the type of power supplied to your home, consult your dealer or local power company.
8. Do not place objects on the power cord. Install the unit where no one can step or trip on the cord.
9. Do not overload wall outlets and extension cords. This can result in the risk of fire or electric shock.
10. Never push any objects through slots in this unit. This may result in the risk of fire or electric shock. Never spill any liquid on the unit.
11. To reduce the risk of electric shock, do not disassemble this unit. Take the unit to an authorized servicenter when service is required. Opening or removing covers may expose you to dangerous voltages or other risks. Incorrect reassembly can cause electric shock when the unit is subsequently used.
12. Unplug this unit from the wall outlet and refer servicing to an authorized servicenter when the following conditions occur:
  - A. When the power supply cord or plug is damaged or frayed.
  - B. If liquid has been spilled into the unit.
  - C. If the unit has been exposed to rain or water.
  - D. If the unit does not work normally by following the operating instructions. Adjust only controls covered by the operating instructions. Improper adjustment may require extensive work by an authorized servicenter.
  - E. If the unit has been dropped or physically damaged.
  - F. If the unit exhibits a distinct change in performance.
13. During thunderstorms, avoid using telephones except cordless types. There may be a remote risk of an electric shock from lightning.
14. Do not use this unit to report a gas leak, when in the vicinity of the leak.

## SAVE THESE INSTRUCTIONS

## Important Safety Instructions

### CAUTION:

To reduce the risk of fire or injury to persons, read and follow these instructions.

1. Use only the battery(ies) specified.
2. Do not dispose of the battery(ies) in a fire. They may explode. Check with local waste management codes for special disposal instructions.
3. Do not open or mutilate the battery(ies). Released electrolyte is corrosive and may cause burns or injury to the eyes or skin. The electrolyte may be toxic if swallowed.
4. Exercise care in handling batteries in order not to short the battery to conductive materials such as rings, bracelets, and keys. The battery and/or conductor may overheat and cause burns.
5. Charge the battery(ies) provided with or identified for use with this product only in accordance with the instructions and limitations specified in this manual.

### WARNING:

TO PREVENT FIRE OR SHOCK HAZARD, DO NOT EXPOSE THIS PRODUCT TO RAIN OR ANY TYPE OF MOISTURE.

- The AC adaptor is used as the main disconnect device, ensure that the AC outlet is located/installed near the unit and is easily accessible.

## FCC and Other Information

This equipment complies with Part 68 of the FCC rules and the requirements adopted by the ACTA. On the bottom of this equipment is a label that contains, among other information, a product identifier in the format US:ACJ-----.

If requested, this number must be provided to the telephone company.

Registration No. .... (found on the bottom of the unit)  
Ringer Equivalence No. (REN).....0.1B

A plug and jack used to connect this equipment to the premises wiring and telephone network must comply with the applicable FCC Part 68 rules and requirements adopted by the ACTA. A compliant telephone cord and modular plug is provided with this product. It is designed to be connected to a compatible modular jack that is also compliant.

The REN is used to determine the number of devices that may be connected to a telephone line. Excessive RENs on a telephone line may result in the devices not ringing in response to an incoming call. In most but not all areas, the sum of RENs should not exceed five (5.0). To be certain of the number of devices that may be connected to a line, as determined by the total RENs, contact the local telephone company. For products approved after July 23, 2001, the REN for this product is part of the product identifier that has the format US:AAAEQ##TXXXX. The digits represented by ## are the REN without a decimal point (e.g., 03 is a REN of 0.3).

If this equipment causes harm to the telephone network, the telephone company will notify you in advance that temporary discontinuance of service may be required. But if advance notice isn't practical, the telephone company will notify the customer as soon as possible. Also, you will be advised of your right to file a complaint with the FCC if you believe it is necessary.

The telephone company may make changes in its facilities, equipment, operations or procedures that could affect the operation of the equipment. If this happens the telephone company will provide advance notice in order for you to make necessary modifications to maintain uninterrupted service.

If trouble is experienced with this equipment, for repair or warranty information, please contact a Factory Servicenter or other Authorized Servicer. If the equipment is causing harm to the telephone network, the telephone company may request that you disconnect the equipment until the problem is resolved.

Connection to party line service is subject to state tariffs. Contact the state public utility commission, public service commission or corporation commission for information.

If your home has specially wired alarm equipment connected to the telephone line, ensure the installation of this equipment does not disable your alarm equipment. If you have questions about what will disable alarm equipment, consult your telephone company or a qualified installer.

### WHEN PROGRAMMING EMERGENCY NUMBERS AND(OR) MAKING TEST CALLS TO EMERGENCY NUMBERS:

- 1) Remain on the line and briefly explain to the dispatcher the reason for the call.
- 2) Perform such activities in the off-peak hours, such as early morning or late evenings.

This device complies with Part 15 of the FCC Rules. Operation is subject to the following two conditions: (1) This device may not cause harmful interference, and (2) this device must accept any interference received, including interference that may cause undesired operation.

Privacy of communications may not be ensured when using this phone.



## FCC and Other Information

**CAUTION:**

Any changes or modifications not expressly approved by the party responsible for compliance could void the user's authority to operate this device.

**Note:**

This equipment has been tested and found to comply with the limits for a Class B digital device, pursuant to Part 15 of the FCC Rules. These limits are designed to provide reasonable protection against harmful interference in a residential installation. This equipment generates, uses, and can radiate radio frequency energy and, if not installed and used in accordance with the instructions, may cause harmful interference to radio communications. However, there is no guarantee that interference will not occur in a particular installation. If this equipment does cause harmful interference to radio or television reception, which can be determined by turning the equipment off and on, the user is encouraged to try to correct the interference by one or more of the following measures:

- Reorient or relocate the receiving antenna.
- Increase the separation between the equipment and receiver.
- Connect the equipment into an outlet on a circuit different from that to which the receiver is connected.
- Consult the dealer or an experienced radio/TV technician for help.

Some cordless telephones operate at frequencies that may cause interference to nearby TVs and VCRs. To minimize or prevent such interference, the base of the cordless telephone should not be placed near or on top of a TV or VCR. If interference is experienced, move the cordless telephone further away from the TV or VCR. This will often reduce, or eliminate, interference.

Operating near 5.8GHz electrical appliances may cause interference. Move away from the electrical appliances.

**FCC RF Exposure Warning:**

This product complies with FCC radiation exposure limits set forth for an uncontrolled environment. To comply with FCC RF exposure requirements the base unit must be installed and operated with its antenna located 20 cm or more between antenna and all person's body (excluding extremities of hands, wrist and feet). The handset unit may be carried and operated with only the specific provided belt-clip. Other non-tested belt-clips or similar body-worn accessories may not comply and must be avoided. The base and handset units must not be co-located or operated in conjunction with any other antenna or transmitter.

This equipment is hearing aid compatible as defined by the FCC in 47 CFR Section 68.316.

When you hold the phone to your ear, noise might be heard in your Hearing Aid. Some Hearing Aids are not adequately shielded from external RF (radio frequency) energy. If noise occurs, use an optional headset accessory or the speakerphone option (if applicable) when using this phone. Consult your audiologist or Hearing Aid manufacturer about the availability of Hearing Aids which provide adequate shielding to RF energy commonly emitted by digital devices.

A TIA/EIA-IS-968 compliant telephone cord and modular plug is provided with this equipment. This equipment is designed to be connected to the telephone network or premises wiring using a compatible modular jack that is also TIA/EIA-IS-968 compliant.

For assistance, please call: 1-800-211-PANA(7262)

Useful Information

## FCC and Other Information

---

The software contained in this equipment to allow user access to the network must be ungraded to recognize newly established network area codes and exchange codes as they are placed into service.

Failure to upgrade the premises systems or peripheral equipment to recognize the new codes as they are established will restrict the customer and the customer's employees from gaining access to the network and to these codes.

- **Environment** — do not place the unit in a room where the temperature is less than 5°C (41°F) or greater than 40°C (104°F). Allow 10 cm (4") clearance around the unit for proper ventilation. Avoid excessive smoke, dust, mechanical vibration, shock, or direct sunlight.
- **Medical** — consult the manufacturer of any personal medical devices, such as pacemakers or hearing aids, to determine if they are adequately shielded from external RF (radio frequency) energy. (The unit operates in the frequency range of 5760MHz to 5840MHz, and the power output level can range 0.25 to 0.5 watts.) Do not use the unit in health care facilities if any regulations posted in the area instruct you not to do so. Hospitals or health care facilities may be using equipment that could be sensitive to external RF (radio frequency) energy.
- **Routine care** — wipe the unit with a soft cloth. Do not use benzine, thinner, or any abrasive powder. When you leave the unit unused for a long period of time, unplug the AC adaptor from the outlet.
- **If there is any trouble** — disconnect the unit from the telephone line and connect a known working phone. If the known working phone operates properly, have your unit repaired by one of the authorized Panasonic Factory Service Centers. If the known working phone does not operate properly, consult your telephone company.

# Index

<b>A</b>		<b>E</b>	
Accessories . . . . .	2	Erasing messages . . . . .	67
Accessory handset . . . . .	3	Erasing all messages . . . . .	67
Answering calls, base unit . . . . .	31	Error messages . . . . .	82
Answering calls, handset . . . . .	31	Extension number . . . . .	47, 80, 81
Answering System . . . . .	63	<b>F</b>	
Auto talk . . . . .	19, 31, 48	FCC and other information . . . . .	96
<b>B</b>		FLASH button . . . . .	58
Backlit LCD . . . . .	29	Flash time . . . . .	58
Base unit location . . . . .	6	– <i>Function menu,</i>	
Battery charge . . . . .	6, 13	<i>Direct commands</i> . . . . .	78, 79
– <i>Battery information</i> . . . . .	14	Function menu, selection . . . . .	15
Battery replacement . . . . .	13, 14	Function menu, table . . . . .	16
Battery strength . . . . .	13	<b>G</b>	
Belt clip . . . . .	77	– <i>Greeting message</i> . . . . .	23
– <i>Booster</i> . . . . .	29	<b>H</b>	
<b>C</b>		Headset, optional . . . . .	77
Call share . . . . .	53	Hold . . . . .	28, 30
Call Waiting Caller ID display . . . . .	57	<b>I</b>	
Call waiting tone . . . . .	57	Incoming call tone . . . . .	59
– <i>Caller ID number auto edit</i> . . . . .	36, 37	Installation, AC adaptor . . . . .	12
– <i>Call monitoring</i> . . . . .	63	Installation, battery . . . . .	13
Caller ID service . . . . .	32	Installation, telephone line cord . . . . .	12
Caller IQ . . . . .	90	Intercom call . . . . .	47
Caller List, editing . . . . .	36	<b>K</b>	
Caller List, erasing . . . . .	38	Key tone . . . . .	60
Caller List, storing . . . . .	38	<b>L</b>	
Caller List, viewing . . . . .	35	LCD contrast . . . . .	22
Calling back from the Caller List . . . . .	35	Lighted handset keypad . . . . .	29
– <i>Chain dial</i> . . . . .	42	Line mode . . . . .	19
CID (Caller ID) . . . . .	34	Listening to messages . . . . .	64, 65, 70
– <i>Clarity booster</i> . . . . .	29	Location of controls . . . . .	7, 8
CONF (Conference) . . . . .	53		
Conference calls . . . . .	53		
– <i>Copy phone book</i> . . . . .	44		
<b>D</b>			
– <i>Date and time</i> . . . . .	17		
Deregistration . . . . .	80		
Dialing mode . . . . .	18		
Direct commands . . . . .	78, 79		
Displays . . . . .	10		
Display language . . . . .	18		

For assistance, please call: 1-800-211-PANA(7262)



Useful Information

## Index

### M

- Mailbox . . . . . 61
- Mailbox, password . . . . . 62
- *Mailbox, transferring a call* . . . . . 69
- Making calls, base unit . . . . . 30
- Making calls, handset . . . . . 27
- Memo message . . . . . 68, 72
- *Message alert* . . . . . 26, 64, 65
- Message storage . . . . . 24
- Microphone, base unit . 23, 30, 49, 68
- Microphone, handset . . . . . 27
- *Monitoring incoming calls* . . . . . 63
- Mute . . . . . 56

### N

- Navigator key . . . . . 9
- Noise . . . . . 6
- Number of rings . . . . . 25

### O

- openLCR . . . . . 90

### P

- Paging . . . . . 47
- PAUSE . . . . . 56
- *Phone book* . . . . . 39
- *Phone book, copying* . . . . . 44, 45
- Phone book, dialing . . . . . 41, 42
- Phone book, downloading . . . . . 91
- Phone book, editing . . . . . 43
- Phone book, erasing . . . . . 43
- Phone book, names . . . . . 40
- Phone book, storing . . . . . 39
- Power failure . . . . . 12, 17, 24
- Privacy feature . . . . . 56
- Pulse service . . . . . 57

### R

- *Recording mode* . . . . . 26
- Recording time . . . . . 24
- Redial . . . . . 28, 30
- Redial list . . . . . 28
- *Registration* . . . . . 80, 81
- Registration, canceling . . . . . 80
- Remote code . . . . . 71

- Remote operation, handset . . . . . 65
- Remote operation, touch tone  
phone . . . . . 70
- Ringer off . . . . . 20, 21, 31
- Ringer tone . . . . . 21, 22
- Ringer volume . . . . . 20, 21
- Room monitor . . . . . 54
- Rotary service, tone dialing . . . . . 57

### S

- Safety instructions . . . . . 94
- Shipping product for service  
. . . . . Back cover
- Soft keys . . . . . 9
- Speed dialer . . . . . 46
- Specifications . . . . . 103
- SP-phone, base unit . . . . . 30
- SP-phone, handset . . . . . 27

### T

- *Talking Caller ID* . . . . . 32, 33, 34
- Toll saver . . . . . 25
- *Transferring a call* . . . . . 50
- Troubleshooting, Answering  
System . . . . . 87
- Troubleshooting, general . . . . . 88
- Troubleshooting, openLCR  
service for Caller IQ . . . . . 89
- Troubleshooting, Telephone  
System . . . . . 84
- TTY . . . . . 2, 102, Back Cover

### V

- VE (Voice Enhancer) . . . . . 29
- *Voice enhancer technology* . . . . . 29
- Voice menu . . . . . 66, 72
- *Voice paging* . . . . . 49
- Volume control, base unit . 24, 30, 66
- Volume control, handset . . . . . 28, 66

### W

- Wall mounting . . . . . 74
- Warranty . . . . . 101

- “–” indicates important information  
and frequently used features.

**PANASONIC CONSUMER  
ELECTRONICS COMPANY, DIVISION  
OF MATSUSHITA ELECTRIC  
CORPORATION OF AMERICA  
One Panasonic Way  
Secaucus, New Jersey 07094**

**PANASONIC SALES COMPANY,  
DIVISION OF MATSUSHITA  
ELECTRIC OF PUERTO RICO, INC.,  
Ave. 65 de Infanteria, Km. 9.5  
San Gabriel Industrial Park  
Carolina, Puerto Rico 00985**

## **Panasonic Telephone Products Limited Warranty**

### **Limited Warranty Coverage**

If your product does not work properly because of a defect in materials or workmanship, Panasonic Consumer Electronics Company or Panasonic Sales Company (collectively referred to as "the warrantor") will, for the length of the period indicated on the chart below, which starts with the date of original purchase ("Limited Warranty period"), at its option either (a) repair your product with new or refurbished parts, or (b) replace it with a new or a refurbished product. The decision to repair or replace will be made by the warrantor.

**Parts  
One (1) Year**

**Labor  
One (1) Year**

During the "Labor" Limited Warranty period there will be no charge for labor. During the "Parts" Limited Warranty period, there will be no charge for parts. You must mail-in your product during the Limited Warranty period. This Limited Warranty excludes both parts and labor for batteries, antennas, and cosmetic parts (cabinet). This Limited Warranty only applies to products purchased and serviced in the United States or Puerto Rico. This Limited Warranty is extended only to the original purchaser and only covers products purchased as new.

### **Mail-In Service**

For assistance in the continental U.S.A. in obtaining repairs please ship the product to:

**Panasonic Services Company Customer Servicer  
Suite B 4900 George McVay Drive McAllen, TX 78503**

✂ For assistance in Puerto Rico call Panasonic Sales Company (787)-750-4300 or fax (787)-768-2910.

For Limited Warranty service for headsets if a headset is included with this product please call Panasonic Call Center at 1-800-211-PANA (7262).

When shipping the unit carefully pack, include all accessories, and send it prepaid, adequately insured and preferably in the original carton. Include a letter detailing the complaint and provide a day time phone number where you can be reached.

**IF REPAIR IS NEEDED DURING THE LIMITED WARRANTY PERIOD THE PURCHASER WILL BE REQUIRED TO FURNISH A SALES RECEIPT/PROOF OF PURCHASE INDICATING DATE OF PURCHASE, AMOUNT PAID AND PLACE OF PURCHASE. CUSTOMER WILL BE CHARGED FOR THE REPAIR OF ANY UNIT RECEIVED WITHOUT SUCH PROOF OF PURCHASE.**

### **Limited Warranty Limits And Exclusions**

This Limited Warranty ONLY COVERS failures due to defects in materials or workmanship, and DOES NOT COVER normal wear and tear or cosmetic damage. The Limited Warranty ALSO DOES NOT COVER damages which occurred in shipment, or failures which are caused by products not supplied by the warrantor, or failures which result from accidents, misuse, abuse, neglect, mishandling, misapplication, alteration, faulty installation, set-up adjustments, misadjustment of consumer controls, improper maintenance, power line surge, lightning damage, modification, introduction of sand, humidity or liquids, commercial use such as hotel, office, restaurant, or other business or rental use of the product, or service by anyone other than a Factory Servicer or other Authorized Servicer, or damage that is attributable to acts of God.

**THERE ARE NO EXPRESS WARRANTIES EXCEPT AS LISTED UNDER "LIMITED WARRANTY COVERAGE". THE WARRANTOR IS NOT LIABLE FOR INCIDENTAL OR CONSEQUENTIAL DAMAGES RESULTING FROM THE USE OF THIS PRODUCT, OR ARISING OUT OF ANY BREACH OF THIS LIMITED WARRANTY.** (As examples, this excludes damages for lost time, lost calls or messages, cost of having someone remove or re-install an installed unit if applicable, travel to and from the servicer. The items listed are not exclusive, but are for illustration only.) **ALL EXPRESS AND IMPLIED WARRANTIES, INCLUDING THE WARRANTY OF MERCHANTABILITY, ARE LIMITED TO THE PERIOD OF THE LIMITED WARRANTY.**

Some states do not allow the exclusion or limitation of incidental or consequential damages, or limitations on how long an implied warranty lasts, so the exclusions may not apply to you. This Limited Warranty gives you specific legal rights and you may also have other rights which vary from state to state. If a problem with this product develops during or after the Limited Warranty period, you may contact your dealer or Servicenter. If the problem is not handled to your satisfaction, then write to the warrantor's Consumer Affairs Department at the addresses listed for the warrantor.

**PARTS AND SERVICE, WHICH ARE NOT COVERED BY THIS LIMITED WARRANTY, ARE YOUR RESPONSIBILITY.**

## ***Customer Services Directory***

Obtain Product Information and Operating Assistance; locate your nearest Dealer or Servicenter; purchase Parts and Accessories; or make Customer Service and Literature requests by visiting our Web Site at:

**<http://www.panasonic.com/support>**

or, contact us via the web at:

**<http://www.panasonic.com/contactinfo>**

You may also contact us directly at: 1-800-211-PANA (7262),  
Monday-Friday 9 am-9 pm; Saturday-Sunday 10 am-7 pm, EST.

For hearing or speech impaired TTY users, TTY : 1-877-833-8855

## ***Accessory Purchases***

Purchase Parts, Accessories and Instruction Books online for all Panasonic Products by visiting our Web Site at:

**<http://www.pasc.panasonic.com>**

or, send your request by E-mail to:

**[npcparts@panasonic.com](mailto:npcparts@panasonic.com)**

You may also contact us directly at:

1-800-332-5368 (Phone) 1-800-237-9080 (Fax Only)  
(Monday - Friday 9 am to 8 pm, EST.)

Panasonic Services Company

20421 84th Avenue South, Kent, WA 98032

(We Accept Visa, MasterCard, Discover Card, American Express,  
and Personal Checks)

For hearing or speech impaired TTY users, TTY : 1-866-605-1277

## ***Service in Puerto Rico***

***Matsushita Electric of Puerto Rico, Inc. Panasonic Sales Company  
Factory Servicenter:***

***Ave. 65 de Infantería, Km. 9.5, San Gabriel Industrial Park,  
Carolina, Puerto Rico 00985***

***Phone (787)750-4300, Fax (787)768-2910***

## Specifications

### N Handset

<b>Power Supply:</b>	Ni-MH battery (3.6 V, 830 mAh)
<b>Frequency:</b>	5.76 GHz – 5.84 GHz
<b>Dimensions (H x W x D):</b>	Approx. 220 mm x 53 mm x 37 mm (8 <sup>21</sup> / <sub>32</sub> " x 2 <sup>3</sup> / <sub>32</sub> " x 1 <sup>15</sup> / <sub>32</sub> " )
<b>Mass (Weight):</b>	Approx. 210 g (0.46 lb.)
<b>Security Codes:</b>	1,000,000

### N Base Unit

<b>Power Supply:</b>	AC adaptor (120 V AC, 60 Hz)
<b>Power Consumption:</b>	Standby: Approx. 2.5 W Maximum: Approx. 6.0 W
<b>Frequency:</b>	5.76 GHz – 5.84 GHz
<b>Dimensions (H x W x D):</b>	Approx. 107 mm x 251 mm x 135 mm (4 <sup>7</sup> / <sub>32</sub> " x 9 <sup>7</sup> / <sub>8</sub> " x 5 <sup>5</sup> / <sub>16</sub> " )
<b>Mass (Weight):</b>	Approx. 480 g (1.06 lb.)

### N Charger (KX-TG5243 only)

<b>Power Supply:</b>	AC adaptor (120 V AC, 60 Hz)
<b>Power Consumption:</b>	Standby: Approx. 0.8 W Maximum: Approx. 4.0 W
<b>Dimensions (H x W x D):</b>	Approx. 69 mm x 74 mm x 100 mm (2 <sup>23</sup> / <sub>32</sub> " x 2 <sup>29</sup> / <sub>32</sub> " x 3 <sup>15</sup> / <sub>16</sub> " )
<b>Mass (Weight):</b>	Approx. 120 g (0.26 lb.)

**N Dialing Mode:** Tone (DTMF)/Pulse

**N Operating Environment:** 5 °C – 40 °C (41 °F – 104 °F)

Specifications are subject to change without notice.

### Energy Star:

As an ENERGY STAR® Participant, Panasonic has determined that this product meets the ENERGY STAR guidelines for energy efficiency. ENERGY STAR is a U.S. registered mark.



For assistance, please call: 1-800-211-PANA(7262)

### For product service

- Visit our website: <http://www.panasonic.com/support>
- Contact us via the web at: <http://www.panasonic.com/contactinfo>
- Call us at: 1-800-211-PANA(7262)

### When you ship the product

- Carefully pack your unit, preferably in the original carton.
- Attach a letter, detailing the symptom, to the outside of the carton.

Symptom

---

- Send the unit to an authorized servicer, prepaid and adequately insured.
- Do not send your unit to the Panasonic Consumer Electronics Company listed below or to executive or regional sales offices. These locations do not repair consumer products.

### For your future reference

Serial No. \_\_\_\_\_

Date of purchase \_\_\_\_\_

(found on the bottom of the unit)

Name and address of dealer \_\_\_\_\_

- This cordless telephone is designed for use in the United States of America. Sale or use of this product in other countries may violate local laws.
- Ce téléphone sans fil est conçu pour être utilisé aux États-Unis d'Amérique. La vente ou l'emploi de cet appareil dans certains autres pays peut constituer une infraction à la législation locale.
- Este teléfono inalámbrico fue elaborado para uso en los Estados Unidos de América. La venta o el empleo de este producto en ciertos países puede constituir violación de la legislación local.
- このコードレス電話機は、日本国外での使用を目的として設計されており、日本国内での使用は法律違反となります。従って、当社では日本国内においては原則として修理などのサービスは致しかねます。

**If you need assistance with setup or operation, please call 1-800-211-PANA(7262)**

**For hearing or speech impaired TTY users, TTY : 1-877-833-8855**

**Panasonic Consumer Electronics Company,  
Division of Matsushita Electric Corporation of America  
One Panasonic Way, Secaucus, New Jersey 07094**

**Panasonic Sales Company,  
Division of Matsushita Electric of Puerto Rico, Inc.  
Ave. 65 de Infantería, Km. 9.5, San Gabriel Industrial Park  
Carolina, Puerto Rico 00985**

© 2004 Panasonic Communications Co., Ltd. All Rights Reserved.

PQQX13995YD S0104-4084