

Panasonic®

Operating Instructions

Link-to-Cell Bluetooth Convergence Solution

Model No. **KX-TGE260**
KX-TGE262
KX-TGE263
KX-TGE264
KX-TG454SK
KX-TG484SK
KX-TGE270
KX-TGE272
KX-TGE273
KX-TGE274
KX-TGE275
KX-TG465SK

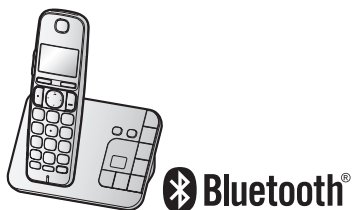

Model shown is KX-TGE260.

***Before initial use, see “Getting Started”
on page 11.***

Thank you for purchasing a Panasonic product.

Please read these operating instructions before using the unit and save them for future reference.

Consulte “Guía Rápida Española”, página 79.

For assistance, visit our Web site: <http://www.panasonic.com/help> for customers in the U.S.A. or Puerto Rico.

Please register your product: <http://www.panasonic.com/prodreg>

Table of Contents

Introduction		Programming	
Model composition	3	Menu list	37
Accessory information	3	Alarm	44
Important Information		Silent mode	45
For your safety	7	Call block	46
Important safety instructions	8	Other programming	47
For best performance	8	Registering a unit	48
Other information	9	Caller ID Service	
Specifications	10	Using Caller ID service	49
Getting Started		Caller list	49
Setting up	11	Using Bluetooth Devices	
Controls	13	Copying phonebook from a cellular phone (phonebook transfer)	52
Display icons/Indicators	14	Text message (SMS) alert	53
Language settings	16	Using a Bluetooth wireless headset (optional) for landline calls	54
Date and time	16	Answering System for Landline	
Recording your greeting message	16	Answering system for landline	56
Other settings	16	Turning the answering system on/off	56
Link to Cell		Greeting message	56
Link to cell feature	18	Listening to messages	57
Pairing a cellular phone	18	Advanced new message alerting features	58
Link to cell settings	19	Remote operation	60
Making/Answering Calls Using the Handset		Answering system settings	61
Making cellular calls	22	Useful Information	
Making landline calls	22	Voice mail service for landline	63
Answering calls	23	Wall mounting	64
Useful features during a call	23	Error messages	67
Power back-up operation for landline	26	Troubleshooting	68
Making/Answering Calls Using the Base Unit		FCC and other information	76
Making cellular calls	28	Guía Rápida Española	
Making landline calls	28	Guía Rápida Española	79
Answering calls	28	Appendix	
Useful features during a call	29	Customer services	89
Locator/Intercom		Warranty (For United States and Puerto Rico)	90
Handset locator	31	Index	
Cell locator	31	Index	92
Intercom	31		
Phonebook			
Phonebook	33		
Speed dial	36		

Model composition

■ KX-TGE260 series

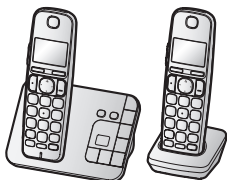

- Model shown is KX-TGE262.

■ KX-TGE270 series

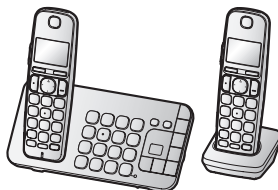

- Model shown is KX-TGE272.

Series	Model No.	Base unit	Handset	Quantity
		Part No.	Part No.	
KX-TGE260 series	KX-TGE260	KX-TGE260	KX-TGEA20	1
	KX-TGE262	KX-TGE260	KX-TGEA20	2
	KX-TGE263	KX-TGE260	KX-TGEA20	3
	KX-TGE264	KX-TGE260	KX-TGEA20	4
	KX-TG454SK	KX-TGE260	KX-TGEA20	4
	KX-TG484SK	KX-TGE260	KX-TGEA20	4
KX-TGE270 series	KX-TGE270	KX-TGE270	KX-TGEA20	1
	KX-TGE272	KX-TGE270	KX-TGEA20	2
	KX-TGE273	KX-TGE270	KX-TGEA20	3
	KX-TGE274	KX-TGE270	KX-TGEA20	4
	KX-TGE275	KX-TGE270	KX-TGEA20	5
	KX-TG465SK	KX-TGE270	KX-TGEA20	5

Accessory information

Supplied accessories

No.	Supplied handset qty.	1 unit*1	2 units*2	3 units*3	4 units*4	5 units*5
	Accessory item/ Order number	Accessory quantity				
①	AC adaptor/PNLV226Z	1	1	1	1	1

For assistance, please visit <http://www.panasonic.com/help>

Introduction

No.	Supplied handset qty.	1 unit* ¹	2 units* ²	3 units* ³	4 units* ⁴	5 units* ⁵
	Accessory item/ Order number	Accessory quantity				
②	Telephone line cord/ PQJA10075Z	1	1	1	1	1
③	Wall mounting adaptor* ⁶	1	1	1	1	1
④	Rechargeable batteries/ HHR-4DPA	2	4	6	8	10
⑤	Handset cover* ^{7, *8}	1	2	3	4	5
⑥	Belt clip* ⁹	1	2	3	4	5
⑦	Charger* ¹⁰	–	1	2	3	4

*1 KX-TGE260/KX-TGE270

*2 KX-TGE262/KX-TGE272

*3 KX-TGE263/KX-TGE273

*4 KX-TGE264/KX-TGE274/KX-TG454SK/KX-TG484SK

*5 KX-TGE275/KX-TG465SK

*6 PNKL1044Z1: White, PNKL1044Z2: Black

*7 The handset cover comes attached to the handset.

*8 PNYNTGEA20BR: Black, PNYNTGEA20SR: White

*9 PNKE1312Z1: White, PNKE1312Z2: Black

*10 PNLC1050ZB: Black, PNLC1050ZT: Titanium Black, PNLC1050ZS: Silver

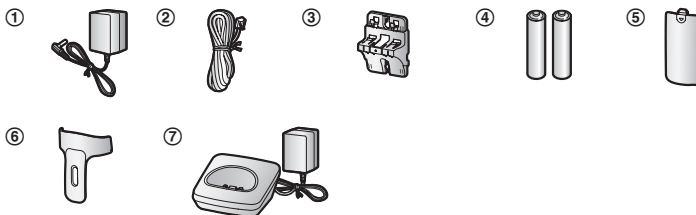

Additional/replacement accessories

Please contact your nearest Panasonic dealer for sales information (page 89).

Accessory item	Order number
Rechargeable batteries	HHR-4DPA* ¹ ● To order, please visit http://www.panasonic.com/batterystore
	Battery type: – Nickel metal hydride (Ni-MH) – 2 x AAA (R03) size for each handset
Headset	KX-TCA60, KX-TCA93, KX-TCA400, KX-TCA430

Introduction

Accessory item	Order number
T-adaptor	KX-J66
Range extender	KX-TGA405*2
Key detector	KX-TGA20*3

- *1 Replacement batteries may have a different capacity from that of the supplied batteries.
- *2 By installing this unit, you can extend the range of your phone system to include areas where reception was previously not available. This product can be purchased online. Please visit our Web site: <http://www.panasonic.com/RangeExtender>
- *3 By registering the key detector (4 max.) to a Panasonic Digital Cordless Phone and attaching it to an easy-to-lose item in advance, you can locate and find the mislaid item to which the key detector is attached. Please visit our Web site: <http://panasonic.net/pcc/products/telephone/p/tga20/>

Other information



- Design and specifications are subject to change without notice.
- The illustrations in these instructions may vary slightly from the actual product.

Expanding your phone system

Handset (optional): KX-TGEA20	
You can expand your phone system by registering optional handsets (6 max.) to a single base unit. <ul style="list-style-type: none">• Optional handsets may be a different color from that of the supplied handsets.	

Bluetooth® devices

You can expand your phone system by pairing the following units to a single base unit.

Your Bluetooth cellular phone*1: 2 max. (for cellular calls: page 18)	
Your Bluetooth headset*1: 1 max. (for a wireless hands-free conversation: page 54)	

- *1 Your cellular phone and headset must be Bluetooth wireless technology compatible. For more details and the list of compatible cellular phones, please visit our Web site: <http://www.panasonic.com/link2cell>

For assistance, please visit <http://www.panasonic.com/help>



Introduction

Trademarks

- The Bluetooth® word mark and logos are registered trademarks owned by Bluetooth SIG, Inc., and any use of such marks by Panasonic Corporation is under license.
- All other trademarks identified herein are the property of their respective owners.

Important Information

For your safety

To prevent severe injury and loss of life/property, read this section carefully before using the product to ensure proper and safe operation of your product.

WARNING

Power connection

- Use only the power source marked on the product.
- Do not overload power outlets and extension cords. This can result in the risk of fire or electric shock.
- Completely insert the AC adaptor/power plug into the power outlet. Failure to do so may cause electric shock and/or excessive heat resulting in a fire.
- Regularly remove any dust, etc. from the AC adaptor/power plug by pulling it from the power outlet, then wiping with a dry cloth. Accumulated dust may cause an insulation defect from moisture, etc. resulting in a fire.
- Unplug the product from power outlets if it emits smoke, an abnormal smell, or makes an unusual noise. These conditions can cause fire or electric shock. Confirm that smoke has stopped emitting and contact us at <http://www.panasonic.com/contactinfo>
- Unplug from power outlets and never touch the inside of the product if its casing has been broken open.
- Never touch the plug with wet hands. Danger of electric shock exists.

Installation

- To prevent the risk of fire or electrical shock, do not expose the product to rain or any type of moisture.
- Do not place or use this product near automatically controlled devices such as automatic doors and fire alarms. Radio waves emitted from this product may cause such devices to malfunction resulting in an accident.

- Do not allow the AC adaptor or telephone line cord to be excessively pulled, bent or placed under heavy objects.

Operating safeguards

- Unplug the product from power outlets before cleaning. Do not use liquid or aerosol cleaners.
- Do not disassemble the product.
- Do not spill liquids (detergents, cleansers, etc.) onto the telephone line cord plug, or allow it to become wet at all. This may cause a fire. If the telephone line cord plug becomes wet, immediately pull it from the telephone wall jack, and do not use.

Medical

- Consult the manufacturer of any personal medical devices, such as pacemakers or hearing aids, to determine if they are adequately shielded from external RF (radio frequency) energy. (The product operates in the frequency range of 1.92 GHz to 1.93 GHz, and the RF transmission power is 115 mW (max.).)
- Do not use the product in health care facilities if any regulations posted in the area instruct you not to do so. Hospitals or health care facilities may be using equipment that could be sensitive to external RF energy.

CAUTION

Installation and location

- Never install telephone wiring during an electrical storm.
- Never install telephone line jacks in wet locations unless the jack is specifically designed for wet locations.
- Never touch uninsulated telephone wires or terminals unless the telephone line has been disconnected at the network interface.
- Use caution when installing or modifying telephone lines.
- The AC adaptor is used as the main disconnect device. Ensure that the AC outlet is installed near the product and is easily accessible.

For assistance, please visit <http://www.panasonic.com/help>

7

Important Information

- This product is unable to make calls when:
 - the handset batteries need recharging or have failed.
 - there is a power failure.

Battery

- We recommend using the batteries noted on page 4. **USE ONLY rechargeable Ni-MH batteries AAA (R03) size.**
- Do not mix old and new batteries.
- Do not open or mutilate the batteries. Released electrolyte from the batteries is corrosive and may cause burns or injury to the eyes or skin. The electrolyte is toxic and may be harmful if swallowed.
- Exercise care when handling the batteries. Do not allow conductive materials such as rings, bracelets, or keys to touch the batteries, otherwise a short circuit may cause the batteries and/or the conductive material to overheat and cause burns.
- Charge the batteries provided with or identified for use with this product only, in accordance with the instructions and limitations specified in this manual.
- Only use a compatible base unit (or charger) to charge the batteries. Do not tamper with the base unit (or charger). Failure to follow these instructions may cause the batteries to swell or explode.

Attention:



A nickel metal hydride battery that is recyclable powers the product you have purchased. Please call 1-800-8-BATTERY (1-800-822-8837) for information on how to recycle this battery.

Important safety instructions

When using your product, basic safety precautions should always be followed to reduce the risk of fire, electric shock, and injury to persons, including the following:

1. Do not use this product near water for example, near a bathtub, washbowl, kitchen sink, or laundry tub, in a wet basement or near a swimming pool.
2. Avoid using a telephone (other than a cordless type) during an electrical storm. There may be a remote risk of electric shock from lightning.
3. Do not use the telephone to report a gas leak in the vicinity of the leak.
4. Use only the power cord and batteries indicated in this manual. Do not dispose of batteries in a fire. They may explode. Check with local codes for possible special disposal instructions.

SAVE THESE INSTRUCTIONS

For best performance

Base unit location/avoiding noise

The base unit and other compatible Panasonic units use radio waves to communicate with each other.

- For maximum coverage and noise-free communications, place your base unit:
 - at a convenient, high, and central location with no obstructions between the handset and base unit in an indoor environment.
 - away from electronic appliances such as TVs, radios, personal computers, wireless devices, or other phones.
 - facing away from radio frequency transmitters, such as external antennas of mobile phone cell stations. (Avoid putting the base unit on a bay window or near a window.)
- Coverage and voice quality depends on the local environmental conditions.

Important Information

- If the reception for a base unit location is not satisfactory, move the base unit to another location for better reception.

Environment

- Keep the product away from electrical noise generating devices, such as fluorescent lamps and motors.
- The product should be kept free from excessive smoke, dust, high temperature, and vibration.
- The product should not be exposed to direct sunlight.
- Do not place heavy objects on top of the product.
- When you leave the product unused for a long period of time, unplug the product from the power outlet.
- The product should be kept away from heat sources such as heaters, kitchen stoves, etc. It should not be placed in rooms where the temperature is less than 0 °C (32 °F) or greater than 40 °C (104 °F). Damp basements should also be avoided.
- The maximum calling distance may be shortened when the product is used in the following places: Near obstacles such as hills, tunnels, underground, near metal objects such as wire fences, etc.
- Operating the product near electrical appliances may cause interference. Move away from the electrical appliances.

Routine care

- **Wipe the outer surface of the product with a soft moist cloth.**
- Do not use benzine, thinner, or any abrasive powder.

Other information

CAUTION: Risk of explosion if battery is replaced by an incorrect type. Dispose of used batteries according to the instructions.

Notice for product disposal, transfer, or return

- This product can store your private/confidential information. To protect your privacy/confidentiality, we recommend that you erase information such as phonebook or caller list entries from the memory before you dispose of, transfer, or return the product.

Notice

- This product is designed for use in the United States of America. Sale or use of this product in other countries may violate local laws.
- Cet appareil est conçu pour être utilisé aux États-Unis d'Amérique. La vente ou l'emploi de cet appareil dans certains autres pays peut constituer une infraction à la législation locale.
- Este producto está diseñado para usarse en los Estados Unidos de América. La venta o el empleo de este producto en ciertos países puede constituir violación de la legislación local.
- 本產品專為美國使用而設。若在其他國家銷售或使用，可能會違反當地法例。
- この製品は、日本国外での使用を目的として設計されており、日本国内での使用は法律違反となります。従って、当社では日本国内においては原則として修理などのサービスは致しかねます。

ENERGY STAR

As an ENERGY STAR® Partner, Panasonic has determined that this product meets the ENERGY STAR guidelines for energy efficiency. ENERGY STAR is a U.S. registered mark.



Important Information

Specifications

- **Standard:**
DECT 6.0 (Digital Enhanced Cordless
Telecommunications 6.0)
Bluetooth wireless technology 2.1
- **Frequency range:**
1.92 GHz to 1.93 GHz (DECT)
2.402 GHz to 2.48 GHz (Bluetooth)
- **RF transmission power:**
115 mW (max.)
- **Power source:**
120 V AC, 60 Hz
- **Power consumption:**
Base unit:
Standby: Approx. 1.2 W
Maximum: Approx. 4.5 W
Charger:
Standby: Approx. 0.1 W
Maximum: Approx. 1.8 W
- **Operating conditions:**
0 °C – 40 °C (32 °F – 104 °F), 20 % – 80 %
relative air humidity (dry)

Setting up

Connections

- If you do not connect the telephone line cord and use only cellular lines, set the cellular line only mode to use this unit more conveniently (page 20).

■ Base unit

- ① Connect the AC adaptor to the unit by pressing the plug firmly.
- ② Fasten the cord by hooking it.
- ③ Connect the AC adaptor to the power outlet.
- ④ Connect the telephone line cord to the unit, then to the single-line telephone jack (RJ11C) until you hear a click.
- ⑤ A DSL/ADSL filter (not supplied) is required if you have a DSL/ADSL service.

Note:

- Use only the supplied Panasonic AC adaptor PNLV226.

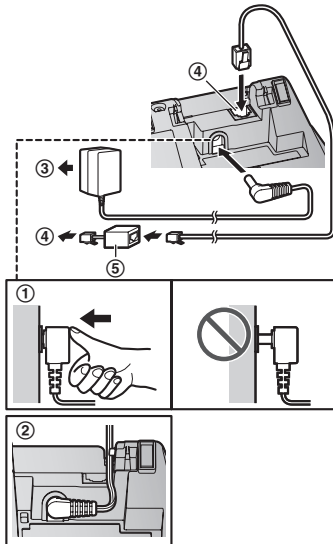

■ Charger

- ① Connect the AC adaptor to the power outlet.

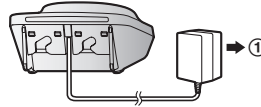

Battery installation

- USE ONLY rechargeable Ni-MH batteries AAA (R03) size (A).
- Do NOT use Alkaline/Manganese/Ni-Cd batteries.
- Confirm correct polarities (+, -).

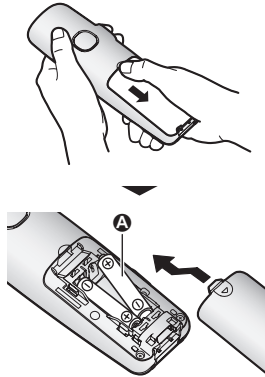

- Follow the directions on the display to set up the unit.

Getting Started

Battery charging

Charge for about 7 hours.

- Confirm “Charging” is displayed (A).
- When the batteries are fully charged, “Fully charged” is displayed.

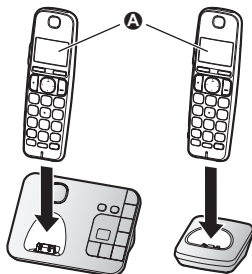

Note when setting up

Note for connections

- The AC adaptor must remain connected at all times. (It is normal for the adaptor to feel warm during use.)
- The AC adaptor should be connected to a vertically oriented or floor-mounted AC outlet. Do not connect the AC adaptor to a ceiling-mounted AC outlet, as the weight of the adaptor may cause it to become disconnected.

Note for battery installation

- Use the supplied rechargeable batteries. For replacement, we recommend using the Panasonic rechargeable batteries noted on page 4, 8.

Note for battery charging

- It is normal for the handset to feel warm during charging.
- Clean the charge contacts of the handset, base unit, and charger with a soft and dry cloth once a month. Before cleaning the unit, disconnect from power outlets and any telephone line cords. Clean more often if the unit is exposed to grease, dust, or high humidity.

Battery level

Icon	Battery level
	High
	Medium
	Low
	Needs charging.
	Empty

Panasonic Ni-MH battery performance (supplied batteries)

Operation	Operating time
In continuous use	10 hours max.*1
Not in use (standby)	8 days max.*1

*1 If eco mode is on.

Note:

- Actual battery performance depends on usage and ambient environment.

Intelligent eco mode

This feature automatically reduces handset power consumption by suppressing handset transmission power when the handset is close to the base unit.

- When this feature is activated, **ECO** is displayed. However, during a cellular call, **ECO** is not displayed even though this feature is activated.
- Eco mode is turned off when the clarity booster is activated (page 24).

Controls

Handset

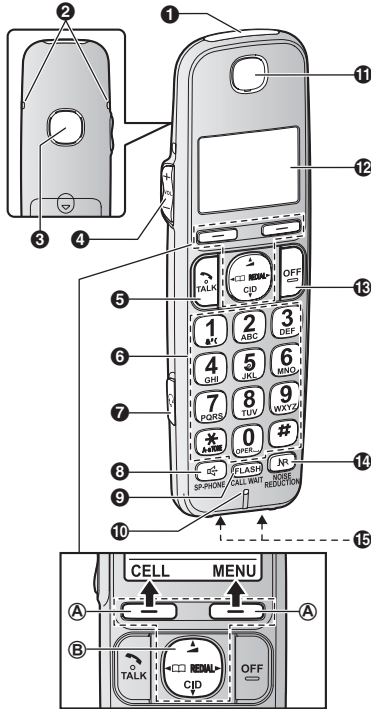

- 1 Ringer indicator
- 2 Belt clip holes
- 3 Speaker
- 4 [+]/[-] (VOL.: Volume up/down)
- 5 [TALK]
- 6 Dial keypad (TONE)
- 7 Headset jack
- 8 [SP-PHONE] (Speakerphone)
- 9 [FLASH]/[CALL WAIT]
- 10 Microphone
- 11 Receiver
- 12 Display

- 13 [OFF]
- 14 [NR] (NOISE REDUCTION/Smart function key)
- NR indicator
- 15 Charge contacts

Control type

A Soft keys

By pressing a soft key, you can select the feature shown directly above it on the display. After a cellular phone is paired, [CELL] is displayed.

B Navigator key

- [▲], [▼], [◀], or [▶]: Scroll through various lists and items.
- [◀] (Volume: [▲] or [▼]): Adjust the receiver or speaker volume while talking.
- [◀] □: View the phonebook entry.
- [▶] REDIAL: View the redial list.
- [▼] CID (Caller ID): View the caller list.

Base unit

KX-TGE260 series: page 3

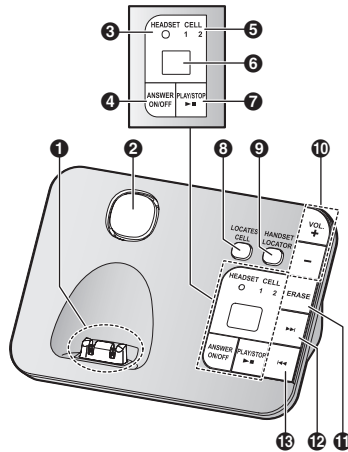

- 1 Charge contacts
- 2 Speaker
- 3 HEADSET indicator
- 4 [ANSWER/PAUSE/ON/OFF]
- 5 CELL 1 indicator
- CELL 2 indicator

Getting Started

- 6 Message counter
- 7 [▶■] (PLAY/STOP)
Message indicator
- 8 [LOCATES CELL]
- 9 [HANDSET LOCATOR]
- 10 [+]/[-] (VOL.: Volume up/down)
- 11 [ERASE]
- 12 [▶▶] (Skip)
- 13 [◀◀] (Repeat)

■ KX-TGE270 series: page 3

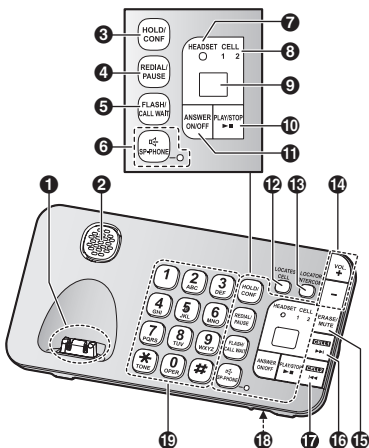

- 1 Charge contacts
- 2 Speaker
- 3 [HOLD] [CONF]
- 4 [REDIAL] [PAUSE]
- 5 [FLASH] [CALL WAIT]
- 6 [☎] (SP-PHONE: Speakerphone)
SP-PHONE indicator
- 7 HEADSET indicator
- 8 CELL 1 indicator
- 9 CELL 2 indicator
- 10 Message counter
- 11 [▶■] (PLAY/STOP)
Message indicator
- 12 [ANSWER ON/OFF]
- 13 [LOCATES CELL]
- 14 [LOCATOR] [INTERCOM]
- 15 [+]/[-] (VOL.: Volume up/down)
- 16 [ERASE] [MUTE]
- 17 [CELL 1] [▶▶] (Skip)







- 17 [CELL 2] [◀◀] (Repeat)
- 18 Microphone
- 19 Dial keypad [TONE]

Display icons/Indicators

Handset display items

Item	Meaning
	Within base unit range
	Out of base unit range
	The landline is in use. <ul style="list-style-type: none"> • When flashing: The call is put on hold. • When flashing rapidly: An incoming call is now being received.
	A cellular line is in use.*1 <ul style="list-style-type: none"> • When flashing: The cellular call is put on hold. • When flashing rapidly: A cellular call is being received.
	A cellular phone is connected.*1 Ready to make/receive cellular calls. <ul style="list-style-type: none"> • When turned off: A cellular phone is not connected to the base unit. (page 20)
	<ul style="list-style-type: none"> - A cellular call is being done on that line. - The cellular line is selected for the setting.
	Eco mode is on.*2 (page 12)
	Noise reduction is set. (page 24)
	Equalizer is set. (page 24)
	Speakerphone is on. (page 22)
	Ringer volume is off.*3 (page 39, 41)
	Silent mode is on. (page 45)

Getting Started

Item	Meaning
	Call sharing mode is off. (page 43)
	Alarm is on. (page 44)
	Handset number
	Battery level
	Blocked call (page 46)
	Clarity booster is on.*2 (page 24)
In use	Answering system is being used by another handset or the base unit.
Cell1 in use	Someone is using the corresponding line.
Cell2 in use	
C1&C2 in use	
Line in use	

- *1 Corresponding cellular line(s) is(are) indicated next to the item.
- *2 During a cellular call, the item is not displayed even though the feature is activated.
- *3 Corresponding lines (1, 2: cellular line, L: landline) are indicated next to the item. If all lines are turned off, no line is indicated.

Base unit display item

Item	Meaning
	“Greeting only” is selected. Caller messages are not recorded. (page 62)

CELL indicators on the base unit

The CELL indicators show each cellular line status.

Status	Meaning
On	A cellular phone is connected. Ready to make/receive cellular calls.

Status	Meaning
Flashing	<ul style="list-style-type: none"> – The cellular line is in use. – Phonebook entries are being copied from a cellular phone (page 52). – The base unit is searching for the paired cellular phone. – The base unit is pairing a cellular phone. – A cellular call is put on hold.
Flashing rapidly	A cellular call is being received.
Light off	<ul style="list-style-type: none"> – A cellular phone is not paired to the base unit. – A cellular phone is not connected to the base unit (page 20).

Bluetooth HEADSET indicator on the base unit

The HEADSET indicator shows the Bluetooth headset status.

Status	Meaning
On	A Bluetooth headset is connected to the base unit. Ready to use it.
Flashing	<ul style="list-style-type: none"> – A Bluetooth headset is in use. – The base unit is searching for the paired Bluetooth headset. – The base unit is pairing a headset. – Mute is turned on.
Flashing rapidly	A landline call is being received.
Light off	<ul style="list-style-type: none"> – The Bluetooth headset is not connected to the base unit. – A Bluetooth headset is not paired to the base unit.

Getting Started

Language settings

Display language

You can select either “English” or “Español” as the display language. The default setting is “English”.

- 1 [MENU]#1110
- 2 [↕]: Select the desired setting. → [SAVE]
- 3 [OFF]

Voice guidance language

You can select either “English” or “Español” as the voice guidance language of the answering system. The default setting is “English”.

- 1 [MENU]#1112
- 2 [↕]: Select the desired setting.
- 3 [SAVE] → [OFF]

Date and time

- 1 [MENU]#101
- 2 Enter the current month, date, and year by selecting 2 digits for each.
Example: July 15, 2014
07 15 14
- 3 [OK]
- 4 Enter the current hour and minute (12-hour clock format) by selecting 2 digits for each.
Example: 9:30
09 30
- 5 [X]: Select “AM” or “PM”.
- 6 [SAVE] → [OFF]

Note:

- When English is selected as the display language, 12-hour clock format is used. When Spanish is selected, 24-hour clock format is used.

Recording your greeting message

You can record your own greeting message instead of using a pre-recorded greeting message. See page 56 for details.

- 1 [MENU]#302
- 2 [↕]: “Yes” → [SELECT]
- 3 Record a greeting message. → [STOP] → [OFF]

Other settings

Smart function key (NR key)

The Smart function key (NR key) is located on the bottom of the handset and informs you with its flashing to allow you to activate the following features by simply pressing this key.

- When the NR indicator flashes rapidly, you can:
 - Answer the call (outside call, intercom). (page 23, 32)
 - Stop paging. (page 31)
 - Stop the alarm sound. (page 45)
- When the NR indicator flashes slowly in standby mode, you can:
 - Listen to new messages. (page 57)
 - Listen to new voice mail messages. (page 64)
 - View the caller list when there are missed calls. (page 50)To activate these features, their Smart function key must be “On”. (page 17)

Using the Smart function key (NR key)

When the NR indicator flashes rapidly/slowly, press [NR].

- The above features can be activated depending the situation.
- If you answer a call using the Smart function key, the speakerphone is activated.
- Even if the handset is placed on the base unit or charger, the feature can be

activated. You can talk or listen to new messages without lifting up the handset. If you want to perform further operations, lift up the handset.

- When the unit has new messages, new voice mail messages, and missed calls, the unit can be operated to play the new messages first, play the new voice mail messages next, and then show the missed calls.

Setting the Smart function key

The Smart function key for the following features must be "On".

- "New message" (Default: On)
- "New VM" (Default: On)
- "Missed Call" (Default: Off)

The settings can be set for each handset.

- 1 **[MENU]#|2|7|8**
- 2 **[↕]**: Select the desired setting and press **[SELECT]**.
 - "✓" is displayed next to the selected features.
 - To cancel a selected feature, press **[SELECT]** again. "✓" disappears.
- 3 **[SAVE] → [OFF]**

Note:

- If the **NR** indicator flashes when the handset is not placed on the base unit or charger, battery consumption is faster than usual.

Dialing mode

If you cannot make calls, change this setting according to your telephone line service. The default setting is "Tone".

"Tone": For tone dial service.

"Pulse": For rotary/pulse dial service.

- 1 **[MENU]#|1|2|0**
- 2 **[↕]**: Select the desired setting.
- 3 **[SAVE] → [OFF]**

Link to Cell

Link to cell feature

You can connect your base unit and cellular phone using Bluetooth wireless technology, so that you can make or answer cellular calls using your phone system. This allows you to:

- use the unit to talk on cellular calls even if some areas of your home have poor cellular reception, simply by placing your cellular phone in an area with good reception.
- talk on cellular calls even if your cellular phone is in your pocket or bag.
- enjoy cordless cellular calls even if your cellular phone plugged in and charging.

Important:

- Your cellular phone must support the Hands Free Profile (HFP) specification.
- You may pair 2 cellular phones and 1 headset.
- The unit can be used to talk on 2 lines at the same time (for example, 2 cellular lines, or the landline and 1 cellular line).
- Only 2 Bluetooth devices can be used with the unit at the same time (for example, 2 cellular lines, or the headset and 1 cellular line).
- Locate your cellular phone near the base unit. If the cellular phone is too close to the base unit during a cellular call, you may hear noise. For best performance, we recommend placing the cellular phone between 0.6 m to 3 m (2 feet to 10 feet) away from the base unit.

Pairing a cellular phone

Important:

- For more details and the list of compatible cellular phones, please visit our Web site: <http://www.panasonic.com/link2cell>
- Before pairing a Bluetooth enabled cellular phone to the base unit, make sure that no other Bluetooth device such as a Bluetooth headset is connected to your cellular phone.

1 Handset:

For CELL 1: **[MENU]#6241**
For CELL 2: **[MENU]#6242**

- After the corresponding CELL indicator on the base unit starts flashing, the rest of the procedure must be completed within 5 minutes.

2 Your cellular phone:

While the corresponding CELL indicator is flashing, follow the instructions of your cellular phone to enter the pairing mode.

- Depending on your cellular phone, it may ask you to enter the Bluetooth PIN (default: "0000"). If your cellular phone shows PassKey confirmation on its display, follow the directions to proceed.

3 Handset:

Wait until a long beep sounds.

- It may take more than 10 seconds to complete pairing.
- When the corresponding CELL indicator lights up, the cellular phone is connected to the base unit. You are ready to make cellular calls.

4 [OFF]

Note:

- Make sure that your cellular phone is set to connect to this product automatically. Refer to your cellular phone's operating instructions.
- Make sure you cancel your cellular phone's current pairing if you want to pair it to the other line (page 18).
- The default setting for the text message alert feature is "On (no announce)", so when you pair your cellular phone to the base unit, this feature may be activated (page 53). (This depends on the version and type of cellular phone you are using.)

Unpairing a cellular phone

You can cancel the pairing of a cellular phone that is stored in the base unit.

1 For CELL 1: **[MENU]#61111**
For CELL 2: **[MENU]#61112**

2 [↕]: "Yes" → [SELECT]

- When the cellular phone is unpaired, the CELL indicator is turned off.

3 [OFF]

Link to cell settings

Selecting which unit receives cellular calls

You can select which unit rings and receives calls for a cellular line. When “**all**” is selected, all handsets and the base unit ring.

- 1 For CELL 1: **[MENU]#[6][2][7][1]**
For CELL 2: **[MENU]#[6][2][7][2]**
- 2 **[↕]**: Select the desired handset or “**all**”.
→ **[SAVE]**
- 3 **[OFF]**

Note:

- When you select a specific handset to receive calls for a cellular line:
 - other handsets cannot answer the calls.
 - the base unit can answer the calls even though it does not ring. However, you can make the base unit ring by adjusting the base unit ringer volume (page 39). (KX-TGE270 series: page 3)
- When you change the setting to “**all**”, the base unit ringer volume also returns to the lowest level even if the ringer volume has been changed.
- The units selected with this setting have the text message alert feature (page 53) applied to them.

Ring as cell mode

Once this feature is turned on, the handset and base unit ring using the same ringer tone as your cellular phone.

The following settings are available:

- “**off**”: Turn this feature off to use the ringer tones of the handset and base unit. Caller information is announced depending on the Talking Caller ID setting (page 41).
- “**On (with Talking CID)**” (default): The handset and base unit use your cellular phone’s ringer tone. Caller information is announced even if the Talking Caller ID is turned off.
- “**On (without Talking CID)**”: The handset and base unit use your cellular phone’s ringer tone. Caller information is

not announced even if the Talking Caller ID is turned on.

Important:

- To use this feature, your cellular phone must support Bluetooth in-band ringtone. Refer to your cellular phone’s operating instructions.

- 1 For CELL 1: **[MENU]#[6][1][4][1]**
For CELL 2: **[MENU]#[6][1][4][2]**
- 2 **[↕]**: Select the desired setting.
- 3 **[SAVE]** → **[OFF]**

Note:

- The units use the preset ringer tones (page 41) instead of your cellular phone’s ringer tone when a cellular call is being received if:
 - your cellular phone is in silent mode (depending on your cellular phone).
 - the base unit is in use.
 - 2 handsets are sharing a landline call.
- If your cellular phone is in silent mode with “**On (with Talking CID)**” set, the unit announces caller information even when Talking Caller ID is turned off (page 41).

To use the handset ringer tone instead of your cellular phone’s ringer tone

Select “**off**” in step 2, “Ring as cell mode”, page 19.

To change the handset ringer tone for a cellular line, see page 39.

Auto connection to the Bluetooth devices (cellular phones or headset)

After pairing, your Bluetooth devices are connected to the base unit. If you move the Bluetooth devices out of base unit range, the Bluetooth devices are disconnected from the base unit. This feature allows the base unit to try to reconnect the Bluetooth devices at regular intervals when it returns within base unit range. You can set the interval. The default setting is “**1 min**”.

Link to Cell

Important:

- When 3 Bluetooth devices (2 cellular phones and 1 headset) are paired to the base unit, only 2 Bluetooth devices can be used with the unit at the same time, and the base unit loses its connection from other Bluetooth devices. To automatically resume the connection to Bluetooth devices, leave the auto connection on.
- Some cellular phones lose connection after usage, please check the specifications of your cellular phone for more details.

1 **[MENU]** **#** **6** **3** **2**

2 **[↕]**: Select the desired setting.

3 **[SAVE]** → **[OFF]**

Note:

- Some cellular phones may ask you if you accept the connection requirement from the base unit. In that case, select “**oFf**” in step 2. Check the specifications of your cellular phone.

Connecting/disconnecting the cellular phone manually

If you will not be using the paired cellular phone's link to cell feature temporarily (for example, you do not want the unit to ring when your cellular line receives a call), you can disconnect your cellular phone from the base unit. If you want to use it again, reconnect the cellular phone to the base unit.

Note:

- Even if a paired cellular phone was disconnected from the base unit, if it is brought within the base unit's range during the auto connection interval, it may automatically connect to the base unit (page 19).
- A disconnected cellular phone is not unpaired from the base unit, so pairing it to the base unit again is unnecessary.

1 **To connect/disconnect:**

For CELL 1: **[MENU]** **#** **6** **2** **5** **1**

For CELL 2: **[MENU]** **#** **6** **2** **5** **2**

- A long beep sounds.

2 **[OFF]**

Cellular line only mode (If you do not use the landline)

If you do not use the landline, we recommend setting the unit to the cellular line only mode.

Important:

- If you turn on the “**Cell line only mode**”, disconnect the telephone line cord from the base unit. Otherwise the “**Cell line only mode**” cannot be activated.

1 **[MENU]** **#** **1** **5** **7**

2 **To turn on:**

[↕]: “**on**” → **[SELECT]** →

[↕]: “**Yes**” → **[SELECT]**

To turn off:

[↕]: “**oFf**” → **[SELECT]**

Note:

- Once you set this mode, you can use the following buttons to make cellular calls:
 - for the handset, press **[↶]** or **[↷]** instead of **[CELL]** (page 22).
 - for the base unit, press **[↶]** instead of the line button (**[CELL 1]** or **[CELL 2]**) set for the cellular line selection (page 21, 28). (KX-TGE270 series: page 3)
- Once you set this mode, the following features cannot be used:
 - Landline features (page 44)
 - Answering system (page 56)
Messages cannot be received.
 - Voice mail features (page 63)
- After this mode is turned on or off, the base unit reboots.
 - Bluetooth connections from cellular phones or headset are disconnected. If the auto connection is turned on (page 19), the cellular phones are reconnected.
 - **Y** will be displayed on the handset momentarily. The handset can be used once **Y** is displayed.

When you use the landline again

Before connecting the telephone line to the base unit, select “**oFf**” in step 2, “Cellular line

only mode (If you do not use the landline)", page 20.

Cellular line selection

This feature determines which cellular line is selected to make cellular calls when:

- you press **[CELL]** on the handset.
- you press **[↶]** or **[↷]** on the handset while the cellular line only mode is turned on.
- you press **[↷]** on the base unit while the cellular line only mode is turned on. (KX-TGE270 series: page 3)

The following settings are available:

- "**Manual**" (handset only: default): You can select the desired cellular line when making a call.
- "**Cellphone 1**"*1 (base unit default): CELL 1 is selected.
- "**Cellphone 2**"*1: CELL 2 is selected.

1 For handset: **[MENU]#634**
For base unit*2: **[MENU]#*634**

2 **[↕]**: Select the desired setting.

3 **[SAVE] → [OFF]**

*1 After the Bluetooth device is paired, the device name is displayed.

*2 KX-TGE270 series: page 3

Storing your area code (for dialing only a 7-digit phone number to make a local call)

You need to add your area code when making cellular calls to a phone number in your area.

Once you store your area code, it is automatically added to the beginning of the 7-digit phone number when making cellular calls.

1 **[MENU]#633**

2 Enter the 3-digit area code.
• To correct a digit, press **[CLEAR]**.

3 **[SAVE] → [OFF]**

Changing the Bluetooth PIN (Personal Identification Number)

The PIN is used to pair cellular phones to the base unit. The default PIN is "0000". To prevent unauthorized access to this product, we recommend that you change the PIN, and keep it confidential.

Important:

- Please make note of your new PIN. The unit does not reveal the PIN to you. If you forget your PIN, see page 75.

1 **[MENU]#619**

- If the unit prompts you to enter the old PIN (when the default has been changed), enter the current 4-digit PIN.

2 Enter the new 4-digit PIN. → **[OK]**

3 Enter the new 4-digit PIN again. → **[SAVE]**

4 **[OFF]**

Making/Answering Calls Using the Handset

Making cellular calls

Important:

- The unit can be used to talk on 2 lines at the same time (for example, 2 cellular lines, or the landline and 1 cellular line).
- Only 2 Bluetooth devices can be used with the unit at the same time (for example, 2 cellular lines, or the headset and 1 cellular line).
- Before making calls, confirm that the corresponding CELL indicator on the base unit lights up (page 15).

- 1 Lift the handset and dial the phone number.
 - To correct a digit, press [CLEAR].
- 2 [CELL]
 - The unit starts dialing when:
 - only 1 cellular phone is paired.
 - a specific line is set to make cellular calls (page 21).
 - Go to step 4.
- 3 [↕]: Select the desired cellular phone. → [SELECT]
- 4 When you finish talking, press [OFF] or place the handset on the base unit or charger.

Note:

- To switch to the speaker, press [🔊].
To switch back to the receiver, press [🔊]/ [🔊].

Adjusting the receiver or speaker volume

Press [+] or [-] repeatedly while talking.

Making a cellular call using the redial list

The last 5 phone numbers dialed are stored in the redial list (each 48 digits max.).

- 1 [▶] REDIAL
- 2 [↕]: Select the desired phone number.
- 3 [CELL]
 - The unit starts dialing when:
 - only 1 cellular phone is paired.

- a specific line is set to make cellular calls (page 21).

- 4 [↕]: Select the desired cellular phone. → [SELECT]

Erasing a number in the redial list

■ When a cellular phone is paired:

- 1 [▶] REDIAL
- 2 [↕]: Select the desired phone number. → [MENU]
- 3 [↕]: "Erase" → [SELECT]
- 4 [↕]: "Yes" → [SELECT]
- 5 [OFF]

■ When a cellular phone is not paired:

- 1 [▶] REDIAL
- 2 [↕]: Select the desired phone number. → [ERASE]
- 3 [↕]: "Yes" → [SELECT]
- 4 [OFF]

Making landline calls

- 1 Lift the handset and dial the phone number.
 - To correct a digit, press [CLEAR].
- 2 [🔊]
- 3 When you finish talking, press [OFF] or place the handset on the base unit or charger.

Using the speakerphone

- 1 Dial the phone number and press [🔊].
- 2 When you finish talking, press [OFF].

Note:

- To switch back to the receiver, press [🔊]/ [🔊].

Making a call using the redial list

The last 5 phone numbers dialed are stored in the redial list (each 48 digits max.).

- 1 [▶] REDIAL

Making/Answering Calls Using the Handset

- 2 **[↕]**: Select the desired phone number.
- 3 **[↶]**

Pause (for PBX/long distance service users)

A pause is sometimes required when making calls using a PBX or long distance service. When storing a calling card access number and/or PIN in the phonebook, a pause is also needed (page 35).

Example: If you need to dial the line access number "9" when making outside calls with a PBX:

- 1 **[9]** → **[▲]** (Pause)
- 2 Dial the phone number. → **[↶]**

Note:

- A 3.5 second pause is inserted each time **[▲]** (Pause) is pressed.

Answering calls

When a call is being received, the ringer indicator and **NR** indicator flash rapidly.

- 1 Lift the handset and press **[↶]** or **[↗]** when the unit rings.
 - To answer a cellular call, you can also press **[CELL]**.
- 2 When you finish talking, press **[OFF]** or place the handset on the base unit or charger.

Any key answer: You can answer the call by pressing any dial key.

Auto talk: You can answer calls simply by lifting the handset (page 43).

Temporary handset ringer off: You can turn the ringer off temporarily by pressing **[⌘]**.

Using the Smart function key

When the **NR** indicator flashes rapidly, press **[NR]**.

- You can answer the call even if the handset is placed on the base unit or charger (page 16).

You can finish talking by pressing **[OFF]** without lifting up the handset.

Adjusting the handset ringer volume

Press **[+]** or **[-]** repeatedly to select the desired volume while ringing.

Useful features during a call

Hold

- 1 Press **[MENU]** during an outside call.
- 2 **[↕]**: "Hold" → **[SELECT]**
- 3 **To release hold on the cellular line:**
Press **[CELL]**.^{*1}
 - Another handset user can take the call by pressing **[CELL]**.^{*1}
 - *1 If you press **[CELL]** and the selection list is displayed, select the desired cellular line and press **[SELECT]**.
 - The base unit user can take the call by pressing **[CELL 1]** or **[CELL 2]**. (KX-TGE270 series: page 3)**To release hold on the landline:**
Press **[↶]**.
 - Another handset user can take the call by pressing **[↶]**.
 - The base unit user can take the call by pressing **[↗]**. (KX-TGE270 series: page 3)

Note:

- After holding for 10 minutes, the call is disconnected.

Mute

- 1 Press **[MUTE]** during a call.
- 2 To return to the call, press **[MUTE]**.

Note:

- **[MUTE]** is a soft key visible on the display during a call.

Making/Answering Calls Using the Handset

Flash for landline calls

[FLASH] allows you to use the special features of your host PBX such as transferring an extension call, or accessing optional telephone services.

Note:

- To change the flash time, see page 43.

For call waiting or Call Waiting Caller ID service users

To use call waiting or Call Waiting Caller ID, you must first subscribe with your service provider/telephone company. This feature allows you to receive calls while you are already talking on the phone. If you receive a call while on the phone, you will hear a call waiting tone.

If you subscribe to both Caller ID and Call Waiting with Caller ID services, the 2nd caller's information is displayed after you hear the call waiting tone on the handset.

- 1 Press **[CALL WAIT]** to answer the 2nd call.
- 2 To switch between calls, press **[CALL WAIT]**.

Note:

- Please contact your service provider/telephone company for details and availability of this service in your area.

Temporary tone dialing for landline calls (for rotary/pulse service users)

Press **[TONE]** before entering access numbers which require tone dialing.

Handset clarity booster

This feature can improve sound clarity when the handset is used in an area where there may be interference. During an outside call, this feature is turned on automatically when necessary.

- When this feature is turned on, **[BOOST]** is displayed. However, during a cellular call,

[BOOST] is not displayed even though the feature is activated.

Handset noise reduction

This feature allows you to hear the voice of the person you are talking to clearly, by reducing the surrounding noise coming from the other party's telephone.

Press **[NR]** to turn on/off while talking.

Note:

- Depending on the environment where this handset is being used, this feature may not be effective.
- This feature is not available using the speakerphone.

Handset equalizer

This feature clarifies the voice of the person you are talking to, producing a more natural-sounding voice that is easier to hear and understand.

- 1 Press **[MENU]** while talking.
- 2 **[↕]**: "Equalizer" → **[SELECT]**
- 3 **[↕]**: Select the desired setting.
- 4 Press **[OK]** to exit.

Note:

- Depending on the condition and quality of your telephone line, this feature may emphasize existing line noise. If it becomes difficult to hear, turn this feature off.
- This feature is not available while using the speakerphone.
- When both the "Equalizer" setting and noise reduction are activated, **[NR]** is shown on the display.

Call share

You can join an existing outside call.

■ **While another unit is on a cellular call:**

- 1 To join the conversation, press **[CELL]**.
 - You can join the conversation when:
 - only 1 cellular phone is paired.

Making/Answering Calls Using the Handset

- a specific line is set to make cellular calls (page 21).

2 **[↕]**: Select the desired cellular phone.
→ **[SELECT]**

■ **While another unit is on a landline call:**

To join the conversation, press **[↩]**.

Note:

- A maximum of 3 parties (including 1 outside party) can join a conversation using 2 extensions. (**3-way conference**)
- To prevent other users from joining your conversations with outside callers, turn call sharing mode off (page 43).

Transferring calls, conference calls

Outside calls can be transferred or a conference call with an outside party can be made between 2 handsets.

- 1 During an outside call, press **[MENU]**.
- 2 **[↕]**: “Intercom” → **[SELECT]**
- 3 **[↕]**: Select the desired unit. → **[SELECT]**
- 4 Wait for the paged party to answer.
 - If the paged party does not answer, press **[↩]** to return to the outside call.

5 **To complete the transfer:**

Press **[OFF]**.

To establish a conference call:

[MENU] → **[↕]**: “Conference” → **[SELECT]**

- To leave the conference, press **[OFF]**.
The other 2 parties can continue the conversation.
- To put the outside call on hold:
[MENU] → **[↕]**: “Hold” → **[SELECT]**
To resume the conference: **[MENU]**
→ **[↕]**: “Conference” → **[SELECT]**
- To cancel the conference: **[MENU]** → **[↕]**: “Stop conference” → **[SELECT]**

You can continue the conversation with the outside caller.

Transferring a cellular call between the handset and a cellular phone

Transferring a cellular call from the handset to a cellular phone

- 1 Press **[MENU]** during a cellular call.
- 2 **[↕]**: “Transfer to cell” → **[SELECT]**
 - The cellular call is transferred to the cellular phone.

Note:

- Depending on your cellular phone type, you may need to set the cellular phone to be ready to talk before transferring. For example, if your cellular phone has a top cover, open it beforehand.

Transferring a cellular call from a cellular phone to the handset

During a conversation using a cellular phone, the call cannot be transferred to the handset by the cellular phone. Perform the following with the handset.

- 1 During a conversation using a cellular phone, press **[CELL]**.
 - The call is transferred to the handset when:
 - only 1 cellular phone is paired.
 - a specific line is set to make cellular calls (page 21).
- 2 **[↕]**: Select the desired cellular phone. → **[SELECT]**
 - The call is transferred to the handset.

Answering a 2nd call

If you receive a call while talking on the phone, the interrupt tone sounds (page 41) and the 2nd caller's information is displayed if you subscribe to Caller ID (page 49).

Answering a 2nd call during a landline call

- 1 Press **[MENU]** during a landline call.

Making/Answering Calls Using the Handset

- 2 **[↕]: “Hold” → [SELECT]**
- 3 **To answer the 2nd call:**
Press **[CELL]** while the 2nd call is being received.
- 4 To hang up the 2nd call and return to the 1st call (landline call), press **[OFF]**, then press **[↶]**.

Answering a 2nd call during a cellular call



- 1 Press **[MENU]** during a cellular call.
 - 2 **[↕]: “Hold” → [SELECT]**
 - 3 **To answer the 2nd call:**
Press **[↶]** or **[CELL]** while the 2nd call is being received.
 - 4 To hang up the 2nd call and return to the 1st call (cellular call), press **[OFF]**, then press **[CELL]***1.
- *1 If you press **[CELL]** and the selection list is displayed, select the desired cellular line and press **[SELECT]**.

Power back-up operation for landline

When a power failure occurs, the charged handset temporarily supplies power to the base unit (power back-up mode). This allows you to make and receive landline calls using a handset during a power failure. The base unit will not perform any other functions. However, some functions such as Caller ID and phonebook are available only when using a handset other than the handset supplying power to the base unit. You can program “Power failure” and the default setting is “Auto” (page 43).

Important:

- If a handset is not placed on the base unit when a power failure occurs, “**Base no power Press OFF**” is displayed. After pressing **[OFF]** on the handset, place it on the base unit to start power back-up mode.

- Power back-up mode will not work if the battery level of the power supplying handset is  or .
- Do not lift the power supplying handset from the base unit during power back-up mode.

Panasonic Ni-MH battery performance (supplied batteries) during power back-up mode

When the batteries are fully charged, operating time of the handset in power back-up mode varies depending on usage.

- Continuous use of the handset in power back-up mode: 1.5 hours max.
- Continuous use of the handset other than a handset in power back-up mode: 2 hours max.
- Not in use in power back-up mode: 2 hours max.

Making calls during a power failure

■ When only 1 handset is registered:

- 1 Lift the handset and dial the phone number.
- 2 Within 1 minute, place the handset on the base unit.
 - Wait until speakerphone is turned on automatically and the call is made.
- 3 When the other party answers the call, keep the handset on the base unit and talk using the speakerphone.
- 4 When you finish talking, press **[OFF]**.

■ **When 2 or more handsets are registered:**
You should leave one handset on the base unit for supplying the power, and use another handset for making calls.

Note:

- The range of the base unit is limited during a power failure. Please use the handset close to the base unit.

Making/Answering Calls Using the Handset

Making a call using the redial list

■ When only 1 handset is registered:

- 1 Lift the handset.
- 2 [**▶**] REDIAL
- 3 [**↕**]: Select the desired phone number.
- 4 Within 1 minute, place the handset on the base unit.
 - Wait until speakerphone is turned on automatically and the call is made.

■ When 2 or more handsets are registered:

You should leave one handset on the base unit for supplying the power, and use another handset for making calls.

Making a call using the phonebook

There must be at least 2 handsets registered to the base unit in order for the phonebook feature to be used during a power failure.

You should leave one handset on the base unit for supplying the power, and use another handset for making calls.

Answering calls during a power failure

■ When only 1 handset is registered:

- 1 When the unit rings, keep the handset on the base unit and press [**☎**] or [**☎**].
 - Speakerphone is turned on.
- 2 When you finish talking, press [**OFF**].

■ When 2 or more handsets are registered:

When the unit rings, use a handset which is not supplying power to the base unit.

- Do not use or lift the handset which is placed on the base unit during power back-up mode.

Note:

- The range of the base unit is limited during a power failure. Please use the handset close to the base unit.

Making/Answering Calls Using the Base Unit

Making cellular calls

Available for:
KX-TGE270 series (page 3)

- 1 Press **[CELL 1]** or **[CELL 2]**.
- 2 Dial the phone number.
- 3 When the other party answers, speak into the microphone.
- 4 When you finish talking, press **[⏏]**.

Note:

- For best performance, use the speakerphone in a quiet environment.
 - While on a call, you can switch from the base unit to the handset:
 - With the call sharing mode on (page 43), press **[CELL]***1 on the handset. → **[⬆]**: Select the desired cellular phone. → **[SELECT]** → Press **[⏏]** on the base unit.
 - If the handset is on the base unit, simply lift it.
- *1 The call is taken when:
 - only 1 cellular phone is paired.
 - a specific line is set to make cellular calls (page 21).

Adjusting the speaker volume

Press **[+]** or **[-]** repeatedly while talking.

Redialing the last number dialed

- 1 Press **[CELL 1]** or **[CELL 2]**.
- 2 **[REDIAL]**

Making landline calls

- 1 **[⏏]**
- 2 Dial the phone number.
- 3 When the other party answers, speak into the microphone.
- 4 When you finish talking, press **[⏏]**.

Note:

- While on a call, you can switch from the base unit to the handset:
 - Press **[📞]** on the handset, then press **[⏏]** on the base unit with the call sharing mode on (page 43).
 - If the handset is on the base unit, simply lift it.

Redialing the last number dialed

[⏏] → **[REDIAL]**

Pause (for PBX/long distance service users)

A pause is sometimes required when making calls using a PBX or long distance service. When storing a calling card access number and/or PIN in the phonebook, a pause is also needed (page 35).

Example: If you need to dial the line access number "9" when making outside calls with a PBX:

- 1 **[⏏]**
- 2 **[9]** → **[PAUSE]**
- 3 Dial the phone number.

Note:

- A 3.5 second pause is inserted each time **[PAUSE]** is pressed.

Answering calls

When a landline call is being received, the SP-PHONE indicator flashes rapidly. When a cellular call is being received, the CELL indicator and SP-PHONE indicator flash rapidly.

- 1 Press **[⏏]** when the unit rings.
 - You can also answer the cellular call by pressing **[CELL 1]** or **[CELL 2]**.
- 2 Speak into the microphone.
- 3 When you finish talking, press **[⏏]**.

Making/Answering Calls Using the Base Unit

Adjusting the base unit ringer volume

Press **[+]** or **[-]** repeatedly to select the desired volume while ringing.

- To turn the ringer off, press and hold **[-]** until the unit beeps.

Useful features during a call

Hold

- 1 Press **[HOLD]** during an outside call.
- 2 **To release hold on the cellular line:**
Press **[CELL 1]** or **[CELL 2]**.
 - A handset user can take the call:
[CELL]*1 → [SELECT]
*1 The call is taken when:
 - only 1 cellular phone is paired.
 - a specific line is set to make cellular calls (page 21).

To release hold on the landline:
Press **[MUTE]**.

- A handset user can take the call by pressing **[MUTE]**.

Note:

- While a landline call is on hold, the SP-PHONE indicator flashes.
- After holding for 10 minutes, the call is disconnected.

Mute

- 1 Press **[MUTE]** during a call.
 - The SP-PHONE indicator flashes.
- 2 To return to the call, press **[MUTE]**.

Flash for landline calls

[FLASH] allows you to use the special features of your host PBX such as transferring an extension call, or accessing optional telephone services.

Note:

- To change the flash time, see page 43.

For call waiting service users

To use call waiting, you must first subscribe with your service provider/telephone company. This feature allows you to receive calls while you are already talking on the phone. If you receive a call while on the phone, you will hear a call waiting tone.

- 1 Press **[CALL WAIT]** to answer the 2nd call.
- 2 To switch between calls, press **[CALL WAIT]**.

Note:

- Please contact your service provider/telephone company for details and availability of this service in your area.

Temporary tone dialing for landline calls (for rotary/pulse service users)

Press **[TONE]** (TONE) before entering access numbers which require tone dialing.

Call share

You can join an existing outside call.

To select the line that is being used for the call:

- for a cellular line press **[CELL 1]** or **[CELL 2]**.
- for the landline press **[MUTE]**.

Note:

- A maximum of 3 parties (including 1 outside party) can join a conversation using 2 extensions. **(3-way conference)**
- To prevent other users from joining your conversations with outside callers, turn call sharing mode off (page 43).

Transferring calls, conference calls

Outside calls can be transferred or a conference call with an outside party can be made between a handset and the base unit.

Making/Answering Calls Using the Base Unit

- 1 During an outside call, press **[INTERCOM]**.
When 2 or more handsets are registered:
 - To page a specific handset, enter the handset number.
 - To page all handsets, press **[0]** or wait for a few seconds.
- 2 Wait for the paged party to answer.
 - If paged party does not answer, press **[INTERCOM]** to return to the outside call.
- 3 **To complete the transfer:**
Press **[⇨]**.
 - The outside call is being routed to the handset.**To establish a conference call:**
Press **[CONF]**.
 - To leave the conference, press **[⇨]**. The other 2 parties can continue the conversation.
 - To put the outside call on hold, press **[HOLD]**. To resume the conference, press **[CONF]**.

Transferring a cellular call between the base unit and a cellular phone

Transferring a cellular call from the base unit to a cellular phone

During a cellular call, press and hold **[CELL 1]** or **[CELL 2]** until the SP-PHONE indicator goes out.

- The cellular call is transferred to the cellular phone.

Transferring a cellular call from a cellular phone to the base unit

During a conversation using a cellular phone, press **[CELL 1]** or **[CELL 2]**.

- The cellular call is transferred to the base unit.

Answering a 2nd call

If you receive a call while talking on the phone, the interrupt tone sounds (page 41).

Answering a 2nd call during a landline call

- 1 Press **[HOLD]** during a landline call.
- 2 **To answer the 2nd call:**
Press **[CELL 1]** or **[CELL 2]**.
- 3 To hang up the 2nd call and return to the 1st call (landline call), press **[⇨]** 2 times.

Answering a 2nd call during a cellular call

- 1 Press **[HOLD]** during a cellular call.
- 2 **To answer the 2nd call:**
[⇨], **[CELL 1]**, or **[CELL 2]**
- 3 To hang up the 2nd call and return to the 1st call (cellular call), press **[⇨]**, then press **[CELL 1]** or **[CELL 2]**.

Handset locator

You can locate a misplaced handset by paging it.

- 1 **Base unit:** Press **[LOCATOR]** or **[HANDSET LOCATOR]**.
 - All registered handsets beep for 1 minute.
- 2 To stop paging:

Base unit:
Press **[LOCATOR]** or **[HANDSET LOCATOR]**.

Handset:

 - **KX-TGE260 series: page 3**
Press **[OFF]**.
 - **KX-TGE270 series: page 3**
Press **[↶]**, then press **[OFF]**.

Using the Smart function key

You can also stop paging:

- KX-TGE260 series: press **[J/R]**.
- KX-TGE270 series: press **[J/R]**, then press **[OFF]**.

Cell locator

This feature allows you to locate a misplaced cellular phone by pressing the **[LOCATES CELL]** button on the base unit and calling your cellular phone. You must assign your cellular phone's phone number to the button beforehand. Only 1 cellular phone number (24 digits max.) can be assigned.

Adding a phone number

- 1 **[MENU]#248**
 - If you have already stored a cellular phone number, the current number is displayed.
- 2 Enter your cellular phone number. → **[SAVE] → [OFF]**

Erasing the number

- 1 **[MENU]#248**
- 2 Press and hold **[CLEAR]** until all digits are erased. → **[SAVE] → [OFF]**

Calling the misplaced cellular phone

Base unit: [LOCATES CELL]

- To stop calling:
 - KX-TGE260 series: press **[LOCATES CELL]** again.
 - KX-TGE270 series: press **[↶]**.

Important:

- While the base unit is calling the cellular phone, the outside line is used.
 - KX-TGE260 series: Even if the cellular phone answers, you cannot talk with the cellular phone. To end the call, press **[LOCATES CELL]** on the base unit.
 - KX-TGE270 series: When the cellular phone answers, you can talk with the cellular phone. To end the call, press **[↶]** on the base unit.
- Charges may be incurred if the cellular phone answers the call.

Intercom

Intercom calls can be made:

- between handsets
 - between a handset and the base unit*1
- *1 KX-TGE270 series: page 3

Note:

- When paging unit(s), the paged unit(s) beeps for 1 minute.
 - If you receive an outside call while talking on the intercom, the interrupt tone sounds (page 41).
 - To answer the call with the handset, press **[OFF]**, then press the corresponding line key.
 - To answer the call with the base unit, press **[↶]**, then press the corresponding line key.*1
- *1 KX-TGE270 series: page 3

Locator/Intercom

Making an intercom call

Handset

- 1 **[MENU]** → **[↕]**: "Intercom" → **[SELECT]**
- 2 **[↕]**: Select the desired unit. → **[SELECT]**
- 3 When you finish talking, press **[OFF]**.

Note:

- You can also use the **[INT]** soft key, if displayed, to make intercom calls.

Base unit*1

*1 KX-TGE270 series: page 3

- 1 Press **[INTERCOM]**.
When 2 or more handsets are registered:
 - To page a specific handset, enter the handset number.
 - To page all handsets, press **[0]** or wait for a few seconds.
 - To stop paging, press **[INTERCOM]**.
- 2 When you finish talking, press **[INTERCOM]**.

Answering an intercom call

Handset

- 1 Press **[↶]** to answer the page.
- 2 When you finish talking, press **[OFF]**.

Base unit*1

*1 KX-TGE270 series: page 3

- 1 Press **[INTERCOM]** to answer the page.
- 2 When you finish talking, press **[INTERCOM]**.

Using the Smart function key

Press **[NR]** to answer the page.

Phonebook

You can add 3,000 names (16 characters max.) and phone numbers (24 digits max.) to the phonebook, and assign each phonebook entry to the desired group (page 34). The following groups are available:

- Group 1: "Home"^{*1} (default)
- Group 2: "Cell 1"^{*1}
- Group 3: "Cell 2"^{*1}
- Group 4-9: You can change the group name for each group.

*1 For groups 1-3, the group names cannot be changed.

Important:

- All entries can be shared by any registered handset.
- You can copy phonebook entries from a Bluetooth cellular phone to the unit's phonebook (page 52).

Adding phonebook entries

- 1 [◀] □ □ → [MENU]
- 2 [↕]: "Add new entry" → [SELECT]
- 3 Enter the party's name. → [OK]
- 4 Enter the party's phone number. → [OK]
- 5 [↕]: Select the desired group. → [SELECT] 2 times
- 6 [OFF]

Storing a redial list number to the phonebook

Phone numbers of up to 24 digits can be stored in the phonebook.

■ When a cellular phone is paired:

- 1 [▶] REDIAL
- 2 [↕]: Select the desired phone number. → [MENU]
- 3 [↕]: "Save" → [SELECT]
- 4 To store the name, continue from step 3, "Editing entries", page 35.

■ When a cellular phone is not paired:

- 1 [▶] REDIAL
- 2 [↕]: Select the desired phone number. → [SAVE]
- 3 To store the name, continue from step 3, "Editing entries", page 35.

Storing caller information to the phonebook

■ When a cellular phone is paired:

- 1 [▼] CID
- 2 [↕]: Select the desired entry. → [SELECT]
 - To edit the number, press [✕] (Edit) repeatedly until the phone number is shown in the desired format.
- 3 [SAVE]
- 4 [↕]: "Phonebook" → [SELECT]
- 5 Continue from step 3, "Editing entries", page 35.

■ When a cellular phone is not paired:

- 1 [▼] CID
- 2 [↕]: Select the desired entry. → [MENU]
 - To edit the number: [↕]: "Edit" → [SELECT]

Press [EDIT] repeatedly until the phone number is shown in the desired format. And then, press [SAVE]. Go to step 4.
- 3 [↕]: "Save CID" → [SELECT]
- 4 [↕]: "Phonebook" → [SELECT]
- 5 Continue from step 3, "Editing entries", page 35.

Character table for entering names

While entering characters, you can switch between uppercase and lowercase by pressing [✕] (A→a).

Key	Character
[1]	& ' () * .
	- . / 1

Phonebook

Key	Character
[2]	A B C 2
	a b c 2
[3]	D E F 3
	d e f 3
[4]	G H I 4
	g h i 4
[5]	J K L 5
	j k l 5
[6]	M N O 6
	m n o 6
[7]	P Q R S 7
	p q r s 7
[8]	T U V 8
	t u v 8
[9]	W X Y Z 9
	w x y z 9
[0]	_ 0
[#]	#

- To enter another character that is located on the same dial key, first press [►] to move the cursor to the next space.
- If you do not press any dial key within 5 seconds after entering a character, the character is fixed and the cursor moves to the next space.
- _ in the above table represents a single space.

Erasing the character or number

Press [◀] or [►]. → [CLEAR]

- Press and hold [CLEAR] to erase all characters or numbers.

Groups

Groups can help you find entries in the phonebook quickly and easily. You can change the group name for groups 4-9 ("Friends", "Family", etc.). By assigning different ringer tones for different groups of callers, you can identify who is calling (ringer ID), if you have subscribed to Caller ID service.

Changing group names/setting ringer ID

- 1 [◀] □□ → [MENU]
- 2 [↕]: "Group" → [SELECT]
- 3 [↕]: Select the desired group. → [SELECT]
 - If you selected "Home", "Cell 1", or "Cell 2", go to step 5.
- 4 To change group names
[↕]: "Group name" → [SELECT] → Edit the name (10 characters max.) → [SAVE]
- 5 To set group ringer tone
[↕]: Select the current setting of the group ringer tone. → [SELECT] → [↕]: Select the desired ringer tone. → [SAVE]
- 6 [OFF]

Finding and calling from a phonebook entry

■ Using a cellular line:

- 1 [◀] □□
 - 2 To scroll through all entries
[↕]: Select the desired entry.
To search by first character
 - ① Press the dial key ([0] to [9], or [#]) which contains the character you are searching for (page 33).
 - ② [↕]: Scroll through the phonebook if necessary.
- To search by query**
You can narrow down the search to enter the first characters of a name.
- ① [X]
 - ② To search for the name, enter the first characters (up to 4) in uppercase (page 33).
 - ③ [OK]
 - ④ [↕]: Scroll through the phonebook if necessary.
- To search by group**
- ① [GROUP]
 - ② [↕]: Select the desired group. → [SELECT]
 - ③ [↕]: Scroll through the phonebook if necessary.

3 [CELL]

- The unit starts dialing when:
 - only 1 cellular phone is paired.
 - a specific line is set to make cellular calls (page 21).

4 [↕]: Select the desired cellular phone. → **[SELECT]**

■ **Using the landline:**

1 [←] □□

2 To scroll through all entries

[↕]: Select the desired entry.

To search by first character

- ① Press the dial key (0 to 9, or #) which contains the character you are searching for (page 33).
- ② **[↕]:** Scroll through the phonebook if necessary.

To search by query

You can narrow down the search to enter the first characters of a name.

- ① **[☒]**
- ② To search for the name, enter the first characters (up to 4) in uppercase (page 33).
- ③ **[OK]**
- ④ **[↕]:** Scroll through the phonebook if necessary.

To search by group

- ① **[GROUP]**
- ② **[↕]:** Select the desired group. → **[SELECT]**
- ③ **[↕]:** Scroll through the phonebook if necessary.

3 [↶]

Editing entries

- 1** Find the desired entry (page 34). → **[MENU]**
- 2** **[↕]:** “Edit” → **[SELECT]**
- 3** Edit the name if necessary. → **[OK]**
- 4** Edit the phone number if necessary. → **[OK]**
- 5** **[↕]:** Select the desired group (page 34). → **[SELECT]** 2 times
- 6** **[OFF]**

Erasing entries

Erasing an entry

- 1** Find the desired entry (page 34). → **[MENU]**
- 2** **[↕]:** “Erase” → **[SELECT]**
- 3** **[↕]:** “Yes” → **[SELECT]**
- 4** **[OFF]**

Erasing all entries

- 1** **[←] □□ → [MENU]**
- 2** **[↕]:** “Erase all” → **[SELECT]**
- 3** **[↕]:** Select the desired group. → **[SELECT]**
- 4** **[↕]:** “Yes” → **[SELECT]**
- 5** **[↕]:** “Yes” → **[SELECT]**
- 6** **[OFF]**

Chain dial

This feature allows you to dial phone numbers in the phonebook while you are on a call. This feature can be used, for example, to dial a calling card access number or bank account PIN that you have stored in the phonebook, without having to dial manually.

- 1** During an outside call, press **[MENU]**.
- 2** **[↕]:** “Phonebook” → **[SELECT]**
- 3** **[↕]:** Select the desired entry.
- 4** Press **[CALL]** to dial the number.

Note:

- When storing a calling card access number and your PIN in the phonebook as one phonebook entry, press **[▲]** (Pause) to add pauses after the number and PIN as necessary (page 23).
- If you have rotary/pulse service, you need to press **[☒]** (TONE) before pressing **[MENU]** in step 1 to change the dialing mode temporarily to tone. When adding entries to the phonebook, we recommend adding **[☒]** (TONE) to the beginning of

Phonebook

phone numbers you wish to chain dial (page 33).

Speed dial

You can assign 1 phone number to each of the dial keys ([1] to [9]) on the handset.

Adding phone numbers to speed dial keys

■ By entering phone numbers:

- 1 Press and hold the desired speed dial key ([1] to [9]). → **[ADD]**
- 2 [↕]: "Manual" → **[SELECT]**
- 3 Enter the party's name (16 characters max.). → **[OK]**
- 4 Enter the party's phone number (24 digits max.). → **[OK]**
- 5 **[SELECT]** → **[OFF]**

■ From the phonebook:

- 1 Press and hold the desired speed dial key ([1] to [9]). → **[ADD]**
- 2 [↕]: "Phonebook" → **[SELECT]**
- 3 [↕]: Select the desired entry.
- 4 **[SAVE]** → **[OFF]**

Note:

- If you edit a phonebook entry which is assigned to a speed dial key, the edited entry does not transfer to the speed dial key.

Editing an entry

- 1 Press and hold the desired speed dial key ([1] to [9]). → **[MENU]**
- 2 [↕]: "Edit" → **[SELECT]**
- 3 Edit the name if necessary. → **[OK]**
- 4 Edit the phone number if necessary. → **[OK]**
- 5 **[SELECT]** → **[OFF]**

Erasing an entry

- 1 Press and hold the desired speed dial key ([1] to [9]). → **[MENU]**
- 2 [↕]: "Erase" → **[SELECT]**
- 3 [↕]: "Yes" → **[SELECT]** → **[OFF]**

Viewing an entry/Making a call

■ Using a cellular line:

- 1 Press and hold the desired speed dial key ([1] to [9]).
- 2 **[CELL]**
 - The unit starts dialing when:
 - only 1 cellular phone is paired.
 - a specific line is set to make cellular calls (page 21).
- 3 [↕]: Select the desired cellular phone. → **[SELECT]**

■ Using the landline:

- 1 Press and hold the desired speed dial key ([1] to [9]).
- 2 **[☎]**

Menu list

To access the features, there are 2 methods.

■ Scrolling through the display menus

- 1 [MENU]
- 2 Press [▼] or [▲] to select the desired main menu. → [SELECT]
- 3 Press [▼] or [▲] to select the desired item from the next sub-menus. → [SELECT]
- 4 Press [▼] or [▲] to select the desired setting. → [SAVE]

■ Using the direct command code

- 1 [MENU] → Enter the desired code.
Example: Press [MENU]#[1][0][1].
- 2 Select the desired setting. → [SAVE]

Note:

- To exit the operation, press [OFF].
- In the following table, < > indicates the default settings.
- In the following table,  indicates the reference page number.
- Display menu order and sub-menu may vary depending on your model.

Display menu tree and direct command code table

Main menu:  "Phonebook"

Operation	Code	
Viewing the phonebook entry.	#280	34

Main menu: →) "Caller list"

Operation	Code	
Viewing the caller list.	#213	49

Main menu:  "Answering device"

Sub-menu 1	Sub-menu 2	Settings	Code	
Play new message	–	–	#323	57
Play all message	–	–	#324	57
Erase all message*1	–	–	#325	58
Greeting	Record greeting*1	–	#302	56
	Check greeting	–	#303	57
	Pre-recorded*1 (Reset to pre-recorded greeting)	–	#304	57

Programming

Sub-menu 1	Sub-menu 2	Settings	Code	
New message alert ^{*1}	Outgoing call – On/Off	On <Off>	#338	58
	Outgoing call – Notification to	–		
	Outgoing call – Remote code	Activate <Inactivate>		
	Base unit beep	On <Off>	#339	58
Settings	Ring count ^{*1}	2-7 rings <4 rings> Toll saver	#211	61
	Recording time ^{*1}	1 min <3 min> Greeting only ^{*2}	#305	61
	Remote code ^{*1}	<111>	#306	60
	Screen call – Handset	<On> Off	#310	61
	Screen call – Base unit ^{*1, *3}	<On> Off	#*310	61
Answer on ^{*1}	–	–	#327	56
Answer off ^{*1}	–	–	#328	56

Main menu:  "Voice Mail access"^{*4}

Operation	Code	
Listening to voice mail messages.	#330	64

Main menu:  "Intercom"^{*}

Operation	Code	
Paging the desired unit.	#274	32

Programming

Main menu:  "Bluetooth"

Sub-menu 1	Sub-menu 2	Settings	Code	
Link to cell – 1: Add new device ^{*5} (for CELL 1) – 2: Add new device ^{*5} (for CELL 2)	Connect ^{*1} / Disconnect ^{*1}	–	#6251 ^{*6}	20
			#6252 ^{*7}	
	Ringer volume – Handset	Off-6 <6>	#6281 ^{*6}	23
			#6282 ^{*7}	
	Ringer volume – Base unit ^{*1}	Off-6 <1>	#*6281 ^{*6}	29
			#*6282 ^{*7}	
	Ringer tone ^{*8}	<Tone 2> ^{*6} <Tone 4> ^{*7}	#6291 ^{*6}	–
			#6292 ^{*7}	
	Select unit to ring ^{*1}	Handset 1-6 <All>	#6271 ^{*6}	19
			#6272 ^{*7}	
	Ring as cell (limited) ^{*1}	<On (with Talking CID)> On (without Talking CID) Off	#6141 ^{*6}	19
			#6142 ^{*7}	
Text message alert – On/Off ^{*1}	<On (no announce)> On (with name) Off	#6101 ^{*6}	53	
		#6102 ^{*7}		
Text message alert – Alert tone ^{*9}	<Tone 1> ^{*6} <Tone 2> ^{*7}	#6101 ^{*6}	53	
		#6102 ^{*7}		
Pair	–	#6241 ^{*6}	18	
		#6242 ^{*7}		
Unpair	–	#6111 ^{*6}	18	
		#6112 ^{*7}		
Phonebook transfer	–	–	#618	52
Headset	Add new device ^{*5}	–	#621	54
	Connect ^{*1} / Disconnect ^{*1}	–	#622	54
	Pair	–	#621	54
	Unpair	–	#612	54

For assistance, please visit <http://www.panasonic.com/help>

39

Programming

Sub-menu 1	Sub-menu 2	Settings	Code	
Settings	Auto connect* ¹	<1 min> 3 min 5 min 10 min Off	#632	19
	Cell area code* ¹	-	#633	21
	Cell line only mode* ¹	On <Off>	#157	20
	Cell line select - Handset	Cellphone 1* ⁵ Cellphone 2* ⁵ <Manual>	#634	21
	Cell line select - Base unit* ^{1, *3}	<Cellphone 1>* ⁵ Cellphone 2* ⁵	#*634	
	Set PIN* ¹	<0000>	#619	21
	International code* ¹	-	#117	52
	Country code* ¹	-	#118	
Trunk prefix* ¹	-	#119		

Main menu:  "Set date & time"

Sub-menu 1	Sub-menu 2	Settings	Code	
Date and time* ¹	-	-	#101	16
Memo alarm	Alarm1-3	Once Daily Weekly <Off>	#720	44
Time adjustment* ^{1, *10}	-	<Caller ID auto> Manual	#226	-

Main menu:  "Speed dial"

Operation	Code	
Viewing the speed dial entry.	#261	36

Programming

Main menu:  "Settings"

Sub-menu 1	Sub-menu 2	Settings	Code		
Ring adjustments	Ringer volume – Handset ^{*4}	Off-6 <6>	#160	–	
	Ringer volume – Base unit ^{*1, *4}	Off-6 <1>	#*160	–	
	Ringer tone ^{*4, *8, *11} (Handset)	<Tone 1>	#161	–	
	Interrupt tone – Handset ^{*12}	<On> Off	#201	25	
	Interrupt tone – Base unit ^{*1, *3, *12}	<On> Off	#*201	30	
	Silent mode – Handset	On/Off – On – <Off>		#238	45
		Start/End – <11:00 PM/ 06:00 AM>		#237	45
		Select group		#241	45
	Silent mode – Base unit ^{*1, *3}	On/Off – On – <Off>		#*238	45
		Start/End – <11:00 PM/ 06:00 AM>		#*237	45
Select group			#*241	45	
Set date & time	Date and time ^{*1}	–	#101	16	
	Memo alarm – Alarm1-3	Once Daily Weekly <Off>	#720	44	
	Time adjustment ^{*1, *10}	<Caller ID auto> Manual	#226	–	
Talking Caller ID	Handset	<On> Off	#162	49	
	Base unit ^{*1}	On <Off>	#*162		

Programming

Sub-menu 1	Sub-menu 2	Settings	Code		
Key detector setting* ¹³ - 1: Add new device (for Detector1)* ¹⁴ - 2: Add new device (for Detector2) - 3: Add new device (for Detector3) - 4: Add new device (for Detector4)	Change name* ¹	Detector1	#6561	-	
		Detector2* ¹⁵	#6562* ¹⁶		
		Detector3* ¹⁵	#6563* ¹⁶		
		Detector4* ¹⁵	#6564* ¹⁶		
	Registration	-		#6571	-
				#6572* ¹⁶	
				#6573* ¹⁶	
				#6574* ¹⁶	
	Deregistration	-		#6581	-
				#6582* ¹⁶	
				#6583* ¹⁶	
				#6584* ¹⁶	
Call block* ¹	Block a single number	-	#217	46	
	Block range of numbers	-			
	Block unknown CID (CID: Caller ID)	On <Off>	#240	47	
	First ring	<On> Off	#173	47	
Speed dial	-	-	#261	36	
Cell locator	-	-	#248	31	
Record greeting* ¹	-	-	#302	56	
Voice mail* ⁴	Save VM access#* ¹ (VM: Voice mail)	-	#331	63	
	VM tone detect* ¹	<On> Off	#332	63	
LCD contrast (Display contrast)	-	Level 1-4 <2>	#145	-	
Handset name	-	-	#104	47	
Display name	-	On <Off>	#105	47	
Smart function key	-	-	#278	17	
Key tone	-	<On> Off	#165	-	

Programming

Sub-menu 1	Sub-menu 2	Settings	Code	
Caller ID edit (Caller ID number auto edit)	–	<On> Off	#214	50
Auto talk ^{*17}	–	On <Off>	#200	23
Set tel line ^{*4}	Set dial mode ^{*1}	Pulse <Tone>	#120	17
	Set flash time ^{*1, *18}	900 ms <700 ms> 600 ms 400 ms 300 ms 250 ms 200 ms 160 ms 110 ms 100 ms 90 ms 80 ms	#121	24
	Set line mode ^{*1, *19}	A 	#122	–
Call sharing ^{*1}	–	<On> Off	#194	24, 29
Registration	Register handset	–	#130	48
	Deregistration ^{*2}	–	#131	48
Power failure	–	<Auto> Off	#152	26
Change language	Display	<English> Español	#110	16
	Voice prompt ^{*1}	<English> Español	#112	16

Main menu:  “Customer support”

Operation	Code	
Displaying customer support Web address.	#680	–

Main menu:  “Key detector”^{*13}

Sub-menu 1	Sub-menu 2	Settings	Code	
Search	–	–	#655	–
Battery check	–	–		

*1 If you program these settings using one of the units, you do not need to program the same item using another unit.

Programming

- *2 This menu is not displayed when scrolling through the display menus. It is only available in direct command code.
- *3 KX-TGE270 series: page 3
- *4 When the cellular line only mode is turned on, these menus are not displayed (page 20).
- *5 After the Bluetooth device is paired, the device name is displayed.
- *6 For CELL 1
- *7 For CELL 2
- *8 The preset melodies in this product are used with permission of © 2012 Copyrights Vision Inc.
- *9 The preset melodies in this product are used with the following permission:
 - “Tone 1” and “Tone 2”: © 2013 Copyrights Vision Inc.
 - “Tone 3” - “Melody 10”: © 2012 Copyrights Vision Inc.
- *10 This feature allows the unit to automatically adjust the date and time each time caller information including date and time is received.

To turn this feature on, select “**Caller ID auto**”. To turn this feature off, select “**Manual**”. (Caller ID subscribers only)

To use this feature, set the date and time first (page 16).
- *11 If you subscribe to a distinctive ring service (such as IDENT-A-RING), select a tone (tone 1 or 2). If you select a melody, you cannot distinguish lines by their ringers.
- *12 This tone lets you know when you receive an outside call while you are on another line or an intercom call. If you select “**On**”, the tone sounds 2 times.
- *13 This setting is available when you have the key detector (KX-TGA20). Read the installation manual for more information on the key detector.
- *14 For models with supplied key detectors, the display shows “**1: Detector1**”.
- *15 If you register 2 or more key detectors.
- *16 If you have 2 or more key detectors.
- *17 If you subscribe to a Caller ID service and want to view the caller’s information after lifting up the handset to answer a call, turn off this feature.
- *18 The flash time depends on your telephone exchange or host PBX. Contact your PBX supplier if necessary. The setting should stay at “**700 ms**” unless pressing [**FLASH**] fails to pick up the waiting call.
- *19 Generally, the line mode setting should not be changed. This setting automatically maintains receiver volume at the proper level depending on the current telephone line condition. Set the line mode to “**A**” if telephone line condition is not good.

Alarm

An alarm sounds at the set time for 1 minute and is repeated 5 times at 5 minute intervals (snooze function). A text memo can also be displayed for the alarm. A total of 3 separate alarm times can be programmed for each handset. You can set one of 3 different alarm options (once, daily, or weekly) for each alarm time.

Important:

- Make sure the unit’s date and time setting is correct (page 16).

- 1 [**MENU**]# [7] [2] [0]
- 2 Select an alarm by pressing [1] to [3]. → [**SELECT**]
- 3 [**↕**]: Select the desired alarm option. → [**SELECT**]

“ Off ” Turns alarm off. Go to step 10.
“ Once ” An alarm sounds once at the set time.
“ Daily ” An alarm sounds daily at the set time. Go to step 5.

“weekly”
Alarm sounds weekly at the set time(s).

- 4 Proceed with the operation according to your selection in step 3.
 - **Once:**
Enter the desired month and date. → **[OK]**
 - **Weekly:**
[↕]: Select the desired day of the week and press **[SELECT]**. → **[OK]**
- 5 Set the desired time.
- 6 **[X]**: Select “AM” or “PM”. → **[OK]**
- 7 Enter a text memo (10 characters max.). → **[OK]**
- 8 **[↕]**: Select the desired alarm tone. → **[SELECT]**
 - We recommend selecting a different ringer tone from the one used for outside calls.
- 9 **[↕]**: Select the desired snooze setting. → **[SAVE]**
- 10 **[SELECT]** → **[OFF]**

Note:

- Press **[STOP]** to stop the alarm completely.
- When the handset is in use, the alarm will not sound until the handset is in standby mode.
- Press any dial key, **[NR]**, or **[SNOOZE]** to stop the sound but keep the snooze function activated.
- If you want to make an outside call when the snooze function is activated, please stop the snooze function before making the call.

Silent mode

Silent mode allows you to select a period of time during which the handset and/or base unit will not ring for outside calls. This feature is useful for time periods when you do not want to be disturbed, for example, while sleeping. Silent mode can be set for each unit. Using the phonebook’s group feature (page 34), you can also select groups of

callers whose calls override silent mode and ring the handset (Caller ID subscribers only).

Important:

- Make sure the unit’s date and time setting is correct (page 16).
- We recommend turning the base unit ringer off (page 39, 41) in addition to turning the silent mode on. (KX-TGE260 series: page 3)
- If you have set the alarm, the alarm sounds even if the silent mode is turned on.

Turning silent mode on/off

- 1 **For handset setting: [MENU]#238**
For base unit setting (using a handset)*1: [MENU]#X238
 - 2 **[↕]**: Select the desired setting. → **[SAVE]**
 - If you select “OFF”, press **[OFF]** to exit.
 - 3 Enter the desired hour and minute you wish to start this feature.
 - 4 **[X]**: Select “AM” or “PM”. → **[OK]**
 - 5 Enter the desired hour and minute you wish to end this feature.
 - 6 **[X]**: Select “AM” or “PM”.
 - 7 **[SAVE]** → **[OFF]**
- *1 KX-TGE270 series: page 3

Changing the start and end time

- 1 **For handset setting: [MENU]#237**
For base unit setting (using a handset)*1: [MENU]#X237
 - 2 Continue from step 3, “Turning silent mode on/off”, page 45.
- *1 KX-TGE270 series: page 3

Selecting groups to bypass silent mode

- 1 **For handset setting: [MENU]#241**
For base unit setting (using a handset)*1: [MENU]#X241
- 2 Select your desired groups by pressing **1** to **9**.
 - “✓” is displayed next to the selected group numbers.

Programming

- To cancel a selected group, press the same dial key again. “✓” disappears.

3 [SAVE] → [OFF]

*1 KX-TGE270 series: page 3

Call block

This feature rejects calls from unwanted callers (Caller ID subscribers only). The following items are available when storing phone numbers in the call block list (250 max.).

- “**Block a single number**”: The unit can reject calls from specific phone numbers.
- “**Block range of numbers**”: The unit can reject calls that begin with a number stored in the call block list, such as a toll-free phone number prefix or certain area codes.

You can also set the unit to reject calls that do not have a phone number.

When a call is received, the unit rings briefly*1 while caller information is being received. If the caller's phone number matches an entry in the call block list, the unit emits no sound to the caller, and disconnects the call.

*1 This is called first ring. If you do not want the first ring to sound, turn this setting to “**Off**” (page 47).

Important:

- Rejected calls are logged in the caller list.

Storing unwanted callers

Storing a single phone number

Important:

- We recommend storing 10 digits (including the area code). If only 7 digits are stored, all numbers that have the same last 7 digits will be blocked.

■ From the caller list:

When a cellular phone is paired:

1 [v] CID

2 [↕]: Select the entry to be blocked. → [SELECT]

- To edit the number, press [F] (Edit) repeatedly until the phone number is shown in the 10-digit format.

3 [SAVE]

4 [↕]: “Call block” → [SELECT]

5 [↕]: “Yes” → [SELECT]

6 Edit the phone number if necessary (24 digits max.).

7 [SAVE] → [OFF]

When a cellular phone is not paired:

1 [v] CID

2 [↕]: Select the entry to be blocked. → [MENU]

- To edit the number: [↕]: “Edit” → [SELECT]
Press [EDIT] repeatedly until the phone number is shown in the 10-digit format. And then, press [SAVE]. Go to step 4.

3 [↕]: “save CID” → [SELECT]

4 [↕]: “Call block” → [SELECT]

5 [↕]: “Yes” → [SELECT]

6 Edit the phone number if necessary (24 digits max.).

7 [SAVE] → [OFF]

■ By entering phone numbers:

1 [MENU][#][2][1][7]

2 [↕]: “Block a single number” → [SELECT]

3 [MENU] → [↕]: “Add” → [SELECT]

4 Enter the phone number (24 digits max.).
• To erase a digit, press [CLEAR].

5 [SAVE] → [OFF]

Storing a range of numbers

1 [MENU][#][2][1][7]

2 [↕]: “Block range of numbers” → [SELECT]

3 [MENU] → [↕]: “Add” → [SELECT]

- 4 Enter the desired number (2-8 digits).
 - To erase a digit, press **[CLEAR]**.
- 5 **[SAVE]** → **[OFF]**

Blocking incoming calls that have no phone number

You can reject calls when no phone number is provided, such as private callers or out of area calls.

- 1 **[MENU]** **#** **2** **4** **0**
- 2 **[↓]**: Select the desired setting. → **[SAVE]** → **[OFF]**

Note:

- When the unit receives a cellular call without a phone number, the call may not be rejected.

Setting the first ring for the call block list

If you do not want the first ring from a number on the call block list to sound, turn the first ring setting to "off". The default setting is "on".

- 1 **[MENU]** **#** **1** **7** **3**
- 2 **[↓]**: Select the desired setting. → **[SAVE]** → **[OFF]**

Viewing/editing/erasing call block numbers

- 1 **[MENU]** **#** **2** **1** **7**
- 2 **[↓]**: "Block a single number" or "Block range of numbers" → **[SELECT]**
- 3 **[↓]**: Select the desired entry.
 - To exit, press **[OFF]**.
- 4 To edit a number:
[EDIT] → Edit the number. → **[SAVE]** → **[OFF]**
 To erase a number:
[ERASE] → **[↓]**: "Yes" → **[SELECT]** → **[OFF]**

Note:

- When editing, press the desired dial key to add, **[CLEAR]** to erase.

Erasing all call block numbers

- 1 **[MENU]** **#** **2** **1** **7**
- 2 **[↓]**: "Block a single number" or "Block range of numbers" → **[SELECT]**
- 3 **[MENU]** → **[↓]**: "Erase all" → **[SELECT]**
- 4 **[↓]**: "Yes" → **[SELECT]**
- 5 **[↓]**: "Yes" → **[SELECT]** → **[OFF]**

Other programming

Changing the handset name

The default handset name is "Handset 1" to "Handset 6". You can customize the name of each handset ("Bob", "Kitchen", etc.). This is useful when you make intercom calls between handsets. To display the handset name in standby mode, turn on the handset name display feature (page 47).

- 1 **[MENU]** **#** **1** **0** **4**
- 2 Enter the desired name (10 characters max.).
- 3 **[SAVE]** → **[OFF]**

Displaying the handset name

You can select whether or not the handset name is displayed in standby mode. The default setting is "off".

- 1 **[MENU]** **#** **1** **0** **5**
- 2 **[↓]**: Select the desired setting. → **[SAVE]** → **[OFF]**

Programming

Registering a unit

Operating additional units

Additional handsets

Up to 6 handsets can be registered to the base unit.

Important:

- See page 5 for information on the available model.

Registering a handset to the base unit

The supplied handset and base unit are pre-registered. If for some reason the handset is not registered to the base unit, re-register the handset.

- 1 Handset:**
[MENU] [#] 1 3 0
- 2 Base unit:**
Press and hold [LOCATOR] or [HANDSET LOCATOR] for about 5 seconds.
 - If all registered handsets start ringing, press [LOCATOR] or [HANDSET LOCATOR] again to stop, then repeat this step.
- 3 Handset:**
Press [OK], then wait until a long beep sounds.

Deregistering a handset

A handset can cancel its own registration to the base unit, or other handsets registered to the same base unit. This allows the handset to end its wireless connection with the system.

- 1 [MENU] [#] 1 3 1**
 - All handsets registered to the base unit are displayed.
- 2 [↕]:** Select the handset you want to cancel. → [SELECT]
- 3 [↕]:** "Yes" → [SELECT] → [OFF]

Using Caller ID service

Important:

- This unit is Caller ID compatible. To use Caller ID features, you must subscribe to Caller ID service. Contact your service provider/telephone company for details.

Caller ID features

When an outside call is being received, the caller information is displayed.

Caller information for the last 50 callers is logged in the caller list from the most recent call to the oldest.

- If the unit cannot receive caller information, the following is displayed:
 - “**Out of area**”: The caller dials from an area which does not provide a Caller ID service.
 - “**Private caller**”: The caller requests not to send caller information.
 - “**Long distance**”: The caller makes a long distance call.
- If the unit is connected to a PBX system, caller information may not be properly received. Contact your PBX supplier.

Missed calls

If a call is not answered, the unit treats it as a missed call. The display shows “**Missed call**”.

Note:

- Even when there are unviewed missed calls, “**Missed call**” disappears from the standby display if the following operation is performed by one of the units:
 - A handset is replaced on the base unit or charger.
 - Pressing **[OFF]** on a handset.

Phonebook name display

When caller information is received and it matches a phone number stored in the phonebook, the stored name in the phonebook is displayed and logged in the caller list.

Talking Caller ID

Handset / Base unit

This feature lets you know who is calling without looking at the display.

To use this feature, you must:

- subscribe to a Caller ID service of your service provider/telephone company.
- turn this feature on (page 41).

When caller information is received, the handsets and/or base unit announce the caller’s name or phone number received from your service provider/telephone company following every ring.

The unit announces in English only.

- Name pronunciation may vary. This feature may not pronounce all names correctly.
- Caller ID service has a limit of how many characters can be displayed. If the caller’s name is too long, the unit may not be able to display or announce the entire name.

Phonebook name announcement

When caller information is received and it matches a phone number stored in the phonebook, the stored name in the phonebook is announced.

Caller list

Important:

- Make sure the unit’s date and time setting is correct (page 16).

Viewing the caller list and calling back

■ Using a cellular line

- 1 **[▼]** CID
- 2 Press **[▼]** to search from the most recent call, or **[▲]** to search from the oldest call.
- 3 To call back, press **[SELECT]**. To exit, press **[OFF]**.
- 4 **[CELL]**
 - The unit starts dialing when:
 - only 1 cellular phone is paired.

Caller ID Service

- a specific line is set to make cellular calls (page 21).

5 [\uparrow]: Select the desired cellular phone. →
[SELECT]

■ Using the landline

- 1** [∇] CID
- 2** Press [∇] to search from the most recent call, or [\blacktriangle] to search from the oldest call.
- 3** To call back, press [\curvearrowright].
To exit, press [OFF].

Note:

- If the entry has already been viewed or answered, “✓” is displayed.
- \square or \square indicates the caller information was received from the cellular line.

Using the Smart function key

When “Missed call” is displayed and the \mathcal{NR} indicator flashes slowly, there are missed calls.

Press [\mathcal{NR}] in step 1 on “Viewing the caller list and calling back”, page 49.

- “Missed Call” must be set to “On” in “Setting the Smart function key”, page 17.
- If the handset is placed on the base unit or charger, you need to lift up the handset to view the caller list after pressing [\mathcal{NR}].
- When the unit has new messages, new voice mail messages, and missed calls, the unit can be operated to play the new messages first, play the new voice mail messages next, and then show the missed calls.

Editing a caller's phone number

You can edit a phone number in the caller list by removing its area code and/or the long distance code “1”.

■ When a cellular phone is paired:

- 1** [∇] CID
- 2** [\uparrow]: Select the desired entry. →
[SELECT]
- 3** Press \square (Edit) repeatedly until the phone number is shown in the desired format.

4 Using a cellular line:

To make a cellular call, continue from step 4, “Viewing the caller list and calling back”, page 49.

Using the landline:

[\curvearrowright]

■ When a cellular phone is not paired:

- 1** [∇] CID
- 2** [\uparrow]: Select the desired entry. →
[MENU]
- 3** [\uparrow]: “Edit” → [SELECT]
- 4** Press [EDIT] repeatedly until the phone number is shown in the desired format.
- 5** [\curvearrowright]

Caller ID number auto edit feature

Once you call back an edited number, the unit which was used to call back remembers the area code and format of the edited number. The next time someone calls from the same area code, caller information is customized by the unit as follows:

- When the call is being received, the Caller ID number is displayed in the same format as the edited number.
- After the call has ended, the caller's phone number is displayed in the same format as the edited number, when reviewed from the caller list.

For example, you can use this feature to set the unit to ignore the area code of callers in your area, so that you can call these local numbers using caller information without dialing the area code.

To activate this feature, you must edit an entry in the caller list, then call that number. After that, phone numbers from that caller's area code are edited automatically.

This feature can be set for each unit (page 43). The default setting is “On”.

Note:

- Phone numbers from the 4 most recently edited area codes are automatically edited.

Erasing selected caller information

- 1 [▼] CID
- 2 [↕]: Select the desired entry.
- 3 [ERASE] → [↕]: "Yes" → [SELECT]
- 4 [OFF]

Erasing all caller information

- 1 [▼] CID
- 2 [ERASE] → [↕]: "Yes" → [SELECT]
- 3 [OFF]

Using Bluetooth Devices

Copying phonebook from a cellular phone (phonebook transfer)

You can copy phonebook entries from the paired cellular phones or other cellular phones (not paired) to the unit's phonebook. A cellular phone must be compatible with Bluetooth wireless technology.

Important:

- Your cellular phone must support Phone Book Access Profile (PBAP) or Object Push Profile (OPP) specification.
- If a copied entry has 2 or more phone numbers, each phone number (6 max.) is stored as a separate entry with the same name.
- If a phonebook entry includes additional data such as a picture, that entry may fail to copy to the base unit.
- If your cellular phone includes international call entries, set the conversion codes before copying (page 52).

1 Handset:

[MENU] **#** **6** **1** **8**

2 Handset:

To copy from paired cellular phones:
[↕]: Select the desired cellular phone. → **[SELECT]**

- Copied items are stored to the group ("Cell 1" or "Cell 2") which the cellular phone is paired to.

To copy from other cellular phones (not paired):
[↕]: "Other cell" → **[SELECT]** → **[↕]**: Select the group you want to copy to. → **[SELECT]**

3 When "Use the cell to transfer phone book" is displayed: Go to step 4.

When "Select mode" menu is displayed:
[↕]: Select "Auto" or "Manual". → **[SELECT]**
"Auto": Download all entries from the cellular phone automatically. Go to step 5.
"Manual": Copy entries you selected.

- "Select mode" menu is displayed only when the cellular phone supports PBAP (Phone Book Access Profile) for Bluetooth connection.
- Some cellular phones may require you to perform an operation on the cellular phone even if you select "Auto".

4 Cellular phone:

Follow the instructions of your cellular phone to copy phonebook entries.

- For other cellular phones (not paired), you need to search for and select the base unit. The Bluetooth PIN (default: "0000") may be required. If your cellular phone shows PassKey confirmation on its display, follow the directions to proceed.
- The entries being copied are displayed on the handset.

5 Handset:

Wait until "Completed" is displayed.

- You can continue copying other entries if necessary.

6 Handset: [OFF]

Note:

- Some copied entries may have characters which do not exist in the character table (page 33). These characters can be displayed but cannot be entered when editing an entry.
- The unit does not support some characters. If a copied entry includes those characters, they are replaced with other available characters or "*".
- If you receive a call while copying phonebook entries, the copying procedure stops. Try again after finishing the call.

Setting conversion codes

You must first set the following 3 dialing codes before transferring the phonebook from your cellular phone (each 4 digits max.).

- "International code": An international prefix used when you make an international call.
- "Country code": Your country code for international calls.

- “**Trunk prefix**”: A trunk prefix; the initial digit(s) to be dialed in a domestic call, prior to the area code.

- 1 **[MENU]**
- 2 To store “**International code**”:
#117
To store “**Country code**”: #118
To store “**Trunk prefix**”: #119
- 3 Enter the desired number. → **[SAVE]**
- 4 **[OFF]**

Note:

- After you copy the entries, confirm that the numbers were transferred correctly.

Text message (SMS) alert

The handset can notify you when a cellular phone that is paired to the base unit receives a text message. The handset can notify you by briefly displaying a message, by sounding a ringer tone or melody, and by announcement. The announcement is in English only.

Important:

- To use the text message alert feature, you need to pair your cellular phone to the base unit (page 18).
- Your cellular phone must support Message Access Profile (MAP) specification. We recommend that you confirm if your cellular phone supports MAP in advance.
- For more details and the list of compatible cellular phones, please visit our Web site: <http://www.panasonic.com/link2cell>

For those whose devices do not support the Message Access Profile (MAP):

By installing the app “Text Message Alert”, you can use the text message alert feature. Please visit our Web site:

<http://www.panasonic.net/pcc/support/tel/sms/>



- Refer to your cellular phone operating instructions for information on how to install applications.

Setting text message (SMS) alert

The following settings are available. The default is “On (no announce)”.

- “On (no announce)”: The handset notifies you but does not make an announcement.
- “On (with name)”: The handset notifies you and announces the name of the message sender.
- “Off”: The handset does not notify you.

Your cellular phone

In order to use the text message alert feature, you may need to enable your cellular phone’s Bluetooth notification feature.

Handset

■ Turning text message (SMS) alert on/off

- 1 For CELL 1: **[MENU]** #6101
For CELL 2: **[MENU]** #6102
- 2 **[↕]**: “On/Off” → **[SELECT]**
- 3 **[↕]**: Select the desired setting.
- 4 **[SAVE]** → **[OFF]**

■ Selecting the alerting tone

- 1 For CELL 1: **[MENU]** #6101
For CELL 2: **[MENU]** #6102
- 2 **[↕]**: “Alert tone” → **[SELECT]**
- 3 **[↕]**: Select the desired setting.
- 4 **[SAVE]** → **[OFF]**

Note:

- If the text message alert feature does not work, you must turn on notifications in the Bluetooth settings of your cellular phone. Then, unplug the base unit’s AC adaptor and reconnect it to activate the text message alert feature. For instructions on how to do this, visit our Web site: <http://www.panasonic.net/pcc/support/tel/sms/>
- The unit announces the name or phone number depending on your cellular phone.
- This feature may not pronounce all names correctly.

Using Bluetooth Devices

- Text message alerts are not logged in the caller list of your unit.

Using a Bluetooth wireless headset (optional) for landline calls

By pairing a Bluetooth headset to the base unit, you can have a hands-free conversation wirelessly for landline calls.

Important:

- Your Bluetooth wireless headset must support the HeadSet Profile (HSP) specification.
- 1 headset can be paired to the base unit.
- Only 2 Bluetooth devices can be used with the unit at the same time (for example, 2 cellular lines, or the headset and 1 cellular line).
- For best performance, we recommend using a Bluetooth headset within 1 m (3.3 feet) of the base unit. A headset can communicate with the base unit within a range of approximately 10 m (33 feet).

Pairing a headset to the base unit

Important:

- Make sure that the Bluetooth headset is not connected to any other Bluetooth device.
- 1 Your headset:**
Set your headset to pairing mode.
 - Refer to the headset operating instructions.
 - 2 Handset:**
[MENU][#][6][2][1]
 - 3 If your headset PIN is "0000",** go to step 4.
If your headset PIN is other than "0000", press [CLEAR], then enter your headset PIN.
 - Typically, default PIN is "0000". Refer to the headset operating instructions.
 - 4 Press [OK],** then wait until a long beep sounds.

5 [OFF]

- When the HEADSET indicator on the base unit lights up, you are ready to use the headset.

Connecting/disconnecting a headset

If you cannot connect the headset and base unit using the headset, you can connect using the handset.

To use your headset with another Bluetooth device such as a cellular phone, you may need to disconnect it from the base unit.

Important:

- Make sure that the headset is turned on.

1 To connect/disconnect:

[MENU][#][6][2][2]

- A long beep sounds.

2 [OFF]

Unpairing a headset

You can cancel a pairing of the headset that is stored to the base unit.

1 [MENU][#][6][1][2]

2 [↕]: "Yes" → [SELECT]

- When the headset is unpaired, the HEADSET indicator is turned off.

3 [OFF]

Operating a Bluetooth wireless headset using a landline

Important:

- Refer to your headset operating instructions for headset operations.

Answering landline calls with your headset

To answer a landline call, turn on your headset referring to your headset operating instructions.

When you finish talking, turn off your headset referring to your headset operating instructions.

Note:

- If you cannot hang up the call using your headset:
 - press [▶■] (STOP) on the base unit.
(KX-TGE260 series: page 3)
 - press [Ⓜ] on the base unit 2 times.
(KX-TGE270 series: page 3)

Switching between the base unit and your headset

You can switch between the base unit and your headset:

- during a landline call with the base unit speakerphone. (KX-TGE270 series: page 3)
- during an intercom call between the base unit and handset. (KX-TGE270 series: page 3)
- while listening to messages recorded on the base unit answering system.

■ To switch to your headset:

Turn on the headset referring to your headset operating instructions.

■ To switch to the base unit (KX-TGE270 series: page 3):

Press [Ⓜ] on the base unit.

Call sharing between your headset and the handset

Important:

- To activate this feature, you should set call sharing mode to on beforehand (page 43).
- **While the handset is on a landline call:**
To join the conversation with your headset, turn on the headset referring to your headset operating instructions.
- **While your headset is on a landline call:**
To join the conversation with the handset, press [↶].

Adjusting your headset receiver volume

Base unit

Press [⊕] or [⊖] repeatedly while using your headset.

Answering System for Landline

Answering system for landline

The answering system can answer and record calls for you when you are unavailable to answer the phone.

You can also set the unit to play a greeting message but not to record caller messages by selecting “**Greeting only**” as the recording time setting (page 61).

Important:

- Make sure the unit's date and time setting is correct (page 16).

Memory capacity (including your greeting message)

The total recording capacity is about 18 minutes. A maximum of 64 messages can be recorded.

Note:

- When message memory becomes full:
 - “**Messages full**” is shown on the handset display.
 - The message counter on the base unit flashes if the answering system is turned on.
 - If you use the pre-recorded greeting message, the unit automatically switches to another pre-recorded greeting message asking callers to call again later.
 - If you recorded your own greeting message, the same message is still announced to callers even though their messages are not recorded.

Turning the answering system on/off

Base unit

Press [**ANSWER ON/OFF**] to turn on/off the answering system.

Handset

- 1 **To turn on:**
[MENU]#[3][2][7]
To turn off:
[MENU]#[3][2][8]
- 2 [**OFF**]

Note for base unit and handset:

- When the answering system is turned on, the message counter on the base unit displays the total number of messages (old and new).

Greeting message

When the unit answers a call, a greeting message is played to callers.

You can use either:

- your own greeting message
- a pre-recorded greeting message

Recording your greeting message

- 1 [MENU]#[3][0][2]
- 2 [↕]: “**yes**” → [**SELECT**]
- 3 After a beep sounds, hold the handset about 20 cm (8 inches) away and speak clearly into the microphone (2 minutes max.).
- 4 Press [**STOP**] to stop recording. → [**OFF**]

Using a pre-recorded greeting message

The unit provides 2 pre-recorded greeting messages:

- If you erase or do not record your own greeting message, the unit plays a pre-recorded greeting asking callers to leave a message.
- If the message recording time (page 61) is set to “**Greeting only**”, callers' messages are not recorded and the unit plays a different pre-recorded greeting message asking callers to call again.

Answering System for Landline

Resetting to a pre-recorded greeting message

If you want to use a pre-recorded greeting message once you record your own greeting message, you need to erase your own greeting message.

- 1 **[MENU]** **#** **3** **0** **4**
- 2 **[YES]** → **[OFF]**

Playing back the greeting message

- 1 **[MENU]** **#** **3** **0** **3**
- 2 To exit, press **[OFF]**.

Listening to messages

Using the base unit

When new messages have been recorded, **[▶■]** on the base unit flashes. Press **[▶■]** (PLAY).

- During playback, **[▶■]** on the base unit lights.
- If new messages have been recorded, the base unit plays back new messages.
- If there are no new messages, the base unit plays back all messages.

Operating the answering system during playback

Key	Operation
[+] or [-]	Adjust the speaker volume
[◀◀]	Repeat message*1
[▶▶]	Skip message
[▶■] (STOP)	Stop playback
[ERASE]	Erase currently playing message

*1 If pressed within the first 5 seconds of a message, the previous message is played.

Erasing all messages

Press **[ERASE]** 2 times while the unit is not in use.

Using the handset

When new messages have been recorded, “New message” is displayed.

- 1 **To listen to new messages:**
[MENU] **#** **3** **2** **3**
To listen to all messages:
[MENU] **#** **3** **2** **4**
- 2 When finished, press **[OFF]**.

Note:

- To switch to the receiver, press **[↶]**.
- You can also use the **[PLAY]** soft key, if displayed, to play new messages.

Using the Smart function key

When “New message” is displayed and the **NR** indicator flashes slowly, there are new messages.

Press **[NR]** in step 1 on “Using the handset”, page 57.

- “New message” must be set to “On” in “Setting the Smart function key”, page 17.

Operating the answering system

[MENU] → **[↕]**: “Answering device” → **[SELECT]**

Key	Operation
[+] or [-]	Adjust the receiver/speaker volume (during playback)
1 or [◀]	Repeat message (during playback)*1
2 or [▶]	Skip message (during playback)
3	Enter the “Settings” menu
4	Play new messages
5	Play all messages
6	Play greeting message
7 6	Record greeting message

Answering System for Landline

Key	Operation
[8]	Turn answering system on
[PAUSE]	Pause message*2
[9] or [STOP]	Stop recording Stop playback
[0]	Turn answering system off
[*]4*3	Erase currently playing message
[*]5	Erase all messages
[*]6	Reset to a pre-recorded greeting message

- *1 If pressed within the first 5 seconds of a message, the previous message is played.
- *2 To resume playback:
[↕]: "Playback" → [SELECT]
- *3 You can also erase as follows:
[PAUSE] → [↕]: "Erase" → [SELECT] → [↕]: "Yes" → [SELECT]

Calling back (Caller ID subscribers only)

- Using a cellular line:
 - 1 Press [PAUSE] during playback.
 - 2 [↕]: "Call back (Cell)" → [SELECT]
 - The unit starts dialing when:
 - only 1 cellular phone is paired.
 - a specific line is set to make cellular calls (page 21).
 - 3 [↕]: Select the desired cellular phone. → [SELECT]
- Using the landline:
 - 1 Press [PAUSE] during playback.
 - 2 [↕]: "Call back" → [SELECT]

Editing the number before calling back

- 1 Press [PAUSE] during playback.
- 2 [↕]: "Edit & Call" → [SELECT]

- 3 Press [EDIT] repeatedly until the phone number is shown in the desired format (page 50). → [↩]
 - To call back using a cellular line, continue from step 2, "Making cellular calls", page 22.

Erasing all messages

- 1 [MENU]# [3] [2] [5]
- 2 [↕]: "Yes" → [SELECT] → [OFF]

Advanced new message alerting features

Audible message alert

This feature allows the base unit to beep to inform you of a new message arrival when new messages are recorded. The base unit beeps 2 times every minute until you listen to the messages, if the "Base unit beep" setting is turned on. The default setting is "Off".

- 1 [MENU]# [3] [3] [9]
- 2 [↕]: Select the desired setting. → [SAVE] → [OFF]

New message alert by a call

This feature allows you to receive a notification by phone when new messages are recorded. The base unit calls a phone number you specify. You can then operate the answering system remotely to listen to the new message.

To use this feature, you must:

- store a phone number to which the unit makes the call to.
- turn on the new message alert setting.

After you answer the new message alert call, you can listen to messages from that call (page 59).

Important:

- A new message alert is stopped 1 minute after the unit starts to call. The unit will not retry the call even if the call is not answered.

Answering System for Landline

Storing a phone number to which the unit makes an alert call

■ From the phonebook:

- 1 [MENU]#338
- 2 [↕]: "Notification to" → [SELECT] → [ADD]
- 3 [↕]: "Phonebook" → [SELECT]
- 4 [↕]: Select the desired phonebook entry. → [SAVE] → [OFF]

■ By entering a phone number:

- 1 [MENU]#338
- 2 [↕]: "Notification to" → [SELECT] → [ADD]
- 3 [↕]: "Manual" → [SELECT]
- 4 Enter the desired name (16 characters max.). → [OK]
- 5 Enter the desired number (24 digits max.). → [OK] → [SELECT] → [OFF]

Turning on/off the new message alert setting

- 1 [MENU]#338
- 2 [↕]: "On/Off" → [SELECT]
- 3 [↕]: Select the desired setting. → [SAVE] → [OFF]

Editing the set phone number

- 1 [MENU]#338
- 2 [↕]: "Notification to" → [SELECT]
- 3 [MENU] → [↕]: "Edit" → [SELECT]
- 4 Edit the name if necessary (16 characters max.). → [OK]
- 5 Edit the phone number if necessary (24 digits max.). → [OK] → [SELECT] → [OFF]

Erasing the set phone number

- 1 [MENU]#338
- 2 [↕]: "Notification to" → [SELECT]

- 3 [MENU] → [↕]: "Erase" → [SELECT]

- 4 [↕]: "Yes" → [SELECT] → [OFF]
 - The new message alert setting is turned off.

Activating/inactivating the remote access code to play messages

If you activate this feature, you must enter the remote access code (page 60) to play the new message from the new message alert call. This is so that unauthorized parties cannot listen to your messages. The default setting is "Inactivate".

- "Inactivate": You can listen to the message by pressing [4] to play new messages (without entering the remote access code).
- "Activate": You must enter your remote access code and then press [4] to play new message.

- 1 [MENU]#338

- 2 [↕]: "Remote code" → [SELECT]

- 3 [↕]: Select the desired setting. → [SAVE] → [OFF]

Listening to messages

After you answer the new message alert, you can listen to the messages as follows.

- When the remote access code is set to "Inactivate":
Press [4] to play the new message during the announcement.

- When the remote access code is set to "Activate":

- 1 Enter the remote access code (page 60) during the announcement.
- 2 Press [4] to play the new message.

Note:

- Within 10 seconds after listening to new messages, you can press [#]9 during the call to turn off the new message alert by a call feature.
- Even if the unit makes a new message alert call, the handset redial list does not show the record.

Answering System for Landline

Remote operation

Using a touch-tone phone, you can call your phone number from outside and access the unit to listen to messages or change answering system settings. The unit's voice guidance prompts you to press certain dial keys to perform different operations.

Remote access code

A 3-digit remote access code must be entered when operating the answering system remotely. This code prevents unauthorized parties from listening to your messages remotely. The default setting is "111".

Important:

- To prevent unauthorized access to this product, we recommend that you regularly change the remote code.

- 1 **[MENU]** **#** **3** **0** **6**
- 2 Enter the desired 3-digit remote access code.
- 3 **[SAVE]** → **[OFF]**

Deactivating remote operation

Press **[X]** in step 2 on "Remote access code", page 60.

- The entered remote access code is deleted.

Using the answering system remotely

- 1 Dial your landline phone number from a touch-tone phone.
- 2 After the greeting message starts, enter your remote access code.
- 3 Follow the voice guidance prompts as necessary or control the unit using remote commands (page 60).
- 4 When finished, hang up.

Voice guidance

■ When the English voice guidance is selected

During remote operation, the unit's voice guidance starts and prompts you to press **[1]** to perform a specific operation, or press **[2]** to listen to more available operations.

■ When the Spanish voice guidance is selected

To start the voice guidance, press **[9]**. The voice guidance announces the available remote commands (page 60).

Note:

- If you do not press any dial keys within 10 seconds after a voice guidance prompt, the unit disconnects your call.

Remote commands

You can press dial keys to access certain answering system functions without waiting for the voice guidance to prompt you.

Key	Operation
[1]	Repeat message (during playback)*1
[2]	Skip message (during playback)
[4]	Play new messages
[5]	Play all messages
[9]	Stop playback*2 Start voice guidance*3
[0]	Turn answering system off
[X] [4]	Erase currently playing message
[X] [5]	Erase all messages
[X] [#]	End remote operation (or hang up)

*1 If pressed within the first 5 seconds of a message, the previous message is played.

*2 For English voice guidance only

*3 For Spanish voice guidance only

Answering System for Landline

Turning on the answering system remotely

- 1 Dial your phone number from a touch-tone phone.
- 2 Let the phone ring 15 times.
 - A long beep is heard.
- 3 Enter your remote access code within 10 seconds after the long beep.
 - The greeting message is played back.
 - You can either hang up, or enter your remote access code again and begin remote operation (page 60).

Answering system settings

Call screening

Handset / Base unit*1

While a caller is leaving a message, you can listen to the call through the unit's speaker. To adjust the speaker volume, press **[+]** or **[-]** repeatedly.

You can answer the call by pressing **[☎]** on the handset or **[☎]** on the base unit*1.

Call screening can be set for each unit. The default setting is "On".

- 1 **For handset setting:** **[MENU]#310**
For base unit setting (using a handset)*1: **[MENU]#*310**
- 2 **[↕]:** Select the desired setting. → **[SAVE] → [OFF]**

*1 KX-TGE270 series: page 3

Number of rings before the unit answers a call

You can change the number of times the phone rings "Ring count" before the unit answers calls. You can select 2 to 7 rings, or "Toll saver".

The default setting is "4 rings".

"Toll saver": The unit's answering system answers at the end of the 2nd ring when new messages have been recorded, or at the end of the 5th ring when there are no new

messages. If you call your phone from outside to listen to new messages (page 60), you know that there are no new messages when the phone rings for the 3rd time. You can then hang up without being charged for the call.

- 1 **[MENU]#211**
- 2 **[↕]:** Select the desired setting. → **[SAVE] → [OFF]**

For voice mail service subscribers

If you subscribe to a flat-rate service package that includes Caller ID, call waiting, voice mail, and unlimited local/regional/long distance calls, please note the following:

- To use the voice mail service provided by your service provider/telephone company rather than the unit's answering system, turn off the answering system (page 56).
- To use this unit's answering system rather than the voice mail service provided by your service provider/telephone company, please contact your service provider/telephone company to deactivate your voice mail service.
If your service provider/telephone company cannot do this:
 - Set this unit's "Ring count" setting so that this unit's answering system answers calls before the voice mail service of your service provider/telephone company does. It is necessary to check the number of rings required to activate the voice mail service provided by your service provider/telephone company before changing this setting.
 - Change the number of rings of the voice mail service so that the answering system can answer the call first. To do so, contact your service provider/telephone company.

Caller's recording time

You can change the maximum message recording time allowed for each caller. The default setting is "3 min".

- 1 **[MENU]#305**
- 2 **[↕]:** Select the desired setting. → **[SAVE] → [OFF]**

Answering System for Landline

Selecting “Greeting only”

You can select “**Greeting only**” which sets the unit to announce a greeting message to callers but not record messages.

Select “**Greeting only**” in step 2 on “Caller’s recording time”, page 61.

Note:

- When you select “**Greeting only**”:
 - If you do not record your own message, the unit will play the pre-recorded greeting-only message asking callers to call again later.
 - If you use your own message, record the greeting-only message asking callers to call again later (page 56).

Voice mail service for landline

Voice mail is an automatic answering service offered by your service provider/telephone company. After you subscribe to this service, your service provider/telephone company's voice mail system answers calls for you when you are unavailable to answer the phone or when your line is busy. Messages are recorded by your service provider/telephone company, not your telephone. Please contact your service provider/telephone company for details of this service.

Important:

- To use the voice mail service provided by your service provider/telephone company rather than the unit's answering system, turn off the answering system (page 56). For details, see page 61.

Storing the voice mail (VM) access number

In order to listen to your voice mail messages, you must dial your service provider/telephone company's voice mail access number. Once you have stored your voice mail access number, you can dial it automatically (page 64).

- [MENU]#331**
- Enter your access number (24 digits max.). → **[SAVE]** → **[OFF]**

Note:

- When storing your voice mail access number and your mailbox password, press **[▲]** (Pause) to add pauses (page 23) between the access number and the password as necessary. Contact your service provider/telephone company for the required pause time.

Example:

1-222-333-4444	PPPP	8888
VM access	Pauses	Password
number		

To erase the voice mail access number

- [MENU]#331**
- Press and hold **[CLEAR]** until all digits are erased. → **[SAVE]** → **[OFF]**

Voice mail (VM) tone detection

Handset / Base unit*1

*1 KX-TGE270 series: page 3

Your service provider/telephone company sends special signals (sometimes called "voice mail tones" or "stutter tones") to the unit to let you know you have new voice mail messages. If you hear a series of dial tones followed by a continuous dial tone after you press **[↶]** on the handset or press **[⏻]** on the base unit, you have new voice mail messages. Soon after you hang up a call or after the phone stops ringing, your unit checks the phone line to see if new voice mail messages have been recorded.

Turn this feature off when:

- You do not subscribe to voice mail service.
- Your service provider/telephone company does not send voice mail tones.
- Your phone is connected to a PBX.

If you are not sure which setting is required, contact your service provider/telephone company.

Turning VM tone detection on/off

The default setting is "On".

- [MENU]#332**
- [↕]**: Select the desired setting. → **[SAVE]** → **[OFF]**

Useful Information

Listening to voice mail messages

The unit lets you know that you have new voice mail messages in the following way:

- "Voice mail msg. via phone co." is displayed if message indication service is available.

Handset

- 1 **[MENU]** **#** **3** **3** **0**
 - The speakerphone turns on.
- 2 Follow the pre-recorded instructions.
- 3 When finished, press **[OFF]**.

Note:

- You can also use the **[ACCESS]** soft key, if displayed, to play new voice mail messages.
- If the handset still indicates there are new messages even after you have listened to all new messages, turn it off by pressing and holding **#** until the handset beeps.

Base unit*1

*1 KX-TGE270 series: page 3

To listen to voice mail messages, you have to dial your voice mail access number manually.

Using the Smart function key

When "Voice mail msg. via phone co." is displayed and the **JR** indicator flashes slowly, there are new voice mail messages.

Press **[JR]** in step 1 on "Listening to voice mail messages", page 64.

- "New VM" must be set to "On" in "Setting the Smart function key", page 17.
- If the voice mail (VM) access number is not stored, the **JR** indicator does not flash.
- When the unit has new messages, new voice mail messages, and missed calls, the unit can be operated to play the new messages first, play the new voice mail messages next, and then show the missed calls.

Wall mounting

Note:

- Make sure that the wall and the fixing method are strong enough to support the weight of the unit.

Base unit

- 1 Lead the AC adaptor cord and telephone line cord through the hole in the wall mounting adaptor in the direction of the arrow.

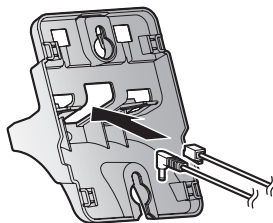

- 2 Tuck the telephone line cord inside the wall mounting adaptor (1). Connect the AC adaptor cord and telephone line cord (2).
- A** AC adaptor cord

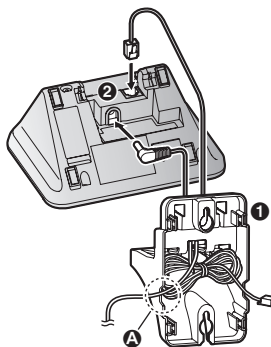

Useful Information

- 3** Insert the hooks on the wall mounting adaptor into holes **(A)** and **(B)** on the base unit.

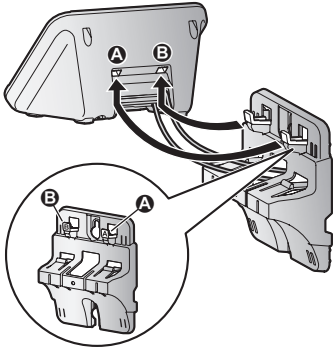

- 4** Adjust the adaptor to hold the base unit, then push it in the direction of the arrow until it clicks into place.

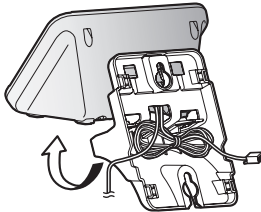
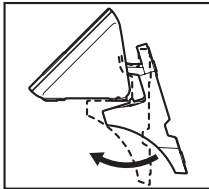

- 5** Mount the unit on a wall then slide down to secure in place.

- (A)** AC adaptor cord
- This product is compliant with the following wall phone plate sizes (2 types).
- (B)** 83 mm (3 1/4 inches)

- (C)** 102 mm (4 inches)
Fit the slots of the unit onto the corresponding wall phone plate tabs for **(D)** and **(E)** respectively.

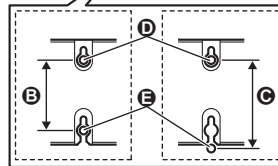
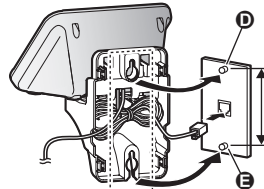
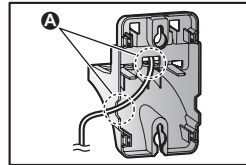

To remove the wall mounting adaptor

While pushing down the release levers **(1)**, remove the adaptor **(2)**.

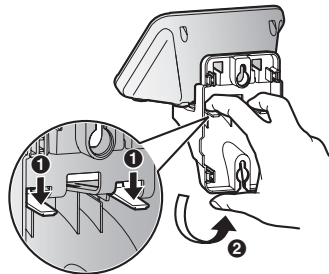

Useful Information

Charger

Drive the screws (A) (not supplied) into the wall.

B 27.2 mm (1 1/16 inches)

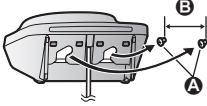

Error messages

Display message	Cause/solution
Ask phone company for VM access #	<ul style="list-style-type: none"> You have not stored the voice mail access number. Store the number (page 63).
Base no power or No link. Re-connect base AC adaptor. or No link.	<ul style="list-style-type: none"> The handset has lost communication with the base unit. Move closer to the base unit and try again. Unplug the base unit's AC adaptor to reset the unit. Reconnect the adaptor and try again. The handset's registration may have been canceled. Re-register the handset (page 48). When "No link." is displayed during a power failure, place a handset on the base unit to supply power to the base unit.
Busy	<ul style="list-style-type: none"> No cellular phone is paired to the base unit. Pair a cellular phone (page 18). The called unit is in use. Other units are in use and the system is busy. Try again later. The handset you are using is too far from the base unit. Move closer and try again.
Check tel line	<ul style="list-style-type: none"> The supplied telephone line cord has not been connected yet or not connected properly. Check the connections (page 11). If you do not connect the telephone line cord and use only cellular lines, set the cellular line only mode (page 20).
Error!!	<ul style="list-style-type: none"> Recording was too short. Try again. Someone is using a cellular line or headset. Try again later. The phonebook copy is incomplete (page 52). The cellular phone is disconnected from the base unit. Make sure that other Bluetooth devices are not connected to the cellular phone, and try again.
Failed	<ul style="list-style-type: none"> Although the unit tried to connect to the cellular phone or headset, the connection has been failed. <ul style="list-style-type: none"> Someone is using a cellular line or headset. Try again later. Make sure that the cellular phone or headset is not connected to other Bluetooth devices.
Invalid	<ul style="list-style-type: none"> There is no handset registered to the base unit matching the handset number you entered. The handset is not registered to the base unit. Register the handset (page 48).

Useful Information

Display message	Cause/solution
Requires subscription to Caller ID.	<ul style="list-style-type: none">You must subscribe to a Caller ID service. Once you receive caller information after subscribing to a Caller ID service, this message will not be displayed.
Use rechargeable battery.	<ul style="list-style-type: none">A wrong type of battery such as Alkaline or Manganese was inserted. Use only the rechargeable Ni-MH batteries noted on page 4, 8.

Troubleshooting

If you still have difficulties after following the instructions in this section, disconnect the base unit's AC adaptor, then reconnect the base unit's AC adaptor. Remove the batteries from the handset, and then insert the batteries into the handset again.

General use

Problem	Cause/solution
The handset does not turn on even after installing charged batteries.	<ul style="list-style-type: none">Place the handset on the base unit or charger to turn on the handset.
The unit does not work.	<ul style="list-style-type: none">Make sure the batteries are installed correctly (page 11).Fully charge the batteries (page 12).Check the connections (page 11).Unplug the base unit's AC adaptor to reset the unit. Reconnect the adaptor and try again.The handset has not been registered to the base unit. Register the handset (page 48).
I cannot pair a cellular phone to the base unit.	<ul style="list-style-type: none">Depending on the compatibility of the cellular phone, you may not be able to pair it to the base unit. Confirm that your cellular phone supports the hands-free profile (HFP) specification.Confirm that the Bluetooth feature of your cellular phone is turned on. You may need to turn this feature on depending on your cellular phone.The Bluetooth technology on your cellular phone may not be functioning normally. Turn off and on your cellular phone.If your cellular phone is already connected to another Bluetooth device such as a Bluetooth headset, turn it off or disconnect it from your cellular phone.Some cellular phones may require you to enter the Bluetooth PIN to pairing. Confirm that you entered the correct PIN.



Useful Information

Problem	Cause/solution
I cannot connect a cellular phone to the base unit.	<ul style="list-style-type: none"> • Confirm that your cellular phone is turned on. • Confirm that your cellular phone is within base unit range (page 14). • Your cellular phone's Bluetooth feature is turned off. Turn it on. • Depending on the state of the wireless environment, such as the presence of any electrical interference, there may be a delay even if the auto connection feature is turned on. You can connect to the base unit manually (page 20). • The cellular phone has not been paired to the base unit. Pair the cellular phone (page 18).
I cannot hear a dial tone.	<ul style="list-style-type: none"> • The base unit's AC adaptor or telephone line cord is not connected. Check the connections. • Disconnect the base unit from the telephone line and connect the line to a known working telephone. If the working telephone operates properly, contact our service personnel to have the unit repaired. If the working telephone does not operate properly, contact your service provider/telephone company.
I cannot use the Smart function key even if the  indicator is flashing slowly.	<ul style="list-style-type: none"> • Another unit is in use. Wait and try again later.
The base unit beeps.	<ul style="list-style-type: none"> • New messages have been recorded. Listen to the new messages (page 57).

Menu list

Problem	Cause/solution
The display is in a language I cannot read.	<ul style="list-style-type: none"> • Change the display language (page 16).
I cannot register a handset to a base unit.	<ul style="list-style-type: none"> • The maximum number of handsets (6) is already registered to the base unit. Cancel unused handset registrations from the base unit (page 48).

Battery recharge

Problem	Cause/solution
The handset beeps and/or  flashes.	<ul style="list-style-type: none"> • Battery charge is low. Fully charge the batteries (page 12).
I fully charged the batteries, but <ul style="list-style-type: none"> –  still flashes, –  is displayed, or – the operating time seems to be shorter. 	<ul style="list-style-type: none"> • Clean the battery ends (\oplus, \ominus) and the charge contacts with a dry cloth and charge again. • It is time to replace the batteries (page 11).

Useful Information

Making/answering calls, intercom

Problem	Cause/solution
✖ is displayed.	<ul style="list-style-type: none">• The handset is too far from the base unit. Move closer.• The base unit's AC adaptor is not properly connected. Reconnect AC adaptor to the base unit.• The handset is not registered to the base unit. Register it (page 48).
Noise is heard, sound cuts in and out.	<ul style="list-style-type: none">• You are using the handset or base unit in an area with high electrical interference. Re-position the base unit and use the handset away from sources of interference.• Move closer to the base unit.• If you use a DSL/ADSL service, we recommend connecting a DSL/ADSL filter between the base unit and the telephone line jack. Contact your DSL/ADSL provider for details.
The handset or base unit does not ring.	<ul style="list-style-type: none">• The ringer volume for landline is turned off. Adjust the ringer volume (page 41).• The ringer volume for cellular line is turned off. Adjust the ringer volume (page 39).• When one handset is selected to ring for cellular calls, other units do not ring. To change the selection, see page 19.• Silent mode is turned on. Turn it off (page 45).
I cannot make local calls with the handset or base unit using a cellular line.	<ul style="list-style-type: none">• You need to add your area code when making cellular calls. Store your area code in order to automatically add it to the beginning of the 7-digit phone number when making cellular calls (page 21).
I cannot make or answer cellular calls with the handset or base unit.	<ul style="list-style-type: none">• Depending on the cellular phone's compatibility (page 5), you may not be able to make or answer cellular calls even if the cellular phone is connected to the base unit.• Make sure that the CELL indicator lights up and the cellular phone is connected to the base unit (page 20).• Only 2 Bluetooth devices can be used with the unit at the same time (for example, 2 cellular lines, or the headset and 1 cellular line).• The cellular phone is being used separately from your system.
I can make and answer cellular calls but cannot hear a sound.	<ul style="list-style-type: none">• The Bluetooth technology on your cellular phone may not be functioning normally. Turn off and on your cellular phone.• Disconnect and reconnect the base unit AC adaptor and try again.
I cannot switch cellular calls from the unit to the cellular phone.	<ul style="list-style-type: none">• Your cellular phone may not support this feature. Refer to the operating instructions of your cellular phone.
I cannot make a call using the landline.	<ul style="list-style-type: none">• The dialing mode may be set incorrectly. Change the setting (page 17).

Useful Information

Problem	Cause/solution
I cannot make or answer a call.	<ul style="list-style-type: none">● An outside line is being used after a cell locator feature is used.<ul style="list-style-type: none">– KX-TGE260 series: To end the call, press [LOCATES CELL] on the base unit.– KX-TGE270 series: To end the call if someone answers using the cellular phone, press [⏏] on the base unit.
I cannot use a cellular line or a landline.	<ul style="list-style-type: none">● The unit can be used to talk on 2 lines at the same time (for example, 2 cellular lines, or the landline and 1 cellular line).
I cannot make long distance calls.	<ul style="list-style-type: none">● Make sure that you have long distance service.

Caller ID/Talking Caller ID

Problem	Cause/solution
Caller information is not displayed.	<ul style="list-style-type: none">● You must subscribe to Caller ID service. Contact your service provider/telephone company for details.● If your unit is connected to any additional telephone equipment such as a Caller ID box or cordless telephone line jack, plug the unit directly into the wall jack.● If you use a DSL/ADSL service, we recommend connecting a DSL/ADSL filter between the base unit and the telephone line jack. Contact your DSL/ADSL provider for details.● The name display service for landline calls may not be available in some areas. Contact your service provider/telephone company for details.● Other telephone equipment may be interfering with this unit. Disconnect the other equipment and try again.
Caller information is displayed or announced late.	<ul style="list-style-type: none">● Depending on your service provider/telephone company, the unit may display or announce the caller's information at the 2nd ring or later.● Move closer to the base unit.

Useful Information

Problem	Cause/solution
<p>Caller information is not announced.</p>	<ul style="list-style-type: none"> ● The ringer volume for landline is turned off. Adjust the ringer volume (page 41). ● The ringer volume for cellular line is turned off. Adjust the ringer volume (page 39). ● When one handset is selected to ring for cellular calls, other units do not announce caller information. To change the selection, see page 19. ● The Talking Caller ID feature is turned off. Turn it on (page 41). ● The ring as cell mode is set to “On (without Talking CID)”. To change the mode, see page 19. ● The number of rings for the answering system is set to “2 rings” or “Toll saver”. Select a different setting (page 61). ● Your unit does not announce caller information while the other devices such as headset or handsets are engaged in a call.
<p>The caller list/incoming phone numbers are not edited automatically.</p>	<ul style="list-style-type: none"> ● The Caller ID number auto edit feature is turned off. Turn it on and try again (page 43). ● You need to call back the edited number to activate Caller ID number auto edit.
<p>I cannot dial the phone number edited in the caller list.</p>	<ul style="list-style-type: none"> ● The phone number you dialed might have been edited incorrectly (for example, the long distance “1” or the area code is missing). Edit the phone number with another pattern (page 50).
<p>Time on the unit has shifted.</p>	<ul style="list-style-type: none"> ● Incorrect time information from incoming Caller ID changes the time. Set the time adjustment to “Manual” (off) (page 41).
<p>The 2nd caller’s information is not displayed during an outside call.</p>	<ul style="list-style-type: none"> ● In order to use Caller ID, call waiting, or Call Waiting Caller ID (CWID), you must first contact your service provider/telephone company and subscribe to the desired service. After subscribing, you may need to contact your service provider/telephone company again to activate this specific service, even if you already subscribed to both Caller ID and Call Waiting with Caller ID services (CWID).

Useful Information

Using Bluetooth devices

Problem	Cause/solution
I cannot copy phonebook entries from a cellular phone.	<ul style="list-style-type: none">● Confirm that the cellular phone supports Bluetooth wireless technology.● Confirm that the cellular phone supports the Phone Book Access Profile (PBAP) or Object Push Profile (OPP) specification.● If the cellular phone is already connected to another Bluetooth device such as a Bluetooth headset, turn it off or disconnect it from the cellular phone.● Someone is using a cellular line or headset. Try again later.● Turn the cellular phone off, then turn it on and try again.● If an entry is already stored in the unit's phonebook, the entry cannot be copied even by selecting another group.
I cannot have a conversation using the headset.	<ul style="list-style-type: none">● Confirm that the Bluetooth wireless headset supports the HeadSet Profile (HSP) specification.● Your Bluetooth headset is not paired. Pair it (page 54).● Turn your headset off, then turn it on and try again.
Noise is heard during a call on the headset.	<ul style="list-style-type: none">● A Bluetooth headset can communicate with the base unit within a range of approximately 10 m (33 feet). The connection may be subject to interference from obstructions such as walls or electronic devices. Move closer to the base unit.
I cannot connect my headset to the base unit.	<ul style="list-style-type: none">● Confirm that your headset is turned on.● If your headset is already connected to another Bluetooth device such as your cellular phone, disconnect the headset from your cellular phone, then perform the connecting procedure from the base unit.● Only 2 Bluetooth devices can be used with the unit at the same time (for example, 2 cellular lines, or the headset and 1 cellular line).● The headset has not been paired to the base unit. Pair the headset (page 54).
Some headset enhanced features are not available.	<ul style="list-style-type: none">● The base unit does not support enhanced features such as Last number redial or Call reject.
An error tone is heard when I try to program the Bluetooth feature.	<ul style="list-style-type: none">● The Bluetooth feature cannot be accessed immediately after connecting the AC adaptor to the base unit. Wait a few seconds and try again.● The headset has not connected to the base unit yet, even though you performed the connecting procedure setting. Wait a few seconds and try again.

Useful Information

Problem	Cause/solution
Text message alerts are not displayed or announced.	<ul style="list-style-type: none">● Confirm that the cellular phone supports the Message Access Profile (MAP) specification.● If your smartphone does not support Message Access Profile (MAP), download the "Text Message Alert" app (page 53).● Text message (SMS) alert is set to "On (no announce)" or "Off". Set it to "On (with name)".● The Bluetooth device's Bluetooth notifications setting is turned off.● The handset selected to display and/or announce alerts is in use.● The Bluetooth device or its corresponding cellular line is in use.

Answering system

Problem	Cause/solution
The unit does not record new messages.	<ul style="list-style-type: none">● The answering system is turned off. Turn it on (page 56).● The answering system does not answer or record calls from cellular lines.● The message memory is full. Erase unnecessary messages (page 57).● The recording time is set to "Greeting only". Change the setting (page 61).● Your service provider/telephone company's voice mail service may be answering your calls before the unit's answering system can answer your calls. Change the unit's number of rings setting (page 61) to a lower value, or contact your service provider/telephone company.● The answering system will not answer incoming calls while the other devices such as headset or handsets are engaged in a call.
I cannot operate the answering system remotely.	<ul style="list-style-type: none">● The remote access code is not set. Set the remote access code (page 60).● You are entering the wrong remote access code. If you have forgotten your remote access code, enter the remote access code setting to check your current code (page 60).● The answering system is turned off. Turn it on (page 61).● You cannot operate the answering system when calling a cellular phone paired to the base unit.
The unit does not emit the specified number of rings.	<ul style="list-style-type: none">● If the first ring is turned off, the number of rings decreases by 1 from the specified number of rings.

Useful Information

Bluetooth PIN

Problem	Cause/solution
I cannot remember the PIN.	<ul style="list-style-type: none">Change the PIN using the following method. <ol style="list-style-type: none">[MENU][#][6][1][9][*][7][0][0][0]Enter the new 4-digit PIN. → [OK]Enter the new 4-digit PIN again. → [SAVE] → [OFF]

Voice mail

Problem	Cause/solution
"Voice mail msg. via phone co." is shown on the handset display. How do I remove this message from the display?	<ul style="list-style-type: none">This notification is displayed when your service provider/telephone company's voice mail service (not the unit's answering system) has recorded a message for you. Typically you can remove this notification from the display by listening to the message. To listen to the message, dial the voice mail number provided by your service provider/telephone company (for most cases, this will be your own phone number), and follow the voice instructions. Depending on your service provider/telephone company, you may need to remove all messages from your voice mailbox to remove the notification. You can also remove this notification by pressing and holding [#] until the unit beeps.

Liquid damage

Problem	Cause/solution
Liquid or other form of moisture has entered the handset/base unit.	<ul style="list-style-type: none">Disconnect the AC adaptor and telephone line cord from the base unit. Remove the batteries from the handset and leave to dry for at least 3 days. After the handset/base unit are completely dry, reconnect the AC adaptor and telephone line cord. Insert the batteries and charge fully before use. If the unit does not work properly, contact an authorized service center.

Caution:

- To avoid permanent damage, do not use a microwave oven to speed up the drying process.

Useful Information

FCC and other information

This equipment complies with Part 68 of the FCC rules and the requirements adopted by the ACTA. On the bottom of this equipment is a label that contains, among other information, a product identifier in the format US:ACJ-----.

If requested, this number must be provided to the telephone company.

- Registration No.....(found on the bottom of the unit)
- Ringer Equivalence No. (REN).....0.1B

A plug and jack used to connect this equipment to the premises wiring and telephone network must comply with the applicable FCC Part 68 rules and requirements adopted by the ACTA. A compliant telephone cord and modular plug is provided with the product. It is designed to be connected to a compatible modular jack that is also compliant.

The REN is used to determine the number of devices that may be connected to a telephone line. Excessive RENs on a telephone line may result in the devices not ringing in response to an incoming call. In most but not all areas, the sum of RENs should not exceed five (5.0). To be certain of the number of devices that may be connected to a line, as determined by the total RENs, contact the local telephone company. For products approved after July 23, 2001, the REN for the product is part of the product identifier that has the format US:AAAEQ##TXXXX. The digits represented by ## are the REN without a decimal point (e.g., 03 is a REN of 0.3).

If this equipment causes harm to the telephone network, the telephone company will notify you in advance that temporary discontinuance of service may be required. But if advance notice isn't practical, the telephone company will notify the customer as soon as possible. Also, you will be

advised of your right to file a complaint with the FCC if you believe it is necessary.

The telephone company may make changes in its facilities, equipment, operations or procedures that could affect the operation of the equipment. If this happens the telephone company will provide advance notice in order for you to make necessary modifications to maintain uninterrupted service.

If trouble is experienced with this equipment, for repair or warranty information, please contact a Factory Service Center or other Authorized Servicer. If the equipment is causing harm to the telephone network, the telephone company may request that you disconnect the equipment until the problem is resolved.

Connection to party line service is subject to state tariffs. Contact the state public utility commission, public service commission or corporation commission for information.

If your home has specially wired alarm equipment connected to the telephone line, ensure the installation of this equipment does not disable your alarm equipment. If you have questions about what will disable alarm equipment, consult your telephone company or a qualified installer.

This equipment is hearing aid compatible as defined by the FCC in 47 CFR Section 68.316.

When you hold the phone to your ear, noise might be heard in your Hearing Aid. Some Hearing Aids are not adequately shielded from external RF (radio frequency) energy. If noise occurs, use an optional headset accessory or the speakerphone option (if applicable) when using this phone. Consult with your audiologist or Hearing Aid

Useful Information

manufacturer about the availability of Hearing Aids which provide adequate shielding to RF energy commonly emitted by digital devices.

WHEN PROGRAMMING EMERGENCY NUMBERS AND/OR MAKING TEST CALLS TO EMERGENCY NUMBERS:

- 1) Remain on the line and briefly explain to the dispatcher the reason for the call.
- 2) Perform such activities in the off-peak hours, such as early morning or late evenings.

This device complies with Part 15 of the FCC Rules. Operation is subject to the following two conditions:

(1) This device may not cause harmful interference, and (2) this device must accept any interference received, including interference that may cause undesired operation.

Privacy of communications may not be ensured when using this phone.

CAUTION:

Any changes or modifications not expressly approved by the party responsible for compliance could void the user's authority to operate this device.

NOTE:

This equipment has been tested and found to comply with the limits for a Class B digital device, pursuant to Part 15 of the FCC Rules. These limits are designed to provide reasonable protection against harmful interference in a residential installation. This equipment generates, uses, and can radiate radio frequency energy and, if not installed and used in accordance with the instructions, may cause harmful interference to radio communications. However, there is no guarantee that interference will not occur in a particular installation. If this equipment does cause harmful interference to radio or television reception, which can be determined by turning the equipment off and on, the user is

encouraged to try to correct the interference by one or more of the following measures:

- Reorient or relocate the receiving antenna.
- Increase the separation between the equipment and receiver.
- Connect the equipment into an outlet on a circuit different from that to which the receiver is connected.
- Consult the dealer or an experienced radio/TV technician for help.

Some cordless telephones operate at frequencies that may cause interference to nearby TVs and VCRs. To minimize or prevent such interference, the base of the cordless telephone should not be placed near or on top of a TV or VCR. If interference is experienced, move the cordless telephone further away from the TV or VCR. This will often reduce or eliminate interference.

FCC RF Exposure Warning:

- This product complies with FCC radiation exposure limits set forth for an uncontrolled environment.
- To comply with FCC RF exposure requirements, the base unit must be installed and operated 20 cm (8 inches) or more between the product and all person's body.
- This product may not be collocated or operated in conjunction with any other antenna or transmitter.
- The handset may be carried and operated with only the specific provided belt-clip. Other non-tested belt-clips or similar body-worn accessories may not comply and must be avoided.

Notice:

- FCC ID can be found inside the battery compartment or on the bottom of the units.

Useful Information

Compliance with TIA-1083 standard:

Telephone handsets identified with this logo have reduced noise and interference when used with T-Coil equipped hearing aids and cochlear implants.

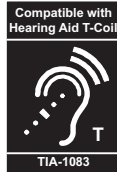

Guía Rápida Española

Conexiones

Unidad base

- ① Conecte el adaptador de corriente alterna a la unidad presionándolo firmemente.
- ② Enganche el cable para fijarlo.
- ③ Conecte el adaptador de corriente alterna a la toma de corriente.
- ④ Conecte el cable de la línea telefónica a la unidad, y después a la toma telefónica de una sola línea (RJ11C) hasta que escuche un clic.
- ⑤ Se requiere un filtro DSL/ADSL (no incluido) si tiene este tipo de servicio.

Nota:

- Use solo el adaptador de corriente alterna Panasonic PNLV226 que se suministra.

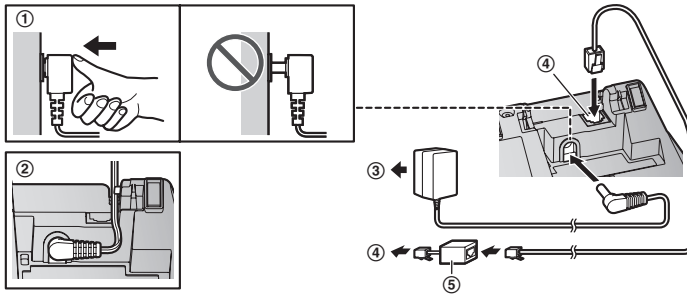

Cargador

- ① Conecte el adaptador de corriente alterna a la toma de corriente.

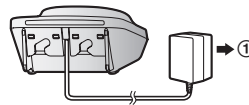

Guía Rápida Española

Instalación y carga de la batería

Cargue aproximadamente durante 7 horas.

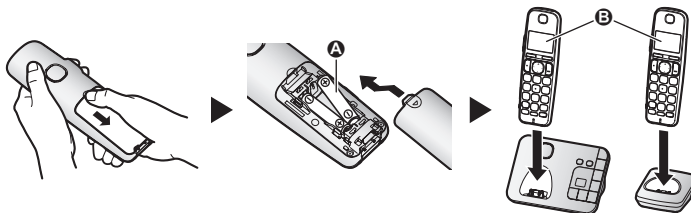

Nota:

- UTILICE SOLO baterías recargables de Ni-MH tamaño AAA (R03) (A).
- NO utilice baterías Alcalinas, de Manganeseo o de Ni-Cd.
- Confirme que las polaridades estén correctas (+, -).
- Cambie el idioma de la pantalla.
- Confirme que aparezca "Cargando" (B).

Sugerencias de operación

Teclas de función

Al oprimir una tecla de función, puede seleccionar la función que aparece directamente encima de ella en la pantalla. Preste atención a la pantalla para ver qué funciones están asignadas a las teclas de función durante la operación.

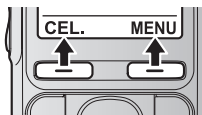

Tecla navegadora

- [▲], [▼], [◀], o [▶]: Navegue por diversas listas y elementos.
- ◀ (Volumen: [▲] o [▼]): Ajuste el volumen del receptor o el altavoz mientras habla.
- [◀] □□: Vea la entrada del directorio telefónico.
- [▶] REDIAL (Remarcación): Vea la lista de remarcación.
- [▼] CID (identificador de llamadas): Vea la lista de personas que llamaron.

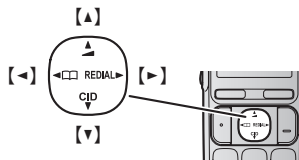

Cambio de idiomas (Auricular) (predeterminado: "English")

Cuando instale las baterías por primera vez, es posible que aparezca "Date and time Press SELECT". Oprima [OFF] para salir.

Idioma de la pantalla

[MENU] [1] [1] [1] [0] → [↕]: "Español" → [GUARDA] → [OFF]

Idioma de la guía de voz

[MENU] [1] [1] [1] [2] → [↕]: "Español" → [GUARDA] → [OFF]

Fecha y hora (Auricular)

- 1 **[MENU]** **[#]** **[1]** **[0]** **[1]**
- 2 Introduzca el día, mes y año actuales. → **[OK]**
- 3 Introduzca la hora y minuto actuales (formato de reloj de 24 horas).
- 4 **[GUARDA]** → **[OFF]**

Cómo grabar el mensaje de saludo del contestador de llamadas para la línea terrestre (Auricular)

Si utiliza un mensaje de saludo pregrabado, no es necesario que grabe su propio mensaje de saludo.

- 1 **[MENU]** **[#]** **[3]** **[0]** **[2]** → **[↑]**: "sí" → **[SELEC.]**
- 2 Después de que se emita un pitido, sostenga el auricular a una distancia aproximada de 20 cm (8 pulgadas) y hable con claridad en el micrófono (máx. de 2 minutos).
- 3 Oprima **[PARAR]** para dejar de grabar. → **[OFF]**

Enlace a celular

Puede conectar su unidad base y teléfono celular usando la tecnología inalámbrica Bluetooth®, para poder hacer o responder llamadas a su teléfono celular usando su sistema telefónico. Para obtener más detalles, visite nuestro sitio web: <http://www.panasonic.com/link2cell>

- Coloque su teléfono celular cerca de la unidad base. Si su teléfono celular está demasiado cerca de la unidad base durante la llamada celular, es posible que escuche ruido. Para un mejor funcionamiento, le recomendamos que coloque su teléfono celular de 0.6 m a 3 m (2 pies a 10 pies) de la unidad base.



- A** Línea celular
- B** Proveedores de servicios de telefonía celular

Marcas registradas

- La marca denominativa y los logotipos de Bluetooth® son marcas registradas de Bluetooth SIG, Inc. y cualquier uso de dichas marcas por parte de Panasonic Corporation se hace bajo licencia.
- Todas las demás marcas comerciales que se identifican en el presente pertenecen a sus respectivos propietarios.

Guía Rápida Española

Enlace a celular

Cómo emparejar un teléfono celular con Bluetooth

1 Auricular:

Para CELL 1: [MENU] # [6] [2] [4] [1]

Para CELL 2: [MENU] # [6] [2] [4] [2]

- Después de que el indicador de CELL correspondiente comienza a parpadear en la unidad base, el resto del procedimiento debe completarse en menos de 5 minutos.

2 Su teléfono celular:

Mientras el indicador de CELL correspondiente esté parpadearo, siga las instrucciones de su teléfono celular para entrar al modo de emparejamiento.

- Dependiendo de su teléfono celular, es posible que le pida que introduzca el NIP de Bluetooth (predeterminado: "0000"). Si su teléfono celular muestra la confirmación de la PassKey en su pantalla, siga las instrucciones para continuar.

3 Auricular:

Espere a que se emita un pitido largo.

- Es posible que tarde más de 10 segundos en completar el emparejamiento.
- Cuando el indicador del CELL correspondiente se ilumina, esto significa que el teléfono celular está conectado a la unidad base. Ya está listo para hacer llamadas regulares de celular.

4 [OFF]

Nota:

- Asegúrese de que su teléfono celular está configurado para conectarse a este producto automáticamente. Consulte las instrucciones de operación de su teléfono celular.

Unidad base: Indicadores de CELL

Estado	Significado
Encendido	Un teléfono celular está conectado. Listo para hacer o recibir llamadas celulares.
Parpadeando	<ul style="list-style-type: none"> – La línea del celular se está usando. – Las entradas del directorio telefónico se están copiando desde un teléfono celular. – La unidad base está buscando el teléfono celular emparejado. – La unidad base está emparejando un teléfono celular. – Una llamada de celular se pone en espera.
Parpadea rápidamente	Se está recibiendo una llamada de celular.
Luz apagada	<ul style="list-style-type: none"> – No hay un teléfono celular emparejado con la unidad base. – No hay un teléfono celular conectado a la unidad base.

Auricular: enlace a elementos de la pantalla del celular

	<p>Se está usando una línea de celular.*1</p> <ul style="list-style-type: none"> • Cuando parpadea: la llamada celular se pone en espera. • Cuando parpadea rápidamente: se está recibiendo una llamada celular. <p>*1 La línea o líneas celulares correspondientes se indican enseguida del elemento.</p>
	<p>Un teléfono celular está conectado.*1 Listo para hacer o recibir llamadas celulares.</p> <ul style="list-style-type: none"> • Cuando está apagado: no hay un teléfono celular conectado a la unidad base. <p>*1 La línea o líneas celulares correspondientes se indican enseguida del elemento.</p>
	<ul style="list-style-type: none"> – Se está haciendo una llamada de celular en esa línea. – La línea celular está seleccionada para la configuración.

Enlace a celular

Cómo conectar o desconectar el teléfono celular

Conexión automática a dispositivos Bluetooth (teléfonos celulares o audífono)

La unidad se conecta a los dispositivos Bluetooth a intervalos regulares si se pierde la conexión. consulte las instrucciones de operación para cambiar el intervalo (predeterminado: "1 min").

- Cuando se sincronizan 3 dispositivos con capacidad Bluetooth (2 teléfonos celulares y 1 audífono) a la unidad base, sólo 2 dispositivos Bluetooth pueden usarse con la unidad a la vez, y la unidad base pierde su conexión con otros dispositivos Bluetooth. Para restablecer la conexión a los dispositivos Bluetooth automáticamente, deje encendida la conexión automática.

Cómo conectar o desconectar manualmente el teléfono celular

Si no va a utilizar el vínculo del teléfono celular emparejado a la función del celular temporalmente (por ejemplo, si no quiere que la unidad timbre cuando su línea celular reciba una llamada), puede desconectar su teléfono celular de la unidad base. Si desea usarlo de nuevo, reconecte el teléfono celular a la unidad base.

- Aunque haya desconectado un teléfono celular emparejado de la unidad base, si lo coloca dentro del alcance de la unidad base durante el intervalo de conexión automática, es posible que se conecte automáticamente a la unidad base.
- Los teléfonos celulares desconectados no se desemparejan de la unidad base, así que no es necesario emparejarlos de nuevo con ella.

1 Para conectarlo o desconectarlo:

Para CELL 1: **[MENU]#6[2]5[1]** (Se emite un pitido largo.)

Para CELL 2: **[MENU]#6[2]5[2]** (Se emite un pitido largo.)

2 [OFF]

Modo exclusivo para la línea celular (si no utiliza la línea terrestre) (Auricular)

Si no utiliza la línea terrestre, configure el modo exclusivo para la línea celular para usar esta unidad en forma más conveniente.

- Si enciende el "Modo Lín. Cel.", desconecte el cable de la línea telefónica de la unidad base. De lo contrario no será posible activar el "Modo Lín. Cel."

1 [MENU]#1[5]7

2 Para encenderlo:

[+]: "Encendido" → [SELEC.] → [+]: "sí" → [SELEC.]

Para apagarlo:

[+]: "Apagado" → [SELEC.]

Operaciones básicas

Cómo hacer y contestar llamadas (Auricular)

Para hacer llamadas de celular

1 Marque el número telefónico. → **[CEL.]**

- Cuando el modo exclusivo para la línea celular está configurado, también puede oprimir **[↶]/[↷]** en lugar de **[CEL.]**.
- Cuando solo hay 1 teléfono celular emparejado, la unidad comienza a marcar.

2 Cuando hay 2 teléfonos celulares emparejados:

[+]: Seleccione el teléfono celular deseado. → **[SELEC.]**

Para hacer llamadas por la línea terrestre

Marque el número telefónico. → **[↶]/[↷]**

Guía Rápida Española

Operaciones básicas

Cómo hacer y contestar llamadas (Auricular)

Para contestar llamadas	[]/[]/[MR]
Para colgar	[OFF]
Para ajustar el volumen del receptor o del altavoz	Oprima [+] o [-] repetidamente mientras habla.
Cómo hacer una llamada usando la lista de remarcación	<p>1 [>] REDIAL → [*]: Seleccione el número telefónico deseado.</p> <p>2 Para hacer una llamada celular: Cuando solo 1 teléfono celular está emparejado: [CEL.] o Cuando 2 teléfonos celulares están emparejados: [CEL.] → [*]: Seleccione el teléfono celular deseado. → [SELEC.] Para hacer una llamada terrestre: []</p>
Para ajustar el volumen del timbre (línea de celular/línea terrestre)	Oprima [+] o [-] repetidamente para seleccionar el volumen deseado mientras timbra.

Cómo hacer y contestar llamadas (unidad base: serie KX-TGE270)

Para hacer llamadas de celular	[CELL 1]/[CELL 2] → Marque el número telefónico. Cuando el modo exclusivo para la línea celular está configurado, también puede oprimir [] en lugar de [CELL 1]/[CELL 2].
Para hacer llamadas por la línea terrestre	[] → Marque el número telefónico.
Para contestar llamadas	[]
Para colgar	[]
Para ajustar el volumen del altavoz	Oprima [+] o [-] repetidamente mientras habla.
Cómo hacer una llamada usando la lista de remarcación	<p>1 Para hacer una llamada celular: [CELL 1]/[CELL 2] Para hacer una llamada terrestre: []</p> <p>2 [REDIAL]</p>
Para ajustar el volumen del timbre (línea de celular/línea terrestre)	Oprima [+] o [-] repetidamente para seleccionar el volumen deseado mientras timbra.

Operaciones básicas

Directorio telefónico (Auricular)

Para añadir entradas	<p>1 [◀] □ → [MENU] 2 [⬆]: “Agregar Ent. Nueva” → [SELEC.] 3 Introduzca el nombre de la persona (máx. 16 caracteres). → [OK] 4 Introduzca el número telefónico de la persona (máx. 24 dígitos). → [OK] 5 [⬆]: Seleccione el grupo deseado. → [SELEC.] 2 veces → [OFF]</p>
Para hacer llamadas	<p>1 [◀] □ → [⬆]: Seleccione la entrada deseada. 2 Para hacer una llamada celular: Cuando solo 1 teléfono celular está emparejado: [CEL.] o Cuando 2 teléfonos celulares están emparejados: [CEL.] → [⬆]: Seleccione el teléfono celular deseado. → [SELEC.] Para hacer una llamada terrestre: [☎]</p>

Contestador de llamadas de la línea terrestre (Unidad base)

Contestador encendido/apagado	Oprima [ANSWER ON/OFF] para encender y apagar el contestador de llamadas.
Para escuchar mensajes	[▶■] (PLAY)

Contestador de llamadas de la línea terrestre (Auricular)

Para escuchar mensajes	<p>Para escuchar mensajes nuevos: [REPRO.] o [MENU]#323 Para escuchar todos los mensajes: [MENU]#324</p>
------------------------	--

Guía Rápida Española

Cómo usar dispositivos Bluetooth

Copiado de entradas del directorio telefónico desde un teléfono celular con Bluetooth (transferencia del directorio telefónico)

Puede copiar entradas del directorio telefónico desde los teléfonos celulares emparejados o desde otros teléfonos celulares (no emparejados) al directorio telefónico de la unidad.

1 Auricular: [MENU] [7] [6] [1] [8]

2 Auricular:

Para copiar desde teléfonos celulares emparejados:

[↕]: Seleccione el teléfono celular deseado. → [SELEC.]

- Los elementos copiados se almacenan en el grupo "Ce1. 1" o "Ce1. 2" en el que está emparejado el teléfono celular.

Para copiar desde otros teléfonos celulares (no emparejados):

[↕]: "Otro celular" → [SELEC.] → [↕]: Seleccione el grupo al que desea copiar. → [SELEC.]

3 Cuando aparezca "Transf. datos del directorio del celular": Vaya al paso 4.

Cuando aparezca el menú "Selec. modo":

[↕]: Seleccione "Auto" o "Manual". → [SELEC.]

"Auto": Descargue todas las entradas del teléfono celular automáticamente. Vaya al paso 5.

"Manual": Copie las entradas que seleccionó.

- El menú "Selec. modo" aparece solo cuando el teléfono celular soporta PBAP (Perfil de Acceso a Directorio Telefónico) para la conexión Bluetooth.

4 Teléfono celular:

Siga las instrucciones de su teléfono celular para copiar las entradas del directorio telefónico.

- Para otros teléfonos celulares (no emparejados), necesita buscar y seleccionar la unidad base. Quizás requiera el NIP de Bluetooth (predeterminado: "0000"). Si su teléfono celular muestra la confirmación de la PassKey en su pantalla, siga las instrucciones para continuar.
- Las entradas que se están copiando aparecen en el auricular.

5 Auricular:

Espere a que aparezca "Completo". → [OFF]

Cómo usar dispositivos Bluetooth

Cómo usar un audífono Bluetooth (opcional) para llamadas por la línea terrestre

Al emparejar un audífono Bluetooth con la unidad base, podrá tener conversaciones inalámbricas a manos libres para llamadas terrestres.

- Solo se pueden usar 2 dispositivos Bluetooth con la unidad al mismo tiempo (por ejemplo, 2 líneas celulares o el audífono y 1 línea celular).

Cómo emparejar un audífono con la unidad base

1 Su audífono:

Configure su audífono en modo de emparejamiento.

- Consulte las instrucciones de operación de su audífono.

2 Auricular:

[MENU] [7] [6] [2] [1]

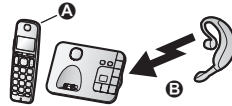

- A** Empareje usando el auricular.
- B** Emparejamiento

3 Si el NIP de su audífono es "0000", vaya al paso 4.

Si el NIP de su audífono es diferente a "0000", oprima [BORRAR] y después introduzca el NIP de su audífono.

- Por lo general, el NIP predeterminado es "0000". Consulte las instrucciones de operación del audífono.

4 Oprima [OK], y después espere a que se emita un pitido largo. → [OFF]

- Cuando el indicador HEADSET de la unidad base se ilumina, usted está listo para usar el audífono.

Cómo operar un audífono inalámbrico con Bluetooth usando una línea terrestre

Consulte las instrucciones de operación de su audífono para ver cómo funciona.

■ Cómo contestar llamadas de la línea terrestre con su audífono

Para contestar una llamada de línea terrestre, encienda su audífono. Para ello, consulte las instrucciones de operación de su audífono.

Cuando termine de hablar, apague su audífono. Para ello, consulte las instrucciones de operación de su audífono.

- Si no puede colgar la llamada usando su audífono:
 - oprima [▶■] (STOP) en la unidad base. (Serie KX-TGE260)
 - oprima [⏏] en la unidad base 2 veces. (Serie KX-TGE270)

■ Cómo cambiar entre la unidad base y su audífono

Puede cambiar entre la unidad base y su audífono:

- durante una llamada por una línea terrestre con el altavoz de la unidad base. (Serie KX-TGE270)
- durante una llamada de intercomunicador entre la unidad base y el auricular. (Serie KX-TGE270)
- mientras escucha los mensajes grabados en el contestador de llamadas de la unidad base.

Para cambiar a su audífono:

Encienda el audífono. Para ello, consulte las instrucciones de operación de su audífono.

Para cambiar a la unidad base (serie KX-TGE270):

Oprima [⏏] en la unidad base.

Guía Rápida Española

Preguntas frecuentes

Pregunta	Causa y solución
¿Por qué aparece Ψ?	<ul style="list-style-type: none"> El auricular está demasiado lejos de la unidad base. Acérquelo. El adaptador para corriente de la unidad base no está conectado correctamente. Conecte de nuevo el adaptador para corriente a la unidad base. El auricular no está registrado en la unidad base. Regístrelo. <ol style="list-style-type: none"> Auricular: [MENU] [#] [1] [3] [0] Unidad base: Oprima y mantenga oprimido [LOCATOR] o [HANDSET LOCATOR] durante aproximadamente 5 segundos. Auricular: Oprima [OK], y después espere hasta que suene un pitido largo.
¿Por qué no es posible emparejar un teléfono celular con la unidad base?	<ul style="list-style-type: none"> Dependiendo de la compatibilidad del teléfono celular, es posible que no pueda emparejarlo con la unidad base. Para obtener más información, visite http://www.panasonic.com/link2cell Confirme que la función de Bluetooth de su teléfono celular esté encendida. Es posible que necesite encender esta función dependiendo de su teléfono celular.
¿Cómo se incrementa el nivel de volumen del auricular?	<ul style="list-style-type: none"> Oprima la tecla de volumen [+] repetidamente mientras habla.
¿Por qué hay ruido o se corta la conversación?	<ul style="list-style-type: none"> Trate de reubicar la unidad base de forma que se minimice la distancia al auricular. Si ocurre el mismo problema aunque el auricular se encuentre enseguida de la unidad base, visite: http://www.panasonic.com/support
¿Es posible añadir otro auricular accesorio a mi unidad base?	<ul style="list-style-type: none"> Sí, puede añadir hasta 6 auriculares (incluyendo los que se venden con su unidad base) a una sola unidad base. Para adquirir auriculares accesorios adicionales (KX-TGEA20), visite: http://www.pstc.panasonic.com Los usuarios TTY (usuarios con impedimentos auditivos o del habla) pueden llamar al 1-866-605-1277.
¿Es posible mantener cargando las baterías todo el tiempo?	<ul style="list-style-type: none"> Puede dejar el auricular en la unidad base o el cargador en cualquier momento. Esto no daña las baterías.
¿Cómo se contestan las llamadas en espera (segunda llamada)?	<ul style="list-style-type: none"> Oprima [CALL WAIT] cuando escuche el tono de llamada en espera.

Customer services

Customer Services Directory (United States and Puerto Rico)

Obtain Product Information and Operating Assistance; locate your nearest Dealer or Service Center; purchase Parts and Accessories; or make Customer Service and Literature requests by visiting our Web Site at:

<http://www.panasonic.com/help>

or, contact us via the web at:

<http://www.panasonic.com/contactinfo>

For hearing or speech impaired TTY users, TTY: 1-877-833-8855

Accessory Purchases (United States and Puerto Rico)

Purchase Parts, Accessories and Owner's Manual online for all Panasonic Products by visiting our Web Site at:

<http://www.pstc.panasonic.com>

or, send your request by E-mail to:

npcparts@us.panasonic.com

You may also contact us directly at:

1-800-237-9080 (Fax Only)

(Monday - Friday 9 am to 9 pm, EST.)

Panasonic National Parts Center

20421 84th Avenue S., Kent, WA 98032

(We accept Visa, MasterCard, Discover Card, American Express.)

For hearing or speech impaired TTY users, TTY: 1-866-605-1277

Appendix

Warranty (For United States and Puerto Rico)

Panasonic Telephone Products Limited Warranty

Limited Warranty Coverage

If your product does not work properly because of a defect in materials or workmanship, Panasonic Corporation of North America (referred to as "the warrantor") will, for the length of the period indicated on the chart below, which starts with the date of original purchase ("Limited Warranty period"), at its option either (a) repair your product with new or refurbished parts, or (b) replace it with a new or a refurbished equivalent value product, or (c) refund your purchase price. The decision to repair, replace or refund will be made by the warrantor.

Parts	Labor
One (1) Year	One (1) Year

During the "Labor" Limited Warranty period there will be no charge for labor. During the "Parts" Limited Warranty period, there will be no charge for parts. You must mail-in your product prepaid during the Limited Warranty period. This Limited Warranty excludes both parts and labor for batteries, antennas, and cosmetic parts (cabinet). This Limited Warranty only applies to products purchased and serviced in the United States or Puerto Rico. This Limited Warranty is extended only to the original purchaser and only covers products purchased as new.

Mail-In Service--Online

Online Repair Request

To submit a new repair request and for quick repair status visit our Web Site at <http://www.panasonic.com/repair>

When shipping the unit carefully pack in a padded shipping carton, include all accessories, and send it prepaid. Include a letter detailing the complaint, a return address and provide a day time phone number where you can be reached. P.O. Boxes are not acceptable. Keep the tracking number for your records. A copy of valid registered receipt is required under the 1 year parts and labor Limited Warranty.

For Limited Warranty service for headsets if a headset is included with this product please follow instructions above.

IF REPAIR IS NEEDED DURING THE LIMITED WARRANTY PERIOD THE PURCHASER WILL BE REQUIRED TO FURNISH A SALES RECEIPT/PROOF OF PURCHASE INDICATING DATE OF PURCHASE, AMOUNT PAID AND PLACE OF PURCHASE. CUSTOMER WILL BE CHARGED FOR THE REPAIR OF ANY UNIT RECEIVED WITHOUT SUCH PROOF OF PURCHASE.

Limited Warranty Limits And Exclusions

This Limited Warranty ONLY COVERS failures due to defects in materials or workmanship, and DOES NOT COVER normal wear and tear or cosmetic damage. The Limited Warranty ALSO DOES NOT COVER damages which occurred in shipment, or failures which are caused by products not supplied by the warrantor, or failures which result from accidents, misuse, abuse, neglect, bug infestation, mishandling, misapplication, alteration, faulty installation, set-up adjustments, misadjustment of consumer controls, improper maintenance, power line surge, lightning damage, modification, introduction of sand, humidity or liquids, commercial use such as hotel, office, restaurant, or other business or rental use of the product, or service by anyone other than a Factory Service Center or other Authorized Servicer, or damage that is attributable to acts of God.

THERE ARE NO EXPRESS WARRANTIES EXCEPT AS LISTED UNDER "LIMITED WARRANTY COVERAGE". THE WARRANTOR IS NOT LIABLE FOR INCIDENTAL OR CONSEQUENTIAL DAMAGES RESULTING FROM THE USE OF THIS PRODUCT, OR ARISING OUT OF ANY BREACH OF THIS LIMITED WARRANTY. (As examples, this excludes damages for lost time, lost calls or messages, cost of having someone remove or re-install an installed unit if applicable, travel to and from the servicer. The items listed are not exclusive, but are for illustration only.) **ALL EXPRESS AND IMPLIED WARRANTIES, INCLUDING THE WARRANTY OF MERCHANTABILITY, ARE LIMITED TO THE PERIOD OF THE LIMITED WARRANTY.**

Some states do not allow the exclusion or limitation of incidental or consequential damages, or limitations on how long an implied warranty lasts, so the exclusions may not apply to you.

This Limited Warranty gives you specific legal rights and you may also have other rights which vary from state to state. If a problem with this product develops during or after the Limited Warranty period, you may contact your dealer or Service Center. If the problem is not handled to your satisfaction, then write to the warrantor's Consumer Affairs Department at the addresses listed for the warrantor.

PARTS AND SERVICE, WHICH ARE NOT COVERED BY THIS LIMITED WARRANTY, ARE YOUR RESPONSIBILITY.

When you ship the product

- Carefully pack your unit, preferably in the original carton.
- Attach a letter, detailing the symptom.
- Send the unit to Panasonic Exchange Center, prepaid and adequately insured.
- Do not send your unit to Panasonic Corporation of North America listed on the back cover or to executive or regional sales offices. These locations do not repair consumer products.

Index

Index

- # 3-way conference: 25, 29
- A** Additional handset: 48
 - Alarm: 44
 - Answering calls: 23, 28
 - Answering system
 - Call screening: 61
 - Erasing messages: 57, 58, 60
 - Greeting message: 56
 - Greeting only: 61
 - Listening to messages: 57, 60
 - New message alerting: 58
 - Number of rings: 61
 - Recording time: 61
 - Remote access code: 60
 - Remote operation: 60
 - Ring count: 61
 - Toll saver: 61
 - Turning on/off: 56
 - Auto talk: 23, 43
- B** Battery: 11, 12
 - Bluetooth wireless technology
 - Cellular phone (Link to cell): 18
 - Headset: 54
 - Phonebook transfer: 52
 - Booster (Clarity booster): 24
- C** Call block: 46
 - First ring: 47
 - Call share: 24, 29, 43
 - Call waiting: 24, 29
 - Call Waiting Caller ID: 24
 - Caller ID number auto edit: 43, 50
 - Caller ID service: 49
 - Caller list: 49
 - Caller list edit: 50
 - Cell locator: 31
 - Cellular calls: 22, 28
 - Cellular phone
 - Pairing: 18
 - Unpairing: 18
 - Chain dial: 35
 - CID (Caller ID): 49, 50
 - Conference calls: 25, 29
 - Control type: 13
 - Customer support: 43
- D** Date and time: 16
 - Dialing mode: 17
 - Direct command code: 37
- Display
 - Contrast: 42
 - Language: 16
- E** Eco mode: 12
 - Equalizer: 24
 - Error messages: 67
- F** Flash: 24, 29, 43
- G** Groups: 34
- H** Handset
 - Deregistration: 48
 - Locator: 31
 - Name: 47
 - Registration: 48
- Hold: 23, 29
- I** Intercom: 31
- K** Key detector: 42, 43
 - Key tone: 42
- L** Landline calls: 22, 28
 - Line mode: 43
 - Link to cell
 - Area code: 21
 - Auto connection: 19
 - Cellular line only mode: 20
 - Cellular line selection: 21
 - Connection: 20
 - Ring as cell mode: 19
 - Select unit to ring: 19
 - Text message (SMS: Short Message Service) alert: 53
- M** Making calls: 22, 28
 - Missed calls: 49
 - Mute: 23, 29
- N** Noise reduction: 24
- P** Pause: 23, 28
 - Phonebook: 33
 - PIN: 21
 - Power failure (power back-up operation): 26
- R** Redialing: 22, 28
 - Ringer ID: 34
 - Ringer tone: 39, 41
 - Rotary/pulse service: 24
- S** Silent mode: 45
 - Smart function key (NR key): 16
 - Speed dial: 36
 - SP-PHONE (Speakerphone): 22
- T** Talking Caller ID: 49
 - Temporary tone dialing: 24, 29
 - Time adjustment: 41
 - Transferring calls: 25, 29



Index

- Troubleshooting: 68
- TTY: 89
- V** VM (Voice mail): 63
- Voice guidance language: 16
- Voice mail: 61, 63
- Volume
 - Receiver: 22
 - Ringer (Base unit): 29, 39, 41
 - Ringer (Handset): 23, 39, 41
 - Speaker: 22, 28
- W** Wall mounting: 64



Notes

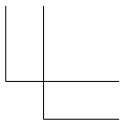
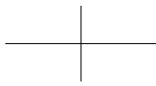
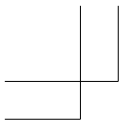

Notes

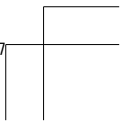
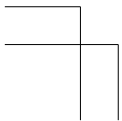
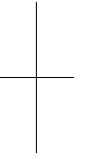
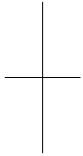

IMPORTANT!

If your product is not working properly. . .

- ① **Reconnect AC adaptor to the base unit.**
- ② **Check if telephone line cord is connected.**
- ③ **Use rechargeable Ni-MH batteries.**
(Alkaline/Manganese/Ni-Cd batteries CANNOT be used.)
- ④ Read **troubleshooting** page in the **Operating Instructions**.



Visit our Web site: <http://www.panasonic.com/help>

- **FAQ and troubleshooting hints are available.**

For your future reference

We recommend keeping a record of the following information to assist with any repair under warranty.

Serial No. (found on the bottom of the base unit)	Date of purchase
Name and address of dealer	
Attach your purchase receipt here.	

Panasonic Corporation of North America

Two Riverfront Plaza, Newark, NJ 07102-5490

© Panasonic System Networks Co., Ltd. 2013

Printed in Malaysia



PNQX6366YA

PNQX6366YA TT1113WK1015