

Panasonic®

Operating Instructions

2-in-1 Corded | Cordless Phone

Model No. **KX-TGB850**

KX-TGB852

KX-TG2153SK



Model shown is KX-TGB850.

Before initial use, see “Getting Started” on page 8.

Thank you for purchasing a Panasonic product.

Please read these operating instructions before using the unit and save them for future reference.

Consulte “Guía Rápida Española”, página 37.

For assistance, visit our Web site: <http://shop.panasonic.com/support> for customers in the U.S.A.

Please register your product: <http://shop.panasonic.com/support>

Introduction

Model composition.....	3
Accessory information	3
Graphical symbols for use on equipment and their descriptions	4

Important Information

For your safety.....	5
Important safety instructions.....	6
For best performance	6
Other information.....	7
Specifications	7

Getting Started

Setting up	8
Note when setting up.....	9
Controls	10
Navigating the menus.....	12
Date and time	12
Other settings	12
Menu Map.....	13

Making and Answering Calls

Making calls.....	14
Answering calls.....	15
Useful features during a call.....	15
Intercom, transferring calls and conference calls.....	16
Handset locator	17

Phonebook

Phonebook	18
Speed dial.....	19

Caller ID Service

Using Caller ID service.....	21
Caller list.....	21

Programming

Personal settings	23
Advanced settings	25

Answering System

Answering system	29
Turning the answering system on/off.....	29
Greeting message	29
Listening to messages.....	30

Useful Information

Voicemail service.....	33
Wall mounting.....	33
Troubleshooting.....	34
FCC and other information	35

Guía Rápida Española

Guía Rápida Española	37
----------------------------	----

Appendix

Customer services.....	43
Limited Warranty (ONLY FOR U.S.A.).....	44

Index

Index.....	46
------------	----

Model composition

Series	Model No.	Base unit	Handset	
		Part No.	Part No.	Quantity
KX-TGB850 series	KX-TGB850	KX-TGB850	KX-TGBA85	1
	KX-TGB852	KX-TGB850	KX-TGBA85	2
	KX-TG2153SK	KX-TGB850	KX-TGBA85	3

Accessory information

Supplied accessories

No.	Accessory item/Part number	Quantity		
		KX-TGB850	KX-TGB852	KX-TG2153SK
①	AC adaptor/PNWHYAB810S00	2	3	4
②	Telephone line cord/PNJA1186Z	1	1	1
③	Desk stand ^{*1} /PNWHYAB850B01	1	1	1
④	Corded handset/PNWHYAB850B00	1	1	1
⑤	Corded handset cord/ PQJA212V	1	1	1
⑥	Rechargeable batteries ^{*2}	2	4	6
⑦	Handset cover ^{*3} /PNWHYAB810S01	1	2	3
⑧	Charger/PNWHYAB810S02	1	2	3

^{*1} The desk stand comes attached to the base unit.

^{*2} See below for replacement battery information.

^{*3} The handset cover comes attached to the handset.



Additional/replacement accessories

Please contact your nearest Panasonic dealer for sales information (page 43).

Accessory item	Model number/Specification
Rechargeable batteries	HHR-4DPA ^{*1}
	<ul style="list-style-type: none"> ● To order, please visit http://shop.panasonic.com/support Battery type: <ul style="list-style-type: none"> – Nickel metal hydride (Ni-MH) – 2 x AAA (R03) size for each handset

^{*1} Replacement batteries may have a different capacity from that of the supplied batteries.

Other information

- Design and specifications are subject to change without notice.
- The illustrations in these instructions may vary slightly from the actual product.

Expanding your phone system













You can expand your phone system by registering optional handsets (4 max.) to a single base unit.

- Optional handsets may be a different color from that of the supplied handsets.
- To order, please visit <http://shop.panasonic.com/support>

Handset (optional): KX-TGBA85



Graphical symbols for use on equipment and their descriptions

Symbol	Explanation	Symbol	Explanation
	Alternating current (A.C.)		Class II equipment (equipment in which protection against electric shock relies on Double Insulation or Reinforced Insulation)
	Direct current (D.C.)		"ON" (power)
	Protective earth		"OFF" (power)
	Protective bonding earth		Stand-by (power)
	Caution: risk caused by visible radiation		"ON"/"OFF" (power; push-push)
	For indoor use only		Caution, risk of electric shock

For your safety

To prevent severe injury and loss of life/property, read this section carefully before using the product to ensure proper and safe operation of your product.

WARNING

Power connection

- Use only the power source marked on the product.
- Do not overload power outlets and extension cords. This can result in the risk of fire or electric shock.
- Completely insert the AC adaptor/power plug into the power outlet. Failure to do so may cause electric shock and/or excessive heat resulting in a fire.
- Regularly remove any dust, etc. from the AC adaptor/power plug by pulling it from the power outlet, then wiping with a dry cloth. Accumulated dust may cause an insulation defect from moisture, etc. resulting in a fire.
- Unplug the product from power outlets if it emits smoke, an abnormal smell, or makes an unusual noise. These conditions can cause fire or electric shock. Confirm that smoke has stopped emitting and contact us at <http://shop.panasonic.com/support>
- Unplug from power outlets and never touch the inside of the product if its casing has been broken open.
- Never touch the plug with wet hands. Danger of electric shock exists.

Installation

- To prevent the risk of fire or electrical shock, do not expose the product to rain or any type of moisture.
- Do not place or use this product near automatically controlled devices such as automatic doors and fire alarms. Radio waves emitted from this product may cause such devices to malfunction resulting in an accident.
- Do not allow the AC adaptor or telephone line cord to be excessively pulled, bent or placed under heavy objects.

Operating safeguards

- Unplug the product from power outlets before cleaning. Do not use liquid or aerosol cleaners.
- Do not disassemble the product.
- Do not spill liquids (detergents, cleansers, etc.) onto the telephone line cord plug, or allow it to become wet at all. This may cause a fire. If the telephone line cord plug becomes wet, immediately pull it from the telephone wall jack, and do not use.
- Do not place the corded or cordless handset in the base unit when battery cover is removed.

Medical

- Consult the manufacturer of any personal medical devices, such as pacemakers or hearing aids, to determine if they are adequately shielded from external RF (radio frequency) energy. (The product operates in the frequency range of 1.92 GHz to 1.93 GHz, and the RF transmission power is 115 mW (max.).)
- Do not use the product in health care facilities if any regulations posted in the area instruct you not to do so. Hospitals or health care facilities may be using equipment that could be sensitive to external RF energy.

CAUTION

Installation and location

- Never install telephone wiring during an electrical storm.
- Never install telephone line jacks in wet locations unless the jack is specifically designed for wet locations.
- Never touch uninsulated telephone wires or terminals unless the telephone line has been disconnected at the network interface.
- Use caution when installing or modifying telephone lines.
- The AC adaptor is used as the main disconnect device. Ensure that the AC outlet is installed near the product and is easily accessible.
- The product is only use for mounting at heights ≤ 2 m.

Note:

- This height is not guaranteed for product reliability.
- To prevent serious injuries due to the product unexpectedly falling, the product must be installed at a height of 1.5 m or lower.
- This product is unable to make calls when:
 - the handset batteries need recharging or have failed.
 - there is a power failure.

Battery

- We recommend using the batteries noted on page 3. **USE ONLY rechargeable Ni-MH batteries AAA (R03) size.**
- Do not mix old and new batteries.
- Do not open or damage the batteries. Released electrolyte from the batteries is corrosive and may cause burns or injury to the eyes or skin. The electrolyte is toxic and may be harmful if swallowed.
- Exercise care when handling the batteries. Do not allow conductive materials such as rings, bracelets, or keys to touch the batteries, otherwise a short circuit may cause the batteries and/or the conductive material to overheat and cause burns.
- Charge the batteries provided with or identified for use with this product only, in accordance with the instructions and limitations specified in this manual.
- Only use a compatible charger to charge the batteries. Do not tamper with the charger. Failure to follow these instructions may cause the batteries to swell or explode.
- Avoid the use in the following conditions
 - High or low extreme temperatures during use, storage or transportation.
 - Replacement of a battery with an incorrect type that can defeat a safeguard.
 - Disposal of a battery into fire or a hot oven, or mechanically crushing or cutting of a battery, that can result in an explosion.
 - Extremely high temperature and/or extremely low air pressure that can result in an explosion or the leakage of flammable liquid or gas.

Attention:



A nickel metal hydride battery that is recyclable powers the product you have purchased. Please call 1-800-8-BATTERY (1-800-822-8837) for information on how to recycle this battery.

Important safety instructions

When using your product, basic safety precautions should always be followed to reduce the risk of fire, electric shock, and injury to persons, including the following:

1. Do not use this product near water for example, near a bathtub, washbowl, kitchen sink, or laundry tub, in a wet basement or near a swimming pool.
2. Avoid using a telephone (other than a cordless type) during an electrical storm. There may be a remote risk of electric shock from lightning.
3. Do not use the telephone to report a gas leak in the vicinity of the leak.
4. Use only the power cord and batteries indicated in this manual. Do not dispose of batteries in a fire. They may explode. Check with local codes for possible special disposal instructions.

SAVE THESE INSTRUCTIONS

For best performance

Base unit location/avoiding noise

The base unit and other compatible Panasonic units use radio waves to communicate with each other.

- For maximum coverage and noise-free communications, place your base unit:
 - at a convenient, high, and central location with no obstructions between the handset and base unit in an indoor environment.
 - away from electronic appliances such as TVs, radios, personal computers, wireless devices, or other phones.

– facing away from radio frequency transmitters, such as external antennas of mobile phone cell stations. (Avoid putting the base unit on a bay window or near a window.)

- Coverage and voice quality depends on the local environmental conditions.
- If the reception for a base unit location is not satisfactory, move the base unit to another location for better reception.

Environment

- Keep the product away from electrical noise generating devices, such as fluorescent lamps and motors.
- The product should be kept free from excessive smoke, dust, high temperature, and vibration.
- The product should not be exposed to direct sunlight.
- Do not place heavy objects on top of the product.
- When you leave the product unused for a long period of time, unplug the product from the power outlet.
- The product should be kept away from heat sources such as heating devices, cooking appliances, etc. It should not be placed in rooms where the temperature is less than 0°C (32°F) or greater than 40°C (104 °F). Damp basements should also be avoided.
- The maximum calling distance may be shortened when the product is used in the following places: Near obstacles such as hills, tunnels, underground, near metal objects such as wire fences, etc.
- Operating the product near electrical appliances may cause interference. Move away from the electrical appliances.

Routine care

- **Wipe the outer surface of the product with a soft moist cloth.**
- Do not use benzine, thinner, or any abrasive powder.

Other information

- The applied nameplate is located at the bottom or rear of the product.
- **CAUTION:** Risk of explosion if battery is replaced by an incorrect type. Dispose of used batteries according to the instructions.

Notice for product disposal, transfer, or return

- This product can store your private/confidential information. To protect your privacy/confidentiality, we recommend that you erase information such as phonebook or caller list entries from the memory before you dispose of, transfer, or return the product.

Notice

- This product is designed for use in the United States of America. Sale or use of this product in other countries may violate local laws.
- Cet appareil est conçu pour être utilisé aux États-Unis d'Amérique. La vente ou l'emploi de cet appareil dans certains autres pays peut constituer une infraction à la législation locale.
- Este producto está diseñado para usarse en los Estados Unidos de América. La venta o el empleo de este producto en ciertos países puede constituir violación de la legislación local.
- 本產品專為美國使用而設。若在其他國家銷售或使用，可能會違反當地法例。
- この製品は、日本国外での使用を目的として設計されており、日本国内での使用は法律違反となります。従って、当社では日本国内においては原則として修理などのサービスは致しかねます。

Specification

- **Frequency range:**
1.92 GHz to 1.93 GHz
- **RF transmission power:**
115 mW (max.)
- **Power source:**
100–240 V AC, 50/60 Hz
- **Power consumption**
Base unit:
Standby: 0.81 W
Maximum: 1.97 W
Charger:
Standby: 0.03 W
Maximum: 0.9 W
- **Operating conditions:**
0°C – 40°C (32°F – 104°F), 20% – 80% relative air humidity (dry)

Setting up

Connections

Base unit

- 1 Connect the AC adaptor to the unit by pressing the plug firmly.
- 2 Connect the telephone line cord to the unit until you hear a click.
- 3 Fasten the AC adaptor cord and the telephone line cord by hooking it.
- 4 Connect the AC adaptor to the power outlet.
- 5 Connect the telephone line cord to the single-line telephone jack (RJ11C) until you hear a click.
- 6 A DSL/ADSL filter (not supplied) is required if you have a DSL/ADSL service.
- 7 Connect the corded handset cord to the corded handset and the base unit until you hear a click.

Note:

Use only the supplied AC adaptor MN0063-L060040.

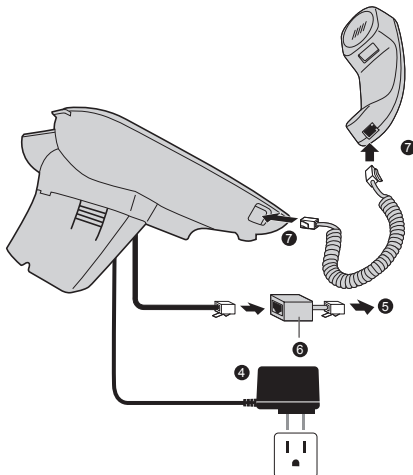
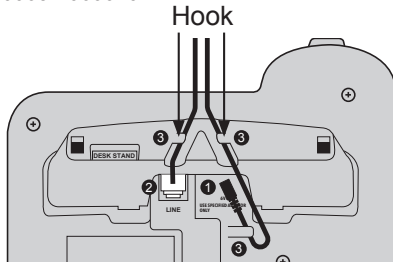

Charger

- 1 Connect the AC adaptor to the unit by pressing the plug firmly.
- 2 Fasten the cord by hooking it.
- 3 Connect the AC adaptor to the power outlet.

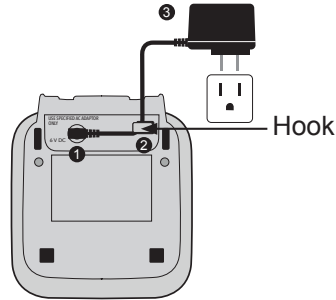

Note:

Use only the supplied AC adaptor MN0063-L060040.

Battery installation

- 1 Press down at ①.
 - 2 Slide the handset cover ②.
 - 3 Insert the batteries, then close the handset cover.
- USE ONLY rechargeable Ni-MH batteries AAA (R03) size (A).
 - Do NOT use alkaline/manganese/Ni-Cd batteries.
 - Confirm correct polarities.

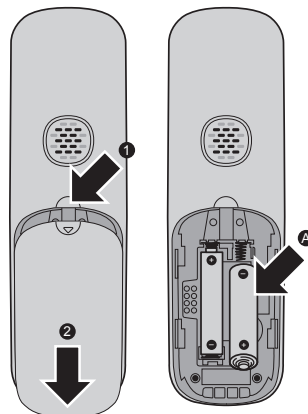

Battery charging

Charge for at least 7 hours.

When the handset needs charging, the display shows “**Low battery**” and there is a warning beep every 2 minutes during a call, recharge the handset before using it again. When charging,  will scroll on the display.



Note when setting up

Note for connections

- The AC adaptor must remain connected at all times. (It is normal for the adaptor to feel warm during use.)
- The AC adaptor should be connected to a vertically oriented or floor-mounted AC outlet. Do not connect the AC adaptor to a horizontally oriented AC outlet that faces the floor, such as an AC outlet installed on a ceiling or under a table, as the weight of the adaptor may cause it to become disconnected.

Power failure

The base unit will work as a standard telephone using power from the telephone line, so you can make and answer outside calls with the corded handset. However, this operation may not work properly depending on area or telephone line's condition. The base unit speakerphone and the cordless handset will not function during a power failure.





Note for battery installation

- Use the supplied rechargeable batteries. For replacement, we recommend using the rechargeable batteries noted on page 3 and 6.

Note for battery charging

- It is normal for the handset to feel warm during charging.
- Clean the charge contacts of the handset and charger with a soft and dry cloth once a month. Before cleaning the unit, disconnect from power outlets and any telephone line cords. Clean more often if the unit is exposed to grease, dust, or high humidity.

Battery level

Icon	Battery level
	Battery is fully charged
	Battery is partially charged
	Battery is running low
	Battery is almost fully discharged

Ni-MH battery performance (supplied batteries)

Operation	Operating time
In continuous use	14 hours max.
Not in use (standby)	200 hours max.

Note:

- Actual battery performance depends on usage and ambient environment.

Controls

Handset

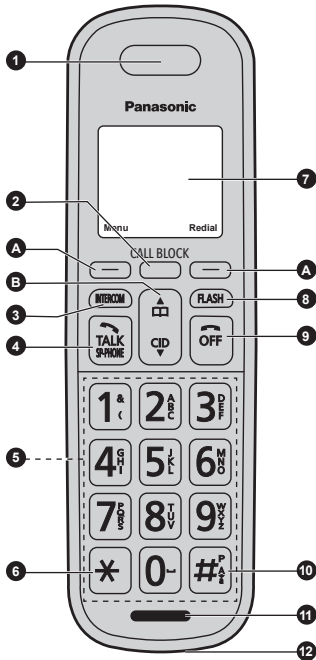





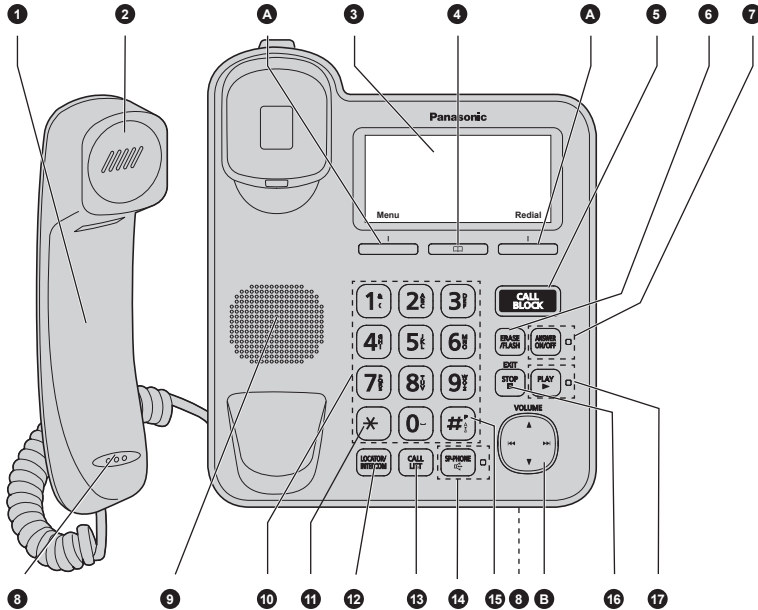







1	Receiver
2	Call block Short cut to call block menu, page 25.
3	Intercom Press to make intercom call and transfer calls to the base unit or another handset.
4	Talk/Speakerphone Press to make and receive calls. During a call, press to turn speakerphone on and off.
5	Dial keypad/Speed dial buttons 1 to 9 Press and hold to dial the stored entry, page 20.
6	* / Pulse to Tone dialing Dial a star, page 19. During a call, press to switch from pulse dialing to tone dialing, page 15.
7	Display See page 12 for an overview of the display icons.
8	Flash Press to use with switchboard/PBX services and some network services.
9	Off Press to end a call.
10	# / Change case/Pause Dial a #. Press and hold to change the case from abc to abc or ABC mode when entering or editing letters, page 18. Press and hold to enter a pause when pre-dialing or storing numbers, page 15.
11	Microphone
12	Charge contacts
A	Soft keys By pressing a soft key, you can select the feature shown directly above it on the display.
B	Navigator key  <ul style="list-style-type: none"> - [▲] □: View the phonebook list. - [▼] CID (Caller ID): View the caller list. - [▲] or [▼]: Scroll through various lists or items. - Volume ([▲] or [▼]): Adjust the receiver or speaker volume while talking. - [▲] or [▼]: Move the cursor to edit a number or name.

Base unit



1	Corded handset	13	Call list Press to enter the caller list, page 21.
2	Receiver		SP-PHONE (Speakerphone)
3	Display See page 12 for an overview of the display icons.	14	SP-PHONE indicator Press to make and receive calls.
4	Phonebook View the phonebook list, page 18.		##/Change case/Pause Dial a # . Press and hold to change the case from abc to ABC mode when entering or editing letters, page 18. Press and hold to enter a pause when pre-dialing or storing numbers, page 15.
5	Call block Short cut to call block menu, page 25.	15	Exit/Stop Press to go back to standby mode. Press to stop playback message, page 30.
6	Erase/Flash Press to delete currently playing message, page 30. Press to use with switchboard/PBX services and some network services	16	Play Play/Message indicator Press to play the message, page 30.
7	Answer On/Off Answer On/Off Indicator Press to turn on/off the answering system.		Soft keys A By pressing a soft key, you can select the feature shown directly above it on the display.
8	Microphone		Navigator key [▲] or [▼] : Scroll through various lists or items. [▲] or [▼] : Adjust the receiver or speaker volume while talking.
9	Speaker		B [▲] or [▼], [◀] or [▶] : Move the cursor to edit a number or name. [◀] or [▶] : Repeat/skip messages during playback
10	Dial keypad Speed dial buttons 1 to 9 Press and hold to dial the stored entry, page 20.		
11	* / Pulse to Tone dialing Dial a star, page 19. During a call, press to switch from pulse dialing to tone dialing, page 15.		
12	Locator/Intercom Use to locate a misplaced handset. Press to make intercom call and transfer calls to the handset.		

Display icons

Item	Meaning
 *1	Indicates a received call
 *1	Indicates an outgoing call
	Flashes to indicate a new missed call and when viewing a new missed call in the caller list Steady when viewing a missed call in the caller list
 *1, *2	Indicates a blocked number
 *1	Flashes when receiving an incoming call Steady when the phone is off hook
 *1	Speakerphone is activated
	Ringer volume is off
 *3	Flashes to indicate new voicemail messages received Steady when the entry has been viewed in the caller list
	Flashes when recording a new message Steady when answering system is on
 *1	Silent mode is on
 *1	Out of base unit range
 *1	Range status: The more bars visible, the closer the handset is to the base unit.
 *1	Alarm is on

*1 Handset only.

*2 Caller ID subscribers only.

*3 Voice mail subscribers only.

Navigating the menus

The phone has an easy to use menu system. Each menu has a list of options, which can be seen on the menu map on page 13.

When the handset and base unit are in standby:

- 4 **[Menu]** to open the main menu.
- 5 **[↔]**: → available options.
- 6 **[OK]** to select an option.
- 7 To return to the previous menu level, press **[Back]**.
- 8 To exit the menu and return to standby, press **[OFF]** on the handset or **[EXIT/STOP]** on the base unit.

Note:

If no buttons are pressed for 30 seconds, the handset and base unit returns to standby automatically.

Date and time

Handset

- 1 **[Menu]**, → **[▼]** “Personal set”, press **[OK]**.
- 2 **[▼]** “Date & time”.
- 3 **[OK]** to select.
- 4 Enter the current month, date, and year using the keypad (e.g. **[0][7][1][2][2][0]** for July 12, 2020), press **[OK]** to confirm.
- 5 Enter the current time using the keypad (e.g. **[0][9][3][0]** for 09:30), then press **[↔]** to select “AM” or “PM” and press **[OK]** to save.

Other settings

Dial mode

If you cannot make calls, change this setting according to your telephone line service. The default setting is “Tone”, to change this setting, see page 26.

“Tone”: For tone dial service.

“Pulse”: For rotary/pulse dial service.

Menu Map

Base unit

Phonebook	<ul style="list-style-type: none"> - View - Add new - Edit - Delete^{*1} - Delete all^{*1}
Personal set	<ul style="list-style-type: none"> - Sounds <ul style="list-style-type: none"> - Ring volume - Key tone - Language
Advanced set	<ul style="list-style-type: none"> - Call block <ul style="list-style-type: none"> - Unknown call - Block list <ul style="list-style-type: none"> - <i>Block mode</i> - <i>Block number</i> - Area code - Flash time - Dial mode - Auto clock - Change PIN - Deregister^{*2} - Reset
Answ. machine	<ul style="list-style-type: none"> - On/off - Play all - Record memo - Delete all - Outgoing msg. <ul style="list-style-type: none"> - Record also - Answer only - Ring count - Remote access - TAM language

^{*1} Only available if a phonebook entry is stored.

^{*2} This feature is not available for single handset model.

Handset

Phonebook	<ul style="list-style-type: none"> - View - Add new - Edit - Delete^{*1} - Delete all^{*1}
Personal set	<ul style="list-style-type: none"> - Sounds <ul style="list-style-type: none"> - Ring volume - Ring tones - Silent mode - Key tone - Docking tone - Battery tone - Handset name - Date & time - Language - Auto answer - Auto hang-up
Alarm	<ul style="list-style-type: none"> - Off - On once - On daily
Advanced set	<ul style="list-style-type: none"> - Call block <ul style="list-style-type: none"> - Unknown call - Block list <ul style="list-style-type: none"> - <i>Block mode</i> - <i>Block number</i> - Area code - Flash time - Dial mode - Auto clock - Change PIN - Register - Deregister^{*2} - Reset
Answ. machine	<ul style="list-style-type: none"> - On/off - Play all - Record memo - Delete all - Outgoing msg. <ul style="list-style-type: none"> - Record also - Answer only - Ring count - Remote access - TAM language

Making calls

Using the handset

- 1 Lift the handset and dial the phone number.
 - To correct a digit, press **[Clear]**.
- 2 **[TALK/SP-PHONE]**.
 - To make the call using the speakerphone, press **[TALK/SP-PHONE]**.
- 3 When you finish talking, press **[OFF]** or place the handset on the charger.

Note:

- While talking, you can switch between the receiver and the speakerphone by pressing **[TALK/SP-PHONE]**.
- In step 1, you can store the dialed phone number to the phonebook by pressing **[Save]**.

Auto hang-up: You can end a call simply by placing the handset on the charger (page 24).

Making a call using the redial list

The last 10 phone numbers dialed are stored in the redial list in each unit (each 24 digits max.).

- 1 **[Redial]**.
- 2 **[↕]**: Select the desired entry.
- 3 **[TALK/SP-PHONE]**.

Deleting an entry or all entries in the redial list

- 1 **[Redial]**.
- 2 **[↕]**: Select the desired entry, press **[OK]**.
- 3 **[OK]**, → **[▼]** “Delete” or “Delete all”.
- 4 **[OK]**. “Confirm?”.
- 5 **[OK]** to confirm or **[Back]** to cancel.

Using the base unit

- 1 Dial the phone number.
 - To correct a digit, press **[Clear]**.
- 2 Lift the corded handset.
- 3 When you finish talking, place the corded handset on the cradle.

Note:

You can also dial the phone number after lifting the corded handset.

Using the speakerphone

- 1 During a conversation with the corded handset, press **[SP-PHONE]** to turn on the speakerphone.
 - You can place the corded handset on the cradle.
 - Speak into the base unit microphone.
 - Speak alternately with the other party.
- 2 When you finish talking, press **[SP-PHONE]**.

Note:

- For best performance, use the speakerphone in a quiet environment.
- To switch to the receiver, lift the corded handset.

Making a call using the redial list

The last 10 phone numbers dialed are stored in the redial list (each 24 digits max.).

- 1 **[Redial]**.
- 2 **[↕]**: Select the desired entry.
- 3 Lift the corded handset or press **[SP-PHONE]**.

Deleting an entry or all entries in the redial list

- 1 **[Redial]**.
- 2 **[↕]**: Select the desired entry, press **[OK]**.
- 3 **[OK]**, → **[▼]** “Delete” or “Delete all”.
- 4 **[OK]**. “Confirm?”.
- 5 **[OK]** to confirm or **[Back]** to cancel.

Adjusting the receiver or speaker volume

Handset / Base unit

[↕] repeatedly while talking.

Pause (for PBX/long distance service users)

A pause is sometimes required when making calls using a PBX or long distance service. When storing a calling card access number and/or PIN in the phonebook, a pause is also needed.

Example: If you need to dial the line access number “9” when making outside calls with a PBX:

Handset

- 1 **[9]** → press and hold **[#]**. “P” (Pause) will be displayed.
- 2 Dial the phone number. → **[TALK/SP-PHONE]**.

Base unit

- 1 **[9]** → press and hold **[#]**. “P” (Pause) will be displayed.
- 2 Dial the phone number.
- 3 Lift the corded handset.

Note for handset and base unit:

- A 3.5 second pause is inserted each time you press and hold **[#]** (Pause).

Answering calls

Using the handset

- 1 Lift the handset and press **[TALK/SP-PHONE]** when the unit rings.
- 2 When you finish talking, press **[OFF]** or place the handset on the charger.

Auto answer: You can answer calls simply by lifting the handset off the charger. You do not need to press **[TALK/SP-PHONE]**. To turn this feature on, see page 24.

Temporary ringer off: You can turn the ringer off temporarily by pressing **[Silent]** (right soft key).

Using the base unit

When a call is being received, the SP-PHONE indicator flashes.

- 1 Lift the corded handset or press **[SP-PHONE]** when the unit rings.
- 2 When you finish talking, place the corded handset on the cradle. When the speakerphone is used, press **[SP-PHONE]**.

Temporary ringer off: You can turn the ringer off temporarily by pressing **[Silent]** (right soft key).

Adjusting the ringer volume

Handset / Base unit

[↕] repeatedly to select the desired volume while ringing.

Useful features during a call

Mute

Handset / Base unit

- 1 **[Mute]** during a call. “Mute on”.
- 2 To return to the call, press **[Mute]**.

Flash

Handset / Base unit

Pressing **[FLASH]** on the handset or **[ERASE/FLASH]** on the base unit allows you to use the special features of your host PBX such as transferring an extension call, or accessing optional telephone services.

Note:

- To change the flash time, see page 26.

For call waiting or Call Waiting Caller ID service users

To use call waiting or Call Waiting Caller ID, you must first subscribe with your phone service provider.

This feature allows you to receive calls while you are already talking on the phone. If you receive a call while on the phone, you will hear a call waiting tone.

If you subscribe to both Caller ID and Call Waiting with Caller ID services, the 2nd caller's information is displayed on the handset that is in use after you hear the call waiting tone.

Handset / Base unit

- 1 Press **[FLASH]** on the handset or **[ERASE/FLASH]** on the base unit to answer the 2nd call.
- 2 To switch between calls, press **[FLASH]** on the handset or **[ERASE/FLASH]** on the base unit.

Temporary tone dialing (for rotary/pulse service users)

Handset / Base unit

Press **[*]** before entering access numbers which require tone dialing.

Handset equalizer

This feature clarifies the voice of the person you are talking to, producing a more natural-sounding voice that is easier to hear and understand.

You can choose from “Treble”, “Alto” or “Bass”.

- 1 Press **[Options]** while talking.
- 2 **[▼]** “Equalizer”, press **[OK]**.
- 3 **[▲]** Select the desired setting, press **[OK]**.

Note:

- Depending on the condition and quality of your telephone line, this feature may emphasise existing line noise.
- If it becomes difficult to hear, you can change the setting.
- This feature is not available while using the speakerphone.

Intercom, transferring calls and conference calls

Making an intercom call

Intercom calls can be made:

- between handsets
- between a handset and the base unit

Handset

- 1 If only one handset is registered to the base unit, press **[INTERCOM]** and the base unit rings automatically.
- 2 If 2 or more handsets are registered to the base unit, press **[INTERCOM]** → **[▼]** to select the handset / base unit that is to be called, press **[OK]**.

Base unit

- 1 If only one handset is registered to the base unit, press **[LOCATOR/INTERCOM]**, the handset rings automatically.
Lift the corded handset if needed.
- 2 If 2 or more handsets are registered to the base unit, press **[LOCATOR/INTERCOM]**, → **[▼]** to select the handset that is to be called, press **[OK]**.
Lift the corded handset if needed.

Receiving an intercom call

Handset

When an intercom call is received, base unit or the handset number that is calling is displayed.

- 1 **[TALK/SP-PHONE]** to answer the call.

Base unit

When an intercom call is received, the handset number that is calling is displayed.

- 1 Lift the corded handset to answer the call.

Transferring calls

Outside calls can be transferred or a conference call with an outside party can be made:

- between handsets
- between a handset and the base unit

During an outside call:

Handset

- 1 If only one handset is registered to the base unit, press **[INTERCOM]** and the base unit rings automatically.
- 2 If 2 or more handsets are registered to the base unit, press **[INTERCOM]** → **[▼]** to select the handset / base unit that is to be called, press **[OK]**.
- 3 When the other handset or base unit answers, press **[OFF]** to complete the transfer.

Base unit

- 1 If only one handset is registered to the base unit, press **[LOCATOR/INTERCOM]** and the handset rings automatically.
- 2 If 2 or more handsets are registered to the base unit, press **[LOCATOR/INTERCOM]** → **[▼]** to select the handset that is to be called, press **[OK]**.
- 3 When the handset answers, place the corded handset on the cradle to complete the transfer.

Note:

If there is no answer from the other handset / base unit, press **[INTERCOM]** on the handset or **[LOCATOR/INTERCOM]** on the base unit to return to the outside caller. The outside call resumes automatically after 60 seconds if there is no answer.

3-way conference call

To hold a 3-way conference call between 2 intercom callers and 1 outside caller.

During an outside call:

Handset

- 1 If only one handset is registered to the base unit, press **[INTERCOM]** and the base unit rings automatically.
- 2 If 2 or more handsets are registered to the base unit, press **[INTERCOM]** → **[▼]** to select the handset / base unit that is to be called, press **[OK]**.
- 3 Once the other handset or base unit answers, press **[Conf]** to join all 3 callers.

Base unit

- 1 If only one handset is registered to the base unit, press **[LOCATOR/INTERCOM]** and the handset rings automatically.
- 2 If 2 or more handsets are registered to the base unit, press **[LOCATOR/INTERCOM]** → **[▼]** to the handset that is to be called and press **[OK]**.
- 3 When the handset answers, press **[Conf]** to join all 3 callers.

Handset locator

The handset locator can be used to alert a handset user that they are wanted or locate a missing handset. Locator calls cannot be answered by a handset.

- 1 **[LOCATOR/INTERCOM]** on the base unit.
- 2 **[▼]** “Locate all”, press **[OK]**.
- 3 To stop the ringing, **[LOCATOR/INTERCOM]** or press any button on the handset.

Phonebook

The phonebook can store up to 70 names and numbers. Names can be up to 16 characters and numbers up to 24 digits.

Storing a name and number

When subscribed to Caller ID, to display the name of the caller instead of the number, save the full telephone number including the area code to the phonebook.

Multiple entries can be stored with the same name. However, to prevent unnecessary duplicated entries, the number can be stored only once.

Handset / Base unit

- 1 **[Menu]**. “Phonebook”.
- 2 **[OK]**, → **[▼]** “Add new”.
- 3 **[OK]**. “Enter name”.
- 4 Enter the name, press **[OK]**. “Enter number” is displayed.
- 5 Enter the number, press **[OK]**. The entry is saved.
- 6 Proceed with the operation for your unit.
Handset: **[OFF]** to return to standby.
Base unit: **[EXIT/STOP]** to return to standby.

Entering names and writing tips

Handset / Base unit

Use the keypad letters to enter names, e.g. to store Tom:

[8] once to enter T.

[6] three times to enter o.

[6] once to enter m.

To change the text from lower to upper case, press and hold **[#]**.

[Clear] to delete the last character or digit.

[↕]: Move between characters/digits.

[0] to insert a space.

Storing a redial list number to the phonebook

Handset / Base unit

- 1 **[Redial]**.
- 2 **[↕]**: Select the desired entry, press **[OK]**.
- 3 **[OK]**. “Save number”.
- 4 **[OK]**. “Enter name”.
- 5 Enter the name, press **[OK]**. The number is displayed.
- 6 Edit the number if necessary, then press **[OK]**. The number is stored.
- 7 Proceed with the operation for your unit.
Handset: **[OFF]** to return to standby.
Base unit: **[EXIT/STOP]** to return to standby.

Note:

See ‘Entering names and writing tips’ on page 18.

Storing caller information to the phonebook

Handset / Base unit

- 1 Proceed with the operation for your unit.
Handset: **[▼]** **CID**.
Base unit: **[CALL LIST]**.
- 2 **[↕]**: Select the desired entry.
- 3 **[Options]**, → **[▼]** “Save number”.
- 4 **[OK]**.
- 5 Enter the name if necessary, then press **[OK]**. The number is displayed.
- 6 Edit the number if necessary, then press **[OK]**. The number is stored.
- 7 Proceed with the operation for your unit.
Handset: **[OFF]** to return to standby.
Base unit: **[EXIT/STOP]** to return to standby.

Note:

See ‘Entering names and writing tips’ on page 18.

Viewing or dialing an entry

Handset / Base unit

- 1 Proceed with the operation for your unit.
Handset: **[▲]** **[□]**.
Base unit: **[□]**.

- 2 **[\blacklozenge]**: Select the required entry.
OR
Enter the first letter of the name to search alphabetically. The first name that starts with this letter or the nearest letter in the alphabet will be displayed.
[\blacklozenge]: Select the required entry.
- 3 Proceed with the operation for your unit.
Handset: **[TALK/SP-PHONE]** to dial or **[OFF]** to return to standby.
Base unit: Lift the corded handset or **[EXIT/STOP]** to return to standby.

Note:

When the list is displayed, to view detailed, press **[View]**. To return to the list, press **[Back]**.

Editing a name and number

Handset / Base unit

- 1 **[Menu]**. “Phonebook”.
- 2 **[OK]**, → **[\blacktriangledown]** “Edit”, press **[OK]**.
- 3 **[\blacklozenge]**: To select the entry that needs to be edited, or search alphabetically, press **[OK]**.
- 4 **[Clear]** to delete the name if required, then enter the new name, press **[OK]**. The existing number is displayed.
- 5 **[Clear]** to delete the number if required, then enter the new number, press **[OK]**. The entry is saved.
- 6 Proceed with the operation for your unit.
Handset: **[OFF]** to return to standby.
Base unit: **[EXIT/STOP]** to return to standby.

Deleting an entry

Handset / Base unit

- 1 **[Menu]**. “Phonebook”.
- 2 **[OK]**, → **[\blacktriangledown]** “Delete”, press **[OK]**.
- 3 **[\blacklozenge]**: To select the entry that needs to be deleted, or search alphabetically, press **[OK]**.
- 4 The display shows “Confirm?”.
- 5 **[OK]** to confirm or **[Back]** to cancel.
- 6 Proceed with the operation for your unit.
Handset: **[OFF]** to return to standby.
Base unit: **[EXIT/STOP]** to return to standby.

Deleting all entries

Handset / Base unit

- 1 **[Menu]**. “Phonebook”.
- 2 **[OK]**, → **[\blacktriangledown]** “Delete all”, press **[OK]**.
- 3 The display shows “Confirm?”.
- 4 **[OK]** to confirm or **[Back]** to cancel.
- 5 Proceed with the operation for your unit.
Handset: **[OFF]** to return to standby.
Base unit: **[EXIT/STOP]** to return to standby.

Chain dial

Base unit

This feature allows you to dial phone numbers in the phonebook while you are on a call. This feature can be used, for example, to dial a calling card access number or bank account PIN that you have stored in the phonebook, without having to dial manually.

- 1 During an outside call, press **[\square]**.
- 2 **[\blacklozenge]**: Select the required entry.
- 3 Press **[OK]** 2 times.

Note:

When storing a calling card access number and your PIN in the phonebook as one phonebook entry, press and hold **[#]** to add pauses after the number and PIN as necessary (page 15).

If you have rotary/pulse service, you need to press **[*]** before pressing **[\square]** in step 1 to change the dialing mode temporarily to tone. When adding entries to the phonebook, we recommend adding **[*]** to the beginning of phone numbers you wish to chain dial.

Speed dial

You can assign 1 phone number to each of the dial keys (1 to 9) in the handset and base unit. The speed dial name can be up to 14 characters and the speed dial number can be up to 24 digits. If a number is stored in the phonebook, it cannot be stored as a speed dial number.

Storing phone numbers to speed dial keys

Handset / Base unit

- 1 [Menu], “Phonebook”.
- 2 [OK], → [▼] “Edit”, press [OK].
- 3 [↕]: To select the key you want to store the number, press [OK].
- 4 Enter the name, press [OK].
- 5 Enter the number, press [OK].
- 6 Proceed with the operation for your unit.
Handset: [OFF] to return to standby.
Base unit: [EXIT/STOP] to return to standby.

Note:

- An entry stored in the phonebook can not be stored as a speed dial number.
- If you want to delete the speed dial number, follow “Deleting an entry” on page 19.

Dial a speed dial number

Handset / Base unit

- 1 Press and hold the relevant key until the number is displayed and dialed.

Using Caller ID service

IMPORTANT

- This unit is Caller ID compatible. To use Caller ID features, you must subscribe to a Caller ID service. Contact your phone service provider for details.

Caller ID features

When an outside call is being received, the caller's phone number is displayed. Caller information for the last 50 callers is logged in the caller list from the most recent call to the oldest.

- If the unit cannot receive caller information, the following is displayed:
 - "Unknown": The caller dials from an area which does not provide a Caller ID service.
 - "Private": The caller requests not to send caller information.
- If the unit is connected to a PBX system, caller information may not be properly received. Contact your PBX supplier.

Missed calls

If a call is not answered, the unit treats it as a missed call. The display flashes . This lets you know if you should view the calls list to see who called while you were away.

Phonebook name display

When caller information is received and it matches a phone number stored in the phonebook, the stored name in the phonebook is displayed and logged in the caller list.

To ensure that the caller's name is displayed, make sure the full telephone number, including the area code is stored in the phonebook.

Area code

Phone numbers stored automatically in the caller list will include area codes. If you do not want to dial the area code when making calls from the caller list, you can store the area code which you want the unit to delete automatically. The area code must be 3-digit long.

Handset / Base unit

- 1 **[MENU]**, → **[▼]** "Advanced set", press **[OK]**.
- 2 **[▼]** "Area code", press **[OK]**.
- 3 Enter the 3-digit area code, press **[OK]** to confirm.
- 4 Proceed with the operation for your unit.
Handset: [OFF] to return to standby.
Base unit: [EXIT/STOP] to return to standby.

Caller list

Make sure the unit's date and time setting is correct, page 24.

Viewing the caller list

Handset / Base unit

- 1 Proceed with the operation for your unit.
Handset: [▼] CID to open the caller list.
Base unit: [CALL LIST] to open the caller list.
 - If there are no calls in the list, the display shows "List empty".
- 2 **[↑]**: To the required entry.
- 3 **[Options]**, "View", press **[OK]**.
- 4 The display shows the date and time of the call.

Note:

 disappears after viewing all missed call.

Dialing an entry in the caller list

Handset / Base unit

- 1 Proceed with the operation for your unit.
Handset: [▼] CID to open the caller list.
Base unit: [CALL LIST] to open the caller list.
- 2 **[↑]**: To the required entry.
- 3 Proceed with the operation for your unit.
Handset: [TALK/SP-PHONE].
Base unit: Lift the corded handset or press [SP-PHONE].

Editing a caller's phone number

You can edit a phone number in the caller list by removing its area code and/or the long distance code "1".

Handset / Base unit

- 1 Proceed with the operation for your unit.
Handset: [▼] **CID** to open the caller list
Base unit: [CALL LIST] to open the caller list.
- 2 [↕]: To the required entry.
- 3 [Options], "View", press [OK].
- 4 Press [#] repeatedly until the number number is shown in the desired format.
- 5 Proceed with the operation for your unit.
Handset: [TALK/SP-PHONE].
Base unit: Lift the corded handset.

Deleting an entry

Handset / Base unit

- 1 Proceed with the operation for your unit.
Handset: [▼] **CID** to open the caller list.
Base unit: [CALL LIST] to open the caller list.
- 2 [↕]: To the required entry.
- 3 [Options], → [▼] "Delete".
- 4 [OK]. "Confirm?".
- 5 [OK] to confirm or [Back] to cancel.
- 6 Proceed with the operation for your unit.
Handset: [OFF] to return to standby.
Base unit: [EXIT/STOP] to return to standby.

Deleting the entire caller list

Handset / Base unit

- 1 Proceed with the operation for your unit.
Handset: [▼] **CID** to open the caller list.
Base unit: [CALL LIST] to open the caller list.
- 2 [Options], → [▼] "Delete all".
- 3 [OK]. "Confirm?".
- 4 [OK] to confirm or [Back] to cancel.

Personal settings

Sounds

Ringer volume

The ring volume can be set to different volume levels. Choose from 5 volume levels or Off.

Handset / Base unit

- 1 [Menu], → [▼] “Personal set”, press [OK].
- 2 “Sounds”, press [OK].
- 3 “Ring volume”, press [OK].
- 4 [↕]: Select the volume (1 - 5 or “Off”), press [OK].
- 5 Proceed with the operation for your unit.
Handset: [OFF] to return to standby.
Base unit: [EXIT/STOP] to return to standby.

Note:

When the phone is ringing, adjust the ringer volume by pressing [↕].

Ringer melody

Different ringer melodies of the handset can be set. Choose from 10 different ringer melodies. While scrolling a sample ring will be heard for each melody.

Handset

- 1 [Menu], → [▼] “Personal set”, press [OK].
- 2 “Sounds”, press [OK].
- 3 [▼] “Ring tones”, press [OK].
- 4 [↕]: Select the ring tone (1 - 10), press [OK] to save.
- 5 [OFF] to return to standby.

Note:

The preset melodies in this product are used with permission of ©2015 Copyrights Vision Inc.

Silent mode

Silent mode can be set for a designated time period. Once activated when you receive an incoming call the handset will not ring.

IMPORTANT

We recommend turning the base unit ringer off (page 15) in addition to turning the silent mode on.

While silent mode is activated, you cannot hear operating and notification tones of the handset.

■ Turning silent mode on /off

Handset

- 1 [Menu], → [▼] “Personal set”, press [OK].
- 2 “Sounds”, press [OK].
- 3 [▼] “Silent mode”, press [OK].
- 4 “On/off”, press [OK].
- 5 [↕]: Select “On” or “Off”, press [OK].
- 6 [OFF] to return to standby.

■ Changing the start and end time

Handset

- 1 [Menu], → [▼] “Personal set”, press [OK].
- 2 “Sounds”, press [OK].
- 3 [▼] “Silent mode”, press [OK].
- 4 [▼] “Start & end”, press [OK].
- 5 Enter the start time using the keypad [0][2][3][0] for 2:30, then press [↕] to select “AM” or “PM” and press [OK].
 Enter the end time using the keypad (e.g. [0][3][3][0] for 3:30), then press [↕] to select “AM” or “PM” and press [OK] to save.
- 6 [OFF] to return to standby.

Key tones

Handset / Base unit

- 1 [Menu], → [▼] “Personal set”, press [OK].
- 2 “Sounds”, press [OK].
- 3 [▼] “Key tone”, press [OK].
- 4 [↕]: Select “On” or “Off”, press [OK] to save.
- 5 Proceed with the operation for your unit.
Handset: [OFF] to return to standby.
Base unit: [EXIT/STOP] to return to standby.

Docking tone

When you replace the handset in the base unit, you will hear a double beep. You can switch this beep on or off.

Handset

- 1 [Menu], → [▼] “Personal set”, press [OK].
- 2 “Sounds”, press [OK].
- 3 [▼] “Docking tone”, press [OK].

- [**+**]: Select “On” or “Off”, press [**OK**] to save.
- [**OFF**] to return to standby.

Battery tone

When your batteries are running low on charge, you will hear a beep. You can switch this beep on or off.

Handset

- [**Menu**], → [**▼**] “Personal set”, press [**OK**].
- “Sounds”, press [**OK**].
- [**▼**] “Battery tone”, press [**OK**].
- [**+**]: Select “On” or “Off”, press [**OK**] to save.
- [**OFF**] to return to standby.

Handset name

A personalized name can be set for each handset to easily distinguish between them. A name can be up to 14 characters.

Handset

- [**Menu**], → [**▼**] “Personal set”, press [**OK**].
- [**▼**] “Handset name”, press [**OK**].
- Enter the new handset name, press [**OK**] to save.
To delete the current name or if a mistake is made, press [**Clear**] to delete the last character or digit.
- [**OFF**] to return to standby.

Note:

See ‘Entering names and writing tips’, page 18.

Date and time

Handset

- [**Menu**], → [**▼**] “Personal set”, press [**OK**].
- [**▼**] “Date & time”, press [**OK**].
- Enter the current month, date, and year using the keypad (e.g. [**0**][**7**][**1**][**2**][**2**][**0**] for July 12, 2020), press [**OK**] to confirm.
- Enter the current time using the keypad (e.g. [**0**][**9**][**3**][**0**] for 9:30), then press [**+**] to select “AM” or “PM” and press [**OK**] to save.
- [**OFF**] to return to standby.

Language

Handset / Base unit

- [**Menu**], → [**▼**] “Personal set”, press [**OK**].
- [**▼**] “Language”, press [**OK**].
- [**+**]: Select the preferred language, press [**OK**] to save.
- Proceed with the operation for your unit.
Handset: [OFF] to return to standby.
Base unit: [EXIT/STOP] to return to standby.

Languages available are English, Spanish and French.

Auto answer

The phone is set to answer calls by lifting the handset off the charger. This feature can be switched off so that calls can only be answered by pressing [**TALK/SP-PHONE**].

Handset

- [**Menu**], → [**▼**] “Personal set”, press [**OK**].
- [**▼**] “Auto answer”, press [**OK**].
- [**+**]: Select “On” or “Off”, press [**OK**] to save.
- [**OFF**] to return to standby.

Auto hang-up

The phone is set to end calls by pressing [**OFF**]. This feature can be switched on so that calls can be ended by placing the handset on the charger.

Handset



- [**Menu**], → [**▼**] “Personal set”, press [**OK**].
- [**▼**] “Auto hang-up”, press [**OK**].
- [**▼**]: Select “On” or “Off”, press [**OK**] to confirm.
- [**OFF**] to return to standby.

Alarm

Handset

- [**Menu**], → [**▼**] “Alarm”, press [**OK**].
- [**+**]: Select “Off”, “On once” or “On daily”, press [**OK**].
- If you select “On once” or “On daily”, enter the time using the keypad (e.g. [**0**][**2**][**3**][**0**] for 2:30), then press [**+**] to select “AM” or “PM” and press [**OK**] to save.

4 [OFF] to return to standby.

Once the alarm is set to on, the  icon is displayed. When the alarm goes on the  icon flashes. Press any dial key to stop the sound. If set to “On once” then the alarm will turn off automatically after it sounds. If the alarm is set to “On daily” the alarm will sound at that time every day, to turn the alarm off select “Off” in the menu.

Advanced settings

Call block

This feature allows the unit to block calls from specified phone numbers that you do not want to answer such as junk calls (Caller ID subscribers only).

When a call is received, the unit does not ring while the caller is being identified.

If the caller's phone number matches an entry in the block list, the unit emits no sound to the caller and “Blocked caller” is displayed for about 7 seconds, then disconnects the call.

To disconnect the current call and add a phone number to the call block list

You can press the [CALL BLOCK] button in the following situations to disconnect the current call and add a phone number to the call block list:

- when an incoming call is being received
- when an incoming call is being received by the answering system
- when talking on an outside call

Once a phone number has been added to the call block list, the unit will block calls from that phone number in the future.

Handset / Base unit

- 1 Press [CALL BLOCK] under the situations shown above.
 - The call block number is stored in the call block list and “Blocked caller” is displayed for about 7 seconds, then the call is disconnected.

Switching unknown call block on/off

Handset / Base unit



- 1 [CALL BLOCK].
- 2 “Unknown call”, press [OK].

- 3 []: Select “On” or “Off”, press [OK] to save.

- 4 **Handset:** [OFF] to return to standby.
Base unit: [EXIT/STOP] to return to standby.

Switching call block on/off

Handset / Base unit

- 1 [CALL BLOCK].
- 2 [] “Block list”, press [OK].
- 3 “Block mode”, press [OK].
- 4 []: Select “On” or “Off”, press [OK] to save.
- 5 **Handset:** [OFF] to return to standby.
Base unit: [EXIT/STOP] to return to standby.



Setting a number to be blocked

You can store up to 50 phone numbers in the call block list.



To activate this feature, you must turn the block mode on (page 25).

Handset / Base unit

■ Adding call blocked number from the caller list

- 1 Proceed with the operation for your unit.
Handset: [] CID to open the caller list.
Base unit: [CALL LIST] to open the caller list.
- 2 []: To the required entry. → [Options].
- 3 []: “Block number”, press [OK] 2 times.
- 4 Proceed with the operation for your unit.
Handset: [OFF] to return to standby.
Base unit: [EXIT/STOP] to return to standby.

■ Adding call blocked number manually

- 1 [CALL BLOCK].
- 2 [] “Block list”, press [OK].
- 3 [] “Block number”, press [OK].
- 4 []: to the next available slot, press [OK].
- 5 Enter the number or pre ix you want to block. Press [OK] to confirm.
- 6 **Handset:** [OFF] to return to standby.
Base unit: [EXIT/STOP] to return to standby.

Note:

When you store a phone number in the block list, you will need to store the full number including the area code for the number to be blocked.

If you want to change/delete the block list number, follow the first 3 steps in “Adding call blocked number manually” above, and then

press [↵] to the slot where the number is stored, press [OK]. To delete the number, press [CLEAR], either press [OK] to delete, or enter a new number and press [OK].

Flash time

This setting is useful to access certain network and PBX/switchboard services. The default flash time is suitable for your country and network operator. It is unlikely that you should need to change this setting unless advised to do so.

Handset / Base unit

- 1 [Menu], → [▼] “Advanced set”, press [OK].
- 2 [▼] “Flash time”, press [OK].
- 3 [↵]: Select “80ms”, “90ms”, “100ms”, “110ms”, “160ms”, “200ms”, “250ms”, “300ms”, “400ms”, “600ms”, “700ms” or “900ms”, press [OK] to save.
- 4 Proceed with the operation for your unit.
Handset: [OFF] to return to standby.
Base unit: [EXIT/STOP] to return to standby.

Dial mode

Your phone is set to tone dialing. You should only need to change this if connected to a PBX/switchboard which requires pulse dialing.

Handset / Base unit

- 1 [Menu], [▼] “Advanced set”, [OK].
- 2 [▼] “Dial mode”, [OK].
- 3 [↵]: Select “Tone” or “Pulse”, [OK].
- 4 Proceed with the operation for your unit.
Handset: [OFF] to return to standby.
Base unit: [EXIT/STOP] to return to standby.

Auto clock

If you have subscribed to Caller ID Service, the date and time will be set on your base unit whenever a call is received. This feature can be set to On or Off.

Handset / Base unit

- 1 [Menu], → [▼] “Advanced set”, press [OK].
- 2 [▼] “Auto clock”, press [OK].
- 3 [↵]: Select “On” or “Off”, press [OK] to save.
- 4 Proceed with the operation for your unit.
Handset: [OFF] to return to standby.
Base unit: [EXIT/STOP] to return to standby.

Change PIN

Some functions are protected by a 4-digit PIN code which must be entered if the settings are changed. The default PIN is 0000. The PIN can be changed to a preferred number.

When entering a PIN, the digits are shown as ****.

Handset / Base unit

- 1 [Menu], → [▼] “Advanced set”, press [OK].
- 2 [▼] “Change PIN”, press [OK].
- 3 If the PIN is already changed from default setting, enter the current 4-digit PIN, press [OK].
- 4 Enter a new 4-digit PIN, press [OK].
- 5 Re-enter the new PIN, press [OK] to save.
- 6 Proceed with the operation for your unit.
Handset: [OFF] to return to standby.
Base unit: [EXIT/STOP] to return to standby.

IMPORTANT

If the PIN code is changed, please keep a record of the new number.

Registering a handset

Note:

Handset batteries must be fully charged before registration. Hold the handset close to the base unit during the registration process.

Handsets that were supplied with the base unit are already pre-registered.

On the base unit:

- 1 Press and hold [LOCATOR/INTERCOM] for 5 seconds. The base unit will remain in registration mode for 120 seconds.

On the handset:

- 2 If the handset is not registered to a base unit: “Register your Handset”, press [OK]. “Press locator Key for 5 sec”, press [OK] and then enter the 4-digit PIN code (default = 0000), [OK].
- 3 If the handset is already registered to a base unit, press [Menu], → [▼] “Advanced set”, press [OK]. [▼] “Register”, press [OK].
- 4 “Press locator key for 5 sec”, press [OK].
- 5 Enter the 4-digit PIN code (default = 0000), press [OK].

A beep will be heard if the registration is successful. The handset is automatically

assigned an available handset number. Use this number when making internal calls.

Note:

If registration is not successful the first time, please repeat the process again in case the base unit registration period ran out of time. If the base unit is not found after about 120 seconds, the handset returns to standby. Try registering again.

De-registering a handset

A handset can cancel other handsets registered to the same base unit. This allows the handset to end its wireless connection with the system.

Handset / Base unit

- 1 **[Menu]**, → **[▼]** “**Advanced set**”, press **[OK]**.
- 2 **[▼]** “**Deregister**”, press **[OK]**.
- 3 Enter the 4-digit PIN code (default = 0000), press **[OK]**.
- 4 **[▼]** to select the handset that needs to be de-registered, press **[OK]**. A confirmation beep will be heard and the display will return to standby.

Restore default settings

The phone can be restored to its default (original) settings. All the handsets that are registered to the base unit will be retained.

IMPORTANT

Current handset and base unit settings will be reset. Some contents will be retained even if you reset the phone setting. See “Default setting by reset” for details.

Handset / Base unit

- 1 **[Menu]**, → **[▼]** “**Advanced set**”, press **[OK]**.
- 2 **[▼]** “**Reset**”, press **[OK]**.
- 3 The display shows “**Confirm?**”.
- 4 Proceed with the operation for your unit.
Handset: **[OK]** to confirm or **[OFF]** to return to standby.
Base unit: **[OK]** to confirm or **[EXIT/STOP]** to return to standby.
 The phone will restart automatically.

Default settings by reset

Phonebook	Unchanged
Speed dial	Unchanged
Ring volume (Handset)	5
Ring volume (Base unit)	5
Ring tones ^{*1}	1
Silent mode ^{*1}	Off
Silent mode (Start time) ^{*1}	08:00PM
Silent mode (End time) ^{*1}	08:00AM
Key tone	On
Docking tone ^{*1}	On
Battery tone ^{*1}	On
Handset name ^{*1}	Unchanged
Date & time	Unchanged
Language	English
Auto answer ^{*1}	Off
Auto hang-up	On
Alarm ^{*1}	Off
Call block (Unknown call)	Off
Call block (Block mode)	Off
Call block (Block number)	Unchanged
Area code	Empty
Flash time	700ms
Dial mode	Tone
Auto clock	Unchanged
Change PIN	0000
Caller list	Unchanged
Redial list	Unchanged
Receiver/speaker volume (Handset)	3
Receiver/speaker volume (Base unit)	3
Handset equalizer ^{*1}	Alto
Answering system	On
Answer mode	Record also
Greeting message	Use default

Programming

Recording message	Unchanged
Ring count	4 rings
Remote access	Deactivate
Security code	0000
TAM language	English

*1 Handset only

Answering system

The answering system can answer and record calls for you when you are unavailable to answer the phone.

You can also set the unit to play a greeting message but not to record caller messages by selecting **“Answer only”** after setting the answering system **“On”**.

IMPORTANT

Make sure the unit's date and time setting is correct (page 24).

Memory capacity (including your greeting message)

The total recording capacity is about 25 minutes. A maximum of 59 messages can be recorded.

Note:

When message memory becomes full:

- **“Memory full!”** is shown on the handset and base unit display.
- The total number of new messages are not displayed even if the answering system is turned on.
- The unit automatically switches to **“Answer only”** mode even if you selected **“Record also”**.

Turning the answering system on/off

The answering system is preset to on.

Using the base unit keys

Press **[ANSWER ON/OFF]** to turn on/off the answering system.

Via the menu

Handset / Base unit

- 1 **[Menu]**, → **[▼]** **“Answ. machine”**, press **[OK]**.
- 2 **“On/off”**, press **[OK]**.
- 3 **[⬆]**: Select **“On”** or **“Off”**, press **[OK]**.
If On is selected, **[⬆]** **“Record also”** or **“Answer only”**, press **[OK]**.

- 4 Proceed with the operation for your unit.
Handset: **[OFF]** to return to standby.
Base unit: **[EXIT/STOP]** to return to standby.

Note for base unit and handset:

When the answering system is turned on:

- the **ANSWER ON/OFF** indicator on the base unit lights up.
-  is displayed.

Call screening

Base unit

While a caller is leaving a message, you can listen to the call through the base unit's speaker. To adjust the volume, press **[▲]** or **[▼]** repeatedly. You can answer a call by:

- lifting the corded handset from the base unit
- pressing **[TALK/SP-PHONE]** on the handset.

Note:

You can also adjust the volume by pressing **[▲]** or **[▼]** in standby.

Greeting message

When the unit answers a call, a greeting message is played to callers.

You can use either:

- your own greeting message
- a pre-recorded greeting message

Recording your greeting message

Handset / Base unit

- 1 **[Menu]**, → **[▼]** **“Answ. machine”**, press **[OK]**.
- 2 **[▼]** **“Outgoing msg.”**, press **[OK]**.
- 3 **[⬆]**: Select **“Record also”** or **“Answer only”**, press **[OK]**.
- 4 **[▼]** **“Record”**, press **[OK]**.
- 5 Once you hear the beep say your message into the handset / base unit microphone, press **[Save]** to end recording. The greeting will be played back.
- 6 Proceed with the operation for your unit.
Handset: **[OFF]** to return to standby.
Base unit: **[EXIT/STOP]** to return to standby.

Using a pre-recorded greeting message

The unit provides 2 pre-recorded greeting messages:

- If you erase or do not record your own greeting message, the unit plays a pre-recorded greeting asking callers to leave a message.
- If the greeting is set to **“Answer only”**, callers' messages are not recorded and the unit plays a different pre-recorded greeting message asking callers to call again.

Resetting to a pre-recorded greeting message

If you change into a pre-recorded greeting message once you record your own greeting message, your own recorded greeting message is erased.

Handset / Base unit

- 1 **[Menu]**, → **[▼]** **“Answ. machine”**, press **[OK]**.
- 2 **[▼]** **“Outgoing msg.”**, press **[OK]**.
- 3 **[↓]**: Select **“Record also”** or **“Answer only”**, press **[OK]**.
- 4 **[▼]** **“Use default”**, press **[OK]**.
- 5 **“Confirm?”**, press **[OK]**.
- 6 Proceed with the operation for your unit.
Handset: **[OFF]** to return to standby.
Base unit: **[EXIT/STOP]** to return to standby.

Playing back the greeting message

Handset / Base unit

- 1 **[Menu]**, → **[▼]** **“Answ. machine”**, press **[OK]**.
- 2 **[▼]** **“Outgoing msg.”**, press **[OK]**.
- 3 **[↓]**: Select **“Record also”** or **“Answer only”**, press **[OK]**.
- 4 **“Play”**, press **[OK]**.
- 5 The current greeting will play back.
- 6 Proceed with the operation for your unit.
Handset: **[OFF]** to return to standby.
Base unit: **[EXIT/STOP]** to return to standby.

Listening to messages

Note:

- **“Missed call”** is still shown even after you have listened to messages. To remove this message, see **“Viewing the caller list”** on page 21.

Using the base unit keys

When new messages have been recorded:

- Play/Message indicator on the base unit flashes.
-  flashes with the total number of new messages.

Press **[PLAY]**.

- If new messages have been recorded, the base unit plays back new messages.
- If there are no new messages, the base unit plays back all messages.

Operating the answering system during playback

Key	Operation
[▲] or [▼]	Adjust the speaker volume
[◀◀]	Play previous message
[▶▶]	Skip message
[EXIT/STOP]	Stop playback
[ERASE/FLASH]	Delete currently playing message

Via the menu

When new messages have been recorded,  flashes on the display.

Handset / Base unit

To listen to new messages:

[Listen]*

*If you stop the playback operation halfway, **[Listen]** disappears from the standby display even when there are new messages which are not played.

To listen to all messages:

[Menu], → **[▼]** **“Answ. machine”**, press **[OK]**.
[▼] **“Play all”**, press **[OK]**.

Note for handset:

All new messages will automatically play back via the loudspeaker then, press [TALK/SP-PHONE] for private playback. The display shows the number of new messages and the date and time the messages were left. If there are no new messages, all stored messages are played.

During playback

[Options] → [↕]: to change the options. → [OK]

Options	Operation
Repeat	Repeat message
Next	Skip message
Previous	Play previous message
Delete	Delete currently playing message

Deleting all old messages

Handset / Base unit

- [Menu], → [▼] “Answ. machine”, press [OK].
- [▼] “Delete all”, press [OK].
- “Confirm?”, press [OK].
- Proceed with the operation for your unit.
Handset: [OFF] to return to standby.
Base unit: [EXIT/STOP] to return to standby.

Recording a memo message

You can record memo messages for other users which can be played back just like normal messages.

Handset / Base unit

- [Menu], → [▼] “Answ. machine”, press [OK].
- [▼] “Record memo”, press [OK].
 After the tone record your memo by speaking into the microphone, press [Save] to end recording. The message will be played back.
- [OK] to stop playback or [Delete] to delete.
- Proceed with the operation for your unit.
Handset: [OFF] to return to standby.
Base unit: [EXIT/STOP] to return to standby.

Ring count

Select the duration of rings before your answer machine picks up the call. Choose from 3-8 rings or Toll saver.

When set to Toll saver, if you have new messages your phone answers after 3 rings. If there are no new messages it will answer after 5 rings. So you have the option to hang up, saving the time and cost of a call.

Handset / Base unit

- [Menu], → [▼] “Answ. machine”, press [OK].
- [▼] “Ring count”, press [OK]. It will display the current setting.
- [↕]: Select the number of rings required and press [OK] to save.
- Proceed with the operation for your unit.
Handset: [OFF] to return to standby.
Base unit: [EXIT/STOP] to return to standby.

Remote access

You can operate your answering machine from any DTMF phone by calling your product and entering a 4-digit security code.

Dial your telephone number. When you hear your outgoing message, press [✳].

Enter your 4-digit security code (default setting 0000) you will hear a confirmation beep. Use the keypad to operate the answering machine.

Key	Operation
1	Play new messages
2	Play all messages
3	Delete currently playing message
4	Skip back to previous message
5	Answer on/off
6	Skip forward to next message
8	Play the greeting message
9	Record the greeting message
0	Play remote access menu

Note:

If you want to listen the same message again, press 4, then press 6.

Remote access on/off and change remote security code

Handset / Base unit

- 1 [Menu], → [▼] “Answ. machine”, press [OK].
- 2 [▼] “Remote access”, press [OK].
- 3 [↕]: Select “Activate”, “Deactivate” or “Security code”, press [OK].
- 4 If you select “Security code”, enter the old code and press [OK] when the security code is already changed from default setting.
- 5 Enter the new code and press [OK].
- 6 Re-enter the new code. Press [OK].
- 7 Proceed with the operation for your unit.
Handset: [OFF] to return to standby.
Base unit: [EXIT/STOP] to return to standby.

Turning on the answering system remotely

- 1 Dial your phone number from a touch-tone phone.
- 2 Let the phone ring 15 times.
 - The message is heard.
- 3 Enter [*] and your remote security code within 7 seconds after the message.
 - You can either hang up, or begin remote operation (page 31).

TAM language

Handset / Base unit

- 1 [Menu], → [▼] “Answ. machine”, press [OK].
- 2 [▼] “TAM language”, press [OK].
- 3 [↕]: Select the language you require. Press [OK].
- 4 Proceed with the operation for your unit.
Handset: [OFF] to return to standby.
Base unit: [EXIT/STOP] to return to standby.

Languages available are English or Spanish.

Voicemail service

In addition to your unit's answering system you may also have voicemail service from your phone service provider. Voicemail is an answering service that may be offered by your phone service provider. This service can also record calls when you are unavailable to answer the phone or when your line is busy. Messages are recorded on the phone company system and not on the unit's answering system.

- To use the voicemail service rather than the unit's answering system, turn off the answering system (page 29).

If you have unit's answering system set to on and also the voicemail enabled, the system with least amount of rings will record the message first.

Example:

If the unit's answering system is set to 4 rings (page 31) and the voicemail answering system provided by your phone company is set to 6 rings (call your service provider), the unit's answering system will record the incoming call first.

When you have new messages,  is displayed if message indication service is available. Please contact your phone service provider for details of this service.

To listen to your voicemail messages, you have to dial your voicemail access number manually.

If still remains on the display even after you have listened to new messages, while in the calls list press and holding  for 2 seconds will delete all voicemail messages.

Wall mounting

Note:

- Make sure that the wall and the fixing method are strong enough to support the weight of the unit.

Base unit

- Remove the desk stand from the base unit.

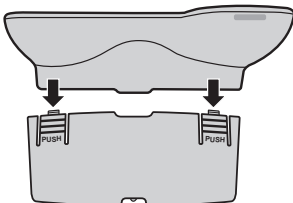

- Mount the unit on a wall then slide down to secure in place.

- This product is compliant with the following wall phone plate size.
 - A** 83 mm (3 1/4 inches)
 Fit the slots of the unit onto the wall phone plate.

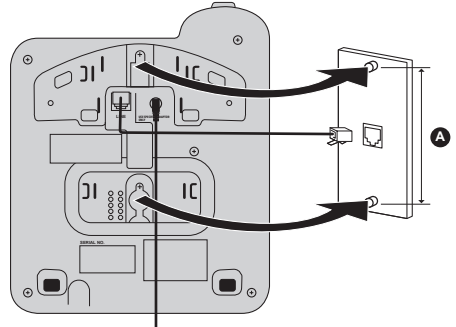

To temporarily set the handset down during a conversation, place it as shown here.

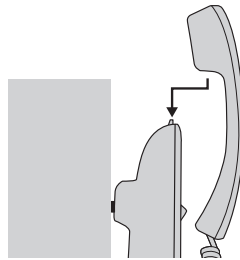

Charger

- Drive the screws (not supplied) into the wall. Mount the unit on a wall then slide down to secure in place.

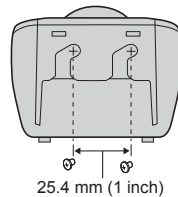

Troubleshooting

No dial tone

- Use only the telephone line cord supplied.
- Check that the telephone line cord is connected properly.
- Check that the mains power is connected properly.

No display

- Check that the batteries are inserted correctly and fully charged. Use only approved rechargeable batteries supplied.
- Reset the unit by removing the batteries and disconnecting the mains power. Wait for around 15 seconds before connecting it again. Allow up to one minute for the handset and base unit to synchronize.

LCD and key backlight does not light up during operation

- Battery charge is low. Fully charge the batteries.

icon is not displayed

- Handset is out of range. Move closer to the base unit.
- Check that the mains power is connected properly.

icon is not scrolling during charge

- Adjust the handset slightly on the charger.
- Clean the charge contacts with a dry cloth.
- Check that the charger power is connected properly.
- The battery is full. When the handset is fully charged,  icon will appear steadily on the display.

No Caller Display

- You must subscribe to Caller ID service. Contact your phone service provider for details.
- The caller may have withheld their number.
- The record cannot be found in the phonebook. Check that the correct name/number is stored in the phonebook, with the full area code.

I have forgotten my PIN!

- Restore the phone to its default settings, see page 27.

Cannot register a handset to the base unit

- Up to a maximum of 4 handsets can be registered to the base unit. De-register a handset in order to register a new one, see page 27.
- Check that correct PIN code (default = 0000) has been entered.
- Check that the handset and base unit are at least one metre away from other electrical equipment to avoid interference when registering.

Handset does not ring

- The handset ringer volume may be set to Off, see page 23.

Base unit does not ring

- The base unit ringer volume may be set to Off, see page 23.

Noise interference on my phone or on other electrical equipment nearby

- Place the phone at least one metre away from electrical appliances or any metal obstructions to avoid any risk of interference.

Answering machine will not record new messages

- Is the recording memory full? Play and delete messages.
- Is the greeting message set to “Answer only”? Change the greeting message to “Record also”.

Liquid damage

Liquid or other form of moisture has entered the handset/base unit

- Disconnect the AC adaptor and telephone line cord from the base unit. Remove the batteries from the handset and leave to dry for at least 3 days. After the handset/ base unit are completely dry, reconnect the AC adaptor and telephone line cord. Insert the batteries and charge fully before use. If the unit does not work properly, contact an authorized service center.

Caution:

- To avoid permanent damage, do not use a microwave oven to speed up the drying process.

FCC and other information

This equipment complies with Part 68 of the FCC rules and the requirements adopted by the ACTA. On the bottom of this equipment is a label that contains, among other information, a product identifier in the format US:ACJ-----.

- Registration No.....(found on the bottom of the unit)
- Ringer Equivalence No. (REN).....0.9A

A plug and jack used to connect this equipment to the premises wiring and telephone network must comply with the applicable FCC Part 68 rules and requirements adopted by the ACTA. A compliant telephone cord and modular plug is provided with the product. It is designed to be connected to a compatible modular jack that is also compliant.

The REN is used to determine the number of devices that may be connected to a telephone line. Excessive RENs on a telephone line may result in the devices not ringing in response to an incoming call. In most but not all areas, the sum of RENs should not exceed five (5.0). To be certain of the number of devices that may be connected to a line, as determined by the total RENs, contact the local telephone company. For products approved after July 23, 2001, the REN for the product is part of the product identifier that has the format US:AAAEQ##TXXXX. The digits represented by ## are the REN without a decimal point (e.g., 03 is a REN of 0.3).

If this equipment causes harm to the telephone

network, the telephone company will notify you in advance that temporary discontinuance of service may be required. But if advance notice isn't practical, the telephone company will notify the customer as soon as possible. Also, you will be advised of your right to file a complaint with the FCC if you believe it is necessary.

The telephone company may make changes in its facilities, equipment, operations or procedures that could affect the operation of the equipment. If this happens the telephone company will provide advance notice in order for you to make necessary modifications to maintain uninterrupted service.

If trouble is experienced with this equipment, for repair or warranty information, please contact a Factory Service Center or other Authorized Servicer. If the equipment is causing harm to the telephone network, the telephone company may request that you disconnect the equipment until the problem is resolved.

Connection to party line service is subject to state tariffs. Contact the state public utility commission, public service commission or corporation commission for information.

If your home has specially wired alarm equipment connected to the telephone line, ensure the installation of this equipment does not disable your alarm equipment. If you have questions about what will disable alarm equipment, consult your telephone company or a qualified installer.

This equipment is hearing aid compatible as defined by the FCC in 47 CFR Section 68.316.

When you hold the phone to your ear, noise might be heard in your Hearing Aid. Some Hearing Aids are not adequately shielded from external RF (radio frequency) energy. If noise occurs, use an optional headset accessory or the speakerphone option (if applicable) when using this phone. Consult with your audiologist or Hearing Aid manufacturer about the availability of Hearing Aids which provide adequate shielding to RF energy commonly emitted by digital devices.

WHEN PROGRAMMING EMERGENCY NUMBERS AND/OR MAKING TEST CALLS TO EMERGENCY NUMBERS:

- 1 Remain on the line and briefly explain to the dispatcher the reason for the call.
- 2 Perform such activities in the off-peak hours, such as early morning or late evenings.

- 3 This device complies with Part 15 of the FCC Rules. Operation is subject to the following two conditions:

(1) This device may not cause harmful interference, and (2) this device must accept any interference received, including interference that may cause undesired operation.

Privacy of communications may not be ensured when using this phone.

CAUTION:

Any changes or modifications not expressly approved by the party responsible for compliance could void the user's authority to operate this device.

NOTE:

This equipment has been tested and found to comply with the limits for a Class B digital device, pursuant to Part 15 of the FCC Rules. These limits are designed to provide reasonable protection against harmful interference in a residential installation. This equipment generates, uses, and can radiate radio frequency energy and, if not installed and used in accordance with the instructions, may cause harmful interference to radio communications. However, there is no guarantee that interference will not occur in a particular installation. If this equipment does cause harmful interference to radio or television reception, which can be determined by turning the equipment off and on, the user is encouraged to try to correct the interference by one or more of the following measures:

- Reorient or relocate the receiving antenna.
- Increase the separation between the equipment and receiver.
- Connect the equipment into an outlet on a circuit different from that to which the receiver is connected.
- Consult the dealer or an experienced radio/TV technician for help.

Some cordless telephones operate at frequencies that may cause interference to nearby TVs and VCRs. To minimize or prevent such interference, the base unit of the cordless telephone should not be placed near or on top of a TV or VCR. If interference is experienced, move the cordless telephone further away from the TV or VCR. This will often reduce or eliminate interference.

FCC RF Exposure Warning:

- This product complies with FCC radiation exposure limits set forth for an uncontrolled environment.
- To comply with FCC RF exposure requirements, the base unit must be installed and operated 20 cm (8 inches) or more between the product and all person's body.
- This product may not be collocated or operated in conjunction with any other antenna or transmitter.
- For body-worn operation, the handset must be used only with a non-metallic accessory. Use of other accessories may not ensure compliance with FCC RF exposure requirements.

Notice:

- FCC ID can be found inside the battery compartment or on the bottom of the units.

Guía rápida

Conexiones

Unidad base

- 1 Conecte el adaptador de corriente alterna a la unidad presionándolo firmemente.
- 2 Conecte el cable de la línea telefónica a la unidad hasta que escuche un clic.
- 3 Enganche el cable del adaptador de corriente alterna y el cable de la línea telefónica para fijarlos.
- 4 Conecte el adaptador de corriente a la toma de corriente.
- 5 Conecte el cable de la línea telefónica a la toma de una sola línea telefónica (RJ11C) hasta que escuche un clic.
- 6 Se requiere un filtro DSL/ADSL (no incluido) si dispone de este tipo de servicio.
- 7 Conecte el cable del auricular alámbrico a este y a la unidad base hasta que escuche un clic.

Nota:

Use solo el adaptador de corriente MN0063-L060040 que se incluye.

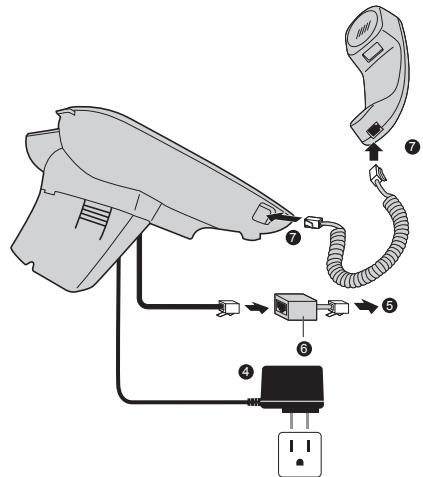
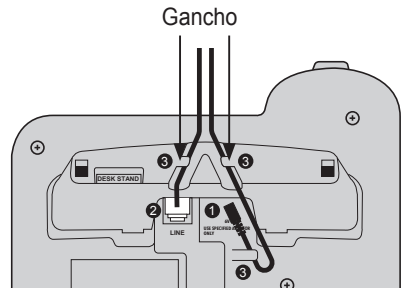

Cargador

- 1 Conecte el adaptador de corriente alterna a la unidad presionándolo firmemente.
- 2 Enganche el cable para fijarlo.
- 3 Conecte el adaptador de corriente a la toma de corriente.

Nota:

Use solo el adaptador de corriente MN0063-L060040 que se incluye.

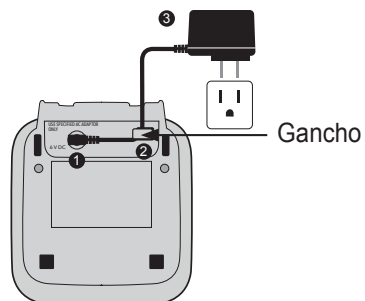

Instalación y carga de la batería

Cargue durante al menos 7 horas.

- 1 Presione **1** hacia abajo.
- 2 Deslice la tapa del auricular **2**.
- 3 Inserte las baterías y, a continuación, cierre la tapa del auricular.

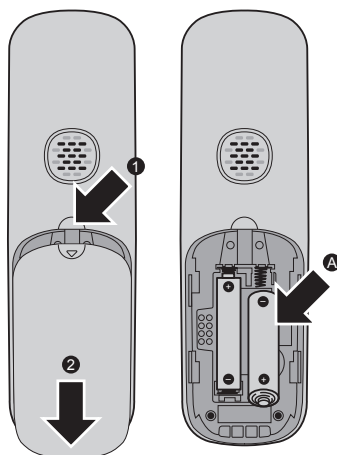

Cuando el auricular necesite carga, la pantalla mostrará el mensaje **"Batería baja"** y se emitirá un pitido de advertencia cada 2 minutos durante una llamada. Recargue el auricular antes de usarlo nuevamente. Cuando se esté cargando el dispositivo, se mostrará el icono  con sus barras en movimiento.

Nota:

- UTILICE SOLO baterías recargables de Ni-MH tamaño AAA (R03) .
- NO utilice baterías alcalinas, de manganeso ni de Ni-Cd.
- Confirme que las polaridades estén correctas.
- Cambie el idioma de la pantalla.

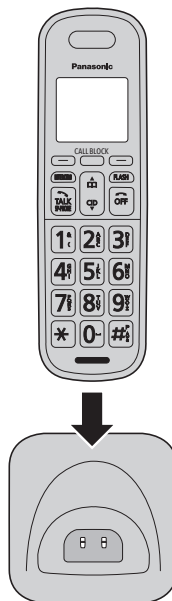

Sugerencias de operación

Teclas de función

Al oprimir una tecla de función, puede seleccionar la función que aparece directamente encima de ella en la pantalla.

Tecla navegadora

Auricular:

- [▲]☐: Ver la lista del directorio telefónico.
- [▼]CID (Identificador de llamada): Ver la lista de llamadas.
- [▲]o[▼]: Navegar por diversas listas o elementos.
- VOLUME (Volumen:[▲]o[▼]): Ajustar el volumen del receptor o el altavoz mientras habla.
- [▲]o[▼]: Mover el cursor para editar un número o nombre.

Unidad base:

- [▲]o[▼]: Navegar por diversas listas o elementos.
- [▲]o[▼]: Ajustar el volumen del receptor o el altavoz mientras habla.
- [▲]o[▼],[◀◀]o[▶▶]: Mover el cursor para editar un número o nombre.
- [◀◀]o[▶▶]: Repetir u omitir el mensaje durante la reproducción.

Auricular:

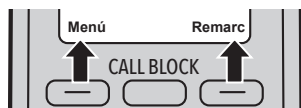

Unidad base:

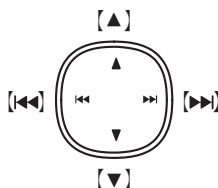

Cómo navegar por los menús

- 1 [Menú] para abrir el menú principal.
- 2 [▲]: Opciones disponibles.
- 3 [OK] para seleccionar una opción.
- 4 Para volver al nivel de menú anterior, oprima [Atrás].
- 5 Para salir del menú y regresar a espera, oprima [OFF] en el auricular o [EXIT/STOP] en la unidad base.

Idioma mostrado en pantalla (Auricular/Unidad base) (predeterminado: "English")

- 1 [Menu],[▼]"Personal set" (Ajuste personal), [OK].
- 2 [▼]"Language" (Idioma), [OK].
- 3 [▲]: Seleccione el idioma de su preferencia, [OK].

Fecha y hora (Auricular)

- 1 [Menú], [▼] “Ajuste personal”, [OK].
- 2 [▼] “Fecha y hora”, [OK].
- 3 Introduzca la fecha con el teclado (p. ej. [0][7][1][2][2][0] para el 12 de julio de 2020), [OK].
- 4 Introduzca la hora con el teclado (p. ej. [0][9][3][0] para las 9:30), [⏸] para seleccionar “AM” o “PM”, [OK].

Modo de marcación (Auricular/Unidad base) (predeterminado: “Tono”)

- 1 [Menú], [▼] “Ajuste avanz.”, [OK].
- 2 [▼] “Modo marcac”, [OK].
- 3 [⏸]: Seleccione “Tono” o “Pulso”, [OK].

Operaciones básicas	
Cómo hacer y contestar llamadas (Auricular)	
Para hacer llamadas	Levante el auricular, marque el número telefónico, [TALK/SP-PHONE].
Para contestar llamadas	Levante el auricular, [TALK/SP-PHONE].
Para colgar	[OFF]
Para ajustar el volumen del receptor o del altavoz	Oprima [⏸] repetidamente mientras habla.
Cómo hacer una llamada usando la lista de remarcación	[Remarc], [⏸]: Seleccione la entrada deseada, [TALK/SP-PHONE].
Cómo hacer y contestar llamadas (Unidad base)	
Para hacer llamadas	Marque el número telefónico. Levante el auricular alámbrico u oprima [SP-PHONE].
Para contestar llamadas	Levante el auricular alámbrico u oprima [SP-PHONE].
Para colgar	Coloque el auricular alámbrico en la base. Cuando utilice el altavoz, oprima [SP-PHONE].
Para ajustar el volumen del receptor o del altavoz	Oprima [⏸] repetidamente mientras habla.
Cómo hacer una llamada usando la lista de remarcación	[Remarc], [⏸]: Seleccione la entrada deseada, levante el auricular alámbrico.
Para ajustar el volumen del timbre (Auricular/Unidad base)	
Para ajustar el volumen del timbre	Oprima [⏸] repetidamente para seleccionar el volumen deseado mientras suena.
Directorio telefónico (Auricular/Unidad base)	
Para añadir entradas	<ol style="list-style-type: none"> 1 [Menú]. “Directorio”. 2 [OK], [▼] “Agregar nueva”. 3 [OK]. “Introd. nombre”. 4 Introduzca el nombre, [OK]. Se muestra “Introd. nombre”. 5 Introduzca el número, [OK].

Directorio telefónico (Auricular/Unidad base)	
Para hacer llamadas	<p>1 Continúe operando su unidad. Auricular: [▲] □□ Unidad base: [□□]</p> <p>2 [↕]: Seleccione la entrada deseada. O Introduzca la primera letra del nombre para realizar una búsqueda en orden alfabético. Se mostrará el primer nombre que comience con dicha letra o con la letra más cercana del alfabeto. [↕]: Seleccione la entrada deseada.</p> <p>3 Continúe operando su unidad. Auricular: [TALK/SP-PHONE]. Unidad base: Levante el auricular alámbrico.</p>
Contestador de llamadas (Unidad base)	
Contestador encendido/apagado	Oprima [ANSWER ON/OFF] para encender y apagar el contestador de llamadas.
Para escuchar mensajes	[PLAY]
Sistema contestador de llamadas (Auricular)	
Para escuchar mensajes	<p>Para escuchar mensajes nuevos: [Escucha]</p> <p>Para escuchar todos los mensajes: [Menú], → [▼] "Contestador", [OK]. [▼] "Reproducir todo", [OK].</p>

Preguntas frecuentes	
Preguntas	Causa y solución
¿Por qué no se muestra Yil ?	<ul style="list-style-type: none"> • El auricular está demasiado lejos de la unidad base. Acérquelo. • El adaptador para corriente de la unidad base no está conectado correctamente. Conecte de nuevo el adaptador para corriente a la unidad base. • El auricular no está registrado en la unidad base. Regístrelo. <p>En la unidad base:</p> <ol style="list-style-type: none"> 1 Mantenga oprimido [LOCATOR/INTERCOM] durante 5 segundos. La unidad base permanecerá en el modo de registro durante 120 segundos. <p>En el auricular:</p> <ol style="list-style-type: none"> 2 Si el auricular no está registrado en una unidad base: “Registrar su Auricular”, oprima [OK]. “Presione locldr. Durante 5 seg.”, oprima [OK] e introduzca el código PIN de 4 dígitos (predeterminado = 0000). [OK]. 3 Si el auricular ya está registrado en una unidad base, oprima [Menú], → [▼] “Ajuste avanz.”, oprima [OK] [▼] “Registrar”, oprima [OK]. 4 “Presione locldr. Durante 5 seg.”, oprima [OK]. 5 Introduzca el código PIN de 4 dígitos (predeterminado = 0000), oprima [OK].
¿Cómo se incrementa el nivel de volumen del auricular?	<ul style="list-style-type: none"> • Oprima repetidamente la tecla de volumen [▲] mientras habla.
¿Por qué hay ruido o se corta la conversación?	<ul style="list-style-type: none"> • Trate de reubicar la unidad base de forma que se minimice la distancia al auricular. • Si ocurre el mismo problema incluso cuando el auricular está junto a la unidad base, visite: http://shop.panasonic.com/support
¿Es posible añadir otro auricular accesorio a mi unidad base?	<ul style="list-style-type: none"> • Sí, puede añadir hasta 4 auriculares (incluyendo los que se venden con su unidad base) a una sola unidad base. • Para adquirir auriculares accesorios adicionales (KX-TGBA85), visite: http://shop.panasonic.com/support Los usuarios de TTY (usuarios con impedimentos auditivos o del habla) pueden llamar al 1-877-833-8855.
¿Es posible mantener cargando las baterías todo el tiempo?	<ul style="list-style-type: none"> • Puede dejar el auricular en el cargador el tiempo que lo desee. Esto no daña las baterías.
¿Cómo se contestan las llamadas en espera (2a llamada)?	<ul style="list-style-type: none"> • Oprima [FLASH] en el auricular o [ERASE/FLASH] en la unidad base cuando escuche el tono de llamada en espera.

Customer services

Shop Accessories!

for all your Panasonic gear

Go to

<http://shop.panasonic.com/support>

Get everything you need to get the most out of
your Panasonic products

Accessories & Parts for your Camera, Phone, A/V
products, TV, Computers & Networking, Personal
Care, Home Appliances, Headphones, Batteries,
Backup Chargers & more...

Customer Services Directory

For Product Information, Operating Assistance,
Parts, Owner's Manuals, Dealer and Service info
go to <http://shop.panasonic.com/support>

For the hearing or speech impaired TTY: 1- 877-833-8855

As of June 2015

Limited Warranty (ONLY FOR U.S.A)

Panasonic Products Limited Warranty

Limited Warranty Coverage (For USA Only)

If your product does not work properly because of a defect in materials or workmanship, Panasonic Corporation of North America (referred to as “the warrantor”) will, for the length of the period indicated on the chart below, which starts with the date of original purchase (“warranty period”), at its option either (a) repair your product with new or refurbished parts, (b) replace it with a new or a refurbished equivalent value product, or (c) refund your purchase price. The decision to repair, replace or refund will be made by the warrantor.

Product or Part Name	Parts	Labor
Telephone	One (1) Year	One (1) Year

During the “Labor” warranty period there will be no charge for labor. During the “Parts” warranty period, there will be no charge for parts. This Limited Warranty excludes both parts and labor for non-rechargeable batteries, antennas, and cosmetic parts (cabinet). This warranty only applies to products purchased and serviced in the United States. This warranty is extended only to the original purchaser of a new product which was not sold “as is”.

Mail-In Service--Online Repair Request

Online Repair Request

To submit a new repair request and for quick repair status visit our Web Site at <http://shop.panasonic.com/support>

When shipping the unit, carefully pack, include all supplied accessories listed in the Owner’s Manual, and send it prepaid, adequately insured and packed well in a carton box. When shipping Lithium Ion batteries please visit our Web Site at <http://shop.panasonic.com/support> as Panasonic is committed to providing the most up to date information. Include a letter detailing the complaint, a return address and provide a daytime phone number where you can be reached. A valid registered receipt is required under the Limited Warranty.

IF REPAIR IS NEEDED DURING THE WARRANTY PERIOD, THE PURCHASER WILL BE REQUIRED TO FURNISH A SALES RECEIPT/PROOF OF PURCHASE INDICATING DATE OF PURCHASE, AMOUNT PAID AND PLACE OF PURCHASE. CUSTOMER WILL BE CHARGED FOR THE REPAIR OF ANY UNIT RECEIVED WITHOUT SUCH PROOF OF PURCHASE.

Limited Warranty Limits and Exclusions

This warranty ONLY COVERS failures due to defects in materials or workmanship, and DOES NOT COVER normal wear and tear or cosmetic damage. The warranty ALSO DOES NOT COVER damages which occurred in shipment, or failures which are caused by products not supplied by the warrantor, or failures which result from accidents, misuse, abuse, neglect, mishandling, misapplication, alteration, faulty installation, set-up adjustments, misadjustment of consumer controls, improper maintenance, power line surge, lightning damage, modification, introduction of sand, humidity or liquids, commercial use such as hotel, office, restaurant, or other business or rental use of the product, or service by anyone other than a Factory Service Center or other Authorized Servicer, or damage that is attributable to acts of God.

THERE ARE NO EXPRESS WARRANTIES EXCEPT AS LISTED UNDER "LIMITED WARRANTY COVERAGE".

THE WARRANTOR IS NOT LIABLE FOR INCIDENTAL OR CONSEQUENTIAL DAMAGES RESULTING FROM THE USE OF THIS PRODUCT, OR ARISING OUT OF ANY BREACH OF THIS WARRANTY.

(As examples, this excludes damages for lost time, travel to and from the servicer, loss of or damage to media or images, data or other memory or recorded content.

The items listed are not exclusive, but for illustration only.)

ALL EXPRESS AND IMPLIED WARRANTIES, INCLUDING THE WARRANTY OF MERCHANTABILITY, ARE LIMITED TO THE PERIOD OF THE LIMITED WARRANTY.

Some states do not allow the exclusion or limitation of incidental or consequential damages, or limitations on how long an implied warranty lasts, so the exclusions may not apply to you. This warranty gives you specific legal rights and you may also have other rights which vary from state to state. If a problem with this product develops during or after the warranty period, you may contact your dealer or Service Center. If the problem is not handled to your satisfaction, then write to:

Panasonic Corporation of North America
Consumer Affairs Department 8th Fl.
Two Riverfront Plaza
Newark NJ 07102-5490

PARTS AND SERVICE, WHICH ARE NOT COVERED BY THIS LIMITED WARRANTY, ARE YOUR RESPONSIBILITY.

As of January 2020

Index

- A
 - Alarm: 24
 - Answering calls: 15
 - Answering system
 - Call screening: 29
 - Deleting all messages: 31
 - Greeting message: 29
 - Listening to messages: 30
 - Memory capacity: 29
 - On/off: 29
 - Recording a memo message: 31
 - Remote access: 31
 - Ring count: 31
 - Security code: 32
 - TAM language: 32
 - Auto answer: 24
 - Auto clock: 26
 - Auto hang-up: 24
- B
 - Base unit speakerphone: 14
 - Base unit controls: 11
 - Battery
 - Battery level: 9
 - Caution: 6
 - Charging: 9
 - Installation: 8
 - Note for battery charging: 9
 - Note for battery installation: 9
 - Performance: 9
 - Tone: 24
 - Type: 3
- C
 - Call block: 25
 - Caller ID: 21
 - Call waiting: 15
 - Call Waiting Caller ID: 15
 - Conference call: 17
 - Connections
 - Base unit: 8
 - Charger: 8
 - Note: 9
- D
 - Date and time: 12, 24
 - Default settings: 27
 - De-registering a handset: 27
 - Dial mode: 12, 26
 - Display icons: 12
 - Docking tone: 23
 - During a power failure: 9
- F
 - Flash: 15
 - Flash time: 26
- H
 - Handset
 - Controls: 10
 - Equalizer: 16
 - Locator: 17
 - Name: 24
 - Handset speakerphone: 14
- I
 - Intercom: 16
- K
 - Key tones: 23
- L
 - Language: 24
- M
 - Making calls: 14
 - Menu Map: 13
 - Mute: 15
- N
 - Navigating the menus: 12
- P
 - Pause: 14
 - Phonebook: 18
 - PIN code: 26
 - Power failure: 9
- R
 - Redial
 - Deleting a number or the entire list: 14
 - Making a call: 14
 - Storing a number to the phonebook: 18
 - Registering a handset: 26
 - Restore default settings: 27
 - Ringer melody: 23
 - Ringer volume: 23
 - Rotary/pulse service: 15
- S
 - Silent mode: 23
 - Speed dial: 19
 - SP-PHONE (Speakerphone): 14
 - Specifications: 7
- T
 - Temporary tone dialing: 15
 - Transferring calls: 16
- Troubleshooting: 34

TTY: 43

V Voicemail: 33

W Wall mounting: 33

IMPORTANT!

If your product is not working properly. . .

- ① Reconnect AC adaptor to the base unit.
- ② Check if telephone line cord is connected.
- ③ Use rechargeable Ni-MH batteries.
(Alkaline/Manganese/Ni-Cd batteries CANNOT be used.)
- ④ Read **troubleshooting** page in the **Operating Instructions**.



Visit our Web site: <http://shop.panasonic.com/support>

- FAQ and troubleshooting hints are available.

For your future reference

We recommend keeping a record of the following information to assist with any repair under warranty.

Serial No.	Date of purchase
(found on the bottom of the base unit)	
Name and address of dealer	

Attach your purchase receipt here.

Panasonic Corporation of North America
Two Riverfront Plaza, Newark, NJ 07102-5490

© Panasonic Corporation 2020

Printed in China

PNQE1138ZA SS0120MU0