

Panasonic®

Owner's Manual High Definition Video Camera

Model No. **HDC-TM900P/PC**
HDC-HS900P/PC

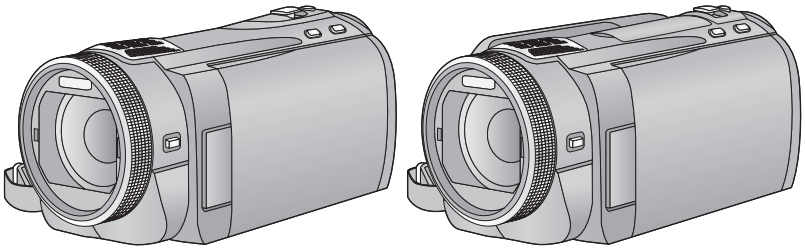

Before connecting, operating or adjusting this product, please read the instructions completely.

AVCHD™

DOLBY
DIGITAL
5.1 CREATOR

LEICA
DICOMAR

SD™
XC

HDMI

VIERA Link™

BD

For USA and Puerto Rico assistance, please call: 1-800-211-PANA(7262) or,
contact us via the web at: <http://www.panasonic.com/contactinfo>

For Canadian assistance, please call: 1-800-561-5505 or visit us at www.panasonic.ca

VQT3K69

Things You Should Know

Thank you for choosing Panasonic! You have purchased one of the most sophisticated and reliable products on the market today. Used properly, we're sure it will bring you and your family years of enjoyment. Please take time to fill in the information on the right. The serial number is on the tag located on the back of your camera. Be sure to **retain this manual** as your convenient camera information source.

Date of Purchase _____

Dealer Purchased From _____

Dealer Address _____

Dealer Phone No. _____

Model No. _____

Serial No. _____

Safety Precautions

WARNING:





TO REDUCE THE RISK OF FIRE, ELECTRIC SHOCK OR PRODUCT DAMAGE,

- **DO NOT EXPOSE THIS APPARATUS TO RAIN, MOISTURE, DRIPPING OR SPLASHING AND THAT NO OBJECTS FILLED WITH LIQUIDS, SUCH AS VASES, SHALL BE PLACED ON THE APPARATUS.**
- **USE ONLY THE RECOMMENDED ACCESSORIES.**
- **DO NOT REMOVE THE COVER (OR BACK); THERE ARE NO USER SERVICEABLE PARTS INSIDE. REFER SERVICING TO QUALIFIED SERVICE PERSONNEL.**

CAUTION!

DO NOT INSTALL OR PLACE THIS UNIT IN A BOOKCASE, BUILT-IN CABINET OR IN ANOTHER CONFINED SPACE. ENSURE THE UNIT IS WELL VENTILATED. TO PREVENT RISK OF ELECTRIC SHOCK OR FIRE HAZARD DUE TO OVERHEATING, ENSURE THAT CURTAINS AND ANY OTHER MATERIALS DO NOT OBSTRUCT THE VENTILATION VENTS.

The following mark and symbols are located on bottom of the unit.

	CAUTION RISK OF ELECTRIC SHOCK DO NOT OPEN		
CAUTION: TO REDUCE THE RISK OF ELECTRIC SHOCK, DO NOT REMOVE SCREWS. NO USER-SERVICEABLE PARTS INSIDE. REFER SERVICING TO QUALIFIED SERVICE PERSONNEL.			

The lightning flash with arrowhead symbol, within an equilateral triangle, is intended to alert the user to the presence of uninsulated "dangerous voltage" within the product's enclosure that may be of sufficient magnitude to constitute a risk of electric shock to persons.

The exclamation point within an equilateral triangle is intended to alert the user to the presence of important operating and maintenance (servicing) instructions in the literature accompanying the appliance.

THE FOLLOWING APPLIES ONLY IN THE U.S.A.

FCC Note:

This equipment has been tested and found to comply with the limits for a Class B digital device, pursuant to Part 15 of the FCC Rules. These limits are designed to provide reasonable protection against harmful interference in a residential installation. This equipment generates, uses, and can radiate radio frequency energy and, if not installed and used in accordance with the instructions, may cause harmful interference to radio communications. However, there is no guarantee that interference will not occur in a particular installation. If this equipment does cause harmful interference to radio or television reception, which can be determined by turning the equipment off and on, the user is encouraged to try to correct the interference by one or more of the following measures:

- Reorient or relocate the receiving antenna.
- Increase the separation between the equipment and receiver.
- Connect the equipment into an outlet on a circuit different from that to which the receiver is connected.
- Consult the dealer or an experienced radio/TV technician for help.

FCC Caution: To assure continued compliance, follow the attached installation instructions and use only shielded interface cables with ferrite core when connecting to computer or peripheral devices.

Any changes or modifications not expressly approved by the party responsible for compliance could void the user's authority to operate this equipment.

Declaration of Conformity

Trade Name: Panasonic
Model No.: HDC-TM900P/HDC-HS900P
Responsible party: Panasonic Corporation of North America
One Panasonic Way, Secaucus, NJ 07094
Support Contact: Panasonic Consumer Electronics Company
1-800-211-PANA (7262)

This device complies with Part 15 of the FCC Rules. Operation is subject to the following two conditions: (1) This device may not cause harmful interference, and (2) this device must accept any interference received, including interference that may cause undesired operation.



THE FOLLOWING APPLIES ONLY IN CANADA.

This Class B digital apparatus complies with Canadian ICES-003.

AC adaptor

This AC adaptor operates on AC between 110 V and 240 V.

But

- In the U.S.A. and Canada, the AC adaptor must be connected to a 120 V AC power supply only.
- When connecting to an AC supply outside of the U.S.A. or Canada, use a plug adaptor to suit the AC outlet configuration.
- When connecting to a supply of greater than AC 125 V, ensure the cord you use is suited to the voltage of the AC supply and the rated current of the AC adaptor.
- Contact an electrical parts distributor for assistance in selecting a suitable AC plug adaptor or AC cord set.

The unit should be installed near an accessible AC power outlet, with the power cord connected directly to it.

To completely disconnect power from the unit, unplug the power cord from the AC power outlet.

■ Concerning the battery

Batteries

1 Battery pack (Lithium ion battery pack)

- Use the specified unit to recharge the battery pack.
- Do not use the battery pack with equipment other than the specified unit.
- Do not get dirt, sand, liquids, or other foreign matter on the terminals.
- Do not touch the plug terminals (+ and -) with metal objects.
- Do not disassemble, remodel, heat or throw into fire.

2 Button-type battery (Lithium battery)

- Insert with poles aligned.
- Do not touch the terminals (+ and -) with metal objects.
- Do not recharge, disassemble, remodel, heat or throw into fire.
- Keep out of reach of children.

If any electrolyte should come into contact with your hands or clothes, wash it off thoroughly with water.

If any electrolyte should come into contact with your eyes, never rub the eyes. Rinse eyes thoroughly with water, and then consult a doctor.

Warning

Risk of fire, explosion and burns. Do not disassemble.

Do not heat the batteries above the following temperatures or incinerate.

Button-type battery 60 °C (140 °F)

Battery pack 60 °C (140 °F)

CAUTION

Danger of explosion if battery is incorrectly replaced. Replace only with the same or equivalent type recommended by the manufacturer. Dispose of used batteries according to the manufacturer's instructions.

■ Product Identification Marking

Product	Location
High Definition Video Camera	Battery holder
AC adaptor	Bottom

U.S.A./CANADA CONSUMERS: ATTENTION:



A lithium ion/polymer battery that is recyclable powers the product you have purchased. Please call 1-800-8-BATTERY for information on how to recycle this battery.

<For USA-California only>

This product contains a CR Coin Cell Lithium Battery which contains Perchlorate Material – special handling may apply.

See www.dtsc.ca.gov/hazardouswaste/perchlorate.

IMPORTANT SAFETY INSTRUCTIONS

Read these operating instructions carefully before using the unit. Follow the safety instructions on the unit and the applicable safety instructions listed below. Keep these operating instructions handy for future reference.

- 1) Read these instructions.
- 2) Keep these instructions.
- 3) Heed all warnings.
- 4) Follow all instructions.
- 5) Do not use this apparatus near water.
- 6) Clean only with dry cloth.
- 7) Do not block any ventilation openings. Install in accordance with the manufacturer's instructions.
- 8) Do not install near any heat sources such as radiators, heat registers, stoves, or other apparatus (including amplifiers) that produce heat.
- 9) Do not defeat the safety purpose of the polarized or grounding-type plug. A polarized plug has two blades with one wider than the other. A grounding-type plug has two blades and a third grounding prong. The wide blade or the third prong are provided for your safety. If the provided plug does not fit into your outlet, consult an electrician for replacement of the obsolete outlet.
- 10) Protect the power cord from being walked on or pinched particularly at plugs, convenience receptacles, and the point where they exit from the apparatus.
- 11) Only use attachments/accessories specified by the manufacturer.
- 12) Use only with the cart, stand, tripod, bracket, or table specified by the manufacturer, or sold with the apparatus. When a cart is used, use caution when moving the cart/apparatus combination to avoid injury from tip-over.
- 13) Unplug this apparatus during lightning storms or when unused for long periods of time.
- 14) Refer all servicing to qualified service personnel. Servicing is required when the apparatus has been damaged in any way, such as power-supply cord or plug is damaged, liquid has been spilled or objects have fallen into the apparatus, the apparatus has been exposed to rain or moisture, does not operate normally, or has been dropped.



Precautions

USE & LOCATION

WARNING

- **TO AVOID SHOCK HAZARD** ... Your camera and power supply should not be exposed to rain or moisture. Do not connect the power supply or operate your camera if it gets wet. Your camera has been designed for outdoor use, however it is not designed to sustain direct exposure to water, rain, sleet, snow, sand, dust, or a direct splashing from a pool or even a cup of coffee. This action could permanently damage the internal parts of your camera. Do not attempt to disassemble this unit. There are no user serviceable parts inside. Unplug your camera from the power supply before cleaning.
- **AS WITH ANY SMALL OBJECT, SD CARDS CAN BE SWALLOWED BY YOUNG CHILDREN. DO NOT ALLOW CHILDREN TO HANDLE THE SD CARD.**

CAUTION

- **DO NOT AIM YOUR CAMERA AT THE SUN OR OTHER BRIGHT OBJECTS**
- **DO NOT LEAVE THE CAMERA WITH THE EVF AIMED DIRECTLY AT THE SUN AS THIS MAY CAUSE DAMAGE TO THE INTERNAL PARTS OF THE EVF**
- **DO NOT EXPOSE YOUR CAMERA TO EXTENDED HIGH TEMPERATURE** ... Such as, in direct sunlight, inside a closed car, next to a heater, etc... This action could permanently damage the internal parts of your camera.
- **AVOID SUDDEN CHANGES IN TEMPERATURE** ... If the unit is suddenly moved from a cold place to a warm place, moisture may form on the SD card and inside the unit.
- **DO NOT LEAVE YOUR CAMERA OR THE POWER SUPPLY TURNED ON WHEN NOT IN USE.**

- **STORAGE OF YOUR CAMERA** ... Store and handle your camera in a manner that will not subject it to unnecessary movement (avoid shaking and striking). Your camera contains a sensitive pick-up device which could be damaged by improper handling or storage.

CARE

- **TO CLEAN YOUR CAMERA** ... Do not use strong or abrasive detergents when cleaning your camera body.
- **TO PROTECT THE LENS** ... Do not touch the surface of the lens with your hand. Use a commercial camera lens solution and lens paper when cleaning the lens. Improper cleaning can scratch the lens coating.
- **TO PROTECT THE FINISH OF YOUR CAMERA** ... Before handling your camera, make sure your hands and face are free from any chemical products, such as suntan lotion, as it may damage the finish.

-If you see this symbol-

Information on Disposal in other Countries outside the European Union



This symbol is only valid in the European Union.
If you wish to discard this product, please contact your local authorities or dealer and ask for the correct method of disposal.

■ About the recording format for recording motion pictures

You can select from AVCHD, 1080/60p or iFrame recording formats to record motion pictures using this unit. (→ 57, 67)

AVCHD:

You can record high definition quality images with this format. It is suitable for viewing on a large format TV or for saving to disc.

1080/60p:

This is a 1080/60p (1920×1080/60 progressive) recording mode that can record in maximum quality*. The scenes recorded in 1080/60p can be saved or played back by this unit or the HD Writer AE 3.0.

* This means the highest quality for this unit.

iFrame:

This is a recording format suitable for playing back or editing on Mac (iMovie'11). Using iMovie'11, iFrame motion pictures can be imported faster than AVCHD motion pictures. Also, the imported file size of iFrame motion pictures will be smaller than that of AVCHD motion pictures.

- It is not compatible with motion pictures recorded in AVCHD or 1080/60p format.

■ Indemnity about recorded content

Panasonic does not accept any responsibility for damages directly or indirectly due to any type of problems that result in loss of recording or edited content, and does not guarantee any content if recording or editing does not work properly. Likewise, the above also applies in a case where any type of repair is made to the unit (including any other non-built-in memory/HDD related component).

■ Handling of built-in memory [HDC-TM900]

This unit is equipped with the built-in memory. When using this component, pay attention to the following points.

Back up data periodically.

The built-in memory is temporary storage. In order to avoid erasing data due to static electricity, electromagnetic waves, breakage, and failures, back up the data to a PC or DVD disc. (→ 113, 125)

- Access lamp [ACCESS] (→ 17)
 - illuminates while the SD card or built-in memory is being accessed (initialization, recording, playback, deleting etc.). Do not perform the following operations when the lamp illuminates. It may damage the built-in memory or cause a malfunction in the unit.
 - Turn the unit off (remove the battery)
 - Insert and remove the USB cable
 - Expose the unit to vibrations or shock
- About disposing of or giving away this unit. (→ 149)

■ Handling of HDD [HDC-HS900]

This unit is equipped with the built-in HDD. While the HDD is capable of storing a large amount of data, there are a few things to look out for. When using this component, pay attention to the following points.

Do not expose the HDD to vibrations and shocks.

Due to the environment and handling conditions, the HDD may be subject to partial damages or may not be able to read, record, and play back data. Do not expose the unit to vibrations or shock, and do not turn off the unit during recording or playback.

If the unit is used in a place with loud sounds, such as a club or similar venue, the recording may stop due to sound vibrations. Recording data on an SD card is recommended in these places.

Back up data periodically.

The HDD is temporary storage. In order to avoid erasing data due to static electricity, electromagnetic waves, breakage, and failures, back up the data to a PC or DVD disc. (→ 113, 125)

If the HDD experiences any abnormality, back up data immediately.

Failure in the HDD may produce continuous noise or choppy sound during recording or playing back. Continuous use will cause further deterioration, and may eventually disable the HDD. If these phenomena are observed, copy the data on the HDD to a PC, a DVD disc etc. immediately and contact consumer support. (→ 168, 169) Once the HDD is out of order, data cannot be restored.

Operation may stop in hot or cold environments.

The unit is disabled in order to protect the HDD.

Do not use the unit in low atmospheric pressures.

The HDD may fail if it is used at altitudes of 3000 m (9800 feet) or higher above sea level.

Transportation

When the unit is transported, turn off the unit and be careful not to shake, drop, or cause impact to the unit.

Falling detection

[] is indicated on the screen when it detects a falling state (a weightless state). If the falling state is detected repeatedly, the unit may stop the recording or playback operation in order to protect the HDD.



- HDD access lamp [ACCESS HDD] (→ 20) illuminates while the HDD is being accessed (initialization, recording, playback, deleting etc.). Do not perform the following operations when the lamp illuminates. It may damage the HDD or cause a malfunction in the unit.
 - Turn the unit off (remove the battery)
 - Insert and remove the USB cable
 - Expose the unit to vibrations or shock
- About disposing of or giving away this unit. (→ 149)

■ Cards that you can use with this unit

SD Memory Card, SDHC Memory Card and SDXC Memory Card

- 4 GB or more Memory Cards that do not have the SDHC logo or 48 GB or more Memory Cards that do not have the SDXC logo are not based on SD Memory Card Specifications.
- Refer to page 26 for more details on SD cards.

■ For the purposes of this owner's manual

- SD Memory Card, SDHC Memory Card and SDXC Memory Card are referred to as the "SD card".
- Functions that can be used for Motion Picture Recording Mode: 
Functions that can be used for Still Picture Recording Mode: 
- Functions that can be used for Motion Picture Playback Mode: **VIDEO**
Functions that can be used for Still Picture Playback Mode: **PHOTO**
- Pages for reference are indicated by an arrow, for example: → 00

This owner's manual is designed for use with models **HDC-TM900** and **HDC-HS900**. Pictures may be slightly different from the original.

- The illustrations used in this owner's manuals show model **HDC-TM900**, however, parts of the explanation refer to different models.
- Depending on the model, some functions are not available.
- Features may vary, so please read carefully.
- Not all models may be available depending on the region of purchase.

Contents

Accessories	12
Quick Guide	13

Preparation

Parts identification and handling	17
Power supply	21
Inserting/removing the battery	21
Charging the battery	22
Charging and recording time	23
Recording to a card	26
Cards that you can use with this unit	26
Inserting/removing an SD card	27
Turning the unit on/off	28
Turning the unit on and off with the power button	28
Turning the unit on and off with the LCD monitor/viewfinder	28
Selecting a mode	29
How to use the touch screen	29
About the Touch Menu	30
Setting date and time	31

Basic

Before recording	32
Selecting a media to record	34
Recording motion pictures	35
Recording still pictures	37
Recording still pictures in Motion Picture Recording Mode	38
Intelligent Auto Mode	39
Motion picture/Still picture playback	41
Using the menu screen	44
Using the quick menu	45
Using the Setup Menu	46
Using with the remote control	53
Operation of direction buttons/ OK button	54

Advanced (Recording)

Zoom in/out function	55
About the zoom speed	55
Ring zoom	55
Extra Optical Zoom	55
Image Stabilizer Function	56
1080/60p recording	57
Recording with the Touch function	58
Touch function icons	58
Recording functions of operation icons	61
Operation icons	61
Recording functions of menus	66
Manual recording	82
White balance	83
Manual shutter speed/iris adjustment	84
Recording with Manual focus	85
Recording 3D video	86
Functions not available during 3D recording	88

Advanced (Playback)

Playback Operations	89
Motion picture playback using operation icon	89
Creating still picture from motion picture	90
Highlight&Time frame index	90
Repeat playback	91
Resuming the previous playback	91
Zooming in on a still picture during playback (Playback zoom)	91
Various playback functions	92
Playing back motion pictures/ still pictures by date	92
Highlight Playback	93
Changing the playback settings and playing back the slide show	95

Deleting scenes/still pictures	96
Dividing a scene (AVCHD, 1080/60p)	97
Dividing a scene to partially delete (iFrame)	98
Deleting personal information	99
Protecting scenes/still pictures	99
DPOF setting	100
Relay scene combining	
[HDC-TM900]	101
Watching Video/Pictures on your TV	103
Connecting with a HDMI mini cable	106
Listening in 5.1 channel sound (AVCHD, 1080/60p)	106
Connecting with the AV multi cable	106
Playback using VIERA Link™	107
3D video playback	109
Functions not available during 3D playback	110

Copy/Dubbing

Copying between SD card and Built-in Memory/HDD	111
Connecting a DVD burner to copy to/ play back a disc	113
Preparing for copying/ playing back	113
Copying to discs	115
Playing back the copied disc	117
Managing the copied disc	118
Dubbing with a Blu-ray disc recorder, video device, etc.	119
3D video storage	123

With a PC

What you can do with a PC	125
End User License Agreement	127
Operating environment	128
Installation	131
Connecting to a PC	133
About the PC display	135
Starting HD Writer AE 3.0	136
Reading the operating instructions of the software applications	136
If using Mac	136

Others

Indications	138
Messages	141
About recovery	142
Troubleshooting	143
Cautions for use	148
About copyright	154
Recording modes/approximate recordable time	155
Approximate number of recordable pictures	156
Specifications	158
Optional accessories	163
Accessory Order Form (For USA and Puerto Rico Customers)	166
Limited Warranty (ONLY FOR U.S.A. AND PUERTO RICO)	167
Warranty (For Canadian Customers)	169
Index	170
Spanish Quick Use Guide/ Guía española para el uso rápido	172

Accessories

Check the accessories before using this unit.

Keep the accessories out of reach of children to prevent swallowing.

Product numbers correct as of Dec. 2010. These may be subject to change.

Battery pack

VW-VBN130



CD-ROM

Software



AC adaptor

VSK0732



AC cable

K2CA2CA00025



Remote control (Built-in battery)

N2QAEC000024



AV multi cable

K1HY12YY0008



USB cable

K1HA05AD0007



Stylus pen

VGQ0C14



- This is used for operations that are hard to operate with your fingers or performing detailed operations with the touch screen operation. (→ 29, 52)

Lens hood

VDW2053



Shoe adaptor

(supplied for HDC-TM900;
not supplied for HDC-HS900)
VYC0996



Quick Guide

■ Inserting the battery

Install the battery by inserting it in the direction shown in the figure.

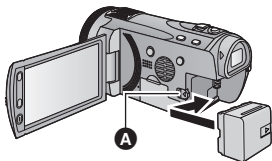

- **A** Insert the battery until it clicks and locks.

■ Charging the battery

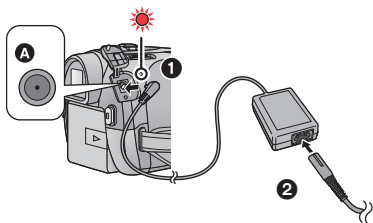

- **A** DC input terminal
- **1** Connect the AC adaptor to the DC input terminal.
- **2** Connect the AC cable to the AC adaptor, then the AC outlet.
- The status indicator will flash red at an interval of 2 seconds, indicating that charging has begun. It will turn off when the charging is completed.

■ Inserting/removing an SD card

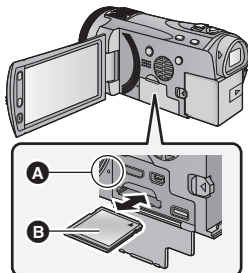

Access lamp [ACCESS] **A**

- When this unit is accessing the SD card or built-in memory, the access lamp lights up.

- 1) Open the LCD monitor.
- 2) Check that the access lamp has gone off.
- 2) Open the SD card/terminal cover and insert (remove) the SD card into (from) the card slot.
- Face the label side **B** in the direction shown in the illustration and press it straight in as far as it will go.
- Press the center of the SD card and then pull it straight out.
- 3) Securely close the SD card/terminal cover.
- Securely close it until it clicks.

■ Turning the unit on/off

Turning the unit on and off with the power button

Press the power button to turn on the unit.

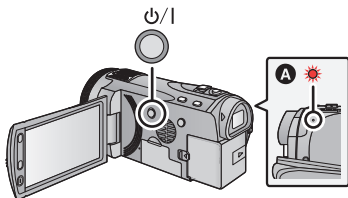

- A** The status indicator lights on.
- To turn off the unit, hold down the power button until the status indicator goes off.

Turning the unit on and off with the LCD monitor/viewfinder

Opening the LCD monitor or extending the viewfinder turns on the unit. Closing the LCD monitor/viewfinder turns off the unit.

To turn on the unit

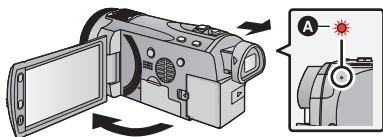

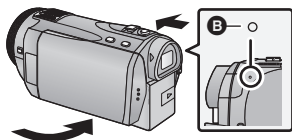

- A** The status indicator lights on.

To turn off the unit





- B** The status indicator goes off.

■ Selecting a mode

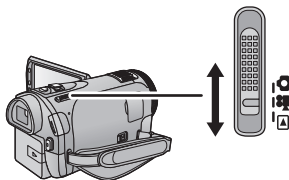
Operate the mode switch to change the mode to ,  or .



	Motion Picture Recording Mode (→ 35)
	Still Picture Recording Mode (→ 37)
	Playback Mode (→ 41, 89)

■ How to use the touch screen

You can operate by directly touching the LCD monitor (touch screen) with your finger. It is easier to use the stylus pen (supplied) for detailed operation or if it is hard to operate with your fingers.

Touch

Touch and release the touch screen to select icon or picture.

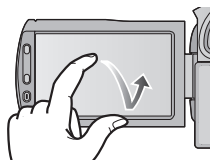

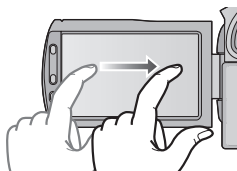

Slide while touching

Move your finger while pressing on the touch screen.



Touch Menu

Touch  to display the Touch Menu.
Touch ◀ (left side)/▶ (right side) of  on the Touch Menu to switch the operation icons.

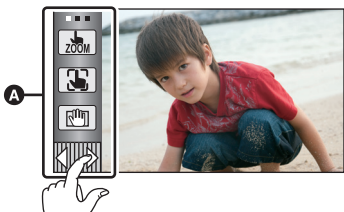



A Touch Menu

Language selection

- 1) Touch [MENU], then touch [SETUP] → [LANGUAGE].
- 2) Touch desired language.

Selecting a media to record

- 1) Change the mode to  or .
- 2) Select the menu.



MENU : [MEDIA SELECT]

- 3) Touch the media to record motion pictures or still pictures.
 - Touch [VIDEO/SD CARD] or [PICTURE/SD CARD] to record to the SD card.
HDC-TM900
Touch [VIDEO/Built-inMemory] or [PICTURE/Built-inMemory] to record to the built-in memory.
HDC-HS900
Touch [VIDEO/HDD] or [PICTURE/HDD] to record to the HDD.
 - The media is selected separately to motion pictures or still pictures is highlighted in yellow.
- 4) Touch [ENTER].

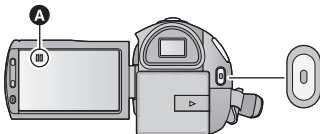

Recording motion pictures

- 1) Change the mode to .
- 2) Open the LCD monitor or extend the viewfinder.
- 3) Press the recording start/stop button to start recording.



A When you begin recording,  changes to .

Recording still pictures

- 1) Change the mode to .
- 2) Open the LCD monitor or extend the viewfinder.
- 3) Press the  button fully to take the picture.

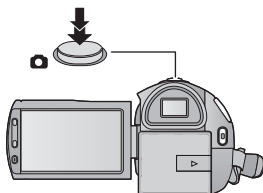

■ Motion picture/Still picture playback

- 1) Change the mode to .
- 2) Touch the play mode select icon **A**.



- 3) Select the [MEDIA] and [VIDEO/PICTURE] you wish to play back.
 - Touch [ENTER].
- 4) Touch the scene or the still picture to be played back.

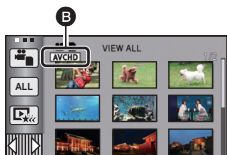

- B** [1080/60p] is displayed when [1080/60p] is touched, [AVCHD] is displayed when [AVCHD] is touched or [iFrame] is displayed when [iFrame] is touched in step 3.

- To display the next (previous) page:
 - Slide the thumbnail display upward (downward) while touching it.
 - Switch the Touch Menu, and then touch ▲ (up)/ ▼ (down) on the thumbnail scroll lever.



- 5) Select the playback operation by touching the operation icon.

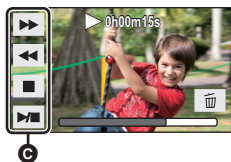

C Operation icon

- Operation icons and screen display will disappear when no function is performed

for a specific period of time. To display them again, touch the screen.

(Motion picture playback)

- ▶/||: Playback/Pause
- ◀◀: Rewind playback
- ▶▶: Fast forward playback
- : Stops the playback and shows the thumbnails.

(Still picture playback)

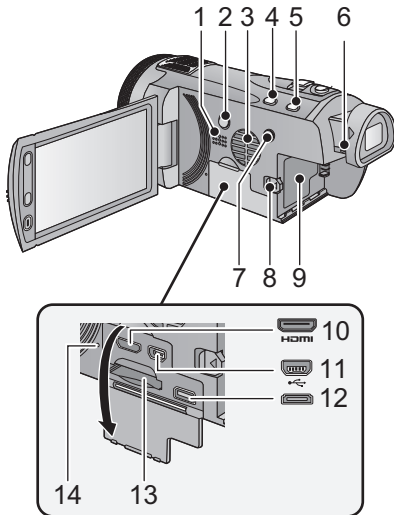

- ▶/||: Slide show (playback of the still pictures in numerical order) start/pause.
- ◀||: Plays back the previous picture.
- ||▶: Plays back the next picture.
- : Stops the playback and shows the thumbnails.

Parts identification and handling

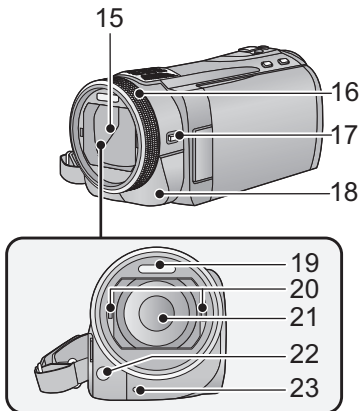

- 1 Speaker
- 2 Power button [⏻/⏺] (→ 28)
- 3 Inlet (cooling fan) (→ 32)
- 4 Intelligent auto/Manual button [iA/MANUAL] (→ 39, 82)
- 5 Optical image stabilizer button [O.I.S.] (→ 56)
- 6 Eyepiece corrector dial (→ 33)
- 7 1080/60p button [1080/60p] (→ 57)
- 8 Battery release lever [BATT] (→ 21)
- 9 Battery holder (→ 21)
- 10 HDMI mini connector [HDMI] (→ 103, 107)
- 11 USB terminal [↔] (→ 114, 119, 133)
- 12 AV multi connector (→ 103, 122)
 - Use the AV multi cable (only the supplied cable).
- 13 Card slot (→ 27)
- 14 Access lamp [ACCESS] (→ 27)



- 15 Lens cover
 - The lens cover opens in  Motion Picture Recording Mode or  Still Picture Recording Mode. (→ 29)
- 16 Multi manual ring (→ 82, 85)
- 17 Camera function button [CAMERA FUNCTION] (→ 82)
- 18 Remote control sensor (→ 54)
- 19 Built-in flash (→ 63)
- 20 3D Conversion Lens attachment part (concave) (→ 86)
- 21 Lens (LEICA DICOMAR)
 - Please refer to page 33 for details about attaching the lens hood.
- 22 AF assist lamp (→ 81)
- 23 Recording lamp (→ 49)

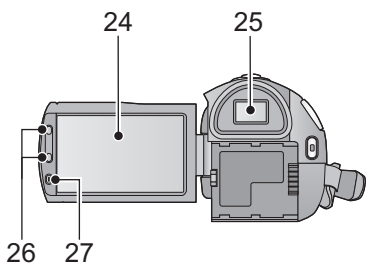

24 LCD monitor (Touch screen) (→ 29)

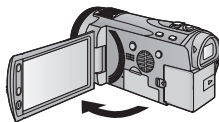

- It can open up to 90°.

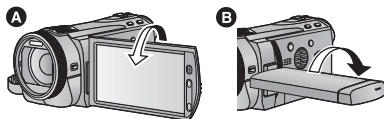

- It can rotate up to 180° **A** towards the lens or 90° **B** towards the viewfinder.

Due to limitations in LCD production technology, there may be some tiny bright or dark spots on the LCD monitor screen. However, this is not a malfunction and does not affect the recorded picture.

25 Viewfinder (→ 33)

Due to limitations in LCD production technology, there may be some tiny bright or dark spots on the viewfinder screen. However, this is not a malfunction and does not affect the recorded picture.

26 Zoom buttons (→ 55)

27 Sub recording start/stop button (→ 32)

- This button functions in the same manner as the recording start/stop button.

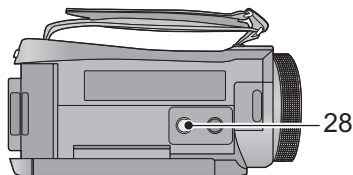

28 Tripod receptacle

- If you attach a tripod which has 5.5 mm (0.22 ") screw or larger, it may damage this unit.

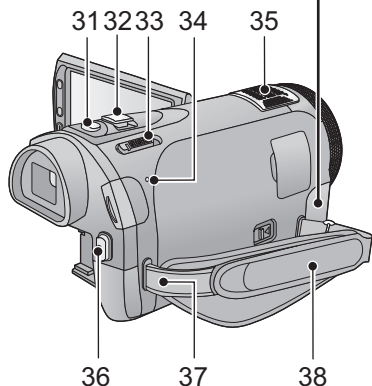
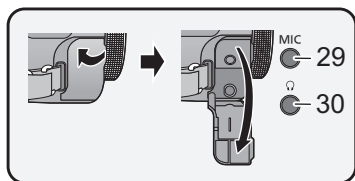

29 Microphone terminal [MIC]

- A compatible plug-in powered microphone can be used as an external microphone.
- Audio will be stereo (2 ch) with the external microphone input.
- (Microphone input level meter) is displayed when the external microphone is connected. (→ 75)
- When the unit is connected with the AC adaptor, sometimes noise may be heard depending on the microphone type. In this case, please switch to the battery for the power supply and the noise will stop.

30 Headphone terminal [] (→ 65)

31 Photoshot button [] (→ 75)

32 Zoom lever [W/T] (In Motion Picture Recording Mode or Still Picture Recording Mode) (→ 55)

Thumbnail display switch [/]/
Volume lever [-VOL+] (In Playback Mode) (→ 42)

33 Mode switch (→ 29)

34 Status indicator (→ 28)

35 Internal microphones

36 Recording start/stop button (→ 35)

37 Shoulder strap fixture

38 Grip belt

Adjust the length of the grip belt so that it fits your hand.

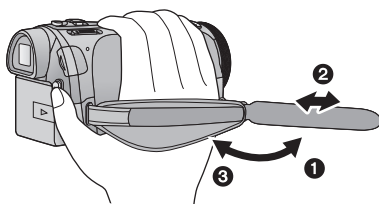

- 1 Flip the belt.
- 2 Adjust the length.
- 3 Replace the belt.

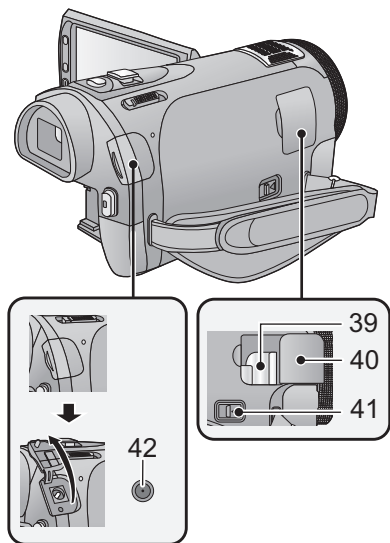

- 39 Shoe adaptor mount (→ 165)
 40 Shoe adaptor cover (→ 165)
 41 Shoe adaptor release lever
 [SHOE ADAPTOR RELEASE] (→ 165)
 42 DC input terminal [DC IN] (→ 22)
- Do not use any other AC adaptors except the supplied one.

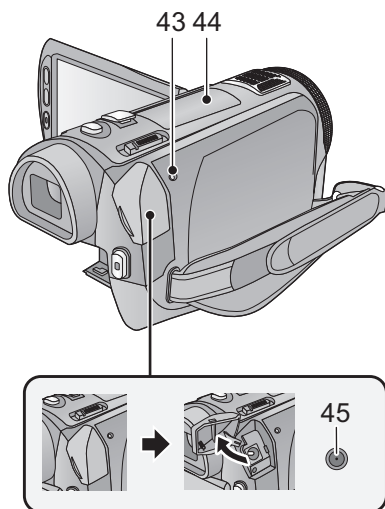

- 43 HDD access lamp [ACCESS HDD]
 44 Accessory shoe (→ 165)
 45 DC input terminal [DC IN] (→ 22)
- Do not use any other AC adaptors except the supplied one.

Power supply

■ About batteries that you can use with this unit

The battery that can be used with this unit is VW-VBN130/VW-VBN260.

- The unit has a function for distinguishing batteries which can be used safely. The dedicated battery (VW-VBN130/VW-VBN260) supports this function. The only batteries suitable for use with this unit are genuine Panasonic products and batteries manufactured by other companies and certified by Panasonic. (Batteries which do not support this function cannot be used). Panasonic cannot in any way guarantee the quality, performance or safety of batteries which have been manufactured by other companies and are not genuine Panasonic products.

It has been found that counterfeit battery packs which look very similar to the genuine product are made available to purchase in some markets. Some of these battery packs are not adequately protected with internal protection to meet the requirements of appropriate safety standards. There is a possibility that these battery packs may lead to fire or explosion. Please be advised that we are not liable for any accident or failure occurring as a result of use of a counterfeit battery pack. To ensure that safe products are used we would recommend that a genuine Panasonic battery pack is used.

Inserting/removing the battery

- Press the power button to turn off the unit. (→ 28)

Install the battery by inserting it in the direction shown in the figure.

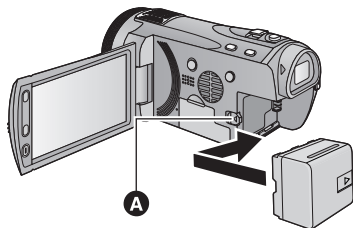

- A** Insert the battery until it clicks and locks.

Removing the battery

Be sure to hold down the power button until the status indicator goes off. Then remove the battery while supporting the unit to prevent it from dropping.

Move the battery release lever in the direction indicated by the arrow and remove the battery when unlocked.

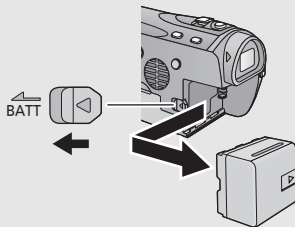

Charging the battery

When this unit is purchased, the battery is not charged. Charge the battery fully before using this unit for the first time.

Important:

- Use the supplied AC adaptor. Do not use the AC adaptor of another device.
- Do not use the AC cable with any other equipment as it is designed only for this unit. Also, do not use the AC cable from other equipment with this unit.
- The battery can also be charged using a battery charger (VW-BC20PP; optional).
- The battery will not be charged if the unit is turned on.
- It is recommended to charge the battery in a temperature between 10 °C to 30 °C (50 °F to 86 °F). (The battery temperature should also be the same.)

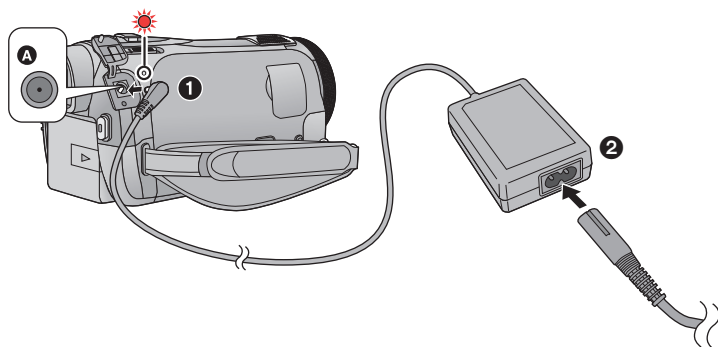

A DC input terminal

- Insert the plugs as far as they will go.

1 Connect the AC adaptor to the DC input terminal.

2 Connect the AC cable to the AC adaptor, then the AC outlet.

- The status indicator will flash red at an interval of 2 seconds, indicating that charging has begun.

It will turn off when the charging is completed.

■ Connecting to the AC outlet

If you turn on the unit while connecting the AC adaptor, you can use the unit with power supplied from the outlet.

- If the status indicator flashes at a particularly fast or slow rate, refer to page 151.
- We recommend using Panasonic batteries (→ 12, 23, 24, 163).
- If you use other batteries, we cannot guarantee the quality of this product.
- Do not heat or expose to flame.
- Do not leave the battery(ies) in an automobile exposed to direct sunlight for a long period of time with doors and windows closed.

Charging and recording time

■ Charging/Recording time

- Temperature: 25 °C (77 °F)/humidity: 60%RH
- When using the viewfinder (times in parentheses are when using the LCD monitor)

HDC-TM900				
Battery model number [Voltage/Capacity (minimum)]	Charging time	Recording mode	Maximum continuous recordable time	Actual recordable time
Supplied battery/ VW-VBN130 (optional) [7.2 V/1250 mAh]	2 h 30 min	[1080/60p]	1 h 30 min (1 h 25 min)	55 min (55 min)
		[HA]	1 h 35 min (1 h 30 min)	1 h (55 min)
		[HG], [HX], [HE]	1 h 35 min (1 h 35 min)	
		[iFrame]	1 h 40 min (1 h 35 min)	1 h (1 h)
VW-VBN260 (optional) [7.2 V/2500 mAh]	4 h 30 min	[1080/60p]	2 h 55 min (2 h 50 min)	1 h 45 min (1 h 45 min)
		[HA]	3 h 5 min (3 h)	1 h 55 min (1 h 50 min)
		[HG], [HX], [HE]	3 h 10 min (3 h)	
		[iFrame]	3 h 15 min (3 h 10 min)	2 h (1 h 55 min)

HDC-HS900

Battery model number [Voltage/Capacity (minimum)]	Charging time	Recording destination	Recording mode	Maximum continuous recordable time	Actual recordable time
Supplied battery/ VW-VBN130 (optional) [7.2 V/1250 mAh]	2 h 30 min	HDD	[1080/60p]	1 h 15 min (1 h 10 min)	45 min (45 min)
			[HA], [HG], [HX], [HE]	1 h 20 min (1 h 15 min)	50 min (45 min)
			[iFrame]	1 h 20 min (1 h 20 min)	50 min (50 min)
		SD	[1080/60p]	1 h 15 min (1 h 15 min)	45 min (45 min)
			[HA], [HG]	1 h 20 min (1 h 20 min)	50 min (45 min)
			[HX], [HE]		50 min (50 min)
			[iFrame]	1 h 25 min (1 h 20 min)	
VW-VBN260 (optional) [7.2 V/2500 mAh]	4 h 30 min	HDD	[1080/60p]	2 h 25 min (2 h 20 min)	1 h 30 min (1 h 25 min)
			[HA], [HG], [HX], [HE]	2 h 35 min (2 h 30 min)	1 h 35 min (1 h 30 min)
			[iFrame]	2 h 40 min (2 h 35 min)	1 h 40 min (1 h 35 min)
		SD	[1080/60p]	2 h 30 min (2 h 25 min)	1 h 30 min (1 h 30 min)
			[HA]	2 h 40 min (2 h 35 min)	1 h 35 min (1 h 35 min)
			[HG], [HX], [HE]		1 h 40 min (1 h 35 min)
			[iFrame]	2 h 45 min (2 h 40 min)	1 h 40 min (1 h 40 min)



- These times are approximations.
- **The indicated charging time is for when the battery has been discharged completely. Charging time and recordable time vary depending on the usage conditions such as high/low temperature.**
- Recordable time of 3D recording mode is the same.
(During 3D recording mode, 1080/60p and iFrame recording mode cannot be used.)

-
- The actual recordable time refers to the recordable time when repeatedly starting/stopping recording, turning the unit on/off, moving the zoom lever etc.
 - The batteries heat up after use or charging. This is not a malfunction.

Battery capacity indication

- The display changes as the battery capacity reduces.



If there is less than 3 minutes remaining, then  will become red. If the battery discharges, then  will flash.

- The remaining battery capacity is displayed when using the Panasonic battery that you can use for this unit. The actual time can vary depending on your actual use.
- When using the AC adaptor or batteries made by other companies, the remaining battery capacity will not be shown.

Recording to a card

The unit can record still pictures or motion pictures to an SD card, built-in memory or HDD. To record to an SD card, read the following.

This unit (an SDXC compatible device) is compatible with SD Memory Cards, SDHC Memory Cards and SDXC Memory Cards. When using an SDHC memory card/SDXC memory card with other equipment, check the equipment is compatible with these memory cards.

Cards that you can use with this unit

Use SD cards conforming to Class 4 or higher of the SD Speed Class Rating* for motion picture recording.

Card type	Capacity	Motion picture recording	Still picture recording
SD Memory Card	8 MB/16 MB/ 32 MB	Cannot be used.	Cannot be guaranteed in operation.
	64 MB/128 MB/ 256 MB	Cannot be guaranteed in operation.	
	512 MB/1 GB/ 2 GB	Can be used.	Can be used.
SDHC Memory Card	4 GB/6 GB/8 GB/ 12 GB/16 GB/ 24 GB/32 GB		
SDXC Memory Card	48 GB/64 GB		

* SD Speed Class Rating is the speed standard regarding continuous writing. Check via the label on the card, etc.

e.g.:



- Please confirm the latest information about SD Memory Cards/SDHC Memory Cards/SDXC Memory Cards that can be used for motion picture recording on the following website.

http://panasonic.jp/support/global/cs/e_cam

(This website is in English only.)

- 4 GB or more Memory Cards that do not have the SDHC logo or 48 GB or more Memory Cards that do not have the SDXC logo are not based on SD Memory Card Specifications.
- When the write-protect switch **A** on SD card is locked, no recording, deletion or editing will be possible on the card.
- Keep the Memory Card out of reach of children to prevent swallowing.



Inserting/removing an SD card

When using an SD card not from Panasonic, or one previously used on other equipment, for the first time on this unit, format the SD card. (→ 51) When the SD card is formatted, all of the recorded data is deleted. Once the data is deleted, it cannot be restored.

Caution:

Check that the access lamp has gone off.

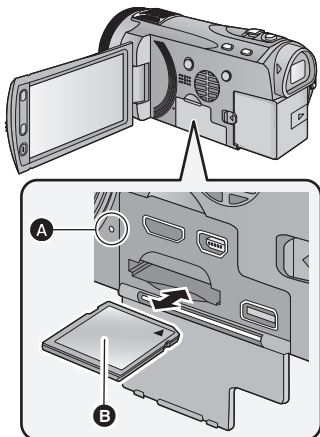

Access lamp [ACCESS] **A**

- When this unit is accessing the SD card or built-in memory, the access lamp lights up.

- 1** Open the LCD monitor.
- 2** Open the SD card/terminal cover and insert (remove) the SD card into (from) the card slot.

- Face the label side **B** in the direction shown in the illustration and press it straight in as far as it will go.
- Press the center of the SD card and then pull it straight out.

- 3** Securely close the SD card/terminal cover.

- Securely close it until it clicks.

- Do not touch the terminals on the back of the SD card.
- Do not apply strong shocks, bend, or drop the SD card.
- Electrical noise, static electricity or the failure of this unit or the SD card may damage or erase the data stored on the SD card.
- When the card access lamp is lit, do not:
 - Remove the SD card
 - Turn the unit off
 - Insert and remove the USB cable
 - Expose the unit to vibrations or shockPerforming the above while the lamp is on may result in damage to data/SD card or this unit.
- Do not expose the terminals of the SD card to water, dirt or dust.
- Do not place SD cards in the following areas:
 - In direct sunlight
 - In very dusty or humid areas
 - Near a heater
 - Locations susceptible to significant difference in temperature (condensation can occur.)
 - Where static electricity or electromagnetic waves occur
- To protect SD cards, return them to their cases when you are not using them.
- About disposing of or giving away the SD card. (→ 152)

Turning the unit on/off

You can turn the unit on and off using the power button, the LCD monitor or the viewfinder.

A clicking sound is heard when the unit is shaken.

- This is the sound of the lens moving and is not a defect.

This sound will no longer be heard when the unit is turned on and change the mode to

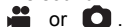

Turning the unit on and off with the power button

Press the power button to turn on the unit.

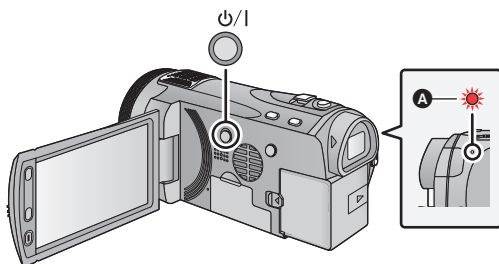

To turn off the unit

Hold down the power button until the status indicator goes off.

- A** The status indicator lights on.

Turning the unit on and off with the LCD monitor/viewfinder

Opening the LCD monitor or extending the viewfinder turns on the unit. Closing the LCD monitor/viewfinder turns off the unit.

During general use, you may find it convenient to turn the unit on/off using the LCD monitor or viewfinder.

■ To turn on the unit

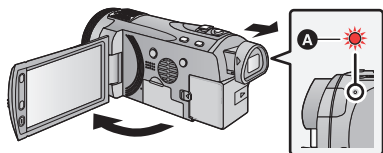

- A** The status indicator lights on.

- The unit will not turn off unless the LCD monitor is closed and the viewfinder is retracted.
- The unit will not turn off while recording motion pictures even if the LCD monitor is closed and the viewfinder is retracted.

■ To turn off the unit

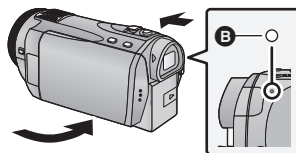

- B** The status indicator goes off.

- In the following cases, opening the LCD monitor or extending the viewfinder does not turn on the unit. Press the power button to turn on the unit.
 - When the unit is originally purchased
 - When you have turned off the unit using the power button



Preparation

Selecting a mode

Change the mode to recording or playback.

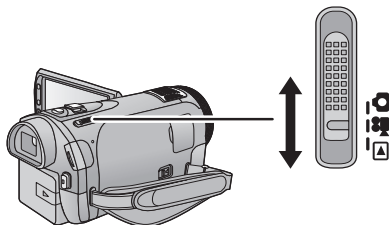
Operate the mode switch to change the mode to ,  or .



	Motion Picture Recording Mode (→ 35)
	Still Picture Recording Mode (→ 37)
	Playback Mode (→ 41, 89)

Preparation

How to use the touch screen

You can operate by directly touching the LCD monitor (touch screen) with your finger. It is easier to use the stylus pen (supplied) for detailed operation or if it is hard to operate with your fingers.

■ Touch

Touch and release the touch screen to select icon or picture.

- Touch the center of the icon.
- Touching the touch screen will not operate while you are touching another part of the touch screen.

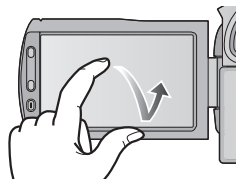

■ Slide while touching

Move your finger while pressing on the touch screen.

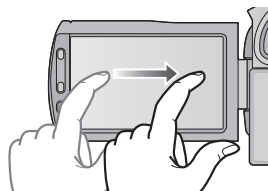

■ About the operation icons



These icons are used to switch the menu and thumbnail display page, for item selection and setting etc.



Touch to return to the previous screen such as when setting menus.

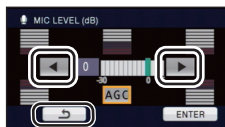

About the Touch Menu

Touch ◀ (left side)/▶ (right side) of  on the Touch Menu to switch the operation icons.

Touch ◀ (left side)/▶ (right side) of  on the Touch Menu.

- It is also possible to switch the operation icons by sliding the Touch Menu right or left while touching it.

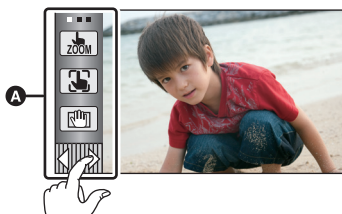

A Touch Menu

Recording Mode

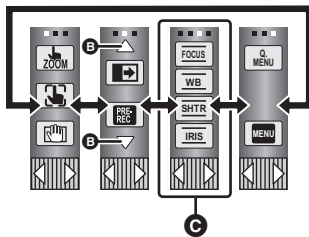

Playback Mode

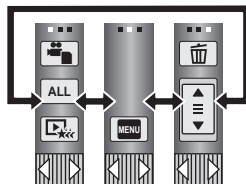

- B** Touch these icons to switch pages upward or downward.
- C** Displayed only during the Manual Mode.

■ To display the Touch Menu



The Touch Menu will disappear when no function is performed for a specific period of time during Recording mode. To display it again, touch .

- Do not touch on the LCD monitor with hard pointed tips, such as ball point pens.
- Perform the touch screen calibration when the touch is not recognized or wrong location is recognized. (→ 52)

Preparation



Setting date and time

When the unit is turned on for the first time, a message asking you to set the date and time will appear.

Select [YES] and perform steps 2 to 3 below to set the date and time.

1 Select the menu. (→ 44)

 : [SETUP] → [CLOCK SET]

2 Touch the date or time to be set, then set the desired value using / .

A Displaying the World time setting (→ 46):

 [HOME] /  [DESTINATION]

- The year can be set between 2000 and 2039.
- The 12-hour system is used to display the time.



3 Touch [ENTER].

- A message prompting for World time setting may be displayed. Perform the World time setting by touching the screen. (→ 46)
- Touch [EXIT] to complete the setting.

- The date and time function is driven by a built-in lithium battery.
- When this unit is purchased, the clock is set. If the time display becomes [- -], the built-in lithium battery needs to be charged. To recharge the built-in lithium battery, connect the AC adaptor or attach the battery to this unit. Leave the unit as it is for approx. 24 hours and the battery will maintain the date and time for approx. 6 months. (The battery is still being recharged even if the unit is off.)

Before recording

■ Basic camera positioning

1

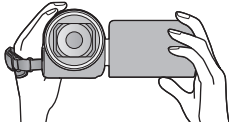

2

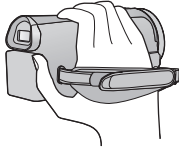

3

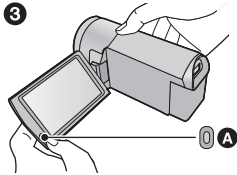

- 1 Hold the unit with both hands.
 - 2 Put your hand through the grip belt.
 - 3 It is convenient to use the Sub-recording Start/Stop button **A** when holding the unit at waist level.
- When recording, make sure your footing is stable and there is no danger of colliding with another person or object.
 - When you are outdoors, record pictures with the sunlight behind you. If the subject is backlit, it will become dark in the recording.
 - Keep your arms near your body and separate your legs for better balance.
 - Do not cover the microphones or the cooling fan inlet with your hand etc.

■ Basic motion picture recording

- The unit should normally be held steady when recording.
- If you move the unit when recording, do so slowly, maintaining a constant speed.
- The zoom operation is useful for recording subjects you cannot get close to, but overuse of zoom in and zoom out can make the resulting motion picture less enjoyable to watch.

■ To adjust the image in the viewfinder

Adjust to make the image clear by rotating the eyepiece corrector dial.

- Extend the viewfinder and close the LCD monitor to turn on the viewfinder.

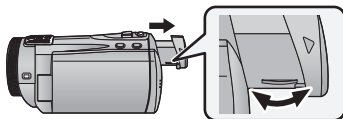

■ To record while showing the contents to someone beside you

Extend the viewfinder and rotate the LCD monitor towards the lens side.

- LCD monitor and viewfinder are turned on during the face-to-face recording when the viewfinder is extended.
- The image is horizontally flipped as if you see a mirror image. (However the image recorded is the same as a normal recording.)
- Record by viewing the image in the viewfinder during the face-to-face recording.

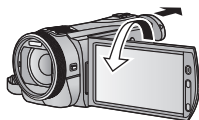

-
- Only some indications will appear on the screen. When  appears, return the direction of the LCD monitor to normal position and check the warning/alarm indication. (→ 141)

■ Attaching/Removing the lens hood

This will reduce the extra light entering the lens in bright sunlight or backlight etc., making it possible to take clearer pictures.

A

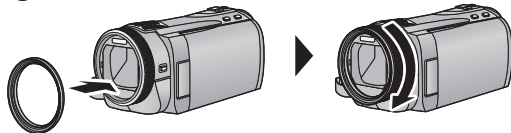

B

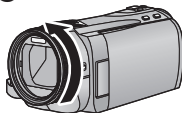

- A** Attaching the lens hood
- B** Removing the lens hood

- If you use the Filter Kit (optional), the Conversion Lens (optional) or the 3D Conversion Lens (optional), remove the lens hood.

Selecting a media to record

The card, built-in memory and HDD media can be selected separately to record motion pictures or still pictures.

1 Change the mode to  or .

2 Select the menu. (→ 44)

MENU : [MEDIA SELECT]

3 Touch the media to record motion pictures or still pictures.

HDC-TM900

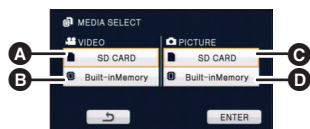

- A** [VIDEO/SD CARD]
- B** [VIDEO/Built-inMemory]
- C** [PICTURE/SD CARD]
- D** [PICTURE/Built-inMemory]

HDC-HS900

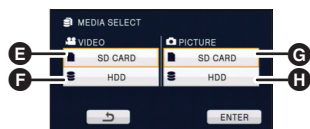

- E** [VIDEO/SD CARD]
- F** [VIDEO/HDD]
- G** [PICTURE/SD CARD]
- H** [PICTURE/HDD]

- The media is selected separately to motion pictures or still pictures is highlighted in yellow.



4 Touch [ENTER].



Recording motion pictures

- 1 Change the mode to .
- 2 Open the LCD monitor or extend the viewfinder.
- 3 Press the recording start/stop button to start recording.



- A** When you begin recording,  changes to .

- 4 Press the recording start/stop button again to pause recording.

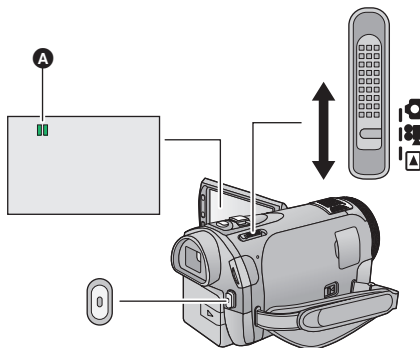

■ Screen indications in the Motion Picture Recording Mode



- Screen display will disappear when no function is performed for a specific period of time. To display it again, touch the screen. (It will not display when AF/AE tracking is used.)

- A** Recording mode
- B** Recording time elapsed
Each time the unit is put into recording pause, the counter display will be reset to 0h00m00s. ("h" is an abbreviation for hour, "m" for minute and "s" for second.)
- C** Approximate remaining recordable time
(When the remaining time is less than 1 minute, R 0h00m flashes red.)

- There are 3 recording formats that can be used with this unit: AVCHD that records high-definition motion pictures, 1080/60p that records motion pictures in maximum quality for this unit and iFrame that records motion pictures suitable for playback and editing on Mac (iMovie'11). To change the recording format, change the Recording Mode (→ 67) or press and hold the 1080/60p button. (→ 57)
- Still pictures can be recorded while recording the motion picture. (→ 38)
- The images recorded between pressing the recording start/stop button to start recording and pressing it again to pause recording become one scene.
When you record with the [REC MODE] set to [iFrame], the scenes longer than approximately 20 minutes will be automatically divided. (Recording will continue.)
- (Maximum recordable scenes of a single SD card, built-in memory or HDD)

Recording formats	[HA]/[HG]/[HX]/[HE]	[1080/60p]	[iFrame]
Recordable scenes	Approx. 3900	Approx. 3900	Approx. 89100
Different dates (→ 92)	Approx. 200	Approx. 200	Approx. 900

- Maximum number of recordable scenes and maximum number of different dates will be less than above table when there are both AVCHD scenes and 1080/60p scenes recorded on SD card, built-in memory or HDD.
- Maximum number of recordable scenes and maximum number of different dates will be less than above table when there are both iFrame scenes and still pictures recorded on SD card, built-in memory or HDD.
- While recording is in progress, the recording will not stop even if the LCD monitor is closed and the viewfinder is retracted.
- Put the unit in Pause mode when connecting or disconnecting an external microphone with the MIC terminal.
- Please refer to page 155 for detail about the approximate recordable time.

About the compatibility of the recorded motion pictures

Please refer to page 57 about 1080/60p

When motion picture is recorded in AVCHD format

- Only motion pictures recorded with the recording format set to AVCHD are supported by AVCHD compatible equipment. Images cannot be played with equipment that does not support AVCHD (ordinary DVD recorders). Confirm that your equipment supports AVCHD by referring to the operating instructions.
- It is not always possible to play back motion pictures recorded with the recording format set to AVCHD on AVCHD compatible equipment. In such a case, play back on this unit instead.

When motion picture is recorded in iFrame format

- You can play back on Mac (iMovie'11).
- It is not compatible with motion pictures recorded in AVCHD format.



Recording still pictures

- 1 Change the mode to .
- 2 Open the LCD monitor or extend the viewfinder.
- 3 Press the button halfway.
(For Auto focus only)

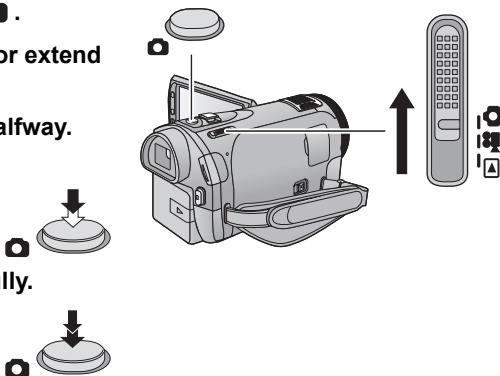

- 4 Press the button fully.



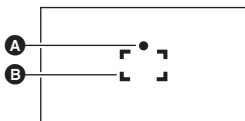





Focus indication:



- A Focus indication
 - (The white lamp flashes.):
Focusing
 - (The green lamp lights up.):
When in focus
 - No mark:
When focusing is unsuccessful.
- B Focus area (area inside brackets)

- If you set the Optical image stabilizer function (→ 56) to 1 ([MODE1]), then the Image Stabilizer function will be more effective. ([MEGA] (MEGA Optical Image Stabilizer) will be displayed when the button is pressed halfway.)
- The AF assist lamp lights in dark places.
- Focus indication will change to registered focus icon when [FACE RECOG.] is set to [ON]. (→ 71)
- Using a flash or tripod is recommended when recording still pictures in dark places because the shutter speed becomes slow.
- The screen will become darker when the button is pressed halfway if the shutter speed is 1/30 or slower.
- You can also take a picture just by touching the subject to focus. (Touch Shutter: → 60)
- To print a picture, save the picture to the SD card (→ 111) and print using a PC or a printer.

■ About the screen indications in Still Picture Recording

- : Still picture operation indicator (→ 138)
- R3000: Remaining number of still pictures (Flashes in red when [0] appears.)
- : Quality of still pictures (→ 79)
- : Size of still pictures (→ 78)
- : MEGA optical image stabilizer (→ 37)
- 1: Optical image stabilizer (→ 56)
- AF*[†]: AF assist lamp (→ 81)
- : Flash (→ 63)
- -: Flash level (→ 63)
- : Red-eye reduction (→ 64)



- Screen display will disappear when no function is performed for a specific period of time. To display it again, touch the screen. (It will not display when AF/AE tracking or Touch shutter is used.)

■ About the focus indication

- The focus indication indicates the status of the Auto focus.
- The focus indication does not appear in Manual Focus Mode.
- The focus indication does not appear or has difficulty focusing in the following cases.
 - When close subjects and far subjects are included in the same scene
 - When the scene is dark
 - When there is a bright part in the scene
 - When the scene is filled with only horizontal lines

■ About the focusing area

When there is a contrasting object ahead or behind the subject in the focus area, the subject may not be focused. If so, move the contrasting object out of the focus area.

- Focus area is not displayed in the following conditions.
 - When the Intelligent Auto Mode (Portrait) is used
 - When AF/AE tracking is used
 - When the Extra Optical Zoom is used
 - When the unit determines that the AF assist lamp is necessary

Recording still pictures in Motion Picture Recording Mode

You can record still pictures even in Motion Picture Recording Mode.

◇ **Change the mode to**  .

Press the  **button fully (press to the bottom) to take the picture.**

- It is possible to record still pictures while recording motion pictures. (Simultaneous recording)
- Remaining number of recordable pictures is displayed while still pictures are being recorded.

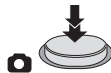

- Built-in flash, Red-eye reduction, Self-timer (→ 64) do not work.
- While recording motion pictures or during the PRE-REC operation, image quality is different from ordinary still pictures so that motion picture recording takes preference over still picture recording.
- If simultaneous recording is used while recording a motion picture, the recordable time remaining will shorten. If the unit is turned off or the mode switch operated, the recordable time remaining may lengthen.

Intelligent Auto Mode



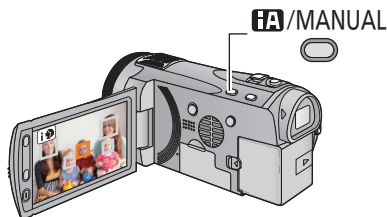





The following modes (appropriate for the condition) are set just by pointing the unit to what you want to record.



Intelligent auto/Manual button

Press this button to switch Intelligent Auto Mode/Manual Mode.

- Please refer to page 82 for details about Manual Mode.

Mode	Scene	Effect	
	Portrait	When the object is a person	Faces are detected and focused automatically, and the brightness is adjusted so it is recorded clearly.
	Scenery	Recording outdoors	The whole landscape will be recorded vividly without whiting out the background sky, which may be very bright.
 *1	Spotlight	Under a spotlight	Very bright object is recorded clearly.
 *1	Low light	Dark room or twilight	It can record very clearly even in a dark room or twilight.
 *2	Night portrait	Recording night portrait	A subject and the background are recorded with near real-life brightness.
 *2	Night scenery	Recording night scenery	You can record night scenery vividly by slowing the shutter speed.
 *2	Macro	Recording zooming in on a flower etc.	This allows recording at very close proximity to the object of recording.
 *1  *2	Normal	Other situations	Contrast is adjusted automatically for clear images.

*1 In Motion Picture Recording Mode only

*2 In Still Picture Recording Mode only

- Depending on the recording conditions, the unit may not enter the desired mode.
- In the Portrait, Spotlight and Low light mode, the face will be surrounded by white frame when detected. In the Potrait mode, a subject that is bigger and close to center of the screen will be surrounded by an orange frame. (→ 72)
- Using a tripod is recommended in Night Portrait and Night Scenery Mode.

- Faces cannot be detected depending on the recording conditions, such as when faces are of certain sizes or at certain tilts or when digital zoom is used.
- [MIC SETUP] is set to [SURROUND] in the Intelligent Auto Mode. Also, when [REC MODE] is set to [iFrame] in the Intelligent Auto Mode, [MIC SETUP] will be set to [STEREO MIC]. (→ 74)

■ Intelligent Auto Mode

When switching to Intelligent Auto Mode, the Auto White Balance and Auto Focus operate and automatically adjust the color balance and focusing.

Depending on the brightness of the subject etc., the aperture and shutter speed are automatically adjusted for an optimum brightness.

- Color balance and focus may not be adjusted automatically depending on light sources or scenes. If so, manually adjust these settings. (→ 83, 85)

Automatic white balance

The illustration shows the range over which Automatic white balance functions.

- 1) The effective range of Automatic white balance adjustment on this unit
- 2) Blue sky
- 3) Cloudy sky (rain)
- 4) Sunlight
- 5) White fluorescent lamp
- 6) Halogen light bulb
- 7) Incandescent light bulb
- 8) Sunrise or sunset
- 9) Candlelight

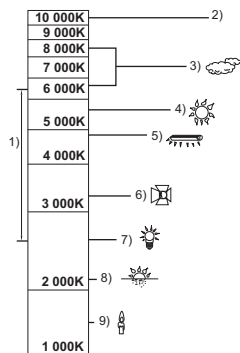

If the automatic white balance is not functioning normally, adjust the white balance manually. (→ 83)

Auto focus

The unit focuses automatically.

- Auto focus does not work correctly in the following situations. Record pictures in the Manual Focus Mode. (→ 85)
 - Recording distant and close-up objects at the same time
 - Recording a subject behind a dirty or dusty window
 - Recording a subject that is surrounded by objects with glossy surfaces or by highly reflective objects

Motion picture/Still picture playback

VIDEO PHOTO

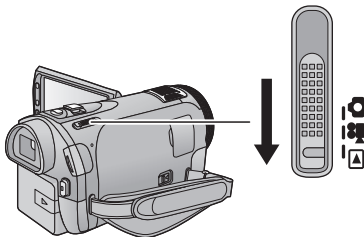

- 1 Change the mode to .
- 2 Touch the play mode select icon **A**. (→ 30)
- 3 Select the [MEDIA] and [VIDEO/PICTURE] you wish to play back.

- Touch [ENTER].

HDC-TM900



HDC-HS900

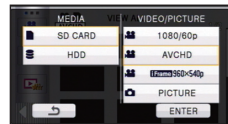

- 4 Touch the scene or the still picture to be played back.

- B** **1080/60p** is displayed when [1080/60p] is touched, **AVCHD** is displayed when [AVCHD] is touched or **iFrame** is displayed when [iFrame] is touched in step 3.

- To display the next (previous) page:
 - Slide the thumbnail display upward (downward) while touching it.
 - Switch the Touch Menu, and then touch ▲ (up)/ ▼ (down) on the thumbnail scroll lever.



5 Select the playback operation by touching the operation icon.



C Operation icon

- Operation icons and screen display will disappear when no function is performed for a specific period of time. To display them again, touch the screen.

Motion picture playback	Still picture playback
<p>▶/ : Playback/Pause</p> <p>◀◀: Rewind playback</p> <p>▶▶: Fast forward playback</p> <p>■: Stops the playback and shows the thumbnails.</p>	<p>▶/ : Slide show (playback of the still pictures in numerical order) start/pause.</p> <p>◀ : Plays back the previous picture.</p> <p> ▶: Plays back the next picture.</p> <p>■: Stops the playback and shows the thumbnails.</p>

■ Change the thumbnail display

While the thumbnail is displayed, the thumbnail display changes in the following order if the zoom lever or zoom buttons are operated to Q side or  side.

20 scenes ↔ 9 scenes ↔ 1 scene ↔ Highlight&Time frame index* (→ 90)

* Highlight&Time frame index can only set in Motion Picture Playback Mode.

Even in Motion Picture Playback Mode, [FACE] and [HIGHLIGHT] cannot be used when [iFrame] is selected.

- 9 scenes display returns if the unit is turned off or the mode is changed.
- By displaying in 1 scene or pressing and holding the thumbnail in the 20 scenes or 9 scenes display, recording date and time are displayed when playing back motion pictures, and recording date and file number when playing back still pictures.

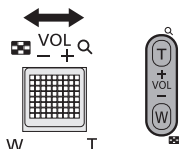

■ Speaker/Headphone volume adjustment

Operate the volume lever or the zoom buttons to adjust the speaker/headphone volume during Motion Picture Playback Mode.

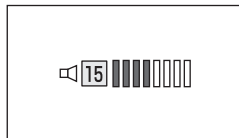
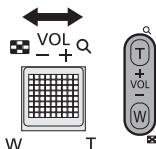

Towards “+”:

Increases the volume

Towards “-”:

Decreases the volume

- Sound will be heard only during normal play back.
- If pause play is continued for 5 minutes, the screen returns to the thumbnails.
- The elapsed time for playback indication will be reset to 0h00m00s for each scene.
- When playing back iFrame scenes, the image will pause momentarily and the screen may turn black when the scenes are switching.

Motion picture compatibility

Please refer to page 57 about 1080/60p.

- This unit is based on AVCHD format/MPEG-4 AVC file format.
- Video signals for the AVCHD that can be played back with this unit are 1920×1080/60i, 1920×1080/24p and 1440×1080/60i.
- Video signals for the iFrame that can be played back with this unit are 960×540/30p.
- This unit may degrade or not play back motion pictures recorded or created on other products, and other products may degrade or not play back motion pictures recorded on this unit, even if the products support AVCHD or iFrame.
- Motion pictures recorded in AVCHD and iFrame are not compatible with each other.

Still picture compatibility

- This unit is compliant with the unified standard DCF (Design rule for Camera File system) established by JEITA (Japan Electronics and Information Technology Industries Association).
- The file format of still pictures supported by this unit is JPEG. (Not all JPEG formatted files will be played back.)
- This unit may degrade or not play back still pictures recorded or created on other products and other products may degrade or not play back still pictures recorded on this unit.

Using the menu screen

- Touch ◀ (left side)/▶ (right side) of  on the Touch Menu to display . (→ 30)

1 Touch [MENU].



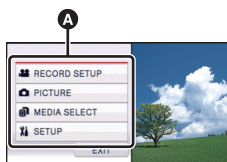

2 Touch the top menu **A**.

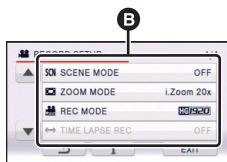

3 Touch the submenu **B**.



- Next (previous) page can be displayed by touching  / .

4 Touch the desired item to enter the setting.



5 Touch [EXIT] to exit the menu setting.

■ About guide display

After touching , touching the submenus and items will cause function descriptions and settings confirmation messages to appear.

- After the messages have been displayed, the guide display is canceled.

Using the quick menu









This allows quick setting of some of the menus.

- Touch ◀ (left side)/▶ (right side) of  on the Touch Menu to display  . (→ 30)

1 Touch [Q.MENU].

The following menus can be set. Touch the desired menu.

- The items displayed differ depending on the position of the mode switch or settings.

Icon	Function	Page
	[REC MODE]	→ 67
	[PICTURE SIZE]	→ 78
	[POWER LCD]	→ 49
	[GUIDE LINES]	→ 65
	[MIC LEVEL]	→ 75
	[MF ASSIST]	→ 85
	[ZEBRA]	→ 76
	[LUMINANCE]	→ 77
	[HISTOGRAM]	→ 77

2 Touch the desired item to enter the setting.

3 Touch [EXIT] to exit the quick menu.

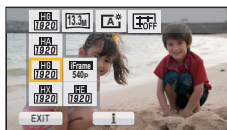

Using the Setup Menu

- The items displayed differ depending on the position or settings of the mode switch. Select the menu.

MENU : [SETUP] → desired setting

[CLOCK SET]

Please refer to page 31.

[SET WORLD TIME]

It is possible to display and record the time at the travel destination by selecting your home region and the travel destination.

1 Touch [SET WORLD TIME].

- If the clock is not set, adjust the clock to the current time. (→ 31)
- When the [HOME] (your home region) is not set, the message appears. Touch [ENTER] and proceed to Step 3.

2 (Only when setting your home region)

Touch [HOME].

- Touch [ENTER].

3 (Only when setting your home region)

Touch / to select your home region and touch [ENTER].

- Touch [SUMMER TIME SET] to set daylight saving time.  appears and the summer time setting is turned on; the time difference from GMT is set forward by one hour. Touch [SUMMER TIME SET] again to return to the normal time setting.

4 (Only when setting the region of your travel destination)

Touch [DESTINATION].

- Touch [ENTER].
- When the home region is set for the first time, the screen for selecting home/travel destination appears after setting the home region successively. If the home region has already been set once, execute the menu operation for Step 1.

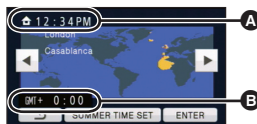

- A** The current time
- B** The time difference from GMT (Greenwich Mean Time)

5 (Only when setting the region of your travel destination)

Touch ◀/▶ to select your travel destination and touch [ENTER].

- Touch [SUMMER TIME SET] to set daylight saving time. ☀ appears and the summer time setting is turned on. The travel destination time and time difference from the home region time are set forward by one hour. Touch [SUMMER TIME SET] again to return to the normal time setting.
- Close the setting by touching [EXIT]. ✈ appears and the time of the travel destination is indicated.

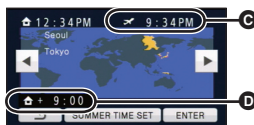

- C The local time at the selected travel destination
- D The time difference between the travel destination and the home region

To return the display to the home setting

Set the home region using Step 1 to 3, and close the setting by touching [EXIT].

- If you cannot find your travel destination in the area shown on the screen, set it by using the time difference from your home region.

[DATE/TIME] [OFF]/[D/T]/[DATE]

It is possible to change the date and time display mode.

- You can also show or change the date and time display by repeatedly pressing the DATE/TIME button on the remote control.

[DATE FORMAT] [Y/M/D]/[M/D/Y]/[D/M/Y]

It is possible to change the date format.



[ECONOMY] [OFF]/[5 MINUTES]

When about 5 minutes have passed without any operation, this unit automatically turns off to save battery life.

- The Power Save function will not activate when:
 - connected to AC adaptor
 - using the USB cable for PC, DVD burner etc.
 - PRE-REC is used

[QUICK POWER ON]

[OFF]/[ON]





The unit is put into recording pause approx. 1 second when the unit is turned on with the mode set to  or .

- Depending on the recording conditions, start time may be longer than 1 second.
- In the Quick power on mode, the zoom magnification becomes 1×.

[QUICK START]

[OFF]/[ON]

This unit is put into recording pause approx. 0.6 seconds after the LCD monitor is reopened or the viewfinder is extended.

- **When in Quick start standby mode about 80% of the power used in Recording pause mode is being consumed, so the recording time will be reduced.**
 - Quick start will not work if the [SD CARD] is selected in the [MEDIA SELECT], even if there is no SD card inserted.
 - **Change the mode to  or .**
- 1 **Set [QUICK START] to [ON].**
 - 2 **Close the LCD monitor and retract the viewfinder while the mode is set to  or .**

The status indicator **A** flashes green and the unit goes into Quick start standby mode.

- The lens cover does not close.

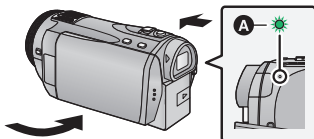

- 3 **Open the LCD monitor or extend the viewfinder.**

The status indicator **A** lights red and the unit is put into recording pause.

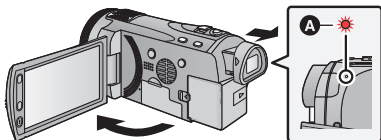

- Quick Start Standby Mode is canceled if
 - about 5 minutes have elapsed
 - mode is set to 
- Depending on the recording conditions and menu settings, time for Quick start may be longer than 0.6 seconds.
- It may take some time for Automatic white balance to adjust.
- In the Quick Start Mode, the zoom magnification becomes 1×.
- If [ECONOMY] (→ 47) is set to [5 MINUTES] and the unit automatically goes into Quick Start Standby Mode, close the LCD monitor and viewfinder and then open the LCD monitor or extend the viewfinder again.
- Turn the unit off using the power button.
- Quick start standby mode cannot be released by the remote control.

[REMOTE CONTROL]

[OFF]/[ON]

Please refer to page 53.

[REC LAMP]

[OFF]/[ON]

The recording lamp lights up during recording and flashes when the unit receives a signal from the remote control or when the Self-timer is counting down. When this is set to [OFF], it does not light during recording.

[ALERT SOUND]

[OFF]/ [] / [])

Touch screen operation, starting and stopping of recording and unit on/off can be confirmed with this sound.

[] (Volume low)/ [] (Volume high)

2 Beeps for 4 times

When an error occurs. Check the sentence displayed on the screen. (→ 141)

[POWER LCD]

[+2]* / [+1]* / [0]* / [-1]* / [A]*

This makes it easier to view the LCD monitor in bright places including outdoors.

- These settings will not affect the images actually recorded.
- It is possible to set from the quick menu. (→ 45)

[+2]* (Makes even brighter) / [+1]* (Makes brighter) / [0]* (Normal) / [-1]* (Makes less bright) / [A]* (Automatic adjustment)

* It is not displayed in the Manual Mode or in the Playback Mode.

- When the AC adaptor is in use, the LCD monitor is set to [+1]* automatically.
- When the LCD monitor is bright, the recordable time with the battery will be shorter.

[LCD SET]

It adjusts brightness and color density on the LCD monitor.

- These settings will not affect the images actually recorded.

1 Touch [LCD SET].

2 Touch the desired setting item.

[BRIGHTNESS]:

Brightness of the LCD monitor

[COLOR]:

Color level of the LCD monitor

3 Touch [] / [] to adjust settings.

4 Touch [ENTER].

- Touch [EXIT] to exit the menu screen.



[EVF SET]

It adjusts the brightness of the viewfinder.

- These settings will not affect the images actually recorded.

1 Extend the viewfinder and open the LCD monitor.

2 Touch [EVF SET].

- The viewfinder turns on.

3 Touch  /  to adjust the setting.

- Adjust while checking the picture in the viewfinder.

4 Touch [ENTER].

- Touch [EXIT] to complete the setting.

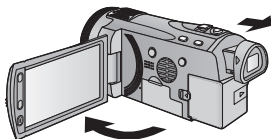

[AV MULTI]

[COMPONENT]/[AV OUT]

Please refer to page 106.

[COMPONENT OUT]

[480i]/[1080i]

Please refer to page 106.

[HDMI RESOLUTION]

[AUTO]/[1080p]/[1080i]/[480p]

Please refer to page 106.

[VIERA Link]

[OFF]/[ON]

Please refer to page 107.

[TV ASPECT]

[16:9]/[4:3]

Please refer to page 105.

[3D PLAYBACK]

[3D]/[2D]

Please refer to page 109.

[INITIAL SET]

Set to [YES] for changing the menu settings back to the default condition.

- Settings for [MEDIA SELECT], [CLOCK SET] and [LANGUAGE] will not be changed.

[NUMBER RESET]

Set the file number of the iFrame and still picture recorded next to 0001.

- Folder number is updated and file number will start from 0001.(→ 135)
- To reset the folder number, format the SD card, built-in memory or HDD, and then perform [NUMBER RESET].
- Please be aware that if a medium is formatted, then all the data recorded on the medium will be erased and cannot be restored. Back up important data on a PC, DVD disc etc. (→ 113, 125)

[FORMAT MEDIA]

Please be aware that if a medium is formatted, then all the data recorded on the medium will be erased and cannot be restored. Back up important data on a PC, DVD disc etc. (→ 113, 125)

1 Touch [FORMAT MEDIA].

2 **HDC-TM900**

Touch [SD CARD] or [Built-inMemory].

HDC-HS900

Touch [SD CARD] or [HDD].

- When formatting is complete, touch [EXIT] to exit the message screen.
 - Perform a physical formatting of the SD card when the SD card is to be disposed/transferred. (→ 152)
 - Perform a physical formatting of the built-in memory/HDD when this unit is to be disposed/transferred. (→ 149)
-
- Do not turn this unit off or remove the SD card, while formatting. Do not expose the unit to vibrations or shock.

Use this unit to format media.

Formatting built-in memory or HDD is only available with this unit.

Do not format an SD card using any other equipment such as a PC. The card may not be used on this unit.

[MEDIA STATUS]

The used space and remaining recordable time of the SD card, built-in memory or HDD can be checked.

- Touching [CHANGE MEDIA] switches the unit between the display for the SD card and the display for the built-in memory/HDD.
 - When the mode switch is set to , remaining recordable time for the selected recording mode is displayed.
 - Touch [EXIT] to close the indication.
-
- The SD card, built-in memory or built-in HDD requires some space to store information and manage system files, so the actual usable space is slightly less than the indicated value. The usable built-in memory/HDD space is generally calculated as 1 GB=1,000,000,000 bytes. The capacities of this unit, PCs and software are expressed as 1 GB=1,024×1,024×1,024=1,073,741,824 bytes. Therefore, the indicated value of the capacity appears to be smaller.

[CALIBRATION]

Perform the touch screen calibration if a different object to the one touched is selected.

1 Touch [CALIBRATION].

- Touch [ENTER].

2 Touch the [+] that appears on the screen with the supplied stylus pen.



- Touch [+] in sequence (up left → down left → down right → up right → center).

3 Touch [ENTER].

[DEMO MODE]

[OFF]/[ON]

This item is used to start the unit demonstration.

(Only when the mode is at the  or  position)

If [DEMO MODE] is switched to [ON] and you touch [EXIT] when there is no SD card inserted and while this unit is connected to the AC adaptor, the demonstration automatically starts. If any operation takes place, the demonstration is canceled. However if no operations take place for approx. 10 minutes, the demonstration automatically starts again. To stop the demonstration, set [DEMO MODE] to [OFF] or insert an SD card.

[O.I.S. DEMO]

This item is used to start the Optical Image Stabilizer demo.

(Only when the mode is at the  position)

Touch [O.I.S. DEMO], the demonstration automatically starts.

When you touch [EXIT], the demonstration will be canceled.

[LANGUAGE]

You can select the language on the screen display and the menu screen.

Using with the remote control

Select the menu.

MENU : [SETUP] →
[REMOTE CONTROL] → [ON]

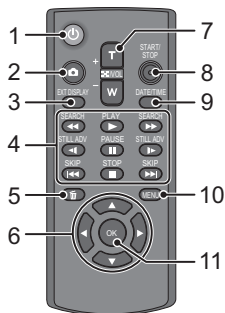

1 Power on/off button [⏻]

Unit can be turned on/off when the LCD monitor is opened or the viewfinder is extended.

- Unit cannot be turned on by the power on/off button when 36 hours have passed after the unit is turned off. Press the power button on the unit and turn the unit back on.
- Unit cannot be turned off when it is connected to the PC or the DVD burner.

2 Photoshot button [📷]*

3 On-screen display button [EXT DISPLAY] (→ 105)

4 Playback operation buttons (→ 41, 89)

These buttons function in the same manner as the corresponding playback operation icon being displayed on screen.

5 Delete button [🗑]

6 Direction buttons [▲, ▼, ◀, ▶]

7 Zoom/volume/thumbnail display switch buttons [T, W, I/O/VOL]*

8 Recording start/stop button [START/STOP]*

9 Date/time button [DATE/TIME] (→ 47)

10 Menu button [MENU]

11 OK button [OK]

* means that these buttons function in the same manner as the corresponding buttons on the unit.

Remove the insulation sheet **A** before using.

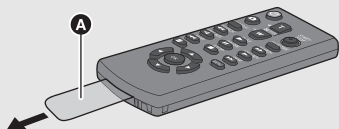

Replacing a button-type battery

- 1 While pressing the stopper **B**, pull out the battery holder.

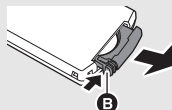

- 2 Set the button-type battery with its (+) mark facing upward and then put the battery holder back in place.



- When the button-type battery runs down, replace it with a new battery (part number: CR2025). The battery should normally last about 1 year, however this depends on how frequently the unit is used.
- Keep the button-type battery out of reach of children to prevent swallowing.

CAUTION

Danger of explosion if battery is incorrectly replaced. Replace only with the same or equivalent type recommended by the manufacturer. Dispose of used batteries according to the manufacturer's instructions.

Replace battery with Panasonic PART NO. CR2025 only. Use of another battery may present a risk of fire or explosion. Caution: Battery may explode if mistreated.

Dispose of used battery promptly. Keep away from children. Do not recharge, disassemble or dispose of in fire.

Remote control usable range

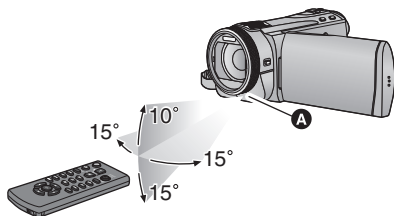

A Remote control sensor

Distance: Within approx. 5 m (16 feet)

Angle: Approx. 10° up and 15° down, left, and right

- The remote control is intended for indoor operation. Outdoors or under strong light, the unit may not operate properly even within the usable ranges.

Operation of direction buttons/OK button

1 Press a direction button.



- Selected item will become yellow.

2 Select the item with the direction button.

3 Confirm the selection by pressing the OK button.



- Selection/confirmation of operation icons, thumbnail display etc. can be operated.
- All touch operations on the unit can also be operated by the remote control (some exceptions).

Zoom in/out function

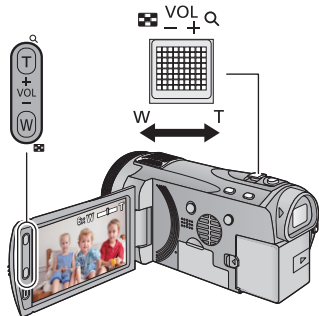

Zoom lever/Zoom buttons

T side:

Close-up recording (zoom in)

W side:

Wide-angle recording (zoom out)

- Maximum zoom magnification for recording motion pictures can be set with [ZOOM MODE]. (→ 67)
- You can also zoom by simply touching the LCD monitor. (Touch Zoom: → 58)

About the zoom speed

The zoom speed will be faster in the order of zoom lever/ring zoom, zoom button/zoom button on the remote control, touch zoom.

- The zoom speed varies depending on the range over which the zoom lever is moved or the speed to rotate the ring.
- The zoom operation using the zoom button, zoom button on the remote control or touch zoom will be performed at a constant speed.

Ring zoom



Zoom operation can be done using the multi manual ring.

Zoom by rotating the ring.



A side:

Close-up recording
(zoom in)

B side:

Wide-angle recording
(zoom out)

Extra Optical Zoom



If the number of the recording pixels is set to anything other than the maximum number of recording pixels in Still Picture Recording Mode, the still picture can be recorded with a zoom ratio of a maximum of 25× without degrading the picture quality.

- Extra optical zoom ratio varies depending on the setting of [PICTURE SIZE] and [ASPECT RATIO]. (→ 78, 79)

■ Extra optical zoom mechanism

When you set the picture size to $0.3m$, the maximum $12.2m$ area is cropped to the center $0.3m$ area, allowing a picture with a higher zoom effect.

- If you take your finger off the zoom lever during zoom operation, the operation sound may be recorded. When returning the zoom lever to the original position, move it quietly.
- When the zoom magnification is 12×, the subjects are focused at about 1.2 m (3.9 feet) or more.
- When the zoom magnification is 1×, this unit can focus on a subject approx. 4 cm (1.6") away from the lens.

Advanced (Recording)



Image Stabilizer Function

Use the image stabilizer to reduce the effects of shake during recording.

This unit is equipped with Hybrid Optical Image Stabilizer.

Hybrid Optical Image Stabilizer is a hybrid of optical and electrical image stabilizer.

- Please refer to page 60 for details about the Optical Image Stabilizer Lock.

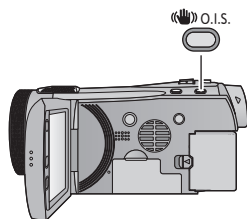

Optical image stabilizer button

Press the button to turn optical image stabilizer on/off.

(Motion Picture Recording Mode)

◀ [O.I.S. ON] / [O.I.S. OFF] → (setting canceled)

- When [HYBRID O.I.S.] is [ON], [O.I.S. ON] is displayed. When [OFF], [O.I.S. OFF] is displayed.
- When recording with a tripod in Motion Picture Recording Mode, we recommend that you set the image stabilizer off.

(Still Picture Recording Mode)

[MODE1] / [MODE2] → (setting canceled)

- When [O.I.S.] is [MODE1], [MODE1] is displayed. When [O.I.S.] is [MODE2], [MODE2] is displayed.

■ Changing Image Stabilizer Mode

(Motion Picture Recording Mode)

MENU : [RECORD SETUP] → [HYBRID O.I.S.] → [ON] or [OFF]

When set to [ON], you can further improve image stabilization for recording while walking, or holding the unit and recording a distant subject with zoom.

- This function's default setting is [ON].

(Still Picture Recording Mode)

MENU : [RECORD SETUP] → [O.I.S.] → [MODE1] or [MODE2]

[MODE1]:

The function works all the time.

[MODE2]:

The function works when the button is pressed. We recommend using this mode when you are recording yourself or recording with a tripod in Still Picture Recording Mode.

1080/60p recording

This is a 1080/60p (1920×1080/60 progressive) recording mode that can record in maximum quality*.

* This means the highest quality for this unit.

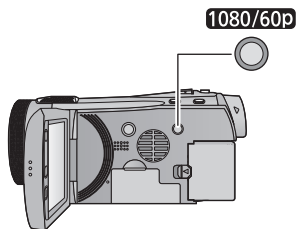

1080/60p button

To set to 1080/60p recording mode, press and hold the button until **1080/60p** is displayed.

- To return to normal recording mode, press and hold the button until **1080/60p** disappears.

-
- Please refer to page 155 for details about approximate recordable time.

1080/60p

- The scenes recorded in 1080/60p can be saved or played back by this unit or by using the HD Writer AE 3.0 software.

Recording with the Touch function

You can record using convenient functions just by the easy operation of touching the screen.

- 1 Touch ◀ (left side)/▶ (right side) of  on the Touch Menu to display Touch function icons. (→ 30)**







- 2 (e.g. AF/AE tracking)**

Touch the Touch function icon.

- To cancel, touch the Touch function icon again. (Optical Image Stabilizer Lock is canceled by releasing the finger touching .



Touch function icons

	Touch Zoom
	AF/AE tracking
	Optical Image Stabilizer Lock* ¹
	Touch Shutter* ²

*¹ In Motion Picture Recording Mode only

*² In Still Picture Recording Mode only.



- An icon is displayed in the **A** position when the Touch function icon is set.



Touch Zoom



You can zoom by touching on the touch zoom bar.

- Touch zoom function is useful for making fine adjustments to the zoom magnification.

- 1 Touch .**

- Touch zoom bar appears.
- The touch zoom bar will disappear when no function is performed for a specific period of time. To display it again, touch the screen.

- 2 Touch and hold the touch zoom bar.**

- You can zoom to the touched position.
- Touch T side to zoom in or touch W side to zoom out.
- You can also zoom by sliding the touch zoom bar toward the T or W while touching it.



- B** Touch zoom bar
- C** Zoom magnification position

- Screen display will disappear when no function is performed for a specific period of time. To display it again, touch the screen while Touch zoom bar is displayed.
- Please refer to page 55 for details about the zoom speed.



It is possible to set the focus and exposure to the subject specified on the touch screen. The focus and exposure will keep following the subject automatically even if it moves.

(Dynamic tracking)

1 Touch .

- When [FACE RECOG.] (→ 69) is [ON] and a registered face is detected, the target is automatically locked.

2 Touch the object and lock the target.

- When you touch the head of the object, the target frame on the head gets locked and tracking starts.
- Touch the object to be changed again when you want to change the target.
- When the Intelligent Auto Mode is selected, the setting becomes **FA** (Normal) and touched object is tracked. Selection becomes **FB** (Portrait) when target frame is locked on a face. (It may turn to **FA** (Normal) even if the target is locked on the face when a spotlight is shining or with a dark scene.)



A Target frame

3 Start recording.

■ About target frame

- When target lock fails, the target frame blinks in red and then disappears. Touch a characteristic part (color etc.) on the object to lock onto it again.
 - When the  button is pressed halfway in Still Picture Recording Mode, the focus is set to the object that is locked. The target frame turns green when it focuses, and the target cannot be changed.
-
- This function cannot be used in Manual Mode. When Manual Mode is set in Still Picture Recording Mode, it can only be used with some settings in Scene Mode.
 - It may track different objects or may not lock the target depending on the recording conditions such as the following:
 - When the object is too large or too small
 - When color of the object is similar to the background
 - When the scene is dark
 - When the target is locked in Still Picture Recording Mode, the screen may become dark or the AF assist lamp may turn on.
 - AF/AE tracking will be canceled in the following cases.
 - When the mode is changed
 - When the unit is turned off
 - When the Scene mode is set
 - Switch to Intelligent Auto Mode/Manual Mode
 - Switch to face-to-face recording



Optical Image Stabilizer Lock



In Motion Picture Recording Mode, you can further improve optical image stabilization by touching and holding Optical Image Stabilizer Lock icon. With this function, you can further reduce the effects of the shake that tends to occur when using zoom.

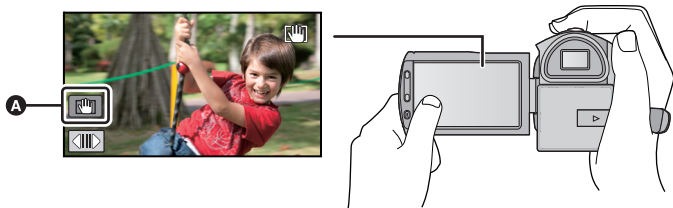

A Optical Image Stabilizer Lock icon

- 1 Press the **Optical Image Stabilizer** button to turn the image stabilizer on.
- 2 Touch and hold .

-  is displayed while you are touching the icon.
- Optical Image Stabilizer Lock is released when you remove your finger from the icon.

■ To set the display method of the Optical Image Stabilizer Lock icon

MENU : [RECORD SETUP] → [O.I.S. LOCK DISPLAY] → desired setting

[OFF]: If no operation is performed for approx. 5 seconds, the icon disappears.

[ON]: Constantly display.

- Stabilization may not be possible under strong shaking conditions.
- To record while moving the unit quickly, release Optical Image Stabilizer Lock.



Touch Shutter



It is possible to focus and record a still picture of a subject that is touched.

- 1 Touch .
- 2 Touch the subject.

- Focus area will display to the touched position, and a still picture is recorded.



- Depending on the recording conditions or recognition of the touched position, it may not be possible to record the intended picture.

Recording functions of operation icons

Select the operation icons to add different effects to the images to be recorded.

1 Touch ◀ (left side)/▶ (right side) of on the Touch Menu to display the operation icons. (→ 30)

- Touch ▲ / ▼ on Touch Menu to switch pages upward or downward.

















2 (e.g. Backlight compensation) Touch an operation icon.

- Select the operation icon again to cancel the function.
- Refer to the respective pages for cancelled the following functions.
 - Smile shot (→ 63)
 - Built-in flash (→ 63)
 - Self-timer (→ 64)
 - Guideline (→ 65)



Operation icons

	Fade*1
	Intelligent contrast control*1, 2
	PRE-REC*1
	Smile shot*1
	Built-in flash*3
	Red-Eye Reduction*2, 3
	Self-timer*3

	Intelligent exposure*2, 3
	Backlight compensation
	Soft skin mode*2
	Tele macro
	Guideline
	Color Night Rec*1, 2
	Headphone volume adjustment*4

*1 Not displayed in Still Picture Recording Mode.

*2 Not displayed in the Intelligent Auto Mode.

*3 Not displayed in Motion Picture Recording Mode.

*4 It is displayed only when a headphone is connected to the headphone output terminal.

- If you turn off the unit or change the mode to  , PRE-REC, Backlight compensation, Color night rec, Self-timer and Tele macro functions are canceled.
- If you turn off the unit, the Fade function is canceled.
- It is possible to set from the menu.
(Except for the PRE-REC and Headphone volume adjustment)

Fade



When you start recording, the image/audio gradually appears. (Fade in)

When you pause recording, the image/audio gradually disappears. (Fade out)

- The Fade setting is canceled when the recording stops.

■ To select the color for Fade in/out

 : [RECORD SETUP] → [FADE COLOR] → [WHITE] or [BLACK]

(Fade in)



(Fade out)



- The thumbnails of scenes recorded using fade in become black (or white).



Intelligent contrast control



This brightens parts that are in shadow and difficult to see and suppresses white saturation in bright parts at the same time. Both bright and dark parts can be recorded clearly.

- If there are extremely dark or bright parts or the brightness is insufficient, the effect may not be clear.



PRE-REC

This prevents you from missing a shot.



This allows recording of the pictures and sound to start approximately 3 seconds before the recording start/stop button is pressed.

-  appears on the screen.
- Aim the unit at the subject beforehand.
- There is no beep sound.
- PRE-REC is canceled in the following cases.
 - If you change the mode
 - If you remove the SD card while [MEDIA SELECT] is set to [VIDEO/SD CARD]
 - If you touch [MENU] or [Q.MENU]
 - If you press 1080/60p button
 - If you turn the unit off
 - If you start recording
 - After 3 hours have passed
- After setting PRE-REC, if recording starts in less than 3 seconds, or while the PRE-REC indication flashes within about 3 seconds after initiating the Quick start operation, motion pictures taken 3 seconds before pressing the recording start/stop button cannot be recorded.
- Images displayed on the thumbnail in Playback Mode will differ from the motion pictures displayed at the start of playback.

Smile shot

When a smiling face is detected during motion picture recording, the unit automatically records a still picture.











The icon changes each time it is touched.

 ([ON]) →  ([FACE RECOG.]) → [OFF]

 : The unit records a still picture on detecting a smiling face.

 : Still pictures are only recorded when the face of a person registered using Face Recognition (→ 69) is detected.

[OFF]: Cancel the setting.



- During Smile Shot recording, the face detected as a smiling face is surrounded by a green frame and  /  are red.
 - Smile Shot recording will not work in the following cases. ( /  will flash)
 - When [MEDIA SELECT] is set to [PICTURE/SD CARD], and there is no SD card inserted.
 - When it is set to Manual Focus
 - When the Interval recording is used
 - When [FACE RECOG.] is set to [OFF], or no one is registered (In  ([FACE RECOG.] only)
-
- Depending on the recording conditions (type of smile, camera shake, etc.), the face of the subject may not be detected correctly.
 - The number of recording pixels are  (4864×2736),  (3840×2160) or  (1920×1080). (→ 78)
 - When still pictures that have been recorded using the Smile Shot are displayed as thumbnails, the  appears.
 - When the AF/AE tracking function is target locking a face of the subject, still pictures are only recorded if a smiling face is detected on the locked subject. When the Smile Shot function is set to  ([FACE RECOG.]), it will record only if the face of a subject registered with [FACE RECOG.] is locked as a target.

Built-in flash

When the  button is pressed, the flash is activated and the picture will be recorded. Use the Built-in flash in order to record still pictures in dark places.

Each time the  icon is selected, the indication changes by one setting in the following order:

 ([ON]) →  A ([AUTO]) →  ([OFF])

- The unit automatically determines if the flash is necessary even when it has been set to  by detecting the ambient brightness. (If it determines that the flash is necessary, the  indication lights up in red.)



■ To adjust the brightness of the flash

 [MENU] : [PICTURE] → [FLASH LEVEL] → desired setting

[-]: Less bright

[±0]: Normal

[+]: Much brighter

-
- The light from the flash may be blocked by the lens hood when the lens hood is attached.
 - Do not use the flash with the ND filter (optional) or the conversion lens (optional) attached.
 - If the  indication etc. flashes when the  button is pressed halfway, the flash is not activated.

- The available range of the flash is approx. 1 m to 2.5 m (3.3 feet to 8.2 feet) in dark places.
- Using the flash fixes a shutter speed to 1/500 or slower.



Red-Eye Reduction



Reduces the phenomena where human eyes become red from flashes.

- The flash is activated 2 times.
- The red-eye phenomenon tends to appear in certain recording conditions and more with some people than with others.
- When faces are detected in the Intelligent Auto Mode, the Red-Eye Reduction is set to on.









Self-timer



This is for recording still pictures using the timer.



Each time the  icon is selected, the indication changes by one setting in the following order:

 10 (Records after 10 seconds) →  2 (Records after 2 seconds) → setting canceled

- When the  button is pressed, a still picture is recorded after the  10 or  2 display and the recording lamp flashes for the time which has been set. After recording, the Self-timer is canceled.
- In Auto Focus Mode, if the  button is pressed halfway once and then fully, the lens focuses on the subject when the button is pressed halfway. If the  button is pressed fully all at once, the lens focuses on the subject just before recording.

To stop the timer midway through

Touch [CANCEL].

- Setting the Self-timer to  2 is a good way to prevent image shake when the  button is pressed while using a tripod etc.
- Self-timer can be stopped midway by pressing MENU on the remote control.



Intelligent exposure



This brightens dark areas so the image can be recorded clearly.

- If there are extremely dark parts or the brightness is insufficient, the effect may not be clear.



Backlight compensation



This makes the image brighter to prevent darkening of a backlit subject.



Soft skin mode



This makes skin colors appear softer for a more attractive appearance.

This is more effective if you record a person closely from the torso up.

- If the background or anything else in the scene has colors similar to the skin color, they will also be smoothed.
- If the brightness is insufficient, the effect may not be clear.
- If you record a person in the distance, the face may not be recorded clearly. In this case, cancel Soft Skin Mode or zoom in on the face (close-up) to record.



Tele macro



A more impressive image can be obtained by focusing on the object only in close-up and shading off the background.

- The unit can focus on the subject at a distance of approx. 70 cm (28").
- When the Tele macro is set with the zoom magnification less than 12 \times , it will automatically be set to 12 \times .

- Tele Macro function is canceled when the zoom magnification becomes lower than 12 \times .



Guideline



You can check if the image is level while recording or playing back motion pictures and still pictures. The function can also be used to estimate the balance of the composition.

It will switch every time the icon is touched.

→ → → Setting canceled

- It is possible to set from the quick menu. (→ 45)
- The guidelines do not appear on the images actually recorded.

■ Displaying Guidelines at playback

- Change the mode to and touch the play mode select icon. Then set [VIDEO/PICTURE] to [1080/60p], [AVCHD] or [iFrame]. (→ 41)

MENU : [VIDEO SETUP] → [GUIDE LINES] → desired setting

- To cancel the Guideline function during playback, set to [OFF].
- It cannot be set while in Still Picture Playback Mode.



Color Night Rec



This function allows you to record color images in very low light situations. (Minimum required illumination: approx. 1 lx)

- Recorded scene is seen as if frames were missed.
- If set in a bright place, the screen may become washed out for a while.
- Bright dots that are usually invisible may be seen, but this is not a malfunction.
- Using a tripod is recommended.
- In darker areas, Auto Focus may focus a bit slower. This is normal.



Headphone volume adjustment



Adjust the volume of the headphone while recording. (When the LCD monitor is in use)

: Increase the volume

: Decrease the volume

- Actual volume to be recorded does not change.

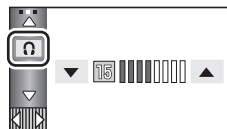











Recording functions of menus

[SCENE MODE]



When you record images in different situations, this mode automatically sets optimum shutter speeds and apertures.

MENU : [RECORD SETUP] → [SCENE MODE] → desired setting

[OFF]:	Cancel the setting
 Sports:	To make fast moving scenes less shaky with slow playback and pause of playback
 Portrait:	To make people stand out against the background
 Spotlight:	Improved quality when subject is brightly illuminated.
 Snow:	Improved image quality when shooting in snowy locations.
 Beach:	To make blue in the sea or sky vibrant
 Sunset:	To make red in the sunrise or sunset vibrant
 Fireworks:	To capture the fireworks in the night sky beautifully
 Scenery:	For spatial scenery
 Night scenery:	To capture the evening or night scenery beautifully.
 Low light:	For dark scenes, such as at dusk (In Motion Picture Recording Mode only)
 Night portrait:	To capture a person and the background brightly. (In Still Picture Recording Mode only)

- **(Sports/Portrait/Spotlight/Snow/Beach/Sunset/Scenery)**
 - The shutter speed is 1/8 or more in Still Picture Recording Mode.
- **(Sunset/Low light)**
 - The shutter speed is 1/30 or more (When [DIGITAL CINEMA] is [ON], it is 1/24 or more.) in Motion Picture Recording Mode.
- **(Sunset/Fireworks/Scenery/Night scenery)**
 - Image may get blurry when a close object is recorded.
- **(Sports)**
 - During normal playback, the image movement may not look smooth.
 - Color and screen brightness may change under indoor lighting.
 - If the brightness is insufficient, the Sports Mode does not function. The  display flashes.
- **(Portrait)**
 - Color and screen brightness may change under indoor lighting.
- **(Fireworks)**
 - The shutter speed is 1/30.
 - Image may get washed out when recorded in bright surroundings.

- **(Night scenery/Night portrait)**
 - The shutter speed is 1/2 or more in Still Picture Recording Mode.
 - Using a tripod is recommended.
- **(Night portrait)**
 - The flash is set to [ON].

[ZOOM MODE]



Set the maximum zoom ratio for the Motion Picture Recording Mode.

: [RECORD SETUP] → [ZOOM MODE] → **desired setting**

[Opt.Zoom 12×]:	Optical zoom only (Up to 12×)
[i.Zoom 20×]:	This zoom function allows you to maintain high-definition picture quality (Up to 20×)
[D.Zoom 30×]:	Digital zoom (Up to 30×)
[D.Zoom 700×]:	Digital zoom (Up to 700×)

- The larger the digital zoom magnification, the more the image quality is degraded.
- This function cannot be used in Still Picture Recording Mode.

[REC MODE]



Switch the picture quality and recording format of the motion pictures to be recorded.

: [RECORD SETUP] → [REC MODE] → **desired setting**

- It is possible to set from the quick menu. (→ 45)

[HA]/[HG]/[HX]/[HE]*¹:	Set the recording mode to AVCHD.
[iFrame]*²:	Set the recording mode to iFrame.

*¹ Recording will have higher quality in the order of [HA], [HG], [HX], and [HE].

*² iFrame is a format suitable for Mac (iMovie'11). It is recommended for when using a Mac.

- **Recordable time using the battery (→ 23)**
- This function's default setting is [HG] mode.
- Please refer to page 155 about approximate recordable time.
- When the unit is moved a lot or moved quickly, or when a fast-moving subject is recorded (particularly when recording in [HE] mode), mosaic-type noise may appear at playback.

[TIME LAPSE REC]



A scene that moves slowly for long period of time is recorded frame by frame with an interval, and is recorded as a short time motion picture.

A frame is recorded with a set recording interval.

30 frames will make up motion picture of 1 second.

- Set [ZOOM MODE] to [Opt.Zoom 12×]. (→ 67)
- Set [REC MODE] to [HA], [HG], [HX] or [HE]. (→ 67)

: [RECORD SETUP] → [TIME LAPSE REC] → desired setting

[OFF]:

Cancel the setting

[1 SECOND]/[10 SECONDS]/[30 SECONDS]/[1 MINUTE]/[2 MINUTES]:

Change the recording interval.

- appears on the screen.
- After recording, the setting of interval recording is canceled.
- Audio cannot be recorded.

Setup example	Setup time (recording interval)	Recording time	Recorded time
Sunset	1 s	Approx. 1 h	Approx. 2 min
Blooming	30 s	Approx. 3 h	Approx. 12 s

- Maximum recordable time is 12 hours.

- Still picture recording cannot be used.
- Recording mode cannot be changed when the Interval recording is set.
- If you turn off the unit or change the mode to , this function is canceled.
- The shortest motion picture recording time is 1 second.
- Color balance and focus may not be adjusted automatically depending on light sources or scenes. If so, manually adjust these settings. (→ 83, 85)

[DIGITAL CINEMA]



Use this function to record an image with vivid color, like an image on a movie film.

- Switch to Manual Mode. (→ 82)
- Set [ZOOM MODE] to [Opt.Zoom 12×]. (→ 67)
- Set [REC MODE] to [HA] or [HG]. (→ 67)

: [RECORD SETUP] → [DIGITAL CINEMA] → [ON]

- The shutter speed is 1/48 or more. (When [AUTO SLOW SHTR (2D)] is [ON], it is 1/24 or more.)
- The images may not appear smooth.



It is possible to continuously record motion picture to an SD card when there is no space available in the built-in memory. (It allows you to record only to SD card from built-in memory.)

- Set **[MEDIA SELECT]** to **[Built-inMemory]**.
- Set **[REC MODE]** to **[HA]**, **[HG]**, **[HX]** or **[HE]** (→ 67), or set to **1080/60p** recording mode. (→ 57)
- Insert an SD card.

MENU : **[RECORD SETUP]** → **[RELAY REC]** → **[ON]**

- ⇨ □ is displayed on the screen. ⇨ □ will disappear when space in the built-in memory is gone and the recording to the SD card starts.
 - Relay recording can only be performed once.
 - **Combine the scenes that were relay-recorded using the [RELAY SCENE COMBINE] into the SD card. (→ 101, 111)**
 - Once you have performed **[RELAY SCENE COMBINE]**, you can use the Relay Recording function again. If the **[RELAY REC]** is set to **[ON]** without performing the **[RELAY SCENE COMBINE]**, a message is displayed. You will be able to perform Relay Recording by touching **[YES]**, but you will not be able to perform the **[RELAY SCENE COMBINE]** after that.
-
- Still pictures are recorded to the SD card after Relay recording.
 - ⇨ is displayed on the thumbnail display during the playback of a scene that was relay-recorded on the built-in memory.

[FACE RECOG.]

Face Recognition is a function for finding faces that resemble faces which have already been registered and automatically prioritizing focus and exposure for those faces. This function makes it possible to keep the face of your loved ones in focus even when they are at the back or on the end of a line in a group picture.

MENU : **[RECORD SETUP]** → **[FACE RECOG.]** → **desired setting**

[OFF]:	Cancel the setting
[ON]:	The Face Recognition function is available
[SET]:	Face Recognition registration/editing/cancellation

■ Registering a face for face recognition

MENU : [RECORD SETUP] → [FACE RECOG.] → [SET] → [SET]

- Up to a maximum of 6 people can be registered.

1 Align the person's face with the guide.

- Take a picture of the person's face from the front, ensuring that their hair does not hide the outline of their face, their eyes or their eyebrows.

2 Touch [REC] or press the button fully.

- Touch [ENTER].
- It may not be possible to register a face depending on the recording conditions. In this case, try recording the face again.

3 Entering the person's name.

- Touch the text entry icon in the center of the screen and enter the name.
- After entering the name, touch [Enter].

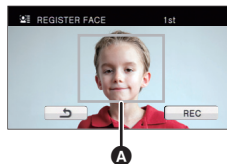

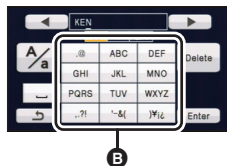

A Guide



B Text entry icon

Entering text

Icon	Description of operation
[A] etc.	Enters a character.
	Moves cursor left.
	Moves cursor right.
[A/a]	Switches between [A]/[a] (alphabet) and [&/1] (symbols/numbers).
	Enter a space.
[Delete]	Deletes a character. Deletes the previous character if the cursor is in an empty space.
[Enter]	Ends text entry.

- A maximum of 9 characters can be entered.

4 Touch [ENTER] to end registration.

- Touch [EXIT].

■ Changing the information of a registered person

1 Select the menu.

MENU : [RECORD SETUP] → [FACE RECOG.] → [SET] → [EDIT]

2 Touch the desired item to enter the setting.

- Up to 3 face shots can be registered. To additionally register or to change/delete the registered face shots, touch  or the face shot.
- If you register several face shots of the same person (up to 3 face shots can be registered), each with a different facial expression or different background, it is more likely that face recognition will be successful.



[SET NAME]:

Change the name.

[PRIORITY]:

Focus and exposure will be set in priority according to the registration order setting from the first person. Target will be locked according to the registration order setting from the first person when AF/AE tracking is active.

- To change the registration order, select the person you wish to change.

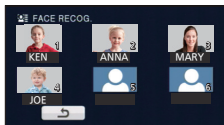

[FOCUS ICON]:

This changes the focus indication icon that appears during still picture recording. (Only displayed when Face Recognition is in use.)

- Touch the icon you wish to have displayed.

3 Touch [ENTER].

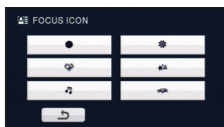

■ Canceling a registered person

1 Select the menu.

MENU : [RECORD SETUP] → [FACE RECOG.] → [SET] → [DELETE] or [DELETE ALL]

- Touching [DELETE ALL] cancels all the registered people.

2 (When [DELETE] is selected)

Touch the person to cancel.

- When touched, the person is selected and  is displayed. To cancel the selected person, touch again.
- Touch [ENTER].

- Since face recognition searches for faces that resemble the registered faces, there is no guarantee of positive recognition.
- It may not be possible to correctly recognize a person who has been registered due to differences in facial expression and environment.
- Perform the registration again if recognition becomes unstable in cases such as when facial features change with age.

[NAME DISPLAY]



When a registered person is detected by face recognition during recording, the name registered for that person is displayed.

MENU : [RECORD SETUP] → [NAME DISPLAY] → desired number

[OFF]/[1]/[2]/[3]

- Displayed name will disappear after a while.
- It is displayed according to the registration order setting from the first person.
- This function is not displayed during the face-to-face recording or Playback Mode.

[FACE FRAMING]



Detected faces appear with frames.

MENU : [RECORD SETUP] → [FACE FRAMING] → desired setting

[OFF]:

Cancel the setting.

[PRIMARY]:

Only the prioritized face framing is displayed.

[ALL]:

All face detection framings are displayed.



- Up to 15 frames are indicated. Larger faces and faces nearer to the center of the screen take preference over others. When [FACE RECOG.] is [ON] registered people are given priority.

■ Prioritized face framing

Prioritized face framing is displayed as orange frames. Focus and adjustment of brightness will be performed against the prioritized face framing.

- Prioritized face framing is only displayed with Portrait Mode in the Intelligent Auto Mode.
- The white frame is for face detection only.
- Focus will be set to prioritized face framing and the brightness adjusted when the unit is set to Portrait mode in Intelligent Auto Mode.
- Focus will be set to prioritized face framing when the  button is pressed halfway when recording still pictures. Prioritized face framing will turn to green when the focus is set.

[AUTO SLOW SHTR (2D)]



You can record bright pictures even in dark places by slowing the shutter speed.

- **Switch to Manual Mode.** (→ 82)

MENU : [RECORD SETUP] → [AUTO SLOW SHTR (2D)] → [ON]

- The shutter speed is set to 1/30 or more depending on the surrounding brightness.

- This function cannot be used when using the 3D Conversion Lens (optional).
- This function cannot be used in Still Picture Recording Mode.
- When the shutter speed becomes 1/30, the screen may be seen as if frames are missed and afterimages may appear.

[AUTO SLOW SHTR (3D)]



This auto slow shutter function is only used with the 3D Conversion Lens (optional).

MENU : [RECORD SETUP] → [AUTO SLOW SHTR (3D)] → [ON]

- For details, refer to [AUTO SLOW SHTR (2D)].

- This function's default setting is [ON].
- When a 3D Conversion Lens is used, the recording scene will become darker. We recommend setting this function to [ON].

[AGS]



If the unit continues to be tilted upside down from the normal horizontal position while recording motion pictures, it is automatically put into recording pause.

MENU : [RECORD SETUP] → [AGS] → [ON]

- The AGS function may activate and cause the unit to pause the recording if you are recording a subject right above or right below you.

[Digital Cinema Color]



Recording motion pictures with more vivid colors, using x.v.Color™ technology.

- **Switch to Manual Mode. (→ 82)**
- **Set [REC MODE] to [HA], [HG], [HX] or [HE] (→ 67), or set to 1080/60p recording mode. (→ 57)**

MENU : [RECORD SETUP] → [Digital Cinema Color] → [ON]

- For more realistic colors, use an HDMI mini cable with a TV that supports the x.v.Color™.
- **When motion pictures recorded while this function is turned [ON] are played back with a TV not compatible with x.v.Color™, colors may not be reproduced properly.**
- To play back images recorded in Digital cinema color with vivid colors of wider color ranges, a device compatible with x.v.Color™ is required. When these images are played back with devices other than ones compatible with x.v.Color™, it is recommended to record the images after this function is turned [OFF].
- x.v.Color™ is a name for devices that are compatible with the xvYCC format, an international standard for expanded color in motion pictures, and that follow the rules for signal transmission.

[SHOOTING GUIDE]



Message is displayed when this unit is moved rapidly.

MENU : [RECORD SETUP] → [SHOOTING GUIDE] → [ON]

When “CAMERA PANNING IS TOO FAST.” appears, move the unit slowly while recording.

• **Set to [OFF] to turn off the message indication.**

• Message will not appear while pausing the recording. (Message will appear even if it is pausing the recording if [DEMO MODE] is set to [ON].)

[WIND NOISE CANCELER]



This will reduce the wind noise coming into the built-in microphones while maintaining the realism.

• **Switch to Manual Mode. (→ 82)**

MENU : [RECORD SETUP] → [WIND NOISE CANCELER] → [ON]

- This function's default setting is [ON].
- When switching to Intelligent Auto Mode, [WIND NOISE CANCELER] is set to [ON], and the setting cannot be changed.
- You may not see the full effect depending on the recording conditions.
- If wind sound cannot be reduced with the Wind noise canceler function alone, set [BASS SETTING] to [LOWCUT]. (→ 76)

[MIC SETUP]



Recording setting of the built-in microphone can be adjusted.

• **Switch to Manual Mode. (→ 82)**

MENU : [RECORD SETUP] → [MIC SETUP] → **desired setting**

[SURROUND]:	Sound is recorded with 5.1 ch surround microphone.
[ZOOM MIC]:	Directivity of the microphone is synchronized with the zoom operation. Sounds near the front of the unit are recorded more clearly if you zoom in (close-up) and surrounding sounds are recorded more realistically if you zoom out (wide angle).
[FOCUS MIC]:	Directivity of the center is enhanced for recording audio near the front of the unit more clearly.
[STEREO MIC]:	Sound from two directions is recorded in 2 ch by forward-facing stereo microphones.

- If you wish to record higher quality sound and maintain realism even when zooming in, for instance, when recording a music recital, we recommend setting [MIC SETUP] to [SURROUND].
- If you have an external microphone connected when recording in [iFrame], [MIC SETUP] is set to [STEREO MIC] automatically.

[MIC LEVEL]



When recording, the input level from the built-in microphones and the external microphone terminal can be adjusted.

- **Switch to Manual Mode.** (→ 82)

1 Select the menu.

MENU : [RECORD SETUP] → [MIC LEVEL] → desired setting

[AUTO]: AGC is activated, and the recording level is adjusted automatically.

[SET+AGC]/[SET]: The desired recording level can be set.

- It is possible to select the setting from the quick menu in Manual Mode. (→ 45) The microphone level returns to the setting adjusted previously, and it cannot be set from the quick menu.

2 (When [SET+AGC]/[SET] is selected)

Touch / **to adjust.**

- Touch **AGC** to activate/disactivate AGC. When AGC is activated, the icon is surrounded by yellow and the amount of sound distortion can be reduced. When AGC is deactivated, natural recording can be performed.
- Adjust the microphone input level so that the last 2 bars of the gain value are not red. (Otherwise, the sound is distorted.) Select a lower setting for microphone input level.

3 Touch [ENTER] to set the microphone input level and then touch [EXIT].

- (Microphone input level meter) appears on the screen.

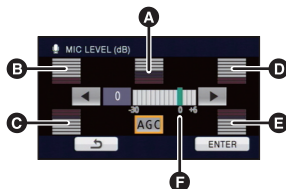

- A** Center
- B** Front left
- C** Back left
- D** Front right
- E** Back right
- F** Microphone input level

- When switching to Intelligent Auto Mode, the setting is fixed to [AUTO] and cannot be changed.
- When [MIC SETUP] is [ZOOM MIC], the volume will be different depending on the zoom rate.
- When [MIC SETUP] is set to [STEREO MIC] or external microphone input is used, the sound is stereo (2 ch) and only the front-left and front-right input level meters function.
- The microphone input level meter shows the largest volume for the microphones.
- You cannot record with the audio completely muted.

[BASS SETTING]



Change the lower setting of the built-in microphone according to your choice.

- Switch to Manual Mode. (→ 82)

MENU : [RECORD SETUP] → [BASS SETTING] → desired setting

[0dB]/[+3dB]/[+6dB]/[LOWCUT]

- Normally set to [0dB].
- Select [+3dB] or [+6dB] to get strong power feeling at bass level.

[PICTURE ADJUST]



Adjust the quality of the image while recording.

Adjust by outputting to a TV while adjusting the quality of the image.

- This setting is retained when you change between Motion Picture Recording Mode and Still Picture Recording Mode.
- Switch to Manual Mode. (→ 82)

1 Select the menu.

MENU : [RECORD SETUP] → [PICTURE ADJUST]

2 Touch the desired setting items.

[SHARPNESS]:	Sharpness of the edge
[COLOR]:	Depth of the color of the image
[EXPOSURE]:	Brightness of the image
[WB ADJUST]:	Picture color balance

3 Touch ◀/▶ to adjust settings.

4 Touch [ENTER].

- Touch [EXIT] to complete the settings.
- appears on the screen.

[ZEBRA]



Parts where white saturation (color saturation) is likely to occur (extremely brightly lit or shiny parts) are displayed with diagonal lines (zebra pattern).

- Switch to Manual Mode. (→ 82)

MENU : [RECORD SETUP] → [ZEBRA] → [ON]

- It is possible to set from the quick menu in Manual Mode. (→ 45)



A Zebra pattern

- You can record an image with little white saturation if you manually adjust the shutter speed or brightness (Iris/Gain) (→ 84).
- The zebra pattern does not appear on the images actually recorded.

[LUMINANCE]



Displays the luminance level of the center of the screen (luminance display frame) in %. It makes the adjustment of the brightness of the object easier, by checking the luminance level of the object, when recording same object in different surroundings.

Adjust the brightness using [IRIS]. (→ 84)

- **Switch to Manual Mode.** (→ 82)

MENU : [RECORD SETUP] → [LUMINANCE] → **desired setting**

- It is possible to set from the quick menu in Manual Mode. (→ 45)

[OFF]:

Cancel the setting.

[ALWAYS]:

Constantly display.

[ON ADJUST]:

Display only when [IRIS] is adjusted. (→ 84)

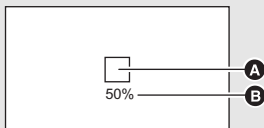

A Luminance display frame

B Luminance level

- Luminance level is displayed between 0% and 99%. It will be displayed as 99% ↑ when it is over 99%.

[HISTOGRAM]



A graph with brightness as horizontal axis and number of pixels at that brightness as vertical axis is displayed. It is possible to determine the exposure of the whole image by looking at the distribution in the graph.

Adjust the brightness using [IRIS]. (→ 84)

- **Switch to Manual Mode.** (→ 82)

MENU : [RECORD SETUP] → [HISTOGRAM] → **desired setting**

- It is possible to set from the quick menu in Manual Mode. (→ 45)

[OFF]:

Cancel the setting.

[ALWAYS]:

Constantly display.

[ON ADJUST]:

Display only when [IRIS] is adjusted. (→ 84)

■ Example of the display

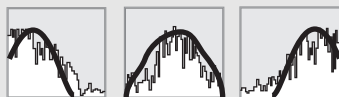

A Normal

B Dark

C Bright











The higher the number of pixels, the higher the clarity of the picture when printing.

MENU : [PICTURE] → [PICTURE SIZE] → desired setting

- It is possible to set from the quick menu. (→ 45)

- The number of recording pixels that can be set changes depending on selected screen aspect ratio. (→ 79)

■ Picture size and Maximum zoom ratio

Picture size		Aspect ratio	Extra optical zoom (→ 55)
	4032×3024	[4:3]	—*
	3200×2400		13.2×
	2560×1920		16.5×
	640×480		25×
	4608×3072	[3:2]	—*
	3600×2400		13.2×
	2880×1920		16.5×
	4864×2736	[16:9]	—*
	3840×2160		13.2×
	3072×1728		16.5×



* Extra optical zoom cannot be used. The maximum zoom magnification is 12×

■ Picture size in Motion Picture Recording Mode

- Change the mode to .

MENU : [PICTURE] → [PICTURE SIZE] → desired setting

- It is possible to set from the quick menu. (→ 45)

Picture size		Aspect ratio
	4864×2736	[16:9]
	3840×2160	
	1920×1080	

- This function's default settings are **[4.2M]** in Still Picture Recording Mode and **[13.3M]** in Motion Picture Recording Mode.
- The recording will become longer depending on the recording pixels.
- Please refer to page 156 for details about the number of recordable pictures.

[QUALITY]



Selecting the picture quality.

MENU : [PICTURE] → [QUALITY] → **desired setting**



Still pictures with a high picture quality are recorded.



Priority is given to the number of still pictures recorded. Still pictures are recorded in normal picture quality.

[ASPECT RATIO]



This allows you to select the aspect ratio of the pictures to suit printing or the playback method.

MENU : [PICTURE] → [ASPECT RATIO] → **desired setting**

[4:3]: Aspect ratio of 4:3 television

[3:2]: Aspect ratio of conventional film camera or prints (such as L-size print)

[16:9]: Aspect ratio of high-definition television, etc.

- This function's default setting is [3:2].
- When the aspect ratio is set to [4:3] or [3:2], black bands may appear on the left and right of the screen.
- The edges of still pictures recorded on this unit with a [16:9] aspect ratio may be cut at printing. Check the printer or photo studio before printing.



Recording is done continuously at the rate of 60 still pictures per second.
Use this function to record an object with fast movement.

1 Select the menu.

MENU : [PICTURE] → [HI-SPEED BURST] → **desired setting**

[OFF]:

Cancel the setting.

[60 frames/sec]:

180 still pictures are recorded continuously at the rate of 60 per second.

The picture size is **2.1M** (1920×1080).

2 Press the button.

- flashes in red during recording.
- First press the button halfway, then press it fully to set the focus and record. It will automatically focus if you press fully once, so it is convenient when recording objects moving back and forth.

3 Touch [Record] or [Delete].

[Record]: Pictures are stored.

[Delete]: All pictures are deleted.

4 (When [Record] is selected in step 3)

Touch [REC ALL] or [SELECT].

[REC ALL]: All pictures are stored.

[SELECT]: Pictures are stored by specifying range.

5 (When [SELECT] is selected in step 4)

Touch the range of pictures that will be stored.

- Previous (Next) page is displayed by touching / .

* Only select the picture for start point if only 1 picture is to be stored.

- A confirmation message is displayed when [Enter] is touched after selecting the start point and finish point. Touch [YES] to store the pictures.

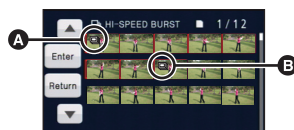
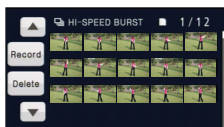

- A** Start point*
- B** Finish point

- If you turn off the unit or change the mode, this function is canceled.
- The maximum number of times you can record on a media is 15.
(In the case of SD cards it is the maximum number of recordable scenes per card.)
- Color balance and brightness on the screen may change with some light sources such as fluorescent lamps.
- Image quality is different from ordinary still picture recording.

[AF ASSIST LAMP]



Illuminating the subject makes it easier for the camera to focus when recording in low light conditions that make focusing difficult.

- **Switch to Manual Mode.** (→ 82)

MENU : [PICTURE] → [AF ASSIST LAMP] → [AUTO]

- The available distance of the AF assist lamp is approx. 1.5 m (5 feet).
- A conversion lens (optional) can block the AF assist lamp, and it will become harder to adjust the focus.
- When switching to Intelligent Auto Mode, the setting is fixed to [AUTO] and cannot be changed.

[SHTR SOUND]



You can add a shutter sound when recording still pictures.

MENU : [PICTURE] → [SHTR SOUND] → **desired setting**

[OFF]: Cancel the setting.

 : Volume low

 : Volume high

- No shutter sound is emitted in Motion Picture Recording Mode.

Manual recording

The operation sequence differs for the LCD monitor and viewfinder.



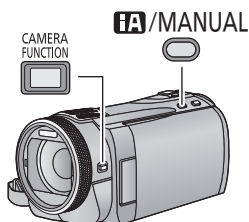

- The **Manual Focus, White Balance, Shutter Speed, Brightness (Iris and Gain)** settings are retained when you change between Motion Picture Recording Mode and Still Picture Recording Mode.

Press the iA/MANUAL button or CAMERA FUNCTION button to switch to Manual Mode.



- **MNL** appears on the screen.



A Manual icons

-  Focus (→ 85)
-  White balance (→ 83)
-  Manual shutter speed (→ 84)
-  Iris adjustment (→ 84)

■ When using the LCD monitor

- 1 Touch the desired item to be set.
- 2 Touch  /  to enter the selection.



- Press the iA/MANUAL button to cancel manual setting.

■ When using the viewfinder

- 1 Press the **CAMERA FUNCTION** button to select the desired item.
 - Selected item changes whenever the CAMERA FUNCTION button is pressed.
- 2 Rotate the multi manual ring to select the setting and press the **CAMERA FUNCTION** button to enter the setting.



- Zoom operation cannot be done using the multi manual ring during setting.

White balance



Automatic white balance function may not reproduce natural colors depending on the scenes or lighting conditions. If so, you can adjust the white balance manually.

- Press the **i/MANUAL** button or **CAMERA FUNCTION** button to switch to **Manual Mode**. (→ 82)
- For how to perform the settings when using the viewfinder, refer to page 82.

1 Touch **[WB]**.

2 Touch / to select **White balance mode**.

- Select the optimal mode by confirming the color on the screen.
- Touch **[WB]** to determine the mode.



Icon	Mode/Recording conditions
	Auto white balance adjustment
	Sunny mode: Outdoors under a clear sky
	Cloudy mode: Outdoors under cloudy sky
	Indoor mode 1: Incandescent light, video lights like in the studio, etc.
	Indoor mode 2: Color fluorescent lamps, sodium lamps in gymnasiums etc.
	Manual adjustment mode: <ul style="list-style-type: none">● Mercury-vapor lamps, sodium lamps, some fluorescent lights● Lights used for wedding receptions at hotels, stage spotlights in theaters● Sunrise, sunset, etc.

- To return to auto setting, set to **AWB** or press the **i/MANUAL** button again.

■ To set the white balance manually

1 Select , fill the screen with a white subject.

2 Touch and set the blinking .

- When using the viewfinder, press and hold the **CAMERA FUNCTION** button.
- When the screen turns black instantly and the display stops flashing and then lights constantly, the setting is complete.
- If the display continues flashing, the white balance cannot be set. In this case, use other White balance modes.



- When the display flashes, the manual white balance previously adjusted is stored. Whenever recording conditions change, re-set the white balance.
- When setting both the white balance and the iris/gain, set the white balance first.
- **AWB** is not displayed on the screen when **AWB** is being set.

Manual shutter speed/iris adjustment



Shutter Speed:

Adjust it when recording fast-moving subjects.

Iris:

Adjust it when the screen is too bright or too dark.

- Press the **iA/MANUAL** button or **CAMERA FUNCTION** button to switch to **Manual Mode**. (→ 82)
- For how to perform the settings when using the viewfinder, refer to page 82.

1 Touch [SHTR] or [IRIS].

2 Touch / to adjust settings.

- Touch [SHTR]/[IRIS] to complete the adjustments.

Shutter speed:

1/60 to 1/8000

- If [AUTO SLOW SHTR (2D)] is set to [ON], the shutter speed will be set between 1/30 and 1/8000.
- If [DIGITAL CINEMA] is set to [ON], the shutter speed will be set between 1/48 and 1/8000. (When [AUTO SLOW SHTR (2D)] is set to [ON], the range is 1/24 to 1/8000.)
- The shutter speed closer to 1/8000 is faster.
- The shutter speed will be set between 1/2 and 1/2000 in Still Picture Recording Mode.

Iris/Gain value:

CLOSE ↔ (F16 to F1.7) ↔ OPEN ↔ (0dB to 18dB)

- Value closer to CLOSE darkens the image.
- Value closer to 18dB brightens the image.
- When the iris value is adjusted to brighter than OPEN, it changes to the gain value.
- To return to auto setting, press the iA/MANUAL button again.

-
- When setting both the shutter speed and the iris/gain value, set the shutter speed and then set the iris/gain value.

Manual shutter speed adjustment

- When the shutter speed is set lower than 1/15 in the Still Picture Recording Mode, using a tripod is recommended. Also, white balance cannot be set. The shutter speed will be set to 1/30 when the unit is turned on again or when the Quick start is performed.
- You may see a band of light around an object that is shining very bright, or highly reflective.
- During normal playback, image movement may not look smooth.
- If you record an extremely bright object or record under indoor lighting, color and screen brightness may change or a horizontal line may appear on the screen. In this case, record in the Intelligent Auto Mode or set the shutter speed to 1/60 in areas where the power supply frequency is 60 Hz, or 1/100 in areas of 50 Hz.

Manual iris/gain adjustment

- Luminance level and histogram are displayed during the iris adjustment. (→ 77)
- If the gain value is increased, the noise on the screen increases.
- Depending on the zoom magnification, there are iris values that are not displayed.

Recording with Manual focus



Perform focus adjustments using the multi manual ring.

If auto focusing is difficult due to the conditions, then use Manual Focus.

- Press the **iA/MANUAL** button or **CAMERA FUNCTION** button to switch to Manual Mode. (→ 82)
- For how to perform the settings when using the viewfinder, refer to page 82.

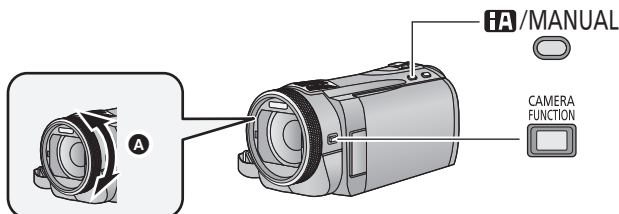

- **A** Rotate the multi manual ring to adjust the focus.

1 (When MF assist function is used)
Select the menu.

MENU : [RECORD SETUP] → [MF ASSIST] → [ON]

- It is possible to set from the quick menu. (→ 45)

- Touch to display the Manual icon.

2 Touch [FOCUS].

3 Touch [MF] to change to Manual Focus.

- MF appears on the screen.

4 Adjust the focus by rotating the multi manual ring.

The in-focus area is displayed in blue. The normal screen returns approximately 2 seconds after you finish bringing the subject into focus.

- When [MF ASSIST] is [OFF], the blue area is not displayed.
- To restore Auto Focus, touch [AF] in step 3 or press the iA/MANUAL button again.



- **A** Part displayed in blue

- When adjusting the focus, you cannot zoom using the multi manual ring.
- The blue display does not appear on the images actually recorded.

Recording 3D video

With the 3D Conversion Lens (optional) attached, you can record life-like and powerful 3D video. To view 3D video, a television that supports 3D is required.

3D video

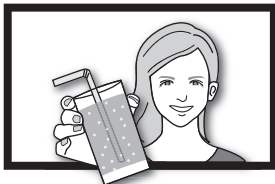

The image is an illustration.

- In the unit, the recordable 3D videos are side-by-side format (2-screen structure).
- Since the 3D video is recorded in side-by-side format, the recorded 3D video is not of high definition picture quality.

■ Recording 3D video

For details on how to attach and how to adjust the attachment position of the 3D Conversion Lens, please read the operating instructions for the 3D Conversion Lens.

When using for the first time, be sure to adjust the 3D Conversion Lens attachment position.

- Turn off the unit.
- Change the mode to  .

1 Attach the 3D Conversion Lens to the unit.

- Attach the 3D Conversion Lens securely so it will not tilt or move.
- You cannot attach the 3D Conversion Lens together with the lens hood or a filter etc.
- Attach the Lens front cap supplied with the 3D Conversion Lens.

2 Turn on the unit.

- Turn on with the unit in a horizontal state.
- The 3D Conversion Lens adjustment mode screen will appear automatically after performing the initial setting.
- If the 3D Conversion Lens adjustment mode screen does not appear automatically, set from the menu.
([SETUP] → [3D CONV. LENS SETUP])
- If the unit is turned on with the USB cable still connected, the USB connection will take priority.

3 Adjust the 3D Conversion Lens attachment part following the instructions on the screen.

- 2 screens will appear.
- The 3D Conversion Lens cannot be adjusted using the viewfinder.

4 Touch [EXIT] to end the adjustment.

- After adjustment, a single screen appears.
- **When re-attaching the 3D Conversion Lens or after an impact etc., it is recommended that you perform the adjustment again.**



- A** [3D] appears.

5 Press the recording start/stop button to start recording.

- Start recording after removing the Lens front cap.
- When the 3D Conversion Lens is attached, the zoom position is fixed, and the zoom operation is disabled.
- When recording in 3D, the image will appear with gray frame around it. The gray frame will be recorded in the video.

To ensure that the 3D video can be safely viewed, pay attention to the following points when recording.

- Where possible, record with the unit in a horizontal state.
 - Do not get too close to the subject. (record from a distance of at least 1.2 m (3.9 feet).)
 - When moving the unit as you record, move it slowly.
 - Try to hold the unit as steady as possible when recording while riding in a vehicle or walking.
-
- Use of a tripod is recommended for recording with a stable picture.
 - The reception range for the remote control might become narrow at the upper side of the unit, so operate from the lower side. (→ 54)
 - [ECONOMY] will not work while you adjust the 3D Conversion Lens attachment position.
 - When the 3D Conversion Lens is attached, the auto slow shutter setting is [AUTO SLOW SHTR (3D)]. The default setting of [AUTO SLOW SHTR (3D)] is [ON]. (→ 73)
 - While 3D recording if moving the unit fast, the message is more likely to appear.
 - If the unit is turned on with the lens cap attached in the shade etc., the screen may appear to be blue. In such a case, remove the lens cap to return the screen to normal.

■ Functions that cannot be used during 3D recording

When recording with the 3D Conversion Lens, you cannot use certain functions.

Functions not available during 3D recording

(Button/lever operations)

- Zoom in/out function*1
- Hybrid Optical Image Stabilizer*2
- Intelligent auto mode*3
- 1080/60p recording*4
- Still picture recording (Still Picture Recording Mode, and still picture recording in Motion Picture Recording Mode)
- Manual operations*5 (focus, shutter speed, iris)
- [EXT DISPLAY] (remote control)



(Setup menu)

- Quick power on
- Quick start
- Initial set

(Recording functions)

- AF/AE tracking
- iFrame ([REC MODE])
- Intelligent contrast control
- Smile shot
- Soft skin mode
- Tele macro
- Guideline
- Color night rec
- Scene mode
- Digital cinema
- Face recognition
- Digital cinema color
- Zoom microphone
- Picture adjust
- Luminance
- Histogram

*1 The zoom position is fixed, and the zoom operation is disabled.

*2 The Optical Image Stabilizer () and Optical Image Stabilizer Lock () can be used.

*3 Intelligent Auto Mode is canceled.

*4 The 1080/60p recording mode is canceled, and the video is recorded with AVCHD picture quality.



*5 Only White Balance can be used. Touch  to display the Manual icon.

Playback Operations

Motion picture playback using operation icon

VIDEO

For details on the basic playback operations, refer to page 41.

Playback operation	Playback display	Operating steps
Fast forward/ rewind playback	During Playback 	<p>Touch ►► during playback to fast forward. (Touch ◀◀ to rewind.)</p> <ul style="list-style-type: none"> The fast forward/rewind speed increases if you touch ►►/◀◀ again. (The display on the screen changes from ►► to ►►►.) Normal playback is restored when you touch ►/ .
Skip playback (to the start of a scene)		<p>Slide the LCD screen display right to left (left to right) while touching it during playback.</p>
Slow-motion playback	During Pause 	<p>With the playback paused, continue touching ►►. (◀◀ is for slow rewind playback) Playback is slow while touching.</p> <ul style="list-style-type: none"> Normal playback is restored when you touch ►/ . When slow-motion pictures are played back in reverse, they will be shown continuously at approximately 2/3rd the speed of normal playback (intervals of 0.5 seconds). Slow-motion playback for iFrame scenes will be in 1 second intervals.
Frame-by-frame playback The motion picture is advanced one frame at a time.		<p>With the playback paused, touch ►►. (Touch ◀◀ to advance the frames one at a time in the reverse direction.)</p> <ul style="list-style-type: none"> Normal playback is restored when you touch ►/ . When the frames are advanced one at a time in the reverse direction, they will be shown in intervals of 0.5 seconds. Frame-by-frame playback for iFrame scenes will be in 1 second intervals.

Playback operation	Playback display	Operating steps
Direct playback	<p>During Playback</p> 	<p>Touch the Direct playback bar or slide it while touching.</p> <ul style="list-style-type: none"> • The playback pauses temporarily and skips to the position touched or slid to while touching. • Playback will start by releasing your touching or sliding finger. • Direct playback bar cannot be operated with the remote control.

Creating still picture from motion picture

VIDEO

A single frame from the recorded motion picture can be saved as a still picture.
Picture size of the still picture to be recorded is **2.1M** (1920×1080).

1 Pause at the scene you want to save as a still picture during playback.

- It is convenient to use slow-motion playback and frame-by-frame playback.

2 Press the button fully.

- Date the motion picture was recorded will be registered as date of the still picture.
- Quality will be different from the normal still picture.

Highlight&Time frame index



VIDEO

An image of one scene is displayed as a thumbnail at set search condition. Scene can be played back from any midway point of the scene you wish to see.

- Operate the zoom lever or the zoom buttons to  side and change over the thumbnail display to Highlight&Time frame index. (→ 42)



1 Touch .

- To display the next (previous) page:
 - Slide the thumbnail display upward (downward) while touching it.
 - Switch the Touch Menu, and then touch  (up)/  (down) on the thumbnail scroll lever.

2 Touch the desired search condition.

[3 SECONDS]/[6 SECONDS]/[12 SECONDS]/[MINUTES]/[FACE]*/[HIGHLIGHT]*

- * It is not displayed on iFrame scenes.
- When select [FACE], it will select the portion for which face recognition was performed from the scenes judged to be clearly recorded. This will then be displayed as a thumbnail.
- A portion judged to be clearly recorded will be detected and displayed in thumbnail if you select [HIGHLIGHT].

3 (When [MINUTES] is selected) Touch / to set the time.

- It can be set up to a maximum of 60 minutes.
- Touch [ENTER].

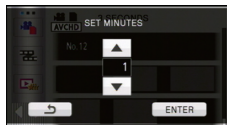

4 Touch the thumbnail to be played back.

- Next (Previous) thumbnail can be displayed by touching / .

Repeat playback

VIDEO

Playback of the first scene starts after playback of the last scene finishes.

: [VIDEO SETUP] → [REPEAT PLAY] → [ON]

The indication appears on the full screen views.

- All the scenes are played back repeatedly. (When playing back motion pictures by date, all the scenes on the selected date are played back repeatedly.)

Resuming the previous playback

VIDEO

If playback of a scene was stopped halfway, the playback can be resumed from where it was stopped.

: [VIDEO SETUP] → [RESUME PLAY] → [ON]

If playback of a motion picture is stopped, appears on the thumbnail view of the stopped scene.

- The memorized resume position is cleared if you turn off the unit or change the mode. (The setting of [RESUME PLAY] does not change.)

Zooming in on a still picture during playback (Playback zoom)

PHOTO

You can zoom in by touching a still picture during playback.

1 Touch and hold the part you wish to zoom in on during still picture playback.

- The still picture is zoomed in the following order: $\times 1 \rightarrow \times 2 \rightarrow \times 4$. Touch and hold the screen to zoom in from the normal display to $\times 2$, Touch the screen to zoom in from $\times 2$ to $\times 4$.
- The still picture is zoomed in on, centering on the part you touched.

2 Move to the zoomed in position by touching / / / or slide while touching the screen.

- The location of the zoom displays for about 1 second when zooming in (zooming out) or moving the displayed location.
- The more picture is enlarged, the more its quality deteriorates.

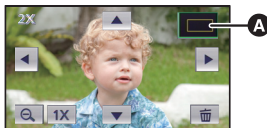

- **A** Displayed location of the zoom

Zooming out from the zoomed still picture

Touch  to zoom out. ($\times 4 \rightarrow \times 2 \rightarrow \times 1$)

• Touch  to return to normal playback ($\times 1$).

• You can also perform zoom operations using the zoom lever or the zoom buttons.

Advanced (Playback)

Various playback functions

Playing back motion pictures/still pictures by date

VIDEO **PHOTO**

The scenes or the still pictures recorded on the same day can be played back in succession.

1 Touch the date select icon. (→ 30)



2 Touch the playback date.

The scenes or the still pictures recorded on the date selected are displayed as thumbnails.



3 Touch the scene or the still picture to be played back.

A Date select icon

- Playing back of all the scenes or the still pictures returns if the unit is turned off or the mode is changed.
- Even if AVCHD scenes are recorded on the same day, they are grouped separately in the following cases. -1, -2... is added after the recording date displayed on the screen.
 - When the number of scenes exceeds 99
 - When the Interval recording is used
- Even if AVCHD scenes or 1080/60p scenes are recorded on the same day, they are grouped separately when switching between AVCHD and 1080/60p recordings. -1, -2... is added after the recording date displayed on the screen.
- Even if iFrame scenes are recorded on the same day, they are grouped separately in the following cases.
 - When the number of scenes exceeds 99
 - When [NUMBER RESET] is performed
- Even if still pictures are recorded on the same day, they are grouped separately in the following cases.
 - When the number of still pictures exceeds 999
 - When pictures are recorded in Hi-Speed Burst Shooting mode ( is indicated after the date in the list by date)
 - When [NUMBER RESET] is performed
-  is displayed after the date in the list by date for the still pictures created from the motion picture. (→ 90)

Highlight Playback

VIDEO

Part that was recognized as clearly recorded is extracted from a long recording, and it can be played back in a short time with effects and music added.

- **Highlight playback cannot be used for iFrame scenes.**

1 Touch  . (→ 30)

2 (Only when you would like to change the settings)
Touch **[SET]** to select the item to change.



[SCENE SETUP]:	Select the scene or date to be played back.
[PRIORITY SETUP]:	Select the target to give priority to playback. (→ 94)
[PLAYBACK TIME]:	Select the time to play back. (→ 94)
[EFFECT SETUP]:	Select the effect for playback. (→ 94)
[MUSIC SELECT]:	Select the music to be played on playback. (→ 94)

3 Touch **[START]**.

- When the [SCENE SETUP] is not changed in step 2, it will playback with the last recorded date.

4 Select the playback operation. (→ 41, 89)

- When the playback is finished or stopped, the screen to select [REPLAY], [SELECT AGAIN] or [EXIT] is displayed. Touch the desired item.

- Playing back of all the scenes returns if the unit is turned off or the mode is changed.
- Slow-motion playback, frame-by-frame playback, and direct playback bar operation are not possible.
- Highlight playback cannot be performed with interval-recorded motion pictures. (→ 68)

■ Scene setting

1 Touch **[SELECT SCENES]** or **[SELECT DATE]**.

2 (When [SELECT SCENES] is selected)

Touch the scenes to be played back.

- Up to 99 scenes can be selected in succession.
- When touched, the scene is selected and  is displayed. Touch the scene again to cancel the operation.

(When [SELECT DATE] is selected)

Touch the date to be played back.

- A maximum of 7 days can be selected.
- When touched, the date is selected and surrounded by red. Touch the date again to cancel the operation.

3 Touch **[Enter]/[ENTER]**.

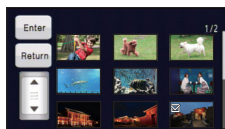

■ Priority setting

1 Touch [FACE] or [FACE RECOG.].

- If you touch [FACE], any detected face, including the face of person registered for Face Recognition, is given priority on playback.

2 (When [FACE RECOG.] is selected)

Touch a face to specify.

- You can specify up to 6 faces, which are to be played back in priority.
- When touched, the registered face is selected and surrounded by red. Touch the registered face again to cancel the operation.
- Touch [ENTER]. When a single face is specified, the name registered for that face is displayed. When multiple faces are specified, the number of faces is displayed.

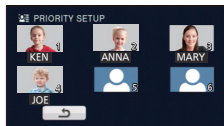

■ Playback time setting

Touch the playback time.

- The playback time of [AUTO] is a maximum of approx. 5 minutes.
- Playback time may become shorter than the setting, or it may not even play back if the part recognized as clearly recorded is short.

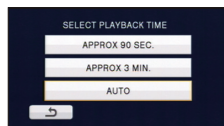

■ Effect setting

Effects such as fade, slow-motion, still (pause), or digest playback are inserted.

1 Touch the desired effect.

[POP]: Recommended for enjoyable situations such as party scene.

[CLASSICAL]: Recommended for slow moving scene.

[NATURAL]: Recommended for scenery.

[DYNAMIC]: Recommended for fast moving scene such as sports scene.

[NONE]: Effect is off.

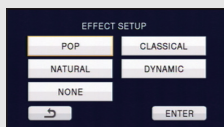

- When the effect setting is changed, music setting will be set the same as the effect setting. (To set the effect setting and music setting to different settings, change the music setting after setting the effect setting.)

2 Touch [ENTER].

■ Music setting

1 Touch your favorite music.

- When [EFFECT SETUP] is set to [NONE], you will be able to select [NO MUSIC]. When [NO MUSIC] is selected, the audio recorded at the time of shooting is played back.
- To adjust the volume of music during playback or audio testing, operate the volume lever or the zoom buttons. (→ 43)

2 Touch [ENTER].

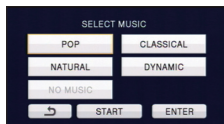

To test the music audio

Touch [START].

- Touch the other music option to change the music to be tested.
- When you touch [STOP], the music playback stops.

Changing the playback settings and playing back the slide show

PHOTO

1 Touch  . (→ 30)

2 (Only when you would like to change the settings)

Touch **[SET]** to select the item to change.



[DATE SETUP]: Select the date to be played back.

[EFFECT SETUP]: Select the effect for playback. (→ 94)

[SLIDE INTERVAL]: Selects the interval between still pictures at playback.

[MUSIC SELECT]: Select the music to be played on playback.

3 (When **[DATE SETUP]** is selected)

Touch the **playback date**.

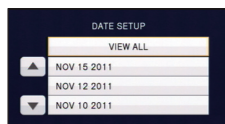

(When **[EFFECT SETUP]** is selected)

Touch the **desired effect**.

- When the effect setting is changed, music setting will be set the same as the effect setting. (To set the effect setting and music setting to different settings, change the music setting after setting the effect setting.)
- When **[EFFECT SETUP]** is set, **[SLIDE INTERVAL]** cannot be set.

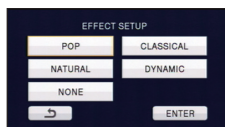

(When **[SLIDE INTERVAL]** is selected)

Touch the **interval of playback for the slide show**.

[SHORT]: Approx. 1 second

[NORMAL]: Approx. 5 seconds

[LONG]: Approx. 15 seconds

(When **[MUSIC SELECT]** is selected)

Touch the **desired sound**.

- To adjust the volume of music during playback of the slide show or audio testing, operate the volume lever or the zoom buttons. (→ 43)
- Touch **[ENTER]**.

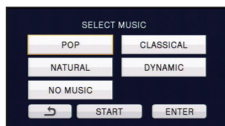

(To test the music audio)

Touch **[START]** and start the audio testing.

- Touch the other music option to change the music to be tested.
- When you touch **[STOP]**, the music playback stops.

4 Touch **[START]**.

5 Select the playback operation. (→ 41)

- When the playback is finished or stopped, the screen to select [REPLAY], [SELECT AGAIN] or [EXIT] is displayed. Touch the desired item.

Advanced (Playback)

Deleting scenes/still pictures

VIDEO PHOTO

Deleted scenes/still pictures cannot be restored, so perform appropriate confirmation of the contents before proceeding with deletion.

◇ Change the mode to  .

■ To delete the scene or still picture being played back

Touch  while scenes or still pictures to be deleted are being played back.

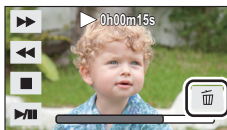

■ To delete scenes or still pictures from the thumbnail display

- Switch the thumbnail display of the scenes or still pictures to delete. (→ 41)

1 Touch  . (→ 30)

- When the thumbnail display is 1 scene display or Highlight&Time frame index, the scene or still picture being displayed is deleted.

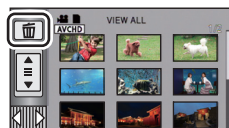

2 Touch [ALL SCENES], [MULTI] or [SINGLE].

- All the scenes or still pictures displayed as thumbnails will be deleted by selecting [ALL SCENES].

(In case of playing back scenes or still pictures by date, all the scenes or still pictures on the selected date will be deleted.)

- Protected scenes/still pictures cannot be deleted.

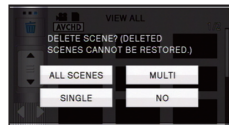

3 (When [MULTI] is selected in step 2)

Touch the scene/still picture to be deleted.

- When touched, the scene/still picture is selected and the  indication appears on the thumbnail. Touch the scene/still picture again to cancel the operation.
- Up to 99 scenes can be selected to be deleted.

(When [SINGLE] is selected in step 2)

Touch the scene/still picture to be deleted.

- Touched scene or still picture is deleted.

4 (When [MULTI] is selected in step 2)

Touch [Delete].

- To continuously delete other scenes/still pictures, repeat steps 3-4.

When you stop deleting halfway

Touch [CANCEL] while deleting.

- The scenes or still pictures that have already been deleted when the deletion is canceled cannot be restored.

To complete editing

Touch [Return].

- You can also delete scenes by touching [MENU], selecting [EDIT SCENE] → [DELETE] → [ALL SCENES], [MULTI] or [SINGLE].
- You can also delete still pictures by touching [MENU], selecting [PICT. SETUP] → [DELETE] → [ALL SCENES], [MULTI] or [SINGLE].
- During Highlight Playback or Disc Playback when connected to a DVD burner (optional), scenes/still pictures cannot be deleted.
- Scenes that cannot be played back (the thumbnails are displayed as ) cannot be deleted.
- In case of [ALL SCENES], the deletion may take time if there are many scenes or still pictures.
- If you delete scenes recorded on other products or still pictures conforming to DCF standard with this unit, all the data related to the scenes/still pictures may be deleted.
- When still pictures recorded on an SD card by other products are deleted, a still picture (other than JPEG) that cannot be played back on this unit, may be erased.

Dividing a scene (AVCHD, 1080/60p)

VIDEO

It is possible to divide an AVCHD or 1080/60p scene.

Any unwanted parts in the scene can be deleted after dividing.

- Change the mode to  and touch the play mode select icon. Then set [VIDEO/PICTURE] to [1080/60p] or [AVCHD]. (→ 41)

1 Select the menu.

 : [EDIT SCENE] → [DIVIDE] → [SET]

2 Touch the scene to be divided.

3 Touch to set the dividing point.

- Using Slow-Motion Playback or Frame-by-Frame Playback makes it easy to search for the point where you want to divide the scene. (→ 89)
- Touch [YES] to continue dividing the same scene. To continue dividing other scenes, touch [NO] and repeat steps 2-3.



4 Touch [Return] to complete dividing.

- Unwanted parts can be deleted. (→ 96)

To delete all the divided points

MENU : [EDIT SCENE] → [DIVIDE] → [CANCEL ALL]

- The scenes that were deleted after division cannot be recovered.
- You cannot divide a scene if you are playing back a disc with a DVD burner (optional) connected, or if the number of scenes of a given date would exceed 99 scenes.
- It may not be possible to divide scenes with a short recording time.
- Data that has been recorded or edited on another device cannot be divided and the divided points cannot be deleted.
- If personal information in the divided scenes is deleted, the personal information is deleted when the divided scenes are canceled.

Dividing a scene to partially delete (iFrame)

VIDEO

Divide the iFrame scene, and delete unnecessary parts.

This divides the recorded scenes in two and deletes the front half or back half.

The scenes that were deleted after division cannot be recovered.

- Change the mode to  and touch the play mode select icon. Then set [VIDEO/PICTURE] to [iFrame]. (→ 41)

1 Select the menu.

MENU : [EDIT SCENE] → [SPLIT&DELETE]

2 Touch the scene to be divided.

3 Touch to set the dividing point.

- Using Slow-Motion Playback or Frame-by-Frame Playback makes it easy to search for the point where you want to divide the scene. (→ 89)
- Set to at least 2 seconds for the portions to be deleted and least 3 seconds for the portion that is to remain.

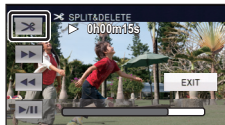

4 Touch the part for deletion.

5 Touch [YES] and confirm (play back) the part for deletion.

- When [NO] is touched, a confirmation message appears. Proceed to step 7.

6 Stop the playback.

- A confirmation message appears.

7 Touch [YES].

- To continue dividing and deleting other scenes, repeat steps 2-7.

To complete editing

Touch [Return].

- It may not be possible to divide scenes with a short recording time.
- The actual division may slightly slip off the previously designated dividing point.

Deleting personal information

VIDEO





Deletes face recognition information from scenes in which faces were recognized.

- Change the mode to  and touch the play mode select icon. Then set [VIDEO/PICTURE] to [1080/60p] or [AVCHD]. (→ 41)
- Personal information is not recorded in the iFrame scenes.

1 Select the menu.

 : [VIDEO SETUP] → [DELETE PERSONAL INFO]

2 Touch the desired scenes with personal information to be deleted.

-  appears at scenes for which faces were recognized. Touch one of the scenes where  appears.
-  will change to  (red) when touched. Touch the  (red) again to cancel the operation.
- Up to 99 scenes can be selected in succession.

3 Touch [Delete].

- To continuously delete other personal information, repeat steps 2-3.
- Touch [Return] to complete the settings.

When you stop deleting halfway

Touch [CANCEL] while deleting personal information.

- The personal information that has already been deleted when the deletion is canceled cannot be restored.

- During Disc Playback when connected to a DVD burner (optional), scenes/still pictures cannot be deleted.

Protecting scenes/still pictures

VIDEO PHOTO

Scenes/still pictures can be protected so that they are not deleted by mistake.

(Even if you protect some scenes/still pictures, formatting the media will delete them.)

- Change the mode to  .

1 Select the menu.

 : [VIDEO SETUP] or [PICT. SETUP] → [SCENE PROTECT]

2 Touch the scene/still picture to be protected.

- When touched, the scene/still picture is selected and the  indication appears on the thumbnail. Touch the scene/still picture again to cancel the operation.
- Touch [Return] to complete the settings.

- When the Disc Playback is selected while a DVD burner (optional) is connected, scenes/still pictures cannot be protected.

DPOF setting

PHOTO

You can write the data selecting still pictures to be printed and the number of prints (DPOF data) onto the SD card. (Copy still pictures recorded to the built-in memory or HDD to the SD card before setting DPOF.)

◇ **Change the mode to  and touch the play mode select icon. Then set [MEDIA] to [SD CARD], and set [VIDEO/PICTURE] to [PICTURE]. (→ 41)**

■ What is DPOF?

DPOF (Digital Print Order Format) is a format which allows the user of a digital camera to define which captured images on the SD card are to be printed, together with information on the number of copies they wish to print. (Please note: Not all commercial printing services support this feature at this time.)

1 Select the menu.

MENU : [PICT. SETUP] → [DPOF SET] → [SET]

2 Touch the still picture to be set.

3 Touch / to set the number of prints.

- Up to 999 prints can be selected. (Prints for set number can be printed with a printer that supports DPOF.)
- To cancel the setting, set the number of prints to [0].

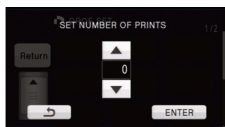

4 Touch [ENTER].

- To continuously set other still pictures, repeat steps 2-4.
- Touch [Return] to complete the settings.

To cancel all DPOF settings

MENU : [PICT. SETUP] → [DPOF SET] → [CANCEL ALL]

- When the disc playback is selected while a DVD burner (optional) is connected, scenes/still pictures cannot be set DPOF.
- You cannot add the recording date to pictures to be printed with the DPOF settings.

Relay scene combining [HDC-TM900]

VIDEO

You can combine the relayed scene (→ 69) in the built-in memory and the continued scene in the SD card to be one into the SD card.

Relay-recorded scene

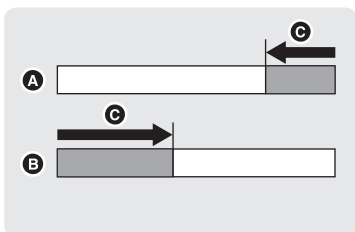

Relay scene combining

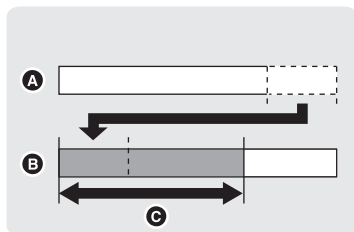

- A** Built-in memory
- B** SD card
- C** Range of Relay recording

- Change the mode to and touch the play mode select icon. Then set [MEDIA] to [SD CARD] or [Built-inMemory], and set [VIDEO/PICTURE] to [1080/60p] or [AVCHD]. (→ 41)

1 Insert the SD card that was used for Relay recording.

2 Select the menu.

MENU : [EDIT SCENE] → [RELAY SCENE COMBINE]

3 When the confirmation message appears, touch [YES].

- Scene in the built-in memory will be deleted. (Protected scenes in the built-in memory are not deleted.)

4 Touch [EXIT] when the relay scene combining complete message is displayed.

- The thumbnail view of the SD card is indicated.
- Relay recording information will be deleted when the relay scenes are combined, and Relay recording will be possible again.
- When the relayed scenes in the built-in memory or SD card are deleted, combining of the relayed scenes will not be possible.

To cancel relay information

MENU : [EDIT SCENE] → [RELAY INFO CANCEL]

- When the relay information is canceled, combining of the relayed scenes will not be possible anymore.

Combining of the relay scene cannot be performed if the available space on the SD card is less than the volume of the relayed scene in the built-in memory. It is recommended to combine the relay scene using a DVD burner or the HD Writer AE 3.0.

- When the disc playback is selected while a DVD burner (optional) is connected, you cannot combine relay scenes or cancel relay information.
- The personal information of the relayed scene in the built-in memory or SD card is deleted, the personal information of the combined relay scene is deleted.

Watching Video/Pictures on your TV

VIDEO PHOTO

Confirm the terminals on your TV and use a cable compatible with the terminals. Image quality may vary with the connected terminals.

- A** High quality
- 1** HDMI terminal
- 2** Component terminal
- terminal
- 3** Video terminal

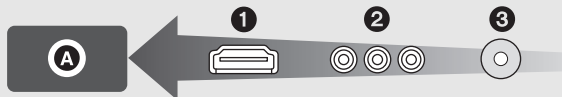

- Use the AV multi cable (supplied) or HDMI mini cable (optional) and check the output settings. (→ 106)
- HDMI is the interface for digital devices. If you connect this unit to a HDMI compatible high definition TV and then play back the recorded high definition images, you can enjoy them in high resolution with high quality sound.

1 Connect this unit to a TV.

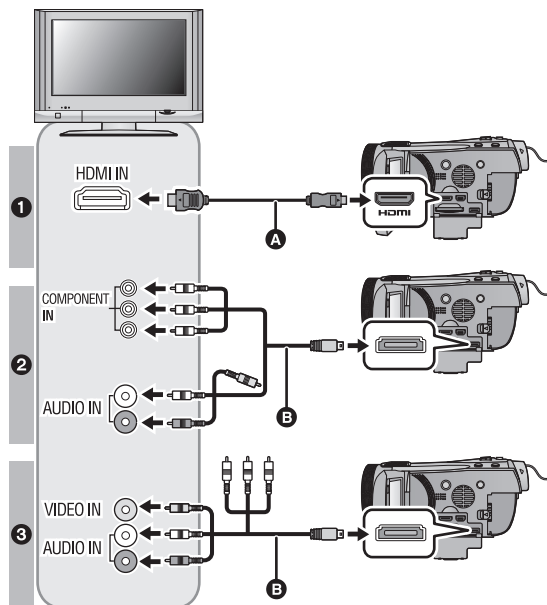

- A** HDMI mini cable (optional)
- Be sure to connect to the HDMI terminal.
- B** AV multi cable (supplied)

Picture quality

- 1** High definition images when connecting to HDMI terminal
- 2** High definition images when connecting to component terminal compatible with 1080i Standard images when connecting to component terminal compatible with 480i
- 3** Standard images when connecting to video terminal

- Check that the plugs are inserted as far as they go.
- Always use a genuine Panasonic HDMI mini cable (RP-CDHM15, RP-CDHM30; optional).
- Do not use any other AV multi cables except the supplied one.
- When connecting to the component terminal of the TV, the yellow plug of the AV multi cable is not required.
- When connecting to the AV terminal of the TV, do not connect the component terminal plug of the AV multi cable. Image may not display when the component terminal plug is connected simultaneously.

2 Select the video input on the TV.

- Example:
Select the [HDMI] channel with a HDMI mini cable.
Select the [Component] or [Video 2] channel with an AV multi cable.
(The name of the channel may differ depending on the connected TV.)
- Check the input setting (input switch) and the audio input setting on the TV. (For more information, please read the operating instructions for the TV.)

3 Change the mode to to play back.

Cables	Reference items
A HDMI mini cable (optional)	<ul style="list-style-type: none"> • Connecting with a HDMI mini cable (→ 106) • Listening in 5.1 channel sound (AVCHD, 1080/60p) (→ 106) • Playback using VIERA Link™ (→ 107)
B AV multi cable (supplied)	<ul style="list-style-type: none"> • Connecting with the AV multi cable (→ 106)



- When the AV multi cable is connected to this unit, the setup screen of the AV multi destination is displayed on the screen of this unit. Touch either [COMPONENT] or [AV OUT] in accordance with the terminal connecting to the TV. (→ 106)
- If the HDMI mini cable and AV multi cable are connected at the same time, output will be prioritized in order of the HDMI mini cable, AV multi cable.

■ **To watch images on a regular TV (4:3) or when both sides of the images do not appear on the screen**

Change the menu setting to display the images correctly. (Check the TV setting.)

MENU : [SETUP] → [TV ASPECT] → [4:3]

Example of images with a [16:9] aspect ratio on a regular TV (4:3)

[TV ASPECT] setting	
[16:9]	[4:3]
	

- If a wide-screen TV is connected, adjust the aspect setting on the TV. (Refer to the operating instructions of the TV for details.)

■ **To display the on-screen information on the TV**

When the EXT DISPLAY button on the remote control is pressed, the information displayed on the screen (operation icon and time code etc.) can be displayed/not displayed on the TV.

- It will not display when the unit is turned off.



Refer to the following support site for information about Panasonic TVs with an SD card slot for playing back your pictures.

<http://panasonic.net/>

- It may not be possible to play back scenes on the TV depending on the recording mode.
- For details on how to play back, please read the operating instructions for the TV.

Connecting with a HDMI mini cable

Select the desired method of HDMI output.

MENU : [SETUP] → [HDMI RESOLUTION] → [AUTO]/[1080p]/[1080i]/[480p]

- [AUTO] determines the output resolution automatically based on information from the connected TV.
If the images are not output on the TV when the setting is [AUTO], switch to the method [1080p], [1080i] or [480p] which enables the images to be displayed on your TV. (Please read the operating instructions for the TV.)
- Image will not display on TV for a few seconds in the following cases.
 - When the 1080/60p recording mode is turned on/off during Motion Picture Recording Mode
 - When you touch the play mode select icon to select [1080/60p], and then touch [ENTER] during Playback Mode.

Listening in 5.1 channel sound (AVCHD, 1080/60p)

You still can listen to the 5.1 channel sound recorded from the internal microphones when this unit is connected to the 5.1 channel compatible AV amplifier or TV using the HDMI mini cable.

Please read the AV amplifier and TV operating instructions for how to connect this unit to the AV amplifier and TV.

- If you connect this unit to a Panasonic AV amplifier that are compatible with VIERA Link, linked operations (VIERA Link) become possible. (→ 107)
- Audio recorded when [MIC SETUP] is set to [STEREO MIC] or recorded from an external microphone is in stereo (2 ch).

Connecting with the AV multi cable

AV multi connector output setting can be changed.

MENU : [SETUP] → [AV MULTI] → desired setting

[COMPONENT]: When connecting to the component terminal

[AV OUT]: When connecting to the video terminal

Changing the component output setting

MENU : [SETUP] → [COMPONENT OUT] → desired setting

[480i]: When connecting to the component terminal on the TV compatible with 480i. (Playback is in standard quality.)

[1080i]: When connecting to the component terminal on the TV compatible with 1080i. (Playback is in high definition quality.)

Playback using VIERA Link™

VIDEO PHOTO

What is the VIERA Link (HDAVI Control™)?

- VIERA Link™ is a new name for EZ Sync™.
- This function allows you to use your remote control for the Panasonic TV for easy operations when this unit has been connected to a VIERA Link compatible device using a HDMI mini cable (optional) for automatic linked operations. (Not all operations are possible.)
- VIERA Link is a unique Panasonic function built on a HDMI control function using the standard HDMI CEC (Consumer Electronics Control) specification. Linked operations with HDMI CEC compatible devices made by other companies are not guaranteed. When using devices made by other companies that are compatible with VIERA Link, refer to the operating instructions for the respective devices.
- This unit is compatible with VIERA Link Ver.5. VIERA Link Ver.5 is the newest Panasonic version and is also compatible with existing Panasonic VIERA Link devices. (As of Dec 2010)

◇ Change the mode to  .

1 Select the menu.

 : [SETUP] → [VIERA Link] → [ON]

- If you are not using VIERA Link, set to [OFF].

2 Connect this unit to a Panasonic TV compatible with VIERA Link with a HDMI mini cable.

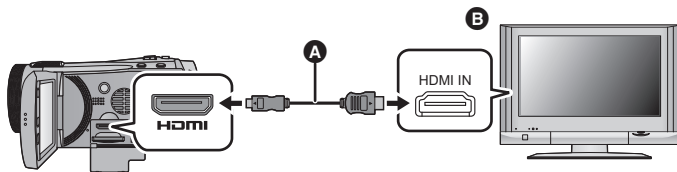

- A** HDMI mini cable (optional)
- B** Panasonic TV compatible with VIERA Link
- It is recommended to connect this unit to an HDMI terminal other than the HDMI1 if there are 2 or more HDMI input terminals on the TV.
- VIERA Link must be activated on the connected TV. (Read the operating instructions of the TV for how to set etc.)
- Always use a genuine Panasonic HDMI mini cable (RP-CDHM15, RP-CDHM30; optional).

3 Operate with the remote control for the TV.

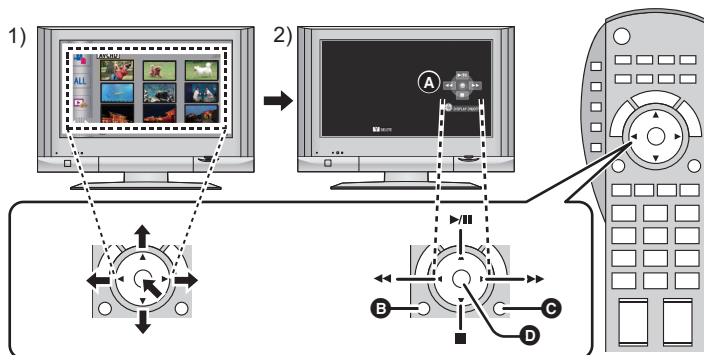

- 1) Press the button up, down, left or right to select a scene or still picture to be played back, and then press the button in the center to set it.
- 2) Activate the operation icons that are displayed on TV screen with the remote control for the TV.

A Operation icons

B Display operation icons

C Cancel operation icons

D Display/Cancel operation icons

- The following operations are available by pressing the color buttons on the remote control.
 - Green: Switching the number of scenes/still pictures in thumbnail display (9 thumbnails → 20 thumbnails → 9 thumbnails...)
 - Yellow: Zoom in on still picture
 - Yellow: Deleting scenes/still pictures
 - Red: Zoom out from still picture

■ Other linked operations

Turning the unit off:

If you use the remote control for the TV to turn off the power, this unit also turns off.

Automatic input switching:

If you connect with a HDMI mini cable and then turn on this unit, the input channel on the TV automatically switches to this unit's screen. If the TV's power is in standby status, it will turn on automatically (if [Set] has been selected for the TV's [Power on link] setting).

- Depending on the HDMI terminal on the TV, the input channel may not switch automatically. In this case, use the remote control for the TV to switch the input channel.

-
- If you are unsure whether or not the TV and AV amplifier you are using are compatible with VIERA Link, read the operating instructions for the devices.
 - Available linked operations between this unit and a Panasonic TV is different depending on the types of Panasonic TVs even if they are compatible with VIERA Link. Refer to the operating instructions of the TV for the operations that support on the TV.
 - Operation is not possible with a cable that is not based on the HDMI standard.

3D video playback

VIDEO

Connect the unit to a 3D compatible television and play back scenes recorded in 3D to enjoy life-like and powerful 3D video.

- ◇ **Change the mode to  and touch the play mode select icon. Then set [VIDEO/PICTURE] to [AVCHD]. (→ 41)**

1 Select the menu.

 : [SETUP] → [3D PLAYBACK] → [3D]

[3D]: Play back scenes recorded in 3D in unaltered form as 3D video.

[2D]: If your television does not support 3D, set to [2D] to play back scenes recorded in 3D.

2 Connect the unit to 3D compatible television and play back scenes recorded in 3D. (→ 103)

- Connect the unit to the 3D compatible television using the HDMI mini cable (optional).
- For the scenes recorded in 3D,  will appear on the thumbnail display at playback.
- Playback switches between 3D video and 2D video automatically.
- If your television does not switch to a 3D video, make the necessary settings on the TV. (For further details, please read the operating instructions for the TV.)
- A gray frame will be displayed around the image when playing back 3D video recorded by this unit.

■ Playing back scenes recorded in 3D as (conventional) 2D video

 : [SETUP] → [3D PLAYBACK] → [2D]

- Set to [2D] when using a television that is not 3D compatible.
- If you feel tired, uncomfortable or otherwise strange when viewing scenes recorded in 3D, set to [2D].

-
- You cannot play back 3D video on the LCD monitor of the unit. When you play back scenes recorded in 3D on the LCD monitor, they will be played back in 2D.
 - You can also play back scenes recorded in 3D by date. Even if scenes are recorded on the same day, the unit will display the date separately when switching between 2D and 3D recordings. (→ 92)
 - When you play back scenes successively, a black screen will appear for a few seconds between scenes recorded in 3D and scenes recorded in 2D.
 - In the 1 scene or Highlight&Time frame index thumbnail display, a gray frame appears around the thumbnails. For the 9 scenes or 20 scenes thumbnail display, gray frames may appear when a divide or repair is performed. (The unit automatically performs scene repair if faulty management information is detected.)
 - When you select a 3D video thumbnail, it may take a few seconds for playback to start. After playback, the thumbnail display may take a few seconds to reappear.
 - If you set [3D PLAYBACK] to [3D] with the unit connected to a television that does not support 3D, the video will be played back in 2 screens.
 - Depending on the 3D-compatible television used, switching to 3D mode may be slow and you may not be able to watch the first scene. In this case, use the pause button.
 - When viewing 3D video, your eyes may become tired if you are too close to the television screen. Use the supplied remote control to operate from a distance.

Functions not available during 3D playback

- Creating still picture from motion picture
- Highlight&Time frame index ([FACE], [HIGHLIGHT])
- Yellow button display and deletion function during VIERA Link (During playback only)
- Highlight playback

Copying between SD card and Built-in Memory/HDD

VIDEO PHOTO

Motion pictures or still pictures recorded with this unit can be copied between an SD card inserted in this unit and a built-in memory/HDD.

■ Check the used space of the copy destination

It is possible to check the used space of the SD card, built-in memory, or HDD by [MEDIA STATUS] (→ 51).

- By displaying in 1 scene or pressing and holding the thumbnail in the 20 scenes or 9 scenes display, recording date and time are displayed when playing back motion pictures, and recording date and file number when playing back still pictures.
- Depending on the media condition, some remaining capacity of the SD card, built-in memory or HDD may not be used.
- If the remaining capacity on a single SD card is not enough, you can copy to multiple SD cards following the instruction on the screen. In this case, the last scene copied to an SD card is automatically divided to fit the space on the SD card.
- If you divide the scenes (→ 97), and copy by scene selection, it is possible to copy matching the remaining capacity of the media, or only the necessary parts.

Copying

- If there is little or no remaining capacity in the SD card, a confirmation message asking to copy after deleting all data on the SD card is displayed. Be aware that deleted data cannot be restored.
- Refer to page 112 for approximate time for copying.

1 Change the mode to .

- Use a sufficiently charged battery or the AC adaptor.

2 Select the menu.

 : [COPY]

HDC-TM900

 When copying from the built-in memory to the SD card

 When copying from the SD card to the built-in memory

 This will convert and copy the scenes recorded as 1080/60p scenes in the built-in memory to the SD card as normal scenes.

- When there are relay recorded scenes in the built-in memory, a message appears on the screen. Touch [YES] and copy after combining relay recorded scenes to the SD card. (→ 101)



HDC-HS900

 When copying from the HDD to the SD card

 When copying from the SD card to the HDD

 This will convert and copy the scenes recorded as 1080/60p scenes in the HDD to the SD card as normal scenes.

3 Touch desired items following the screen display.

- It will return to the previous step by touching .
- (When [SELECT SCENES] is selected)
When touched, the scene/still picture is selected and the  indication appears on the thumbnail. Touch the scene/still picture again to cancel the operation.
- (When [SELECT DATE] is selected)
When touched, the date is selected and surrounded by red. Touch the date again to cancel the operation.
- Up to 99 scenes/still pictures or 99 dates can be set in succession.
- If 2 or more SD cards are necessary to copy, change the card following the instructions on the screen.

4 Touch [EXIT] when the copy complete message is displayed.

- The thumbnail view of the copy destination is indicated.

When you stop copying halfway

Touch [CANCEL] while copying.

Approximate time for copying

When copying a recorded motion picture of full 4 GB size:

5 minutes to 15 minutes

When performing [] → [] / [] → [] on a recorded 1080/60p motion picture of full 4 GB size:

30 minutes to 45 minutes

To copy approx. 600 MB still pictures (Picture size ):

3 minutes to 5 minutes

If you will delete the motion pictures or still pictures after copying is complete, be sure to play back the motion pictures or still pictures to check that they have been copied to correctly before deleting.

- When the disc playback is selected while a DVD burner (optional) is connected, menus are not displayed.
- Depending on the following conditions, the time it takes for copying may be longer.
 - The number of recorded scenes is large.
 - The temperature of the unit is high.
- If some motion pictures or still pictures have already been recorded to the copy destination, then the same date may be assigned or images may not display by date when the list by date is selected.
- Motion pictures that have been recorded on another device may not be copied. Data recorded on a PC with HD Writer AE 3.0, etc. cannot be copied.
- Protection and DPOF settings will be cleared on the copied motion pictures and still pictures when copying motion pictures and still pictures with protection and DPOF settings.
- The order in which the scenes or still pictures were copied cannot be changed.

Connecting a DVD burner to copy to/ play back a disc

VIDEO PHOTO







Motion pictures or still pictures recorded with this unit can be copied to a DVD disc by connecting a DVD burner (optional) to this unit using a USB Connection Cable (supplied with DVD burner). The copied DVD disc can also be played back.

- Please read the operating instructions of the DVD burner for how to use it.
- 1080/60p scenes can be copied after converting to AVCHD picture quality or conventional normal picture quality.
- iFrame scenes cannot be copied to disc. Copy to PC to make a backup. (→ 125)

Preparing for copying/playing back

We recommend using Panasonic DVD burner VW-BN01.

■ About discs that can be used for copying

Disc type	DVD-RAM 	DVD-RW  / +RW 	DVD-R  / DVD-R DL  / +R  / +R DL 
Copy* ¹	○	○	○
Additional copy* ²	○	—	—
Format* ³	○	○	—

*¹ Use a new disc. You can additionally copy only to a DVD-RAM. When you copy to DVD-RW, DVD-R, DVD-R DL, +RW, +R or +R DL, the disc is automatically finalized to allow playback on other devices and additional copying will not be possible.

*² Only DVD-RAM copied with the DVD burner or HD Writer AE 3.0 can additionally copy.

*³ Connect this unit and a DVD burner before formatting. If you format a used disc, you can copy on that disc. Please be aware that if a disc is formatted, then all the data recorded on the disc will be erased. (→ 118)

- We recommend using the discs that have been recommended in the operating instructions of the DVD burner. Refer to the operating instructions of the DVD burner for details about recommended discs, disc handling etc.

1 Connect the AC adaptor (supplied with DVD burner) to the DVD burner.

- You cannot supply power to the DVD burner from this unit.

2 Connect this unit to the AC adaptor and change the mode to .

3 Connect this unit to the DVD burner with the USB Connection Cable (supplied with DVD burner).

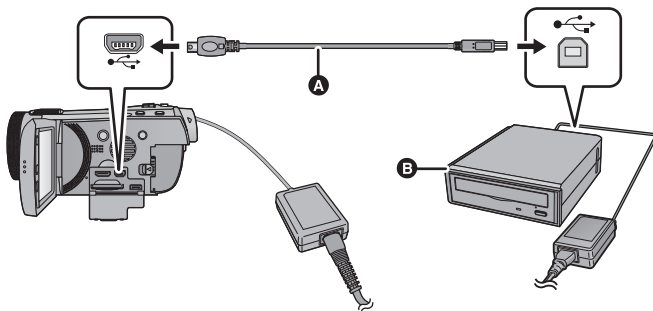

- A** USB Connection Cable (supplied with DVD burner)

- B** DVD burner (optional)

- Insert the plugs as far as they will go.

4 Insert the disc in the DVD burner.

- Insert the DVD disc with the recording side down when using the DVD burner.

5 Touch the desired item.

[BURN DISC]:

Refer to page 115 for how to copy discs.

[PLAY DISC]:

Refer to page 117 for how to play back the copied discs.

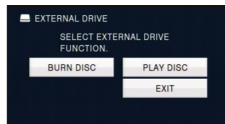

To terminate the connection with the DVD burner

Touch [EXIT].

- Disconnect the USB Connection Cable from this unit.



Copying to discs

- You cannot copy from multiple SD cards to 1 disc. (You can additionally copy only to a DVD-RAM.)
- You cannot copy motion pictures together with still pictures or motion pictures in a different picture quality (AVCHD picture quality and conventional normal picture quality) to the same disc.
- iFrame scenes cannot be copied to disc. Copy to PC to make a backup. (→ 125)
- **[HDC-TM900]**
When copying a scene in the built-in memory to a disc that includes a scene that was relay-recorded, the continued scene that is on the SD card will be copied together to the disc.

1 Connect this unit to the DVD burner to prepare for copying. (→ 113)

2 Touch [BURN DISC].

3 Touch the desired items following the instructions on the screen.

- It will return to the previous step by touching .
- (When [SELECT SCENES] is selected)
When touched, the scene/still picture is selected and the  indication appears on the thumbnail. Touch the scene/still picture again to cancel the operation.
- (When [SELECT DATE] is selected)
When touched, the date is selected and surrounded by red. Touch the date again to cancel the operation.
- Up to 99 scenes/99 dates can be selected in succession.

4 Touch [START].

- When 2 or more discs are necessary for copying, follow the on-screen instructions to switch discs.
- You may need more discs than displayed number of discs when you are copying additionally to a used DVD-RAM.
- Eject the disc after copying is completed.
- When the copied disc is played back on another device and the list of scenes is displayed, they are ordered by date.

■ About recording formats when copying motion pictures

[AVCHD] ([HA]/[HG]/[HX]/[HE]):

Copying scenes of 1080/60p picture quality

The scenes recorded in 1080/60p by this unit will be copied after converting to AVCHD picture quality.

When copying scenes recorded in 1080/60p, select the recording picture quality ([HA]/[HG]/[HX]/[HE]).

Copying scenes of AVCHD picture quality

The scenes recorded in AVCHD format will be copied as high definition picture quality as recorded.

[Standard] ([XP]/[SP]):

Copying scenes of 1080/60p or AVCHD picture quality

Images are converted into the original standard picture quality and then copied.

- Since [XP] has a higher picture quality compared to [SP], the data capacity becomes large so that you may need more discs for copying than [SP].

Before you delete the data on the media after copying is complete, be sure to play back the discs to check that they have been copied to correctly. (→ 117)

Important Notice

- When connecting an optional DVD burner and this unit for copying a disc, do not insert a disc with recorded motion pictures in high definition picture quality into devices that do not support the AVCHD format. In some cases the disc may get stuck in the device. The disc will not play back on devices that do not support the AVCHD format.
- When inserting a disc containing recorded motion/still pictures into other devices, a message prompting you to format the disc may be displayed. Do not format the disc, since deleted data cannot be restored later.

Approximate time for copying to a disc

To copy motion pictures to the full capacity of a disc

Disc type	Copy time		
	[AVCHD]	[Standard] ([XP])	[Standard] ([SP])
DVD-RAM	Approx. 50 min to 1 h 20 min	Approx. 1 h 30 min to 2 h 30 min	Approx. 3 h to 5 h
DVD-RW [*] / +RW [*]	Approx. 35 min to 1 h 15 min		
DVD-R [*] /+R [*]	Approx. 15 min to 45 min		

* Even if the data capacity to be copied is small, the time it takes for copying may be about the same as the time shown in the table.

- When copying motion pictures in standard picture quality to a disc, the recordable time of [Standard] ([XP]) is approx. 1 hour and that of [Standard] ([SP]) is approx. 2 hours.

To copy approx. 600 MB still pictures (picture size $\boxed{14.2M}$)

Disc type	Copy time
DVD-RAM/DVD-RW/DVD-R/+RW/+R	Approx. 10 min to 30 min

To copy approx. 30 minutes of motion pictures recorded in 1080/60p converted to [AVCHD]/[Standard]

Disc type	Copy time
DVD-RAM/DVD-RW/DVD-R/+RW/+R	Approx. 45 min to 1 h 15 min

- Copy time of DVD-R DL/+R DL is approximately 2 to 3 times that of DVD-R/+R.
- Depending on the following conditions or discs, the time it takes for copying may be longer than the above times. Wait until the end of copying is displayed.
 - When the number of recorded scenes is large
 - When the temperature of the DVD burner has become high

-
- The disc that was copied to can be played back by connecting this unit and a DVD burner.
 - Do not turn off this unit or the DVD burner or disconnect the USB Connection Cable while copying. Also, do not shake this unit or the DVD burner.
 - It is impossible to stop copying halfway.
 - The order in which the scenes were copied cannot be changed.
 - Data that has been recorded on another device may not be copied.
 - When 2 or more discs are necessary for copying, the last scene copied to a disc is automatically divided to fit the space on the disc.
 - Copying may complete with more or less than the number of discs displayed when dividing of scenes was performed automatically etc.
 - For discs being copied using [Standard] ([XP])/[Standard] ([SP]), you cannot select Highlight Playback and [HIGHLIGHT] or [FACE] of Highlight & Time Frame Index.
 - The remaining copy time displayed while copying is the approximate time for a single disc.

Playing back the copied disc

- Only discs that have been copied by connecting this unit to the DVD burner or created with HD Writer AE 3.0 can be played back.

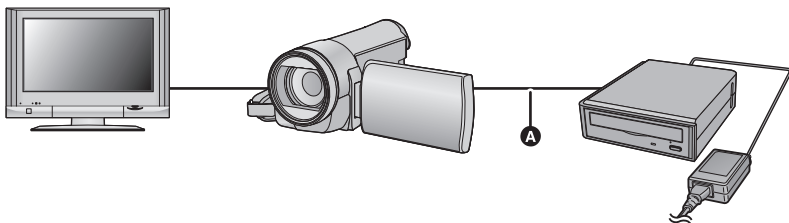

- Ⓐ USB Connection Cable (supplied with DVD burner)

1 Connect this unit to the DVD burner to prepare for playback. (→ 113)

- When playing back on a TV, connect this unit to the TV. (→ 103)

2 Touch the scene or still picture to be played back and then play it back.

- The playback operation is performed the same as when playing back motion pictures or still pictures. (→ 41, 89)
- It will return to Step 5 on page 114 when  is selected in the thumbnail screen.

-
- It is also possible to switch the media to play back by touching the play mode select icon. When the DVD burner is connected, [DISC] can be selected in [MEDIA] ([VIDEO] or [PICTURE]) can be selected in [VIDEO/PICTURE])

Managing the copied disc

- Connect this unit to the DVD burner and then touch [PLAY DISC]. (→ 114)

■ Formatting discs

This is for initializing DVD-RAM, DVD-RW and +RW discs.

Please be aware that if a disc is formatted, then all the data recorded on the disc will be erased. Back up important data on a PC etc.

MENU : [DISC SETUP] → [FORMAT DISC]

- When formatting is complete, touch [EXIT] to exit the message screen.

- Connect this unit and the DVD burner to format discs.

You may no longer be able to use the discs if you format them on another device such as a PC etc.

■ Auto protect

You can protect (write protect) a DVD-RAM disc when copying motion pictures in high definition picture quality or DVD-RW disc when copying motion pictures or still pictures in high definition picture quality to the disc.

1 Select the menu.

MENU : [DISC SETUP] → [AUTO PROTECT] → [ON]

- If a disc that you copied to is inserted in another device without protecting it, a message may be displayed prompting you to format the disc. We recommend setting [AUTO PROTECT] to [ON] in order to prevent accidental deletion.

2 Copy to the disc. (→ 115)

- After copying, the disc is write protected.

To release the disc protection

MENU : [DISC SETUP] → [CANCEL PROTECT]

- Touch [EXIT] and close the message screen after the auto protection is released.

■ Displaying disc information

Information such as the type of recorded disc, the number of recorded scenes and whether or not the disc is finalized is displayed.



MENU : [DISC SETUP] → [DISC STATUS]

- Touch [EXIT] to exit the information screen.

Dubbing with a Blu-ray disc recorder, video device, etc.

■ Check before dubbing

Check the equipment used for dubbing.

Equipment used for dubbing	Dubbing picture quality	To dub
Equipment with SD card slot	High-definition picture quality*	Insert the SD card directly (→ 120) 
Equipment with USB terminal	High-definition picture quality*	Connect with supplied USB cable (→ 120) 
Equipment without SD card slot or USB terminal	Standard picture quality This can be played back on equipment not compatible with high-definition (AVCHD), so is convenient if you are dubbing for distribution.	Connect with supplied AV multi cable (→ 122) 

* Some equipment may not be compatible with high-definition (AVCHD) picture quality. In such a case, connect with the AV multi cable and dub with standard picture quality. (→ 122)

- For the positions of the SD card slot, USB terminal, or terminal for connecting the AV multi cable, refer to the operating instructions of the equipment used.
- The iFrame scenes cannot be dubbed to SD cards or by connecting with the USB cable. Please refer to page 122 for detail about dubbing iFrame scenes.

Dubbing in high-definition picture quality

VIDEO PHOTO

You can dub using a Panasonic Blu-ray disc recorder or high-definition (AVCHD) compatible DVD recorder.

- Depending on the recorders or the media to be copied to, you may not be able to copy in high-definition (AVCHD) picture quality. For further details, see the operating instructions of your recorder.
- Note that the equipment described may not be available in certain countries and regions.

About dubbing of scenes recorded in 1080/60p

The scenes recorded in 1080/60p cannot be dubbed to a disc with 1080/60p picture quality. They are dubbed after being converted to AVCHD picture quality. (As of Dec. 2010)

■ To dub using equipment with an SD card slot

You can dub by directly inserting an SD card.

- To copy scenes or still pictures from the built-in memory or HDD to an SD card, see page 111.

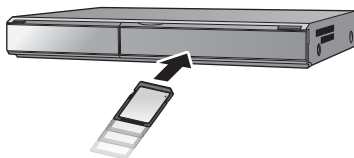

■ To dub using equipment with a USB terminal

You can dub by connecting a USB cable.

- Use the AC adaptor to free you from worrying about the battery running down.
- Turn on the unit (This function is available in all modes).

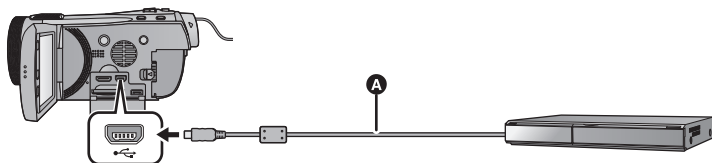

- A** USB cable (supplied)
- Insert the plugs as far as they will go.

1 Connect the unit to the Blu-ray disc recorder or high-definition (AVCHD) compatible DVD recorder.

- The USB function selection screen will appear on the screen of the unit.

2 Touch [RECORDER] on the screen of this unit.

- When you select an option other than [RECORDER], reconnect the USB cable.



3 Touch the media you wish to dub.

- When using the battery, the LCD monitor turns off after about 5 seconds. Touch the screen to turn the LCD monitor on.

4 Dubbing through operations on the Blu-ray disc recorder or high-definition (AVCHD) compatible DVD recorder.

- Do not touch [CHANGE MEDIA] on the screen of the unit during dubbing.

About the screen indication of the unit

- When the unit is accessing the SD card, card access icon () appears on the unit screen or the access lamp is on.
- **HDC-TM900**
When the unit is accessing the built-in memory, built-in memory access icon () appears on the unit screen or the access lamp is on.
- **HDC-HS900**
When the unit is accessing the HDD, HDD access icon () appears on the unit screen or the HDD access lamp is on.
- Be careful not to disconnect the USB cable, AC adaptor or battery while the unit is accessing the media, as this may result in the loss of recorded content.

-
- Do not use any other USB cables except the supplied one. (Operation is not guaranteed with any other USB cables.)
 - For details on dubbing and playback methods, read the operating instructions of the Blu-ray disc recorder or DVD recorder.
 - When you connect the unit to a Blu-ray disc recorder, a dubbing operations screen may appear on the television connected to the Blu-ray disc recorder. In this case as well, perform the operations of steps 1 to 4.
 - You cannot change the mode of the unit or turn off the unit while it is connected to a Blu-ray disc recorder or DVD recorder. Disconnect the USB cable before performing either of these operations.
 - If the battery runs down during dubbing, a message will appear. Operate the Blu-ray disc recorder to cancel the dubbing.

■ Dubbing using equipment without an SD card slot or a USB terminal, or using a video device

You can dub by connecting an AV multi cable.

- **Images are dubbed in standard quality.**
- Use the AC adaptor to free you from worrying about the battery running down.

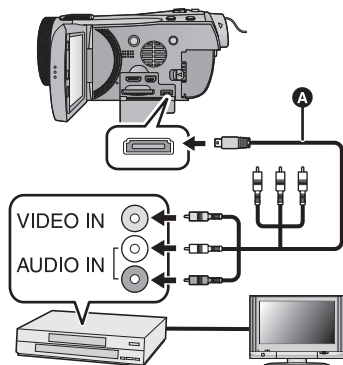

Change the video input on the video device and TV that this unit is connected to.

- The channel set will differ depending on the terminal to which the unit is connected.
 - See the operating instructions of the video device for details.
 - Insert the plugs as far as they will go.
 - Do not use any other AV multi cables except the supplied one.
- A** AV multi cable (supplied)

1 Connect this unit to a video device and then change the mode to .

2 Start playback on this unit.

3 Start recording on the connected device.

- To stop recording (dubbing), stop playback on this unit after stopping recording on the recorder.
-
- If the date and time display and function indication are not wanted, cancel them before dubbing. (→ 47, 105)

If the dubbed images are played back on a wide-screen TV, the images may be stretched vertically.

In this case, refer to the operating instruction for the device you are connecting to or read the operating instructions of the wide-screen TV and set the aspect ratio to 16:9.

3D video storage

VIDEO

You can store 3D video with a DVD burner, a video device or a PC.

Copying with a DVD burner

- Please refer to page 113 for details about copying with a DVD burner.

■ Copying unaltered as 3D video

Recording format: [AVCHD]

The scenes recorded in 3D using the unit can be copied and stored in unaltered form as 3D video. The video is recorded unaltered in side-by-side format.

■ Copying after conversion to 2D video

Recording format: [Standard] ([XP]/[SP])

Scenes recorded in 3D are converted to 2D video before being copied and stored. In this case, 3D video cannot be stored in unaltered form.

- A gray frame will appear around the thumbnail and image after a scene is converted to 2D.

Dubbing with a Blu-ray disc recorder, video device, etc.

■ Dubbing in high-definition picture quality

(Dubbing directly from inserted SD card/Dubbing with a USB cable)

- Please refer to page 119 for details about dubbing in high-definition picture quality.

When dubbing with high-definition (AVCHD) picture quality, you can store 3D video. The video is recorded unaltered in side-by-side format.

- If the dubbed video does not change to 3D video, make the necessary settings on the TV. (For further details, please read the operating instructions for the TV.)

■ Dubbing in standard picture quality

- Please refer to page 122 for details about dubbing in standard picture quality.

Copying unaltered as 3D video

When [3D PLAYBACK] is [3D], the 3D video is recorded in side-by-side format.

MENU : [SETUP] → [3D PLAYBACK] → [3D]

- If the dubbed video does not change to 3D video, make the necessary settings on the TV. (For further details, please read the operating instructions for the TV.)

Copying after conversion to 2D video

Set [3D PLAYBACK] to [2D].

MENU : [SETUP] → [3D PLAYBACK] → [2D]



Copying between SD card and built-in memory/HDD

- Please refer to page 111 for details about copying between SD card and built-in memory/HDD.

■ Copying scenes recorded in 3D



HDC-TM900



MENU : [COPY] → [ → ] or [ → ]

You can copy scenes recorded in 3D between the SD card and the built-in memory. (You cannot copy scenes recorded in 3D when [1080/60p  →  AVCHD] is selected.)

HDC-HS900

MENU : [COPY] → [ → ] or [ → ]

You can copy scenes recorded in 3D between the SD card and the HDD. (You cannot copy scenes recorded in 3D when [1080/60p  →  AVCHD] is selected.)

- Select [VIDEO] → [SELECT SCENES] or [SELECT DATE] → [AVCHD].
- When selecting scenes, select ones marked with  on the thumbnail display.
- When selecting by date, select a date marked with  from the list of dates.

Using HD Writer AE 3.0

• Please refer to page 125 for details about copying with HD Writer AE 3.0.
When you use HD Writer AE 3.0 to handle scenes recorded in 3D, the following operations are possible.

- Copying data to a PC
(Scenes recorded in 3D will be copied unaltered as 3D video.)
- Copying in BD/AVCHD format
(Scenes recorded in 3D will be copied unaltered as 3D video.)
- Copying in DVD-Video format
(Scenes recorded in 3D will be converted to 2D video when copied.)
- Editing
(The only types of editing possible on scenes recorded in 3D are Delete partially and Divide Scene.)
- Online sharing
(Convert the scenes recorded in 3D to 2D video when uploading.)
- Playing back on a PC
(3D video is played back as 2D video.)
 - When writing scenes recorded in 3D to a Blu-ray disc, DVD or SD card, a gray frame is displayed around the thumbnail.

Using a Mac

- Scenes recorded in 3D are not supported by iMovie'11.

What you can do with a PC

HD Writer AE 3.0

You can copy the motion/still picture data to the HDD of PCs or write to media like Blu-ray discs, DVD discs or SD cards using HD Writer AE 3.0, the software installed in the supplied CD-ROM.

Refer to the operating instructions of HD Writer AE 3.0 (PDF file) for details on how to use it.

■ Smart Wizard

The Smart Wizard screen is automatically displayed when you connect this unit to a PC with HD Writer AE 3.0 installed. (→ 133)



Copy to PC:

You can copy motion/still picture data to the HDD of PCs.

Copy to disc:

You can copy to disc in high definition picture quality or conventional standard picture quality (MPEG2 format).

- Select the function you wish to use and follow the on-screen instructions for easy copying.

What can be done with the HD Writer AE 3.0	Data type
Copying data to a PC	Motion picture and still picture
Copying in BD/AVCHD format: ● iFrame scenes cannot be copied to BD/AVCHD format.	
Copying in DVD-Video format: ● Converted to conventional standard quality (MPEG2 format).	Motion picture
Editing: Editing motion picture data copied on an HDD of a PC ● Dividing, Trimming, Still picture, Title, Effect, Transition, BGM, Delete partially ● Converting the motion picture data to MPEG2 ● Converting part of motion picture into still picture	
Online sharing: You can upload motion pictures on the Internet and share them with your family and friends.	
Playing back on a PC: Play back the motion picture data in high definition picture quality on a PC.	
Formatting discs: Depending on the type of disc that you use, formatting is necessary.	

- It is possible to play back on a PC using a image viewer standard to Windows or commercially available image browsing software, and copy pictures to a PC using Windows Explorer.
- Please refer to page 136 for details about using a Mac.

Important Notice

- **When using an SDXC Memory Card, check the following support site.**
<http://panasonic.net/avc/sdcard/information/SDXC.html>
- **Do not insert a disc recorded in AVCHD format with HD Writer AE 3.0 in a device that does not support the AVCHD format. In some cases the disc may get stuck in the device. The disc will not play back on devices that do not support the AVCHD format.**
- **When inserting a disc containing recorded motion pictures into other devices, a message prompting you to format the disc may be displayed. Do not format the disc, since deleted data cannot be restored later.**

-
- **It is impossible to write data to the built-in memory or HDD on this unit from a PC.**
 - **Motion pictures that have been recorded on another device cannot be written to the software supplied with this unit. To write motion picture data recorded with the Panasonic High Definition Video Camera sold previously, use the HD Writer supplied with the unit.**
 - We cannot guarantee operation if you use software other than that supplied to read/write motion picture.
 - Do not start the software supplied with this unit and other software at the same time. Close any other software if you start the software supplied with this unit and close the software supplied with this unit if you start any other software.

■ About Conversion Assist Function

When you want to convert the recording quality and write to media, the "Conversion Assist Function", which is a linking function between this unit and the HD Writer AE 3.0, is activated by connecting this unit to the PC with the USB cable. When the "Conversion Assist Function" is used, it is possible to write to media faster than when operating only on PC.

- Please refer to page 133 for details about the connection of this unit and a PC.
- Refer to the operating instructions of the software for details. (→ 136)

End User License Agreement

Before opening the CD-ROM package, please read the following.

You ("Licensee") are granted a license for the Software defined in this End User License Agreement ("Agreement") on condition that you agree to the terms and conditions of this Agreement. If Licensee does not agree to the terms and conditions of this Agreement, promptly return the Software to Panasonic Corporation ("Panasonic"), its distributors or dealers from which you made the purchase.

Article 1 License

Licensee is granted the right to use the software, including the information recorded or described on the CD-ROM, instruction manuals, and any other media provided to Licensee (collectively "Software"), but all applicable rights to patents, copyrights, trademarks and trade secrets in the Software are not transferred to Licensee.

Article 2 Use by a Third Party

Licensee may not use, copy, modify, transfer or allow any third party, whether free of charge or not, to use, copy or modify the Software, except as expressly provided for in this Agreement.

Article 3 Restrictions on Copying the Software

Licensee may make a single copy of the Software in whole or a part solely for back-up purposes.

Article 4 Computer

Licensee may use the Software only on one computer, and may not use it on more than one computer.

Article 5 Reverse Engineering, Decompiling or Disassembly

Licensee may not reverse engineer, decompile, or disassemble the Software, except to the extent either of them is permitted under law or regulation of the country where Licensee resides. Panasonic, or its distributors will not be responsible for any defects in the Software or damage to Licensee caused by Licensee's reverse engineering, decompiling, or disassembly of the Software.

Article 6 Indemnification

The Software is provided "AS-IS" without warranty of any kind, either expressed or implied, including, but not limited to, warranties of non-infringement, merchantability and/or fitness for a particular purpose. Further, Panasonic does not warrant that the operation of the Software will be uninterrupted or error free. Panasonic or any of its distributors will not be liable for any damage suffered by Licensee arising from or in connection with Licensee's use of the Software.

Article 7 Export Control

Licensee agrees not to export or re-export to any country the Software in any form without the appropriate export licenses under regulations of the country where Licensee resides, if necessary.

Article 8 Termination of License

The right granted to Licensee hereunder will be automatically terminated if Licensee contravenes any of the terms and conditions of this Agreement. In this event, Licensee must destroy the Software and related documentation together with all the copies thereof at Licensee's own expense.

Operating environment

- Even if the system requirements mentioned in this owner's manual are fulfilled, some PCs cannot be used.
- A CD-ROM drive is necessary to install the supplied software applications. (A compatible Blu-ray disc/DVD writer drive and media are necessary for writing to a Blu-ray disc/DVD.)
- Operation is not guaranteed in the following cases.
 - When 2 or more USB devices are connected to a PC, or when devices are connected through USB hubs or by using extension cables.
 - Operation on an upgraded OS.
 - Operation on an OS other than the one pre-installed.
- This software is not compatible with Microsoft Windows 3.1, Windows 95, Windows 98, Windows 98SE, Windows Me, Windows NT and Windows 2000.

■ Operating environment for HD Writer AE 3.0

PC	IBM PC/AT compatible PC
OS	Windows 7 (32 bit/64 bit) Starter/Home Basic/Home Premium/Ultimate/Professional Windows Vista (32 bit) Home Basic/Home Premium/Business/Ultimate (SP1/SP2) Windows XP (32 bit) (SP3)
CPU	Intel Pentium 4 2.8 GHz or higher (including compatible CPU) <ul style="list-style-type: none"> ● Intel Core 2 Duo 2.16 GHz or higher or AMD Athlon 64 X2 Dual-Core 5200+ or higher is recommended when using playback function or MPEG2 output function. ● Intel Core 2 Quad 2.6 GHz or higher is recommended when using editing or Continuous Photo Playback function. ● Intel Core i7 2.8 GHz or higher is recommended when playing back or using the editing function for 1080/60p
RAM	Windows 7: 1 GB or more (32 bit)/2 GB or more (64 bit) Windows Vista: 1 GB or more Windows XP: 512 MB or more (1 GB or more recommended)

Display	High Color (16 bit) or more (32 bit or more recommended) Desktop resolution of 1024×768 pixels or more (1920×1080 pixels or more recommended) Windows 7/Windows Vista: DirectX 9.0c compatible video card (DirectX 10 recommended) Windows XP: DirectX 9.0c compatible video card Compatible with DirectDraw overlay PCI Express™ × 16 compatible recommended Video memory of 256 MB or more recommended
Free hard disk drive space	Ultra DMA — 100 or more 450 MB or more (for installing the software) <ul style="list-style-type: none"> When writing to a DVD/Blu-ray disc/SD, more than double the amount of free space as the disc being created is necessary.
Sound	DirectSound Support
Interface	USB port [Hi-Speed USB (USB 2.0)]
Other requirements	Mouse or equivalent pointing device Internet connection

- Supplied CD-ROM is available for Windows only.
- Input is not supported in languages other than English, German, French and Simplified Chinese.
- Operation cannot be guaranteed on all Blu-ray disc/DVD drives.
- Operation is not guaranteed on Microsoft Windows Vista Enterprise, Windows XP Media Center Edition, Tablet PC Edition and Windows 7 Enterprise.
- This software is not compatible with a multi-boot environment.
- This software is not compatible with a multi-monitor environment.
- If using Windows XP, an administrative account user only can use this software. If using Windows Vista/Windows 7, administrative account and standard account users only can use this software. (An administrative account user should install and uninstall this software.)

■ To use the HD Writer AE 3.0

You will need a high performance PC depending on the functions to be used. It may not properly play back or properly operate depending on the environment of the PC used. Refer to the operating environment and notes.

- Operation during the playback may become slow if the CPU or memory is not fulfilling the requirements of the operating environment.
- Always use the most current driver for the video card.
- Always make sure there is enough capacity on the HDD in the PC. It may become inoperable or the operation may stop suddenly if the capacity gets low.

■ Operating environment for the card reader function (mass storage)

PC	IBM PC/AT compatible PC
OS	Windows 7 (32 bit/64 bit) Windows Vista (32 bit) (SP1/SP2) Windows XP (32 bit) (SP3)
CPU	Windows 7/Windows Vista: 1.0 GHz or higher Windows XP: Intel Pentium III 450 MHz or higher or Intel Celeron 400 MHz or higher
RAM	Windows 7: 1 GB or more (32 bit)/2 GB or more (64 bit) Windows Vista Home Basic: 512 MB or more Windows Vista Home Premium/Business/Ultimate/Enterprise: 1 GB or more Windows XP: 128 MB or more (256 MB or more recommended)
Interface	USB port
Other requirements	Mouse or equivalent pointing device

- The USB equipment operates with the driver installed as standard in the OS.

Installation

When installing the software, log on to your computer as the Administrator or with a user name with equivalent authorization. (If you do not have authorization to do this, consult your manager.)

- Before starting the installation, close all applications that are running.
- Do not perform any other operations on your PC while the software is being installed.
- Explanation of operations and screens is based on Windows 7.

1 Insert the CD-ROM into the PC.

- The following screen is displayed automatically. Click [Run setup.exe] → [Yes].
- If Windows 7 is in use or the following screen is not displayed automatically, select [Start] → [Computer] (or double-click on [Computer] on the desktop), and then double-click [Panasonic].

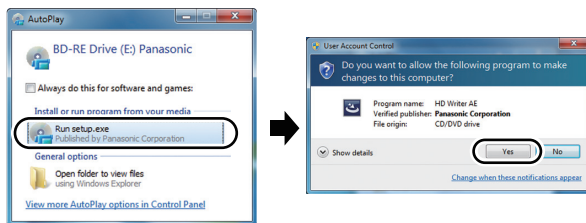

2 Click [Next].

3 Read the [End User License Agreement], then place a check beside [I accept the terms of the license agreement] if you agree to them and click [Next].

4 Select the country or region where you live, then click [Next].

- If the country or region cannot be selected, select [NTSC Area].
- When the confirmation message appears, click [Yes].

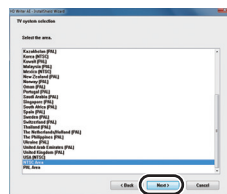

5 Select where the application is to be installed, then click [Next].

6 Select [Yes] or [No] to create shortcut.

- A message regarding the playback in the environment used may be displayed depending on the performance of the PC used. Click [OK] after confirming.

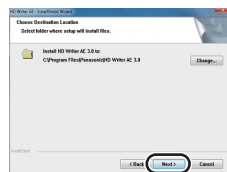

7 When installation is complete, some notes will appear.
Check the contents, then close the window.

8 Select **[Yes, I want to restart my computer now.]**, then click **[Finish]**.

The PC must be rebooted for the application to work.

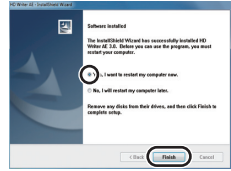

■ Uninstalling HD Writer AE 3.0

Follow the steps below to uninstall any software applications that you no longer require.

1 Select **[Start] → [Control Panel] → [Uninstall a program]**.

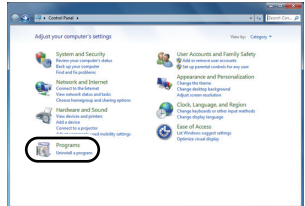

2 Select **[HD Writer AE 3.0]**, then click **[Uninstall]**.

- Proceed with the uninstallation by following the on-screen instructions.
- After uninstalling the software, be sure to reboot the PC.

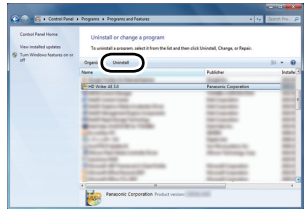

Connecting to a PC

- Connect this unit to the PC after the software applications are installed.
- Remove the supplied CD-ROM from your PC.

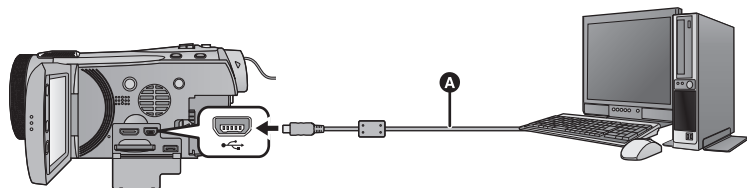

A USB cable (supplied)

- Insert the plugs as far as they will go.

1 Connect this unit to the AC adaptor.

- It is possible to use the unit connected to the PC with the batteries only, but you will not be able to write data into the unit. Use the AC adaptor to free you from worrying about the battery running down.
- Connect with the AC adaptor when using the Conversion Assist Function.

2 Turn on the unit.

- This function is available in all modes.

3 Connect this unit to a PC.



- The USB function selection screen will appear.

4 Touch [PC] on the screen of this unit.

- The Smart Wizard Screen is automatically displayed when HD Writer AE 3.0 is installed.
- This unit is automatically recognized as an external drive of the PC. (→ 135)
- When you select an option other than [PC], reconnect the USB cable.
- When using the battery, the LCD monitor turns off after about 5 seconds. Touch the screen to turn the LCD monitor on.

- Do not use any other USB cables except the supplied one. (Operation is not guaranteed with any other USB cables.)
- **When the unit is connected to a PC, it cannot be turned off.**
Disconnect the USB cable, before turning this unit off.
- When performing reading/writing between a PC and an SD card, be aware that some SD card slots built into PCs and some SD card readers are not compatible with the SDHC Memory Card or SDXC Memory Card.
- When using an SDXC Memory Card, check the following support site.
<http://panasonic.net/avc/sdcard/information/SDXC.html>

About the screen indication of the unit

- Do not disconnect the USB cable, the battery or the AC adaptor while the access lamp is on or card access icon () appears on the unit screen.
- **HDC-TM900**
Do not disconnect the USB cable, the battery or the AC adaptor while the access lamp is on or the built-in memory access icon () appears on the unit screen.
- **HDC-HS900**
Do not disconnect the USB cable, the battery or the AC adaptor while the HDD access lamp is on or HDD access icon () appears on the unit screen.
- If the screen does not change when the unit is operated while connected to a PC, disconnect the battery and/or AC adaptor, wait approximately 1 minute, reconnect the battery and/or AC adaptor, wait approximately 1 minute again, and then turn the unit back on. (Data may be destroyed when above operation is performed while accessing the SD card, built-in memory or HDD.)

■ To disconnect USB cable safely

Select the  icon in task tray displayed on the PC, and then click [Eject Panasonic Camcorder].

- Depending on your PC's settings, this icon may not be displayed.

About the PC display

When the unit is connected to a PC, it is recognized as an external drive.

- Removable disk (Example:  CAM_SD (G:)) is displayed in [Computer].

We recommend using HD Writer AE 3.0 to copy or write back motion picture data. Using Windows Explorer or other programs on the PC to copy, move or rename files and folders recorded with this unit will result in them being unusable with HD Writer AE 3.0.

It is impossible to write data to the built-in memory or HDD on the unit from a PC.

Example folder structure of an SD card:

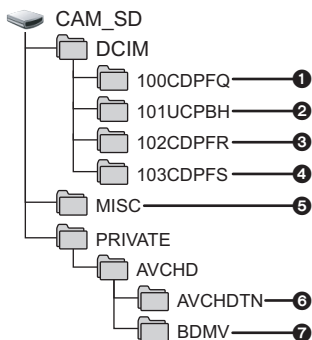

Example folder structure of built-in memory or HDD:

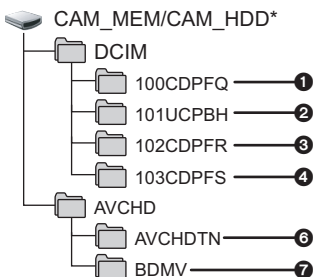

- * [CAM_MEM] is displayed when using the **HDC-TM900**, and [CAM_HDD] is displayed when using the **HDC-HS900**.

The following data will be recorded.

- 1 Up to 999 still pictures in JPEG format ([S1000001.JPG] etc.)
- 2 iFrame format motion picture files ([S1000001.MP4] etc.)
- 3 JPEG format still pictures recorded in Hi-speed Burst Shooting Mode
- 4 JPEG format still pictures created from the motion picture
- 5 The DPOF setting files
- 6 The motion picture thumbnails
- 7 AVCHD format motion picture files ([00000.MTS] etc.)

■ Copying your still pictures to your PC

Card reader function (mass storage)

Still pictures recorded with this unit can be copied to the PC with Explorer or other programs.

- 1 Double click the folder that contains the still pictures. ([DCIM] → [100CDPFQ] etc.)
- 2 Drag and drop the still pictures onto the destination folder (on the PC's HDD).

- Do not delete the SD card's folders. Doing so may make the SD card unusable in this unit.
- When data not supported by this unit has been recorded on a PC, it will not be recognized by this unit.
- Always use this unit to format SD cards.

Starting HD Writer AE 3.0

- To use the software, log on as an Administrator or as user name for standard user account (only for Windows 7/Windows Vista).

The software cannot be used with the user name for a guest account.

(On the PC)

Select [Start] → [All Programs] → [Panasonic] → [HD Writer AE 3.0] → [HD Writer AE].

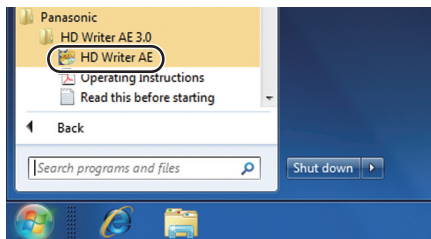

- For details on how to use the software applications, read the PDF operating instructions of the software.

Reading the operating instructions of the software applications

- You will need Adobe Acrobat Reader 5.0 or later or Adobe Reader 7.0 or later to read the PDF operating instructions.

Select [Start] → [All Programs] → [Panasonic] → [HD Writer AE 3.0] → [Operating Instructions].

If using Mac

- HD Writer AE 3.0 is not available for Mac.
- iMovie'11 supported. For details about iMovie'11, please contact Apple Inc.
- iMovie'11 is not compatible with 1080/60p. 1080/60p scenes cannot be imported to a Mac.
 - For users who have **HDC-TM900**, import after converting to a normal scene using [1080/60p] → [AVCHD]. (→ 111)
 - For users who have **HDC-HS900**, import after converting to a normal scene using [1080/60p] → [AVCHD]. (→ 111)
- There are some limitations in the functions when iMovie'11 is used. Refer to page 146 for details.

■ Operating environment

PC	Mac
OS	Mac OS X 10.6.3
CPU	Intel Core Duo or better
RAM	1 GB or more
Interface	USB port

- Even if the system requirements mentioned in this owner's manual are fulfilled, some PCs cannot be used.
- The USB equipment operates with the driver installed as standard in the OS.
- Supplied CD-ROM is available for Windows only.

■ Copying still pictures on PC

1 Connect this unit to a PC via the supplied USB cable.

- The USB function selection screen will appear.

2 Touch [PC] on the screen of this unit.

- This unit is automatically recognized as an external drive of Mac.
- When you select an option other than [PC], reconnect the USB cable.
- When using the battery, the LCD monitor turns off after about 5 seconds. Touch the screen to turn the LCD monitor on.

3 Double-click [CAM_SD] displayed on the desktop.

- For users who have (HDC-TM900), [CAM_SD] and [CAM_MEM] are displayed on the desktop and for users who have (HDC-HS900), [CAM_SD] and [CAM_HDD] are displayed on the desktop.
- Files are stored in [100CDPFQ] or [102CDPFR] folder etc. in the [DCIM] folder.

4 Using a drag-and-drop operation, move the pictures you want to acquire or the folder storing those pictures to any different folder on the PC.

■ To disconnect USB cable safely

Drag [CAM_SD] disk icon to the [Trash], and then disconnect the USB cable.

- For users who have (HDC-TM900), [CAM_SD] and [CAM_MEM] are displayed on the desktop and for users who have (HDC-HS900), [CAM_SD] and [CAM_HDD] are displayed on the desktop.

-
- Do not remove the SD card from this unit when this unit is connected to the PC using a USB cable.

12.2m / 7.7m / 4.9m / 0.3m / 14.2m / 8.6m / 5.5m / 13.3m / 8.3m /
5.3m / 2.1m

Number of recording pixels for still pictures
(→ 38, 78, 80, 90)

In Playback Mode, the picture size is not
displayed for still pictures recorded with
other products that have different picture
sizes from the sizes shown above.

10/2 Self-Timer Recording (→ 64)

MEGA MEGA OIS (→ 37)

B

Zebra (→ 76)

HDD Falling Detection (→ 9)²

99%↑ Luminance Level (→ 77)

PRE-REC PRE-REC (→ 62)

Interval Recording (→ 68)

+3dB / +6dB / Bass Setting (→ 76)

LOW CUT
ZOOM Zoom Microphone (→ 74)

Focus Microphone (→ 74)

Stereo Microphone (→ 74)

Wind Noise Canceler (→ 74)

Picture adjustment (→ 76)

Digital cinema color (→ 73)

Digital Cinema (→ 68)

AF/AE tracking (→ 59)

ZOOM Touch Zoom (→ 58)

Touch Shutter (→ 60)

MF Manual Focus (→ 85)

AWB / / / / /

White Balance (→ 83)

1/100 Shutter Speed (→ 84)

OPEN/F2.0 Iris value (→ 84)

0dB Gain value (→ 84)

○ (White) / ● (Green) / / / / /

Focus indication (→ 37)

Hi-Speed Burst Shooting
(→ 80)

AF* AF assist lamp (→ 81)

C

Display Touch Menu (→ 30)

Backlight Compensation
(→ 64)

Soft Skin Mode (→ 64)

Tele Macro (→ 65)

Intelligent Contrast Control
(→ 62)

Microphone Level (→ 75)

Smile Shot (→ 63)

W / B Fade (White), Fade (Black)
(→ 62)

Color Night Rec function
(→ 65)

Intelligent Exposure (→ 64)

Flash (→ 63)

Flash Level (→ 63)

Red-Eye Reduction (→ 64)

World time setting (→ 46)

NOV 15 2011 Date indication (→ 31)

12:34PM Time indication (→ 31)

■ Playback indications



Display during playback (→ 41, 89)

0h00m00s	Playback Time (→ 41)
No.10	Scene Number
	Repeat Playback (→ 91)
	Resume Playback (→ 91)
100-0001	Still picture folder/file name
1	DPOF already set (to more than 1) (→ 100)
	Protected motion pictures/ still pictures (→ 99)
	1080/60p recorded scene (→ 41)
	iFrame recorded scene (→ 41)
	AVCHD recorded scene (→ 41)
	Relay-recorded scene (→ 69)*1
	Interval-recorded scene (→ 68)
	Still picture recorded using Smile Shot (→ 63)
	Scenes recorded in 3D (→ 109)

■ Indication of connection to other devices

	Accessing the card (→ 121, 134)
	Accessing the built-in memory (→ 121, 134)*1
	Accessing the HDD (→ 121, 134)*2

■ Confirmatory indications

-- (Time display) The built-in battery is low.
(→ 31)

Warning for face-to-face recording (→ 33)

SD card is not inserted or is non-compatible.

■ Confirmatory indications when a DVD burner is connected

Disc Playback (→ 117)

Scene copied in [Standard]([XP])
 Scene copied in [Standard]([SP])

/ / / / / / /

Disc type (→ 113)

Messages

Major confirmation/error messages to be indicated on the screen in text.

*1 **HDC-TM900** only

*2 **HDC-HS900** only

PERIODICALLY MAKE BACK UP OF DATA IN BUILT-IN MEMORY.*1/ RECOMMEND DATA BACK UP PERIODICALLY.*2

We recommend backing up important recorded motion pictures and still pictures periodically to a PC, DVD disc etc. to protect it. (→ 113, 125) This message does not indicate that there is a problem with this unit.

HDD BACKUP RECOMMENDED.*2

There is a possible problem with the HDD. Copy the motion pictures and still pictures stored on the HDD to a PC or a DVD disc immediately (→ 113, 125), and detach the power and contact consumer support. (→ 168, 169)

HDD ERROR OCCURRED. PLEASE TURN UNIT OFF, THEN TURN ON AGAIN.*2

Access to HDD failed. Turn on the unit again. Make sure not to shock or impact the unit.

CANNOT OPERATE DUE TO LOW TEMPERATURE.*2

The internal temperature of this unit is extremely low so it cannot be operated. If "Please Wait." appears after this message, wait awhile without turning the unit off. It may take time until the unit can be used.

CHECK CARD.

This card is not compatible or it cannot be recognized by the unit. If this message appears even though motion pictures and still pictures are recorded on an SD card, the card may be unstable. Reinsert the SD card, then turn the unit off and then on again.

THIS BATTERY CANNOT BE USED.

- Use a battery that is compatible with this unit. (→ 21)
If using a Panasonic battery compatible with this unit, remove the battery and then insert it again. If the message appears even after repeating this several times, this unit needs repair. Detach the power and contact consumer support. (→ 168, 169) Do not attempt to repair it by yourself.
- You are attempting to connect an AC adaptor not compatible with this unit. Use the supplied AC adaptor. (→ 22)



PLEASE CHECK EXTERNAL DRIVE OR DISC.

A disc that cannot be used when connecting the unit to the DVD burner has been inserted, or the DVD burner is not recognized properly. Connect the USB Connection Cable again and insert a disc to copy the data. (→ 113)

About recovery

If faulty management information is found, the messages may appear and a repair is performed. (Repairing may take time depending on the error.)

**SOME SCENES NEED REPAIRING. PLAY SCENES TO BE REPAIRED.
(IRREPARABLE SCENES WILL BE DELETED.)**

- The above message is displayed when abnormal management information is detected when the scenes are displayed in thumbnail. To perform the repair, touch the scene with  in the thumbnail, and start the playback. **Please be aware that if the repair fails, scenes with  will be deleted.**
- Use a sufficiently charged battery or the AC adaptor.
- Depending on the condition of the data, it may not be possible to completely repair the data.
- If recovery fails, it will not be possible to play back scenes recorded before the unit turned off.
- When data recorded on another device is recovered, it may not be possible to play back the data on this unit or the other device.
- If recovery fails, turn the unit off and on again after waiting awhile. If recovery fails repeatedly, format a media on the unit. Please be aware that if a media is formatted, then all the data recorded on the media will be erased.
- If the thumbnail information is recovered, displaying the thumbnails may become slower.

Troubleshooting



Power

Problem	Check points
<p>This unit cannot be turned on.</p> <p>This unit does not stay on long enough.</p> <p>Battery runs down quickly.</p>	<ul style="list-style-type: none"> ● Charge the battery again to ensure it is sufficiently charged. (→ 22) ● In cold places, the battery using time becomes shorter. ● The battery has a limited life. If the operating time is still too short even after the battery is fully charged, the battery has worn out and needs to be replaced.
<p>This unit is turned off automatically.</p>	<ul style="list-style-type: none"> ● If the unit turns off when you turn off the power to the TV using the TV remote control, the VIERA Link is at work. If you are not using the VIERA Link, set [VIERA Link] to [OFF]. (→ 107) ● When this unit is connected to a DVD burner to copy or play back images (a disc is being accessed), the unit turns off automatically if the USB Connection Cable is removed.
<p>This unit cannot be operated though it is turned on.</p> <p>This unit does not operate normally.</p>	<ul style="list-style-type: none"> ● Remove the battery or AC adaptor, wait about 1 minute and then reconnect the battery or AC adaptor. Then about 1 minute later, turn on the unit again. (Conducting the above operation while the media is being accessed may damage the data on the media.) ● If normal operation is still not restored, detach the power connected, and contact consumer support. (→ 168, 169)
<p>“ERROR OCCURRED. PLEASE TURN UNIT OFF, THEN TURN ON AGAIN.” is displayed.</p>	<ul style="list-style-type: none"> ● The unit has automatically detected an error. Restart the unit by turning the unit off and on. ● The unit will be turned off in about 1 minute if the unit is not turned off and on. ● Repair is needed if it is repeatedly displayed even if it is restarted. Detach the power connected, contact consumer support. (→ 168, 169) Do not attempt to repair the unit by yourself.

Indication

Problem	Check points
<p>Remaining battery indication is not displayed properly.</p>	<ul style="list-style-type: none"> ● The remaining battery capacity indication is an approximation. If the remaining battery capacity indication is not displayed correctly, fully charge the battery, discharge it and then charge it again.



Recording

Problem	Check points
<p>The unit arbitrarily stops recording.</p>	<ul style="list-style-type: none"> ● Use an SD card that can be used for motion picture recording. (→ 26) ● The recordable time may have shortened due to the deterioration of the data writing speed or repeated recording and deletion. Using the unit, format the SD card, built-in memory or HDD. (→ 51) ● If [AGS] is [ON], record in the normal horizontal position or set [AGS] to [OFF]. (→ 73) ● HDC-HS900 If the unit is exposed to strong vibrations or shocks while recording on HDD, recording may stop to protect the HDD. If the unit is used in a place with loud sounds, the recording may stop due to sound vibrations. Recording data on an SD card is recommended in these places.
<p>Auto focus function does not work.</p>	<ul style="list-style-type: none"> ● Switch to Intelligent Auto Mode. ● If you are trying to record a scene which is hard to bring into focus in Auto Focus Mode, use the Manual Focus Mode to adjust the focus. (→ 40, 85)
<p>Color balance of images is strange when recording in a place such as a gymnasium.</p>	<ul style="list-style-type: none"> ● In a place with multiple light sources, such as a gymnasium or a hall, set the white balance setting to  (Indoor mode 2). If you cannot record clearly with the  (Indoor mode 2), set it to  (Manual adjustment mode). (→ 83)
<p>Color or brightness of the image changes, or you may see horizontal bars in the image.</p> <p>The LCD monitor flickers indoors.</p>	<ul style="list-style-type: none"> ● Color or brightness of the image may change, or you may see horizontal bars in the image when the object is recorded under fluorescent light, mercury light or sodium light, etc., but this is not a malfunction. ● In Motion Picture Recording Mode, record in Intelligent Auto Mode or set the shutter speed to 1/60 in areas where the power supply frequency is 60 Hz, or 1/100 in areas of 50 Hz. ● In Still Picture Recording Mode, this will not affect the recorded image.

Recording

Problem	Check points
Object seems to be warped.	<ul style="list-style-type: none"> Object seems to be warped slightly when the object moves across the image very fast, but this is because the unit is using MOS for the image sensor. This is not a malfunction.

Playback

Problem	Check points
Scenes/still pictures cannot be played back.	<ul style="list-style-type: none"> Any scenes/still pictures where the thumbnails are displayed as  cannot be played back.
Scenes cannot be deleted.	<ul style="list-style-type: none"> Release the protect setting. (→ 99) Any scenes/still pictures where the thumbnails are displayed as  cannot be deleted. If the scenes/still pictures are unnecessary, format the media to erase the data. (→ 51) Please be aware that if a media is formatted then all the data recorded on the media is erased and cannot be recovered. Back up important data on a PC, disc etc.
White round spots like soap bubbles appear on the recorded picture.	<ul style="list-style-type: none"> If you take a picture with the flash in a dark place or indoors, white round spots may appear on the picture caused by the flash reflecting of particles of dust in the air. This is not a malfunction. A characteristic of this is that the number of round spots and their position differ in every picture. 

With other products

Problem	Check points
Although this unit is correctly connected to a TV, images cannot be seen.	<ul style="list-style-type: none"> Please read the operating instructions of your TV and select the channel that matches the input used for the connection.
The images are squeezed horizontally.	<ul style="list-style-type: none"> Change the [TV ASPECT] setting to match the aspect ratio of the TV. (→ 105) Change the setting of the unit depending on the cable connecting to the TV. (→ 106)
If the SD card is inserted in another device, it is not recognized.	<ul style="list-style-type: none"> Check that the device is compatible with the capacity or type of SD card (SD Memory Card/SDHC Memory Card/SDXC Memory Card) that you inserted. Refer to the operating instructions of the device for details.

With other products

Problem	Check points
VIERA Link does not work.	<p>(Setting on this unit)</p> <ul style="list-style-type: none"> ● Connect with a HDMI mini cable (optional). (→ 107) ● Touch [MENU], then touch [SETUP] → [VIERA Link] → [ON]. (→ 107) ● Turn the unit off and then back on again. <p>(Setting on other devices)</p> <ul style="list-style-type: none"> ● If the TV input does not switch automatically, switch the input using the TV remote control. ● Check the VIERA Link setting on the connected device. ● Please refer to the operating instructions of the connected device.
The power of the DVD burner cannot be turned on.	<ul style="list-style-type: none"> ● When the unit is connected to the DVD burner, use the respective AC adaptors for both this unit and the DVD burner.
Cannot copy scenes on the SD card by connecting to other equipment with the USB cable.	<ul style="list-style-type: none"> ● Other equipment might have not recognized the SD card. Unplug the USB cable once, and reconnect it.

With a PC

Problem	Check points
When connected by the USB cable, this unit is not detected by the PC.	<ul style="list-style-type: none"> ● After re-inserting the SD card into the unit, reconnect the supplied USB cable. ● Select another USB terminal on the PC. ● Check the operating environment. (→ 128, 137) ● Connect the supplied USB cable again after restarting the PC and turning on this unit again.
When the USB cable is disconnected, an error message will appear on the PC.	<ul style="list-style-type: none"> ● To disconnect the USB cable safely, double-click the  icon in the task tray and follow the instructions on the screen.
Cannot see the PDF operating instructions for HD Writer AE 3.0.	<ul style="list-style-type: none"> ● You will need Adobe Acrobat Reader 5.0 or later or Adobe Reader 7.0 or later to read the PDF operating instructions for HD Writer AE 3.0.
Cannot import AVCHD scenes with iMovie'11.	<ul style="list-style-type: none"> ● You may not be able to import AVCHD scenes with iMovie'11 when both AVCHD scenes and iFrame scenes are recorded on a media (an SD card, built-in memory or HDD). In such a case, first copy all the iFrame scenes data to iMovie'11, delete all the iFrame scenes data on the media, and then import the AVCHD scenes with iMovie'11.

Others

Problem	Check points
Item other than the touched one is selected.	<ul style="list-style-type: none"> ● Calibrate the touch screen. (→ 52)
If the SD card is inserted in this unit, it is not recognized.	<ul style="list-style-type: none"> ● If the SD card is formatted on a PC, it may not be recognized by this unit. Use this unit to format SD cards. (→ 51)
The remote control does not function.	<ul style="list-style-type: none"> ● [REMOTE CONTROL] of the [SETUP] is [OFF]. (→ 53) ● The button-type battery of the remote control may have run out. Replace it with a new button-type battery. (→ 53)

■ If scenes do not change smoothly when played back on another device (AVCHD, 1080/60p)

The images may be still for several seconds at the joins between the scenes if the following operations are performed when multiple scenes have been continuously played back using another unit.

- Just how smoothly the scenes will be played back depends on the playback unit.
Depending on the unit used, the images may stop moving and become still for a moment even when none of the following conditions are applicable.
- A continuous recording of motion picture data that exceeds 4 GB may momentarily stop at every 4 GB of data when played back with another device.
- It may not play back smoothly when the editing of scenes was done with the HD Writer AE 3.0, but it will play back smoothly if you set the seamless settings in the HD Writer AE 3.0. Refer to the operating instructions for the HD Writer AE 3.0.

Principal reasons for not playing back smoothly

- | |
|---|
| ● When the scenes were recorded on different dates |
| ● When scenes lasting under 3 seconds have been recorded |
| ● When PRE-REC was used for recording |
| ● When the Interval recording is used |
| ● When deleting scenes |
| ● When selected scenes are copied between an SD card and the built-in memory/HDD |
| ● When selected scenes are copied to a disc in a connected DVD burner |
| ● When scenes recorded with more than 99 scenes on the same date |

Cautions for use

About this unit

The unit and the SD card become warm during use. This is not a malfunction.

Keep this unit as far away as possible from electromagnetic equipment (such as microwave ovens, TVs, video games etc.).

- If you use this unit on top of or near a TV, the pictures and/or sound on this unit may be disrupted by electromagnetic wave radiation.
- Do not use this unit near cell phones because doing so may result in noise adversely affecting the pictures and/or sound.
- Recorded data may be damaged, or pictures may be distorted, by strong magnetic fields created by speakers or large motors.
- Electromagnetic wave radiation generated by microprocessors may adversely affect this unit, disturbing the pictures and/or sound.
- If this unit is adversely affected by electromagnetic equipment and stops functioning properly, turn this unit off and remove the battery or disconnect AC adaptor. Then reinsert the battery or reconnect AC adaptor and turn this unit on.

Do not use this unit near radio transmitters or high-voltage lines.

- If you record near radio transmitters or high-voltage lines, the recorded pictures and/or sound may be adversely affected.

Make sure to use the supplied cords and cables. If you use optional accessories, use the cords and the cables supplied with them.

Do not extend the cords and the cables.

Do not spray insecticides or volatile chemicals onto the unit.

- If the unit is sprayed with such chemicals, its body may be marred and the surface finish may peel off.
- Do not leave rubber or plastic products in contact with the unit for a long time.

When you use the unit in a sandy or dusty place such as a beach, do not let sand or fine dust get into the body and terminals of the unit.

Also, keep the unit away from sea water.

- Sand or dust may damage the unit. (Care should be taken when inserting and removing a card.)
- If sea water splashes onto the unit, wipe off the water with a well wrung cloth. Then wipe the unit again with a dry cloth.

When carrying the unit, do not drop or bump it.

- A strong impact can break the unit's casing, causing it to malfunction.

Cleaning

- Before cleaning, detach the battery or pull the AC cable from the AC outlet, and then wipe the unit with a soft, dry cloth.
- If the unit is very dirty, dip a cloth in water and squeeze firmly, and then wipe the unit with the damp cloth. Next, dry the unit with a dry cloth.
- Use of benzine, paint thinner, alcohol, or dishwashing liquid may alter the camera body or peel the surface finish. Do not use these solvents.
- When using a chemical dust cloth, follow the instructions that came with the cloth.

Do not use the unit for surveillance purposes or other business uses.

- This unit was designed for consumer intermittent use. It was not intended for continuous use, or for any industrial or commercial application resulting in prolonged use.
- In certain situations, continuous use could cause the unit to overheat and cause a malfunction. Such use is strongly discouraged.

When you are not going to use the unit for an extended time

- When storing the unit in a cupboard or cabinet, it is recommended that you place a desiccant (silica gel) in with it.

When disposing of or giving away this unit, note that:

- Formatting and deletion simply change the file management information and cannot be used to completely erase the data in built-in memory or HDD of this unit. The data can be recovered using commercially available software or the like.
- We recommend that you physically format the built-in memory or HDD before disposing of or giving away this unit.

HDC-TM900

To physically format the built-in memory, connect the unit via the AC adaptor, select [SETUP] → [FORMAT MEDIA] → [Built-inMemory] from the menu, and then press and hold the recording start/stop button on the screen below for about 3 seconds. When the built-in memory data deletion screen appears, select [YES], and then follow the on-screen instructions.

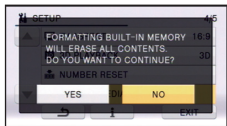

HDC-HS900

To physically format the HDD, connect the unit via the AC adaptor, select [SETUP] → [FORMAT MEDIA] → [HDD] from the

menu, and then press and hold the recording start/stop button on the screen below for about 3 seconds. When the HDD data deletion screen appears, select [YES], and then follow the on-screen instructions.

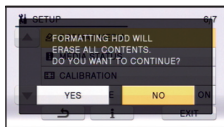

- Please look after the data in your built-in memory or HDD carefully. Panasonic will not be held responsible in the unlikely case that private data is divulged.

About the battery

The battery used in this unit is a rechargeable lithium-ion battery. It is susceptible to humidity and temperature and the effect increases the more the temperature rises or falls. In cold areas, the full charge indication may not appear or the low battery indication may appear about 5 minutes after starting use. At high temperatures, the protection function may be triggered, making it impossible to use the unit.

Be sure to detach the battery after use.

- If the battery is left attached, a minute amount of current continues to flow even if the unit is off. Keeping the unit in this state may result in over discharge of the battery. This may result in you not being able to use the battery even after it is charged.
- The battery should be stored in the vinyl bag so metal does not come into contact with the terminals.
- The battery should be stored in a cool place free from humidity, with as constant temperature as possible. (Recommended temperature: 15 °C to 25 °C (59 °F to 77 °F), Recommended humidity: 40%RH to 60%RH)

- Extremely high temperatures or low temperatures will shorten the life of the battery.
- If the battery is kept in high-temperature, high-humidity, or oily-smoky places, the terminals may rust and cause malfunctions.
- To store the battery for a long period of time, we recommend you charge it once every year and store it again after you have completely used up the charged capacity.
- Dust and other matter attached to the battery terminals should be removed.

Prepare spare batteries when going out for recording.

- Prepare batteries enough to last for 3 to 4 times the period you are planning to record for. Cold places such as a ski resort can shorten recording time.

If you drop the battery accidentally, check to see if the terminals are damaged.

- Attaching a battery with damaged terminals can damage the unit.

Do not throw an old battery into fire.

- Heating a battery or throwing it into a fire may result in an explosion.

If the operating time is very short even after the battery has been recharged, the battery has worn out. Please purchase a new battery.

About the AC adaptor

- If the temperature of the battery is extremely high or extremely low, charging may take time or the battery may not be charged.
- If you use the AC adaptor near a radio, radio reception may be disturbed. Keep the AC adaptor 1 m (3.3 feet) or more away from the radio.
- When using the AC adaptor, it may generate whirring sounds. However, this is normal.
- After use, be sure to disconnect the AC adaptor. (If it is left connected, a minute amount of current is consumed.)
- Always keep the electrodes of the AC adaptor and battery clean.

About status indicator during charging

When the status indicator is flashing at a particularly fast or slow rate, the following should be considered.

Flashing with approx. 4 second period (off for approx. 2 seconds, on for approx. 2 seconds):

- When the battery is over discharged or the temperature of the battery is too high or low. It can be charged, but it may take a few hours to complete the charging normally.
- It will flash in 2 second intervals when normal charging resumes. Even in such cases, it may start flashing in 4 second intervals until charging is completed depending on the conditions of use.

Flashing with approx. 0.5 second period (off for approx. 0.25 second, on for approx. 0.25 second):

- The battery is not charged. Remove the battery from the unit, and try charging again.
- Check that the terminals of the unit or battery are not dirty or covered with a foreign object, and connect the battery correctly once again. If a foreign object or dirt is present, turn off the unit before removing.
- The battery or environment is at an extremely high or low temperature. Wait until the temperature has returned to an appropriate level and try charging again. If you are still unable to charge, there may be a fault in the unit, battery or AC adaptor.

Off:

- Charging has finished.
- If the status indicator stays off despite the charging being unfinished, there may be a fault in the unit, battery or AC adaptor. Refer to page 149 for details on the battery.

About 3D

About 3D recording

Attach the 3D Conversion Lens securely. It must not be used with an insecure attachment.

Do not use the 3D Conversion Lens without adjusting it first.

- It will not be possible to record 3D video correctly, and this may lead to tiredness or discomfort.
- When you re-attach the 3D Conversion Lens after removing it, we recommend making the adjustments again.

With the 3D Conversion Lens attached, do not record a subject at less than the minimum focus distance.

- The 3D effects may be more pronounced, and therefore cause tiredness or discomfort.
- The minimum focus distance is approx. 1.2 m (3.9 feet).

When recording with the 3D Conversion Lens attached, be careful not to shake the unit.

- Tiredness or discomfort may result if the shake is pronounced, due to riding in a vehicle or walking etc.
- When moving the unit as you record, move it slowly.
- We recommend using a tripod.

About 3D viewing

Anyone who is hyper sensitive to light, suffers from heart disease or is otherwise unwell should avoid viewing 3D video.

- Doing may have an adverse affect on such medical conditions.

If you feel tired, uncomfortable or otherwise strange when viewing 3D video, stop viewing at once.

- Continuing to view may cause illness.
- Please rest appropriately after stopping the viewing.

When viewing 3D video, we recommend taking a break every 30 to 60 minutes.

- Viewing for extended periods may cause eye-fatigue.

Short-sighted or far-sighted persons, those with differences in the sight of their right and left eyes, and those with astigmatism are advised to correct their vision by wearing glasses etc.

Stop viewing if you can clearly see a double image while viewing 3D video.

- There are differences in the way that different people experience 3D video images. Please correct your sight appropriately before viewing 3D video.
- You can change the 3D setting of your television or 3D output setting of the unit to 2D.

When viewing 3D video on a 3D compatible television, position yourself a distance away that is at least 3 times the effective height of the television.

- (Recommended distance):
 - For 42"; approx. 1.6 m (5.2 feet),
 - for 46"; approx. 1.7 m (5.6 feet),
 - for 50"; approx. 1.9 m (6.2 feet),
 - for 54"; approx. 2.0 m (6.6 feet).
- Viewing from a distance closer than the recommended distance may lead to eye-fatigue.

Viewing of 3D video is not recommended for children under 5 to 6 years.

- It is difficult to know how children will react to tiredness or discomfort, and they may become ill suddenly.
- When children are viewing, have a responsible adult ensure that eye-fatigue does not occur.

About the SD card

When disposing of or giving away the SD card, note that:

- Formatting and deletion of this unit or computer only changes the file management information and does not completely delete the data in the SD card.
- It is recommended that the SD card is physically destroyed or the SD card is physically formatted using this unit when disposing of or giving away the SD card. To physically format the SD card, connect the unit via the AC adaptor, select [SETUP] → [FORMAT MEDIA] → [SD CARD] from the menu, and then press and hold the recording start/stop button on the screen below for about 3 seconds. When the SD card data deletion screen appears, select [YES], and then follow the on-screen instructions.

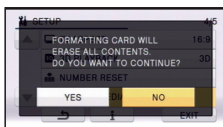

- The customer is responsible for the management of the data in the SD card.

LCD monitor/viewfinder

- When the LCD monitor gets dirty, wipe it with a soft cloth such as eye glass cleaner.
- Do not touch the LCD monitor with your finger nails, or rub or press with strong force.
- It may become hard to see or hard to recognize the touch when the LCD protection sheet is affixed.
- In a place with drastic temperature changes, condensation may form on the LCD monitor. Wipe it with a soft cloth such as eye glass cleaner.
- When the unit has become very cold, for example due to storage in a cold area, its LCD monitor will be slightly darker than usual immediately after the unit is turned

on. The normal brightness will be restored when the unit's internal temperature rises.

Extremely high precision technology is employed to produce the LCD Monitor screen featuring a total of approximately 460,000 dots. The result is more than 99.99% effective dots with a mere 0.01% of the dots inactive or always lit. However, this is not a malfunction and does not affect the recorded picture.

Extremely high precision technology is employed to produce the viewfinder screen featuring a total of approximately 263,000 dots. The result is more than 99.99% effective dots with a mere 0.01% of the dots inactive or always lit. However, this is not a malfunction and does not affect the recorded picture.

About personal information

After you have set up the face recognition function, personal information will be held in this unit and included in recorded images.

- When the unit is serviced, or given away/ disposed of, the personal information should be deleted in the interests of protecting personal information. (→ 99)

Indemnity

- Information, including personal information, may be changed or lost as a result of mistaken operation, static electricity effects, accident, breakage, repair or other handling.

It should be noted before use that Panasonic does not accept any responsibility for direct or indirect problems which occur as the result of the change to or loss of the information including personal information.

About condensation

When condensation forms on the unit, the lens will cloud up and the unit may not work properly. Make every effort to ensure that condensation does not form. If it does form, take the actions described below.

Causes of condensation

Condensation takes place when the ambient temperature or humidity is changed as follows.

- When this unit is brought inside from the cold (e.g. a ski slope) to a warm room.
- When this unit is moved from an air-conditioned car to outside.
- When a cold room has been warmed up quickly.
- When cool wind from an air conditioner is directly blown onto this unit.
- After rain showers.
- When this unit is in a very humid place where the air is thick with steam. (e.g. a heated swimming pool)

Helpful hint

If, for example, you have used this unit for recording on a ski slope and are taking it into a heated room, place the unit inside a plastic bag, remove as much of the air from inside the bag as possible, then seal the bag.

Leave the unit for about an hour in the room so the temperature of the unit is close to the ambient temperature of the room, then use it.

About copyright

■ Carefully observe copyright laws

Whatever you have recorded and created can be used for your personal entertainment only. Under copyright laws, other materials cannot be used without obtaining permission from the holders of the copyrights.

■ Licenses

- SDXC Logo is a trademark of SD-3C, LLC.
- “AVCHD” and the “AVCHD” Logo are trademarks of Panasonic Corporation and Sony Corporation.
- Manufactured under license from Dolby Laboratories.
Dolby and the double-D symbol are trademarks of Dolby Laboratories.
- HDMI, the HDMI Logo, and High-Definition Multimedia Interface are trademarks or registered trademarks of HDMI Licensing LLC in the United States and other countries.
- VIERA Link™ is a trademark of Panasonic Corporation.
- EZ Sync™ is a trademark of Panasonic Corporation.
- HDAVI Control™ is a trademark of Panasonic Corporation.
- x.v.Color™ is a trademark.
- LEICA is a registered trademark of Leica Microsystems IR GmbH and DICOMAR is a registered trademark of Leica Camera AG.
- Microsoft®, Windows® and Windows Vista® are either registered trademarks or trademarks of Microsoft Corporation in the United States and/or other countries.
- Microsoft product screen shot(s) reprinted with permission from Microsoft Corporation.

- IBM and PC/AT are registered trademarks of International Business Machines Corporation of the U.S.
- Intel®, Core™, Pentium® and Celeron® are the registered trademarks or trademarks of Intel Corporation in the United States and other countries.
- AMD Athlon™ is a trademark of Advanced Micro Devices, Inc.
- iMovie and Mac are trademarks of Apple Inc., registered in the U.S. and other countries.
- Other names of systems and products mentioned in these instructions are usually the registered trademarks or trademarks of the manufacturers who developed the system or product concerned.

This product is licensed under the AVC patent portfolio license for the personal and non-commercial use of a consumer to (i) encode video in compliance with the AVC Standard (“AVC Video”) and/or (ii) decode AVC Video that was encoded by a consumer engaged in a personal and non-commercial activity and/or was obtained from a video provider licensed to provide AVC Video. No license is granted or shall be implied for any other use. Additional information may be obtained from MPEG LA, LLC. See <http://www.mpegla.com>.

Recording modes/approximate recordable time

- SD cards are only mentioned with their main memory size. The stated times are the approximate recordable times for continuous recording.

						
Recording mode		[1080/60p]	[HA]	[HG]	[HX]	[HE]
Picture size		1920×1080	1920×1080	1920×1080	1920×1080	1920×1080
SD card	4 GB	19 min	30 min	40 min	1 h	1 h 30 min
	16 GB	1 h 20 min	2 h	2 h 40 min	4 h 10 min	6 h 40 min
	64 GB	5 h 20 min	8 h 30 min	11 h	16 h 50 min	27 h 30 min
HDC-TM900 Built-in memory	32 GB	2 h 40 min	4 h 10 min	5 h 30 min	8 h 20 min	13 h 40 min
HDC-HS900 HDD	220 GB	18 h 30 min	29 h	37 h 30 min	57 h 30 min	94 h

- A** Favors image quality
- B** Favors recording time

Recording mode		[iFrame]
Picture size		960×540
SD card	4 GB	19 min
	16 GB	1 h 20 min
	64 GB	5 h 20 min
HDC-TM900 Built-in memory	32 GB	2 h 40 min
HDC-HS900 HDD	220 GB	18 h 30 min

- If recording for long periods, prepare batteries for 3 or 4 times the period you wish to record for. (→ 23)
- The default setting is [HG] Mode.
- Recordable time of 3D recording mode is the same.
(During 3D recording mode, 1080/60p and iFrame recording mode cannot be used.)
- Maximum continuously recordable time for one scene: 12 hours
- The recording is paused once when the recording time for one scene exceeds 12 hours, and the recording will automatically resume after a few seconds.
- If a recording with a lot of action is recorded, the recording time is reduced.







- The recordable time may be reduced if recording of short scene is repeated.
- Use time in the row of 4 GB in the table on page 155 as a guideline for the time that can be copied onto one DVD disc (4.7 GB).

Others





Approximate number of recordable pictures

- SD cards are only mentioned with their main memory size. The stated number is the approximate number of recordable pictures.





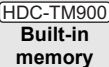

(When [ASPECT RATIO] is set to [4:3] and [QUALITY] is set to )



Picture size		 22M 4032×3024	 7.7M 3200×2400	 4.9M 2560×1920	 0.3M 640×480
SD card	4 GB	610	940	1500	30000
	16 GB	2500	3900	6200	122000
	64 GB	10000	15800	25000	492000
 Built-in memory	32 GB	5000	7900	12500	246000
 HDD	220 GB	33000	53000	84000	899100

(When [ASPECT RATIO] is set to [3:2] and [QUALITY] is set to )

Picture size		 14.2M 4608×3072	 8.6M 3600×2400	 5.5M 2880×1920
SD card	4 GB	500	850	1300
	16 GB	2100	3400	5500
	64 GB	8400	14000	22000
 Built-in memory	32 GB	4200	7000	11000
 HDD	220 GB	29000	45000	75000

(When [ASPECT RATIO] is set to [16:9] and [QUALITY] is set to )

Picture size		 13M 4864×2736	 8.3M 3840×2160	 5.3M 3072×1728	 2.1M 1920×1080
SD card	4 GB	550	850	1420	3600
	16 GB	2200	3400	5600	14000
	64 GB	9000	14000	23000	59000
 Built-in memory	32 GB	4500	7000	11500	29000
 HDD	220 GB	31000	49000	78000	201000

- When [QUALITY] is set to , the numbers of recordable pictures are larger than the numbers shown in the table above.
- **The number of recordable pictures depends on whether  and  are used together and on the subject being recorded.**
- Maximum number of recordable pictures that can be displayed is 99999.
If the number of recordable pictures exceeds 99999, the number will not change when the picture is taken until the number of recordable pictures gets less than 99999.
- The memory capacity indicated on the label of an SD card is the total of the capacity for copyright protection and management and the capacity which can be used on the unit, a PC etc.

Specifications

High Definition Video Camera

Information for your safety

Power source:	DC 9.3 V (When using AC adaptor) DC 7.2 V (When using battery)	
Power consumption:	Recording;	Charging;
	HDC-TM900	HDC-TM900
	6.4 W	10.3 W
	HDC-HS900	HDC-HS900
	7.4 W	10.9 W

Signal system:

1080/60p, 1080/60i, 540/30p

Recording format:

[1080/60p]; Original format

[HA]/[HG]/[HX]/[HE]; AVCHD format compliant

[iFrame]; MPEG-4 AVC file format compliant (.MP4)

Image sensor:

1/4.1" 3MOS image sensor

Total; 3050 K×3

Effective pixels;

Motion picture; 2530 K×3 (16:9)

Still picture; 2320 K×3 (4:3), 2630 K×3 (3:2), 2530 K×3 (16:9)

Lens:

Auto Iris, 12× Optical Zoom, F1.5 to F2.8

Focal length; 3.45 mm to 41.4 mm

Macro (Full range AF)

35 mm equivalent;

Motion picture; 35 mm to 420 mm (16:9)

Still picture; 38.8 mm to 466 mm (4:3), 35.7 mm to 428 mm (3:2), 35 mm to 420 mm (16:9)

Minimum focus distance;

Normal; Approx. 4 cm (1.6") (Wide)/Approx. 1.2 m (3.9 feet) (Tele)

Tele macro; Approx. 70 cm (28") (Tele)

Intelligent auto Macro; Approx. 1 cm (0.4") (Wide)/Approx. 70 cm (28") (Tele)

Filter diameter:

46 mm

Zoom:

12× Optical Zoom, 20× i.Zoom, 30×/700× Digital Zoom

Image Stabilizer function:

Optical (Hybrid Optical Image Stabilizer, Active Mode, Optical Image Stabilizer Lock function)

Monitor:

3.5" wide LCD monitor (Approx. 460 K dots)

Viewfinder:

0.24" wide EVF (Approx. 263 K dots)

Microphone:

5.1 channel surround microphone
(with a zoom microphone/focus microphone function)

Speaker:

1 round speaker, dynamic type

White balance adjustment:

Auto tracking white balance system

Standard illumination:

1,400 lx

Minimum required illumination:

Approx. 1.6 lx (1/30 with Low light mode in the Scene mode)

Approx. 1 lx with the Color Night Rec function

AV multi connector video output level:

Component video output level;

Y; 1.0 Vp-p, 75 Ω

Pb; 0.7 Vp-p, 75 Ω

Pr; 0.7 Vp-p, 75 Ω

AV video output level;

1.0 Vp-p, 75 Ω , NTSC system

HDMI mini connector video output level:

HDMI™ (x.v.Color™) 1080p/1080i/480p

AV multi connector audio output level (Line):

316 mV, 600 Ω , 2 ch

Headphone output:

77 mV, 32 Ω (Stereo mini jack)

HDMI mini connector audio output level:

[1080/60p], [AVCHD]; Dolby Digital/Linear PCM

[iFrame]; Linear PCM

MIC input:

-70 dBV (Mic sensitivity -50 dB equivalent, 0 dB=1 V/Pa, 1 kHz)

(Stereo mini jack)

USB:

Reader/writer function

SD card; Read/Write (No copyright protection support)

HDC-TM900

Built-in memory; Read only

HDC-HS900

HDD; Read only

Hi-Speed USB (USB 2.0), USB terminal Type Mini AB

USB host function (for DVD burner)

Flash:

Available range; Approx. 1.0 m to 2.5 m (3.3 feet to 8.2 feet)

Dimensions:**HDC-TM900**

66 mm (W)×72 mm (H)×146 mm (D)

[2.60 " (W)×2.83 " (H)×5.75 " (D)] (excluding projecting parts)

HDC-HS900

67 mm (W)×72 mm (H)×146 mm (D)

[2.64 " (W)×2.83 " (H)×5.75 " (D)] (excluding projecting parts)

Mass (Weight):**HDC-TM900**

Approx. 395 g (Approx. 0.87 lbs.) [without battery (supplied)]

HDC-HS900

Approx. 455 g (Approx. 1.00 lbs.) [without battery (supplied)]

Mass (Weight) in operation:**HDC-TM900**

Approx. 460 g (Approx. 1.01 lbs.) [with battery (supplied)]

HDC-HS900

Approx. 520 g (Approx. 1.15 lbs.) [with battery (supplied)]

Operating temperature:

0 °C to 40 °C (32 °F to 104 °F)

Operating humidity:

10%RH to 80%RH

Battery operation time:

See page 23

■ 3D Conversion Lens (optional)**Lens:**

F3.2 (f = 2.5 mm)

35 mm equivalent; 58 mm

Minimum recording distance; Approx. 1.2 m (3.9 feet)

Minimum illumination:

Approx. 28 lx (1/30 when [AUTO SLOW SHTR (3D)] is set to [ON])

■ Motion pictures

Recording media:

SD Memory Card (FAT12 and FAT16 system compliant)

SDHC Memory Card (FAT32 system compliant)

SDXC Memory Card (exFAT system compliant)

Refer to page 26 for details on SD cards usable in this unit.

HDC-TM900

Built-in memory; 32 GB

HDC-HS900

HDD; 220 GB

Compression:

MPEG-4 AVC/H.264

Recording mode and transfer rate:

[1080/60p]; Approx. 28 Mbps (VBR)

[HA]; Approx. 17 Mbps (VBR)

[HG]; Approx. 13 Mbps (VBR)

[HX]; Approx. 9 Mbps (VBR)

[HE]; Approx. 5 Mbps (VBR)

[iFrame]; Approx. 28 Mbps (VBR)

Refer to page 155 for the recordable time.

Picture size:

[1080/60p]; 1920×1080/60p

[HA]/[HG]/[HX]/[HE]; 1920×1080/60i

[iFrame]; 960×540/30p

Audio compression:

[1080/60p], [AVCHD]; Dolby Digital/5.1 ch (built-in microphone), 2 ch (built-in microphone/external microphone)

[iFrame]; AAC/2ch

■ Still pictures

Recording media:

SD Memory Card (FAT12 and FAT16 system compliant)

SDHC Memory Card (FAT32 system compliant)

SDXC Memory Card (exFAT system compliant)

Refer to page 26 for details on SD cards usable in this unit.

HDC-TM900

Built-in memory; 32 GB

HDC-HS900

HDD; 220 GB

Compression:

JPEG (Design rule for Camera File system, based on Exif 2.2 standard),

DPOF corresponding

Picture size:

Picture aspect [4:3]; 4032×3024/3200×2400/2560×1920/640×480

Picture aspect [3:2]; 4608×3072/3600×2400/2880×1920

Picture aspect [16:9]; 4864×2736/3840×2160/3072×1728/1920×1080

Refer to page 156 for the number of recordable pictures.

AC adaptor

Information for your safety

Power source:	AC 110 V to 240 V, 50/60 Hz
Power consumption:	16 W
DC output:	DC 9.3 V, 1.2 A

Dimensions:







52 mm (W)×26 mm (H)×86.3 mm (D) [2.1 " (W)×1.0 " (H)×3.4 " (D)]

Mass (Weight):



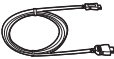

Approx. 115 g (Approx. 0.25 lbs.)

Specifications may change without prior notice.

Optional accessories

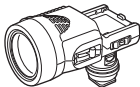
Accessory No.	Figure	Description
VW-BC20PP		Battery charger
VW-VBN130*1		Rechargeable Lithium Ion Battery Pack
VW-VBN260*1		Rechargeable Lithium Ion Battery Pack
RP-CDHM15 RP-CDHM30		HDMI mini cable
VW-W4607H		Wide conversion lens
VW-WE08H*2		Wide end conversion lens
VW-CLT1		3D Conversion Lens
VW-LF46N*3		Filter kit

- *1 Please refer to page 23, concerning the battery charging time and available recording time.
- *2 When using the VW-WE08H, set the zoom to W (wide) side. The focus will be slightly out when it is set to T (tele) side, so remove the VW-WE08H when recording set to T (tele) side.
- *3 When using the VW-LF46N, remove the lens hood (supplied) and set to the flash setting to  ([OFF]).

Accessory No.	Figure	Description
VW-LDC103PP*4		Video DC Light
VZ-LL10PP		Light bulb for video DC light
VW-SK12PP		Shoe adaptor
RP-SDN16GU1A RP-SDN08GU1A RP-SDN04GU1A RP-SDN02GU1A		Class 4 16 GB SDHC Memory Card Class 4 8 GB SDHC Memory Card Class 4 4 GB SDHC Memory Card Class 4 2 GB SD Memory Card
RP-SDW64GU1K RP-SDW48GU1K RP-SDW32GU1K RP-SDW16GU1K RP-SDW08GU1K RP-SDW04GU1K		Class 10 64 GB SDXC Memory Card Class 10 48 GB SDXC Memory Card Class 10 32 GB SDHC Memory Card Class 10 16 GB SDHC Memory Card Class 10 8 GB SDHC Memory Card Class 10 4 GB SDHC Memory Card
VW-BN01		DVD burner

*4 To use the VW-LDC103PP, the battery pack/VW-VBG130, VW-VBG260 is required. To charge the battery pack/VW-VBG130, VW-VBG260, the AC adaptor/VW-AD21PP-K, VW-AD20PP-K is required.

NOTE:

Accessories and/or model numbers may vary by country. Please consult your local dealer.

Product numbers correct as of Dec. 2010. These may be subject to change.

■ Attaching the optional accessories on the shoe adaptor

HDC-TM900

- 1 Open the shoe adaptor cover.



- 2 Attach the shoe adaptor to this unit.

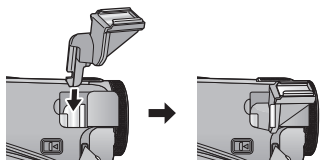

- When removing the shoe adaptor, slide the SHOE ADAPTOR RELEASE lever, and remove the shoe adaptor while sliding the lever.

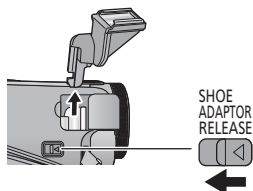

HDC-HS900

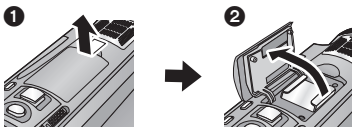

■ Attaching the conversion lens/ filter kit

Attach the wide conversion lens (VW-W4607H; optional), the wide end conversion lens (VW-WE08H; optional), ND filter or MC protector of the Filter kit (VW-LF46N; optional) in front of the lens.

- It is not possible to attach it to the front of the lens hood. (→ 33)
- You will not be able to use the flash. Set the flash setting to  ([OFF]). (→ 63)

Be careful about the following.

When 2 lens accessories, such as the ND filter and wide conversion lens, are fitted and the zoom lever is pressed toward the W side, the 4 corners of an image will be darkened. (Vignetting)

Attaching the lens cap of the Filter Kit (VW-LF46N; optional)

- When the filter kit (VW-LF46N; optional) is used, protect the lens surface while the unit is not used with the lens cap supplied with the filter kit.

Accessory Order Form (For USA and Puerto Rico Customers)

Please photocopy this form when placing an order.

1. Model # _____
 2. Items Ordered

Accessory #	Description	Price Each	Quantity	Total Price
Subtotal				
Your State & Local Sales Tax				
Shipping & Handling				6.95
Total Enclosed				

3. Method of payment (check one)

- Check of Money Order enclosed (NO C.O.D.SHIPMENTS)
 VISA Credit Card # _____
 MasterCard Expiration Date _____
 Discover Customer Signature _____

Make Check or Money Order Payable to: PANASONIC ACCESSORIES

(Please do not send cash)

4. Shipping information (UPS delivery requires complete street address)

Ship To:

Mr.

Mrs.

Ms. _____

First Last

Phone#:

Day () _____

Street Address

Night () _____

City State Zip

TO OBTAIN ANY OF OUR ACCESSORIES YOU CAN DO ANY OF
 THE FOLLOWING:
 VISIT YOUR LOCAL PANASONIC DEALER
 OR
 CALL PANASONIC'S ACCESSORY ORDER LINE AT 1-800-332-5368
 [6 AM-6 PM M-F, PACIFIC TIME]
 OR
 MAIL THIS ORDER TO: PANASONIC SERVICE AND TECHNOLOGY COMPANY ACCESSORY ORDER OFFICE
 20421 84th Avenue South Kent, WA. 98032

In CANADA, please contact your local Panasonic dealer for more information on Accessories.

Limited Warranty (ONLY FOR U.S.A. AND PUERTO RICO)

**Panasonic Consumer Electronics Company,
Division of Panasonic Corporation of North America**
One Panasonic Way, Secaucus, New Jersey 07094

Panasonic Camcorder Products Limited Warranty

Limited Warranty Coverage (For USA and Puerto Rico Only)

If your product does not work properly because of a defect in materials or workmanship, Panasonic Consumer Electronics Company (referred to as "the warrantor") will, for the length of the period indicated on the chart below, which starts with the date of original purchase ("warranty period"), at its option either (a) repair your product with new or refurbished parts, (b) replace it with a new or a refurbished equivalent value product, or (c) refund your purchase price. The decision to repair, replace or refund will be made by the warrantor.

Product or Part Name	Parts	Labor
Camcorder	1 year	90 days
Rechargeable Batteries (defective exchange)	10 days	Not Applicable
SD Memory Cards (defective exchange)	90 days	Not Applicable

During the "Labor" warranty period there will be no charge for labor. During the "Parts" warranty period, there will be no charge for parts. This Limited Warranty excludes both parts and labor for non-rechargeable batteries, antennas, and cosmetic parts (cabinet). This warranty only applies to products purchased and serviced in the United States or Puerto Rico. This warranty is extended only to the original purchaser of a new product which was not sold "as is".

Carry-In or Mail-In Service

To find a service center please visit <http://www.panasonic.com/help> or call 1-800-211-PANA (7262).

When shipping the unit, carefully pack, include all accessories, and send it prepaid, adequately insured and preferably in the original carton. If Lithium Ion batteries are shipped by air the package must be labeled "Contains Lithium Ion Battery (No lithium metal)". Damaged batteries are prohibited from shipment by US Mail. Batteries must be securely packed in a manner to prevent short-circuiting and a package cannot contain more than 3 Lithium Ion batteries. Include a letter detailing the complaint, a return address and provide a daytime phone number where you can be reached. A valid registered receipt is required under the Limited Warranty.

IF REPAIR IS NEEDED DURING THE WARRANTY PERIOD, THE PURCHASER WILL BE REQUIRED TO FURNISH A SALES RECEIPT/PROOF OF PURCHASE INDICATING DATE OF PURCHASE, AMOUNT PAID AND PLACE OF PURCHASE. CUSTOMER WILL BE CHARGED FOR THE REPAIR OF ANY UNIT RECEIVED WITHOUT SUCH PROOF OF PURCHASE.

Limited Warranty Limits And Exclusions

This warranty ONLY COVERS failures due to defects in materials or workmanship, and DOES NOT COVER normal wear and tear or cosmetic damage. The warranty ALSO DOES NOT COVER damages which occurred in shipment, or failures which are caused by products not supplied by the warrantor, or failures which result from accidents, misuse, abuse, neglect, mishandling, misapplication, alteration, faulty installation, set-up adjustments, misadjustment of consumer controls, improper maintenance, power line surge, lightning damage, modification, introduction of sand, humidity or liquids, commercial use such as hotel, office, restaurant, or other business or rental use of the product, or service by anyone other than a Factory Service Center or other Authorized Servicer, or damage that is attributable to acts of God.

THERE ARE NO EXPRESS WARRANTIES EXCEPT AS LISTED UNDER "LIMITED WARRANTY COVERAGE".

THE WARRANTOR IS NOT LIABLE FOR INCIDENTAL OR CONSEQUENTIAL DAMAGES RESULTING FROM THE USE OF THIS PRODUCT, OR ARISING OUT OF ANY BREACH OF THIS WARRANTY.

(As examples, this excludes damages for lost time, travel to and from the servicer, loss of or damage to media or images, data or other memory or recorded content. The items listed are not exclusive, but for illustration only.)

ALL EXPRESS AND IMPLIED WARRANTIES, INCLUDING THE WARRANTY OF MERCHANTABILITY, ARE LIMITED TO THE PERIOD OF THE LIMITED WARRANTY.

Some states do not allow the exclusion or limitation of incidental or consequential damages, or limitations on how long an implied warranty lasts, so the exclusions may not apply to you.

This warranty gives you specific legal rights and you may also have other rights which vary from state to state. If a problem with this product develops during or after the warranty period, you may contact your dealer or Service Center. If the problem is not handled to your satisfaction, then write to the warrantor's Consumer Affairs Department at the addresses listed for the warrantor.

PARTS AND SERVICE, WHICH ARE NOT COVERED BY THIS LIMITED WARRANTY, ARE YOUR RESPONSIBILITY.

Customer Services Directory (United States and Puerto Rico)

Obtain Product Information and Operating Assistance; locate your nearest Dealer or Service Center; purchase Parts and Accessories; or make Customer Service and Literature requests by visiting our Web Site at:

<http://www.panasonic.com/help>

or, contact us via the web at:

<http://www.panasonic.com/contactinfo>

You may also contact us directly at:

1-800-211-PANA (7262)

Monday-Friday 9am-9pm, Saturday-Sunday 10am-7pm EST

For hearing or speech impaired TTY users, TTY: 1-877-833-8855

Accessory Purchases (United States and Puerto Rico)

Purchase Parts, Accessories and Instruction Books online for all Panasonic Products by visiting our Web Site at:

<http://www.pstc.panasonic.com>

Or, send your request by E-mail to:

npcparts@us.panasonic.com

You may also contact us directly at:

1-800-332-5368 (Phone) 1-800-237-9080 (Fax Only)

(Monday-Friday 9am-9pm EST)

Panasonic Service and Technology Company

20421 84th Avenue South, Kent, WA 98032

(We accept Visa, MasterCard, Discover Card, American Express, and Personal Checks)

For hearing or speech impaired TTY users, TTY: 1-866-605-1277

As of November 2009

Warranty (For Canadian Customers)

Panasonic Canada Inc.

5770 Ambler Drive, Mississauga, Ontario L4W 2T3

PANASONIC PRODUCT – LIMITED WARRANTY

Panasonic Canada Inc. warrants this product to be free from defects in material and workmanship under normal use and for a period as stated below from the date of original purchase agrees to, at its option either (a) repair your product with new or refurbished parts, (b) replace it with a new or a refurbished equivalent value product, or (c) refund your purchase price. The decision to repair, replace or refund will be made by Panasonic Canada Inc.

Camcorder Products - One (1) year, parts and labour

This warranty is given only to the original purchaser, or the person for whom it was purchased as a gift, of a Panasonic brand product mentioned above sold by an authorized Panasonic dealer in Canada and purchased and used in Canada, which product was not sold "as is", and which product was delivered to you in new condition in the original packaging.

IN ORDER TO BE ELIGIBLE TO RECEIVE WARRANTY SERVICE HEREUNDER, A PURCHASE RECEIPT OR OTHER PROOF OF DATE OF ORIGINAL PURCHASE, SHOWING AMOUNT PAID AND PLACE OF PURCHASE IS REQUIRED

LIMITATIONS AND EXCLUSIONS

This warranty ONLY COVERS failures due to defects in materials or workmanship, and DOES NOT COVER normal wear and tear or cosmetic damage. The warranty ALSO DOES NOT COVER damages which occurred in shipment, or failures which are caused by products not supplied by Panasonic Canada Inc., or failures which result from accidents, misuse, abuse, neglect, mishandling, misapplication, alteration, faulty installation, set-up adjustments, misadjustment of consumer controls, improper maintenance, improper batteries, power line surge, lightning damage, modification, introduction of sand, humidity or liquids, commercial use such as hotel, office, restaurant, or other business or rental use of the product, or service by anyone other than an Authorized Servicer, or damage that is attributable to acts of God.

Dry cell batteries are also excluded from coverage under this warranty. Rechargeable batteries are warranted for ninety (90) days from date of original purchase.

THIS EXPRESS, LIMITED WARRANTY IS IN LIEU OF ALL OTHER WARRANTIES, EXPRESS OR IMPLIED, INCLUDING ANY IMPLIED WARRANTIES OF MERCHANTABILITY AND FITNESS FOR A PARTICULAR PURPOSE. IN NO EVENT WILL PANASONIC CANADA INC. BE LIABLE FOR ANY SPECIAL, INDIRECT OR CONSEQUENTIAL DAMAGES RESULTING FROM THE USE OF THIS PRODUCT OR ARISING OUT OF ANY BREACH OF ANY EXPRESS OR IMPLIED WARRANTY. (As examples, this warranty excludes damages for lost time, travel to and from the Authorized Servicer, loss of or damage to media or images, data or other memory or recorded content. This list of items is not exhaustive, but for illustration only.)

In certain instances, some jurisdictions do not allow the exclusion or limitation of incidental or consequential damages, or the exclusion of implied warranties, so the above limitations and exclusions may not be applicable. This warranty gives you specific legal rights and you may have other rights which vary depending on your province or territory.

WARRANTY SERVICE

For product operation and information assistance, please contact:

Our Customer Care Centre: Telephone: 1-800-995-8649
Fax #: (905) 238-2360
Email link: camcorderconciierge@ca.panasonic.com

For defective product exchange within the warranty period, please contact the original dealer or our Customer Care Centre.

Index

■ Numerics

1080/60p	8
1080/60p recording	57
3D playback/viewing	109, 151
3D recording	86, 151
5.1 channel	106

■ A

AC adaptor	22, 150
Accessory shoe	20
AF assist lamp	81
AF/AE tracking	59
Alert sound	49
Approximate number of recordable pictures	156
Aspect ratio	79
Auto focus	40
Auto Ground-Directional Standby (AGS)	73
Auto protect	118
Auto slow shutter (2D)	72
Auto slow shutter (3D)	73
Automatic face framing	72
Automatic white balance	40
AV multi connector	17, 103, 122
AV multi connector output	106
AVCHD	8

■ B

Backlight compensation	64
Bass setting	76
Battery	21, 149
Battery capacity indication	25
Built-in memory	8

■ C

Cancel protect	118
Card	26
Changing the display style	47
Charging time	23
Cleaning	148
Color night rec function	65
Component out	106
Component terminal	103
Conversion Assist Function	126
Copy	
Disc	115
Dubbing	119, 122
Dubbing (3D)	124
From built-in memory to SD card	111
From HDD to SD card	111
From SD card to built-in memory	111
From SD card to HDD	111
Creating still picture from motion picture	90

■ D

Date and time display	47
Date and time setting	31

Delete	96
Deleting personal information	99
Demo mode	52
Digital cinema	68
Digital cinema color	73
Digital zoom	67
Direct playback	90
Disc status	118
Divide	97
DPOF setting	100
DVD burner	113

■ E

Economy	47
Extra optical zoom	55
Eyepiece corrector dial	33

■ F

Face recognition	69
Face-to-face recording	33
Fade	62
Fade color	62
Flash	63
Flash level	63
Focus	37, 85
Focus microphone	74
Format disc	118
Formatting	51, 118
Frame-by-frame playback	89

■ G

Gain	84
Grip belt	19
Guide display	44
Guideline	65

■ H

HD Writer AE 3.0	125, 136
HDD	8
HDMI mini connector	17, 103, 107
HDMI resolution	106
Headphone terminal	19
Headphone volume adjustment	65
Highlight playback	93
Highlight&Time frame index	90
Hi-speed burst shooting mode	80
Histogram	77
HYBRID O.I.S.	56

■ I

i.Zoom	67
iFrame	8
Image stabilizer function	56
Indications	138
Initial setting	50
Intelligent auto mode	39
Intelligent contrast control	62
Intelligent exposure	64
Interval recording	68
Iris	84

■ L		
Language	52	
LCD monitor	18, 33, 152	
LCD set	49	
Lens cap	165	
Lens hood	33	
Limited Warranty (Canada)	169	
Limited Warranty (USA and Puerto Rico)	167	
Luminance	77	
■ M		
Manual focus	85	
Manual recording	82	
Media select	34	
Media status	51	
Menu	30, 44	
MF assist	85	
Microphone level	75	
Microphone setup	74	
Microphone terminal	19	
Mode switch	29	
Motion picture compatibility	43	
Multi manual ring	85	
■ N		
Name display	72	
Number reset	50	
■ O		
O.I.S. LOCK	60	
Operation icons	61	
Optical image stabilizer demo	52	
■ P		
Picture adjustment	76	
Picture quality	79	
Picture size	78	
Playback Operations	89	
Playback zoom	91	
Playing back motion pictures by date	92	
Power button	28	
Power LCD	49	
PRE-REC	62	
Protect	99	
■ Q		
Quick menu	45	
Quick power on	48	
Quick start	48	
■ R		
Recordable time	23, 155	
Recording format	8, 67	
Recording lamp	49	
Recording modes	67	
Recording time elapsed	35	
Recovery	142	
Red-eye reduction	64	
Relay information canceling	102	
Relay recording	69	
Relay scene combining	101	
Remaining number of still pictures	38	
Remaining time left for recording	35	
Remote control	48, 53	
Repeat playback	91	
Resume playback	91	
Ring zoom	55	
■ S		
Scene mode	66	
Scene protect	99	
SD Memory Card	26	
SD Speed Class Rating	26	
SDHC Memory Card	26	
SDXC Memory Card	26	
Self-timer recording	64	
Shoe adaptor	20, 165	
Shooting guide	74	
Shoulder strap fixture	19	
Shutter sound	81	
Shutter speed	84	
Simultaneous recording	38	
Skip playback	89	
Slide show	42, 95	
Slow-motion playback	89	
Smile shot	63	
Soft skin mode	64	
Stereo microphone	74	
Still picture compatibility	43	
Stylus pen	29, 52	
Sub recording start/stop button	32	
Surround microphone	74	
■ T		
Tele macro	65	
Touch Menu	30	
Touch screen	29	
Touch screen calibration	52	
Touch Shutter	60	
Touch Zoom	58	
Tripod receptacle	18	
TV aspect	105	
■ V		
Video DC Light	164	
VIERA Link	107	
Viewfinder	18, 33, 50, 152	
Volume adjustment	43	
■ W		
White balance	83	
Wind noise canceler	74	
World time setting	46	
■ Z		
Zebra	76	
Zoom	55	
Zoom microphone	74	
Zoom mode	67	

Spanish Quick Use Guide/Guía española para el uso rápido

■ Insertar la batería

Meta la batería insertándola en la dirección señalada en la figura.

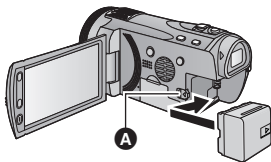

- A** Introduzca la batería hasta que haga clic y se cierre.

■ Carga de la batería

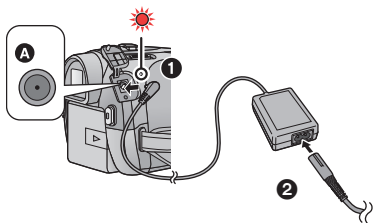

- A** Terminal de entrada de CC
- 1** Conecte el adaptador de CA al terminal de entrada de CC.
- 2** Conecte el cable de CA al adaptador de CA, luego a la toma de CA.
- El indicador de estado parpadeará de color rojo en un intervalo de 2 segundos, indicando que comenzó la carga. Se apagará cuando se completa la carga.

■ Insertar/extraer una tarjeta SD

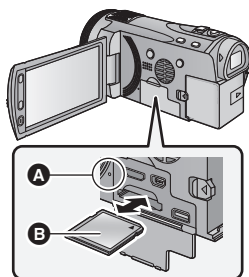

Testigo de acceso [ACCESS] **A**

- Cuando el dispositivo accede a la tarjeta SD o a la memoria integrada, se enciende el testigo de acceso.

- 1) Abra la pantalla LCD.
 - 2) Abra la tapa de la tarjeta SD/terminal e introduzca (retire) la tarjeta SD en (desde) la ranura correspondiente.
 - 3) Cierre de forma segura la tapa de la tarjeta SD/terminal.
- Oriente el lado de la etiqueta **B** en la dirección mostrada en la ilustración e introdúzcalo hasta el fondo.
 - Presione el centro de la tarjeta SD, luego sáquela recta.
 - Presione el centro de la tarjeta SD, luego sáquela recta.
 - Ciérrela firmemente hasta que haga clic.
 - Ciérrela firmemente hasta que haga clic.

■ Encender/apagar el dispositivo

Encender y apagar el dispositivo con el botón de alimentación

Pulse el botón de alimentación para encender el dispositivo.

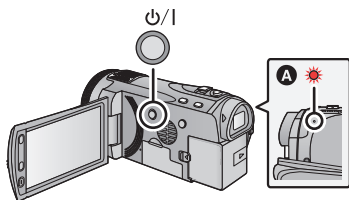

- A El indicador de estado se ilumina.
- Para apagar la unidad, mantenga pulsado el botón de alimentación hasta que el indicador de estado se apague.

Cómo encender y apagar la unidad con el monitor LCD/visor

Al abrir el monitor LCD o extender el visor se enciende el dispositivo. Al cerrar el monitor LCD/visor se apaga.

Para encender el dispositivo

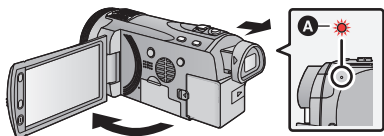

- A El indicador de estado se ilumina.

Para apagar el dispositivo

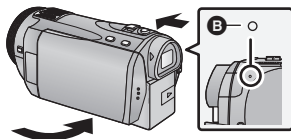



- B El indicador de estado se apaga.

■ Selección del modo

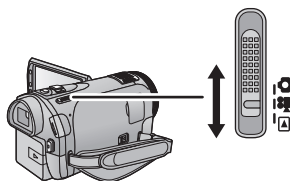
Utilizando el selector de modo, cambie el modo a ,  o .



	Modo de grabación de películas (→ 35)
	Modo de grabación de fotografías (→ 37)
	Modo de reproducción (→ 41, 89)

■ Cómo usar la pantalla táctil

Puede actuar directamente tocando el monitor LCD (pantalla táctil) con el dedo. Es más sencillo utilizar el lápiz electrónico (suministrado) para operaciones detalladas o bien si es difícil de actuar con los dedos.

Toque

Toque y suelte la pantalla táctil para seleccionar el icono o la imagen.

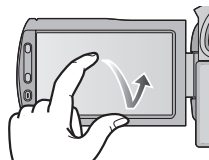

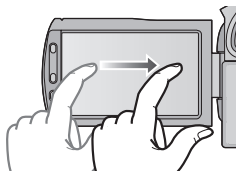

Deslice mientras toca

Mueva el dedo mientras pulsa la pantalla táctil.



Menú táctil

Toque  para visualizar el menú de deslizamiento.

Toque ◀ (lado izquierdo)/ ▶ (lado derecho) de  en el menú táctil para cambiar los iconos de operación.

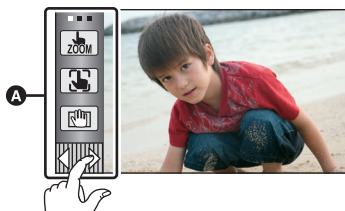



A Menú táctil

■ Selección del idioma

- 1) Toque [MENU], luego toque [CONFIGURAR] → [LANGUAGE].
- 2) Toque el idioma deseado.

■ Seleccionar un medio para grabar

- 1) Cambie el modo a  o a .
- 2) Seleccione el menú.



MENU : [SELEC MEDIO]

- 3) Toque el medio para grabar las películas o fotografías.
 - Toque [VÍDEO/TARJETA SD] o [IMAGEN/TARJETA SD] para grabar en la tarjeta SD.
HDC-TM900
 - Toque [VÍDEO/MEM INTERNA] o [IMAGEN/MEM INTERNA] para grabar en la memoria integrada.
HDC-HS900
 - Toque [VÍDEO/DISCO DURO] o [IMAGEN/DISCO DURO] para grabar en la HDD.
 - El medio se selecciona de forma separada para las películas o fotografías y se resalta en amarillo.
- 4) Toque [ENTRAR].

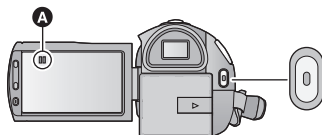

■ Grabación de películas

- 1) Cambie el modo a .
- 2) Abra el monitor LCD o extienda el visor.
- 3) Pulse el botón de inicio/parada de grabación para iniciar la grabación.



A Cuando comienza a grabar,  cambia a .

■ Grabación de películas

- 1) Cambie el modo a .
- 2) Abra el monitor LCD o extienda el visor.
- 3) Para tomar una imagen pulse el botón  a tope.

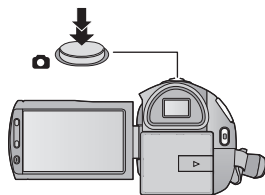

■ Reproducción de película/ fotografía



- 1) Cambie el modo a .
- 2) Toque el icono de selección del modo de reproducción **A**.



- 3) Seleccione el [SOPORTE] y [VIDEO/ FOTO] que desea reproducir.
 - Toque [ENTRAR].
- 4) Toque la escena o la fotografía que desea reproducir.



- B** **[1080/60p]** se visualiza cuando se toca **[1080/60p]**, **[AVCHD]** se visualiza cuando se toca **[AVCHD]**, o **[iFrame]** se visualiza cuando se toca **[iFrame]** en el paso 3.

- Para visualizar la siguiente (anterior) página:
 - Deslice la vista en miniatura hacia arriba (hacia abajo) mientras la toca.
 - Cambie el menú táctil y luego toque  (arriba)/  (abajo) en la barra de desplazamiento de la miniatura.
- 5) Seleccione la operación de reproducción tocando el icono de operación.

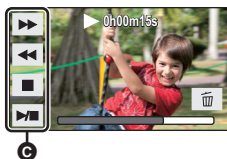

- C** Icono de funcionamiento

- Los iconos de operación y la visualización de la pantalla desaparecerán cuando no se realiza una función por un período específico de tiempo. Para volver a visualizarla, toque la pantalla.

(Reproducción de películas)

- ▶/||: Reproducción/Pausa
- ◀◀: Rebobinado (durante la reproducción)
- ▶▶: Avance rápido (durante la reproducción)
- : Detener la reproducción y visualizar las miniaturas.

(Reproducción de fotografías)

- ▶/||: Iniciar o hacer una pausa en la presentación de diapositivas (reproducción de las fotografías que contiene en orden numérico).
- ◀||: Reproducción de la imagen anterior.
- ||▶: Reproducción de la siguiente imagen.
- : Detener la reproducción y visualizar las miniaturas.

Panasonic Consumer Electronics Company,
Division of Panasonic Corporation of North America
One Panasonic Way, Secaucus, NJ 07094

Panasonic Canada Inc.
5770 Ambler Drive, Mississauga, Ontario, L4W 2T3



VQT3K69
F1210KK0 (2800 (A))



© Panasonic Corporation 2011
Printed in Japan