

Panasonic®

Owner's Manual High Definition Video Camera

Model No. **HC-V720**
HC-V720M
HC-V710

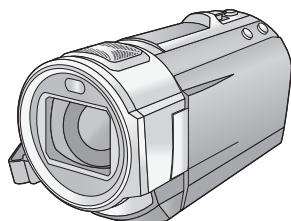

Please read these instructions carefully before using this product, and save this manual for future use.

AVCHD™
Progressive

HDMI



DOLBY
DIGITAL

DLNA
CERTIFIED™

WiFi
CERTIFIED



Register online at www.panasonic.com/register (U.S. customers only)

VQT4Q88

Read this first

■ About the recording format for recording motion pictures

You can record motion pictures in either AVCHD*1 or iFrame recording formats using this unit. (→ 63)

*1 It is compatible with the AVCHD Progressive (1080/60p).

AVCHD:

It is suitable for viewing on a high-definition TV or for saving to disc*2.

*2 To save an image recorded in 1080/60p, it is required to copy to a disc using the supplied software HD Writer AE 5.0.

iFrame:

This is a recording format suitable for viewing and editing on a Mac (iMovie'11).

- It is not compatible with motion pictures recorded in AVCHD format.

■ Indemnity about recorded content

Panasonic does not accept any responsibility for damages directly or indirectly due to any type of problems that result in loss of recording or edited content, and does not guarantee any content if recording or editing does not work properly. Likewise, the above also applies in a case where any type of repair is made to the unit (including any other non-built-in memory related component).

■ Handling of built-in memory [HC-V720M]

This unit is equipped with the built-in memory. When using this component, pay attention to the following points.

Back up data periodically.

The built-in memory is temporary storage. In order to avoid erasing data due to static electricity, electromagnetic waves, breakage, and failures, back up the data to a PC or DVD disc. (→ 157)

- Access lamp [ACCESS] (→ 7) illuminates while the SD card or built-in memory is being accessed (initialization, recording, playback, deleting etc.). Do not perform the following operations when the lamp illuminates. It may damage the built-in memory or cause a malfunction in the unit.
 - Turn the unit off (remove the battery)
 - Insert and remove the USB cable
 - Expose the unit to vibrations or shock
- About disposing of or giving away this unit. (→ 183)

■ About Condensation (When the lens or the LCD monitor is fogged up)

Condensation occurs when there is a change in temperature or humidity, such as when the unit is taken from outside or a cold room to a warm room. Please be careful, as it may cause the lens or LCD monitor to become soiled, moldy, or damaged.





When taking the unit to a place which has a different temperature, if the unit is accustomed to the room temperature of the destination for about one hour, condensation can be prevented. (When the difference in temperature is severe, place the unit in a plastic bag or the like, remove air from the bag, and seal the bag.) When condensation has occurred, remove the battery and/or the AC adapter and leave the unit like that for about one hour. When the unit becomes accustomed to the surrounding temperature, fogging will disappear naturally.

■ Cards that you can use with this unit

SD Memory Card, SDHC Memory Card and SDXC Memory Card

- 4 GB or more Memory Cards that do not have the SDHC logo or 48 GB or more Memory Cards that do not have the SDXC logo are not based on SD Memory Card Specifications.
- Refer to page 13 for more details on SD cards.

■ For the purposes of this owner's manual

- SD Memory Card, SDHC Memory Card and SDXC Memory Card are referred to as the "SD card".
- Function that can be used for Motion Picture Recording Mode: 
- Function that can be used for Still Picture Recording Mode: 
- Function that can be used for the Playback Mode: 
- Function that can be used for the Playback Mode (motion pictures only): 
- Function that can be used for the Playback Mode (still pictures only): 
- Scene(s) recorded in 1080/60p or 1080/60i: "AVCHD scene(s)"
- Pages for reference are indicated by an arrow, for example: → 00

This owner's manual is designed for use with models **HC-V720**, **HC-V720M**, and **HC-V710**. Pictures may be slightly different from the original.

- The illustrations used in this owner's manual show model **HC-V720**, however, parts of the explanation refer to different models.
- Depending on the model, some functions are not available.
- **HC-V720** and **HC-V720M** are equipped with the Wi-Fi® function.
- Features may vary, so please read carefully.
- Not all models may be available depending on the region of purchase.

Contents

Read this first	2
-----------------------	---

Preparation

Names and Functions of Main Parts	6
Power supply	10
Inserting/removing the battery	10
Charging the battery	11
Charging and recording time	12
Recording to a card	13
Cards that you can use with this unit	13
Inserting/removing an SD card	14
Turning the unit on/off	15
Selecting a mode	16
How to use the touch screen	16
About the Touch Menu	17
Setting date and time	18

Basic

Before recording	19
Selecting a media to record	
[HC-V720M]	20
Recording motion pictures	21
Recording still pictures	23
Recording still pictures in	
Motion Picture Recording Mode	24
Intelligent Auto Mode	25
Motion picture/Still picture playback	27
Using the menu screen	30
Using the Setup Menu	31

Advanced (Recording)

Using the zoom	40
Zoom ratio during the Still Picture	
Recording Mode	40
Image Stabilizer Function	41
Changing the Recording Mode	42
Intelligent Auto Plus	43
Creative Control	43
Scene Mode	46
Manual recording	48
White Balance	49
Manual shutter speed/	
iris adjustment	50
Manual Focus adjustment	51

Recording with the Touch Function	52
Touch function icons	52
Recording functions of	
operation icons	56
Operation icons	56
Recording functions of menus	62

Advanced (Playback)

Playback Operations	78
Motion picture playback using	
operation icon	78
Creating still picture from	
motion picture	79
Highlight & Time Frame Index	80
Repeat Playback	80
Resuming the previous playback	81
Zooming in on a still picture	
during playback (Playback zoom)	81
Various playback functions	82
Playing back motion pictures/	
still pictures by date	82
Highlight Playback	83
Changing the playback settings and	
playing back the slide show	89
Deleting scenes/still pictures	91
Deleting part of a scene (AVCHD)	93
Dividing a scene (AVCHD)	94
Dividing a scene to partially delete	
(iFrame/MP4)	95
Deleting personal information	96
Protecting scenes/still pictures	96
Convert to MP4	97
Relay scene combining [HC-V720M]	98
Watching Video/Pictures on your TV	100
Connecting with a HDMI mini cable	102
Listening in 5.1 channel sound	
(AVCHD)	102
Playback using VIERA Link™	103
Converting and playing back	
2D images as 3D	105

Copy/Dubbing

Copying between SD card and Built-in Memory [HC-V720M]	106
Copying/playing back with a USB HDD	109
Preparing for copying/playing back	109
Simple copy	112
Copy selected files	112
Playing back the USB HDD	113
Dubbing with a Blu-ray disc recorder, video device, etc.	114
Using the Eye-Fi™ card.....	118

Wi-Fi [HC-V720]/[HC-V720M]

Wi-Fi® function	121
What you can do with the Wi-Fi function and the preparations	123
Connecting to Wi-Fi	128
Connecting to a wireless access point.....	128
Connecting to a smartphone	133
Recording/playing back with Link to Cell operations	137
DLNA Play.....	142
Live Cast.....	143
Home Cam (Home Monitor).....	147
How to Use the [Wi-Fi Setup] Menu	151

With a PC

What you can do with a PC	157
End User License Agreement	159
Operating environment.....	161
Installation	164
Connecting to a PC	165
About the PC display	167
Starting HD Writer AE 5.0	168
Reading the operating instructions of the software applications	168
If using Mac	169

Others

Indications	170
Messages	173
About recovery.....	174
Troubleshooting	175
Cautions for use.....	182
About copyright	187
Recording modes/approximate recordable time	189
Approximate number of recordable pictures.....	190
Optional accessories	191

Names and Functions of Main Parts

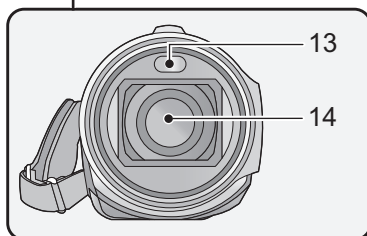
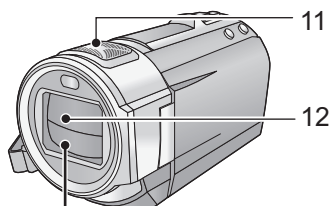
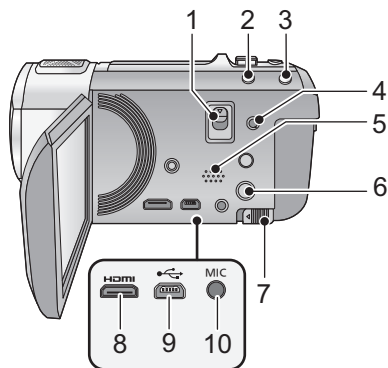



- 1 Shoe adaptor release lever [SHOE ADAPTOR RELEASE] (→ 191)
- 2 Intelligent auto button [iA] (→ 25)
- 3 Optical Image Stabilizer button [(((hand))) O.I.S.] (→ 41)
- 4 A/V connector [A/V] (→ 100, 117)
- 5 Speaker
- 6 Power button [⏻/⏺] (→ 15)
- 7 Battery release lever [BATT] (→ 10)
- 8 HDMI mini connector [HDMI] (→ 100)
- 9 USB terminal [⏻] (→ 109, 115, 165)
- 10 Microphone terminal [MIC]

- A compatible plug-in powered microphone can be used as an external microphone.
- □□□■ (Microphone input level meter) is displayed when the external microphone is connected. (→ 72)
- When the unit is connected with the AC adaptor, sometimes noise may be heard depending on the microphone type. In this case, please switch to the battery for the power supply and the noise will stop.

- 11 Internal microphones

- 12 Lens cover

- The lens cover opens in  Motion Picture Recording Mode or  Still Picture Recording Mode. (→ 16)

- 13 Built-in flash/Video light (→ 59, 61, 77)

- 14 Lens

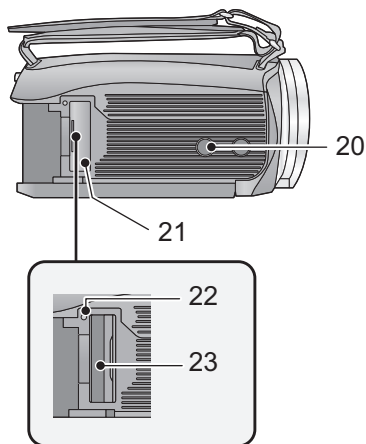
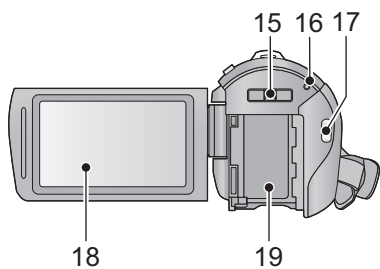

- 15 Shoe adaptor mounting part [SHOE ADAPTOR] (→ 191)
- 16 Status indicator (→ 15, 128)
- 17 Recording start/stop button (→ 21)
- 18 LCD monitor (Touch screen) (→ 16)

- 20 Tripod receptacle
 - If you attach a tripod which has 5.5 mm (0.22 ") screw or larger, it may damage this unit.
- 21 SD card cover (→ 14)
- 22 Access lamp [ACCESS] (→ 14)
- 23 Card slot (→ 14)



- It can open up to 90°.

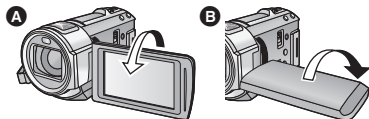

- It can rotate up to 180° **A** towards the lens or 90° **B** towards the opposite direction.

- 19 Battery holder (→ 10)

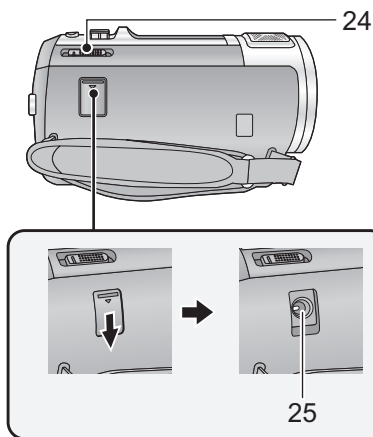

24 Mode switch (→ 16)

25 DC input terminal [DC IN] (→ 11)

- Do not use any other AC adaptors except the supplied one.

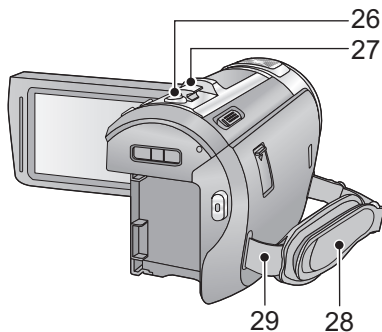

26 Photoshot button [] (→ 23)

27 Zoom lever [W/T] (In Motion Picture Recording Mode or Still Picture Recording Mode) (→ 40)

Thumbnail display switch [/]
Volume lever [-VOL+] (In Playback Mode) (→ 28)

28 Grip belt

Adjust the length of the grip belt so that it fits your hand.

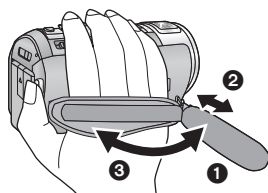

1 Flip the belt.

2 Adjust the length.

3 Replace the belt.

29 Shoulder strap fixture

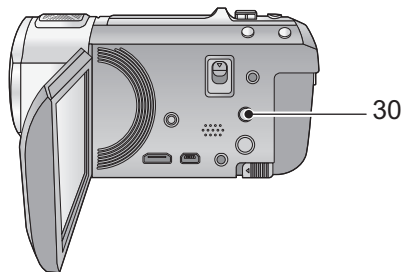

30 Wi-Fi button [Wi-Fi] (→ 128, 133, 138, 142, 143, 148, 151)

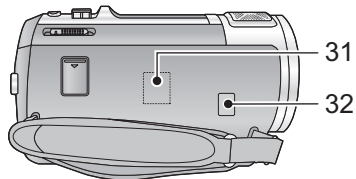

31 Wi-Fi Transmitter (→ 122)
32 NFC touch area (→ 137)

Power supply

■ About batteries that you can use with this unit

The battery that can be used with this unit is VW-VBT190/VW-VBT380.

- The unit has a function for distinguishing batteries which can be used safely. The dedicated battery (VW-VBT190/VW-VBT380) supports this function. The only batteries suitable for use with this unit are genuine Panasonic products and batteries manufactured by other companies and certified by Panasonic. Panasonic cannot in any way guarantee the quality, performance or safety of batteries which have been manufactured by other companies and are not genuine Panasonic products.

It has been found that counterfeit battery packs which look very similar to the genuine product are made available to purchase in some markets. Some of these battery packs are not adequately protected with internal protection to meet the requirements of appropriate safety standards. There is a possibility that these battery packs may lead to fire or explosion. Please be advised that we are not liable for any accident or failure occurring as a result of use of a counterfeit battery pack. To ensure that safe products are used we would recommend that a genuine Panasonic battery pack is used.

Inserting/removing the battery

- Press the power button to turn off the unit. (→ 15)

Install the battery by inserting it in the direction shown in the figure.

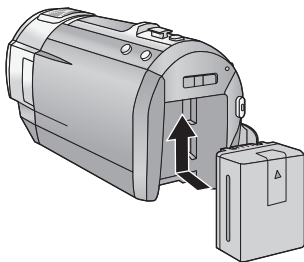

Insert the battery until it clicks and locks.

Removing the battery

Be sure to hold down the power button until the status indicator goes off. Then remove the battery while supporting the unit to prevent it from dropping.

Move the battery release lever in the direction indicated by the arrow and remove the battery when unlocked.

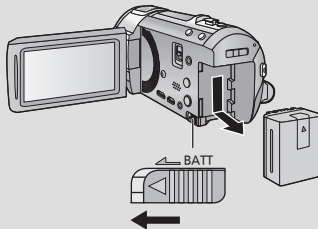

Charging the battery

When this unit is purchased, the battery is not charged. Charge the battery fully before using this unit for the first time.

The unit is in the standby condition when the AC adaptor is connected. The primary circuit is always "live" as long as the AC adaptor is connected to an electrical outlet.

Important:

- Use the supplied AC adaptor. Do not use the AC adaptor of another device.
- Do not use the AC cable with any other equipment as it is designed only for this unit. Also, do not use the AC cable from other equipment with this unit.
- The battery will not be charged if the unit is turned on.
- It is recommended to charge the battery in a temperature between 10 °C and 30 °C (50 °F and 86 °F). (The battery temperature should also be the same.)

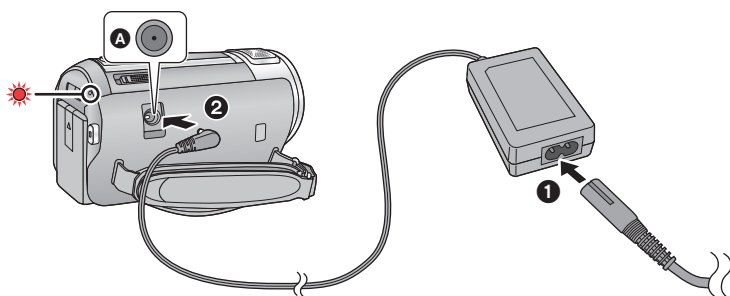

A DC input terminal

1 Connect the AC cable to the AC adaptor, then the AC outlet.

2 Connect the AC adaptor to the DC input terminal.

- The status indicator will flash red at an interval of 2 seconds (approximately 1 second on, 1 second off), indicating that charging has begun. It will turn off when the charging is completed.

■ Connecting to the AC outlet

It is possible to use this unit with power supplied from the AC outlet by turning on the unit with the AC adaptor connected.

When recording for a long time, keep the AC adaptor connected and use it together with the battery.

■ To charge by connecting to other device

It is possible to charge by connecting to other device with the USB cable (supplied). Please refer to page 166.

- If the status indicator flashes at a particularly fast or slow rate, refer to page 184.
- We recommend using Panasonic batteries (→ 12).

- If you use other batteries, we cannot guarantee the quality of this product.
- Do not heat or expose to flame.
- Do not leave the battery(ies) in a car exposed to direct sunlight for a long period of time with doors and windows closed.

Charging and recording time

■ Charging/Recording time







- Temperature: 25 °C (77 °F)/humidity: 60%RH
- Charging times in parentheses are when charging from the USB terminal.

Battery model number [Voltage/Capacity (minimum)]	Charging time	Recording mode	Maximum continuous recordable time	Actual recordable time
Supplied battery/ VW-VBT190 (optional) [3.6 V/1940 mAh]	2 h 20 min (5 h 20 min)	[1080/60p]	1 h 25 min	45 min
		[PH],[HA], [HG],[HE]	1 h 30 min	
		[iFrame]	1 h 40 min	50 min
VW-VBT380 (optional) [3.6 V/3880 mAh]	3 h 45 min (9 h 45 min)	[1080/60p]	3 h 5 min	1 h 35 min
		[PH]	3 h 10 min	1 h 40 min
		[HA],[HG], [HE]	3 h 15 min	
		[iFrame]	3 h 30 min	1 h 50 min

- These times are approximations.
- **The indicated charging time is for when the battery has been discharged completely. Charging time and recordable time vary depending on the usage conditions such as high/low temperature.**

- The actual recordable time refers to the recordable time when repeatedly starting/stopping recording, turning the unit on/off, moving the zoom lever etc.
- The batteries heat up after use or charging. This is not a malfunction.

Battery capacity indication

- The display changes as the battery capacity reduces.  →  →  →  → 
If there is less than 3 minutes remaining, then  will become red. If the battery discharges, then  will flash.
- Screen display will disappear when no touch operation is performed for a specific period of time. However, it will be constantly displayed when the remaining battery time becomes less than 30 minutes.
- The remaining battery capacity is displayed when using the Panasonic battery that you can use for this unit. The actual time can vary depending on your actual use.
- When using the AC adaptor or batteries made by other companies, the remaining battery capacity will not be shown.

Recording to a card

The unit can record still pictures or motion pictures to an SD card or built-in memory. To record to an SD card, read the following.

Cards that you can use with this unit

Use SD cards conforming to Class 4 or higher of the SD Speed Class Rating* for motion picture recording.

Card type	Capacity
SD Memory Card	512 MB/1 GB/2 GB
SDHC Memory Card	4 GB/6 GB/8 GB/12 GB/16 GB/24 GB/32 GB
SDXC Memory Card	48 GB/64 GB

* SD Speed Class Rating is the speed standard regarding continuous writing. Check via the label on the card, etc.

e.g.:



- Please check the latest information on the support website below.

http://panasonic.jp/support/global/cs/e_cam

(This website is in English only.)

- **When using an SDHC Memory Card/SDXC Memory Card with other equipment, check the equipment is compatible with these Memory Cards.**
- An Eye-Fi X2 series SD card is required to use functions related to Eye-Fi. (→ 118)
- We do not guarantee the operation of SD cards other than the ones above. Further, SD cards with a capacity of less than 32 MB cannot be used for motion picture recording.
- 4 GB or more Memory Cards that do not have the SDHC logo or 48 GB or more Memory Cards that do not have the SDXC logo are not based on SD Memory Card Specifications.
- When the write-protect switch **A** on SD card is locked, no recording, deletion or editing will be possible on the card.
- Keep the Memory Card out of reach of children to prevent swallowing.

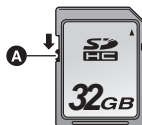

Inserting/removing an SD card

When using an SD card not from Panasonic, or one previously used on other equipment, for the first time on this unit, format the SD card. (→ 37) When the SD card is formatted, all of the recorded data is deleted. Once the data is deleted, it cannot be restored.

Caution:

Check that the access lamp has gone off.

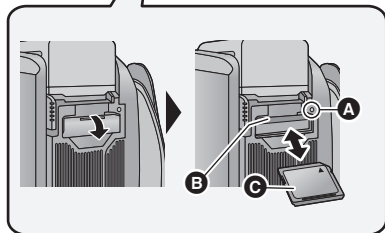
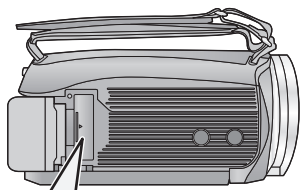

Access lamp [ACCESS] **A**

- When this unit is accessing the SD card or built-in memory, the access lamp lights up.

1 Open the SD card cover and insert (remove) the SD card into (from) the card slot **B**.

- Face the label side **C** in the direction shown in the illustration and press it straight in as far as it will go.
- Press the center of the SD card and then pull it straight out.

2 Securely close the SD card cover.

- Securely close it until it clicks.

- Do not touch the terminals on the back of the SD card.
- Do not apply strong shocks, bend, or drop the SD card.
- Electrical noise, static electricity or the failure of this unit or the SD card may damage or erase the data stored on the SD card.
- When the card access lamp is lit, do not:
 - Remove the SD card
 - Turn the unit off
 - Insert and remove the USB cable
 - Expose the unit to vibrations or shockPerforming the above while the lamp is on may result in damage to data/SD card or this unit.
- Do not expose the terminals of the SD card to water, dirt or dust.
- Do not place SD cards in the following areas:
 - In direct sunlight
 - In very dusty or humid areas
 - Near a heater
 - Locations susceptible to significant difference in temperature (condensation can occur.)
 - Where static electricity or electromagnetic waves occur
- To protect SD cards, return them to their cases when you are not using them.
- About disposing of or giving away the SD card. (→ 185)

Turning the unit on/off

You can turn the unit on and off using the power button or by opening and closing the LCD monitor.

Turning the unit on and off with the power button

Open the LCD monitor and press the power button to turn on the unit.

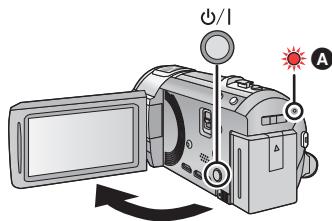

A The status indicator lights on.

To turn off the unit

Hold down the power button until the status indicator goes off.

Turning the unit on and off with the LCD monitor

The unit is turned on when the LCD monitor is opened, and unit is turned off when it is closed.



During normal use, opening and closing of the LCD monitor can be conveniently used to turn the unit on/off.

- The unit will not turn off while recording motion pictures even if the LCD monitor is closed.
- In the following cases, opening the LCD monitor does not turn on the unit. Press the power button to turn on the unit.
 - When the unit is originally purchased
 - When you have turned off the unit using the power button

Selecting a mode

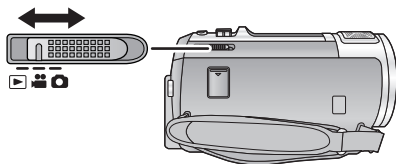
Operate the mode switch to change the mode to ,  or  .



	Motion Picture Recording Mode (→ 21)
	Still Picture Recording Mode (→ 23)
	Playback Mode (→ 27, 78)

How to use the touch screen

You can operate by directly touching the LCD monitor (touch screen) with your finger.

■ Touch

Touch and release the touch screen to select icon or picture.

- Touch the center of the icon.
- Touching the touch screen will not operate while you are touching another part of the touch screen.

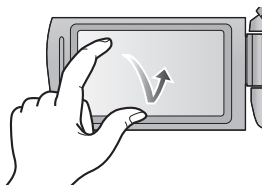

■ Slide while touching

Move your finger while pressing on the touch screen.

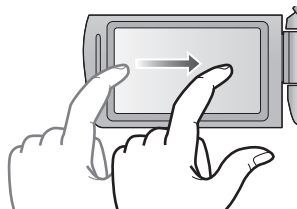

■ About the operation icons



Touch when changing a page or performing settings.



Touch to return to the previous screen.

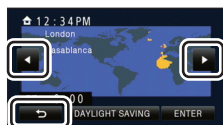

About the Touch Menu

Touch ◀ (left side)/▶ (right side) of  on the Touch Menu to switch the operation icons.

- It is also possible to switch the operation icons by sliding the Touch Menu right or left while touching it.

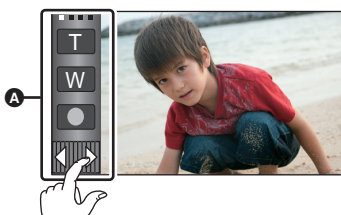

A Touch Menu

Recording Mode

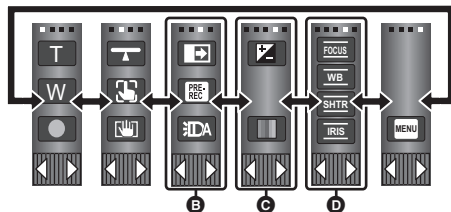

Playback Mode

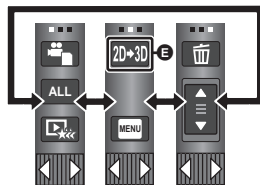

- B You can change the operation icons to display. (→ 35)
- C Displayed only in Intelligent Auto Plus Mode (→ 43) and [Miniature Effect]/[8mm movie]/[Silent movie] of the Creative Control Mode (→ 43).
- D Displayed only in [Time Lapse Rec] of the Creative Control Mode (→ 43), Scene Mode (→ 46) and Manual Mode (→ 48).
- E Displayed only when connected to a TV. (→ 105)

■ To display the Touch Menu



Display of the Touch Menu will disappear when no touch operation is performed for a specific period of time during recording of motion picture/still picture. To display it again, touch .

- Do not touch on the LCD monitor with hard pointed tips, such as ball point pens.

Preparation



Setting date and time

The clock is not set at the time of purchase. Make sure to set the clock.

1 Select the menu. (→ 30)

 : [SETUP] → [CLOCK SET]

2 Touch the date or time to be set, then set the desired value using / .

A Displaying the World Time setting (→ 31):

 [HOME] /  [DESTINATION]

- The year can be set between 2000 and 2039.

3 Touch [ENTER].

- A message prompting for World Time setting may be displayed. Perform the World Time setting by touching the screen. (→ 31)

- Touch [EXIT] to complete the setting.

- **[HC-V720] / [HC-V720M]**

At the time of purchase, the confirmation screen for the Wi-Fi setup is displayed after setting the world time. (→ 128)

Exit the screen if the setup is not necessary.



- When the unit is turned on for the first time, a message asking you to set the date and time will appear. Select [YES] and perform Steps 2 to 3 to set the date and time.
- The date and time function is driven by a built-in lithium battery.
- If the time display becomes [- -], the built-in lithium battery needs to be charged. To recharge the built-in lithium battery, connect the AC adaptor or attach the battery to this unit. Leave the unit as it is for approx. 24 hours and the battery will maintain the date and time for approx. 4 months. (The battery is still being recharged even if the unit is off.)

Before recording

■ Basic camera positioning



- ❶ Hold the unit with both hands.
- ❷ Put your hand through the grip belt.
- ❸ It is convenient to use the Recording button icon **A** when holding the unit at waist level.
 - When recording, make sure your footing is stable and there is no danger of colliding with another person or object.
 - When you are outdoors, record pictures with the sunlight behind you. If the subject is backlit, it will become dark in the recording.
 - Keep your arms near your body and separate your legs for better balance.
 - Do not cover the microphones with your hand etc.

■ Basic motion picture recording

- The unit should normally be held steady when recording.
- If you move the unit when recording, do so slowly, maintaining a constant speed.
- The zoom operation is useful for recording subjects you cannot get close to, but overuse of zoom in and zoom out can make the resulting motion picture less enjoyable to watch.

■ Recording Yourself

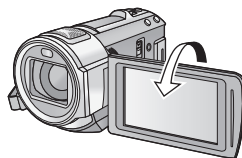

Rotate the LCD monitor towards the lens side.

- The image is horizontally flipped as if you see a mirror image. (However the image recorded is the same as a normal recording.)
- Only some indications will appear on the screen. When  appears, return the direction of the LCD monitor to normal position and check the warning/alarm indication. (→ 173)



Selecting a media to record [HC-V720M]

The card and built-in memory can be selected separately to record motion pictures or still pictures.

- 1 Change the mode to  or .
- 2 Select the menu. (→ 30)

 : [MEDIA SELECT]

- 3 Touch the media to record motion pictures or still pictures.

- The media is selected separately to motion pictures or still pictures is highlighted in yellow.

- 4 Touch [ENTER].

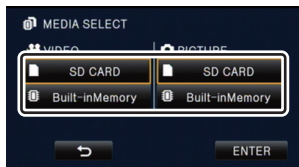





Recording motion pictures

- 1 Change the mode to .
- 2 Open the LCD monitor.
- 3 Press the recording start/stop button to start recording.



- A Recording button icon
- B When you begin recording,  changes to .

- 4 Press the recording start/stop button again to pause recording.

- Recording can also be started/stopped by touching the recording button icon.

■ Screen indications in the Motion Picture Recording Mode

	Recording mode
R 1h20m	Approximate remaining recordable time <ul style="list-style-type: none"> • When the remaining time is less than 1 minute, R 0h00m flashes red.
0h00m00s	Recording time elapsed <ul style="list-style-type: none"> • "h" is an abbreviation for hour, "m" for minute and "s" for second. • Each time the unit is put into recording pause, the counter display will be reset to 0h00m00s.



- Screen display will disappear when no touch operation is performed for a specific period of time. To display it again, touch the screen. (→ 31)
- It will be constantly displayed when the remaining recordable time becomes less than 30 minutes.

- To change the recording format, change the [REC MODE]. (→ 63)
- Still pictures can be recorded while recording the motion picture. (→ 24)
- The images recorded between pressing the recording start/stop button to start recording and pressing it again to pause recording become one scene.
When you record with the [REC MODE] set to [iFrame], the scenes longer than approximately 20 minutes will be automatically divided. (Recording will continue.)
- (Maximum recordable scenes of a single SD card or built-in memory)

Recording formats	[1080/60p]/[PH]/[HA]/[HG]/[HE]	[iFrame]
Recordable scenes	Approx. 3900	Approx. 89100
Different dates (→ 82)	Approx. 900	Approx. 900

- Maximum number of recordable scenes and maximum number of different dates will be less than above table when there are both iFrame scenes and still pictures recorded on an SD card or the built-in memory.
- While recording is in progress, the recording will not stop even if the LCD monitor is closed.
- Put the unit in Pause mode when connecting or disconnecting an external microphone with the MIC terminal.
- Please refer to page 189 about approximate recordable time.



Recording still pictures

- 1 Change the mode to .
- 2 Open the LCD monitor.
- 3 Press the button halfway.
(For Auto Focus only)

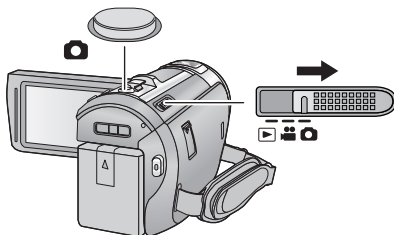

Focus indication:

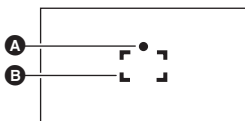







- A Focus indication:
 - (The white lamp flashes.): Focusing
 - (The green lamp lights up.): When in focus
 - No mark: When focusing is unsuccessful.
- B Focus area (area inside brackets)

- 4 Press the button fully.



- If you set the Optical Image Stabilizer function (→ 41) to 1 ([MODE1]), then the Image Stabilizer function will be more effective. ((MEGA Optical Image Stabilizer) will be displayed when the button is pressed halfway.)
- Using a flash or tripod is recommended when recording still pictures in dark places because the shutter speed becomes slow.
- You can also take a picture just by touching the subject to focus. (Touch Shutter: → 55)
- The still picture recording time may be long depending on the picture size.
- The focus indication and the focus area may not be displayed depending on the recording conditions or the menu settings.

■ About the screen indications in Still Picture Recording Mode

	Still picture operation indicator (→ 170)
R3000	Remaining number of still pictures ● Flashes in red when [0] appears.
	Size of still pictures (→ 74)
	MEGA Optical Image Stabilizer (→ 23)
	Optical Image Stabilizer (→ 41)
AF*	AF assist lamp (→ 77)
	Flash (→ 59)
	Flash level (→ 59)
	Red-eye Reduction (→ 59)



- Screen display will disappear when no touch operation is performed for a specific period of time. To display it again, touch the screen.
- It will be constantly displayed when the remaining number of still pictures that can be recorded becomes 200 or less.

■ About the focusing area

When there is a contrasting object ahead or behind the subject in the focus area, the subject may not be focused. If so, move the contrasting object out of the focus area.

Recording still pictures in Motion Picture Recording Mode

◇ Change the mode to  .

Press the  button fully (press to the bottom) to take the picture.

- It is possible to record still pictures while recording motion pictures.
(Simultaneous recording)
- While still pictures are being recorded,  turns red and the remaining number of recordable pictures is displayed.
- No shutter sound is emitted when recording still pictures.



- Built-in flash, Red-eye Reduction, Self-timer (→ 60) do not work.
- While recording motion pictures or during the PRE-REC operation, image quality is different from ordinary still pictures so that motion picture recording takes preference over still picture recording.
- If simultaneous recording is used while recording a motion picture, the recordable time remaining will shorten. If the unit is turned off or the mode switch operated, the recordable time remaining may lengthen.
- The still picture recording time may be long depending on the picture size.
- Maximum number of recordable pictures that can be displayed is 9999. If the number of recordable pictures exceeds 9999, R 9999+ is displayed. The number will not change when the picture is taken until the number of recordable pictures is 9999 or less.
- The recording time may be long depending on the recording condition.

Intelligent Auto Mode



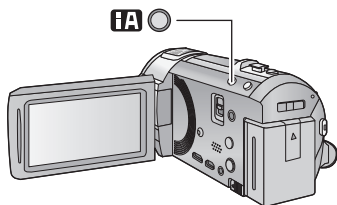





The following modes (appropriate for the condition) are set just by pointing the unit to what you want to record.



Intelligent auto button

Pressing the Intelligent auto button can change the Recording Mode. (→ 42)

- Pressing the Intelligent auto button when other Recording Modes are set will change to Intelligent Auto Mode.

Mode	Effect
 Portrait	Faces are detected and focused automatically, and the brightness is adjusted so it is recorded clearly.
 Scenery	The whole landscape will be recorded vividly without whiting out the background sky, which may be very bright.
 ^{*1} Spotlight	Very bright object is recorded clearly.
 ^{*1} Low Light	It can record very clearly even in a dark room or twilight.
 ^{*2} Night Portrait	A subject and the background are recorded with near real-life brightness.
 ^{*2} Night Scenery	You can record night scenery vividly by slowing the shutter speed.
 ^{*2} Macro	This allows recording at very close proximity to the object of recording.
 ^{*1} Normal	In modes other than those described above, the contrast is adjusted to give a clear picture.
 ^{*2} Normal	

*1 In Motion Picture Recording Mode only

*2 In Still Picture Recording Mode only

- Depending on the recording conditions, the unit may not enter the desired mode.
- In the Portrait, Spotlight, or Low Light Mode, the face will be surrounded by a white frame when detected. In the Portrait Mode, a subject that is bigger and close to center of the screen will be surrounded by an orange frame. (→ 67)
- Using a tripod is recommended in Night Portrait and Night Scenery Mode.
- Faces cannot be detected depending on the recording conditions, such as when faces are of certain sizes or at certain tilts or when digital zoom is used.

■ Intelligent Auto Mode

When switching to Intelligent Auto Mode, the Automatic White Balance and Auto Focus operate and automatically adjust the color balance and focusing.

Depending on the brightness of the subject etc., the aperture and shutter speed are automatically adjusted for an optimum brightness.

- Color balance and focus may not be adjusted automatically depending on light sources or scenes. If so, manually adjust these settings. (→ 49, 51)

Automatic White Balance

The illustration shows the range over which Automatic White Balance functions.

- 1) The effective range of Automatic White Balance adjustment on this unit
- 2) Blue sky
- 3) Cloudy sky (rain)
- 4) Sunlight
- 5) White fluorescent lamp
- 6) Halogen light bulb
- 7) Incandescent light bulb
- 8) Sunrise or sunset
- 9) Candlelight

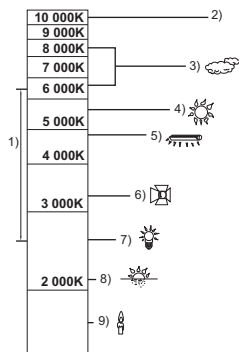

If the Automatic White Balance is not functioning normally, adjust the White Balance manually. (→ 49)

Auto Focus

The unit focuses automatically.

- Auto Focus does not work correctly in the following situations.
Record pictures in the Manual Focus Mode. (→ 51)
 - Recording distant and close-up objects at the same time
 - Recording a subject behind dirty or dusty window
 - Recording a subject that is surrounded by objects with glossy surfaces or by highly reflective objects

Motion picture/Still picture playback

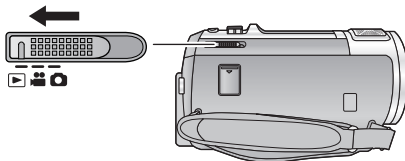

1 Change the mode to .

2 Touch the play mode select icon **A** (→ 17).

- You can also set by touching [MENU], selecting [VIDEO SETUP] or [PICT. SETUP] → [MEDIA, VIDEO/PICTURE]. (→ 30)



3 [HC-V720] / [HC-V710]

Select the still picture **B** or the recording format of the motion picture **C** you wish to play back.

HC-V720M

Select the media type **D** and then select the still picture **B** or the recording format of the motion picture **C** you wish to play back.



- Touch [ENTER].
- The icon is displayed in the thumbnail display when the item for motion picture is touched.
([AVCHD], [1080/60p], [1080/60i], [iFrame] and [MP4])
- [60p] is displayed in the 1080/60p scene when [ALL AVCHD] is touched.

4 Touch the scene or the still picture to be played back.

- To display the next (previous) page:
 - Slide the thumbnail display upward (downward) while touching it.
 - Switch the touch menu, and then touch ▲ (up) / ▼ (down) on the thumbnail scroll lever.



5 Select the playback operation by touching the operation icon.





E Operation icon

- Operation icons and screen display will disappear when no touch operation is performed for a specific period of time. To display them again, touch the screen.

Motion picture playback	Still picture playback
▶/ : Playback/Pause	▶/ : Slide show (playback of the still pictures in numerical order) start/pause.
◀◀: Fast rewind playback*	◀◀: Plays back the previous picture.
▶▶: Fast forward playback*	▶▶: Plays back the next picture.
■: Stops the playback and shows the thumbnails.	■: Stops the playback and shows the thumbnails.

* When pressed two times, the fast rewind/fast forward speed increases. (The screen display changes to ◀◀◀ / ▶▶▶ .)

■ Change the thumbnail display

While the thumbnail is displayed, the thumbnail display changes in the following order if the zoom lever is operated to  side or  side.
20 scenes ↔ 9 scenes ↔ 1 scene ↔ Highlight & Time Frame Index*
(→ 80)

* Highlight & Time Frame Index can only set in Motion Picture Playback Mode.

- 9 scenes display returns if the unit is turned off or the mode is changed.
- By displaying in 1 scene or touching and holding the thumbnail in the 20 scenes or 9 scenes display, recording date and time are displayed when playing back motion pictures, and recording date and file number when playing back still pictures.

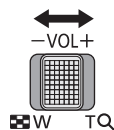

■ Speaker volume adjustment

Operate the volume lever to adjust the speaker volume during Motion Picture Playback Mode.

Towards “+”: Increases the volume

Towards “-”: Decreases the volume

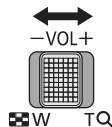
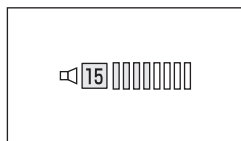

-
- Sound will be heard only during normal playback.
 - If pause play is continued for approx. 5 minutes, the screen returns to the thumbnails.
 - The elapsed time for playback indication will be reset to 0h00m00s each scene.
 - When played back with [ALL AVCHD] selected, the screen may become black momentarily at the time the scene switches.
 - The speaker of this unit does not output sounds when connected to a TV.

Motion picture compatibility

- This unit is based on AVCHD Progressive/AVCHD format/MPEG-4 AVC file format.
- Even if the devices used have compatible standards, when playback of motion pictures recorded using another device is performed using this unit, or when motion pictures recorded using this unit is played back in another device, playback may not proceed normally, or may not be possible. (Please check compatibility in the operating instruction of your device.)
- MP4 scenes that can be played back on this unit are limited to those created on this unit.

Still picture compatibility

- This unit is compliant with the unified standard DCF (Design rule for Camera File system) established by JEITA (Japan Electronics and Information Technology Industries Association).
- The file formats of still pictures supported by this unit is JPEG. (Not all JPEG formatted files will be played back.)
- This unit may degrade or not play back still pictures recorded or created on other products and other products may degrade or not play back still pictures recorded on this unit.

Using the menu screen

- Touch ◀ (left side) / ▶ (right side) of  on the Touch Menu to display . (→ 17)

1 Touch .





■ About guide display

After touching , touching the submenus and items will cause function descriptions and settings confirmation messages to appear.

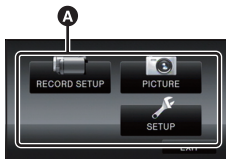

- After the messages have been displayed, the guide display is canceled.

2 Touch the top menu .

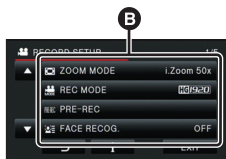

3 Touch the submenu .



- Next (previous) page is displayed by touching  / .

4 Touch the desired item to enter the setting.

5 Touch [EXIT] to exit the menu setting.

Using the Setup Menu

[DISPLAY]



Set the display method for the screen information display.

[MENU] : [SETUP] → [DISPLAY] → desired setting

[5 SECONDS]: Information is displayed on the screen for 5 seconds after starting the Motion Picture Recording Mode or Still Picture Recording Mode, starting to playback, or touching the screen.

[ON]: Constantly displayed.

[CLOCK SET]



Please refer to page 18.

[SET WORLD TIME]



It is possible to display and record the time at the travel destination by selecting your home region and the travel destination.

1 Select the menu.

[MENU] : [SETUP] → [SET WORLD TIME]

- If the clock is not set, adjust the clock to the current time. (→ 18)
- When the [HOME] (your home region) is not set, the message appears. Touch [ENTER] and proceed to Step 3.

2 (Only when setting your home region)

Touch [HOME].

- Touch [ENTER].

3 (Only when setting your home region)

Touch ◀ / ▶ to select your home region and touch [ENTER].

- Touch [DAYLIGHT SAVING] to set daylight saving time. ☀🌙 appears and the summer time setting is turned on; the time difference from GMT is set forward by one hour. Touch [DAYLIGHT SAVING] again to return to the normal time setting.

4 (Only when setting the region of your travel destination)

Touch [DESTINATION].

- Touch [ENTER].

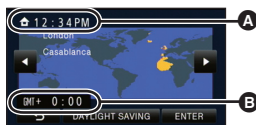

- A** The current time
- B** The time difference from GMT (Greenwich Mean Time)

- When the home region is set for the first time, the screen for selecting home/travel destination appears after setting the home region successively. If the home region has already been set once, execute the menu operation for Step 1.
- 5 (Only when setting the region of your travel destination)
- Touch / to select your travel destination and touch [ENTER].
- Touch [DAYLIGHT SAVING] to set daylight saving time. appears and the summer time setting is turned on. The travel destination time and time difference from the home region time are set forward by one hour. Touch [DAYLIGHT SAVING] again to return to the normal time setting.
 - Close the setting by touching [EXIT]. appears and the time of the travel destination is indicated.

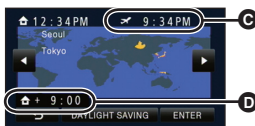

- C The local time at the selected travel destination
- D The time difference between the travel destination and the home region

To return the display to the home setting

Set the home region using Steps 1 to 3, and close the setting by touching [EXIT].

- If you cannot find your travel destination in the area shown on the screen, set it by using the time difference from your home region.

[DATE/TIME]



It is possible to change the date and time display mode.

: [SETUP] → [DATE/TIME] → desired display

[DATE]/[D/T]/[OFF]

[DATE FORMAT]



It is possible to change the date format.

: [SETUP] → [DATE FORMAT] → desired setting

[Y/M/D]/[M/D/Y]/[D/M/Y]

[ZOOM/REC DISPLAY]



You can set the display method of the zoom button icons (**T** / **W**) and recording button icon (**●**).

MENU : [SETUP] → [ZOOM/REC DISPLAY] → desired setting

[ON]: Constantly displayed.

[OFF]: Icons will disappear after approx. 5 seconds without any touch operation.

[O.I.S. LOCK DISPLAY]



Please refer to page 55.

[EXT. DISPLAY]



Please refer to page 101.

[ECONOMY (BATT)]



When about 5 minutes have passed without any operation, this unit automatically turns off to save battery life.

MENU : [SETUP] → [ECONOMY (BATT)] → [ON]

- This unit will not automatically turn off even if [ECONOMY (BATT)] is set to [ON] in following cases:
 - Using the AC adaptor*
 - Using the USB cable for PC etc.
 - PRE-REC is used
 - During slide show playback
 - Wi-Fi function

* When [ECONOMY (AC)] is activated, this unit automatically turns off.

[ECONOMY (AC)]



When about 30 minutes have passed without any operation while connecting AC adaptor with this unit, this unit automatically turns off.

MENU : [SETUP] → [ECONOMY (AC)] → [ON]

- This unit will not automatically turn off even if [ECONOMY (AC)] is set to [ON] in following cases:
 - Using the USB cable for PC etc.
 - PRE-REC is used
 - During slide show playback
 - Wi-Fi function

[QUICK POWER ON]



The unit is put into recording pause approx. 1 second when the unit is turned on with the mode set to or .

[MENU] : [SETUP] → [QUICK POWER ON] → [ON]

- Depending on the recording conditions, start time may be longer than 1 second.
- In the Quick Power On Mode, the zoom magnification becomes approx. 1×.

[QUICK START]



This unit is put into recording pause approx. 0.6 seconds after the LCD monitor is reopened.

- **When in Quick Start Standby Mode about 80% of the power used in recording pause mode is being consumed, so the recording time will be reduced.**

- **[HC-V720]/[HC-V710]**

Quick Start will not work if there is no SD card inserted.

- **[HC-V720M]**

Quick Start will not work if the [SD CARD] is selected in the [MEDIA SELECT], even if there is no SD card inserted.

1 Select the menu.

[MENU] : [SETUP] → [QUICK START] → [ON]

2 Close the LCD monitor.

The status indicator **A** flashes green and the unit goes into Quick Start Standby Mode.

- The lens cover does not close.

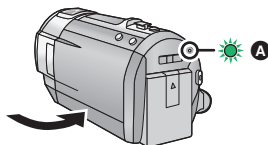

3 Open the LCD monitor.

The status indicator **A** lights red and the unit is put into recording pause.

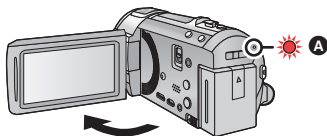

- Quick Start Standby Mode is canceled if
 - about 5 minutes elapsed
 - mode is set to
- Depending on the recording conditions and menu settings, time for Quick Start may be longer than 0.6 seconds.
- It may take some time for Automatic White Balance to adjust.
- In the Quick Start Mode, the zoom magnification becomes approx. 1×.
- When it has gone into Quick Start Standby Mode automatically with the [ECONOMY (BATT)] (→ 33)/[ECONOMY (AC)] (→ 33), close the LCD monitor once and open it again.
- Turn the unit off using the power button.

[ALERT SOUND]



Touch screen operation, starting and stopping of recording and unit on/off can be confirmed with this sound.

When [OFF] is selected, the sound is not output at the start/end of recording, etc.

MENU : [SETUP] → [ALERT SOUND] → desired setting

(Volume low)/ (Volume high)/[OFF]

2 Beeps for 4 times

When an error occurs, follow the instructions displayed on the screen. (→ 173)

[SELECT OPERATION ICONS]



You can change the operation icons (→ 56) to display in the Touch Menu.

Register 3 favorite operation icons.

- The default settings are, (Fade), (PRE-REC) and (Video Light) for Motion Picture Recording Mode, and (Built-in flash), (Self-timer) and (Backlight Compensation) for Still Picture Recording Mode.

1 Select the menu.

MENU : [SETUP] → [SELECT OPERATION ICONS]

2 Touch the operation icon you would like to change to cancel the setting.

3 Touch the operation icon to be set.

- Name of the function is displayed by touching and holding on the operation icon.
- To cancel, touch the operation icon again.

4 Touch [ENTER].

[POWER LCD]



This makes it easier to view the LCD monitor in bright places including outdoors.

MENU : [SETUP] → [POWER LCD] → desired setting

* (Makes even brighter)/ * (Makes brighter)/ * (Normal)/ * (Makes less bright)/
* (Automatic adjustment)

- These settings will not affect the images actually recorded.
- * It is not displayed in the Manual Mode or in the Playback Mode.

- When the AC adaptor is in use, the LCD monitor is set to * automatically.
- Recordable time with the battery is shortened when the LCD is made brighter.
- When the video light is set to ([ON]) or ([AUTO]) and it is lit, it cannot be set.

[LCD SET]



It adjusts brightness and color density on the LCD monitor.

- These settings will not affect the images actually recorded.

1 Select the menu.

MENU : [SETUP] → [LCD SET] → **desired setting**

[BRIGHTNESS]: Brightness of the LCD monitor

[COLOR]: Color level of the LCD monitor

2 Touch / to adjust settings.

3 Touch [ENTER].

- Touch [EXIT] to exit the menu screen.

[HDMI RESOLUTION]



Please refer to page 102.

[VIERA Link]



Please refer to page 103.

[TV ASPECT]



Please refer to page 101.

[INITIAL SET]



Set to [YES] for changing the menu settings back to the default condition.

MENU : [SETUP] → [INITIAL SET]

- Settings for [MEDIA SELECT]^{*}, [CLOCK SET] and [LANGUAGE] will not be changed.

* For users who have (HC-V720) / (HC-V710), this menu is not displayed.

HC-V720 / **HC-V720M**

[Reset Wi-Fi Settings]



Set to [YES] to change the Wi-Fi settings back to the default condition.

MENU : [SETUP] → [Reset Wi-Fi Settings]

- The "LUMIX CLUB" login ID and Wi-Fi password are also deleted.

[Auto Cursor Position]



The entered character is confirmed in approx. 1 second after character input, and the cursor is moved to the right.

It makes the input easy without moving the cursor when characters on the same key are to be entered again.

MENU : [SETUP] → [Auto Cursor Position] → [ON]

- Character input screen is displayed in following conditions:
 - When registering [FACE RECOG.] (→ 64)
 - When setting [TITLE SETUP] for the Highlight Playback (→ 87)
 - When you configure the Wi-Fi function (→ 131, 132, 152, 153, 155)

[NUMBER RESET]



Set the file number of the iFrame and still picture recorded next to 0001.

MENU : [SETUP] → [NUMBER RESET]

- Folder number is updated and file number will start from 0001. (→ 167)
- To reset the folder number, format the SD card and built-in memory, and then perform [NUMBER RESET].

[FORMAT MEDIA]



Please be aware that if a medium is formatted, then all the data recorded on the medium will be erased and cannot be restored. Back up important data on a PC, DVD disc etc. (→ 157)

MENU : [SETUP] → [FORMAT MEDIA] → **desired media**

[Built-inMemory]^{*1}/[SD CARD]/[HDD]^{*2}

*1 **HC-V720M** only.

*2 Displayed when connecting a USB HDD. (→ 109)

• **HC-V720**/**HC-V710**

Media selection screen is not displayed when the USB HDD is not connected. Touch [YES].

- When formatting is complete, touch [EXIT] to exit the message screen.
- Perform a physical formatting of the SD card when the SD card is to be disposed/ transferred. (→ 185)
- **HC-V720M**
Perform a physical formatting of the built-in memory when this unit is to be disposed/ transferred. (→ 183)

- Do not turn this unit off or remove the SD card, while formatting. Do not expose the unit to vibrations or shock.

Use this unit to format media.

Formatting built-in memory is only available with this unit.

Do not format an SD card using any other equipment such as a PC. The card may not be used on this unit.

[MEDIA STATUS]



The used space and remaining recordable time of the SD card and built-in memory can be checked.

[MENU] : **[SETUP]** → **[MEDIA STATUS]**

● **HC-V720M**

- Touching [CHANGE MEDIA] switches the unit between the display for the SD card and the display for the built-in memory.
 - When the mode switch is set to , remaining recordable time for the selected recording mode is displayed.
 - Touch [EXIT] to close the indication.
-
- The SD card or built-in memory requires some space to store information and manage system files, so the actual usable space is slightly less than the indicated value. The usable SD card/built-in memory space is generally calculated as 1 GB=1,000,000,000 bytes. The capacities of this unit, PCs and software are expressed as 1 GB=1,024×1,024×1,024=1,073,741,824 bytes. Therefore, the indicated value of the capacity appears to be smaller.

[Firmware Version Info]



The firmware version of this unit is displayed.

[MENU] : **[SETUP]** → **[Firmware Version Info]**

[Firmware Upgrade]



You can update the firmware version of this unit.

[MENU] : **[SETUP]** → **[Firmware Upgrade]**

For the latest update information, check the support website below. (As of December 2012)

http://panasonic.jp/support/global/cs/e_cam/
(This Site is English only)

[DEMO MODE]



This item is used to start the unit demonstration.

 : [SETUP] → [DEMO MODE] → [ON]

- If [DEMO MODE] is switched to [ON] and you touch [EXIT] when there is no SD card inserted and while this unit is connected to the AC adaptor, the demonstration automatically starts. If any operation takes place, the demonstration is canceled. However if no operations take place for approx. 10 minutes, the demonstration automatically starts again. To stop the demonstration, set [DEMO MODE] to [OFF] or insert an SD card.

[O.I.S. DEMO]



This item is used to start the Optical Image Stabilizer demo.

 : [SETUP] → [O.I.S. DEMO]

- Touch [O.I.S. DEMO], the demonstration automatically starts. When you touch [EXIT], the demonstration will be canceled.

[Eye-Fi TRANSFER]



This item is displayed only when an Eye-Fi card is inserted.
Please refer to page 118.

[Eye-Fi DIRECT]



This item is displayed only when an Eye-Fi card is inserted.
Please refer to page 119.

[LANGUAGE]



You can select the language on the screen display and the menu screen.

 : [SETUP] → [LANGUAGE] → desired language

Using the zoom

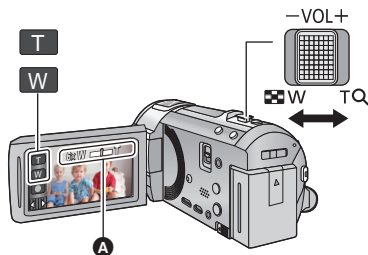

Zoom lever/Zoom button icons

T side:

Close-up recording (zoom in)

W side:

Wide-angle recording (zoom out)

A Zoom bar

- Maximum zoom ratio for recording motion pictures can be set with [ZOOM MODE]. (→ 62)

■ About the zoom bar

The zoom bar is displayed during the zoom operation.

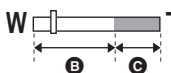

B Optical Zoom

C Motion Picture Recording Mode: i.Zoom/Digital zoom (Blue)

Still Picture Recording Mode: Extra Optical Zoom (Blue)

■ About the zoom speed

- The zoom speed varies depending on the range over which the zoom lever is moved.
- The zoom operation using the zoom button icons will be performed at a constant speed respectively.

Zoom ratio during the Still Picture Recording Mode



The zoom ratio can be expanded up to 50× without degrading the picture quality for the Still Picture Recording Mode. (Extra Optical Zoom)

- Extra Optical Zoom ratio varies depending on the setting of [PICTURE SIZE] and [ASPECT RATIO]. (→ 74, 75)

- If you take your finger off the zoom lever during zoom operation, the operation sound may be recorded. When returning the zoom lever to the original position, move it quietly.
- When the zoom magnification is at its maximum, the subjects are focused at about 1.5 m (4.9 feet) or more.
- When the zoom magnification is 1×, this unit can focus on a subject approx. 3 cm (1.2") away from the lens.

Image Stabilizer Function

Use the Image Stabilizer to reduce the effects of shake during recording.

This unit is equipped with Hybrid Optical Image Stabilizer.

Hybrid Optical Image Stabilizer is a hybrid of Optical and Electrical Image Stabilizer.

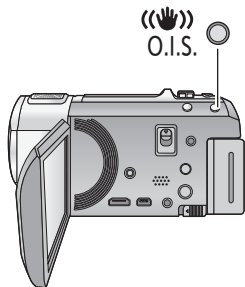



Optical Image Stabilizer button

Press the button to turn Optical Image Stabilizer on/off.



(Motion Picture Recording Mode)

 /  →  (setting canceled)

- When [HYBRID O.I.S.] is [ON],  is displayed. When [OFF],  is displayed.
- When recording with a tripod in Motion Picture Recording Mode, we recommend that you set the Image Stabilizer off.

(Still Picture Recording Mode)

₁ / ₂ →  (setting canceled)

- When [O.I.S.] is [MODE1], ₁ is displayed. When [O.I.S.] is [MODE2], ₂ is displayed.

■ Changing Image Stabilizer Mode

(Motion Picture Recording Mode)

 : [RECORD SETUP] → [HYBRID O.I.S.] → [ON] or [OFF]

When set to [ON], you can further improve image stabilization for recording while walking, or holding the unit and recording a distant subject with zoom.

- This function's default setting is [ON].

(Still Picture Recording Mode)

 : [RECORD SETUP] → [O.I.S.] → [MODE1] or [MODE2]

[MODE1]: The function works all the time.

[MODE2]: The function works when the  button is pressed. We recommend using this mode when you are recording yourself or recording with a tripod in Still Picture Recording Mode.

- Please refer to page 55 for details about the Optical Image Stabilizer Lock.





Changing the Recording Mode

1 Touch the Recording Mode button icon.



2 Touch the desired Recording Mode button icon.



Mode		Effect
	Intelligent Auto	You can switch the mode to the Intelligent Auto Mode, which optimizes settings to the recording environment you are in. (→ 25)
	Intelligent Auto Plus	You can add manually-adjusted brightness and color balance settings to the Intelligent Auto Mode, and record. (→ 43)
	Creative Control*	You can record motion pictures with added effects. (→ 43)
	Scene Mode	This option allows this unit to automatically adjust the shutter speed and aperture according to the scene you want to record. (→ 46)
	Manual	You can set the shutter speed, focus, White Balance, and brightness (iris/gain). (→ 48)

* In Motion Picture Recording Mode only

- Pressing the Intelligent auto button while in Intelligent Auto Mode can also change the Recording Mode. (→ 25)

IA+ Intelligent Auto Plus



Please refer to page 25 for details about the effect of each mode.

(Portrait) / (Scenery) / (Spotlight)^{*1} / (Low Light)^{*1} / (Night Portrait)^{*2} / (Night Scenery)^{*2} / (Macro)^{*2} / (Normal)^{*1} / (Normal)^{*2}

*1 In Motion Picture Recording Mode only

*2 In Still Picture Recording Mode only

• Change the Recording Mode to . (→ 42)

1 (When adjusting the brightness)

Touch .

(When adjusting the color balance)

Touch .

- R side: Sets the balance to a reddish tone.

B side: Sets the balance to a bluish tone.

- When no operations are performed for approximately 5 seconds, the touch menu disappears. If you touch , the touch menu reappears.

2 Touch / to adjust settings.

- Touch while adjusting the brightness, or touch while adjusting the color balance to make the display of the adjustment bar disappear.

3 Start recording.

Creative Control



• Change the Recording Mode to . (→ 42)

Select the desired Creative Control Mode, then touch [Enter].

Mode	Effect
[Miniature Effect]	You can record motion pictures with a diorama effect like recording a miniature by intentionally creating focused area and out of focused area in the peripheral of the image and recording motion picture with an interval. (→ 44)
[8mm movie]	You can record motion pictures with a faded retro effect. (→ 45)
[Silent movie]	You can record motion pictures that are similar to black-and-white silent films by lowering the amount of incoming light. (→ 45)
[Time Lapse Rec]	You can record a scene that moves slowly over a long period of time as a short time motion picture by recording one frame at each set interval. (→ 45)

- Still pictures cannot be taken.

1 Touch to adjust the horizontal position of the in-focus portion.

- If you touch the screen, you can adjust the horizontal position of the in-focus portion.
- When no touch operations are performed for approximately 1 second, [Reset], [SIZE], and [ENTER] are displayed. If you touch the screen, you can readjust the horizontal position of the in-focus portion.
- Position of the in-focus portion will return to original position when you touch [Reset].





2 Touch [SIZE].

- The size of the in-focus portion is switched every time you touch [SIZE].
Medium size → Large size → Small size
- If you touch the screen, you can adjust the horizontal position of the in-focus portion.
- If you touch [Reset], the in-focus portion is reset to the original position and [SIZE] is reset to the medium size.

3 Touch [ENTER].



4 (When adjusting the brightness)

Touch .

- The level of brightness is switched every time you touch the icon.
 (Standard) →  (+1) (Bright) →  (-1) (Dark)

5 (When adjusting the vividness)

Touch .

- The level of vividness is switched every time you touch the icon.
 (Standard) →  (+1) (Vivid) →  (+2) (Most vivid)

6 Start recording.

- It will record with an interval. 1 second will be recorded for approximately every 6 seconds of recording.

-
- To make the Miniature Effect easier to gain, record objects incorporating a distant view or those that can provide depth or a skewed perspective. Also, use a tripod and avoid zooming.
 - You may see a lot of noise in the in-focus portion when recording dark subjects such as night scenes.
 - Audio cannot be recorded.
 - [REC MODE] is set to [HA].
 - The maximum recordable time is 12 hours.
 - Motion pictures recorded with this function will look as if the frame rate is low.
 - **HC-V720M**
Setting Miniature Effect will set [RELAY REC] to [OFF]. (→ 63)



8mm

[8mm movie]

1 (When adjusting the brightness)

Touch .

- The level of brightness is switched every time you touch the icon.

0 (Standard) → +1 (Bright) → -1 (Dark)

2 (When adjusting the color balance)

Touch .

- The level of color balance is switched every time you touch the icon.

B (Blue) → R (Red) → Y (Yellow)
3 **Start recording.**

- The sound is monaural.



SILN

[Silent movie]

1 (When adjusting the brightness)

Touch .

- The level of brightness is switched every time you touch the icon.

0 (Standard) → +1 (Bright) → -1 (Dark)
2 **Start recording.**

- Audio cannot be recorded.

INTV

[Time Lapse Rec]**Touch the desired setup time.****[1 SECOND]/[10 SECONDS]/[30 SECONDS]/[1 MINUTE]/[2 MINUTES]**

- Touch [ENTER].
- A frame is recorded with a set recording interval. 30 frames will make up a motion picture of 1 second.

Setup example	Setup time (recording interval)	Recording time	Recorded time
Sunset	1 s	Approx. 1 h	Approx. 2 min
Blooming	30 s	Approx. 3 h	Approx. 12 s

- Maximum recordable time is 12 hours.

- Audio cannot be recorded.
- [REC MODE] is set to [HA].
- The shortest motion picture recording time is 1 second.
- The color balance and focus may not be adjusted automatically depending on the light source or scene. If so, manually adjust those settings. (→ 49, 51)
- HC-V720M**
Setting Time lapse recording will set [RELAY REC] to [OFF]. (→ 63)



- Change the Recording Mode to **SCN**. (→ 42)

Touch the desired Scene Mode.

Mode	Effect
Sports	To make fast moving scenes less shaky with slow playback and pause of playback
Portrait	To make people stand out against the background
Soft Skin	To makes skin colors appear softer for a more attractive appearance
Spotlight	Improved quality when subject is brightly illuminated.
Snow	Improved image quality when shooting in snowy locations.
Beach	To make blue in the sea or sky vibrant
Sunset	To make red in the sunrise or sunset vibrant
Scenery	For spatial scenery
Fireworks	To capture the fireworks in the night sky beautifully
Night Scenery	To capture the evening or night scenery beautifully
Low Light	For dark scenes, such as at dusk (In Motion Picture Recording Mode only)
Night Portrait	To capture a person and the background brightly (In Still Picture Recording Mode only)

- Touch [ENTER].

- **(Sports/Portrait/Soft Skin/Spotlight/Snow/Beach/Sunset/Scenery)**
 - The shutter speed is 1/8 or more in Still Picture Recording Mode.
- **(Sunset/Low Light)**
 - The shutter speed is 1/30 or more in Motion Picture Recording Mode.
- **(Sunset/Scenery/Fireworks/Night Scenery)**
 - Image may get blurry when close object is recorded.
- **(Sports)**
 - During normal playback, the image movement may not look smooth.
 - Color and screen brightness may change under indoor lighting.
 - If the brightness is insufficient, the Sports Mode does not function. The display flashes.
- **(Portrait)**
 - Color and screen brightness may change under indoor lighting.
- **(Soft Skin)**
 - If the background or anything else in the scene has colors similar to the skin color, they will also be smoothed.
 - If the brightness is insufficient, the effect may not be clear.
 - If you record a person in the distance, the face may not be recorded clearly. In this case, cancel Soft Skin Mode or zoom in on the face (close-up) to record.

- **(Fireworks)**
 - The shutter speed is 1/30.
 - Image may get washed out when recorded in bright surrounding.
- **(Night Scenery/Night Portrait)**
 - The shutter speed is 1/2 or more in Still Picture Recording Mode.
 - Using a tripod is recommended.
- **(Night Portrait)**
 - The flash is set to [ON].

Manual recording

- The Manual Focus, White Balance, Shutter Speed, Brightness (Iris and Gain) settings are retained when you change between Motion Picture Recording Mode and Still Picture Recording Mode.

Touch **MNL** to switch to Manual Mode. (→ 42)



A manual icons

- FOCUS** Focus (→ 51)
- WB** White Balance (→ 49)
- SHTR** Manual Shutter Speed (→ 50)
- IRIS** Iris Adjustment (→ 50)

White Balance



Automatic White Balance function may not reproduce natural colors depending on the scenes or lighting conditions. If so, you can adjust the White Balance manually.

- Switch to Manual Mode. (→ 48)

1 Touch [WB].

2 Touch / to select White Balance Mode.

- Touch [WB] to select the mode.



Icon	Mode/Recording conditions
	Automatic White Balance adjustment
	Sunny mode: Outdoors, under a clear sky
	Cloudy mode: Outdoors, under cloudy sky
	Indoor mode 1: Incandescent light, video lights like in the studio, etc.
	Indoor mode 2: Color fluorescent lamps, sodium lamps in gymnasiums etc.
	Manual adjustment mode: <ul style="list-style-type: none">• Mercury-vapor lamps, sodium lamps, some fluorescent lights• Lights used for wedding receptions at hotels, stage spotlights in theaters• Sunrise, sunset, etc.

- To return to auto setting, set to or press the intelligent auto button again.

■ To set the White Balance manually

1 Select , fill the screen with a white subject.

2 Touch and set the blinking .

- When the screen turns black instantly and the display stops flashing and then lights constantly, the setting is complete.
- If the display continues flashing, the White Balance cannot be set. In this case, use other White Balance Modes.



- When the display flashes, the Manual White Balance previously adjusted is stored. Whenever recording conditions change, re-set the White Balance.
- When setting both the White Balance and the iris/gain, set the White Balance first.
- is not displayed on the screen when is being set.

Manual shutter speed/iris adjustment



Shutter Speed:

Adjust it when recording fast-moving subjects.

Iris:

Adjust it when the screen is too bright or too dark.

- **Switch to Manual Mode.** (→ 48)

1 Touch [SHTR] or [IRIS].

2 Touch / to adjust settings.

- Touch [SHTR]/[IRIS] to end the adjustment.

: Shutter speed:

1/60 to 1/8000

- If [AUTO SLOW SHTR] is set to [ON], the shutter speed will be set between 1/30 and 1/8000.
- The shutter speed closer to 1/8000 is faster.
- The shutter speed will be set between 1/2 and 1/2000 in Still Picture Recording Mode.

: Iris/Gain value:

CLOSE ↔ (F16 to F2.0) ↔ **OPEN** ↔ (0dB to 18dB)

- Value closer to CLOSE darken the image.
- Value closer to 18dB brighten the image.
- When the iris value is adjusted to brighter than OPEN, it changes to the gain value.
- To return to auto setting, press the intelligent auto button again.

-
- When setting both the shutter speed and the iris/gain value, set the shutter speed and then set the iris/gain value.

Manual shutter speed adjustment

- When the shutter speed is set lower than 1/15 in the Still Picture Recording Mode, using a tripod is recommended. Also, White Balance cannot be set. The shutter speed will be set to 1/30 when the unit is turned on again or when the Quick Start is performed.
- You may see a band of light around an object that is shining very bright, or highly reflective.
- During normal playback, image movement may not look smooth.
- If you record an extremely bright object or record under indoor lighting, color and screen brightness may change or a horizontal line may appear on the screen. In this case, record in the Intelligent Auto Mode or set the shutter speed to 1/60 in areas where the power supply frequency is 60 Hz, or 1/100 in areas of 50 Hz.
- Brightness of the image displayed on the LCD monitor may be different from brightness of the image actually recorded during the Still Picture Recording Mode. Confirm the image on the playback screen after recording.

Manual iris/gain adjustment

- If the gain value is increased, the noise on the screen increases.
- Depending on the zoom magnification, there are iris values that are not displayed.

Manual Focus adjustment



If auto focusing is difficult due to the conditions, then use Manual Focus.

- Switch to Manual Mode. (→ 48)

- 1 (When MF assist function is used)
Select the menu.

MENU : [RECORD SETUP] → [MF ASSIST] → [ON]

- Touch to display the Manual icon.

- 2 Touch [FOCUS].

- 3 Touch [MF] to change to Manual Focus.

- MF appears on the screen.

- 4 Adjust the focus by touching $\text{MF} \begin{smallmatrix} + \\ - \end{smallmatrix}$.

$\text{MF} \begin{smallmatrix} + \\ - \end{smallmatrix}$: To focus on a close subject

$\text{MF} \begin{smallmatrix} - \\ + \end{smallmatrix}$: To focus on a faraway subject



The in-focus area is displayed in blue. The normal screen returns approximately 2 seconds after you finish bringing the subject into focus.

A Part displayed in blue

- Touch [FOCUS] to end the adjustment.
- When [MF ASSIST] is [OFF], the blue area is not displayed.
- To restore Auto Focus, touch [AF] in Step 3 or press the intelligent auto button again.

-
- The blue display does not appear on the images actually recorded.

Recording with the Touch Function

You can record using convenient functions just by the easy operation of touching the screen.





1 Touch ◀ (left side)/▶ (right side) of  on the Touch Menu to display Touch Function icons. (→ 17)

2 Touch the Touch Function icon.
(e.g. AF/AE tracking)

- To cancel, touch the Touch Function icon again. (Optical Image Stabilizer Lock is canceled by releasing the finger touching .)



Touch function icons

	Level Shot ^{*1}
	AF/AE tracking
	Optical Image Stabilizer Lock ^{*1}
	Touch Shutter ^{*2}

*1 In Motion Picture Recording Mode only

*2 In Still Picture Recording Mode only

- An icon is displayed when the Touch Function icon is set.

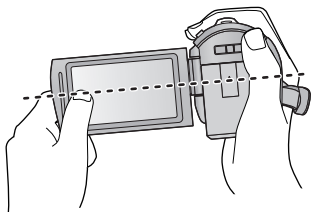

This function detects the horizontal tilt of the unit, and automatically corrects it to the level position before recording.



————— : When this function is set to on.

- - - - - : When this function is set to off.

1 Touch .

- Icon is displayed in **A** position.
 - When the tilt is corrected: 
 - When the tilt is above the correction range: 
- When the tilt exceeds the correction range, move the unit to the position where  is displayed.



2 Start recording.

- The range that this icon can be displayed correctly the slope is about 45° to the vertical direction.
- The image may move while zooming depending on the tilt of this unit.
- To record a level image with a tripod, attach this unit by using [LEVEL GAUGE] (→ 68), and then use Level Shot.





It is possible to set the focus and exposure to the subject specified on the touch screen. The focus and exposure will keep following the subject automatically even if it moves.

1 Touch

- When [FACE RECOG.] (→ 64) is [ON] and a registered face is detected, the target is automatically locked.

2 Touch the object and lock the target.

- When you touch the head of the object, the target frame on the head gets locked and tracking starts.
- Touch the object to be changed again when you want to change the target.
- When the Intelligent Auto Mode or Intelligent Auto Plus Mode is selected, the setting becomes **FA/FAV** (Normal) and touched object is tracked. Selection becomes  /  (Portrait) when target frame is locked on a face. (It may turn to **FA/FAV** (Normal) even if the target is locked on the face when a spotlight is shining or with a dark scene.)



A Target frame

3 Start recording.

■ About target frame

- When target lock fails, the target frame blinks in red and then disappears. Touch a characteristic part (color etc.) on the object to lock onto it again.
 - When the  button is pressed halfway in Still Picture Recording Mode, the focus is set to the object that is locked. The target frame turns green when it focuses, and the target cannot be changed.
-
- This function cannot be used in Manual Mode. In Still Picture Recording Mode, it can only be used with some settings in Scene Mode.
 - It may track different objects or may not lock the target depending on the recording conditions such as the following:
 - When the object is too large or too small
 - When color of the object is similar to the background
 - When the scene is dark
 - When the target is locked in Still Picture Recording Mode, the screen may become dark or the AF assist lamp may be performed. (→ 77)
 - AF/AE tracking will be canceled in the following cases.
 - When the mode is changed
 - When the unit is turned off
 - Touch the Recording Mode button icon
 - Switch to recording of yourself





Optical Image Stabilizer Lock



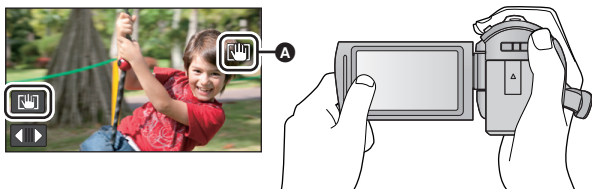

In **Motion Picture Recording Mode**, you can further improve optical image stabilization by touching and holding . With this function, you can further reduce the effects of the shake that tends to occur when using zoom.



- 1 Press the **Optical Image Stabilizer** button to turn the **Image Stabilizer** on.
- 2 Touch and hold .

- Icon is displayed in **A** while you are touching and holding .
- Optical Image Stabilizer Lock is released when you remove your finger from the icon.

■ To make the display of disappear

Display of  will not disappear even when no operation is performed for specific time with the default setting. To make the display of  disappear, change the setting of the [O.I.S. LOCK DISPLAY].

 : [SETUP] → [O.I.S. LOCK DISPLAY] → desired setting

[ON]: Constantly display.

[OFF]: The icon will disappear after approx. 5 seconds without any touch operation.

- Stabilization may not be possible under strong shaking conditions.
- To record while moving the unit quickly, release Optical Image Stabilizer Lock.



Touch Shutter



It is possible to focus and record a still picture of a subject that is touched.

- 1 Touch .

- 2 Touch the subject.

- Focus area is displayed at the touched position, and a still picture is recorded.



- Depending on the recording conditions or recognition of the touched position, it may not be possible to record the intended picture.
- This will not operate for recording yourself.



Recording functions of operation icons

Select the operation icons to add different effects to the images to be recorded.

1 Touch ◀ (left side)/▶ (right side) of  on the Touch Menu to display the operation icons. (→ 17)

2 Touch an operation icon.
(e.g. PRE-REC)

• The operation icons that are displayed in the Touch Menu can be changed. ([SELECT OPERATION ICONS]: → 35)

• Select the operation icon again to cancel the function.

Refer to the respective pages for canceling the following functions.

– Smile Shot (→ 58)

– Built-in flash (→ 59)

– Self-timer (→ 60)







– Guidelines (→ 61)







– Video light (→ 61)

• The icon is displayed when the operation icon is set.



Operation icons

	Fade ^{*1}
	Intelligent Contrast Control ^{*1}
	PRE-REC ^{*1}
	Smile Shot ^{*1}
	Built-in flash ^{*2}
	Red-eye Reduction ^{*2}
	Self-timer ^{*2}

	Intelligent Exposure ^{*2}
	Backlight Compensation
	Tele Macro
	Guidelines
	Color Night Rec ^{*1}
	Video light ^{*1}

*1 Not displayed in Still Picture Recording Mode.

*2 Not displayed in Motion Picture Recording Mode.

• If you turn off the unit or change the mode to , PRE-REC, Backlight Compensation, Color Night Rec, Self-timer and Tele Macro functions are canceled.

• If you turn off the unit, the Fade function is canceled.

• It is possible to set from the menu.

Fade



When you start recording, the image/audio gradually appears. (Fade in)

When you pause recording, the image/audio gradually disappears. (Fade out)

- The Fade setting is canceled when the recording stops.

■ To select the color for fade in/out

 : [RECORD SETUP] → [FADE COLOR] → [WHITE] or [BLACK]

(Fade in)



(Fade out)



- The thumbnails of scenes recorded using fade in become black (or white).

Intelligent Contrast Control



This brightens parts that are in shadow and difficult to see and suppresses white saturation in bright parts at the same time. Both bright and dark parts can be recorded clearly.

- If there are extremely dark or bright parts or the brightness is insufficient, the effect may not be clear.



PRE-REC

This prevents you from missing a shot.



This allows recording of the pictures and sound to start approximately 3 seconds before the recording start/stop button is pressed.

-  appears on the screen.

- Aim the unit at the subject beforehand.

- There is no beep sound.

- PRE-REC is canceled in the following cases.

- If you change the mode

-  / 

- If you remove the SD card

- 

- If you remove the SD card while [MEDIA SELECT] is set to [VIDEO/SD CARD]

- If you touch 

-  / 

- If you press the Wi-Fi button

- If you turn the unit off

- If you start recording



- After 3 hours have passed



- After setting PRE-REC, if recording starts in less than 3 seconds, motion pictures taken 3 seconds before pressing the recording start/stop button cannot be recorded.
- Images displayed on the thumbnail in Playback Mode will differ from the motion pictures displayed at the start of playback.







Smile Shot

When a smiling face is detected during motion picture recording, the unit automatically records a still picture.

The icon changes each time it is touched.

 ([ON]) →  ([FACE RECOG.]) → [OFF]

-  : The unit records a still picture on detecting a smiling face.
-  : Still pictures are only recorded when the face of a person registered using Face Recognition (→ 64) is detected.
- [OFF]: Cancel the setting.

- During Smile Shot recording, the face detected as a smiling face is surrounded by a green frame and  /  are red.
 - Smile Shot recording will not work in the following cases. ( /  will flash)
 - HC-V720 / HC-V710
When there is no SD card inserted
 - HC-V720M
When it is set to [PICTURE/SD CARD] in [MEDIA SELECT], and there is no SD card inserted
 - When it is set to Manual Focus
 - When [FACE RECOG.] is set to [OFF], or no one is registered (In  ([FACE RECOG.]) only)
-
- Depending on the recording conditions (type of smile, camera shake, etc.), the face of the subject may not be detected correctly.
 - The number of recording pixels are 9.4M (4096×2304) or 2.1M (1920×1080). (→ 74)
 - When still pictures that have been recorded using the Smile Shot are displayed as thumbnails, the  appears.
 - When the AF/AE tracking function is target locking a face of the subject, still pictures are only recorded if a smiling face is detected on the locked subject. When the Smile Shot function is set to , it will record only if the face of a subject registered with [FACE RECOG.] is locked as a target.



Built-in flash



When the  button is pressed, the flash is activated and the picture will be recorded. Use the Built-in flash in order to record still pictures in dark places.

Each time the icon is selected, the indication changes by one setting in the following order:

 ([ON]) →  A ([AUTO]) →  ([OFF])

- The unit automatically determines if the flash is necessary even when it has been set to  by detecting the ambient brightness. (If it determines that the flash is necessary, the  indication lights up in red.)

■ To adjust the brightness of the flash

[MENU] : **[PICTURE]** → **[FLASH LEVEL]** → desired setting

 +: Much brighter

 ± 0: Normal

 -: Less bright

- If the  indication etc. flashes when the  button is pressed halfway, the flash is not activated.
- Do not use with Filter Kit (optional) or Conversion Lens (optional) attached.
- The available range of the flash is approx. 1.5 m (4.9 feet) in dark places.

Red-eye Reduction



Reduces the phenomena where human eyes become red from flashes.

- The flash is activated 2 times.
- The red-eye phenomenon tends to appear in certain recording conditions and more with some people than with others.
- When faces are detected in the Intelligent Auto Mode or Intelligent Auto Plus Mode, the Red-eye Reduction is set to on.



Self-timer



This is for recording still pictures using the timer.

Each time the icon is selected, the indication changes by one setting in the following order:

☺10 (Records after 10 seconds) → ☺2 (Records after 2 seconds) → setting canceled

- When you press the button, ☺10 or ☺2 flashes for the set period before a still picture is recorded. After recording, the Self-timer is canceled.
- In Auto Focus Mode, if the button is pressed halfway once and then fully, the lens focuses on the subject when the button is pressed halfway. If the button is pressed fully all at once, the lens focuses on the subject just before recording.

To stop the timer midway through

Touch [CANCEL].

-
- Setting the Self-timer to ☺2 is a good way to prevent image shake when the button is pressed while using a tripod etc.



Intelligent Exposure



This brightens dark areas so the image can be recorded clearly.

-
- If there are extremely dark parts or the brightness is insufficient, the effect may not be clear.



Backlight Compensation



This makes the image brighter to prevent darkening of a backlit subject.



Tele Macro



A more impressive image can be obtained by focusing on the object only in close-up and shading off the background.

- The unit can focus on the subject at a distance of approx. 60 cm (24 ").
 - When the Tele Macro is set with the zoom magnification less than 26× in Motion Picture Recording Mode, it will automatically be set to 26×.
 - When the aspect ratio is [4:3], [3:2] during the Still Picture Recording Mode and Tele Macro is set with the zoom magnification less than 21×, the zoom magnification will automatically be set to 21×. When the aspect ratio is [16:9], the zoom magnification will be 26×.
-
- The Tele Macro function is automatically canceled when the zoom magnification becomes lower than 26× in Motion Picture Recording Mode.
 - Tele Macro function is automatically canceled when the zoom magnification becomes lower than the size below in Still Picture Recording Mode:
 - Less than 21× (when the aspect ratio is [4:3] or [3:2])
 - Less than 26× (when the aspect ratio is [16:9])



Guidelines



You can check if the image is level while recording or playing back motion pictures and still pictures. The function can also be used to estimate the balance of the composition.

It will switch every time the icon is touched.

→ → → Setting canceled

- The guidelines do not appear on the images actually recorded.

■ Displaying guidelines at playback

- Change the mode to and touch the play mode select icon. Then, select the AVCHD scene, or set to [iFrame] or [MP4]. (→ 27)



[MENU] : [VIDEO SETUP] → [GUIDE LINES] → desired setting

- To cancel the Guideline function during playback, set to [OFF].
- It cannot be set while in Still Picture Playback Mode.



Color Night Rec



This function allows you to record color images in very low light situations. (Minimum required illumination: approx. 1 lx)

- Recorded scene is seen as if frames were missed.
- If set in a bright place, the screen may become washed out for a while.
- Bright dots that are usually invisible may be seen, but this is not a malfunction.
- Using a tripod is recommended.
- In darker areas, Auto Focus may focus a bit slower. This is normal.



Video light



It is possible to record with illumination even in dark places.

Each time the icon is selected, the indication changes by one setting in the following order.

([ON]) → ([AUTO]) → ([OFF])



Always on.



Turns on/off automatically according to brightness of the surroundings.



Cancel the setting.

- When the battery is low and the light cannot be lit, the will be displayed on the screen.

- When set to , the video light turns on in Low Light Mode in Intelligent Auto Mode.
- When the video light is in use, the recordable time when using the battery is shortened.
- When the battery level is low, the video light may not turn on or off.
- Do not use with Filter Kit (optional) or Conversion Lens (optional) attached.
- The (approximate) available range of the video light is approximately up to 1.2 m (3.9 feet).
- Using the Color Night Rec function at the same time will make conditions even brighter.

Recording functions of menu











[SCENE MODE]



When you record images in different situations, this mode automatically sets optimum shutter speeds and apertures.

- Set Creative Control Mode to [Time Lapse Rec]. (→ 45)

 : [RECORD SETUP] → [SCENE MODE] → desired setting

[OFF]:	Cancel the setting
 Sports:	To make fast moving scenes less shaky with slow playback and pause of playback
 Portrait:	To make people stand out against the background
 Soft Skin:	To makes skin colors appear softer for a more attractive appearance
 Spotlight:	Improved quality when subject is brightly illuminated.
 Snow:	Improved image quality when shooting in snowy locations.
 Beach:	To make blue in the sea or sky vibrant
 Sunset:	To make red in the sunrise or sunset vibrant
 Scenery:	For spatial scenery
 Fireworks:	To capture the fireworks in the night sky beautifully
 Night Scenery:	To capture the evening or night scenery beautifully
 Low Light:	For dark scenes, such as at dusk

- Please refer to page 46 for details about the effect of each mode.

[ZOOM MODE]



Set the maximum zoom ratio for the Motion Picture Recording Mode.

 : [RECORD SETUP] → [ZOOM MODE] → desired setting

[i.Zoom OFF]:	Up to 26×
[i.Zoom 50×]:	This zoom function allows you to maintain high-definition picture quality. (Up to 50×)
[D.Zoom 60×]:	Digital zoom (Up to 60×)
[D.Zoom 1500×]:	Digital zoom (Up to 1500×)

- The larger the digital zoom magnification, the more the image quality is degraded.
- This function cannot be used in Still Picture Recording Mode.

[REC MODE]



Switch the picture quality and recording format of the motion pictures to record.

: [RECORD SETUP] → [REC MODE] → desired setting

[PH]/[HA]/[HG]/[HE]^{*1}: Set the recording format to 1080/60i.

[1080/60p]^{*2}: Set the recording format to 1080/60p.

[iFrame]^{*3}: Set the recording format to iFrame.

*1 Recording will have higher quality in the order of [PH], [HA], [HG] and [HE].

*2 This option allows you to record in 1080/60p (1920×1080/60 progressive), which is the highest picture quality for this unit.

*3 [iFrame] is a format suitable for Mac (iMovie'11). It is recommended for when using a Mac.

● Recordable time using the battery (→ 12)

- This function's default setting is [HG] mode.
- Please refer to page 189 for details about approximate recordable time.
- When the unit is moved a lot or moved quickly, or when a fast-moving subject is recorded (particularly when recording in [HE] mode), mosaic-type noise may appear at playback.

HC-V720M

[RELAY REC]



It is possible to continuously record motion picture to an SD card when there is no space available in the built-in memory. (It allows you to record only to SD card from built-in memory.)

- Set [MEDIA SELECT] to [Built-inMemory].
- Set [REC MODE] to [PH], [HA], [HG], [HE] or [1080/60p].
- Insert an SD card.

: [RECORD SETUP] → [RELAY REC] → [ON]

- ⇄ is displayed on the screen. ⇄ will disappear when space in the built-in memory is gone and the recording to the SD card starts.
 - Relay Recording can only be performed once.
 - **Combine the scenes that were relay-recorded using the [RELAY SCENE COMBINE] into the SD card. (→ 98, 106)**
 - Once you have performed [RELAY SCENE COMBINE], you can use the Relay Recording function again. If the [RELAY REC] is set to [ON] without performing the [RELAY SCENE COMBINE], a message is displayed. You will be able to perform Relay Recording by touching [YES], but you will not be able to perform the [RELAY SCENE COMBINE] after that.
-
- Still pictures are recorded to the SD card after Relay Recording.
 - ⇄ is displayed on the thumbnail display during the playback of the scene that was relay-recorded on the built-in memory.

Face Recognition is a function for finding faces that resemble faces which have already been registered and automatically prioritizing focus and exposure for those faces. This function makes it possible to keep the face of your loved ones in focus even when they are at the back or on the end of a line in a group picture.

[MENU] : [RECORD SETUP] → [FACE RECOG.] → desired setting

[ON]: The Face Recognition function is available.

[OFF]: Cancel the setting.

[SET]: Face Recognition registration/editing/canceling

■ Registering a face for Face Recognition

[MENU] : [RECORD SETUP] → [FACE RECOG.] → [SET] → [SET]

- Up to a maximum of 6 people can be registered.

1 Align the person's face with the guide.

- Take a picture of the person's face from the front, ensuring that their hair does not hide the outline of their face, their eyes or their eyebrows.

2 Touch [REC] or press the button fully.

- Touch [ENTER].
- It may not be possible to register a face depending on the recording conditions. In this case, try recording the face again.

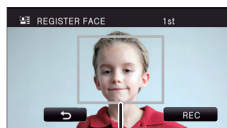

A

A Guide

3 Enter the person's name.

- Touch the text entry icon in the center of the screen and enter the name.
- After entering the name, touch [Enter].



B

B Text entry icon

Entering text

- The characters can be conveniently input without moving the cursor when the [Auto Cursor Position] is set to [ON]. (→ 37)

Icon	Description of operation
[A] etc.	Enters a character.
◀ / ▶	Moves the cursor to left or right.
[A/a/1]	Switches between [A]/[a] (alphabet) and [&/1] (symbols/numbers).
↵	Enters a space.
[Delete]	Deletes a character. Deletes the previous character if the cursor is in an empty space.
[Enter]	Ends text entry.

- A maximum of 9 characters can be entered.

4 Touch [ENTER] to end registration.

- Touch [EXIT].

■ Changing the information of a registered person

1 Select the menu.

[MENU] : [RECORD SETUP] → [FACE RECOG.] → [SET] → [EDIT]

2 Touch the desired item to enter the setting.

- Up to 3 face shots can be registered. To additionally register or to change/delete the registered face shots, touch  or the face shot.
- If you register several face shots of the same person (up to 3 face shots can be registered), each with a different facial expression or different background, it is more likely that Face Recognition will be successful.

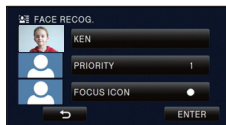

Change name:

Touch the part displaying the registered name, and change the name.

[PRIORITY]:

Focus and exposure will be set in priority according to the registration order setting from the first person. Target will be locked according to the registration order setting from the first person when AF/AE tracking is active.

- To change the registration order, select the person you wish to change.

[FOCUS ICON]:

This changes the focus indication (→ 23) icon that appears during still picture recording. (Only displayed when Face Recognition is in use.)

- Touch the icon you wish to have displayed.

3 Touch [ENTER].

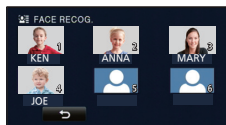

■ canceling a registered person

1 Select the menu.

 : [RECORD SETUP] → [FACE RECOG.] → [SET] → [DELETE] or [DELETE ALL]

- Touching [DELETE ALL] cancels all the registered people.

2 (When [DELETE] is selected)

Touch the person to cancel.

- When touched, the person is selected and  is displayed. To cancel the selected person, touch again.
- Touch [ENTER].

-
- Since Face Recognition searches for faces that resemble the registered faces, there is no guarantee of positive recognition.
 - It may not be possible to correctly recognize a person who has been registered due to differences in facial expression and environment.
 - Perform the registration again if recognition becomes unstable in cases such as when facial features change with age.

[NAME DISPLAY]



When a registered person is detected by Face Recognition during recording, the name registered for that person is displayed.

 : [RECORD SETUP] → [NAME DISPLAY] → desired number

[3]/[2]/[1]/[OFF]

-
- Displayed name will disappear after a while.
 - It is displayed according to the registration order setting from the first person.
 - This function is not displayed during recording of yourself or Playback Mode.

Detected faces appear with frames.

 : **[RECORD SETUP]** → **[FACE FRAMING]** → **desired setting**

[PRIMARY]:

Only the prioritized face framing is displayed.

[ALL]:

All face detection framings are displayed.

[OFF]:

Cancel the setting.



- Up to 15 frames are indicated. Larger faces and faces nearer to the center of the screen take preference over others. When [FACE RECOG.] is [ON] registered people are given priority.

■ Prioritized face framing

Prioritized face framing is displayed as orange frames. Focus and adjustment of brightness will be performed against the prioritized face framing.

- The prioritized face frame is displayed only with Portrait Mode in Intelligent Auto Mode or Intelligent Auto Plus Mode.
- The white frame is for face detection only.
- Focus will be set to prioritized face framing when the  button is pressed halfway when recording still pictures. Prioritized face framing will turn to green when the focus is set.

This function displays the horizontal/vertical tilt of the unit with the electronic level.

MENU : [RECORD SETUP] → [LEVEL GAUGE] → [ON]

■ To correct the tilt

(Horizontal direction)

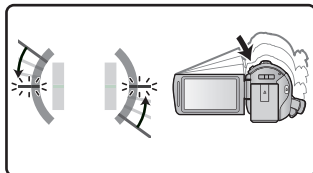

When correcting the leftward tilt

(Vertical direction)

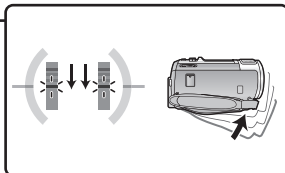

When correcting the downward tilt

- The horizontal tilt display **A** and vertical tilt display **B** appear yellow when there is a tilt, and appear green when there is almost no tilt.
 - The maximum tilt display angles are approximately 45° in horizontal direction and 10° in vertical direction.
 - The electronic level does not affect the actual recorded images.
-
- The electronic level is not displayed when recording yourself or the LCD monitor is closed with the screen facing outward.
 - Even when the tilt is in the corrected state, an error of approximately 1° may occur.
 - In the following cases, the electronic level may not be displayed correctly:
 - When moving this unit
 - When pointing this unit up or down at an angle closer to perpendicular

[AGS]



If the unit continues to be tilted upside down from the normal horizontal position while recording motion pictures, it is automatically put into recording pause.

: [RECORD SETUP] → [AGS] → [ON]

- The AGS function may activate and cause the unit to pause the recording if you are recording a subject right above or right below you.

[AUTO SLOW SHTR]



You can record bright pictures even in dark places by slowing the shutter speed.

- **Switch to Manual Mode.** (→ 48)

: [RECORD SETUP] → [AUTO SLOW SHTR] → [ON]

- The shutter speed is set to 1/30 or more depending on the surrounding brightness.
- This function cannot be used in Still Picture Recording Mode.
- When the shutter speed becomes 1/30, the screen may be seen as if frames are missed and afterimages may appear.

[Digital Cinema Color]



Recording motion pictures with more vivid colors, using x.v.Color™ technology.

- **Switch to Manual Mode.** (→ 48)
- **Set [REC MODE] to [PH], [HA], [HG], [HE] or [1080/60p].** (→ 63)

: [RECORD SETUP] → [Digital Cinema Color] → [ON]

- For more realistic colors, use an HDMI mini cable (supplied) with a TV that supports the x.v.Color™.
- **When motion pictures recorded while this function is turned [ON] are played back with a TV not compatible with x.v.Color™, colors may not be reproduced properly.**
- When these images are played back with devices other than ones compatible with x.v.Color™, it is recommended to record the images after this function is turned [OFF].
- x.v.Color™ is a name for devices that are compatible with the xYCC format, an international standard for expanded color in motion pictures, and that follow the rules for signal transmission.

[SHOOTING GUIDE]



Message is displayed when this unit is moved rapidly.

[MENU] : [RECORD SETUP] → [SHOOTING GUIDE] → [ON]

When “CAMERA PANNING IS TOO FAST.” appears, move the unit slowly while recording.

- Set to [OFF] to turn off the message indication.

- Message will not appear while pausing the recording. (Message will appear even if it is pausing the recording if [DEMO MODE] is set to [ON].)

[Wind Noise Canceler]



This will reduce the wind noise coming into the built-in microphones while maintaining the realism.





- Switch to Manual Mode. (→ 48)

[MENU] : [RECORD SETUP] → [Wind Noise Canceler] → desired setting

[Strong]: When a strong wind is detected, this option effectively reduces the wind noise by minimising the low-pitched sound.

[Normal]: This option extracts and reduces only the wind noise without deteriorating the sound quality.

[OFF]: Cancel the setting.

- When [Strong] is set, you can check how effectively the wind noise is reduced with the icon displayed on the screen. In descending order of the strength of the reduction effect,  /  /  is displayed.
- When [Normal] is set,  will be displayed on the screen.
- This function's default setting is [Normal].
- When switching to Intelligent Auto Mode or Intelligent Auto Plus Mode, [Wind Noise Canceler] is set to [Strong], and the setting cannot be changed.
- You may not see the full effect depending on the recording conditions.
- If wind sound cannot be reduced with the Wind Noise Canceler function alone, set [BASS SETTING] to [LOWCUT]. (→ 73)
- This function cannot be set when using an external microphone.

[LOWCUT]



This function reduces the low-pitched sound when using an external microphone.

- Switch to Manual Mode. (→ 48)

[MENU] : [RECORD SETUP] → [LOWCUT] → [ON]

- This function can be set only when using an external microphone.

[5.1ch/2ch]



You can switch the channel number setting of the built-in microphone.

: [RECORD SETUP] → [5.1ch/2ch] → **desired setting**

[5.1ch]: Records with the 5.1ch surround microphone.

[2ch]: Records with the 2ch stereo microphone.

- The option is set to [2ch] when an external microphone is connected.

[MIC SETUP]



Recording setting of the built-in microphone can be adjusted.

: [RECORD SETUP] → [MIC SETUP] → **desired setting**

[SURROUND]^{*1}: Records the surrounding sound with added realism.

[ZOOM MIC]: Sound is recorded with changing the directionality in conjunction with the zoom operation. Sounds near the front of the unit are recorded more clearly if you zoom in (close-up) and surrounding sounds are recorded more realistically if you zoom out (wide angle).

[FOCUS MIC]^{*1}: The forward sound is recorded more clearly by enhancing the directionality toward the center.

[STEREO MIC]^{*2}: Records sound from two forward directions.

^{*1} The option is displayed only when [5.1ch/2ch] is set to [5.1ch].

^{*2} The option is displayed only when [5.1ch/2ch] is set to [2ch].

- If you wish to record higher quality sound and maintain realism even when zooming in, for instance, when recording a music recital, we recommend setting [MIC SETUP] to [SURROUND].
- [MIC SETUP] will become [STEREO MIC] when the [REC MODE] is set to [iFrame].



When recording, the input level from the built-in microphones and the external microphone terminal can be adjusted.

1 Select the menu.

[MENU] : [RECORD SETUP] → [MIC LEVEL] → desired setting

[AUTO]:	AGC is activated, and the recording level is adjusted automatically.
[SET]:	The desired recording level can be set. AGC is activated, and sound distortions are reduced.
[SET]:	The desired recording level can be set. Sounds are recorded in natural quality.

2 (When [SET]/[SET] is selected)

Touch / to adjust.

- The adjustment screen to be displayed depends on the setting of [5.1ch/2ch].
- Adjust the microphone input level so that the last 2 bars of the gain value are not red. (Otherwise, the sound is distorted.) Select a lower setting for microphone input level.

3 Touch [ENTER].

- Touch [EXIT] to complete the setting.

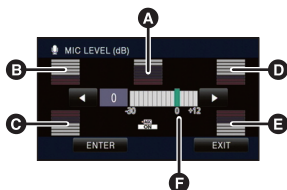

(When set to [5.1ch])

- A** Center
- B** Front left
- C** Back left
- D** Front right
- E** Back right
- F** Microphone input level

- When [MIC SETUP] is [ZOOM MIC], the volume will be different depending on the zoom rate.
- The sound will be recorded in stereo (2ch) when [5.1ch/2ch] is set to [2ch] or an external microphone is input.
- (microphone input level meter) is displayed on the screen when [5.1ch/2ch] is set to [5.1ch], and (microphone input level meter) is displayed when [5.1ch/2ch] is set to [2ch] and [MIC LEVEL] is set to a setting other than [AUTO].
- The microphone input level meter shows the largest volume for the microphones.
- You cannot record with the audio completely muted.

[BASS SETTING]



Change the lower setting of the built-in microphone according to your choice.

- Switch to Manual Mode. (→ 48)

: [RECORD SETUP] → [BASS SETTING] → desired setting

[0dB]/[+3dB]/[+6dB]/[LOWCUT]

- Normally set to [0dB].
- Select [+3dB] or [+6dB] to get strong power feeling at bass level.

[PICTURE ADJUST]



Adjust the quality of the image while recording.

Adjust by outputting to a TV while adjusting the quality of the image.

- This setting is retained when you change between Motion Picture Recording Mode and Still Picture Recording Mode.
- Switch to Manual Mode. (→ 48)

1 Select the menu.

: [RECORD SETUP] → [PICTURE ADJUST]

2 Touch the desired setting items.

[SHARPNESS]:	Sharpness of the edge
[COLOR]:	Depth of the color of the image
[EXPOSURE]:	Brightness of the image
[WB ADJUST]:	Picture color balance

3 Touch / to adjust settings.

4 Touch [ENTER].

- Touch [EXIT] to complete the settings.
- appears on the screen.



The higher the number of pixels, the higher the clarity of the picture when printing.

MENU : [PICTURE] → [PICTURE SIZE] → desired setting

- The number of recording pixels that can be set changes depending on selected screen aspect ratio. (→ 75)

■ Picture size and Maximum zoom ratio in Still Picture Recording Mode

Picture size		Aspect ratio	Extra Optical Zoom (→ 40)
	4480×3360	4:3	-*
	2784×2088		-*
	640×480		50×
	4752×3168	3:2	-*
	3456×2304		-*
	1728×1152		26.2×
	6016×3384	16:9	26×
	4096×2304		26×
	1920×1080		28.9×

* Extra Optical Zoom cannot be used. The maximum zoom magnification is 21×.

■ Picture size in Motion Picture Recording Mode

- Change the mode to .

MENU : [PICTURE] → [PICTURE SIZE] → desired setting

Picture size		Aspect ratio
	4096×2304	16:9
	1920×1080	

- This function's default settings are in Still Picture Recording Mode and in Motion Picture Recording Mode.
- The recording will become longer depending on the recording pixels.
- Please refer to page 190 for details about the number of recordable pictures.

[ASPECT RATIO]



This allows you to select the aspect ratio of the pictures to suit printing or the playback method.

MENU : **[PICTURE]** → **[ASPECT RATIO]** → **desired setting**

[4:3]: Aspect ratio of 4:3 television

[3:2]: Aspect ratio of conventional film camera or prints (such as L-size print)

[16:9]: Aspect ratio of high-definition television, etc.

- This function's default setting is [16:9].
- When the aspect ratio is set to [4:3] or [3:2], black bands may appear on the left and right of the screen.
- The edges of still pictures recorded on this unit with a [16:9] aspect ratio may be cut at printing. Check the printer or photo studio before printing.



Recording is done continuously at the rate of 60 still pictures per second.
Use this function to record an object with fast movement.

1 Select the menu.

[MENU] : [PICTURE] → [HI-SPEED BURST] → [ON]

[ON]: 180 still pictures are recorded continuously at the rate of 60 per second.
The picture size is **[2.1M]** (1920×1080).

[OFF]: Cancel the setting.

2 Press the button.

- flashes in red during recording.
- First press the button halfway, then press it fully to set the focus and record. It will automatically focus if you press fully once, so it is convenient when recording objects moving back and forth.

3 Touch [Record] or [Delete].

[Record]: Pictures are stored.

[Delete]: All pictures are deleted.

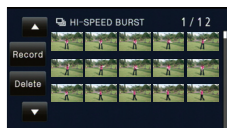

4 (When [Record] is selected in Step 3) Touch [REC ALL] or [SELECT].

[REC ALL]: All pictures are stored.

[SELECT]: Pictures are stored by specifying range.

5 (When [SELECT] is selected in Step 4) Touch the range of pictures that will be stored.

- Previous (Next) page is displayed by touching / .
- * Only select the picture for start point if only 1 picture is to be stored.
- A confirmation message is displayed when [Enter] is touched after selecting the start point and finish point.
Touch [YES] to store the pictures.

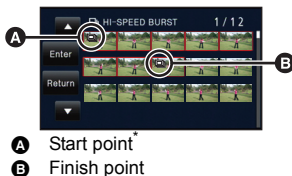

- If you turn off the unit or change the mode, this function is canceled.
- The maximum number of times you can record on a media is 15.
(In the case of SD cards it is the maximum number of recordable scenes per card.)
- Color balance and brightness on the screen may change with some light sources such as fluorescent lamps.
- Image quality is different from ordinary still picture recording.

[AF ASSIST LAMP]



The video light is turned on to make it easier to focus when you are recording in dark places where it is hard to focus.

- **Switch to Manual Mode.** (→ 48)

[MENU] : **[PICTURE]** → **[AF ASSIST LAMP]** → **[AUTO]**

- When switching to Intelligent Auto Mode or Intelligent Auto Plus Mode, the setting is fixed to [AUTO] and cannot be changed.

[SHTR SOUND]



You can add a shutter sound when recording still pictures.

[MENU] : **[PICTURE]** → **[SHTR SOUND]** → **desired setting**

 : Volume low

 : Volume high

[OFF]: Cancel the setting.









- No shutter sound is emitted in Motion Picture Recording Mode.

Playback Operations

Motion picture playback using operation icon



For details on the basic playback operations, refer to page 27.

Playback operation	Playback display	Operating steps
Skip playback (to the start of a scene)	During Playback 	Touch the LCD monitor and slide from right to left (from left to right) during playback.
Slow-motion Playback	During Pause 	With the playback paused, continue touching . ( is for slow rewind playback) Playback is slow while touching. <ul style="list-style-type: none"> • Normal playback is restored when you touch . • When Slow-motion pictures are played back in reverse, they will be shown continuously at approximately 2/3rd the speed of normal playback (intervals of 0.5 seconds). • Slow-motion Playback of the scenes in iFrame or the scenes saved as MP4 will be shown in intervals of 1 second.
Frame-by-frame Playback		With the playback paused, touch . (Touch  to advance the frames one at a time in the reverse direction.) <ul style="list-style-type: none"> • Normal playback is restored when you touch . • When the frames are advanced one at a time in the reverse direction, they will be shown in intervals of 0.5 seconds. • Frame-by-frame Playback of the scenes in iFrame or the scenes saved as MP4 will be shown in intervals of 1 second.

Playback operation	Playback display	Operating steps
Direct playback	<p>During Playback</p> 	<p>Touch the direct playback bar or slide it while touching.</p> <ul style="list-style-type: none"> • The playback pauses temporarily and skips to the position touched or slid to while touching. • Playback will start by releasing your touching or sliding finger.

Creating still picture from motion picture



A single frame from the recorded motion picture can be saved as a still picture.

2.1M (1920×1080) still pictures will be recorded for the AVCHD scenes and iFrame scenes, and

0.2M (640×360) still pictures will be recorded for the MP4 scenes.

Press the  button fully at the location to be saved as a still picture during playback.

- It is convenient to use Pause, Slow-motion Playback and Frame-by-frame Playback.
- Date the motion picture was recorded will be registered as date of the still picture.
- Quality will be different from the normal still picture.



Highlight & Time Frame Index



An image of one scene is displayed as a thumbnail at set search condition. Scene can be played back from any midway point of the scene you wish to see.

- Operate the zoom lever to **Q** side and change over the thumbnail display to **Highlight & Time Frame Index**. (→ 28)

1 Touch .

- To display the next (previous) page:
 - Slide the thumbnail display upward (downward) while touching it.
 - Touch  (up) /  (down) on the thumbnail scroll lever. (→ 27)



2 Touch the desired search condition.

[3 SECONDS]/[6 SECONDS]/[12 SECONDS]/[MINUTES]/[FACE]*/[HIGHLIGHT]*



- * It cannot be set while playing back iFrame scenes or scenes saved as MP4.
- When select [FACE], it will select the portion for which Face Recognition was performed from the scenes judged to be clearly recorded. This will then be displayed as a thumbnail.
- A portion judged to be clearly recorded will be detected and displayed in thumbnail if you select [HIGHLIGHT].

3 (When [MINUTES] is selected)

Touch  /  to set the time.

- It can be set up to a maximum of 60 minutes.
- Touch [ENTER].

4 Touch the thumbnail to be played back.

- Next (Previous) thumbnail can be displayed by touching  / .

Repeat Playback



Playback of the first scene starts after playback of the last scene finishes.

MENU : [VIDEO SETUP] → [REPEAT PLAY] → [ON]

The  indication appears on the full screen views.

- All the scenes are played back repeatedly. (When playing back motion pictures by date, all the scenes on the selected date are played back repeatedly.)

Resuming the previous playback



If playback of a scene was stopped halfway, the playback can be resumed from where it was stopped.

[MENU] : [VIDEO SETUP] → [RESUME PLAY] → [ON]

If playback of a motion picture is stopped, ⏮ appears on the thumbnail view of the stopped scene.

- The memorized resume position is cleared if you turn off the unit or change the mode. (The setting of [RESUME PLAY] does not change.)

Zooming in on a still picture during playback (Playback zoom)



You can zoom in by touching a still picture during playback.

1 Touch and hold the part you wish to zoom in on during still picture playback.

- It will display enlarged in order of normal display (×1) → ×2 → ×4. Touch and hold the screen to zoom in from the normal display ×1 to ×2. Touch the screen to zoom in from ×2 to ×4.
- The still picture is zoomed in on, centering on the part you touched.

2 Move to the zoomed in position by touching ▲ / ▼ / ◀ / ▶ or slide while touching the screen.

- The location of the zoom displays for about 1 second when zooming in (zooming out) or moving the displayed location.



- A** Displayed location of the zoom

Zooming out from the zoomed still picture

Touch 🔍 to zoom out. (×4 → ×2 → ×1)

- Touch **1x** to return to normal playback (×1).

- You can also perform zoom operations using the zoom lever.
- The more picture is enlarged, the more its quality deteriorates.

Various playback functions

Playing back motion pictures/still pictures by date



The scenes or the still pictures recorded on the same day can be played back in succession.

1 Touch the date select icon. (→ 17)





A Date select icon

2 Touch the playback date.

The scenes or the still pictures recorded on the date selected are displayed as thumbnails.

3 Touch the scene or the still picture to be played back.

- Playing back of all the scenes or the still pictures returns if the unit is turned off or the mode is changed.
- In cases such as those described below, scenes and still pictures are grouped separately on the date list, and -1, -2... may be added after the date:
 - When the number of scenes exceeds 99
 - When the number of still pictures exceeds 999
 - When [REC MODE] is changed
 - When the microphone input sound (5.1ch/2ch) is changed
 - When recorded in Creative Control Mode.
 - When [NUMBER RESET] is performed
 - When recorded in Home Monitor function. (→ 147)
- The following scenes and still pictures are grouped separately on the date list, and icons are displayed according to the category:
 - Still pictures taken in High-Speed Burst Shooting Mode: 
 - Still pictures created from motion pictures: 
 - Scenes saved in Highlight Playback (→ 83): 

Highlight Playback



Part that was recognized as clearly recorded is extracted from multiple scenes, and it can be played back or stored in a short time with effects and music added.

It is also possible to create an original Highlight Playback by checking your favorite scenes and setting up to extract those scenes.

- **Highlight Playback cannot be used for iFrame scenes and scenes saved in MP4.**

1 Touch . (→ 17)

2 Touch the desired effect.

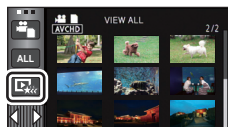

[POP]:	Recommended for party scene.
[NATURAL]:	Recommended for scenery.
[CLASSICAL]:	Recommended for slow moving scene.
[DYNAMIC]:	Recommended for fast moving scene such as sports scene.
[CUSTOM]:	Set the combination of the effect and the music. (→ 84)

- The scenes matching the effect will be extracted and displayed in the thumbnail view.
- Effects such as fade, slow-motion, still (pause), or digest playback are inserted.
- It will be played back with the date of last recording.
- To change the settings, refer to page 85.

3 Touch  in the thumbnail view.

4 Select the playback operation. (→ 27, 78)

- When the playback is finished or stopped, the screen to select [REPLAY], [SAVE] (→ 88), [SELECT AGAIN] or [EXIT] is displayed. Touch the desired item.

-
- Playing back of all the scenes returns if the unit is turned off or the mode is changed.
 - Slow-motion Playback and Frame-by-frame Playback are not possible.
 - Motion pictures recorded with Creative Control Mode are not available for Highlight Playback.

■ Setting up the custom effect

It is possible to enjoy the Highlight Playback with your favorite effect by setting up the combination of an image effect and music.

1 Touch **[CUSTOM]**.

2 Touch **[EFFECT SETUP]** or **[MUSIC SELECT]**.

3 (When **[EFFECT SETUP]** is selected)

Touch the desired effect.

- When **[EFFECT SETUP]** is changed, **[MUSIC SELECT]** will be set the same as **[EFFECT SETUP]**. (To set **[EFFECT SETUP]** and **[MUSIC SELECT]** to different settings, change **[MUSIC SELECT]** after setting **[EFFECT SETUP]**.)

(When **[MUSIC SELECT]** is selected)

Touch the desired sound.

- When **[EFFECT SETUP]** is set to **[NONE]**, you will be able to select **[NO MUSIC]**. When **[NO MUSIC]** is selected, the audio recorded at the time of shooting is played back.

(To test the music audio)

Touch [START].

- Touch the other music option to change the music to be tested.
- When you touch **[STOP]**, the music playback stops.

4 Touch **[ENTER]**.

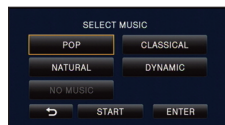
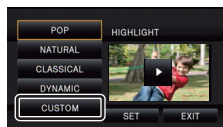

Playing back with the settings changed

Touch [SET] to select the item to change.

[SCENE SETUP]: Select the scene or date to be played back.

[FAVORITE SCENE SETUP]: Set up the favorite scenes. (→ 86)

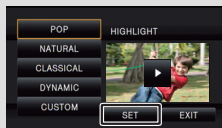

[FAVORITE SCENE PLAY]: Set up if the favorite scenes are to be included in the Highlight Playback or not. (→ 86)

[PRIORITY SETUP]: Select the target to give priority to play back. (→ 87)

[PLAYBACK TIME]: Select the time to play back. (→ 87)

[TITLE SETUP]: Select the title sheet to be displayed at the beginning, and enter the title. (→ 87)

■ Scene setting

- 1 (Only when Highlight Playback is started from [ALL AVCHD])
Touch the recording format of the scene to be played back.

[1080/60p]/[1080/60i]

- 2 Touch [SELECT DATE] or [SELECT SCENES].

- 3 (When [SELECT DATE] is selected)

Touch the date to be played back.

- A maximum of 7 days can be selected.
- When touched, the date is selected and surrounded by red. Touch the date again to cancel the operation.

(When [SELECT SCENES] is selected)

Touch the scenes to be played back.



- Up to 99 scenes can be selected in succession.
- When touched, the scene is selected and ✓ is displayed. Touch the scene again to cancel the operation.

- 4 Touch [Enter]/[ENTER].

■ Checking the favorite scenes

1 Touch the scenes to be played back.

2 Touch [Add] and add the favorite part.

- Approximately 4 seconds before and after touching [Add] will be added as favorite.
- Number of favorite scenes that can be added are 1 to 14. (Number of scenes that can be added differs depending on the scenes selected.)
- Favorite check display  (A) is displayed in orange, and favorite check display  (B) is displayed on the slide bar.
- To cancel the favorite, play back to the position checked as favorite, and touch [Cancel].
- It is convenient to use Slow-motion Playback and Frame-by-frame Playback. (→ 78)

3 Touch and stop the playback.

- It will return to the thumbnail display screen and  is displayed on the scenes added as favorite scenes.

4 Touch [Return].

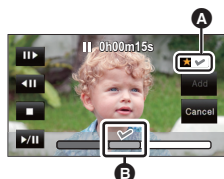
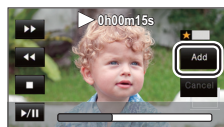

-
- All the scenes checked as favorite may not be played back depending on the playback time setting. (→ 87)

To clear the favorite scenes from the thumbnail display

1 Touch [Reset].

2 Touch [RESET ALL] or [RESET SELECTED].

- The check on all the favorite scenes will be cleared when [RESET ALL] is selected.

3 (When [RESET SELECTED] is selected in Step 2) Touch the scene to be cleared.

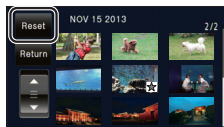

■ Playing back the favorite scenes

Touch [ON] or [OFF].

[ON]: Include the scenes added in the [FAVORITE SCENE SETUP] into the Highlight Playback.

[OFF]: Do not include the scenes added in the [FAVORITE SCENE SETUP] into the Highlight Playback.

■ Priority settings

1 Touch [FACE] or [FACE RECOG.].

- If you touch [FACE], any detected face, including the face of person registered for Face Recognition, is given priority on playback.

2 (When [FACE RECOG.] is selected)

Touch a face to specify.

- You can specify up to 6 faces, which are to be played back in priority.
- When touched, the registered face is selected and surrounded by red. Touch the registered face again to cancel the operation.
- Touch [ENTER]. When a single face is specified, the name registered for that face is displayed. When multiple faces are specified, the number of faces is displayed.

■ Playback time setting

Touch the playback time.

[APPROX 90 SEC.]/[APPROX 3 MIN.]/[AUTO]

- The playback time of [AUTO] is a maximum of approx. 5 minutes.
- Playback time may become shorter than the setting, or it may not even be played back if the part recognized as clearly recorded is short.

■ Setting up the title

1 Touch ◀ / ▶ to select your favorite title sheet.

[NONE]/[PICTURE 1]/[PICTURE 2]/[PICTURE 3]/[PICTURE 4]

- Title and date will not be displayed when [NONE] is selected.

2 Touch [TITLE].

3 Enter the title.

- Input method is same operation as for the Face Recognition.

(→ 64)

- Touch [Enter] after entering the title.
- A maximum of 18 characters can be entered.

4 Touch [ENTER] to end registration.

- The date of the first scene of the Highlight Playback will be displayed as the date.

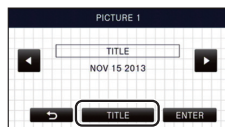

-
- The entered title will be cleared when the unit is turned off or the Highlight Playback is finished.

Saving the Highlight Playback

The scenes put together as a Highlight Playback can be saved as a single scene.

HC-V720 / **HC-V710**

The recorded scenes can be saved in the SD card.

HC-V720M

The recorded scenes can be saved in the built-in memory.

- 1 **Stop the playback of the Highlight Playback or wait until the Highlight playback is finished.**
- 2 **Touch [SAVE].**
- 3 **Select the format to save.**

[QUALITY (AVCHD)]:	It will be saved in high-definition image quality.
[COMPATIBILITY (MP4)]:	It will be saved in image quality (640×360/30p) appropriate for playing back on a PC or uploading to Internet.

- When [QUALITY (AVCHD)] is selected, scenes recorded in 1080/60p are converted to 1080/60i (picture quality [HA] of [REC MODE]) and saved.
- If you select [1080/60i] in [SCENE SETUP] (→ 85), motion pictures are recorded in [HA] regardless of [REC MODE] ([PH]/[HA]/[HG]/[HE]) of a scene. (The image quality remains the same.)

4 **Touch [YES].**

- Playback operation is not possible while playing back the scenes to be saved.

5 **HC-V720** / **HC-V710**

Touch [EXIT].

HC-V720M

Touch [COPY] or [EXIT].

- The Highlight Playback saved in the built-in memory can be copied to the SD card. To copy to the SD card, select [COPY].
- Operate according to the message and touch [EXIT] at the end.

-
-  is displayed on the thumbnail of the scenes saved by the Highlight Playback.

Changing the playback settings and playing back the slide show



1 Touch  . (→ 17)

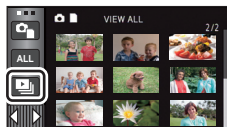

2 (Only when you would like to change the settings)

Touch [SET] to select the item to change.

[DATE SETUP]:	Select the date to be played back.
[PLAYBACK SETUP]:	Select to play back in 3D (2D still pictures are converted to 3D still pictures and played back) or play back in 2D.
[SLIDE INTERVAL]:	Select the interval between still pictures at playback.
[EFFECT SETUP]:	Select the effect for playback.
[MUSIC SELECT]:	Select the music to be played on playback.

3 (When [DATE SETUP] is selected)

Touch the playback date.

(When [PLAYBACK SETUP] is selected)

Touch [3D (NO EFFECT)] or [2D].

(When [SLIDE INTERVAL] is selected)

Touch the interval of playback for the slide show.

[SHORT]:	Approx. 1 second
[NORMAL]:	Approx. 5 seconds
[LONG]:	Approx. 15 seconds

(When [EFFECT SETUP] is selected)

Touch the desired effect.

- When [EFFECT SETUP] is changed, [MUSIC SELECT] will be set the same as [EFFECT SETUP]. (To set [EFFECT SETUP] and [MUSIC SELECT] to different settings, change [MUSIC SELECT] after setting [EFFECT SETUP].)
- [SLIDE INTERVAL] cannot be set, when [EFFECT SETUP] is set.

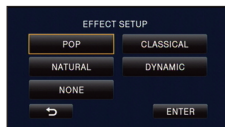

(When [MUSIC SELECT] is selected)

Touch the desired sound.

- Touch [ENTER].

(To test the music audio)

Touch [START] and start the audio testing.

- Touch the other music option to change the music to be tested.
- When you touch [STOP], the music playback stops.

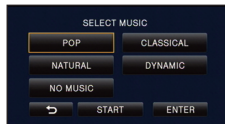

4 Touch [START].

5 Select the playback operation. (→ 28)

- When the playback is finished or stopped, the screen to select [REPLAY], [SELECT AGAIN] or [EXIT] is displayed. Touch the desired item.

Deleting scenes/still pictures

Deleted scenes/still pictures cannot be restored, so perform appropriate confirmation of the contents before proceeding with deletion.

◇ Change the mode to  .

■ To delete the scene or still picture being played back

Touch  while scenes or still pictures to be deleted are being played back.



■ To delete scenes or still pictures from the thumbnail display

- Switch to the thumbnail display of the scenes or still pictures to delete. (→ 27)

1 Touch . (→ 17)

- When the thumbnail display is 1 scene display or Highlight & Time Frame Index, the scene or still picture being displayed is deleted.

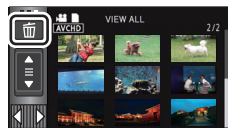

2 Touch [ALL SCENES], [MULTI] or [SINGLE].

- All the scenes or still pictures displayed as thumbnails will be deleted by selecting [ALL SCENES].
(In case of playing back scenes or still pictures by date, all the scenes or still pictures on the selected date will be deleted.)
- Protected scenes/still pictures cannot be deleted.

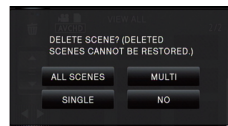

3 (When [MULTI] is selected in Step 2)

Touch the scene/still picture to be deleted.

- When touched, the scene/still picture is selected and the  indication appears on the thumbnail. Touch the scene/still picture again to cancel the operation.
- Up to 99 scenes can be selected to be deleted.

(When [SINGLE] is selected in Step 2)

Touch the scene/still picture to be deleted.

4 (When [MULTI] is selected in Step 2)

Touch [Delete].

- To continuously delete other scenes/still pictures, repeat Steps 3-4.



When you stop deleting halfway:

Touch [CANCEL] while deleting.

- The scenes or still pictures that have already been deleted when the deletion is canceled cannot be restored.

To complete editing:

Touch [Return].

-
- You can also delete scenes by touching , selecting [EDIT SCENE] → [DELETE] → [ALL SCENES], [MULTI] or [SINGLE].
 - You can also delete still pictures by touching , selecting [PICT. SETUP] → [DELETE] → [ALL SCENES], [MULTI] or [SINGLE].
 - During Highlight Playback, scenes/still pictures cannot be deleted.
 - Scenes that cannot be played back (the thumbnails are displayed as ) cannot be deleted.
 - In case of [ALL SCENES], the deletion may take time if there are many scenes or still pictures.
 - If you delete scenes recorded on other products or still pictures conforming to DCF standard with this unit, all the data related to the scenes/still pictures may be deleted.
 - When still pictures recorded on an SD card by other products are deleted, a still picture (other than JPEG) that cannot be played back on this unit, may be erased.

Deleting part of a scene (AVCHD)



Unnecessary part of an AVCHD scene can be deleted.

The deleted scenes cannot be restored.

- Change the mode to  and touch the play mode select icon. Then, select the AVCHD scene. (→ 27)

1 Select the menu.

 : [EDIT SCENE] → [SECTION DELETE]

2 Touch the scene with a part to delete.

3 Set the section to delete by touching and sliding the top and bottom section selection buttons  .

- It is convenient to use Slow-motion Playback and Frame-by-frame Playback. (→ 78)

4 Touch [ENTER].

5 Confirm (play back) the scene after editing by touching [YES].

- A confirmation message appears when [NO] is touched. Proceed to Step 7.

6 Stop the playback.

- A confirmation message appears.

7 Touch [ENTER].

- Repeat Steps 2-7 to continuously delete parts from other scenes.

To complete editing

Touch [Return].

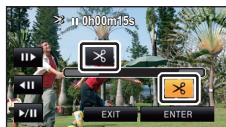

- Deleting a part of a scene cannot be performed when there are 99 scenes in a single date.
- It may not be possible to delete part of a scene with a short recording time.
- The scene will be divided into two scenes when the middle part of a scene is deleted.
- **HC-V720M**

The relay information is deleted when part of a scene that was relay recorded is deleted, making it impossible to perform the Relay scene combining. (→ 98)

Dividing a scene (AVCHD)



It is possible to divide an AVCHD scene.

Any unwanted parts in the scene can be deleted after dividing.

- Change the mode to  and touch the play mode select icon. Then, select the AVCHD scene. (→ 27)

1 Select the menu.

 : [EDIT SCENE] → [DIVIDE] → [SET]

2 Touch the scene to be divided.

3 Touch to set the dividing point.

- It is convenient to use Slow-motion Playback and Frame-by-frame Playback. (→ 78)
- Touch [YES] to continue dividing the same scene. To continue dividing other scenes, touch [NO] and repeat Steps 2-3.



4 Touch [Return] to complete dividing.

- Unwanted parts can be deleted. (→ 91)

To delete all the divided points

 : [EDIT SCENE] → [DIVIDE] → [CANCEL ALL]

- The scenes that were deleted after division cannot be recovered.
- You cannot divide a scene if the number of scenes of a given date would exceed 99 scenes.
- It may not be possible to divide scenes with a short recording time.
- Data that has been recorded or edited on another device cannot be divided and the divided points cannot be deleted.
- If personal information in the divided scenes is deleted, the personal information is deleted when the divided scenes are canceled.

Dividing a scene to partially delete (iFrame/MP4)



Divide the iFrame scene or the scene saved as MP4, and delete unnecessary parts. This divides the recorded scenes in two and deletes the front half or back half.

The scenes deleted by dividing cannot be restored.

- Change the mode to  and touch the play mode select icon. Then, set to [iFrame] or [MP4]. (→ 27)

1 Select the menu.

 : [EDIT SCENE] → [SPLIT&DELETE]

2 Touch the scene to be divided.

3 Touch  to set the dividing point.

- It is convenient to use Slow-motion Playback and Frame-by-frame Playback. (→ 78)
- Set the dividing point so there will be 2 seconds or more for the part for deletion, and 3 seconds or more for the part to be kept.

4 Touch the part for deletion.

5 Touch [YES] and confirm (play back) the part for deletion.

- A confirmation message appears when [NO] is touched. Proceed to Step 7.

6 Stop the playback.

- A confirmation message appears.

7 Touch [YES].

- To continue dividing and deleting other scenes, repeat Steps 2-7.

To complete editing

Touch [Return].

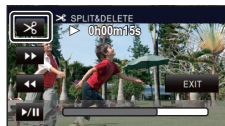

- It may not be possible to divide scenes with a short recording time.
- The actual division may slightly slip off the previously designated dividing point.

Deleting personal information



Deletes Face Recognition information from scenes in which faces were recognized.

- Change the mode to and touch the play mode select icon. Then, select the AVCHD scene. (→ 27)
- Face Recognition information is not recorded in the scenes recorded in iFrame or the scenes saved as MP4.

1 Select the menu.

: [VIDEO SETUP] → [DELETE PERSONAL INFO]

2 Touch the desired scenes with personal information to be deleted.

- appears at scenes for which faces were recognized. will change to (red) when touched. Touch the (red) again to cancel the operation.
- Up to 99 scenes can be selected in succession.

3 Touch [Delete].

- To continuously delete other personal information, repeat Steps 2-3.
- Touch [Return] to complete the settings.

When you stop deleting halfway

Touch [CANCEL] while deleting personal information.

- The personal information that has already been deleted when the deletion is canceled cannot be restored.

Protecting scenes/still pictures



Scenes/still pictures can be protected so that they are not deleted by mistake.

(Even if you protect some scenes/still pictures, formatting the media will delete them.)

- Change the mode to .

1 Select the menu.

: [VIDEO SETUP] or [PICT. SETUP] → [SCENE PROTECT]*

* [TRANSFER/PROTECT] is displayed when using the Eye-Fi card that is set as the selected transfer setting device in advance on the computer.

2 Touch the scene/still picture to be protected.

- When touched, the scene/still picture is selected and the indication appears on the thumbnail. Touch the scene/still picture again to cancel the operation.
- Touch [Return] to complete the settings.

Convert to MP4



Before copying, convert the scenes recorded in AVCHD to those with the image quality (MP4: 640×360/30p) that supports playback on a PC or uploading on the internet.

- Set the mode to , touch the play mode selection icon, and then select the AVCHD scene. (→ 27)

1 Select the menu.

 : [EDIT SCENE] → [CONVERT TO MP4]

2 Touch the scene you want to convert to MP4.

- The scene selection is made as you touch it, and the  indication appears on the thumbnail. To cancel the operation, touch the scene again.
- You can select up to 99 scenes in succession.

3 Touch [Enter].

- Converted MP4 scenes are saved in the same media as those in AVCHD before the conversion.

To stop converting to MP4 halfway

Touch [CANCEL] during format conversion.

To exit the MP4 conversion

Touch [Return].

-
- A scene recorded over a long time may take time.
 - When converting and copying the scenes recorded in AVCHD to an MP4 scene, the scene exceeding approximately 20 minutes is automatically divided.
 - The settings for the copied motion pictures will be cleared if the protected motion pictures are copied.

Relay scene combining [HC-V720M]



You can combine the relayed scene (→ 63) in the built-in memory and the continued scene in the SD card to be one into the SD card.

Relay-recorded scene

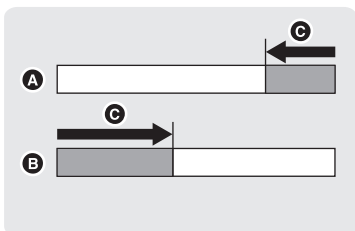

Relay scene combining

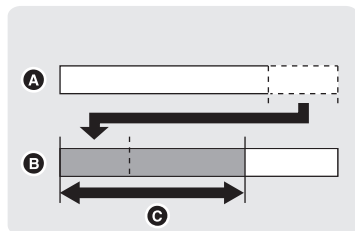

- A Built-in memory
- B SD card
- C Range of Relay Recording

- Change the mode to  and touch the play mode select icon. Then, select the AVCHD scene. (→ 27)

- 1 Insert the SD card that was used for Relay Recording.
- 2 Select the menu.

MENU : [EDIT SCENE] → [RELAY SCENE COMBINE]

- 3 When the confirmation message appears, touch [YES].

- Scene in the built-in memory will be deleted. (Protected scenes in the built-in memory are not deleted.)

- 4 Touch [EXIT] when the relay scene combining complete message is displayed.

- The thumbnail view of the SD card is indicated.
- Relay Recording information will be deleted when the relay scenes are combined, and Relay Recording will be possible again.
- When the relayed scenes in the built-in memory or SD card are deleted, combining of the relayed scenes will not be possible.

To cancel relay information

MENU : [EDIT SCENE] → [RELAY INFO CANCEL]

- When the relay information is canceled, combining of the relayed scenes will not be possible anymore.

Combining of the relay scene cannot be performed if the available space on the SD card is less than the volume of the relayed scene in the built-in memory. It is recommended to combine the relay scene using the HD Writer AE 5.0.

-
- The personal information of the relayed scene in the built-in memory or SD card is deleted, the personal information of the combined relay scene is deleted.

Watching Video/Pictures on your TV



Confirm the terminals on your TV and use a cable compatible with the terminals. Image quality may vary with the connected terminals.

- A** High quality
- 1** HDMI terminal
- 2** Video terminal

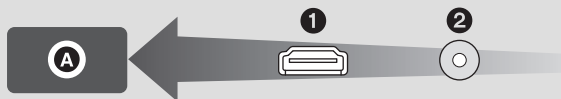

- Use the HDMI mini cable (supplied).
- HDMI is the interface for digital devices. If you connect this unit to a HDMI compatible high-definition TV and then play back the recorded high-definition images, you can enjoy them in high resolution with high quality sound.

1 Connect this unit to a TV.

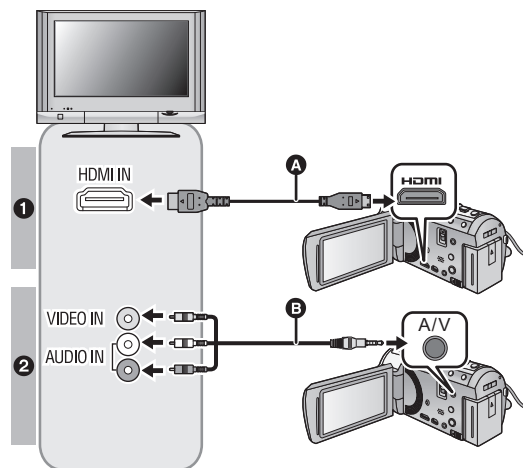

- A** HDMI mini cable (supplied)
- Be sure to connect to the HDMI terminal.
- Connecting with a HDMI mini cable (→ 102)
- Listening in 5.1 channel sound (AVCHD) (→ 102)
- Playback using VIERA Link™ (→ 103)
- B** Composite video cable (commercially-available)

Picture quality

- 1** High-definition images when connecting to HDMI terminal
- 2** Standard images when connecting to video terminal

- Check that the plugs are inserted as far as they go.
- Always use the supplied HDMI mini cable or a genuine Panasonic HDMI mini cable (RP-CDHM15, RP-CDHM30: optional).

2 Select the video input on the TV.

- Example:

Select the [HDMI] channel with a HDMI mini cable.

Select the [Video 2] channel with a Composite video cable.

(The name of the channel may differ depending on the connected TV.)

- Check the input setting (input switch) and the audio input setting on the TV. (For more information, please read the operating instructions for the TV.)

3 Change the mode to to play back.

- When connected to the TV, sound in Playback Mode is not output from this unit. Also, since the volume cannot be adjusted with this unit, adjust the volume of the TV.
- Image and audio is not output from this unit while using the Wi-Fi function.



■ To watch images on a regular TV (4:3) or when both sides of the images do not appear on the screen

Change the menu setting to display the images correctly. (Check the TV setting.)

MENU : [SETUP] → [TV ASPECT] → [4:3]

- If you set the option to [4:3] and connect this unit and the TV with the Composite video cable, images may be displayed in a reduced size.

Example of images with a [16:9] aspect ratio on a regular TV (4:3)

[TV ASPECT] setting	
[16:9]	[4:3]
	

- If a wide-screen TV is connected, adjust the aspect setting on the TV. (Refer to the operating instructions of the TV for details.)

■ To display the on-screen information on the TV

When the menu setting is changed, the information displayed on the screen (operation icon and time code etc.) can be displayed/not displayed on the TV.

MENU : [SETUP] → [EXT. DISPLAY] → desired setting

[SIMPLE]*:	Information partially displayed
[DETAIL]:	All information displayed
[OFF]:	Not displayed

- * This setting is only available in Motion Picture Recording Mode or Still Picture Recording Mode.

Refer to the following support site for information about Panasonic TVs with an SD card slot for playing back your pictures.

<http://panasonic.net/>

- It may not be possible to play back scenes on the TV depending on the [REC MODE].
- For details on how to play back, please read the operating instructions for the TV.

Connecting with a HDMI mini cable

Select the desired method of HDMI output.

 : [SETUP] → [HDMI RESOLUTION] → [AUTO]/[1080p]/[1080i]/[480p]

- [AUTO] determines the output resolution automatically based on information from the connected TV.
If the images are not output on the TV when the setting is [AUTO], switch to the method [1080p], [1080i] or [480p] which enables the images to be displayed on your TV. (Please read the operating instructions for the TV.)
- Images may not be displayed on the television for several seconds in some cases, such as when changing between scenes.

Listening in 5.1 channel sound (AVCHD)

You still can listen to the 5.1 channel sound recorded from the internal microphones when this unit is connected to the 5.1 channel compatible AV amplifier or TV using the HDMI mini cable. Please read the AV amplifier and TV operating instructions for how to connect this unit to the AV amplifier and TV.

- If you connect this unit to a Panasonic AV amplifier that are compatible with VIERA Link, linked operations (VIERA Link) become possible. (→ [103](#))
- Audio recorded when [MIC SETUP] is set to [STEREO MIC] or recorded from an external microphone is in stereo (2 ch).

Playback using VIERA Link™



What is the VIERA Link (HDAVI Control™)?

- VIERA Link™ is a new name for EZ Sync™.
- This function allows you to use your remote control for the Panasonic TV for easy operations when this unit has been connected to a VIERA Link compatible device using a HDMI mini cable (supplied) for automatic linked operations. (Not all operations are possible.)
- VIERA Link is a unique Panasonic function built on a HDMI control function using the standard HDMI CEC (Consumer Electronics Control) specification. Linked operations with HDMI CEC compatible devices made by other companies are not guaranteed.
When using devices made by other companies that are compatible with VIERA Link, refer to the operating instructions for the respective devices.
- This unit supports "VIERA Link Ver.5" function. "VIERA Link Ver.5" is the standard for Panasonic's VIERA Link compatible equipment. This standard is compatible with Panasonic's conventional VIERA Link equipment.

◇ Change the mode to .

1 Select the menu.

MENU : [SETUP] → [VIERA Link] → [ON]

- If you are not using VIERA Link, set to [OFF].

2 Connect this unit to a Panasonic TV compatible with VIERA Link with a HDMI mini cable. (→ 100)

- It is recommended to connect this unit to an HDMI terminal other than the HDMI1 if there are 2 or more HDMI input terminals on the TV.
- VIERA Link must be activated on the connected TV. (Read the operating instructions of the TV for how to set etc.)

3 Operate with the remote control for the TV.

- You can select the scene or picture you want to play back by pressing the button up, down, left or right, and then the button in the center.

(When selecting scenes)

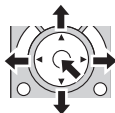

(When playing back)

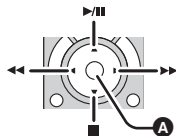

A Display/Cancel operation icons

- The following operations are available by pressing the color buttons on the remote control.

Green	<ul style="list-style-type: none">• Switching the number of scenes/still pictures in thumbnail display (9 thumbnails → 20 thumbnails → 9 thumbnails...)• Zoom in on still picture
Yellow	<ul style="list-style-type: none">• Deleting scenes/still pictures
Red	<ul style="list-style-type: none">• Zoom out from still picture/Adjust the 3D depth

■ Other linked operations

Turning the unit off:

If you use the remote control for the TV to turn off the power, this unit also turns off.

Automatic input switching:

If you connect with a HDMI mini cable and then turn on this unit, the input channel on the TV automatically switches to this unit's screen. If the TV's power is in standby status, it will turn on automatically (if [Set] has been selected for the TV's [Power on link] setting).

- Depending on the HDMI terminal on the TV, the input channel may not switch automatically. In this case, use the remote control for the TV to switch the input channel.

-
- If you are unsure whether or not the TV and AV amplifier you are using are compatible with VIERA Link, read the operating instructions for the devices.
 - Available linked operations between this unit and a Panasonic TV is different depending on the types of Panasonic TVs even if they are compatible with VIERA Link. Refer to the operating instructions of the TV for the operations that support on the TV.
 - Operation is not possible with a cable that is not based on the HDMI standard.

Converting and playing back 2D images as 3D



You can connect this unit to 3D compatible TV, convert the scenes and still pictures recorded in 2D (conventional image) to 3D and play back.

- ◆ **Change the mode to and touch the play mode select icon. Then, select the AVCHD scene or set to . (→ 27)**

1 Touch 2D+3D .

- This is not displayed when playing back the iFrame scenes or scenes saved in MP4.

2 Play back the scene or the still picture by touching it.

- Convert and play back the images recorded in 2D as 3D images.

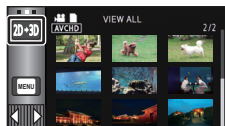

- You can also set by touching , selecting [VIDEO SETUP] or [PICT. SETUP] → [CONV. 2D TO 3D] → [ON]
- Highlight Playback cannot be converted to 3D image.
- Scenes/still pictures converted to 3D images cannot be saved as 3D images.

■ Adjusting 3D effect of the 3D image

It is possible to adjust the scenes and still pictures playing back in 3D for better view.

1 Play back the scenes or still pictures in 3D.

2 Touch .

- The 3D depth adjustment bar is displayed while in 3D playback mode.

3 Touch / to adjust settings.

- 3D depth adjustment bar will disappear after approx. 5 seconds without any touch operation.



- The setting is canceled in following cases:
 - If you stop playback
 - If you turn the unit off
 - If you change the mode

- **Stop the operation when you feel fatigue, discomfort, or otherwise strange while playing back or adjusting.**

Copying between SD card and Built-in Memory [HC-V720M]



Motion pictures or still pictures recorded with this unit can be copied between an SD card inserted in this unit and a built-in memory.

■ Check the used space of the copy destination

It is possible to check the used space of the SD card or built-in memory by [MEDIA STATUS]. (→ 38)

- By displaying in 1 scene or touching and holding the thumbnail in the 20 scenes or 9 scenes display, recording date and time can be checked when playing back motion pictures, and recording date and file number when playing back still pictures.
- Depending on the media condition, some remaining capacity of the SD card or built-in memory may not be used.
- If the remaining capacity on a single SD card is not enough, you can copy to multiple SD cards following the instruction on the screen. In this case, the last scene copied to an SD card is automatically divided to fit the space on the SD card.
- If you divide the scenes (→ 94), and copy by scene selection, it is possible to copy matching the remaining capacity of the media, or only the necessary parts.

Copying

- If there is little or no remaining capacity in the SD card, a confirmation message asking to copy after deleting all data on the SD card is displayed. Be aware that deleted data cannot be restored.
- Refer to page 107 for approximate time for copying.

1 Change the mode to .

- Use a sufficiently charged battery or the AC adaptor.



2 Select the menu.



[MENU] : [COPY]



[→]	When copying from the SD card to the built-in memory
[→]*	When copying from the SD card to the USB HDD
[→]	When copying from the built-in memory to the SD card
[→]*	When copying from the built-in memory to the USB HDD

* Displayed only when connecting a USB HDD. (→ 109)

Changing the recording format



When [ → ] is selected, the recording format will be converted. Touch [YES] and select the copying method.

[AVCHD  →  MP4] This will convert the scene recorded in AVCHD on the built-in memory to MP4 (640×360/30p) and copy to the SD card.

[1080/60p  →  1080/60i] This will convert the scene recorded in 1080/60p on the built-in memory to 1080/60i and copy to the SD card.

- When there are relay-recorded scenes in the built-in memory, a message appears on the screen. Touch [YES] and copy after combining relay-recorded scenes to the SD card. (→ 98)

3 Touch desired items following the screen display.

- It will return to the previous step by touching .
- (When [SELECT SCENES] is selected)
When touched, the scene/still picture is selected and the  indication appears on the thumbnail. Touch the scene/still picture again to cancel the operation.
- (When [SELECT DATE] is selected)
When touched, the date is selected and surrounded by red. Touch the date again to cancel the operation.
- Up to 99 scenes/still pictures or 99 dates can be set in succession.
- If 2 or more SD cards are necessary to copy, change the card following the instructions on the screen.

4 Touch [EXIT] when the copy complete message is displayed.

- The thumbnail view of the copy destination is indicated.



When you stop copying halfway

Touch [CANCEL] while copying.



Approximate time for copying

When copying a recorded motion picture of full 4 GB size:

Approx. 5 minutes to 15 minutes

When performing [1080/60p  →  1080/60i] on a recorded 1080/60p motion picture of full 4 GB size:

Approx. 20 minutes to 30 minutes

When performing [AVCHD  →  MP4] on a recorded AVCHD (HA) motion picture of full 4 GB size:

Approx. 30 minutes to 40 minutes

To copy approx. 600 MB still pictures (Picture size ):

Approx. 3 minutes to 5 minutes

If you will delete the motion pictures or still pictures after copying is complete, be sure to play back the motion pictures or still pictures to check that they have been copied to correctly before deleting.

- Depending on the following conditions, the time it takes for copying may be longer.
 - The number of recorded scenes is large.
 - The temperature of the unit is high.
- If some motion pictures or still pictures have already been recorded to the copy destination, then the same date may be assigned or images may not display by date when the list by date is selected.
- When converting and copying the scenes recorded in AVCHD to an MP4 scene, the scene exceeding approximately 20 minutes is automatically divided.
- Motion pictures that have been recorded on another device may not be copied. Data recorded on a PC with HD Writer AE 5.0, etc. cannot be copied.
- The settings for the copied motion pictures and still pictures will be cleared if the protected motion pictures or still pictures are copied.
- The order in which the scenes or still pictures were copied cannot be changed.

Copying/playing back with a USB HDD



• In this owner's manual, "USB hard disk drive" is indicated as "USB HDD".
If you connect a USB HDD (commercially-available) to this unit by using a USB Connection Cable (supplied with USB HDD), you can copy motion pictures and still pictures recorded on this unit to a USB HDD.

It can also play back the scenes and still pictures copied to the USB HDD.

- You can copy scenes and still pictures recorded with this unit while maintaining the image quality.
- Please read the operating instructions of the USB HDD for how to use it.

Preparing for copying/playing back

For the latest compatible USB HDD recommended by Panasonic, check the support website below.

http://panasonic.jp/support/global/cs/e_cam/

(This Site is English only)

- In the following cases, a USB HDD cannot be used by connecting it to this unit:
 - A USB HDD with a capacity of below 160 GB or above 2 TB
 - When a USB HDD has two or more partitions
 - If a USB HDD is in a format other than FAT32
 - When connected by using a USB hub
 - When a USB HDD is not a desktop type

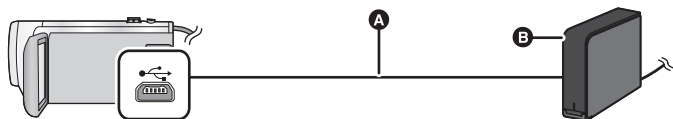

- A** USB Connection Cable (supplied with recommended USB HDD)
- B** Recommended USB HDD (commercially-available)
- Connect this unit to the AC adaptor

1 Connect the AC adaptor (supplied with USB HDD) to the USB HDD.

- You cannot supply power to the USB HDD from this unit.

2 Connect this unit to the AC adaptor and change the mode to .

3 Connect this unit to the USB HDD with the USB Connection Cable (supplied with USB HDD).

- Connect the mini A terminal of the USB Connection Cable to the USB terminal of this unit.
- It may take several minutes until the connection is completed.

4 Touch the desired item.

[Simple copy]:	Copies all scenes and still pictures recorded with this unit that have not been copied yet. (→ 112)
[Copy selected files]:	Allows you to select desired scenes/still pictures, and then copy. (→ 112)
[Playback HDD]:	Plays back scenes and still pictures stored in a USB HDD on this unit. (→ 113)
[Safe Removal]:	Allows you to safely remove this unit and a USB HDD.

- Following can be performed by connecting the USB HDD with the scenes and still pictures copied from this unit to other devices.
 - Playback on Panasonic TV with a USB terminal
 - Dub onto the Panasonic Blu-ray disc recorder with a USB terminal
 - Save on a PC or rewrite on USB HDD using HD Writer AE 5.0

When the USB HDD is connected to other devices such as Blu-ray disc recorder, a message prompting to format the USB HDD may display. All the scenes and still pictures recorded on the USB HDD will be erased if formatted. Do not format as important data will get erased and it will be impossible to restore.

■ Points to check before copying

- **When using a USB HDD for the first time, or using a USB HDD that has been used with other devices, first run [FORMAT MEDIA].**
- Before copying, go to [MEDIA STATUS] to check the amount of free space on the USB HDD.
- In the following cases, copying may take longer:
 - There are lots of scenes
 - The temperature of this unit is high
- If you copy protected scenes or still pictures, the protection setting of the copied scenes or still pictures are canceled.
- The order in which the scenes were copied cannot be changed.

Before you delete the data on the media after copying is complete, be sure to play back the USB HDD to check that they have been copied to correctly. (→ 113)

■ Formatting

This is for initializing the USB HDD.

- **Please be aware that if a media is formatted then all the data recorded on the media is erased and cannot be recovered. Back up important data on a PC etc.**
- **Connect this unit to the USB HDD and touch [Playback HDD].**

MENU : [SETUP] → [FORMAT MEDIA] → [HDD]

- When formatting is complete, touch [EXIT] to exit the message screen.
- Connect this unit and the USB HDD to format.
You may no longer be able to use the USB HDD if you format them on another device such as a PC etc.

■ Displaying media information

The used space of the USB HDD can be checked.

- **Connect this unit to the USB HDD and touch [Playback HDD].**

MENU : [SETUP] → [MEDIA STATUS]

- [HC-V720] / [HC-V710]
If you touch [CHANGE MEDIA], you can switch the display between the SD card and USB HDD.
[HC-V720M]
If you touch [CHANGE MEDIA], you can switch the display between the SD card, built-in memory, and USB HDD.

Simple copy

1 Connect this unit to the USB HDD to prepare for copying. (→ 109)

- You cannot supply power to the USB HDD from this unit.

2 Touch [Simple copy].

- When [Copy selected files] or [Playback HDD] is selected, terminate the connection with the USB HDD (→ 113), and then perform the operation of Step 1.

3

Touch the media you want to copy.

4 Touch [YES].

5 Touch [EXIT] when the copy complete message is displayed.

- The thumbnail view of the copy destination is indicated.

When you stop copying halfway:

Touch [CANCEL] while copying.

Copy selected files

1 Connect this unit to the USB HDD to prepare for copying. (→ 109)

- You cannot supply power to the USB HDD from this unit.

2 Touch [Copy selected files].



- You can also copy scenes or still pictures by touching  , selecting [COPY].



3 /

Touch [NEXT].





Touch the media you want to copy.

 →  : When copying from the SD card to the USB HDD.

 →  : When copying from the built-in memory to the USB HDD.

* Please refer to page 106 for information on copying files between the SD card/built-in memory.

4 Touch the desired items following the instructions on the screen.

- It will return to the previous step by touching .
- (When [SELECT SCENES] is selected)
When touched, the scene/still picture is selected and the  indication appears on the thumbnail. Touch the scene/still picture again to cancel the operation.
- (When [SELECT DATE] is selected)
When touched, the date is selected and surrounded by red. Touch the date again to cancel the operation.
- Up to 99 scenes/ 99 dates can be selected continuously.

5 Touch [EXIT] when the copy complete message is displayed.

- The thumbnail view of the copy destination is indicated.

When you stop copying halfway

Touch [CANCEL] while copying.

Playing back the USB HDD

- Only motion picture/still picture that have been copied by connecting this unit to the USB HDD or copied with HD Writer AE 5.0 can be played back.

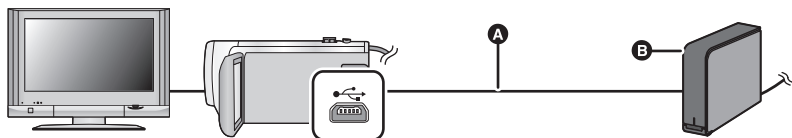

- A** USB Connection Cable (supplied with recommended USB HDD)
- B** Recommended USB HDD (commercially-available)

1 Connect this unit to the USB HDD to prepare for playback. (→ 109)

- When playing back on a TV, connect this unit to the TV. (→ 100)

2 Touch [Playback HDD].

3 Touch the scene or still picture to be played back and then play it back.

- The playback operation is performed the same as when playing back motion pictures or still pictures. (→ 27, 78)

To terminate the connection between this unit and the USB HDD

Touch  on the Touch Menu.

- Disconnect the USB Connection Cable from this unit.

- It is also possible to switch the media to play back by touching the play mode select icon. When the USB HDD is connected, the  (USB HDD) can be selected from the displayed media types. (→ 27)

HC-V720 / **HC-V710**

The scenes you have saved in Highlight Playback during playback of the USB HDD are saved in the SD card.

HC-V720M

The scenes you have saved in Highlight Playback during playback of the USB HDD are saved in the built-in memory. If you touch [COPY] after saving, you can copy them to the SD card.

- Deleting scenes and still pictures on the USB HDD may take time.
- You cannot set the following items during playback of  (USB HDD).

- [SCENE PROTECT]
- [DELETE PERSONAL INFO]
- [SECTION DELETE]
- [DIVIDE]
- [SPLIT&DELETE]
- [CONVERT TO MP4]



HC-V720M

- [RELAY SCENE COMBINE]
- [RELAY INFO CANCEL]

Dubbing with a Blu-ray disc recorder, video device, etc.

■ Check before dubbing

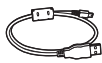
Check the equipment used for dubbing.

Equipment used for dubbing	Dubbing picture quality	To dub
Equipment with SD card slot	High-definition picture quality*	Insert the SD card directly (→ 115) 
Equipment with USB terminal	High-definition picture quality*	Connect with supplied USB cable (→ 115) 
Equipment without SD card slot or USB terminal	Standard picture quality This can be played back on equipment incompatible with high-definition (AVCHD), so it is convenient if you are dubbing for distribution.	Connect with Composite video cable (commercially-available) (→ 117) 

* Some equipment may not be compatible with high-definition (AVCHD) picture quality. In such a case, connect with the Composite video cable (commercially-available) and dub with standard picture quality. (→ 117)

- For the positions of the SD card slot, USB terminal, or terminal for connecting the Composite video cable, refer to the operating instructions of the equipment used.
- The iFrame and MP4 scenes cannot be dubbed by inserting SD cards or by connecting with the USB cable. To dub iFrame and MP4 scenes, refer to page 117.

You can dub using a Panasonic Blu-ray disc recorder or high-definition (AVCHD) compatible DVD recorder.

- Depending on the recorders or the media to be copied to, you may not be able to copy in high-definition (AVCHD) picture quality. For further details, see the operating instructions of your recorder.
- The scenes recorded in 1080/60p recording mode can only be dubbed to a Blu-ray disc using the AVCHD Progressive compatible devices. The scenes recorded in 1080/60p recording mode are not displayed when connected to the product that is not compatible with AVCHD Progressive.
- Note that the equipment described may not be available in certain countries and regions.



■ To dub using equipment with an SD card slot

You can dub by directly inserting an SD card.

- **HC-V720M**

To copy scenes or still pictures from the built-in memory to an SD card, see page 106.

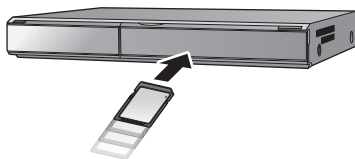

■ To dub using equipment with a USB terminal

You can dub by connecting a USB cable.

- Use the AC adaptor to free you from worrying about the battery running down.
- Turn on the unit.

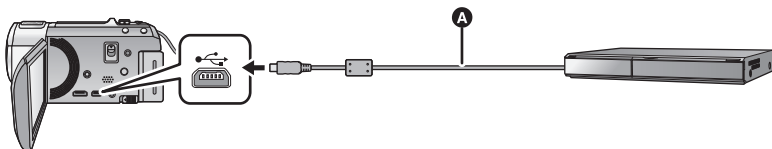

- **A** USB cable (supplied)

- Insert the plugs as far as they will go.

1 Connect the unit to the Blu-ray disc recorder or high-definition (AVCHD) compatible DVD recorder.

- The USB function selection screen will appear on the screen of the unit.

2 Touch [RECORDER] on the screen of this unit.

- When you select an option other than [RECORDER], reconnect the USB cable.

- **HC-V720** / **HC-V710**

When using the battery, the LCD monitor turns off after about 5 seconds. Touch the screen to turn the LCD monitor on.

3 **HC-V720M**

Touch the media you wish to dub.



- When using the battery, the LCD monitor turns off after about 5 seconds. Touch the screen to turn the LCD monitor on.

4 Dubbing through operations on the Blu-ray disc recorder or high-definition (AVCHD) compatible DVD recorder.

- **HC-V720M**

Do not touch [CHANGE MEDIA] on the screen of the unit during dubbing.

About the screen indication of the unit

- When the unit is accessing the SD card, card access icon () appears on the unit screen or the access lamp is on.
- **HC-V720M**
When the unit is accessing the built-in memory, built-in memory access icon () appears on the unit screen or the access lamp is on.
- Be careful not to disconnect the USB cable, AC adaptor or battery while the unit is accessing the media, as this may result in the loss of recorded content.

-
- Do not use any other USB cables except the supplied one. (Operation is not guaranteed with any other USB cables.)
 - When this unit is connected to a Panasonic Blu-ray disc recorder or a DVD recorder using a USB cable while the unit is turned on, power is also supplied from the connected equipment to this unit.
 - For details on dubbing and playback methods, read the operating instructions of the Blu-ray disc recorder or DVD recorder.
 - When you connect the unit to a Blu-ray disc recorder, a dubbing operations screen may appear on the television connected to the Blu-ray disc recorder. In this case as well, perform the operations of Steps 1 to 4.
 - You cannot change the mode of the unit or turn off the unit while it is connected to a Blu-ray disc recorder or DVD recorder. Disconnect the USB cable before performing either of these operations.
 - If the battery runs down during dubbing, a message will appear. Operate the Blu-ray disc recorder to cancel the dubbing.
 - **HC-V720M**

If you convert the recording format of the scenes recorded in 1080/60p to 1080/60i, you can dub them to devices that do not support AVCHD Progressive. (→ 106)



■ Dubbing using equipment without an SD card slot or a USB terminal, or using a video device

You can dub by connecting a Composite video cable (commercially-available).

- Use the AC adaptor to free you from worrying about the battery running down.

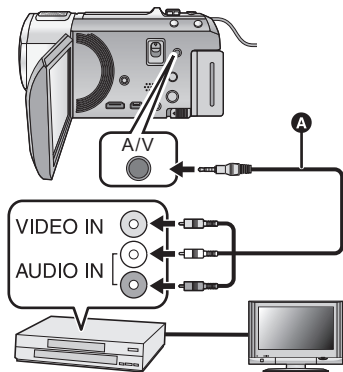

Change the video input on the video device and TV that this unit is connected to.

- The channel set will differ depending on the terminal to which the unit is connected.
- See the operating instructions of the video device for details.
- Insert the plugs as far as they will go.
- ▲ Composite video cable (commercially-available)

- Change the mode to .

1 Connect this unit to a video device and start playback on this unit.

2 Start recording on the connected device.

- To stop recording (dubbing), stop playback on this unit after stopping recording on the recorder.

-
- If the date and time display and function indication are not wanted, cancel them before dubbing. (→ 32, 101)

If the dubbed images are played back on a wide-screen TV, the images may be stretched vertically.

In this case, refer to the operating instruction for the device you are connecting to or read the operating instructions of the wide-screen TV and set the aspect ratio to 16:9.

Using the Eye-Fi™ card

By using an Eye-Fi card (commercially-available), you can record motion pictures and still pictures on the card, and save them on a PC or upload them on a file-sharing website via a wireless network.

- The functions of the Eye-Fi card (including wireless transmission) are not guaranteed to work on this product. In the case of a malfunction of the card, please contact the card manufacturer.
- To use the Eye-Fi transfer feature, a broadband wireless LAN environment is required.
- To use the Eye-Fi card, permission from the national or regional government is required. Do not use if you have not obtained permission. If you are unsure as to whether use is permitted, please check with the card manufacturer.
- To prevent the interception of communications, misuses, identity thefts, etc., we strongly recommend you configure the appropriate security settings (encryption settings). For details, refer to the manuals of your Eye-Fi card and access point.
- **Install the software supplied with the Eye-Fi card in advance on your PC, and configure the Eye-Fi settings. (For settings methods etc., please read the card operating instructions or consult the card manufacturer)**

- **Insert an Eye-Fi card (commercially available) in the unit.**

- **HC-V720M**

(When using in the Motion Picture Recording Mode or Still Picture Recording Mode)

Set the card to be used as the recording media. (→ 20)



(When using in the Playback Mode)

Select the play mode select icon from the thumbnail screen, and set the media to  (card). (→ 27)

Select the menu.

[MENU] : [SETUP] → [Eye-Fi TRANSFER] → [ON]

- When [Eye-Fi TRANSFER] is set to [ON], the transferrable files will be transferred automatically.
- To cancel the transferring of a file, turn off the unit or set [Eye-Fi TRANSFER] to [OFF].
- The setting at the time of purchase is [OFF]. Every time the Eye-Fi card is removed from the unit, this setting is set to [OFF].
- Eye-Fi transfers are not available during motion picture recording.
- You can check the file transfer status on the thumbnail screen.

	File has been transferred
	File waiting for transfer
	File cannot be transferred

■ Using Eye-Fi direct mode

The files can be transferred directly from the Eye-Fi card to a smartphone without going through the wireless access point when necessary setting is performed in a PC in advance.

- **Install the software supplied with the Eye-Fi card on your PC, and configure the Eye-Fi direct mode settings.**
 - **Insert the Eye-Fi card (commercially available) in the unit.**
- Select the menu.**



 : [SETUP] → [Eye-Fi DIRECT]

- This mode is displayed only when [Eye-Fi TRANSFER] is set to [ON].
- The mode will be canceled using the following steps.
 - When the unit is turned off
 - If you start recording motion pictureIn addition to the steps above, the mode may also be canceled by the Eye-Fi card.
- When connected via Eye-Fi direct mode, [ECONOMY (BATT)]/[ECONOMY (AC)] are disabled.

■ Selecting files to transfer



If you perform the required settings in advance on your PC, you can transfer selected files alone. For settings methods etc., please read the card operating instructions or consult the card manufacturer.

- **Install the software supplied with the Eye-Fi card on your PC, and configure the selection transfer settings.**
- **Insert an Eye-Fi card (commercially available) to the unit.**

●  / 

Change the mode to  and touch the play mode select icon. Then, select [iFrame], [MP4] or [PICTURE]. (→ 27)





Change the mode to  and touch the play mode select icon, and set the media to  (card), and set the motion picture/still picture to [iFrame], [MP4] or [PICTURE]. (→ 27)

Select the menu.

 : [VIDEO SETUP] or [PICT. SETUP] → [TRANSFER/PROTECT]

- The setting method is the same as that for the scene protect settings. (→ 96)
- If the selected transfer setting is not configured on the computer, [SCENE PROTECT] is displayed and the selected transfer setting cannot be configured.
- When the write protect switch on the Eye-Fi card is on the LOCK side, [SCENE PROTECT] is displayed and selected transfer setting is disabled. Please unlock the write protect switch.
- The protect setting is also applied to the files for which [TRANSFER/PROTECT] is set. To delete a file, first cancel [TRANSFER/PROTECT] and then perform the operation.
- AVCHD scenes cannot be used as the selected transfer setting.

- The Eye-Fi menu only appears when an Eye-Fi card is used.
- The Eye-Fi transfer feature cannot be guaranteed to continue to operate in the future due to changes to the card specification etc.
- Update the firmware of the Eye-Fi card to the latest one using the software supplied with the Eye-Fi card before use.
- When the endless memory function of the Eye-Fi card is set to on, the files transferred from the card may be deleted automatically.
- The Eye-Fi card may heat up as a result of the files being transferred. Note that the use of an Eye-Fi card accelerates the battery drain, so we recommend you use the card in Playback Mode.
- The Eye-Fi setting can be checked while pausing the recording.

	[Eye-Fi TRANSFER] is set to [ON] (Transferring in Eye-Fi direct mode)
	[Eye-Fi TRANSFER] is set to [ON]
	[Eye-Fi TRANSFER] is set to [OFF]

- If the Eye-Fi card is removed and then reinserted into the unit, set functions related to Eye-Fi again from the menu.
- When using the Eye-Fi card, please be sure to unlock the write-protect switch. (→ 13)
- Before deleting the files, please confirm they have been transferred to your PC and uploaded to the sharing site.
- Do not use the Eye-Fi card in locations where the use of wireless devices is forbidden, such as inside aircraft etc.
- Depending on network conditions, the transfer may take some time. Also, if network conditions deteriorate, the transfer may be suspended.
- Files over 2 GB in size cannot be transferred. Such files should first be split to reduce the file size. (→ 94)

Wi-Fi[®] function

■ Use this unit as a wireless LAN device

When using equipment or computer systems that require more reliable security than wireless LAN devices, ensure that the appropriate measures are taken for safety designs and defects for the systems used. Panasonic will not take any responsibility for any damage that arises when using this unit for any purpose other than as a wireless LAN device.

■ Use of the Wi-Fi function of this unit is presumed to be in countries where this unit is sold

There is the risk that this unit violates the radiowave regulations if used in countries other than those where this unit is sold, and Panasonic takes no responsibility for any violations.

■ There is the risk that data sent and received via radio waves may be intercepted

Please note that there is the risk that data sent and received via radio waves may be intercepted by a third party.

■ Do not use this unit in areas with magnetic fields, static electricity or interference

- Do not use this unit in areas with magnetic fields, static electricity or interference, such as near microwave ovens. Radio waves may not reach this unit.
- Using this unit near devices such as cordless telephones or any other wireless LAN device that use the 2.4 GHz radio wave band may cause a decrease in performance in both devices.

■ Do not connect to the wireless network you are not authorized to use

When this unit utilizes its Wi-Fi function, wireless networks will be searched automatically. When this happens, wireless networks that you are not authorized to use (SSID*) may be displayed, however do not attempt to connect to the network as it may be considered as unauthorized access.

* SSID refers to the name of device that is used to identify a network over a wireless LAN connection. If the SSID matches for both devices, transmission is possible.

■ Before use

To use the Wi-Fi function with this unit, you need a wireless access point or destination device equipped with a wireless LAN function.

-
- This unit cannot be used to connect to a public wireless LAN connection.
 - Use a IEEE802.11b, IEEE802.11g or IEEE802.11n compatible device when using a wireless access point.
 - When using a wireless access point, we strongly recommend that you set a encryption to maintain information security.
 - When sending scenes or still pictures, we recommend you use the AC adaptor. If you are using the battery, we recommend you use a fully charged one.
 - When sending motion pictures or still pictures on a mobile network or tethering, high packet data fees may be incurred depending on the details of your contract.
 - This unit may not connect to a wireless access point depending on the radio wave condition.

- When sending motion pictures or still pictures with the Wi-Fi function, do not cover the Wi-Fi transmitter with your hand. (→ 9)
- When the battery indicator is flashing red, the connection with other equipment may not start or the connection may be disrupted.
- The Wi-Fi transmitter may become warm when using the Wi-Fi function; however this is not a sign of a malfunction. (→ 9)

What you can do with the Wi-Fi function and the preparations

By linking with Wi-Fi compatible devices, you can use the Wi-Fi functions of **[Link to Cell]**, **[DLNA Play]**, **[Live Cast]** and **[Home Cam]**.

Before using the respective Wi-Fi functions, check and prepare your device.

- For the operations and settings of your device such as the smartphone, please read the operating instructions of the device.
- In this Operating Instructions,
 - The smartphone and tablet are indicated as “smartphone”.

[Link to Cell]

Linking with the smartphone, you can operate this unit from a remote location.

Caution:

Be sure to pay special attention to the privacy, the Portrait rights, etc. of the subject when you use this function. Use at your own risk.

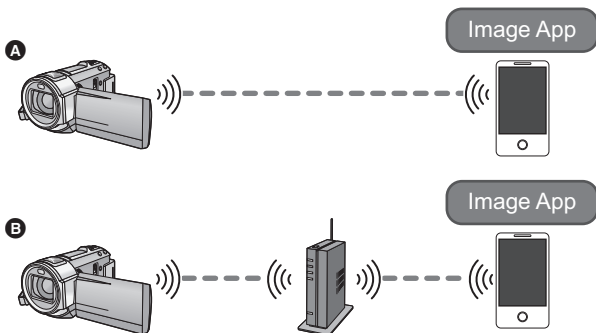

A When connecting to a smartphone

- 1 Install the smartphone application “Image App” on your smartphone. (→ 126)
 - 2 Check if the smartphone is an Android™ (NFC-compatible), Android (non-NFC-compatible), or iOS device
- If a message asking you to touch the NFC mark on the device is displayed when starting up the “Image App”, you can connect using NFC.

If the smartphone is an Android (non-NFC-compatible) or iOS device, proceed to “Connecting to a smartphone” (→ 133) when you complete the preparation above. In the case of an Android (NFC-compatible) device, proceed to “Recording/playing back with Link to Cell operations” (→ 137).

B When connecting to a wireless access point

- 1 Check if the wireless access point is compatible with IEEE802.11b, IEEE802.11g, or IEEE802.11n.
- 2 Install the smartphone application “Image App” on your smartphone. (→ 126)

- ③ Check if the smartphone is an Android (NFC-compatible), Android (non-NFC-compatible), or iOS device in advance
- If a message asking you to touch the NFC mark on the device is displayed when starting up the “Image App”, you can connect using NFC.

When the preparation above is complete, proceed to “Connecting to a wireless access point” (→ 128).

[DLNA Play]

You can play back scenes and still pictures from this unit to a DLNA compatible device connected to your home network.

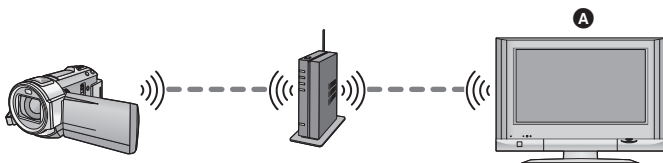

A DLNA-compatible Device

- ① Check if the wireless access point is compatible with IEEE802.11b, IEEE802.11g, or IEEE802.11n.
- ② Check if the Device is DLNA-compatible

When the preparation above is complete, proceed to “Connecting to a wireless access point” (→ 128).

[Live Cast]

Using the “LUMIX CLUB” and USTREAM services, you can broadcast live motion pictures

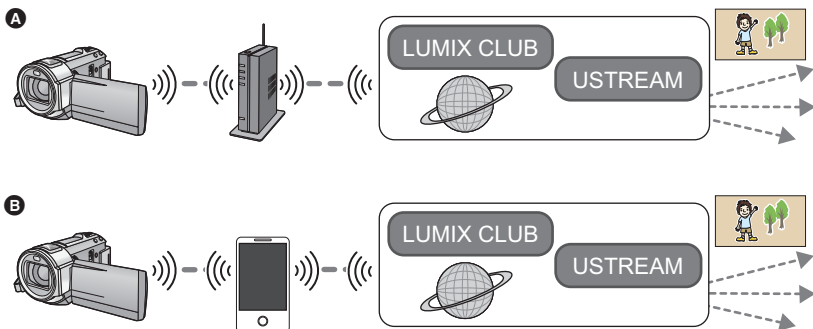

- A When connecting to a wireless access point
- B Tethering connection (smartphone)

Caution:

Be sure to pay special attention to the privacy, the Portrait rights, etc. of the subject when you use this function. Use at your own risk.

- ① (When connecting to a wireless access point)
Check if the wireless access point is compatible with IEEE802.11b, IEEE802.11g, or IEEE802.11n.

(For tethering connection)

Check if your smartphone is compatible with the tethering function.

- 2 Acquire a USTREAM ID/Password/Program on the smartphone or PC (→ 127).
- 3 Acquire a "LUMIX CLUB" ID/Password. (→ 127).
- 4 Configure the USTREAM broadcast settings on the "LUMIX CLUB" (→ 127).

When the preparation above is complete, proceed to "Connecting to a wireless access point" (→ 128).

[Home Cam]

You can confirm the recording screen of this unit from outside using a smartphone.

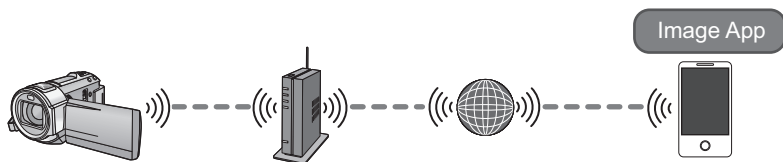

Caution:

This function is not designed for anti-theft or disaster use.



- 1 Check if the wireless access point is compatible with IEEE802.11b, IEEE802.11g, or IEEE802.11n.
 - 2 Install the smartphone application "Image App" on your smartphone. (→ 126)
 - 3 Check if the smartphone is an Android (NFC-compatible), Android (non-NFC-compatible), or iOS device
- If a message asking you to touch the NFC mark on the device is displayed when starting up the "Image App", you can connect using NFC.

When the preparation above is complete, proceed to "Connecting to a wireless access point" (→ 128).

Install the “Image App”

Installing the “Image App”

The “Image App” is an application provided by Panasonic.

	For Android apps	For iOS apps
Version	1.0 (As of December 2012)	
OS	Android 2.2~Android 4.0	iOS 4.3~iOS 6.0
Installation procedure	<ol style="list-style-type: none">1 Connect your Android device to a network.2 Select “Google Play™ Store”.3 Enter “Image App” into the search box.4 Select “Image App” and install it. <ul style="list-style-type: none">• The icon will be added to the menu. 	<ol style="list-style-type: none">1 Connect your iOS device to a network.2 Select “App StoreSM”.3 Enter “Image App” into the search box.4 Select “Image App” and install it. <ul style="list-style-type: none">• The icon will be added to the menu. 

- The service may not be able to be used properly depending on the type of smartphone being used. For compatible devices, see the following support site.

http://panasonic.jp/support/global/cs/e_cam/ (This Site is English only.)

- When downloading the app on a mobile network, high packet data fees may be incurred depending on the details of your contract.

Acquire a USTREAM ID/Password/Program

Acquire a USTREAM ID/Password/Program using a smartphone or a PC.

About the USTREAM

With this video-sharing website, you can stream and watch motion pictures this unit is recording.

Refer to the USTREAM site for details.

<http://www.ustream.tv/>

- Operation cannot be guaranteed on future USTREAM services and updates. The service content and screens which can be used are subject to change without prior notice. (This service is current as of December 2012)

Acquire a “LUMIX CLUB” Login ID/Password

- When you connect this unit to a wireless access point (→ 128), you can acquire a “LUMIX CLUB” Login ID/Password with this unit. (→ 154)

Use linked services with “LUMIX CLUB”

To use the Live Cast, access following website.

<http://lumixclub.panasonic.net/eng/c/>

- Log in to the “LUMIX CLUB” and register/set up the USTREAM on WEB service link setup.

Connecting to Wi-Fi

To use the Wi-Fi function, connect this unit to a wireless access point or smartphone via Wi-Fi.

If the clock has been set for the first time, the confirmation message for the Wi-Fi settings will be displayed. Touch [YES], and then configure the access point settings below.

■ About the status indicator and the connection status icon when connected to Wi-Fi

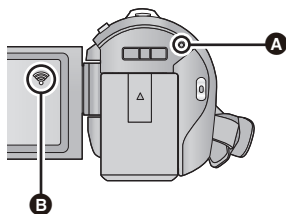

A Lit green

- The status indicator is lit green while this unit is connected to a destination device after completing a Wi-Fi connection.
- When Wi-Fi is disconnected, the status indicator is lit red again.

B The connection status icon

When connected to wireless access point:

📶 connected to Wi-Fi / 📶 not connected to Wi-Fi

- The display will change as follows according to the radio wave intensity: 📶 → 📶 → 📶 → 📶 .

When directly connected:

📶 connected to Wi-Fi / 📶 not connected to Wi-Fi

Connecting to a wireless access point

Check if the wireless access point you are using is compatible with WPS.

- If the wireless access point is compatible with WPS: Proceed to the following [Easy Connection (WPS)]
- If the wireless access point is not compatible with WPS: [Manual Connection] (→ 130)
- WPS is an abbreviation for Wi-Fi Protected Setup™.

[Easy Connection (WPS)]

■ If this is the first time the Wi-Fi button is pressed.

- 1 Press the Wi-Fi button. 
- 2 Touch [YES].
- 3 Touch [Easy Connection (WPS)].

4 Set the wireless access point to waiting for WPS.

- For further details, please read the operating instructions for the wireless access point.
- A message is displayed when the connection is complete.
- A message is displayed when the connection attempt fails. Touch [EXIT], and set the connection again.



Enter a PIN code to set the Wi-Fi connection

1 Touch [PIN code] in Step 4.

2 Touch the wireless access point to be connected.

- If you touch [Refresh], you can search for wireless access points again.

3 Touch [ENTER].

4 Enter the PIN code displayed on this unit screen into the wireless access point.

- For further details, please read the operating instructions for the wireless access point.

5 Touch [NEXT].

- A message is displayed when the connection is complete.
- A message is displayed when the connection attempt fails. Touch [EXIT], and set the connection again.

■ When setting from the Wi-Fi setup menu

1 Press Wi-Fi button.

2 Touch [Wi-Fi Setup].

3 Touch [Wireless Settings].

4 Touch a Blank row.

- For information on how to delete wireless access points or change the search order of wireless access points, please refer to [Wireless Settings] on page 151.

5 Touch [Easy Connection (WPS)].

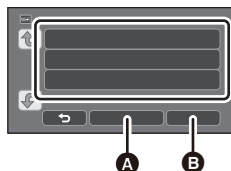

A [Delete]

B [ENTER]

6 Set the wireless access point to waiting for WPS.

- For further details, please read the operating instructions for the wireless access point.
- A message is displayed when the connection is complete.

Enter a PIN code to set the Wi-Fi connection

1 Touch [PIN code] in Step 4.

2 Touch the wireless access point to be connected.

- If you touch [Refresh], you can search for wireless access points again.

3 Touch [ENTER].



4 Enter the PIN code displayed on this unit screen into the wireless access point.

- For further details, please read the operating instructions for the wireless access point.

5 Touch [NEXT].

- A message is displayed when the connection is complete.
- A message is displayed when the connection attempt fails. Touch [EXIT], and set the connection again.

Confirming that the Wi-Fi connection is complete

- The status indicator of this unit is lit green
-  is displayed on the screen

When the preparations for the Wi-Fi function (→ 123) and the Wi-Fi connection are complete, you can use the following functions:

- [Link to Cell] (→ 137)
- [DLNA Play] (→ 142)
- [Live Cast] (→ 143)
- [Home Cam] (→ 147)

[Manual Connection]

- Confirm Encryption key of the selected wireless access point if the network authentication is encrypted.
- When connecting by [Manual Setting], confirm the SSID (Identification name), Authentication method, Encryption type, and Encryption key (Password) of the wireless access point you are using.

■ If this is the first time the Wi-Fi button is pressed

1 Press Wi-Fi button. 

2 Touch [YES].

3 Touch [Manual Connection].

4 Select [Search for wireless network] or [Manual Setting].

[Search for wireless network]: Allows you to search for wireless access points, select one, and set it. (→ 131)

[Manual Setting]: Allows you to configure detailed settings by entering the SSID of the wireless access point you want to connect to. (→ 132)

■ When setting from the Wi-Fi setup menu

- 1 Press Wi-Fi button. 
- 2 Touch [Wi-Fi Setup].
- 3 Touch [Wireless Settings].
- 4 Touch the part with no display of a wireless access point.
 - For information on how to delete wireless access points or change the search order of wireless access points, please refer to [Wireless Settings] on page 151.
- 5 Touch [Manual Connection].
- 6 Select [Search for wireless network] or [Manual Setting].



- A** [Delete]
B [ENTER]

[Search for wireless network]:	Allows you to search for wireless access points, select one, and set it. (→ 131)
[Manual Setting]:	Allows you to configure detailed settings by entering the SSID of the wireless access point you want to connect to. (→ 132)

■ When connecting by [Search for wireless network]

- 1 Touch [Search for wireless network].
- 2 Touch the wireless access point to connect.
 - If you touch [Refresh], you can search for wireless access points again.
- 3 Touch [ENTER].
 - If an Encryption key (Password) is not set, the connection is complete and a message is displayed.
- 4 (When there is an Encryption key)
Touch [INPUT], then enter the Password.
 - For details on how to enter characters, refer to page 65.
 - When the entry is complete, touch [Enter].
- 5 (When there is an Encryption key)
Touch [NEXT].
 - A message is displayed when the connection is complete.

Confirming that the Wi-Fi connection is complete

- The status indicator of this unit is lit green
-  is displayed on the screen

When the preparations for the Wi-Fi function (→ 123) and the Wi-Fi connection are complete, you can use the following functions:

- [Link to Cell] (→ 137)
- [DLNA Play] (→ 142)
- [Live Cast] (→ 143)
- [Home Cam] (→ 147)

■ When connecting by [Manual Setting]

1 Touch [Manual Setting].

2 Touch [INPUT], then enter the SSID of the wireless access point.

- For details on how to enter characters, refer to page 65.
- When the entry is complete, touch [Enter].

3 Touch [NEXT], and then touch the desired Network Authentication method.

Network authentication type	Encryption types that can be set
[Open]	[NONE]/[WEP]
[WEP]	There is no setup of an encryption types.
[WPA-PSK]/[WPA2-PSK]	[TKIP]/[AES]

- When [WEP] is selected, proceed according to step 5.

4 Touch the desired Encryption method.

- If you select [NONE], a message is displayed after completing the connection.

5 (When selecting [WEP]/[TKIP]/[AES])

Touch [INPUT], then enter the Password.

- For details on how to enter characters, refer to page 65.
- When the entry is complete, touch [Enter].

6 Touch [NEXT].

- A message is displayed when the connection is complete.

Confirming that the Wi-Fi connection is complete

- The status indicator of this unit is lit green
-  is displayed on the screen

When the preparations for the Wi-Fi function (→ 123) and the Wi-Fi connection are complete, you can use the following functions:

- [Link to Cell] (→ 137)
- [DLNA Play] (→ 142)
- [Live Cast] (→ 143)
- [Home Cam] (→ 147)

- Check the wireless access points instruction manual and settings when saving a wireless access point.
- The Encryption methods are [AES], [TKIP] and [WEP] in descending order of strength. We recommend you connect with the strongest possible Encryption method.
- If no connection can be established, the wireless access point's radio waves may be too weak. Refer to "Messages" (→ 173) and "Troubleshooting" (→ 175) for details.
- Transmission speed may decrease, or may not be usable depending on the environment it is used in.

Connecting to a smartphone

Check if your smartphone is compatible with WPS.

- Customers in the US should connect by entering an SSID and Password or scanning the QR code.
 - If your smartphone is compatible with WPS:
Proceed to the following [Easy Connection (WPS)]
 - If your smartphone is not compatible with WPS:
Connect by entering an SSID and Password

You can also connect by scanning the QR code displayed on this unit with a smartphone. (→ 134)

[Easy Connection (WPS)]

- 1** Press Wi-Fi button. 
- 2** Touch [Wi-Fi Setup].
- 3** Touch [Direct Connection].
- 4** Touch [Change connection type].
- 5** Touch [Easy Connection (WPS)].
- 6** Set the smartphone to WPS Mode.

Confirming that the Wi-Fi connection is complete

- The status indicator of this unit is lit green
-  is displayed on the screen

When the preparations for the Wi-Fi function (→ 123) and the Wi-Fi connection are complete, you can use the following functions:

- [Link to Cell] (→ 137)

Connecting by entering an SSID and Password

- 1** Press Wi-Fi button. 
- 2** Touch [Wi-Fi Setup].
- 3** Touch [Direct Connection].
- 4** Select the SSID displayed on this unit in the Wi-Fi setting of your smartphone.
- 5** Enter the Password displayed on this unit's screen on your smartphone.

Confirming that the Wi-Fi connection is complete

- The status indicator of this unit is lit green
-  is displayed on the screen

When the preparations for the Wi-Fi function (→ 123) and the Wi-Fi connection are complete, you can use the following functions:

- [Link to Cell] (→ 137)

■ Connecting with QR code

- 1 Press Wi-Fi button  ^{Wi-Fi}
- 2 Touch [Wi-Fi Setup].
- 3 Touch [Direct Connection].
- 4 Touch [Change connection type].
- 5 Touch [QR code].

- QR code is displayed on the screen of this unit.

6 Start up the smartphone application “Image App”.

7 Scan QR code displayed on this unit with a smartphone.

- When using an iOS device, the profile install screen will be displayed on the smartphone. After installing, close the displayed screen by pressing the Home button and relaunch the “Image App”.

Confirming that the Wi-Fi connection is complete

- The status indicator of this unit is lit green
-  is displayed on the screen

- Once the Wi-Fi function preparations (→ 123) and the Wi-Fi connection are complete, the device's image will be displayed on the smartphone screen and you can use [Link to Cell]. Please refer to page 137 for details about [Link to Cell]

-
- Transmission speed may decrease, or may not be usable depending on the environment it is used in.

If the Wi-Fi connection cannot be established

Please refer to the operating instruction of the device in use for details about the setting of the wireless access point or smartphone.

Problem	Check points
<p>It cannot connect to the wireless access point.</p> <p>The wireless access point is not detected.</p>	<p>(General)</p> <ul style="list-style-type: none">● Turn ON the wireless access point.● Approach the wireless access point and reconnect.● If it takes time to complete the connection, the Wi-Fi connection will be aborted. Reset the connection settings.● Check how to connect to the wireless access point and how to set the security settings.● Make sure the wireless access point is registered in this unit. (→ 151)● The device may be unable to locate the wireless access point due to problems with the signal. Use [Manual Connection]. (→ 130) <p>(Easy Connection)</p> <ul style="list-style-type: none">● Make sure the wireless access point is in the correct WPS standby mode.● Make sure the PIN code has been correctly input. <p>(Manual Connection)</p> <ul style="list-style-type: none">● Make sure the SSID and password have been correctly input.● Check the Authentication method, Encryption type, and Encryption key (Password).
<p>Radio waves of the wireless access point get disconnected.</p>	<ul style="list-style-type: none">● The condition may be improved by moving the location or changing the angle of the wireless access point.● If you use another 2.4 GHz band device such as a microwave oven or cordless telephone nearby, you may interrupt the signal. Keep a sufficient distance from these types of devices.

Problem	Check points
<p>The Wi-Fi connection is not possible between this unit and a smartphone.</p>	<p>(Wireless Access Point Connection)</p> <ul style="list-style-type: none"> ● Make sure the smartphone is properly connected to the wireless access point by checking the Wi-Fi settings of the smartphone. ● Make sure this unit and the smartphone are connected to the same wireless access point. ● Make sure the wireless access point is registered in this unit. (→ 151) <p>(Direct Connection)</p> <ul style="list-style-type: none"> ● Make sure the smartphone is properly connected to this unit by checking the Wi-Fi settings of the smartphone. ● Make sure the SSID and password have been correctly input. ● Make sure the smartphone is not connected to the wireless access point. If it is connected to the wireless access point, change the Wi-Fi access point using the smartphone's Wi-Fi set up.
<p>It takes long time every time to connect to a smartphone.</p>	<ul style="list-style-type: none"> ● It may take longer time to connect depending on the Wi-Fi connection setting of the smartphone, but it is not a malfunction.
<p>This unit is not displayed in the Wi-Fi setting screen of the smartphone.</p>	<ul style="list-style-type: none"> ● Try switching the ON/OFF of the Wi-Fi function in the Wi-Fi settings of the smartphone.
<p>The Wi-Fi connection is disconnected immediately.</p>	<ul style="list-style-type: none"> ● If there is a setting for avoiding poor connections in the Wi-Fi setting menu of the Android device 4.0 or later version, turn it OFF.
<p>Cannot be connected using NFC.</p>	<ul style="list-style-type: none"> ● Make sure your smartphone is compatible with NFC. This unit can be used with NFC-compatible terminals via Android (OS version 2.3.3 or later). ● Make sure the NFC function of your smartphone is ON. ● Make sure this unit is not turned off with the power button. ● Some smartphones cannot be easily checked simply by touching. If this unit is not recognized even after touching, change positions and try again by touching slowly. ● Touch again if it does not connect after touch.

Recording/playing back with Link to Cell operations

Using a smartphone, you can perform record/playback operations from a remote location or upload motion pictures and still pictures recorded in this unit on SNS (Social Networking Service).

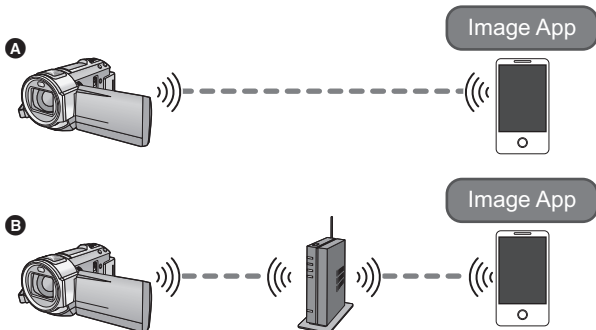

- A** When connecting to a smartphone
B When connecting to a wireless access point

- Before using, perform the preparations for using the Wi-Fi function. (→ 123)
- You need to turn on the Wi-Fi function of your smartphone and install “Image App”. (→ 126)
- Do not remove the SD card during remote operations.

• Refer to [Help] in the “Image App” menu for further details on how to operate.

Using with a direct connection

■ If the device is Android (NFC-compatible)

- Turn on the NFC function of your smartphone.

Using the NFC (Near Field Communication) function, you can easily transfer data necessary for a Wi-Fi connection between this unit and the smartphone.

- This function can be used with the NFC compatible device with Android (OS version 2.3.3 or later). (Except for some models)

1 Start up the smartphone application “Image App”.

2 Touch the smartphone on of this unit.

- If this is the first time the smartphone is connecting to this unit, touch [YES] on the screen of this unit, and then touch the smartphone on  of this unit again.
- If the unit is not recognized even when touching the smartphone, change positions and try again.
- When the connection is complete, images of this unit is displayed on the smartphone screen.

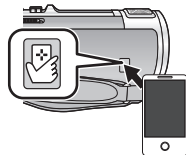

- This unit will be turned on if it is touched on the  by a smartphone even when this unit was turned off using the LCD screen.

If you touch the second smartphone when this unit has already been connected to the first one

The remote operation with the first smartphone that has been connected to this unit will be cut off, and the newly touched smartphone will be connected.

- The connection cannot be established while this unit is recording or copying a file to the smartphone during remote operations.

■ If the device is Android (non-NFC-compatible) or iOS

Proceed to Step 2 when your Wi-Fi connection has been made via [Direct Connection] in [Wi-Fi Setup] ([→ 133](#)).

1 Press Wi-Fi button and touch [Link to Cell]. 

- It will go into connection standby for remote operation.

2 Start up the smartphone application “Image App”.

- When the connection is complete, images of this unit is displayed on the smartphone screen.

To exit remote operation:

Touch [EXIT] or press Wi-Fi button.

- The message is displayed. Touch [YES] to close the indication.

-
- If you have turned off this unit with the LCD monitor, you can also turn on this unit and start the NFC communication by touching the smartphone on this unit. (If you have turned off this unit with the power button, this unit will not turn on by touching the smartphone on this unit)
 - You can register up to five smartphones. When the number exceeds five, registrations will be deleted, starting from the oldest touched one.
 - Please refer the instructions for the device you are using for information on how to set up and use a NFC-compatible smartphone.

Using with a wireless access point connection

■ If the device is Android (NFC-compatible)

● Turn on the NFC function.

Using the NFC (Near Field Communication) function, you can easily transfer data necessary for a Wi-Fi connection between this unit and the smartphone.

- This function can be used with the NFC compatible device with Android (OS version 2.3.3 or later). (Except for some models)

1 Connect the smartphone to a wireless access point.

- When you connect using NFC for the first time, please make connection of this unit and a wireless access point. (→ 128)

2 Start up the smartphone application “Image App”.

3 Touch the smartphone on of this unit.

- If the unit is not recognized even when touching the smartphone, change positions and try again.
- If the smartphone is connecting to this unit for the first time, a message is displayed again. Touch [YES].
- When the connection is complete, images of this unit is displayed on the smartphone screen.
- This unit will be turned on if it is touched on the  by a smartphone even when this unit was turned off using the LCD screen.

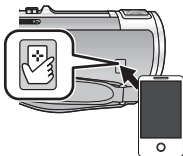

If you touch the second smartphone when this unit has already been connected to the first one

The remote operation with the first smartphone that has been connected to this unit will be cut off, and the newly touched smartphone will be connected.

- The connection cannot be established while this unit is recording or copying a file to the smartphone during remote operations.

■ If the device is Android (non-NFC-compatible) or iOS

1 Connect the smartphone to a wireless access point.

2 Press Wi-Fi button and touch [Link to Cell].

- It will go into connection standby for remote operation.



3 Start up the smartphone application “Image App”.

- When the connection is complete, images of this unit is displayed on the smartphone screen.

To exit remote operation:

Touch [EXIT] or press Wi-Fi button.

- The message is displayed. Touch [YES] to close the indication.

-
- After turning off this unit with the LCD monitor, you can also turn on this unit and start the NFC communication by touching the smartphone on  of this unit. (If you have turned off this unit with the power button, this unit will not turn on by touching the smartphone on  of this unit)
 - You can register up to five smartphones. When the number exceeds five, registrations will be deleted, starting from the oldest touched one.
 - Please refer the instructions for the device you are using for information on how to set up and use a NFC-compatible smartphone.

Screen display during remote operations

Smartphone screen shots are example displayed in Motion Picture Recording Mode and Playback Mode.

Recording screen

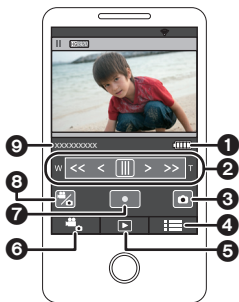

- 1 Remaining battery power of this unit
- 2 Zoom
- 3 Photoshot button
- 4 Menu display
- 5 Playback mode button
- 6 Recording mode button
- 7 Recording start/stop button
- 8 Motion Picture Recording Mode/Still Picture Recording Mode toggle button
- 9 Name of the connected device

Playback screen



- 1 Number of scenes
- 2 Camera function button
- 3 Menu display
- 4 Playback mode button
- 5 Recording mode button
- 6 Scene information display
- 7 Name of the connected device

* The screen differs depending on the operating system.

Functions available for remote operations

■ When Recording Mode

- Turning the unit off
- Selecting a mode
- Recording motion pictures/still pictures
- **HC-V720M**
 - Selecting a media to record
- Using the zoom (Available in the medium or fast speed)
- Selecting a iA/MNL mode
- White Balance
- Recording format
- Backlight Compensation
- Picture size
- Aspect Ratio
- Self-timer

■ When Playback Mode

- Playback
 - The scenes recorded in iFrame cannot playback
- **HC-V720M**
 - Selecting a media to playback (SD card/Built-in memory)
 - Switching the media (AVCHD/MP4/still picture)
 - Delete
 - Save (Copy)
 - The scenes recorded in AVCHD cannot copy
 - Only iOS devices can transfer iFrame scenes
 - Smart Home Network
 - It is possible to post to SNS or perform playback operation when this unit is connected to the DLNA-compatible TV via wireless access point using a smartphone.
 - Creating and saving scenes with Highlight Playback
(Highlight Playback cannot be used for iFrame or MP4 scenes)

-
- If you close the LCD monitor face down while recording, the LCD monitor of this unit will not display.
 - **Be sure to pay special attention to the privacy, the likeness rights, etc. of the subject when you use this function. Use at your own risk.**

DLNA Play

Connecting this unit to a DLNA-compatible device via Wi-Fi, you can play back scenes and still pictures on the device.

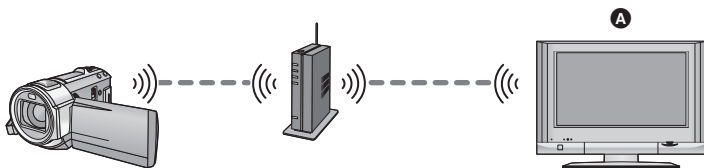

A DLNA-compatible TV

- Before using, perform the preparations for using the Wi-Fi function. (→ 124)
- Please read the operating instructions for the TV about connecting TV to the wireless access point.
- Do not remove the SD card in playing back on a TV.

1 Press Wi-Fi button.



2 Touch [DLNA Play].

- If you touch [Change AP], you can switch the wireless access point to another one that has been registered to this unit.
- If you touch [CANCEL], the Wi-Fi connection is canceled.
- When the connection is complete, the screen of this unit turns off. To display it again, touch the screen.

3 Select this unit (SSID) by the TV side.

- Select the media (SD/MEM) and select the motion picture (AVCHD) or still picture (JPEG) to play back.

4 Perform playback operations with the TV remote control.

- Playback operations may differ depending on the TV in use.
- The following operations can be performed if a color button is pushed.
Blue/Red: Skip playback
- Fast forward/Fast rewind playback cannot be performed.
- You cannot perform playback operations with this unit.

To exit the playback on the TV:

Touch [EXIT] or press Wi-Fi button.

A message is displayed. Touch [YES] to exit.

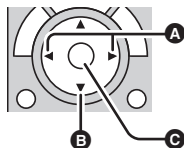

(Examples of operations during motion picture playback)

- A Skip playback
- B Stop
- C Playback/Pause

- Scenes recorded in iFrame/MP4 cannot be played back.
- Depending on the TV used, it may not playback in AVCHD picture quality even when the scene recorded in AVCHD is played back.

Live Cast

You can broadcast motion pictures of this unit live by setting up a link between the "LUMIX CLUB" and USTREAM.

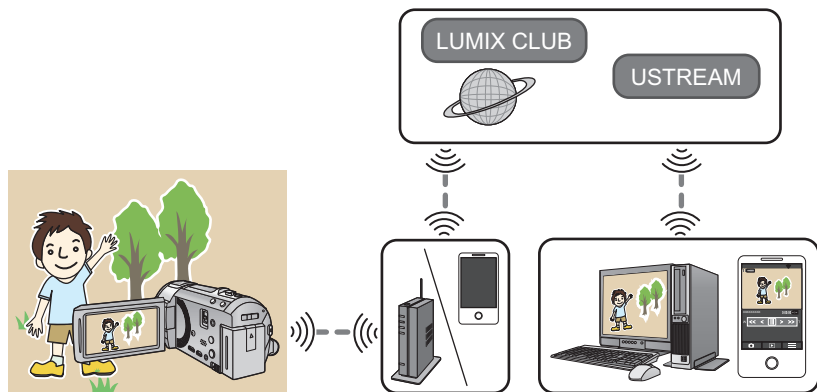

- Before using, perform the preparations for using the Wi-Fi function. (→ 124)
- Check your contract details carefully, as smartphone and internet contract details may result in high communication charges being incurred, or a limit placed on communication traffic.

1 Press Wi-Fi button. 

2 Touch [Live Cast].



- If a "LUMIX CLUB" Login ID and Password has not been registered to this unit yet, enter them according to the screen.
- If you touch [Change AP], you can switch the wireless access point to another one that has been registered to this unit.
- When the connection is made correctly, the screen of this unit switches to the Live Cast Mode.

■ To send e-mails

You can send e-mails containing such information as the USTREAM channel name or the scheduled broadcast date.

- This unit can only set the scheduled broadcast date. (→ 145) For other settings, set them on the "LUMIX CLUB".
- On the "LUMIX CLUB", register the destination addresses of the e-mail in advance.

Touch .



-  /  /  will disappear when no touch function is performed for a specific period of time. To display them again, touch the screen.



A [EXIT]

■ To start the live broadcast

Touch .



- If you press the start recording button, you can simultaneously record the broadcast to this unit.
-  /  /  will disappear when no touch function is performed for a specific period of time. To display them again, touch the screen.



A [EXIT]

■ To stop the live broadcast

Touch .





- When  (gray) is displayed, unsent data is present. Wait until the unsent data is sent and  is displayed.

To exit the Live Cast Mode

Touch [EXIT] or press Wi-Fi button.

- A message is displayed. Touch [YES] to exit.

■ About the screen indications in the Live Cast Mode



 / 	Live broadcast indication
	Image quality (→ 146)
1h23m	Elapsed time of the live broadcast
12fps	Frame rate (→ 146)
 100	Number of people watching the live broadcast <ul style="list-style-type: none">• Up to 9999 viewers can be indicated. The indication does not appear when the number is 0.
	E-mail delivery setting



- Recording is performed in Intelligent Auto Mode.
- If you close the LCD monitor face down while recording, the LCD monitor of this unit will not display.
- Image content may be leaked to third parties depending on the USTREAM image publication method settings. Set the publication range and Password using USTREAM if required.
- **Be sure to pay special attention to the privacy, the likeness rights, etc. of the subject when you use this function. Use at your own risk.**

Configuring the live broadcast settings

Touch  to display the live broadcast setting screen.

-  /  /  will disappear when no touch function is performed for a specific period of time. To display them again, touch the screen.



A [EXIT]

■ To configure the e-mail delivery settings

You can make the delivery setting of a broadcast notification e-mail and the setting for the scheduled time and date of the broadcast indicated in the e-mail.

- 1 Touch [E-MAIL SETUP].
- 2 Touch [ON] or [OFF].

[ON]: Enables e-mailing.

[OFF]: Disables e-mailing.

- 3 (When [ON] is selected)
To set the scheduled broadcast date.

[AUTO]: Allows you to set to the time and date you have touched  .

[MANUAL]: Allows you to set the desired time and date.
 ● The setting method is the same as [CLOCK SET]. (→ 18)

■ To set the image quality

- 1 Touch [IMAGE QUALITY].
- 2 Touch the desired image quality.

Image quality	Picture size	Frame rate	Screen indications
[High]	1280×720	5 to 15 fps (5 to 10 fps)	1280
[Medium]	640×360	5 to 20 fps (5 to 10 fps)	640
[Low]	320×176	5 to 30 fps (5 to 15 fps)	320
[AUTO]	Use this option to check the image quality and automatically set the item.		

- Frame rate in parentheses are when recorded in simultaneously.
- If the selected image quality has an image quality higher than the one you are using, images will appear as if the frame rate is low.

■ To save in USTREAM

- 1 Touch [Save in USTREAM].
- 2 Touch [ON] or [OFF].

[ON]: Live motion pictures are saved on USTREAM.

[OFF]: Select this option not to save on USTREAM.

■ To set the image quality of a motion picture you simultaneously broadcast and record

- 1 Touch [REC MODE].
- 2 Touch desired recording mode.

[PH]/[HA]/[HG]/[HE]

■ **HC-V720M**

To select the media

- 1 Touch [MEDIA SELECT].
- 2 Touch the media for recording motion pictures.
- 3 Touch [ENTER].

Home Cam (Home Monitor)

You can confirm the recording screen of this unit from outside using a smartphone.

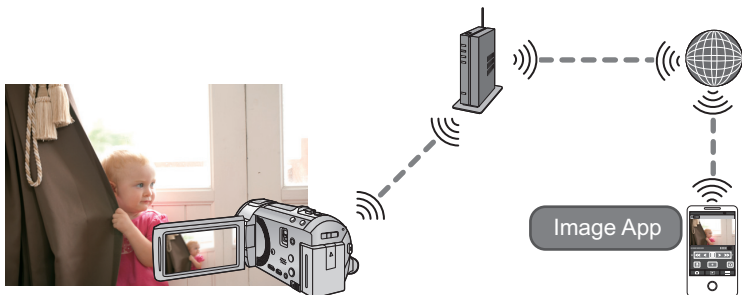

- Before using, perform the preparations for using the Wi-Fi function. (→ 125)
- Switch the Wi-Fi setting to off on your smartphone and use with mobile network such as 3G.
- Check your contract details carefully, as smartphone and internet contract details may result in high communication charges being incurred, or a limit placed on communication traffic.

- Perform the monitoring operation on the smartphone. (→ 149)
- If this is the first time you are configuring the home monitor settings, please read page 148.

■ Connecting with Android (NFC-compatible) device

• Turn on the NFC function.

Using the NFC (Near Field Communication) function, you can easily transfer data necessary for a Wi-Fi connection between this unit and the smartphone.

- This function can be used with the NFC compatible device with Android (OS version 2.3.3 or later). (Except for some models)

1 Start up the smartphone application “Image App”.

- When a Wi-Fi connection guidance screen is displayed, select [NO].

2 Display the screen of a connection setup to home monitor from the menu of a smartphone.

3 Touch the smartphone on of this unit.

- If the unit is not recognized even when touching the smartphone, change positions and try again.
- A confirmation screen is displayed on the screen of a smartphone. Touch [YES] to start home monitor.
- This unit will be turned on if it is touched on the  by a smartphone even when this unit was turned off using the LCD screen.

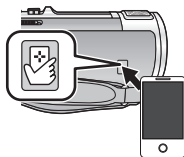

■ If the device is Android (non-NFC-compatible) or iOS

1 Press Wi-Fi button and touch [Home Cam]. 

2 Start up the smartphone application “Image App”.

- When a Wi-Fi connection guidance screen is displayed, select [NO].
- Use the smartphone to start home monitor.

When configuring the home monitor settings for the first time

■ Connecting with Android (NFC-compatible) device

● Turn on the NFC function.

Using the NFC (Near Field Communication) function, you can easily transfer data necessary for a Wi-Fi connection between this unit and the smartphone.

- This function can be used with the NFC compatible device with Android (OS version 2.3.3 or later). (Except for some models)

1 Start up the smartphone application “Image App”.

- When a Wi-Fi connection guidance screen is displayed, select [NO].

2 Display the screen of a connection setup to home monitor from the menu of a smartphone.

3 Touch the smartphone on  of this unit.

- If this is the first time the smartphone is connecting to this unit, touch [YES] on the screen of this unit, and then touch the smartphone on  of this unit again.
- If the unit is not recognized even when touching the smartphone, change positions and try again.
- A confirmation screen is displayed on the screen of a smartphone. Touch [YES] to start home monitor.

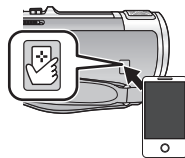

■ If the device is Android (non-NFC-compatible) or iOS

1 Press Wi-Fi button and touch [Home Cam]. 

2 Start up the smartphone application “Image App”.

- When a Wi-Fi connection guidance screen is displayed, select [NO].

3 Display the screen of a connection setup to home monitor from the menu of a smartphone.

4 Set the Device ID and Password displayed on this unit to the smartphone.

- After completing the setting, touch [ENTER].
- Use the smartphone to start home monitor.

■ When configuring the home monitor settings using QR code

1 Press Wi-Fi button. 

2 Touch [Home Cam].

3 Touch [QR code].

- QR code is displayed on the screen of this unit.

4 Start up the smartphone application “Image App”.

5 Display the screen of a connection setup to home monitor from the menu of a smartphone.

6 Scan QR code displayed on this unit with a smartphone.

- A confirmation screen is displayed on the screen of a smartphone. Touch [YES] to start home monitor.

To exit home monitoring:

Touch [EXIT] or press Wi-Fi button.

-
- If you have turned off this unit with the LCD monitor, you can also turn on this unit and start the NFC communication by touching the smartphone on this unit. (If you have turned off this unit with the power button, this unit will not turn on by touching the smartphone on this unit)
 - You can register up to five smartphones. When the number exceeds five, registrations will be deleted, starting from the oldest touched one.
 - Please refer the instructions for the device you are using for information on how to set up and use a NFC-compatible smartphone.

What you can operate/set with a smartphone during home monitoring

Refer to [Help] in the “Image App” menu for further details on how to operate.

■ What you can operate with a smartphone

Confirm the condition inside the house

The monitoring video can be confirmed.

- The monitoring image can be recorded as a video or a still picture.
- It cannot be confirmed with multiple smartphones simultaneously.
- Depending upon the environment in which the device is used, motion picture may be like a frame rate is low.

Voice message

You can talk to each other like portable wireless devices using the smartphone and this unit.

- You can talk up to 10 seconds in 20 second interval.
- Open the LCD monitor of this unit when using the Voice message function.

■ What you can set with a smartphone

Moving/non-moving object detection

This unit can detect moving objects and non-moving objects in the home monitoring detection area.

- Detection of some moving and stationary subjects may not be possible due to the condition of the subject. Check beforehand to see if detection of the moving or stationary object can be detected.
- If the movement of the subject is too fast or too slow, if the subject is too small, or if the surroundings are too dark, detection of moving and stationary objects may be impossible.

Automatic recording

You can record a motion picture on this unit as it detects a moving or non-moving object.

- Automatic recording will record for approximately 30 seconds.
- Automatic recording can record a maximum of 1 hour 15 minutes per day. Check the remaining available recording time.
- When automatic recording is performed with moving object detection, automatic recording is performed only once within the set time.
- When automatic recording is performed with non-moving object detection, the set time will be reset and non-moving object detection will start again.

Changing the home monitor settings of this unit

Setting cannot be performed while operating monitoring with a smartphone.

Touch [Setup] and select desired setting.

■ [Home Monitor Connect]

You can display the registration screen for a Device ID and Password.

■ [Remote Voice Level]

You can set the initial remote voice level and speaker volume level of the remote voice function.

 (Volume low)/  (Volume high)

- The mode cannot be switched to another one during home monitoring operations.
- Although home monitoring can be performed with the battery, we recommend you use the AC adaptor.
- It is recommended to use this unit fixed so that it will not move since it may cause false detection.
- Power of this unit will automatically turn off when monitoring condition continues for approximately 10 days.
- [REC MODE] is set to [HE].
- [ZOOM MODE] is set to [i.Zoom OFF].
- If you close the LCD monitor face down while recording, the LCD monitor of this unit will not display.
- The password for the home monitor settings will change when [Reset Wi-Fi Settings] is performed. Set the home monitor settings of the smartphone again and reconnect to this unit when [Reset Wi-Fi Settings] is performed.

How to Use the [Wi-Fi Setup] Menu

Configure various settings necessary to use the Wi-Fi function.
When connected to Wi-Fi, the settings cannot be changed.

- 1 Press Wi-Fi button. 
- 2 Touch [Wi-Fi Setup].
- 3 Touch desired menu item.

[Wireless Settings]

You can add or delete wireless access points, or rearrange the display order of wireless access points.

- Up to 3 wireless access points can be set.
- Please refer to page 128 for details about [Wireless Settings].



To add a wireless access point

- 1 Touch the part where no wireless access points are displayed.
- 2 Configure the wireless access point settings. (→ 128)

To delete a wireless access point

- 1 Touch the wireless access point to be deleted.
 - 2 Touch [Delete].
- The message is displayed. Touch [YES] to delete.

To switch the search order

- 1 Touch the access point you want to switch the order.
- 2 Switch the order by touching  or .

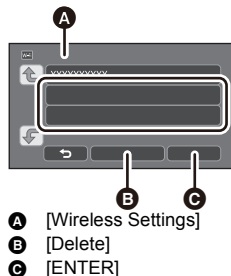

- To change the wireless access point, delete one of the registered wireless access points, and then add one.

[LUMIX CLUB]

Please refer to page 154.

[Direct Connection]

Please refer to page 133.

[Home Monitor Connect]

Please refer to page 147.

[ECONOMY (Wi-Fi)]

[ON]/[OFF]

If you set [ON], the LCD monitor turns off when remotely operating this unit with a smartphone (in Motion Picture Recording Mode or Still Picture Recording Mode) so that power consumption is reduced.

- When the LCD monitor is turned off, you can display the screen by touching it.
- If the Wi-Fi connection is turned off, this unit will turn off automatically approximately 30 minutes later.

[Menu Password]

[Setup]/[Delete]

This will set/clear the Password to limit the startup of the Wi-Fi setting menu.

By setting the Password, it will prevent erroneous operation, prevent wrongful use of the Wi-Fi function by third party, and protect the set personal information.

1 Touch [Setup].

2 Touch [INPUT], and enter the Password (6 characters).

- After finish entering the Password, touch [Enter].
- If the Password has already been set, * is displayed.
- For details on how to enter characters, refer to page 65.

3 Touch [NEXT].

4 Touch [INPUT], and enter the same Password again.

- After finish entering the Password, touch [Enter].
- If the Passwords match with each other, a message is displayed.

5 Touch [EXIT].

- If you set the Wi-Fi Password, you will need to enter the Password each time you touch [Wi-Fi Setup] on the Wi-Fi home screen.
- When you forget your Wi-Fi password, perform [Reset Wi-Fi Settings] from the Setup menu. This will set the Wi-Fi setting to the condition at the time of purchase, and you will be able to use the Wi-Fi setting menu. (→ 36)

[Start up using NFC]

[ON]/[OFF]

This item allows you to use NFC to turn on this unit, establish a remote connection, and configure the home monitoring settings.

[Reset Wi-Fi Settings]

You can change the Wi-Fi setting back to the default condition.

- The "LUMIX CLUB" Login ID and Wi-Fi password are also deleted.

[Device Name]

You can view and change this unit's device name (SSID), which is used for operating this unit as a wireless access point.

1 Touch [INPUT], and enter the desired device name (SSID).

- Input up to [20] characters are recommended. All the characters cannot be confirmed when displaying the Device names on this unit if a long Device name is used. (→ 133)
- For details on how to enter characters, refer to page 65.

2 Touch [EXIT].

-
- If you are going to connect directly to a smartphone after changing the device name (SSID), set the connection again with the changed device name (SSID) (→ 133).
 - The Password entered during the setting of direct connection cannot be changed. (→ 133)

[IP Address/DNS Settings]

You can change or check your wireless LAN's network settings, such as the [IP Address], [Subnet Mask] and [MAC Address].

[IP Address]/[Subnet Mask]/[Gateway]/[Primary DNS]/[Secondary DNS]/[MAC Address]

- If you touch [AUTO], the network settings are configured automatically. If you touch [MANUAL], you can set each item. Select the item you want to set, and set it.
- [MAC Address] cannot be changed.

Using the “LUMIX CLUB”

Acquire a “LUMIX CLUB” Login ID (free).

You can upload the scenes and still pictures recorded with this unit to WEB service with [Link to Cell] or use the [Live Cast] function if you register to “LUMIX CLUB”.

- You can set the same “LUMIX CLUB” Login ID for this unit and a smartphone.

When Login ID is acquired over the smartphone only, it is possible to register the same Login ID to this unit using the “Image App”. (→ 155)

When different Login IDs are acquired for this unit and the smartphone, change one of the Login ID and Password to the one you like to keep.

Refer to the “LUMIX CLUB” site for details.

<http://lumixclub.panasonic.net/eng/c/>

- 1 Press Wi-Fi button.** 
 - 2 Touch [Wi-Fi Setup].**
 - 3 Touch [LUMIX CLUB].**
 - 4 Touch [Add/Change Account].**
 - 5 Touch [New account].**
- Connect to the network. Proceed to the next page by touching [NEXT].
- 6 Read through the “LUMIX CLUB” terms then touch [Agree].**
- Touch [EXIT] to cancel the process without acquiring a Login ID.
- 7 Touch [NEXT] and Enter a Password.**
- Enter any combination of 8 to 16 characters and numbers for the Password.
 - For details on how to enter characters, refer to page 65.
- 8 Check the Login ID and touch [OK].**
- The Login ID (12-digit number) will be displayed automatically. When logging in to the “LUMIX CLUB” with a computer, you only need to enter the numbers.
 - Be sure to make a note of the Login ID and Password.

■ Check or change the acquired Login ID/Password

- To change the “LUMIX CLUB” Password on this unit, access the “LUMIX CLUB” website from your smartphone or PC and change the “LUMIX CLUB” Password in advance.

- 1 Press **Wi-Fi** button. 
- 2 Touch **[Wi-Fi Setup]**.
- 3 Touch **[LUMIX CLUB]**.
- 4 Touch **[Add/Change Account]**.

- 5 Touch **[Change Account]**.

- The Login ID and Password are displayed.

- The Password is displayed as “*”.

- 6 Touch **[Login ID]** or **[Password]**.

- 7 Enter the **Login ID** or **Password**, and touch **[Enter]**.

- For details on how to enter characters, refer to page 65.

- Input the Password that was changed with the smartphone or the PC.

■ Register the Login ID of the smartphone (“Image App”) into this unit

It is convenient to match the Login IDs for this unit and the smartphone (“Image App”) when using the Wi-Fi function utilizing the “LUMIX CLUB”.

- 1 Connect this unit to the smartphone.

- 2 From the “Image App” menu, set the common Login ID.

■ Check the “LUMIX CLUB” terms of use

Check the details if the terms of use have been updated.

- 1 Press **Wi-Fi** button. 
- 2 Touch **[Wi-Fi Setup]**.
- 3 Touch **[LUMIX CLUB]**.
- 4 Touch **[Terms of use]**.

- This unit will connect to the network and the terms of use will be displayed. Touch **[EXIT]** to close the menu after checking the terms of use.

■ Delete your Login ID and account from the “LUMIX CLUB”

Delete the Login ID from this unit when transferring it to another party or disposing of it. You can also delete your “LUMIX CLUB” account.

- 1 Press **Wi-Fi** button. 
- 2 Touch **[Wi-Fi Setup]**.
- 3 Touch **[LUMIX CLUB]**.
- 4 Touch **[Delete account]**.
 - The message is displayed. Touch **[NEXT]**.
- 5 Touch **[YES]** in the **Login ID delete confirmation screen**.
 - The message is displayed. Touch **[NEXT]**.
- 6 Touch **[YES]** on the **confirmation screen for deleting the “LUMIX CLUB” account**.
 - The message is displayed. Touch **[NEXT]**.
 - If you are not deleting the “LUMIX CLUB” account, only the Login ID will be erased when **[NO]** is selected.
- 7 Touch **[EXIT]**.

• Changes and other actions to Login IDs can only be made to the Login ID acquired with this unit.

Using WEB services

When sending images to WEB services, the WEB service being used must be registered with the “LUMIX CLUB”. Registering multiple WEB services will send images to all services simultaneously.

- Check the “FAQ/Contact us” on the following site for compatible WEB services.

<http://lumixclub.panasonic.net/eng/c/>

Preparation:

Make sure that you have created an account on the WEB service you want to use, and have the login information available.

- 1 **Connect to the “LUMIX CLUB” site using a smartphone or computer.**
 - 2 **Enter your “LUMIX CLUB” Login ID and Password and log in to the service.**
 - 3 **Save your email address.**
 - 4 **Select the WEB service to be used and save it.**
- Follow the instructions on the screen to save the service.

What you can do with a PC

HD Writer AE 5.0

You can copy the motion/still picture data to the HDD of PCs or write to media like Blu-ray discs, DVD discs or SD cards using HD Writer AE 5.0, the software installed in the supplied CD-ROM. Refer to the operating instructions of HD Writer AE 5.0 (PDF file) for details on how to use it.

■ Smart Wizard

The Smart Wizard Screen is automatically displayed when you connect this unit to a PC with HD Writer AE 5.0 installed. (→ 165)



Copy to PC:

You can copy motion/still picture data to the HDD of PCs.

Copy to disc:

You can copy to disc in high-definition picture quality or conventional standard picture quality (MPEG2 format).

- Select the function you wish to use and follow the on-screen instructions for easy copying.

What can be done with the HD Writer AE 5.0	Data type
Copying data to a PC Copying in Blu-ray disc/AVCHD format: <ul style="list-style-type: none"> • The scenes recorded in 1080/60p can be copied as 1080/60p. (→ 158: Important Notice) • The scenes recorded in iFrame or the scenes saved as MP4 cannot be copied in Blu-ray disc or in AVCHD format. 	Motion picture and still picture
Copying in DVD-Video format: <ul style="list-style-type: none"> • Converted to conventional standard quality (MPEG2 format). 	
Editing: Editing motion picture data copied on an HDD of a PC <ul style="list-style-type: none"> • Dividing, Trimming, Still picture, Title, Effect, Transition, BGM, Delete partially • Converting the motion picture data to MPEG2 • Converting part of motion picture into still picture 	Motion picture
Online sharing: You can upload motion pictures on the Internet and share them with your family and friends.	
Playing back on a PC: Play back the motion picture data in high-definition picture quality on a PC.	Motion picture and still picture
Formatting discs: Depending on the type of disc that you use, formatting is necessary.	Motion picture

- It is possible to play back still pictures on a PC using an image viewer standard to Windows or commercially available image browsing software, and copy still pictures to a PC using Windows Explorer.
- Please refer to page 169 for details about using a Mac.

Important Notice

- When using an SDXC Memory Card, check the following support site.
<http://panasonic.net/avc/sdcard/information/SDXC.html>
- Do not insert a disc recorded in AVCHD format with HD Writer AE 5.0 in a device that does not support the AVCHD format. In some cases the disc may get stuck in the device.
- To play back a Blu-ray disc to which you have copied scenes recorded in 1080/60p, equipment is required that supports AVCHD Progressive.
- When inserting a disc containing recorded motion pictures into other devices, a message prompting you to format the disc may be displayed. Do not format the disc, since deleted data cannot be restored later.

- It is impossible to write data to this unit from a PC.
- Motion pictures that have been recorded on another device cannot be written to the software supplied with this unit. To write motion picture data recorded with the Panasonic High Definition Video Camera sold previously, use the HD Writer supplied with the unit.
- When motion picture data is written to and read from the SD card, correct operation of the unit cannot be guaranteed if software other than that supplied with the unit is used.
- Do not start the software supplied with this unit and other software at the same time.

■ About Conversion Assist Function

When you want to convert the recording quality and write to media, the "Conversion Assist Function", which is a linking function between this unit and the HD Writer AE 5.0, is activated by connecting this unit to the PC with the USB cable. When the "Conversion Assist Function" is used, it is possible to write to media faster than when operating only on PC.

- Please refer to page 165 for details about the connection of this unit and a PC.
- Refer to the operating instructions of the software for details. (→ 168)

End User License Agreement

Before opening the CD-ROM package, please read the following.

You ("Licensee") are granted a license for the Software defined in this End User License Agreement ("Agreement") on condition that you agree to the terms and conditions of this Agreement.

Article 1 License

Licensee is granted the right to use the software, including the information recorded or described on the CD-ROM, instruction manuals, and any other media provided to Licensee (collectively "Software"), but all applicable rights to patents, copyrights, trademarks and trade secrets in the Software are not transferred to Licensee.

Article 2 Use by a Third Party

Licensee may not use, copy, modify, transfer, rent, lease, lend or allow any third party, whether free of charge or not, to use, copy or modify the Software, except as expressly provided for in this Agreement.

Article 3 Restrictions on Copying the Software

Licensee may make a single copy of the Software in whole or a part solely for back-up purpose.

Article 4 Computer

Licensee may use the Software only on one computer, and may not use it on more than one computer. Further, Licensee may not use the Software for commercial software hosting services.

Article 5 Reverse Engineering, Decompiling or Disassembly

Licensee may not reverse engineer, decompile, or disassemble the Software, except to the extent either of them is permitted under law or regulation of the country where Licensee resides. Panasonic, or its distributors will not be responsible for any defects in the Software or damage to Licensee caused by Licensee's reverse engineering, decompiling, or disassembly of the Software.

Article 6 Indemnification

The Software is provided "AS-IS" without warranty of any kind, either expressed or implied, including, but not limited to, warranties of non-infringement, merchantability and/or fitness for a particular purpose. Further, Panasonic does not warrant that the operation of the Software will be uninterrupted or error free. Panasonic or any of its distributors will not be liable for any damage suffered by Licensee arising from or in connection with Licensee's use of the Software.

Article 7 Export Control

Licensee agrees not to export or re-export to any country the Software in any form without the appropriate export licenses under regulations of the country where Licensee resides, if necessary.

Article 8 Termination of License

The right granted to Licensee hereunder will be automatically terminated if Licensee contravenes any of the terms and conditions of this Agreement. In this event, Licensee must destroy the Software and related documentation together with all the copies thereof at Licensee's own expense.

Article 9 With regard to MICROSOFT SQL SERVER COMPACT 3.5 produced by Microsoft Corporation

(1) Licensee shall use the MICROSOFT SQL SERVER COMPACT 3.5 only when included in the Software, and shall not use the MICROSOFT SQL SERVER COMPACT 3.5 in any other configuration or method. Licensee shall not publish the MICROSOFT SQL SERVER COMPACT 3.5 or work around any technical limitations in the MICROSOFT SQL SERVER COMPACT 3.5.

(2) Licensee shall not use, copy, distribute, regrant for use or otherwise handle the Software in any way beyond the range of use granted under Article 9 (1), and shall not conduct operations such as reverse engineering, decompilation, disassembling, etc. of the MICROSOFT SQL SERVER COMPACT 3.5.

(3) All rights, including copyright, patent rights etc. relating to the MICROSOFT SQL SERVER COMPACT 3.5 shall belong to Microsoft Corporation. Licensee shall not claim any rights related to the MICROSOFT SQL SERVER COMPACT 3.5 whatsoever.

Operating environment

- Even if the system requirements mentioned in this owner's manual are fulfilled, some PCs cannot be used.
- A CD-ROM drive is necessary to install the supplied software applications. (A compatible Blu-ray disc/DVD writer drive and media are necessary for writing to a Blu-ray disc/DVD.)
- Operation is not guaranteed in the following cases.
 - When 2 or more USB devices are connected to a PC, or when devices are connected through USB hubs or by using extension cables.
 - Operation on an upgraded OS.
 - Operation on an OS other than the one pre-installed.
- This software is not compatible with Microsoft Windows 3.1, Windows 95, Windows 98, Windows 98SE, Windows Me, Windows NT and Windows 2000.

■ Operating environment for HD Writer AE 5.0

PC	IBM PC/AT compatible PC
OS	Windows 8 (32 bit/64 bit) Windows 7 (32 bit/64 bit) (SP1) Windows Vista (32 bit) (SP2) Windows XP (32 bit) (SP3)
CPU	Intel Pentium 4 2.8 GHz or higher (including compatible CPU) <ul style="list-style-type: none"> ● Intel Core 2 Duo 2.16 GHz or higher or AMD Athlon 64 X2 Dual-Core 5200+ or higher is recommended when using playback function or MPEG2 output function. ● Intel Core 2 Quad 2.6 GHz or higher is recommended when using the editing or Continuous Photo Playback function. ● Intel Core i7 2.8 GHz or higher is recommended when playing back or using the editing function for 1080/60p
RAM	Windows 8/Windows 7: 1 GB or more (32 bit)/2 GB or more (64 bit) Windows Vista: 1 GB or more Windows XP: 512 MB or more (1 GB or more recommended)
Display	High Color (16 bit) or more (32 bit or more recommended) Desktop resolution of 1024×768 pixels or more (1920×1080 pixels or more recommended) Windows 8/Windows 7/Windows Vista: DirectX 9.0c compatible video card (DirectX 10 recommended) Windows XP: DirectX 9.0c compatible video card Compatible with DirectDraw overlay PCI Express™ ×16 compatible recommended Video memory of 256 MB or more recommended

Free hard disk drive space	Ultra DMA — 100 or more 450 MB or more (for installing the software) <ul style="list-style-type: none"> • When writing to a DVD/Blu-ray disc/SD, more than double the amount of free space as the disc being created is necessary.
Sound	DirectSound Support
Interface	USB port [Hi-Speed USB (USB 2.0)]
Other requirements	Mouse or equivalent pointing device Internet connection

- Supplied CD-ROM is available for Windows only.
- Input is not supported in languages other than English, German, French, Simplified Chinese and Russian.
- Operation cannot be guaranteed on all Blu-ray disc/DVD drives.
- Operation is not guaranteed on Microsoft Windows XP Media Center Edition, Tablet PC Edition, Windows Vista Enterprise, Windows 7 Enterprise or Windows 8 Enterprise.
- For Windows 8, this software is available only as a desktop application.
- This software is not compatible with a multi-boot environment.
- This software is not compatible with a multi-monitor environment.
- If using Windows XP, an administrative account user only can use this software. If using Windows Vista/Windows 7/Windows 8, administrative account and standard account users only can use this software. (An administrative account user should install and uninstall this software.)

■ To use the HD Writer AE 5.0

You will need a high performance PC depending on the functions to be used. It may not properly play back or properly operate depending on the environment of the PC used. Refer to the operating environment and notes.

- Operation during the playback may become slow if the CPU or memory is not fulfilling the requirements of the operating environment.
- Always use the most current driver for the video card.
- Always make sure there is enough capacity on the HDD in the PC. It may become inoperable or the operation may stop suddenly if the capacity gets low.

■ Operating environment for the card reader function (mass storage)

PC	IBM PC/AT compatible PC
OS	Windows 8 (32 bit/64 bit) Windows 7 (32 bit/64 bit) or SP1 Windows Vista (32 bit) (SP2) Windows XP (32 bit) (SP3)
CPU	Windows 8/Windows 7/Windows Vista: 1 GHz or higher 32-bit (×86) or 64-bit (×64) processor (including compatible CPU) Windows XP: Intel Pentium III 450 MHz or higher or Intel Celeron 400 MHz or higher
RAM	Windows 8/Windows 7: 1 GB or more (32 bit)/2 GB or more (64 bit) Windows Vista Home Basic: 512 MB or more Windows Vista Home Premium/Business/Ultimate/Enterprise: 1 GB or more Windows XP: 512 MB or more (1 GB or more recommended)
Interface	USB port
Other requirements	Mouse or equivalent pointing device

- The USB equipment operates with the driver installed as standard in the OS.

Installation

When installing the software, log on to your computer as the Administrator or with a user name with equivalent authorization. (If you do not have authorization to do this, consult your manager.)

- Before starting the installation, close all applications that are running.
- Do not perform any other operations on your PC while the software is being installed.
- Explanation of operations is based on Windows 7.

1 Insert the CD-ROM into the PC.

- The autoplay screen is displayed automatically. Click [Run setup.exe] → [Yes].
- If the autoplay screen is not displayed automatically, select [Start] → [Computer] (or double-click on [Computer] on the desktop), and then double-click [Panasonic].

2 Click [Yes].

3 Click [Next].

- Proceed with the installation by following the on-screen instructions.
- If the country or region cannot be selected, select [NTSC Area].

The PC must be rebooted for the application to work.

■ Uninstalling HD Writer AE 5.0

Follow the steps below to uninstall any software applications that you no longer require.

1 Select [Start] → [Control Panel] → [Uninstall a program].

2 Select [HD Writer AE 5.0], then click [Uninstall].

- Proceed with the uninstallation by following the on-screen instructions.
- After uninstalling the software, be sure to reboot the PC.

Connecting to a PC

- Connect this unit to the PC after the software applications are installed.
- Remove the supplied CD-ROM from your PC.

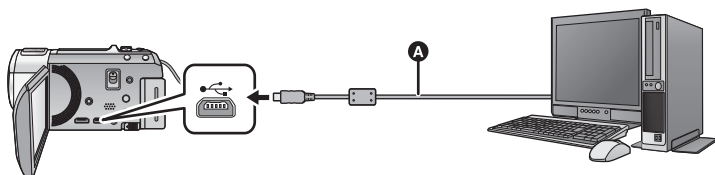

- A** USB cable (supplied)
- Insert the plugs as far as they will go.

1 Connect this unit to the AC adaptor.

- Use the AC adaptor to free you from worrying about the battery running down.
- Connect with the AC adaptor when using the Conversion Assist Function.

2 Turn on the unit.

3 Connect this unit to a PC.

- The USB function selection screen will appear.

4 Touch [PC] on the screen of this unit.

- The Smart Wizard Screen is automatically displayed when HD Writer AE 5.0 is installed.
- This unit is automatically recognized as an external drive of the PC. (→ 167)
- When you select an option other than [PC], reconnect the USB cable.
- When using the battery, the LCD monitor turns off after about 5 seconds. Touch the screen to turn the LCD monitor on.



-
- Do not use any other USB cables except the supplied one. (Operation is not guaranteed with any other USB cables.)
 - When this unit is connected to a PC using a USB cable while the unit is turned on, power is also supplied from the PC to this unit.
 - When performing reading/writing between a PC and an SD card, be aware that some SD card slots built into PCs and some SD card readers are not compatible with the SDHC Memory Card or SDXC Memory Card.
 - When using an SDXC Memory Card, check the following support site.
<http://panasonic.net/avc/sdcard/information/SDXC.html>

■ To disconnect USB cable safely

Select the  icon in task tray displayed on the PC, and then click [Eject Panasonic Video Camera].

- Depending on your PC's settings, this icon may not be displayed.

About the screen indication of the unit

- Do not disconnect the USB cable, battery, or AC adaptor while the access lamp is on or card access icon () appears on the unit screen.
- **HC-V720M**
Do not disconnect the USB cable, battery, or AC adaptor while the access lamp is on or built-in memory access icon () appears on the unit screen.
- If the screen does not change when the unit is operated while connected to a PC, disconnect the battery and/or AC adaptor, wait approximately 1 minute, reconnect the battery and/or AC adaptor, wait approximately 1 minute again, and then turn the unit back on. (Data may be destroyed when above operation is performed while accessing the SD card or built-in memory.)

■ Charging the battery by connecting it to different devices

When using the battery, if you turn off the unit and connect it to a PC, Panasonic Blu-ray disc recorder or Panasonic DVD recorder, the battery will charge.

- **When connecting this unit to a PC for the first time, make sure to connect this unit to the PC with this unit turned on.**
- Insert the USB cable securely all the way. It will not operate properly if it is not inserted all the way.
- Do not use any other USB cables except the supplied one. (Operation is not guaranteed with any other USB cables.)
- Be sure to connect the unit directly to the PC, Blu-ray disc recorder or DVD recorder.
- During charging, the status indicator flashes.
- You cannot charge when the status indicator flashes rapidly, or when it does not light at all. Charge using the AC adaptor. (→ 11)
- It will take 2 or 3 times longer to charge compared to when using the AC adaptor.
- If the status indicator flashes at a particularly fast or slow rate, refer to page 184.

About the PC display

When the unit is connected to a PC, it is recognized as an external drive.

- Removable disk (Example:  CAM_SD (F:)) is displayed in [Computer].

We recommend using HD Writer AE 5.0 to copy motion picture data.

Using Windows Explorer or other programs on the PC to copy, move or rename files and folders recorded with this unit will result in them being unusable with HD Writer AE 5.0. It is impossible to write data to the built-in memory or SD card on this unit from a PC.

Example folder structure of an SD card:

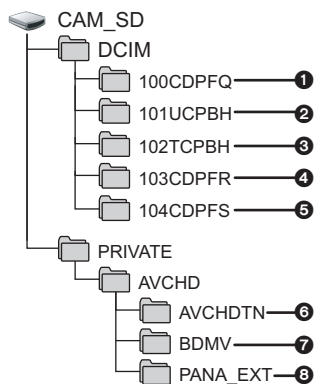

HC-V720M

Example folder structure of built-in memory:

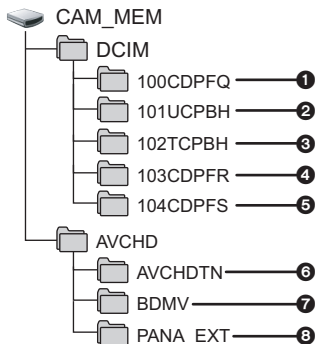

The following data will be recorded.

- 1 **JPEG format still pictures (up to 999 still pictures can be recorded. ([S1000001.JPG], etc.))**
- 2 **iFrame format motion picture files ([S1000001.MP4] etc.)**
- 3 **MP4 format motion picture files ([S1000001.MP4] etc.)**
- 4 **JPEG format still pictures recorded in Hi-Speed Burst Shooting Mode**
- 5 **JPEG format still pictures created from the motion picture**
- 6 **The motion picture thumbnails**
- 7 **AVCHD format motion picture files ([00000.MTS] etc.)**
- 8 **For management**

■ Copying your still pictures to your PC

Card reader function (mass storage)

Still pictures recorded with this unit can be copied to the PC with Explorer or other programs.

- 1 **Double-click the folder that contains the still pictures. ([DCIM] → [100CDPFQ] etc.)**
- 2 **Drag and drop the still pictures onto the destination folder (on the PC's HDD).**

- Do not delete the SD card's folders. Doing so may make the SD card unusable in this unit.
- When data not supported by this unit has been recorded on a PC, it will not be recognized by this unit.
- Always use this unit to format SD cards.

Starting HD Writer AE 5.0

- To use the software, log on as an Administrator or as user name for standard user account (only for Windows 8/Windows 7/Windows Vista).
The software cannot be used with the user name for a guest account.

(On the PC)

Select [Start] → [All Programs] → [Panasonic] → [HD Writer AE 5.0] → [HD Writer AE 5.0].

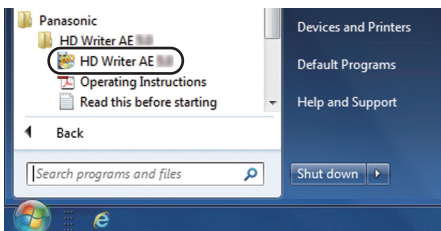

- For details on how to use the software applications, read the PDF operating instructions of the software.

Reading the operating instructions of the software applications

- You will need Adobe Acrobat Reader 5.0 or later or Adobe Reader 7.0 or later to read the PDF operating instructions.

Select [Start] → [All Programs] → [Panasonic] → [HD Writer AE 5.0] → [Operating Instructions].

If using Mac

- HD Writer AE 5.0 is not available for Mac.
- iMovie'11 supported. For details about iMovie'11, please contact Apple Inc.
- iMovie'11 is not compatible with 1080/60p. 1080/60p scenes cannot be imported to a Mac.
 - For users who have [HC-V720]/[HC-V710], it cannot acquire the scenes recorded in 1080/60p. Record in normal recording mode when importing to Mac.
 - For users who have [HC-V720M], convert the scene with [1080/60p]  [1080/60i] before importing. (→ 106)

■ Operating environment

PC	Mac
OS	Mac OS X 10.8.2
CPU	Intel Core 2 Duo or better
RAM	2 GB or more
Interface	USB port
Other requirements	Mouse or equivalent pointing device

- Even if the system requirements mentioned in this owner's manual are fulfilled, some computers cannot be used.
- The USB equipment operates with the driver installed as standard in the OS.
- Supplied CD-ROM is available for Windows only.

■ Copying still pictures on a Mac

1 Connect this unit to a Mac via the supplied USB cable.

- The USB function selection screen will appear.

2 Touch [PC] on the screen of this unit.

- This unit is automatically recognized as an external drive of Mac.
- When you select an option other than [PC], reconnect the USB cable.
- When using the battery, the LCD monitor turns off after about 5 seconds. Touch the screen to turn the LCD monitor on.

3 Double-click [CAM_SD] displayed on the desktop.

- For users who have [HC-V720M], [CAM_SD] and [CAM_MEM] are displayed on the desktop.
- Files are stored in [100CDPFQ] or [102CDPFR] folder etc. in the [DCIM] folder.

4 Using a drag-and-drop operation, move the pictures you want to acquire or the folder storing those pictures to any different folder on the Mac.

■ To disconnect USB cable safely

Drag [CAM_SD] disk icon to the [Trash], and then disconnect the USB cable.

- For users who have [HC-V720M], [CAM_SD] and [CAM_MEM] are displayed on the desktop.

Indications

* **HC-V720M** only

■ Recording indications

Motion Picture Recording Mode

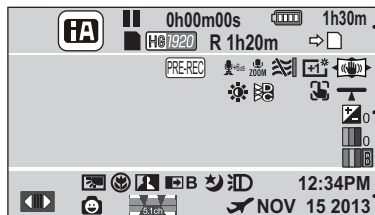

Still Picture Recording Mode

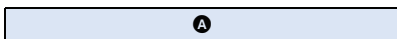
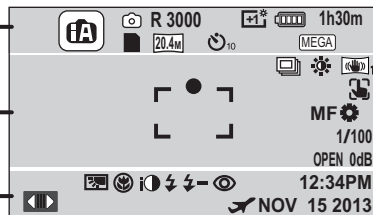

Intelligent Auto Mode (→ 25)



Intelligent Auto Plus Mode (→ 43)



Creative Control Mode (→ 43)



Scene Mode (→ 46)

MNL Manual Mode (→ 48)

●/II (Red) Recording

II (Green) Recording pause

0h00m00s Elapsed recording time (→ 21)

("h" is an abbreviation for hour, "m" for minute and "s" for second.)

Eye-Fi transfer (→ 120)

Remaining battery power (→ 12)

1h30m Remaining battery time (→ 12)

Built-in memory recording possible status*

Card recording possible status

Recognizing the card

1080/60p / PH/920 / HA/920 / HC/920 / HE/920 /
i Frame

Motion Picture Recording Mode (→ 63)

R 1h20m Remaining time for motion picture recording (→ 21)

Relay Recording (→ 63)*

(White) Still picture recording icon

(Red) Recording still picture

R3000 Remaining number of still pictures (→ 24)





















15.1m / 5.8m / 0.3m / 15.1m / 8m / 2m / 20.4m / 9.4m / 2.1m















Number of recording pixels for still pictures (→ 24, 74, 76, 79)

In Playback Mode, the picture size is not displayed for still pictures recorded with other products that have different picture sizes from the sizes shown above.

10/12 Self-timer Recording (→ 60)

MEGA MEGA OIS (→ 23)

B	
	PRE-REC (→ 57)
	Time Lapse Recording (→ 45)
	Bass Setting (→ 73)
	Zoom Microphone (→ 71)
	Focus Microphone (→ 71)
	Stereo Microphone (→ 71)
	Wind Noise Canceler (→ 70)
	Power LCD (→ 35)
	Image Stabilizer (→ 41)/Optical Image Stabilizer Lock (→ 55)
	Picture Adjustment (→ 73)
	Digital Cinema Color (→ 69)
	Brightness Adjustment (Miniature Effect/8mm movie/Silent movie) (→ 44, 45)
	Vividness Adjustment (Miniature Effect) (→ 44)
	Color balance Adjustment (8mm movie) (→ 45)
	AF/AE tracking (→ 54)
	Level Shot (→ 53)
	Touch Shutter (→ 55)
MF	Manual Focus (→ 51)
	White Balance (→ 49)
1/100	Shutter Speed (→ 50)
OPEN/F2.0	Iris value (→ 50)
0dB	Gain value (→ 50)
	Focus indication (→ 23)
	High-Speed Burst Shooting (→ 76)
AF*	AF assist lamp (→ 77)

C	
	Display Touch Menu (→ 17)
	Backlight Compensation (→ 60)
	Tele Macro (→ 60)
	Intelligent Contrast Control (→ 57)
	Microphone Level (→ 72)
	Video Light (→ 61)
	Smile Shot (→ 58)
	Fade (White), Fade (Black) (→ 57)
	Color Night Rec function (→ 61)
	Intelligent Exposure (→ 60)
	Flash (→ 59)
	Flash Level (→ 59)
	Red-eye Reduction (→ 59)
	World Time setting (→ 31)
NOV 15 2013	Date indication (→ 18)
12:34PM	Time indication (→ 18)

■ Playback indications



Display during playback (→ 28, 78)

0h00m00s	Playback Time (→ 28)
No.10	Scene Number
	Repeat Playback (→ 80)
	Resume Playback (→ 81)
100-0001	Still picture folder/file name
	Transfer/Protected motion pictures/still pictures (→ 96, 119)

AVCHD / **1080/60p** / **1080/60i** / **i Frame** / **MP4**

Play mode selection display (→ 27)

	1080/60p recorded scene (→ 27)
	Relay-recorded scene (→ 63)*
MINI	Miniature-recorded scene (→ 44)
	Interval-recorded scene (→ 45)
	Still picture recorded using Smile Shot (→ 58)
	Scenes saved with Highlight Playback (→ 88)
	Eye-Fi transfer status (→ 118)

■ **HC-V720** / **HC-V720M** Indication of connection to Wi-Fi

/ Wi-Fi connection status (wireless access point) (→ 128)

/ Wi-Fi connection status (Direct connection) (→ 133)

■ Indication of connection to USB HDD

USB HDD Playback (→ 113)

■ Indication of connection to other devices

Accessing the card (→ 116, 166)

Accessing the built-in memory (→ 116, 166)*

■ Confirmatory indications

-- (Time display) The built-in battery is low. (→ 18)

Warning for recording of yourself (→ 19)

SD card is not inserted or is incompatible.

Messages

Major confirmation/error messages to be indicated on the screen in text.

*1 **HC-V720M** only

*2 **HC-V720** / **HC-V720M** only

PERIODICALLY MAKE BACK UP OF DATA IN BUILT-IN MEMORY.*1

We recommend backing up important recorded motion pictures and still pictures periodically to a PC, DVD disc etc. to protect it. (→ 157) This message does not indicate that there is a problem with this unit.

CHECK CARD.

This card is not compatible or it cannot be recognized by the unit.

If this message appears even though motion pictures and still pictures are recorded on an SD card, the card may be unstable. Reinsert the SD card, then turn the unit off and then on again.

THIS BATTERY CANNOT BE USED.

- Use a battery that is compatible with this unit. (→ 10)

If using a Panasonic battery compatible with this unit, remove the battery and then insert it again. If the message appears even after repeating this several times, this unit needs repair. Detach the power and consult the dealer who you purchased this unit from. Do not attempt to repair it by yourself.

- You are attempting to connect an AC adaptor not compatible with this unit. Use the supplied AC adaptor. (→ 11)

THIS EXTERNAL DRIVE CANNOT BE USED./ PLEASE CHECK THE EXTERNAL DRIVE.

The external drive that this unit cannot recognize is connected. Check if the USB HDD can be connected and used with this unit and try to reconnect. (→ 109)

Failed to connect wireless access point/ No wireless access point found*2

- Check the Wi-Fi set up of your wireless access point and smartphone.
- [Easy Connection (WPS)] can establish a connection only between two devices: this unit and a device that will connect to this unit. Check if multiple devices are trying to establish a connection in the WPS waiting state simultaneously.
- Read page 135 if the Wi-Fi connection cannot be established.

Connection failed. Please check network settings of connected device.*2

- It may be impossible to connect from some Web services such as "LUMIX CLUB" and USTREAM. Try to reconnect after waiting a short while.
- Read page 135 if the Wi-Fi connection cannot be established.

Network disconnected.*2

- When using [DLNA Play], if you do not operate the DLNA-compatible device you are connected to for a while, it will be displayed. Check the status of the DLNA device you are connected to.



About recovery

If faulty management information is found, the messages may appear and a repair is performed. (Repairing may take time depending on the error.)

-  is displayed when abnormal management information is detected when the scenes are displayed in thumbnail.
-
- Use a sufficiently charged battery or the AC adaptor.
 - Depending on the condition of the data, it may not be possible to completely repair the data.
 - If recovery fails, it will not be possible to play back scenes recorded before the unit turned off.
 - When data recorded on another device is recovered, it may not be possible to play back the data on this unit or the other device.
 - If recovery fails, turn the unit off and on again after waiting awhile. If recovery fails repeatedly, format a media on the unit. Please be aware that if a media is formatted, then all the data recorded on the media will be erased.
 - If the thumbnail information is recovered, displaying the thumbnails may become slower.

Troubleshooting

■ It is not a malfunction in following cases



<p>A clicking sound is heard when the unit is shaken.</p>	<ul style="list-style-type: none"> ● This is the sound of the lens moving and is not a defect. This sound will no longer be heard when the unit is turned on and change the mode to  or .
<p>Object seems to be warped.</p>	<ul style="list-style-type: none"> ● Object seems to be warped slightly when the object moves across the image very fast, but this is because the unit is using MOS for the image sensor. This is not a malfunction.
<p>White round spots like soap bubbles appear on the recorded picture.</p>	<ul style="list-style-type: none"> ● If you take a picture with the flash in a dark place or indoors, white round spots may appear on the picture caused by the flash reflecting of particles of dust in the air. This is not a malfunction. <p>A characteristic of this is that the number of round spots and their position differ in every picture.</p> 
<p>The lens or LCD monitor fog up.</p>	<ul style="list-style-type: none"> ● This is due to condensation. It is not a malfunction. Please refer to page 2.

Power	
Problem	Check points
<p>This unit cannot be turned on.</p> <p>This unit does not stay on long enough.</p> <p>Battery runs down quickly.</p>	<ul style="list-style-type: none"> ● Charge the battery again to ensure it is sufficiently charged. (→ 11) ● In cold places, the battery using time becomes shorter. ● The battery has a limited life. If the operating time is still too short even after the battery is fully charged, the battery has worn out and needs to be replaced.
<p>This unit is turned off automatically.</p>	<ul style="list-style-type: none"> ● If the unit turns off when you turn off the power to the TV using the TV remote control, the VIERA Link is at work. If you are not using the VIERA Link, set [VIERA Link] to [OFF]. (→ 103)
<p>This unit cannot be operated though it is turned on.</p> <p>This unit does not operate normally.</p>	<ul style="list-style-type: none"> ● Remove the battery or AC adaptor, wait about 1 minute and then reconnect the battery or AC adaptor. Then about 1 minute later, turn on the unit again. (Conducting the above operation while the media is being accessed may damage the data on the media.) ● If normal operation is still not restored, detach the power connected, and consult the dealer who you purchased this unit from.



Power	
Problem	Check points
<p>“ERROR OCCURRED. PLEASE TURN UNIT OFF, THEN TURN ON AGAIN.” is displayed.</p>	<ul style="list-style-type: none"> ● The unit has automatically detected an error. Restart the unit by turning the unit off and on. ● The unit will be turned off in about 1 minute if the unit is not turned off and on. ● Repair is needed if it is repeatedly displayed even if it is restarted. Detach the power connected, and consult the dealer who you purchased this unit from. Do not attempt to repair the unit by yourself.

Indication	
Problem	Check points
<p>Remaining battery indication is not displayed properly.</p>	<ul style="list-style-type: none"> ● The remaining battery capacity indication is an approximation. If the remaining battery capacity indication is not displayed correctly, fully charge the battery, discharge it and then charge it again.

Recording

Problem	Check points
The unit arbitrarily stops recording.	<ul style="list-style-type: none"> ● Use an SD card that can be used for motion picture recording. (→ 13) ● The recordable time may have shortened due to the deterioration of the data writing speed or repeated recording and deletion. Using the unit, format the SD card or built-in memory. (→ 37) ● If [AGS] is [ON], record in the normal horizontal position or set [AGS] to [OFF]. (→ 69)
Auto Focus function does not work.	<ul style="list-style-type: none"> ● Switch to Intelligent Auto Mode or Intelligent Auto Plus Mode. ● If you are trying to record a scene which is hard to bring into focus in Auto Focus Mode, use the Manual Focus Mode to adjust the focus. (→ 26, 51)
Color balance of images is strange when recording in a place such as a gymnasium.	<ul style="list-style-type: none"> ● In a place with multiple light sources, such as a gymnasium or a hall, set the White Balance setting to  (Indoor mode 2). If you cannot record clearly with the  (Indoor mode 2), set it to  (Manual adjustment mode). (→ 49)
<p>Color or brightness of the image changes, or you may see horizontal bars in the image.</p> <p>The LCD monitor flickers indoors.</p>	<ul style="list-style-type: none"> ● Color or brightness of the image may change, or you may see horizontal bars in the image when the object is recorded under fluorescent light, mercury light or sodium light, etc., but this is not a malfunction. ● In Motion Picture Recording Mode, record in Intelligent Auto/ Intelligent Auto Plus Mode or set the shutter speed to 1/60 in areas where the power supply frequency is 60 Hz, or 1/100 in areas of 50 Hz. ● In Still Picture Recording Mode, this will not affect the recorded image.

Playback

Problem	Check points
Scenes/still pictures cannot be played back.	<ul style="list-style-type: none"> ● Any scenes/still pictures where the thumbnails are displayed as  cannot be played back.
Scenes cannot be deleted.	<ul style="list-style-type: none"> ● Release the protect setting. (→ 96) ● Any scenes/still pictures where the thumbnails are displayed as  cannot be deleted. If the scenes/still pictures are unnecessary, format the media to erase the data. (→ 37) Please be aware that if a media is formatted then all the data recorded on the media is erased and cannot be recovered. Back up important data on a PC, disc etc.

With other products

Problem	Check points
<p>Although this unit is correctly connected to a TV, images or sounds cannot be seen.</p> <p>The images are squeezed horizontally.</p>	<ul style="list-style-type: none"> ● Please read the operating instructions of your TV and select the channel that matches the input used for the connection. ● Change the [TV ASPECT] setting to match the aspect ratio of the TV. (→ 101) ● The audio during playback mode is not output from this unit when connected to a TV. Sound levels cannot be adjusted using this unit, so adjust the sound on the TV.
<p>If the SD card is inserted in another device, it is not recognized.</p>	<ul style="list-style-type: none"> ● Check that the device is compatible with the capacity or type of SD card (SD Memory Card/SDHC Memory Card/SDXC Memory Card) that you inserted. Refer to the operating instructions of the device for details.
<p>When connected by the USB cable, this unit is not detected by the other devices.</p>	<ul style="list-style-type: none"> ● When connected to other devices using only the battery, reconnect using the AC adaptor.
<p>VIERA Link does not work.</p>	<p>(Setting on this unit)</p> <ul style="list-style-type: none"> ● Connect with a HDMI mini cable (supplied). (→ 103) ● Touch , then touch [SETUP] → [VIERA Link] → [ON]. (→ 103) ● Turn the unit off and then back on again. <p>(Setting on other devices)</p> <ul style="list-style-type: none"> ● If the TV input does not switch automatically, switch the input using the TV remote control. ● Check the VIERA Link setting on the connected device. ● Please refer to the operating instructions of the connected device.
<p>Cannot copy scenes on the SD card by connecting to other equipment with the USB cable.</p>	<ul style="list-style-type: none"> ● Other equipment might have not recognized the SD card. Unplug the USB cable once, and reconnect it.

With a PC	
Problem	Check points
When connected by the USB cable, this unit is not detected by the PC.	<ul style="list-style-type: none"> ● After re-inserting the SD card into the unit, reconnect the supplied USB cable. ● Select another USB terminal on the PC. ● Check the operating environment. (→ 161, 169) ● Connect the supplied USB cable again after restarting the PC and turning on this unit again.
When the USB cable is disconnected, an error message will appear on the PC.	<ul style="list-style-type: none"> ● To disconnect the USB cable safely, double-click the  icon in the task tray and follow the instructions on the screen.
Cannot see the PDF operating instructions for HD Writer AE 5.0.	<ul style="list-style-type: none"> ● You will need Adobe Acrobat Reader 5.0 or later or Adobe Reader 7.0 or later to read the PDF operating instructions for HD Writer AE 5.0.

About the Wi-Fi function [HC-V720]/[HC-V720M]	
Problem	Check points
Cannot connect to wireless access point or smartphone.	<ul style="list-style-type: none"> ● Read page 135 if the Wi-Fi connection cannot be established.
Cannot operate from smartphone using [Link to Cell].	<ul style="list-style-type: none"> ● Install the smartphone app "Image App" on your smartphone. (→ 126)
Cannot use [DLNA Play].	<ul style="list-style-type: none"> ● Make sure the television is compatible with DLNA. Read the instructions for the television you are using. ● Make sure the wireless access point and this device are properly connected. ● Approach the wireless access point and reconnect. ● If a connection cannot be made between this device and a DLNA-compatible device, try to reconnect and make sure they connect properly.
The live broadcast screen will not be displayed.	<ul style="list-style-type: none"> ● Make sure the "LUMIX CLUB" login ID and password have been input correctly. ● Use a PC or smartphone to make sure the USTREAM account registration is complete. ● Use a PC or smartphone to register and set up USTREAM from a "LUMIX CLUB" linked service. (→ 127) ● "LUMIX CLUB" or USTREAM lines may be congested. Retry the live broadcast after waiting a short while.
[Home Cam] cannot be used.	<ul style="list-style-type: none"> ● Make sure the wireless access point is connected to the Internet. ● Make sure the wireless access point and this unit are properly connected. (→ 128)

About the Wi-Fi function [HC-V720]/[HC-V720M]

Problem	Check points
I have forgotten the password for the Wi-Fi.	<ul style="list-style-type: none"> ● Perform [Reset Wi-Fi Settings] from the Setup menu (→ 36). This will set the Wi-Fi setting to the condition at the time of purchase, and you will be able to use the Wi-Fi setting menu. When performing [Reset Wi-Fi Settings], all Wi-Fi settings including the "LUMIX CLUB" login ID and registered wireless access points will be deleted.
I have forgotten the login ID or password for the "LUMIX CLUB".	<ul style="list-style-type: none"> ● Check the information in the login screen of "LUMIX CLUB". http://lumixclub.panasonic.net/eng/c/

Others

Problem	Check points
If the SD card is inserted in this unit, it is not recognized.	<ul style="list-style-type: none"> ● If the SD card is formatted on a PC, it may not be recognized by this unit. Use this unit to format SD cards. (→ 37)

■ If AVCHD scenes do not change smoothly when played back on another device

The images may be still for several seconds at the joins between the scenes if the following operations are performed when multiple scenes have been continuously played back using another unit.

- Just how smoothly the scenes will be played back depends on the playback unit. Depending on the unit used, the images may stop moving and become still for a moment even when none of the following conditions are applicable.
- A continuous recording of motion picture data that exceeds 4 GB may momentarily stop at every 4 GB of data when played back with another device.
- It may not play back smoothly when the editing of scenes was done with the HD Writer AE 5.0, but it will play back smoothly if you set the seamless settings in the HD Writer AE 5.0. Refer to the operating instructions for the HD Writer AE 5.0.

Principal reasons for not playing back smoothly
● When the scenes were recorded on different dates
● When scenes lasting under 3 seconds have been recorded
● When PRE-REC was used for recording
● When the Miniature Effect recording is used
● When the Time Lapse Recording is used
● When deleting scenes
● HC-V720M When selected scenes are copied between an SD card and the built-in memory
● When scenes recorded more than 99 scenes on the same date

Cautions for use

About this unit

The unit and the SD card become warm during use. This is not a malfunction.

Keep this unit as far away as possible from electromagnetic equipment (such as microwave ovens, TVs, video games etc.).

- If you use this unit on top of or near a TV, the pictures and/or sound on this unit may be disrupted by electromagnetic wave radiation.
- Do not use this unit near cell phones because doing so may result in noise adversely affecting the pictures and/or sound.
- Recorded data may be damaged, or pictures may be distorted, by strong magnetic fields created by speakers or large motors.
- Electromagnetic wave radiation generated by microprocessors may adversely affect this unit, disturbing the pictures and/or sound.
- If this unit is adversely affected by electromagnetic equipment and stops functioning properly, turn this unit off and remove the battery or disconnect AC adaptor. Then reinsert the battery or reconnect AC adaptor and turn this unit on.

Do not use this unit near radio transmitters or high-voltage lines.

- If you record near radio transmitters or high-voltage lines, the recorded pictures and/or sound may be adversely affected.

Make sure to use the supplied cords and cables. If you use optional accessories, use the cords and the cables supplied with them.

Do not extend the cords and the cables.

Do not spray insecticides or volatile chemicals onto the unit.

- If the unit is sprayed with such chemicals, its body may be marred and the surface finish may peel off.
- Do not leave rubber or plastic products in contact with the unit for a long time.

When you use the unit in a sandy or dusty place such as a beach, do not let sand or fine dust get into the body and terminals of the unit.

Also, keep the unit away from sea water.

- Sand or dust may damage the unit. (Care should be taken when inserting and removing a card.)
- If sea water splashes onto the unit, wipe off the water with a well wrung cloth. Then wipe the unit again with a dry cloth.

When carrying the unit, do not drop or bump it.

- A strong impact can break the unit's casing, causing it to malfunction.

Cleaning

- Before cleaning, detach the battery or pull the AC cable from the AC outlet, and then wipe the unit with a soft, dry cloth.
- If the unit is very dirty, dip a cloth in water and squeeze firmly, and then wipe the unit with the damp cloth. Next, dry the unit with a dry cloth.
- Use of benzine, paint thinner, alcohol, or dishwashing liquid may alter the camera body or peel the surface finish. Do not use these solvents.
- When using a chemical dust cloth, follow the instructions that came with the cloth.

Do not use the unit for surveillance purposes or other business uses.

- This unit was designed for consumer intermittent use. It was not intended for continuous use, or for any industrial or commercial application resulting in prolonged use.
- In certain situations, continuous use could cause the unit to overheat and cause a malfunction. Such use is strongly discouraged.

When you are not going to use the unit for an extended time

- When storing the unit in a cupboard or cabinet, it is recommended that you place a desiccant (silica gel) in with it.

HC-V720M

When disposing of or giving away this unit, note that:

- Formatting and deletion simply change the file management information and cannot be used to completely erase the data in built-in memory of this unit. The data can be recovered using commercially available software or the like.

- We recommend that you physically format the built-in memory before disposing of or giving away this unit.

To physically format the built-in memory, connect the unit via the AC adaptor, select [SETUP] → [FORMAT MEDIA] → [Built-inMemory] from the menu, and then press and hold the recording start/stop button on the screen below for about 3 seconds. When the built-in memory data deletion screen appears, select [YES], and then follow the on-screen instructions.

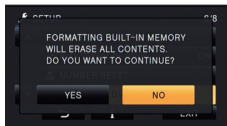

- Please look after the data in your built-in memory carefully. Panasonic will not be held responsible in the unlikely case that private data is divulged.

About the battery

The battery used in this unit is a rechargeable lithium-ion battery. It is susceptible to humidity and temperature and the effect increases the more the temperature rises or falls. In cold areas, the full charge indication may not appear or the low battery indication may appear about 5 minutes after starting use. At high temperatures, the protection function may be triggered, making it impossible to use the unit.

Be sure to detach the battery after use.

- If the battery is left attached, a minute amount of current continues to flow even if the unit is off. Keeping the unit in this state may result in over discharge of the battery. This may result in you not being able to use the battery even after it is charged.
- The battery should be stored in the vinyl bag so metal does not come into contact with the terminals.
- The battery should be stored in a cool place free from humidity, with as constant temperature as possible. (Recommended temperature: 15 °C to 25 °C (59 °F to 77 °F), Recommended humidity: 40%RH to 60%RH)
- Extremely high temperatures or low temperatures will shorten the life of the battery.
- If the battery is kept in high-temperature, high-humidity, or oily-smoky places, the terminals may rust and cause malfunctions.
- To store the battery for a long period of time, we recommend you charge it once every year and store it again after you have completely used up the charged capacity.
- Dust and other matter attached to the battery terminals should be removed.

Prepare spare batteries when going out for recording.

- Prepare batteries enough to last for 3 to 4 times the period you are planning to record for. Cold places such as a ski resort can shorten recording time.

If you drop the battery accidentally, check to see if the terminals are damaged.

- Inserting a battery with damaged terminals can damage the unit.

Do not throw an old battery into fire.

- Heating a battery or throwing it into a fire may result in an explosion.

If the operating time is very short even after the battery has been recharged, the battery has worn out. Please purchase a new battery.

About the AC adaptor

- If the temperature of the battery is extremely high or extremely low, charging may take time or the battery may not be charged.
- If you use the AC adaptor near a radio, radio reception may be disturbed. Keep the AC adaptor 1 m (3.3 feet) or more away from the radio.
- When using the AC adaptor, it may generate whirring sounds. However, this is normal.
- After use, be sure to disconnect the AC adaptor. (If it is left connected, a minute amount of current is consumed.)
- Always keep the electrodes of the AC adaptor and battery clean.

About status indicator during charging

When the status indicator is flashing at a particularly fast or slow rate, the following should be considered.

Flashing with approx. 4 second period (off for approx. 2 seconds, on for approx. 2 seconds):

- When the battery is over discharged or the temperature of the battery is too high or low. It can be charged, but it may take a few hours to complete the charging normally.
- It will flash in approx. 2 second intervals when normal charging resumes. Even in such cases, it may start flashing in approx. 4 second intervals until charging is completed depending on the conditions of use.

Flashing with approx. 0.5 second period (off for approx. 0.25 second, on for approx. 0.25 second):

- The battery is not charged. Remove the battery from the unit, and try charging again.
- Check that the terminals of the unit or battery are not dirty or covered with a foreign object, and connect the battery correctly once again. If a foreign object or dirt is present, turn off the unit before removing.
- The battery or environment is at an extremely high or low temperature. Wait until the temperature has returned to an appropriate level and try charging again. If you are still unable to charge, there may be a fault in the unit, battery or AC adaptor.

Off:

- Charging has finished.
- If the status indicator stays off despite the charging being unfinished, there may be a fault in the unit, battery or AC adaptor. Refer to page 183 for details on the battery.

About 3D

About 3D viewing

Anyone who is hypersensitive to light, suffers from heart disease or is otherwise unwell should avoid viewing 3D image.

- Doing may have an adverse affect on such medical conditions.

If you feel tired, uncomfortable or otherwise strange when viewing 3D image, stop viewing at once.

- Continuing to view may cause illness.
- Please rest appropriately after stopping the viewing.

When viewing 3D images, we recommend taking a break every 30 to 60 minutes.

- Viewing for extended periods may cause eye-fatigue.

Near-sighted or far-sighted persons, those with differences in the sight of their right and left eyes, and those with astigmatism are advised to correct their vision by wearing glasses etc.

Stop viewing if you can clearly see a double image while viewing a 3D image.

- There are differences in the way that different people experience 3D images. Please correct your sight appropriately before viewing 3D image.
- You can change the 3D setting of your television or 3D output setting of the unit to 2D.

About the SD card

When disposing of or giving away the SD card, note that:

- Formatting and deletion of data on this unit or computer only changes the file management information and does not completely delete the data in the SD card.
- It is recommended that the SD card is physically destroyed or the SD card is physically formatted using this unit when disposing of or giving away the SD card.

HC-V720/ HC-V710

To physically format the SD card, connect the unit via the AC adaptor, select [SETUP] → [FORMAT MEDIA] → [YES] from the menu, and then press and hold the recording start/stop button on the screen below for about 3 seconds. When the SD card data deletion screen appears, select [YES], and then follow the on-screen instructions.

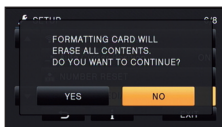

HC-V720M

To physically format the SD card, connect the unit via the AC adaptor, select [SETUP] → [FORMAT MEDIA] → [SD CARD] from the menu, and then press and hold the recording start/stop button on the screen below for about 3 seconds. When the SD card data deletion screen appears, select [YES], and then follow the on-screen instructions.

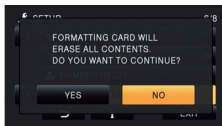

- The customer is responsible for the management of the data in the SD card.

LCD monitor

- When the LCD screen is dirty or condensation has occurred, please wipe it using a soft cloth such as eyeglass cleaner.
- Do not touch the LCD monitor with your fingernails, or rub or press with strong force.
- It may become hard to see or hard to recognize the touch when the LCD protection sheet is affixed.
- When the unit has become very cold, for example due to storage in a cold area, its LCD monitor will be slightly darker than usual immediately after the unit is turned on. The normal brightness will be restored when the unit's internal temperature rises.

Extremely high precision technology is employed to produce the LCD Monitor screen. The result is more than 99.99% effective dots with a mere 0.01% of the dots inactive or always lit. However, this is not a malfunction and does not affect the recorded picture.

About personal information

After you have set up the Face Recognition function, personal information will be held in this unit and included in recorded images.

- When the unit is serviced, or given away/ disposed of, the personal information should be deleted in the interests of protecting personal information. (→ 96)

Indemnity

- Information, including personal information, may be changed or lost as a result of mistaken operation, static electricity effects, accident, breakage, repair or other handling. It should be noted before use that Panasonic does not accept any responsibility for direct or indirect problems which occur as the result of the change to or loss of the information including personal information.

About copyright

■ Carefully observe copyright laws

Whatever you have recorded and created can be used for your personal entertainment only. Under copyright laws, other materials cannot be used without obtaining permission from the holders of the copyrights.

■ Licenses

- SDXC Logo is a trademark of SD-3C, LLC.
- "AVCHD", "AVCHD Progressive" and the "AVCHD Progressive" logo are trademarks of Panasonic Corporation and Sony Corporation.
- Manufactured under license from Dolby Laboratories. Dolby and the double-D symbol are trademarks of Dolby Laboratories.
- HDMI, the HDMI Logo, and High-Definition Multimedia Interface are trademarks or registered trademarks of HDMI Licensing LLC in the United States and other countries.
- VIERA Link™ is a trademark of Panasonic Corporation.
- EZ Sync™ is a trademark of Panasonic Corporation.
- HDAVI Control™ is a trademark of Panasonic Corporation.
- x.v.Color™ is a trademark.
- Microsoft®, Windows® and Windows Vista® are either registered trademarks or trademarks of Microsoft Corporation in the United States and/or other countries.
- Microsoft product screen shot(s) reprinted with permission from Microsoft Corporation.
- IBM and PC/AT are registered trademarks of International Business Machines Corporation of the U.S.
- Intel®, Pentium®, Celeron® and Intel®Core™ are trademarks of Intel Corporation in the U.S. and/or other countries.
- AMD Athlon™ is a trademark of Advanced Micro Devices, Inc.

- iMovie, Mac and Mac OS are trademarks of Apple Inc. registered in the U.S. and other countries.
- App Store is a service mark of Apple Inc.
- Android and Google Play are trademarks or registered trademarks of Google Inc.
- The Wi-Fi CERTIFIED Logo is a certification mark of the Wi-Fi Alliance.
- The Wi-Fi Protected Setup Mark is a mark of the Wi-Fi Alliance.
- "Wi-Fi", "Wi-Fi Protected Setup", "WPA" and "WPA2" are marks or registered marks of the Wi-Fi Alliance.
- DLNA, the DLNA Logo and DLNA CERTIFIED are trademarks, service marks, or certification marks of the Digital Living Network Alliance.
- QR Code is a registered trademark of DENSO WAVE INCORPORATED.
- Other names of systems and products mentioned in these instructions are usually the registered trademarks or trademarks of the manufacturers who developed the system or product concerned.

This product is licensed under the AVC patent portfolio license for the personal and non-commercial use of a consumer to (i) encode video in compliance with the AVC Standard ("AVC Video") and/or (ii) decode AVC Video that was encoded by a consumer engaged in a personal and non-commercial activity and/or was obtained from a video provider licensed to provide AVC Video. No license is granted or shall be implied for any other use. Additional information may be obtained from MPEG LA, LLC. See <http://www.mpegla.com>.

This product incorporates the following software:

- (1) the software developed independently by or for Panasonic Corporation,
- (2) the software owned by third party and licensed to Panasonic Corporation,
- (3) the software licensed under the GNU General Public License, Version 2.0 (GPL V2.0),
- (4) the software licensed under the GNU LESSER General Public License, Version 2.1 (LGPL V2.1), and/or
- (5) open source software other than the software licensed under the GPL V2.0 and/or LGPL V2.1.

The software categorized as (3) - (5) are distributed in the hope that it will be useful, but WITHOUT ANY WARRANTY, without even the implied warranty of MERCHANTABILITY or FITNESS FOR A PARTICULAR PURPOSE. Please refer to the detailed terms and conditions thereof shown in the attached Application Software CD-ROM.

At least three (3) years from delivery of this product, Panasonic will give to any third party who contacts us at the contact information provided below, for a charge no more than our cost of physically performing source code distribution, a complete machine-readable copy of the corresponding source code covered under GPL V2.0 or LGPL V2.1, as well as the respective copyright notice thereof.

Contact Information: oss-cd-request@gg.jp.panasonic.com

The source code and the copyright notice are also available for free in our website below.
<http://panasonic.net/avc/oss/index.html>

Recording modes/approximate recordable time

- SD cards are only mentioned with their main memory size. The stated times are the approximate recordable times for continuous recording.

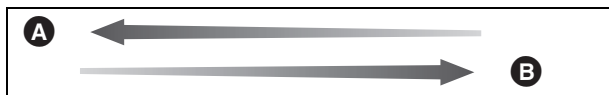

Recording mode		[1080/60p]	[1080/60i]			
			[PH]	[HA]	[HG]	[HE]
Picture size/ Frame rate		1920×1080/ 60p	1920×1080/ 60i	1920×1080/ 60i	1920×1080/ 60i	1920×1080/ 60i
SD card	4 GB	19 min	21 min	30 min	40 min	1 h 30 min
	16 GB	1 h 20 min	1 h 30 min	2 h	2 h 40 min	6 h 40 min
	64 GB	5 h 20 min	6 h	8 h 30 min	11 h	27 h 30 min
HC-V720M Built-in memory		16 GB	1 h 30 min	2 h	2 h 40 min	6 h 40 min

- A** Favours image quality
B Favours Recording time

Recording mode		[iFrame]
Picture size/ Frame rate		960×540/ 30p
SD card	4 GB	19 min
	16 GB	1 h 20 min
	64 GB	5 h 20 min
HC-V720M Built-in memory		16 GB 1 h 20 min

- If recording for long periods, prepare batteries for 3 or 4 times the period you wish to record for. (→ 12)
- The default setting is [HG] Mode.
- Maximum continuously recordable time for one scene: 6 hours
- The recording is paused once when the recording time for one scene exceeds 6 hours, and the recording will automatically resume after a few seconds.
- The recordable time may be reduced if recording with a lot of action is recorded or recording of short scene is repeated.
- Use time in the row of 4 GB in above table as a guideline for the time that can be copied onto one DVD disc (4.7 GB).

Approximate number of recordable pictures

- SD cards are only mentioned with their main memory size. The stated number is the approximate number of recordable pictures.

Picture size		20.4M	9.4M	2.1M	
		6016×3384	4096×2304	1920×1080	
Aspect ratio		16:9			
SD card	4 GB	300	650	3200	
	16 GB	1300	2700	12500	
	64 GB	5000	10500	52000	
HC-V720M Built-in memory		16 GB	1300	2700	12500

Picture size		15.1M	5.8M	0.3M	
		4480×3360	2784×2088	640×480	
Aspect ratio		4:3			
SD card	4 GB	400	1000	28000	
	16 GB	1700	4100	117000	
	64 GB	7000	16500	475000	
HC-V720M Built-in memory		16 GB	1700	4100	117000



Picture size		15.1M	8M	2M	
		4752×3168	3456×2304	1728×1152	
Aspect ratio		3:2			
SD card	4 GB	400	750	2200	
	16 GB	1700	3100	8500	
	64 GB	7000	12500	36000	
HC-V720M Built-in memory		16 GB	1700	3100	8500

- The number of recordable pictures depends on the subject being recorded.
- Maximum number of recordable pictures that can be displayed is 9999. If the number of recordable pictures exceeds 9999, R 9999+ is displayed. The number will not change when the picture is taken until the number of recordable pictures is 9999 or less.
- The memory capacity indicated on the label of an SD card is the total of the capacity for copyright protection and management and the capacity which can be used on the unit, a PC etc.

Optional accessories

Attaching the Conversion Lens/ Filter Kit

Attach the Wide Conversion Lens (VW-W4907H: optional) ND filter or MC protector of the Filter Kit (VW-LF46N: optional) in front of the lens.

- You will not be able to use the flash and video light. Set the flash setting to  ([OFF]), and the video light setting to  ([OFF]). (→ 59, 61)

Be careful about the following.

When 2 lens accessories, such as the ND filter and Wide Conversion Lens, are fitted and the zoom lever is pressed toward the W side, the 4 corners of an image will be darkened. (Vignetting)

Attaching the lens cap of the Filter Kit (VW-LF46N: optional)

- When the Filter Kit (VW-LF46N: optional) is used, protect the lens surface while the unit is not used with the lens cap supplied with the Filter Kit.

Attaching the supplied shoe adaptor

You can attach a variety of optional accessories to the shoe adaptor. For information on how to attach and use those accessories, refer to their manuals.

■ When attaching the shoe adaptor

Insert the shoe adaptor into the shoe adaptor mounting part.

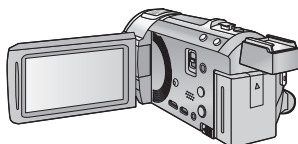
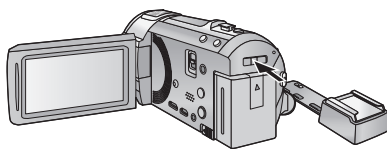

■ When removing the shoe adaptor

When removing the shoe adaptor, slide the SHOE ADAPTOR RELEASE lever, and remove the shoe adaptor while sliding the lever.

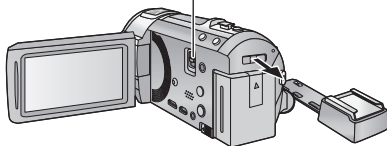

Panasonic Corporation
Web site: <http://panasonic.net>