

Panasonic®

Basic Operating Instructions High Definition Video Camera

Model No. **HC-V700**
HC-V700M

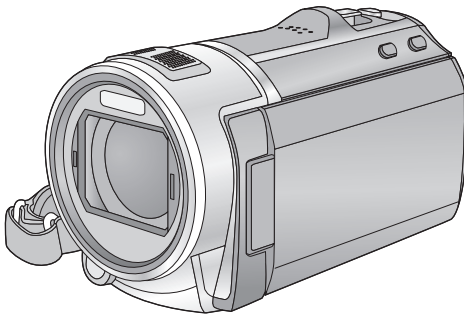

Before use, please read these instructions completely.

More detailed instructions on the operation of this unit are contained in "Operating Instructions (PDF format)" in the supplied CD-ROM. Install it on your PC to read it.

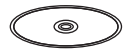

AVCHD™
Progressive

HDMI

SD™
XC

DOLBY
DIGITAL
STEREO CREATOR

VIERA
Link

3D

VQT4G54

SG

Information for Your Safety

WARNING:

To reduce the risk of fire, electric shock or product damage,

- Do not expose this unit to rain, moisture, dripping or splashing.
- Do not place objects filled with liquids, such as vases, on this unit.
- Use only the recommended accessories.
- Do not remove covers.
- Do not repair this unit by yourself. Refer servicing to qualified service personnel.

CAUTION!

To reduce the risk of fire, electric shock or product damage,

- Do not install or place this unit in a bookcase, built-in cabinet or in another confined space. Ensure this unit is well ventilated.
- Do not obstruct this unit's ventilation openings with newspapers, tablecloths, curtains, and similar items.
- Do not place sources of naked flames, such as lighted candles, on this unit.

Install this unit so that the AC mains lead can be unplugged from the socket outlet immediately if any problem occurs.

■ Concerning the battery

Warning

Risk of fire, explosion and burns. Do not disassemble, heat above 60 °C or incinerate.

CAUTION

- Danger of explosion if battery is incorrectly replaced. Replace only with the type recommended by the manufacturer.
- When disposing the batteries, please contact your local authorities or dealer and ask for the correct method of disposal.

Use only the recommended accessories.

- Always use a genuine Panasonic HDMI mini cable (RP-CDHM15, RP-CDHM30: optional).

■ Product identification marking

Product	Location
High Definition Video Camera	Battery holder
AC adaptor	Bottom

-If you see this symbol-

Information on Disposal in other Countries outside the European Union



This symbol is only valid in the European Union. If you wish to discard this product, please contact your local authorities or dealer and ask for the correct method of disposal.

■ Cautions for use

Keep this unit as far away as possible from electromagnetic equipment (such as microwave ovens, TVs, video games etc.).

- If you use this unit on top of or near a TV, the pictures and/or sound on this unit may be disrupted by electromagnetic wave radiation.
- Do not use this unit near cell phones because doing so may result in noise adversely affecting the pictures and/or sound.
- Recorded data may be damaged, or pictures may be distorted, by strong magnetic fields created by speakers or large motors.
- Electromagnetic wave radiation generated by microprocessors may adversely affect this unit, disturbing the pictures and/or sound.
- If this unit is adversely affected by electromagnetic equipment and stops functioning properly, turn this unit off and remove the battery or disconnect AC adaptor. Then reinsert the battery or reconnect AC adaptor and turn this unit on.

Do not use this unit near radio transmitters or high-voltage lines.

- If you record near radio transmitters or high-voltage lines, the recorded pictures and/or sound may be adversely affected.

About connecting to a PC

- Do not use any other USB cables except the supplied one.

■ About the recording format for recording motion pictures

You can record motion pictures in either AVCHD*1 or iFrame recording formats using this unit.

*1 It is compatible with the AVCHD Progressive (1080/50p).

AVCHD:

It is possible to record in the best image quality of this unit (1080/50p) and high definition image (1080/50i). It is suitable for viewing on a large format TV or for saving to disc*2.

*2 To save the image recorded in 1080/50p, it is required to copy to a disc using the supplied software HD Writer AE 4.0.

iFrame:

This is a recording format suitable for viewing and editing on a Mac (iMovie'11). Using iMovie'11, iFrame motion pictures can be imported faster than AVCHD motion pictures. Also, the imported file size of iFrame motion pictures will be smaller than that of AVCHD motion pictures.

- It is not compatible with motion pictures recorded in AVCHD format.

■ Indemnity about recorded content

Panasonic does not accept any responsibility for damages directly or indirectly due to any type of problems that result in loss of recording or edited content, and does not guarantee any content if recording or editing does not work properly. Likewise, the above also applies in a case where any type of repair is made to the unit (including any other non-built-in memory related component).

■ About Condensation (When the lens or the LCD monitor is fogged up)





Condensation occurs when the ambient temperature or humidity changes. Be careful of condensation since it causes lens or LCD monitor stains, fungus and camera malfunction.

■ Cards that you can use with this unit

SD Memory Card, SDHC Memory Card and SDXC Memory Card

- 4 GB or more Memory Cards that do not have the SDHC logo or 48 GB or more Memory Cards that do not have the SDXC logo are not based on SD Memory Card Specifications.
- Refer to page 11 for more details on SD cards.

■ For the purposes of these operating instructions

- SD Memory Card, SDHC Memory Card and SDXC Memory Card are referred to as the "SD card".
- Function that can be used for Motion Picture Recording Mode: 
- Function that can be used for Still Picture Recording Mode: 
- Function that can be used for the Playback Mode: 
- Function that can be used for the Playback Mode (motion pictures only): 
- Function that can be used for the Playback Mode (still pictures only): 
- Scene(s) recorded in 1080/50p, 1080/50i or side-by-side (SbS 3D): "AVCHD scene(s)"
- Pages for reference are indicated by an arrow, for example: → 00

These operating instructions are designed for use with models **HC-V700** and **HC-V700M**. Pictures may be slightly different from the original.

- The illustrations used in these operating instructions show model **HC-V700**, however, parts of the explanation refer to different models.
- Depending on the model, some functions are not available.
- Features may vary, so please read carefully.
- Not all models may be available depending on the region of purchase.

Contents

Information for Your Safety.....	2
Accessories.....	6

Preparation

Power supply.....	8
Inserting/removing the battery.....	8
Charging the battery	9
Charging and recording time.....	10
Recording to a card.....	11
Cards that you can use with this unit	11
Inserting/removing an SD card.....	12
Turning the unit on/off.....	13
Selecting a mode	13
How to use the touch screen	14
About the Touch Menu	15
Setting date and time.....	16

Basic

Selecting a media to record [HC-V700M].....	17
Intelligent Auto Mode	17
Recording motion pictures	18
Recording still pictures	18
Motion picture/Still picture playback	19
Watching Video/Pictures on your TV	20
Using the menu screen	21
Language selection	21
Using the zoom	22
Formatting	22

Others

Specifications.....	23
About copyright	26
Reading the Operating Instructions (PDF format)	27

Accessories

Check the accessories before using this unit.

Keep the accessories out of reach of children to prevent swallowing.

Product numbers correct as of Feb. 2012. These may be subject to change.

Battery pack

VW-VBK180



AC adaptor

VSK0780



AC cable

K2CA2YY00219



- Do not use the AC cable with any other equipment as it is designed only for this unit.

Do not use the AC cable from other equipment with this unit.

AV multi cable

K1HY12YY0016



USB cable

K2KYYYY00201



Shoe adaptor

VYC1055

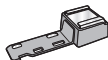

CD-ROM

Software



CD-ROM

Operating Instructions

VFF1018



Optional accessories

Some optional accessories may not be available in some countries.

Battery charger (VW-BC10)
Battery pack (lithium/VW-VBK180)
Battery pack (lithium/VW-VBK360)
HDMI mini cable (RP-CDHM15, RP-CDHM30)
3D Conversion Lens/Step up ring (VW-CLT2) ^{*1}
Wide conversion lens (VW-W4907H) ^{*1}
Filter kit (VW-LF46N) ^{*1}
Video DC light (VW-LDC103) ^{*2}
Light bulb for video DC light (VZ-LL10)
Stereo microphone (VW-VMS2) ^{*3}
Shoe adaptor (VW-SK12)
Accessory kit (VW-ACK180)

*1 Set to the flash setting to  ([OFF]).

*2 To use the VW-LDC103, the battery pack/VW-VBG130, VW-VBG260 is required. To charge the battery pack/VW-VBG130, VW-VBG260, the AC adaptor/VW-AD21-K, VW-AD20-K is required.

*3 External microphone may intrude into the frame when recording. Set the zoom to wide angle, and tilt the external microphone upward so it will not intrude into the frame. This will not affect the audio being recorded.

Power supply

■ About batteries that you can use with this unit

The battery that can be used with this unit is VW-VBK180/VW-VBK360.

- The unit has a function for distinguishing batteries which can be used safely. The dedicated battery (VW-VBK180/VW-VBK360) supports this function. The only batteries suitable for use with this unit are genuine Panasonic products and batteries manufactured by other companies and certified by Panasonic. (Batteries which do not support this function cannot be used). Panasonic cannot in any way guarantee the quality, performance or safety of batteries which have been manufactured by other companies and are not genuine Panasonic products.

It has been found that counterfeit battery packs which look very similar to the genuine product are made available to purchase in some markets. Some of these battery packs are not adequately protected with internal protection to meet the requirements of appropriate safety standards. There is a possibility that these battery packs may lead to fire or explosion. Please be advised that we are not liable for any accident or failure occurring as a result of use of a counterfeit battery pack. To ensure that safe products are used we would recommend that a genuine Panasonic battery pack is used.

Inserting/removing the battery

- Press the power button to turn off the unit. (→ 13)

Install the battery by inserting it in the direction shown in the figure.

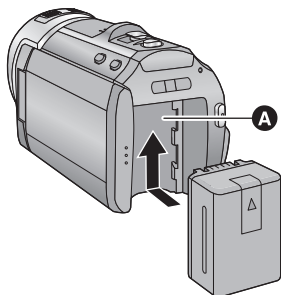

A Battery holder

Insert the battery until it clicks and locks.

Removing the battery

Be sure to hold down the power button until the status indicator goes off. Then remove the battery while supporting the unit to prevent from dropping. **Move the battery release lever in the direction indicated by the arrow and remove the battery when unlocked.**

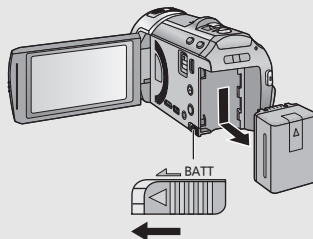

Charging the battery

When this unit is purchased, the battery is not charged. Charge the battery fully before using this unit for the first time.

The unit is in the standby condition when the AC adaptor is connected. The primary circuit is always “live” as long as the AC adaptor is connected to an electrical outlet.

Important:

- Use the supplied AC adaptor. Do not use the AC adaptor of another device.
- Do not use the AC cable with any other equipment as it is designed only for this unit. Also, do not use the AC cable from other equipment with this unit.
- The battery can also be charged using a battery charger (VW-BC10: optional).
- The battery will not be charged if the unit is turned on.
- It is recommended to charge the battery in a temperature between 10 °C and 30 °C. (The battery temperature should also be the same.)

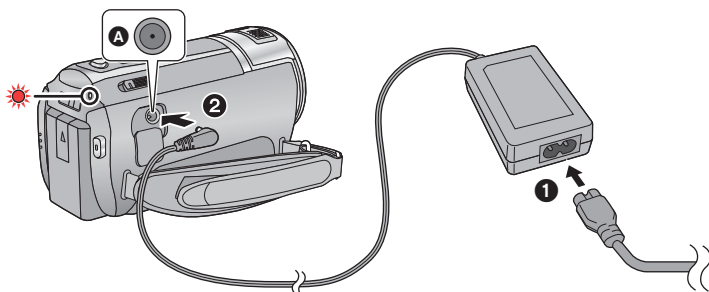

A DC input terminal

- Insert the plugs as far as they will go.

1 Connect the AC cable to the AC adaptor, then the AC outlet.

2 Connect the AC adaptor to the DC input terminal.

- Be careful not to pinch the DC input terminal cover.
- The status indicator will flash red at an interval of 2 seconds (approximately 1 second on, 1 second off), indicating that charging has begun. It will turn off when the charging is completed.

■ Connecting to the AC outlet

It is possible to use this unit with power supplied from the AC outlet by turning on the unit with the AC adaptor connected.

Use it together with the battery when recording for long time the AC adaptor connected.

■ To charge by connecting to other device

It is possible to charge by connecting to other device with the USB cable (supplied).

- Do not use any other AC adaptors except the supplied one.
- We recommend using Panasonic batteries (→ 6, 7).
- If you use other batteries, we cannot guarantee the quality of this product.
- Do not heat or expose to flame.
- Do not leave the battery(ies) in a car exposed to direct sunlight for a long period of time with doors and windows closed.

Charging and recording time

■ Charging/Recording time

- Temperature: 25 °C/humidity: 60%RH
- Charging times in parentheses are when charging from the USB terminal.

Battery model number [Voltage/Capacity (minimum)]	Charging time	Recording mode	Maximum continuously recordable time	Actual recordable time
Supplied battery/ VW-VBK180 (optional) [3.6 V/1790 mAh]	2 h 25 min (5 h 45 min)	[1080/50p]	1 h 20 min	40 min
		[HA],[HG]	1 h 25 min	45 min
		[HX],[HE]	1 h 30 min	
		[iFrame]	1 h 35 min	

- These times are approximations.
 - **The indicated charging time is for when the battery has been discharged completely. Charging time and recordable time vary depending on the usage conditions such as high/low temperature.**
 - Recordable time of 3D recording mode is the same. (During 3D recording mode, 1080/50p and iFrame recording mode cannot be used.)
-
- The actual recordable time refers to the recordable time when repeatedly starting/stopping recording, turning the unit on/off, moving the zoom lever etc.
 - The batteries heat up after use or charging. This is not a malfunction.

Battery capacity indication

- The display changes as the battery capacity reduces.



If there is less than 3 minutes remaining, then will become red. If the battery discharges, then will flash.

- Screen display will disappear when no touch operation is performed for a specific period of time. However, it will be constantly displayed when the remaining battery time becomes less than 30 minutes.
- The remaining battery capacity is displayed when using the Panasonic battery that you can use for this unit. The actual time can vary depending on your actual use.
- When using the AC adaptor or batteries made by other companies, the remaining battery capacity will not be shown.

Recording to a card

The unit can record still pictures or motion pictures to an SD card or built-in memory. To record to an SD card, read the following.

This unit (an SDXC compatible device) is compatible with SD Memory Cards, SDHC Memory Cards and SDXC Memory Cards. When using an SDHC Memory Card/SDXC Memory Card with other equipment, check the equipment is compatible with these Memory Cards.

Cards that you can use with this unit

Use SD cards conforming to Class 4 or higher of the SD Speed Class Rating* for motion picture recording.

Card type	Capacity
SD Memory Card	512 MB/1 GB/2 GB
SDHC Memory Card	4 GB/6 GB/8 GB/12 GB/16 GB/24 GB/32 GB
SDXC Memory Card	48 GB/64 GB

* SD Speed Class Rating is the speed standard regarding continuous writing. Check via the label on the card, etc.

e.g.:



- Please confirm the latest information about SD Memory Cards/SDHC Memory Cards/SDXC Memory Cards that can be used for motion picture recording on the following website.

http://panasonic.jp/support/global/cs/e_cam

(This website is in English only.)

- Operation of the SD Memory Cards 256 MB or less is not guaranteed. Also, the SD Memory Card 32 MB or less cannot be used for the motion picture recording.
- 4 GB or more Memory Cards that do not have the SDHC logo or 48 GB or more Memory Cards that do not have the SDXC logo are not based on SD Memory Card Specifications.
- The operation of Memory Cards exceeding 64 GB cannot be guaranteed.
- When the write-protect switch **A** on SD card is locked, no recording, deletion or editing will be possible on the card.
- Keep the Memory Card out of reach of children to prevent swallowing.

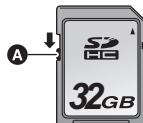

Inserting/removing an SD card

When using an SD card not from Panasonic, or one previously used on other equipment, for the first time on this unit, format the SD card. (→ 22) When the SD card is formatted, all of the recorded data is deleted. Once the data is deleted, it cannot be restored.

Caution:

Check that the access lamp has gone off.

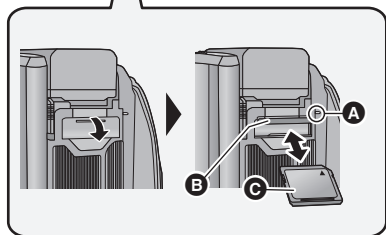
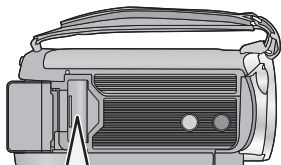

Access lamp [ACCESS] **A**

- When this unit is accessing the SD card or built-in memory, the access lamp lights up.

1 Open the SD card cover and insert (remove) the SD card into (from) the card slot **B**.

- Face the label side **C** in the direction shown in the illustration and press it straight in as far as it will go.
- Press the centre of the SD card and then pull it straight out.

2 Securely close the SD card cover.

- Securely close it until it clicks.

- Do not touch the terminals on the back of the SD card.
- Do not apply strong shocks, bend, or drop the SD card.
- Electrical noise, static electricity or the failure of this unit or the SD card may damage or erase the data stored on the SD card.
- When the card access lamp is lit, do not:
 - Remove the SD card
 - Turn the unit off
 - Insert and remove the USB cable
 - Expose the unit to vibrations or shockPerforming the above while the lamp is on may result in damage to data/SD card or this unit.
- Do not expose the terminals of the SD card to water, dirt or dust.
- Do not place SD cards in the following areas:
 - In direct sunlight
 - In very dusty or humid areas
 - Near a heater
 - Locations susceptible to significant difference in temperature (condensation can occur.)
 - Where static electricity or electromagnetic waves occur
- To protect SD cards, return them to their cases when you are not using them.
- About disposing of or giving away the SD card.
(Refer to the Operating Instructions (PDF format))

Turning the unit on/off

You can turn the unit on and off using the power button or by opening and closing the LCD monitor.

Turning the unit on and off with the power button

Open the LCD monitor and press the power button to turn on the unit.

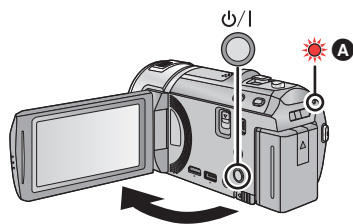

To turn off the unit



Hold down the power button until the status indicator goes off.

A The status indicator lights on.



The unit is turned on when the LCD monitor is opened, and unit is turned off when it is closed.

Selecting a mode

Change the mode to recording or playback.

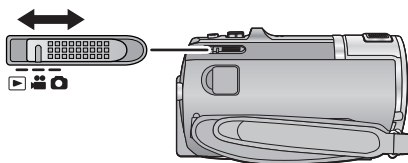
Operate the mode switch to change the mode to ,  or .



	Motion Picture Recording Mode (→ 18)
	Still Picture Recording Mode (→ 18)
	Playback Mode (→ 19)

How to use the touch screen

You can operate by directly touching the LCD monitor (touch screen) with your finger.

■ Touch

Touch and release the touch screen to select icon or picture.

- Touch the centre of the icon.
- Touching the touch screen will not operate while you are touching another part of the touch screen.

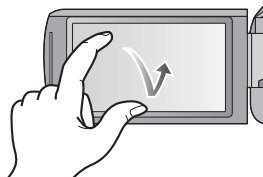

■ Slide while touching

Move your finger while pressing on the touch screen.

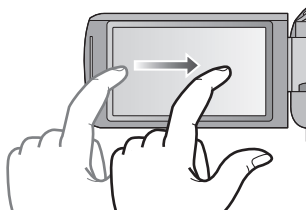

■ About the operation icons



These icons are used to switch the menu and thumbnail display page, for item selection and setting etc.



Touch to return to the previous screen such as when setting menus.

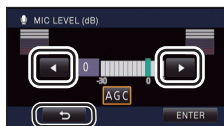

About the Touch Menu

Touch ◀ (left side)/▶ (right side) of  on the Touch Menu to switch the operation icons.

Touch ◀ (left side)/▶ (right side) of  on the Touch Menu.

- It is also possible to switch the operation icons by sliding the Touch Menu right or left while touching it.

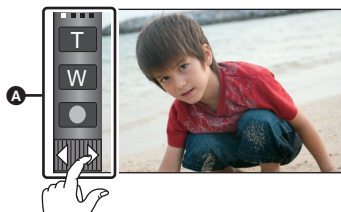

A Touch Menu

Recording Mode

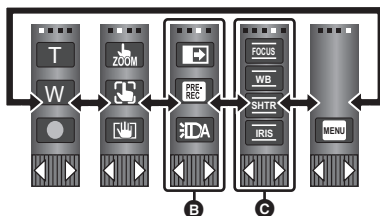

Playback Mode

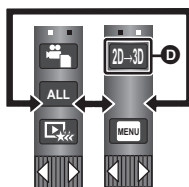

- B** You can change the operation icons to display.
- C** Displayed only during the Manual Mode.
- D** Displayed only when connected to a TV.

■ To display the Touch Menu



Display of the Touch Menu will disappear when no touch operation is performed for a specific period of time. To display it again, touch .

- Do not touch the LCD monitor with hard pointed tips, such as ball point pens.



Setting date and time

When the unit is turned on for the first time, a message asking you to set the date and time will appear.

Select [YES] and perform steps 2 to 3 below to set the date and time.

1 Select the menu. (→ 21)

MENU : [SETUP] → [CLOCK SET]

2 Touch the date or time to be set, then set the desired value using



A Displaying the World time setting:

🏠 [HOME] / ✈️ [DESTINATION]

- The year can be set between 2000 and 2039.
- The 24-hour system is used to display the time.





3 Touch [ENTER].

- A message prompting for World Time setting may be displayed. Perform the World Time setting by touching the screen.
 - Touch [EXIT] to complete the setting.
-
- The date and time function is driven by a built-in lithium battery.
 - If the time display becomes [- -], the built-in lithium battery needs to be charged. To recharge the built-in lithium battery, connect the AC adaptor or attach the battery to this unit. Leave the unit as it is for approx. 24 hours and the battery will maintain the date and time for approx. 4 months. (The battery is still being recharged even if the unit is off.)

Selecting a media to record [HC-V700M]

The card and built-in memory can be selected separately to record motion pictures or still pictures.

- 1 Change the mode to  or .
- 2 Select the menu. (→ 21)

MENU : [MEDIA SELECT]

- 3 Touch the media to record motion pictures or still pictures.
 - The media is selected separately to motion pictures or still pictures is highlighted in yellow.
- 4 Touch [ENTER].

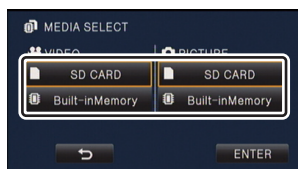

Intelligent Auto Mode

The modes (appropriate for the condition) are set just by pointing the unit to what you want to record.

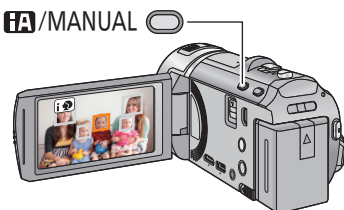

Intelligent auto/Manual button
Press this button to switch Intelligent Auto Mode/Manual Mode.



Recording motion pictures

- 1 Change the mode to .
- 2 Open the LCD monitor.
- 3 Press the recording start/stop button to start recording.



- A Recording button icon
- B When you begin recording, changes to .

- Recording can also be started/stopped by touching the recording button icon. This icon functions in the same manner as the recording start/stop button.

- 4 Press the recording start/stop button again to pause recording.

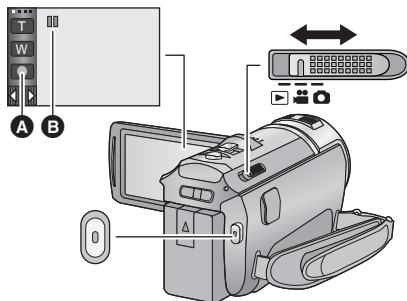

Recording still pictures

- 1 Change the mode to .
- 2 Open the LCD monitor.
- 3 Press the button halfway. (For Auto Focus only)



- 4 Press the button fully.

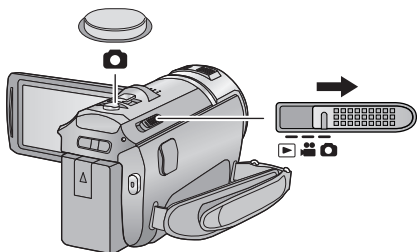

Motion picture/Still picture playback

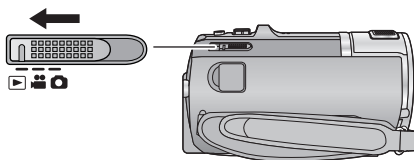

- 1 Change the mode to .
- 2 Touch the play mode select icon **A**.
(→ 15)



- 3 **[HC-V700]**
Select the still picture **B** or the recording format of the motion picture **C** you wish to play back.

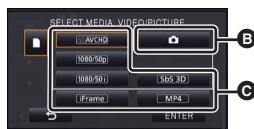

[HC-V700M]

- 3 Select the media type **D** and then select the still picture **B** or the recording format of the motion picture **C** you wish to play back.

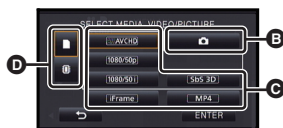

- Touch [ENTER].
- The icon is displayed in the thumbnail display when the item motion picture is touched.
(**AVCHD**, **1080/50p**, **1080/50i**, **Sbs 3D**, **I Frame** and **MP4**)
- **50p** is displayed in the 1080/50p scene and **3D** is displayed in the side-by-side scenes when [ALL AVCHD] is touched.

- 4 Touch the scene or the still picture to be played back.

- It will switch to the screen displaying and thumbnail scroll lever **E** when no operation is performed for approximately 5 seconds in the thumbnail display screen.
- To display the next (previous) page:
 - Slide the thumbnail display upward (downward) while touching it.
 - Touch (up) / (down) of the thumbnail scroll lever.

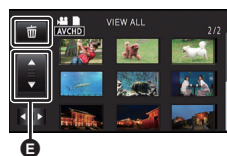

5 Select the playback operation by touching the operation icon.



F Operation icon

- Operation icons and screen display will disappear when no touch operation is performed for a specific period of time. To display them again, touch the screen.

Motion picture playback	Still picture playback
<ul style="list-style-type: none">▶/ : Playback/Pause◀◀: Rewind playback▶▶: Fast forward playback■: Stops the playback and shows the thumbnails.	<ul style="list-style-type: none">▶/ : Slide show (playback of the still pictures in numerical order) start/pause.◀ : Plays back the previous picture. ▶: Plays back the next picture.■: Stops the playback and shows the thumbnails.

Watching Video/Pictures on your TV

1 Connect this unit to a TV.

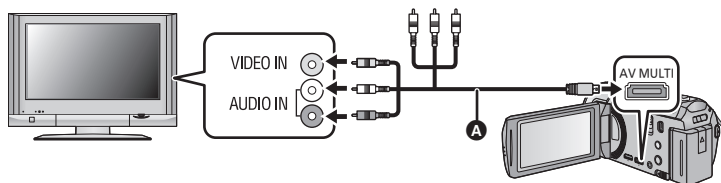

A AV multi cable (supplied)

- Check that the plugs are inserted as far as they go.
- Do not use any other AV multi cables except the supplied one.
- When connecting to the component terminal of the TV, the yellow plug of the AV multi cable is not required.
- When connecting to the AV terminal of the TV, do not connect the component terminal plug of the AV multi cable. Image may not display when the component terminal plug is connected simultaneously.

2 Select the video input on the TV.

3 Change the mode to to play back.

Using the menu screen

- Touch ◀ (left side)/▶ (right side) of  on the Touch Menu to display . (→ 15)

1 Touch .



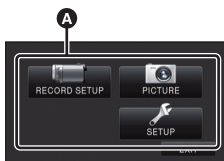

2 Touch the top menu .

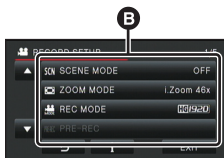

3 Touch the submenu .



- Next (previous) page can be displayed by touching  / .

4 Touch the desired item to enter the setting.



5 Touch [EXIT] to exit the menu setting.

■ About guide display

After touching , touching the submenus and items will cause function descriptions and settings confirmation messages to appear.

- After the messages have been displayed, the guide display is cancelled.

Language selection

You can select the language on the screen display and the menu screen.

 : [SETUP] → [LANGUAGE]



Using the zoom

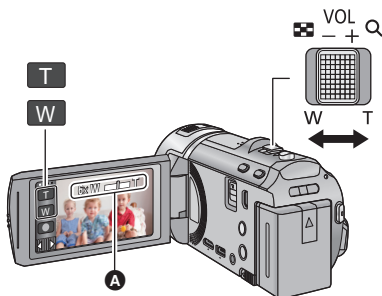

Zoom lever/Zoom button icons

T side:

Close-up recording (zoom in)

W side:

Wide-angle recording (zoom out)

- The zoom speed varies depending on the range over which the zoom lever is moved.

A Zoom bar

The zoom bar is displayed during the zoom operation.

Formatting

Please be aware that if a medium is formatted, then all the data recorded on the medium will be erased and cannot be restored. Back up important data on a PC, DVD disc etc.

Select the menu.

HC-V700

MENU : [SETUP] → [FORMAT CARD]

HC-V700M

MENU : [SETUP] → [FORMAT MEDIA] → [SD CARD] or [Built-inMemory]

Specifications

High Definition Video Camera

Information for your safety

Power source:	DC 5.0 V (When using AC adaptor) DC 3.6 V (When using battery)	
Power consumption:	Recording; 6.7 W	Charging; 7.7 W

Motion picture recording format:

[AVCHD]; AVCHD format version 2.0 compliant (AVCHD Progressive)

[iFrame]; MPEG-4 AVC file format compliant (.MP4)

Motion picture compression:

MPEG-4 AVC/H.264

Audio compression:

[AVCHD]; Dolby Digital/2 ch

[iFrame], [MP4]; AAC/2 ch

Recording mode and transfer rate:

[1080/50p]; Maximum 28 Mbps (VBR)

[HA]; Average 17 Mbps (VBR)

[HG]; Average 13 Mbps (VBR)

[HX]; Average 9 Mbps (VBR)

[HE]; Average 5 Mbps (VBR)

[iFrame]; Maximum 28 Mbps (VBR)

[SbS 3D]; Average 17 Mbps (VBR)

Refer to the operating instructions (PDF format) for the picture size and recordable time of a motion picture.

Still picture recording format:

JPEG (Design rule for Camera File system, based on Exif 2.2 standard)

MPO format compatible (3D still pictures)

Refer to the operating instructions (PDF format) for picture size of a still picture and number of recordable pictures.

Recording media:

SD Memory Card (FAT12 and FAT16 system compliant)

SDHC Memory Card (FAT32 system compliant)

SDXC Memory Card (exFAT system compliant)

Refer to page 11 for details on SD cards usable in this unit.

HC-V700M

Built-in memory; 16 GB

Image sensor:

1/2.33 type (1/2.33") 1MOS image sensor

Total; 15300 K

Effective pixels;

Motion picture; 3550 K to 2580 K (16:9)

Still picture; 2790 K (4:3), 2790 K (3:2), 3550 K to 2580 K (16:9)

Lens:

Auto Iris, 21× optical zoom, F1.8 to F3.5

Focal length;

2.82 mm to 59.2 mm

Macro (Full range AF)

35 mm equivalent;

Motion picture; 28 mm to 717.4 mm (16:9)

Still picture; 34.7 mm to 728.7 mm (4:3), 34.1 mm to 715.2 mm (3:2),
28 mm to 717.4 mm (16:9)

Minimum focus distance;

Normal; Approx. 3.0 cm (Wide)/Approx. 1.5 m (Tele)

Tele Macro; Approx. 60 cm (Tele)

Intelligent Auto Macro; Approx. 1.0 cm (Wide)/Approx. 60 cm (Tele)

Filter diameter:

46 mm

Zoom:

i.Zoom OFF 26×, 46× i.Zoom, 60×/1500× digital zoom

(Using image sensor effective area)

Image stabilizer function:

Optical (Hybrid Optical Image Stabilizer, Active Mode (Rotation correction), Optical Image Stabilizer Lock function)

Monitor:

7.5 cm (3.0") wide LCD monitor (Approx. 460 K dots)

Microphone:

Stereo (with a Zoom Microphone)

Speaker:

1 round speaker, dynamic type

White balance adjustment:

Auto tracking white balance system

Standard illumination:

1,400 lx

Minimum required illumination:

Approx. 4 lx (1/25 with Low Light Mode in the Scene Mode)

Approx. 1 lx with the Colour Night View function

AV multi connector video output level:

Component video out put level;

Y; 1.0 Vp-p, 75 Ω

Pb; 0.7 Vp-p, 75 Ω

Pr; 0.7 Vp-p, 75 Ω

AV video output level;

1.0 Vp-p, 75 Ω, PAL system

HDMI mini connector video output level:

HDMI™ (x.v.Colour™) 1080p/1080i/576p

AV multi connector audio output level (Line):

316 mV, 600 Ω, 2 ch

HDMI mini connector audio output level:

[AVCHD]; Dolby Digital/Linear PCM

[iFrame], [MP4]; Linear PCM

MIC input:

−70 dBV (Mic sensitivity −50 dB equivalent, 0 dB=1 V/Pa, 1 kHz) (Stereo mini jack)

USB:

Reader function

SD card; Read only (No copyright protection support)

HC-V700M

Built-in memory; Read only

Hi-Speed USB (USB 2.0), USB terminal Type Mini AB

USB host function (for DVD burner)

Battery charging function (Charges from USB terminal when the main unit is off)

Flash:

Available range; Approx. 1.0 m to 2.5 m

Dimensions:

55 mm (W)×69 mm (H)×119.5 mm (D)

(including projecting parts)

Mass:

HC-V700

Approx. 270 g [without battery (supplied) and an SD card (optional)]

HC-V700M

Approx. 271 g [without battery (supplied)]

Mass in operation:

HC-V700

Approx. 314 g [with battery (supplied) and an SD card (optional)]

HC-V700M

Approx. 313 g [with battery (supplied)]

Operating temperature:

0 °C to 40 °C

Operating humidity:

10%RH to 80%RH

Battery operation time:

See page 10

AC adaptor

Information for your safety

Power source:	AC 100 V to 240 V, 50/60 Hz
Power consumption:	12 W
DC output:	DC 5.0 V, 1.6 A

Dimensions:

49 mm (W)×24 mm (H)×79 mm (D)

Mass:

Approx. 91 g

■ 3D Conversion Lens (optional)

Lens:

F2.4 (f = 1.47 mm)

35 mm equivalent; 34 mm

Minimum recording distance; Approx. 1.2 m

Minimum required illumination:

Approx. 18 lx (1/25 with Low Light Mode in the Scene Mode)

Others

About copyright

■ Carefully observe copyright laws

Recording of pre-recorded tapes or discs or other published or broadcast material for purposes other than your own private use may infringe copyright laws. Even for the purpose of private use, recording of certain material may be restricted.

■ Licenses

- SDXC Logo is a trademark of SD-3C, LLC.
- “AVCHD”, “AVCHD Progressive” and the “AVCHD Progressive” logo are trademarks of Panasonic Corporation and Sony Corporation.
- Manufactured under license from Dolby Laboratories. Dolby and the double-D symbol are trademarks of Dolby Laboratories.
- HDMI, the HDMI Logo, and High-Definition Multimedia Interface are trademarks or registered trademarks of HDMI Licensing LLC in the United States and other countries.
- x.v.Colour™ is a trademark.
- Microsoft®, Windows® and Windows Vista® are either registered trademarks or

trademarks of Microsoft Corporation in the United States and/or other countries.

- iMovie, Mac and Mac OS are trademarks of Apple Inc. registered in the U.S. and other countries.
- Other names of systems and products mentioned in these instructions are usually the registered trademarks or trademarks of the manufacturers who developed the system or product concerned.

This product is licensed under the AVC patent portfolio license for the personal and non-commercial use of a consumer to (i) encode video in compliance with the AVC Standard (“AVC Video”) and/or (ii) decode AVC Video that was encoded by a consumer engaged in a personal and non-commercial activity and/or was obtained from a video provider licensed to provide AVC Video. No license is granted or shall be implied for any other use. Additional information may be obtained from MPEG LA, LLC. See <http://www.mpegla.com>.

Reading the Operating Instructions (PDF format)

More detailed instructions on the operation of this unit are contained in “Operating Instructions (PDF format)” in the supplied CD-ROM. Install it on your PC to read it.

■ For Windows

1 Turn the PC on and insert the CD-ROM containing the Operating Instructions (supplied).

2 Select the desired language and then click [Operating Instructions] to install.

(Example: When an English language OS)

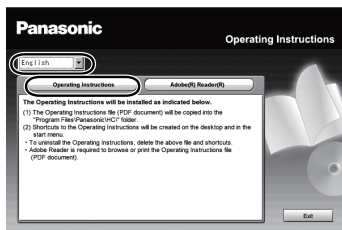

3 Double click the “Operating Instructions” shortcut icon on the desktop.

■ When the Operating Instructions (PDF format) will not open

You will need Adobe Acrobat Reader 5.0 or later or Adobe Reader 7.0 or later to browse or print the Operating Instructions (PDF format).

Download and install a version of Adobe Reader that you can use with your OS from the following Web Site.

<http://get.adobe.com/reader/otherversions>

If using the following OS

- Windows XP SP3
- Windows Vista SP2
- Windows 7

Insert the CD-ROM containing the Operating Instructions (supplied), click [Adobe(R) Reader(R)] and then follow the messages on the screen to install.

■ To uninstall the Operating Instructions (PDF format)

Delete the PDF file from the “Program Files\Panasonic\HC\” folder.

- When the contents in the Program Files folder cannot be displayed, click the [Show the contents of this folder] to display them.

■ For Mac

1 Turn the PC on and insert the CD-ROM containing the Operating Instructions (supplied).

2 Open the “Manual” folder in the CD-ROM and then copy the PDF file with the desired language inside the folder.

3 Double click the PDF file to open it.

Panasonic Corporation

Web site: <http://panasonic.net>

© Panasonic Corporation 2012

VQT4G54

F0212KY0 (500 (A))