

Panasonic®

Operating Instructions

DVD Recorder

Model No. **DMR-EZ485V**

DMR-EZ48V

DIGA



P15 Basic Operations

Dear customer

Thank you for purchasing this product.

For optimum performance and safety, please read these instructions carefully.

Before connecting, operating or adjusting this product, please read the instructions completely.
Please keep this manual for future reference.



Region number supported by this unit

Region numbers are allocated to DVD players and DVD-Video according to where they are sold.

- The region number of this unit is "1".
- The unit will play DVDs marked with labels containing "1" or "ALL".

Example:



If you have any questions contact

In the U.S.A.: 1-800-211-PANA(7262)

In Canada: 1-800-561-5505

For U.S.A. only

The warranty can be found on page 94.

For Canada only

The warranty can be found on page 95.

La referencia rápida en español se encuentra en la página 96-99.

Precautions

CAUTION!

THIS PRODUCT UTILIZES A LASER.
USE OF CONTROLS OR ADJUSTMENTS OR PERFORMANCE OF PROCEDURES OTHER THAN THOSE SPECIFIED HEREIN MAY RESULT IN HAZARDOUS RADIATION EXPOSURE.
DO NOT OPEN COVERS AND DO NOT REPAIR YOURSELF. REFER SERVICING TO QUALIFIED PERSONNEL.

WARNING:

TO REDUCE THE RISK OF FIRE, ELECTRIC SHOCK OR PRODUCT DAMAGE,
• DO NOT EXPOSE THIS APPARATUS TO RAIN, MOISTURE, DRIPPING OR SPLASHING AND THAT NO OBJECTS FILLED WITH LIQUIDS, SUCH AS VASES, SHALL BE PLACED ON THE APPARATUS.
• USE ONLY THE RECOMMENDED ACCESSORIES.
• DO NOT REMOVE THE COVER (OR BACK); THERE ARE NO USER SERVICEABLE PARTS INSIDE. REFER SERVICING TO QUALIFIED SERVICE PERSONNEL.

CAUTION!

DO NOT INSTALL OR PLACE THIS UNIT IN A BOOKCASE, BUILT-IN CABINET OR IN ANOTHER CONFINED SPACE. ENSURE THE UNIT IS WELL VENTILATED. TO PREVENT RISK OF ELECTRIC SHOCK OR FIRE HAZARD DUE TO OVERHEATING, ENSURE THAT CURTAINS AND ANY OTHER MATERIALS DO NOT OBSTRUCT THE VENTILATION VENTS.

THE FOLLOWING APPLIES ONLY IN THE U.S.A.

Note to CATV system installer:

This reminder is provided to call the CATV system installer's attention to Article 820-40 of the NEC that provides guidelines for proper grounding and, in particular, specifies that the cable ground shall be connected to the grounding system of the building, as close to the point of cable entry as practical.

The socket outlet shall be installed near the equipment and easily accessible. The mains plug of the power supply cord shall remain readily operable. To completely disconnect this apparatus from the AC Mains, disconnect the power supply cord plug from AC receptacle.

THE FOLLOWING APPLIES ONLY IN THE U.S.A.

FCC Note:

This equipment has been tested and found to comply with the limits for a Class B digital device, pursuant to Part 15 of the FCC Rules. These limits are designed to provide reasonable protection against harmful interference in a residential installation. This equipment generates, uses, and can radiate radio frequency energy and, if not installed and used in accordance with the instructions, may cause harmful interference to radio communications. However, there is no guarantee that interference will not occur in a particular installation. If this equipment does cause harmful interference to radio or television reception, which can be determined by turning the equipment off and on, the user is encouraged to try to correct the interference by one or more of the following measures:

- Reorient or relocate the receiving antenna.
- Increase the separation between the equipment and receiver.
- Connect the equipment into an outlet on a circuit different from that to which the receiver is connected.
- Consult the dealer or an experienced radio/TV technician for help.

FCC Caution: To assure continued compliance, follow the attached installation instructions and use only shielded interface cables when connecting to peripheral devices.

Any changes or modifications not expressly approved by the party responsible for compliance could void the user's authority to operate this equipment.

This device complies with Part 15 of the FCC Rules. Operation is subject to the following two conditions: (1) This device may not cause harmful interference, and (2) this device must accept any interference received, including interference that may cause undesired operation.

Declaration of Conformity

Trade Name: Panasonic
Model No.: DMR-EZ485V
DMR-EZ48V

Responsible Party:
Panasonic Corporation of North America
One Panasonic Way
Secaucus, NJ 07094

Support Contact:
Panasonic Consumer Electronics Company
Telephone No.: 1-800-211-7262



CAUTION
RISK OF ELECTRIC SHOCK
DO NOT OPEN



CAUTION: TO REDUCE THE RISK OF ELECTRIC SHOCK, DO NOT REMOVE SCREWS. NO USER-SERVICEABLE PARTS INSIDE. REFER SERVICING TO QUALIFIED SERVICE PERSONNEL.



The lightning flash with arrowhead symbol, within an equilateral triangle, is intended to alert the user to the presence of uninsulated "dangerous voltage" within the product's enclosure that may be of sufficient magnitude to constitute a risk of electric shock to persons.



The exclamation point within an equilateral triangle is intended to alert the user to the presence of important operating and maintenance (servicing) instructions in the literature accompanying the appliance.

CAUTION

Danger of explosion if battery is incorrectly replaced. Replace only with the same or equivalent type recommended by the manufacturer. Dispose of used batteries according to the manufacturer's instructions.

DANGER - VISIBLE AND INVISIBLE LASER RADIATION WHEN OPEN. AVOID DIRECT EXPOSURE TO BEAM. FDA 21 CFR/Class IIIb	
CAUTION - CLASS 3B VISIBLE AND INVISIBLE LASER RADIATION WHEN OPEN. AVOID EXPOSURE TO THE BEAM. IEC60825-1 +A2/Class 3B	
ATTENTION - RAYONNEMENT LASER VISIBLE ET INVISIBLE, CLASSE 3B. EN CAS D'OUVERTURE, EVITER UNE EXPOSITION AU FAISCEAU.	
FORSIGTIG - SYNLIG OG USYNLIG LASERSTRÅLING KLASSE 3B. NÅR LAGET ER ÅBENT, UNDGÅ AT BLIVE UDSAT FOR STRÅLEN.	
VARO - AVATTAESSA OLET ALTTIINA LUOKAN 3B NÄKYVÄÄ JA NÄKYMÄTÖNTÄ LASERSÄTELYÄ. VARO ALTISTUMISTA SÄTEELLE.	
WARNING - KLASS 3B SYNLIG OCH OSYNLIG LASERSTRÅLNING NÅR DENNA DEL ÄR ÖPPNAD. UNDVIR EXPOSERING FÖR STRÅLEN.	
VORSICHT - SICHTBARE UND UNSICHTBARE LASERSTRÄHLUNG KLASSE 3B. WENN ABDECKUNG GEÖFFNET, NICHT DEM STRAHL AUSSETZEN.	
注意	- 打开时有可见及不可见激光辐射。避免光束照射。
注意	- ここを開くと可視及び不可視レーザー光が出ます。ビームを見たり、触れたりしないでください。VQL1J70

(Inside of product)

IMPORTANT SAFETY INSTRUCTIONS

Read these operating instructions carefully before using the unit. Follow the safety instructions on the unit and the applicable safety instructions listed below. Keep these operating instructions handy for future reference.

- 1) Read these instructions.
- 2) Keep these instructions.
- 3) Heed all warnings.
- 4) Follow all instructions.
- 5) Do not use this apparatus near water.
- 6) Clean only with dry cloth.
- 7) Do not block any ventilation openings. Install in accordance with the manufacturer's instructions.
- 8) Do not install near any heat sources such as radiators, heat registers, stoves, or other apparatus (including amplifiers) that produce heat.
- 9) Do not defeat the safety purpose of the polarized or grounding-type plug. A polarized plug has two blades with one wider than the other. A grounding-type plug has two blades and a third grounding prong. The wide blade or the third prong are provided for your safety. If the provided plug does not fit into your outlet, consult an electrician for replacement of the obsolete outlet.
- 10) Protect the power cord from being walked on or pinched particularly at plugs, convenience receptacles, and the point where they exit from the apparatus.
- 11) Only use attachments/accessories specified by the manufacturer.
- 12) Use only with the cart, stand, tripod, bracket, or table specified by the manufacturer, or sold with the apparatus. When a cart is used, use caution when moving the cart/apparatus combination to avoid injury from tip-over. 
- 13) Unplug this apparatus during lightning storms or when unused for long periods of time.
- 14) Refer all servicing to qualified service personnel. Servicing is required when the apparatus has been damaged in any way, such as power-supply cord or plug is damaged, liquid has been spilled or objects have fallen into the apparatus, the apparatus has been exposed to rain or moisture, does not operate normally, or has been dropped.

Unit Care

The precision parts in the unit are readily affected by the environment, especially temperature, humidity, and dust. Cigarette smoke also can cause malfunction or breakdown.

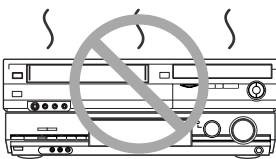
- Do not place the unit on amplifiers or equipment that may become hot. The heat can damage the unit.
 - The unit should not be installed or operated near large magnets or electromagnetic devices. Such devices can damage pre-recorded VHS recordings.
 - Do not place any heavy objects on top of the unit.
 - The unit should not be mounted in a vertical position. It's designed to operate in the horizontal position.
 - Before moving the unit, ensure the disc tray and cassette compartment are empty. Failure to do so will risk severely damaging the disc, tape and the unit.
- 

■ Cautions about condensation

Condensation can cause unreliable playback of recordings. Condensation may form in the following cases,

- The unit is brought from cold surroundings into a well-heated room.
- The unit is suddenly brought from cool surroundings, such as an air-conditioned room or car, to a place which is hot and humid.
- During rainy seasons.

In any of the above-mentioned conditions, do not operate the unit for at least 2 hours. The unit is not equipped with a moisture sensor.

■ When the unit is not to be used for a long time

To save power, unplug the AC power supply cord from the household AC outlet. The unit consumes a small amount of power even when it is turned off.

Standby power consumption

		Front Display (→ 63)	
		Automatic	Bright
Quick Start (→ 58)	On	Approx. 17.6 W	Approx. 17.6 W
	Off	Approx. 1.7 W	Approx. 3.5 W

■ Maintenance

To clean the unit

Wipe with a soft, dry cloth.

- Never use alcohol, thinner or benzene to clean the unit.
- Before using chemically treated cloth, carefully read the instructions that came with the cloth.

To clean the DVD lens

Dust and dirt may adhere to the unit's lens over time, possibly making it impossible to record or play discs.

Use the DVD lens cleaner about once every year, depending on frequency of use and the operating environment.

Carefully read the lens cleaner's instructions before use.

DVD lens cleaner: RP-CL720PP

To clean the video heads

Dirt on the video heads can cause poor recording and play.

If the picture does not improve, use a head-cleaning cassette. If the problem persists, seek advice from a qualified service person.

Head-cleaning cassette: NV-TCL30PT (Only for U.S.A.)

Table of Contents, Accessories

Getting Started

Precautions.....	2
IMPORTANT SAFETY INSTRUCTIONS	3
Unit Care.....	3
Accessories.....	5
Remote Control Information.....	5
Control Reference Guide	6
Main Unit.....	6
The Unit's Display.....	6
Remote Control.....	7
Rear Panel.....	7
Basic Connection	8
Connecting to a Television with Direct Cable or Antenna (No Cable Box or Satellite Receiver).....	8
Connecting to a Television and a Cable Box.....	9
Connecting to a Television and a Satellite Receiver.....	10
Connecting to a TV with an HDMI (High Definition Multimedia Interface) Cable.....	11
Setting the Channels and Clock	12
Acquiring the setting information from the TV (VIERA).....	14

Basic Operations

Media Handling	15
Inserting Discs.....	15
Inserting a Video Cassette.....	15
Inserting USB memory.....	15
Inserting an SD Card.....	15
Watching Television	16
Playback	17
Playing a Disc.....	17
Playing a Video Cassette.....	17
Recording Television Programs	18
Scheduled Recording	19
Copying Recordings	20
Copying Recordings (VHS → DVD).....	20
Copying Recordings (DVD → VHS).....	21
Deleting Recordings	22
Delete Navigator.....	22
Deleting Recordings During Playback.....	22

Advanced Features

Important Notes for Recording	23
Advanced Recording	24
DVD Recording Modes and Estimated Disc Recording Time.....	24
VHS Recording Modes and Estimated Recording Time.....	24
When the format confirmation screen is displayed.....	25
When removing a recorded disc.....	25
Selecting Audio Channels to record.....	25
Specifying the Recording Time.....	26
Flexible Recording.....	26
Playing while you are recording.....	26
Advanced Scheduled Recording	27
To cancel a scheduled recording in progress.....	27
Check, Change, or Delete Programs.....	27
To release the unit from recording standby (Before recording starts).....	27
Recording from an External Device	28
Recording from a VCR, etc.....	28
Recording from a DV Camcorder.....	29
Advanced Disc Playback	30
Zoom in on video.....	30
Menu Screens on the TV.....	30
Selecting Recordings to Play.....	30
Search.....	30
Skip.....	30
Direct Play.....	30
Quick View (Play × 1.3).....	31
Slow-motion Play.....	31
Frame-by-Frame Viewing.....	31
Time Slip.....	31
CM Skip.....	31
Create Chapters.....	31
Changing Audio during Playback.....	31
Playing Playlists	32
Playlist Properties.....	32
View Chapters.....	32

Playing MP3s.....	33
Playing Still Pictures (JPEG).....	34
Playing DivX.....	36
Advanced Video Cassette Playback	37
Zoom in on video.....	37
Fast-forward/Rewind.....	37
Slow playback.....	37
Cue/Review.....	37
Jet Search.....	37
Jet Rewind.....	37
VHS Index Search System (VISS).....	37
S-VHS Quasi Playback (SQPB).....	38
Repeat Playback.....	38
Changing Audio during Playback.....	38
Adjusting the playback picture.....	38
Status Messages	39
On-screen Display Indicators for Video Cassette Playback.....	39

Linked Operations with the TV (VIERA Link™ "HDMI Control™").....	40
Easy control only with VIERA Remote Control.....	41
FUNCTIONS Window	42

Entering Text.....	42
--------------------	----

Advanced Editing

Recordings—Editing	43
Accessing the Recording View.....	43
Editing Operations to Recordings.....	43
Chapters—Creating, Editing	45
Accessing the Chapter View.....	45
Chapter Operations.....	45
Still Pictures—Editing	46
Accessing the Album/Picture View.....	46
Album/Picture Operations.....	46
Copying Still Pictures	48
Importing Still Pictures from an SD card or USB memory.....	48
Copying Still Pictures via the Album View Screen.....	48
Deleting Still Pictures	49
Delete Navigator.....	49

Setting Menus

Setting DVD On-Screen Menus	50
Accessing the DVD On-Screen Menus.....	50
DVD and Card Management	52
Accessing the Management Menus.....	52
Setup Menu	55
Set Channels Automatically.....	55
Set Channels Manually.....	55
Surf Mode.....	56
Parental Rating.....	56
Off Timer.....	57
Remote Control.....	57
Clock Settings.....	57
Quick Start.....	58
DivX Registration.....	58
Restore Default Settings.....	59
Settings for Playback.....	59
Settings for Recording.....	60
Still Mode (paused video).....	60
Black Level Control.....	60
Dynamic Range Compression.....	60
Multi-channel TV Sound (Analog).....	61
Multi-channel TV Sound (Digital).....	61
Digital Audio Output.....	61
Select Audio Channel For DV Input.....	62
Status Messages.....	62
On-screen Language.....	62
Black Background (Analog).....	62
Front Display.....	63
Closed Caption.....	63
TV Aspect.....	64
4:3 TV settings for DVD-Video.....	64
4:3 TV settings for DVD-RAM.....	64
Component Output Signal.....	64
Functions of HDMI.....	65
Select Tape Length.....	66
Jet Search.....	66
Parental Rating List	67

Other Settings

Other Settings	68
Using the Unit's Remote Control to Operate the TV and the Set Top Box (Cable Box, Satellite Receiver, etc.).....	68

Reference

Connection Options for Improved Playback Quality	70
DVD output and DVD/VHS output.....	70
Using an S Video Cable for Better Video (S Video Cable not included)	70
Using Component Video Cables for Better Video (Component Video Cables not included)	71
Using an Audio Cable for Better Sound (Audio Cable not included).....	72
Using an Optical Digital Audio Cable for Better Sound (Optical Digital Audio Cable not included)	72
Using an HDMI (High Definition Multimedia Interface) Cable	72
SD Card and USB Memory Information	73
USB memories you can use with this unit.....	73
SD Cards Usable with this Unit.....	73
Disc Information.....	74
Usable Discs for Recording and Playback.....	74
Play-only Discs	75
Discs that Cannot be Played.....	75
Media Care	75
MP3s, DivX and Still Pictures (JPEG)	76
MP3 File Information.....	76
Still Picture (JPEG) Information.....	76
DivX File Information.....	76
Frequently Asked Questions	77
Setup	77
Discs	77
Recording.....	78
USB.....	78

Error Messages	79
On the Unit's Display.....	79
On the TV.....	80
Troubleshooting Guide	81
If the Antenna Connector doesn't Match	81
Changing RF Output Channel.....	81
To Reset This Unit.....	81
General Issues: Power.....	82
General Issues: Displays	82
General Issues: Operation	83
General Issues: VIERA Link.....	84
General Issues: USB.....	84
Playback Issues: Picture	85
Playback Issues: Sound.....	86
Playback Issues: Operation.....	87
Playback Issues: VHS	88
Recording Issues: DVD Recording/Scheduled Recording/ Copying/External Input	88
Recording Issues: VHS Recording.....	90
Editing Issues: DVD & SD	90
Editing Issues: Still Pictures.....	90
Glossary	91
Specifications	92
Product Service	93
Product information.....	93
Limited Warranty (ONLY FOR U.S.A.)	94
Limited Warranty (ONLY FOR CANADA).....	95
Referencia rápida en español (Spanish Quick Reference).....	96
Index.....	Back cover

Accessories



Please check and identify the supplied accessories. Use numbers indicated in parentheses when asking for replacement parts.

(Product numbers correct as of December 2007. These may be subject to change.)

Only for U.S.A.: To order accessories, refer to "Accessory Purchases" on page 94.

Only for Canada: To order accessories, call the dealer from whom you have made your purchase.



- 1 Remote control
(N2QAYB000197)

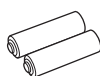

- 2 Batteries for
remote control



- 1 75 Ω coaxial cable
(K2KZ2BA00001)

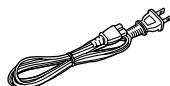

- 1 AC power supply cord
(K2CB2CB00018)
●For use with this unit only. Do
not use it with other equipment.
Also, do not use cords for other
equipment with this unit.



- 1 Audio/video cable
(K2KA2BA00003)



- 1 HDMI cable
(DMR-EZ485V only)
(K1HA19DA00007)

(U.S.A. only) Product Registration Card

Please complete and return the included product registration card, or register via the Internet at: <http://www.prodreg.com/panasonic/>

(Canada only)

The enclosed Canadian French label sheet corresponds to the English display on the front and back sides of the unit.

Remote Control Information

About batteries

- Insert so the poles (+ and -) match those in the remote control.
- Do not use rechargeable type batteries.

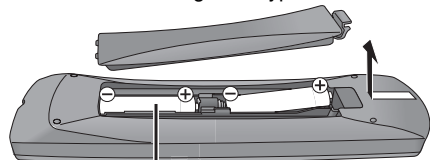

R6/LR6, AA

- Do not mix old and new batteries.
 - Do not use different types at the same time.
 - Do not heat or expose to flame.
 - Do not leave the battery(ies) in an automobile exposed to direct sunlight for a long period of time with doors and windows closed.
 - Do not take apart or short circuit.
 - Do not attempt to recharge alkaline or manganese batteries.
 - Do not use batteries if the covering has been peeled off.
- Mishandling of batteries can cause electrolyte leakage which can damage items the fluid contacts and may cause a fire.

Remove if the remote control is not going to be used for a long period of time. Store in a cool, dark place.

Using the remote control

Aim at the sensor, avoiding obstacles, up to a maximum range of 7 m (23 feet) directly in front of the unit.

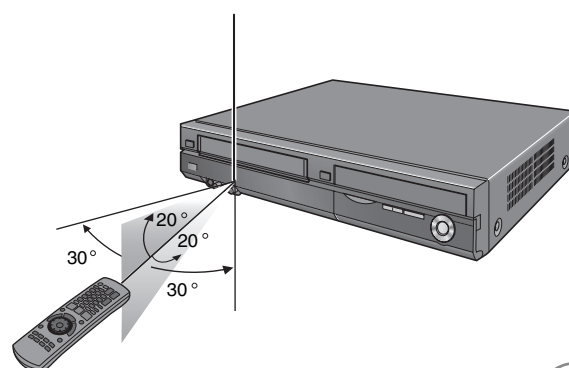

Control Reference Guide

Main Unit

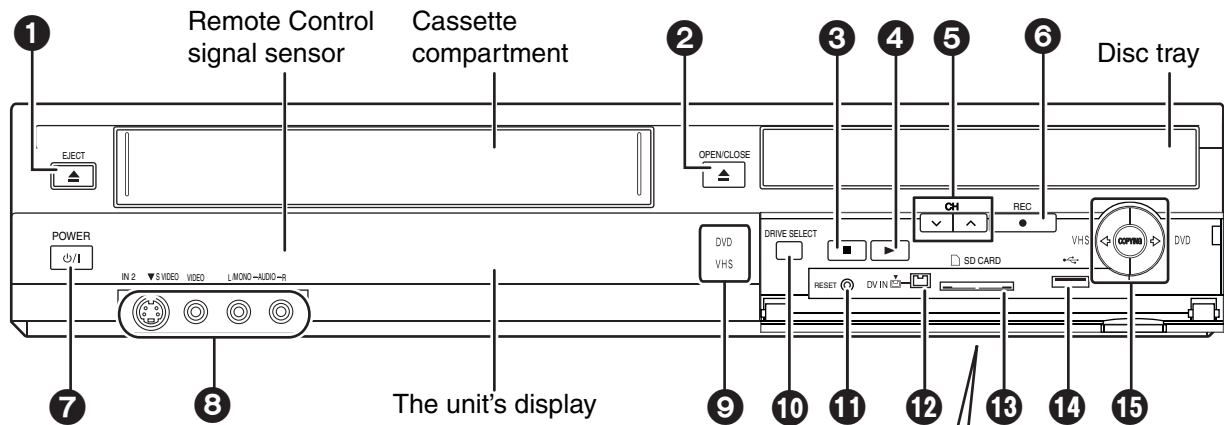

Opening the front panel Pull down.

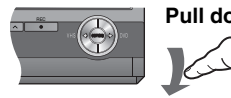

- | | |
|---------------------------------------------------------------------------------------------------------------------------------------------------------------------------------------------------------------------------------------------------------------------------------------------------------------------------------------------------------------------------------------------------------------------------------------------------------------------------------------------------------------------------------------------------------------------------------------------------------------------|----------------------------------------------------------------------------------------------------------------------------------------------------------------------------------------------------------------------------------------------------------------------------------------------------------------------------------------------------------------------------------------------------------------------------------------------------------------------------------------------------------------------------------------------------------------------------------------------------------------------------------------------------------------------------------------------|
| <ul style="list-style-type: none"> ➊ Cassette eject button(→ 15) ➋ Disc tray open/close button.....(→ 15) ➌ Stop button.....(→ 17, 18) ➍ Play/× 1.3 button(→ 17) ➎ Channel select button(→ 13) ➏ Recording button.....(→ 18) ➐ DVD/VHS POWER on/off button (⏻/⏻ POWER)(→ 12) <ul style="list-style-type: none"> • Press to switch the unit from on to standby mode or vice versa. In the standby mode, the unit is still consuming a small amount of power. ➑ IN2 input terminals(→ 28) | <ul style="list-style-type: none"> ➒ DVD/VHS drive indicator.....(→ 17) <ul style="list-style-type: none"> • Lights when the DVD or VHS drive is selected. ➓ Drive select button(→ 17) <ul style="list-style-type: none"> • Drive changes each time you press [DRIVE SELECT]. ➑ Reset button.....(→ 81) ➒ DV IN terminal (for a digital video camcorder).....(→ 29) ➓ SD card slot.....(→ 15) ➑ USB port(→ 15) ➒ One touch copying operation button <ul style="list-style-type: none"> • From VHS to DVD(→ 20) • From DVD to VHS(→ 21) |
|---------------------------------------------------------------------------------------------------------------------------------------------------------------------------------------------------------------------------------------------------------------------------------------------------------------------------------------------------------------------------------------------------------------------------------------------------------------------------------------------------------------------------------------------------------------------------------------------------------------------|----------------------------------------------------------------------------------------------------------------------------------------------------------------------------------------------------------------------------------------------------------------------------------------------------------------------------------------------------------------------------------------------------------------------------------------------------------------------------------------------------------------------------------------------------------------------------------------------------------------------------------------------------------------------------------------------|

The Unit's Display

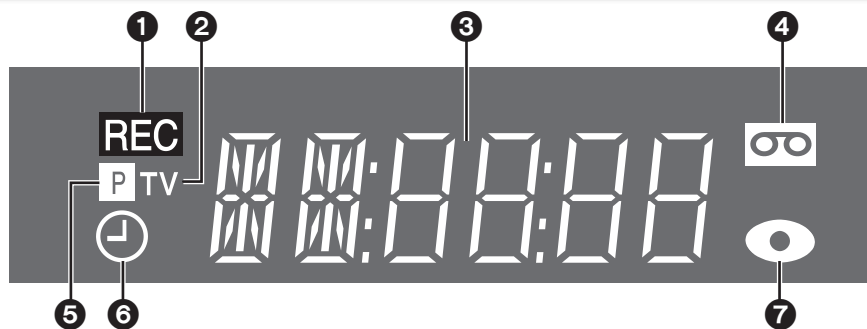

- | | |
|-------------------------------------------------------------------------------------------------------------------------------------------------------------------------------------------------------------------------------------------------------------------------------------------------------------------------------------------------------------------------------------------------------|--------------------------------------------------------------------------------------------------------------------------------------------------------------------------------------------------------------------------------------------------------------------------------------------------------------------------------------------------------------------------------------------------------------------------------------------------------------------------------------------------------------------------------|
| <ul style="list-style-type: none"> ➊ Recording indicator ➋ TV indicator
The indicator lights during TV mode and it goes out during VCR mode. You can switch the mode by using [VCR/TV] (→ 16). ➌ Main display section ➍ Tape indicator ➎ Progressive indicator
This indicator lights up when you select "24p" in "Progressive/24p" (→ 51). | <ul style="list-style-type: none"> ➏ Scheduled recording indicator (→ 19)
On:
When a scheduled recording program is registered and a recordable disc or tape is inserted.
Flashes:
The scheduled recording indicator flashes when the unit cannot go to scheduled recording standby (e.g. there is no disc or tape, etc). It does not flash if Quick Start is off. ➐ Disc indicator
This indicator lights up when a disc that is supported by this unit is inserted. |
|-------------------------------------------------------------------------------------------------------------------------------------------------------------------------------------------------------------------------------------------------------------------------------------------------------------------------------------------------------------------------------------------------------|--------------------------------------------------------------------------------------------------------------------------------------------------------------------------------------------------------------------------------------------------------------------------------------------------------------------------------------------------------------------------------------------------------------------------------------------------------------------------------------------------------------------------------|

Remote Control

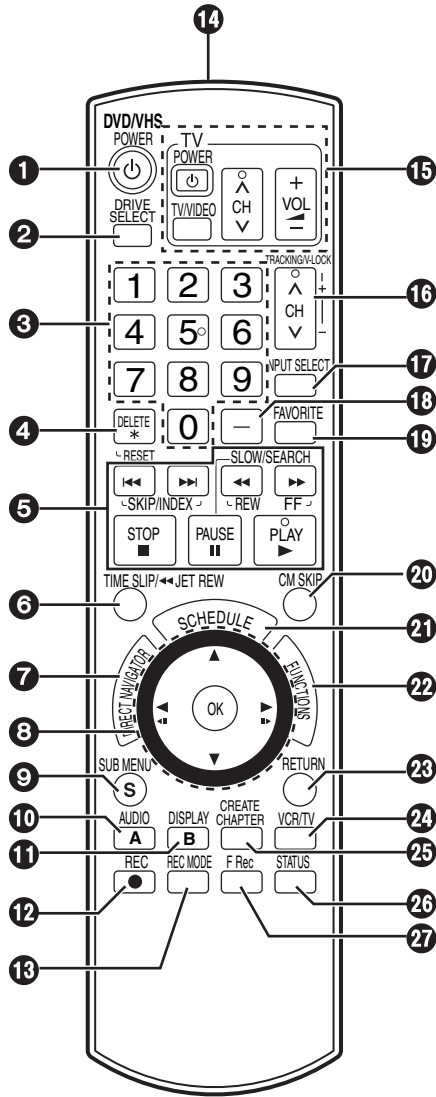

- 1 Turn the unit on or off (→ 12)
- 2 Select drive (DVD, VHS, SD or USB) (→ 17, 33, 34)
- 3 Select channels and recording numbers etc./
Enter numbers (→ 16)
- 4 Delete/Reset the tape counter
- 5 Basic operations for recording and play
- 6 Skip the specified time/
Jet rewind button (→ 31, 37)
- 7 Direct Navigator (→ 30)
- 8 Selection/OK, Frame-by-frame (→ 31)
- 9 Show sub menu (→ 32, 43)
- 10 Select audio (→ 25, 31, 38)
[A] for Recordings screen (→ 30)
- 11 Show DVD on-screen menu (→ 50)
[B] for Album View screen (→ 34)
- 12 Start recording (→ 18)
- 13 Change recording mode (→ 18)
- 14 Transmission window
- 15 TV and Set Top Box operations (→ 68)
- 16 Channel select/TRACKING/V-LOCK (→ 16, 38)
- 17 Input select (TV, IN1, IN2, DV) (→ 28)
- 18 Sub channel access for digital broadcasts (→ 16)
- 19 Favorite (→ 16)
- 20 Skip 1 minute forward (→ 31)
- 21 Show scheduled recording list (→ 19)
- 22 Show FUNCTIONS window (→ 42)
- 23 Return to previous screen
- 24 Select VCR/TV (→ 16)
- 25 Create chapters (→ 31)
- 26 Show status messages (→ 39)
- 27 Start Flexible Recording (→ 26)

Rear Panel

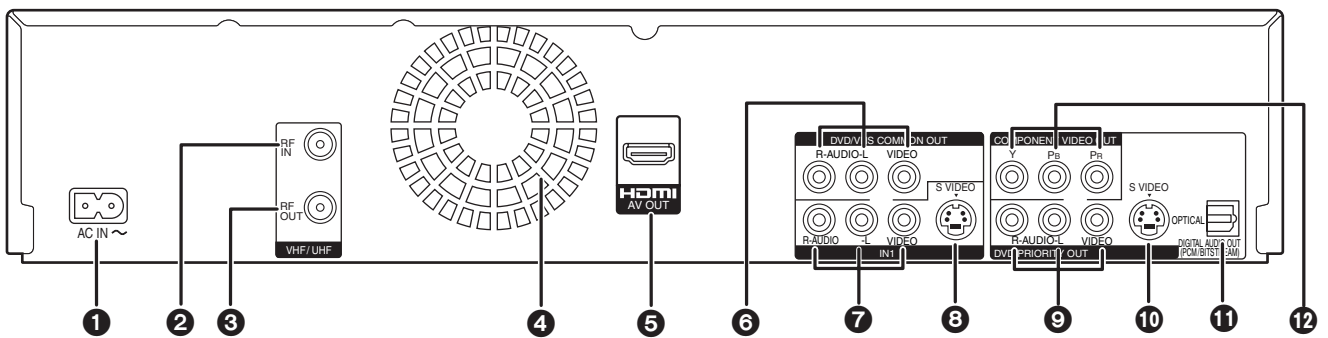

- 1 AC IN~ = Power supply
- 2 RF input terminal (→ 8, 9)
- 3 RF output terminal (→ 8, 9)
- 4 Cooling fan
- 5 HDMI AV OUT terminal (→ 11, 72)
- 6 AUDIO/VIDEO output terminals
(DVD/VHS COMMON OUT) (→ 8-11, 70-72)
- 7 AUDIO/VIDEO input terminals (→ 9, 10)
- 8 S VIDEO input terminal
- 9 AUDIO/VIDEO output terminals
(DVD PRIORITY OUT) (→ 70, 71)
- 10 S VIDEO output terminal (→ 70)
- 11 DIGITAL AUDIO OUT terminal (→ 72)
- 12 COMPONENT VIDEO OUT terminals (→ 71)

Basic Connection

The connection diagrams represent typical installations. These diagrams may not work with certain in-house cable systems, master antenna installations, or situations where TV programming is delivered using methods that differ from industry accepted practices. If you require assistance with connections, please contact Panasonic at 1-800-211-7262 (for U.S.A.) or 1-800-561-5505 (for Canada).

Connecting to a Television with Direct Cable or Antenna (No Cable Box or Satellite Receiver)

Note: The terminals on the rear of your TV may not appear as shown below. Please read terminal labels carefully to ensure correct connections.

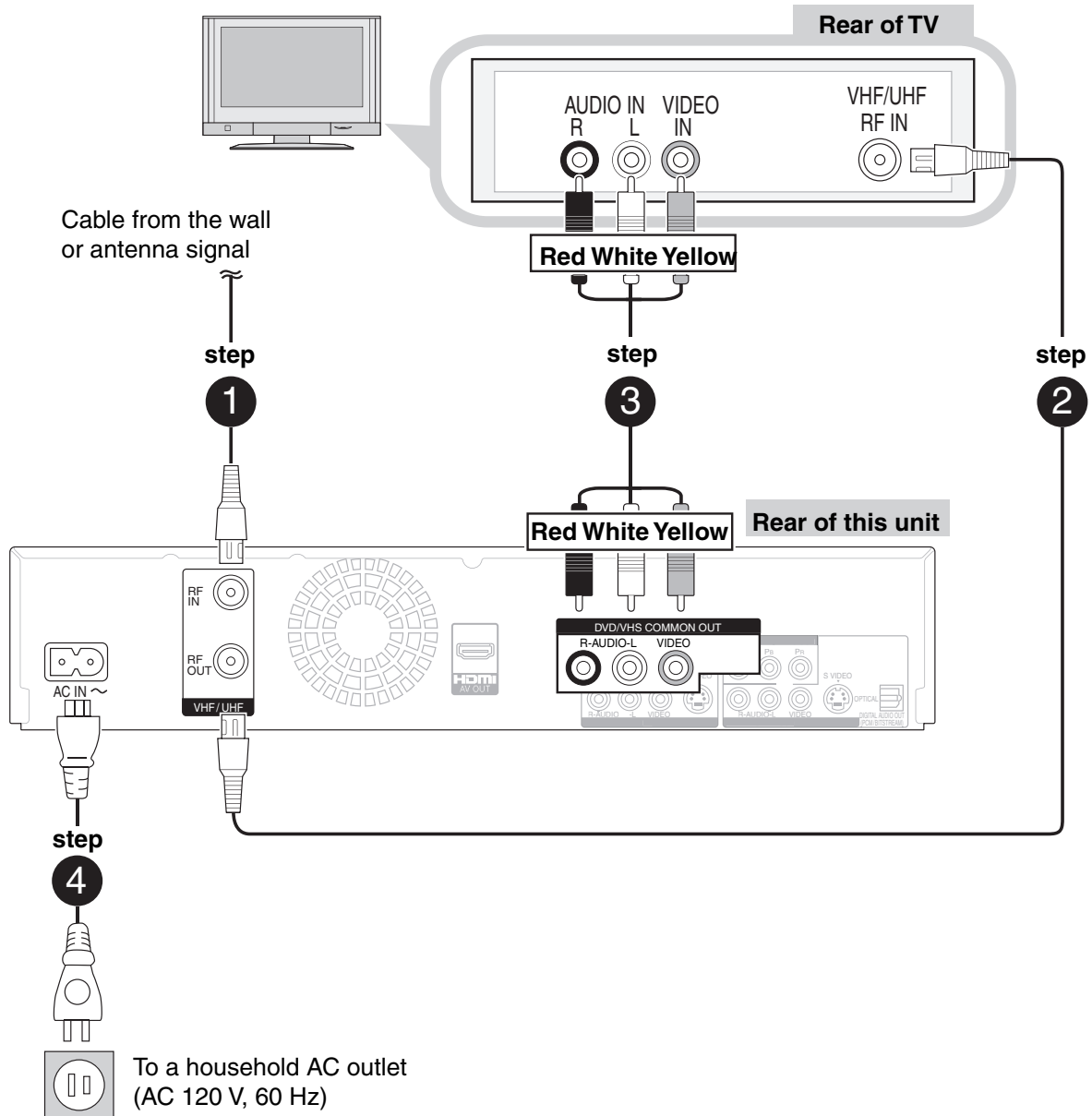

■ Connection (with Audio/Video cable)

Connect in numbered order ① to ④.

- After this connection, set the RF output channel "OFF" (→12).

■ Connection (without Audio/Video cable)

You do not need to connect ③.

- After this connection, set the RF output channel "CH3" or "CH4" (→12).

- ① 75 Ω coaxial cable from the wall or antenna signal to the "RF IN" on the unit.
- ② 75 Ω coaxial cable (*included*) from the "RF OUT" on the unit to the "VHF/UHF RF IN" on the TV.
- ③ Audio/video cable (*included*) from the "DVD/VHS COMMON OUT" on the unit to the "AV IN" on the TV.
- ④ AC power supply cord (*included*) from the "AC IN~" on the unit to a household AC outlet.

Connecting to a Television and a Cable Box

Please check with your Cable Service Provider to verify whether the coaxial cable from the Cable Wall Jack must be connected to your Cable Box first, before connecting to other devices.

- Consult your cable service provider about the appropriate cable box to use.
- Additional coaxial cable and audio/video (AV) cable are required.

Note: The terminals on the rear of your TV and cable box may not appear as shown below. Please read terminal labels carefully to ensure correct connections.

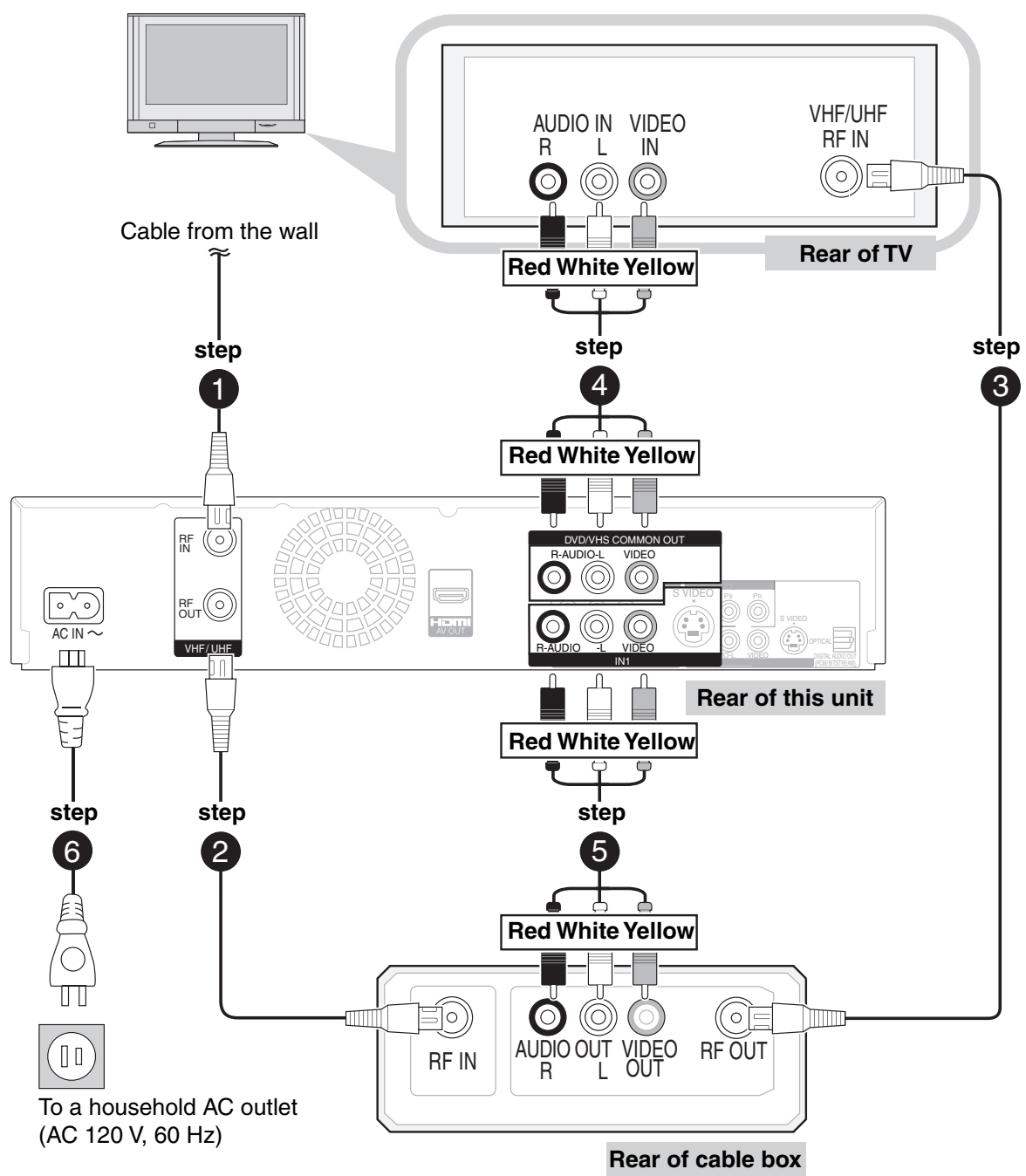

- 1 75 Ω coaxial cable from the wall to the “RF IN” on the unit.
- 2 75 Ω coaxial cable (*included*) from the “RF OUT” on the unit to the “RF IN” on the cable box.
- 3 75 Ω coaxial cable from the “RF OUT” on the cable box to the “VHF/UHF RF IN” on the TV.
- 4 Audio/video cable (*included*) from the “DVD/VHS COMMON OUT” on the unit to the “AV IN” on the TV.
- 5 Audio/video cable from the “AV OUT” on the cable box to the “IN1” on the unit.
- 6 AC power supply cord (*included*) from the “AC IN~” on the unit to a household AC outlet.

Basic Connection

Connecting to a Television and a Satellite Receiver

- Consult your satellite service provider about the appropriate satellite receiver to use.
- Additional coaxial cable and audio/video (AV) cable are required.

Note: The terminals on the rear of your TV and satellite receiver may not appear as shown below. Please read terminal labels carefully to ensure correct connections.

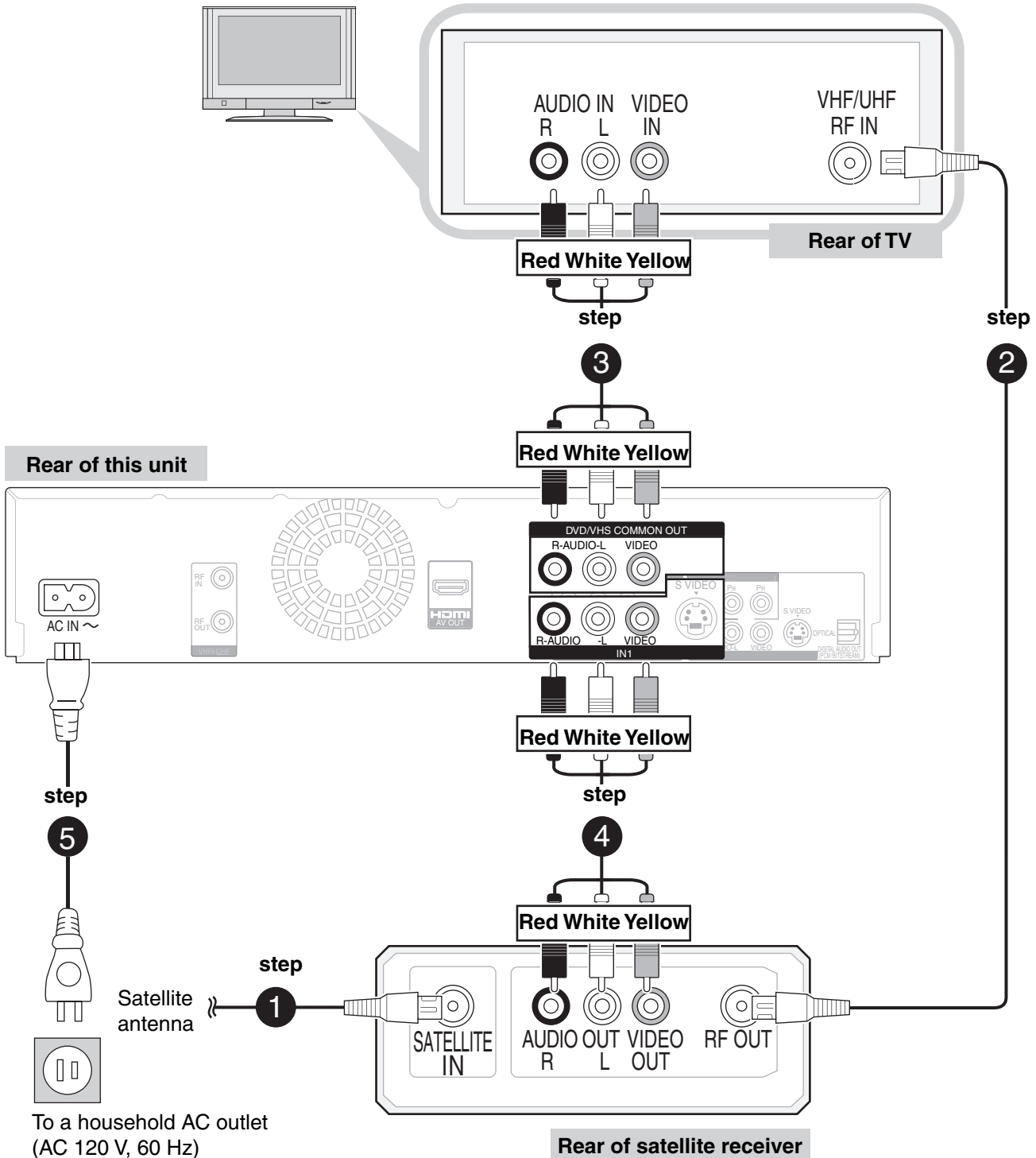

To a household AC outlet
(AC 120 V, 60 Hz)

- 1 75 Ω coaxial cable from the satellite antenna to the “**SATELLITE IN**” on the satellite receiver.
- 2 75 Ω coaxial cable (*included*) from the “**RF OUT**” on the satellite receiver to the “**VHF/UHF RF IN**” on the TV.
- 3 Audio/video cable (*included*) from the “**DVD/VHS COMMON OUT**” on the unit to the “**AV IN**” on the TV.
- 4 Audio/video cable from the “**AV OUT**” on the satellite receiver to the “**IN1**” on the unit.
- 5 AC power supply cord (*included*) from the “**AC IN ~**” on the unit to a household AC outlet.

- You can enjoy high-quality picture and audio by changing the audio/video (AV) cable connection between this unit and your TV as shown on pages 8 to 10 and by doing the following.

Connecting to a TV with an HDMI (High Definition Multimedia Interface) Cable

When connected to an HDMI compatible unit, an uncompressed digital audio and video signal is transmitted, enabling you to enjoy high quality digital video and audio with just one cable. When connecting to an HDMI-compatible HDTV (High Definition Television), the output can be switched to 1080p, 1080i or 720p HD video.

Regarding “HDAVI Control” function

When connecting with a Panasonic TV (VIERA) or a receiver equipped with “HDAVI Control” function, linked operations are possible. [→ 40, Linked Operations with the TV (VIERA Link™ “HDAVI Control™”)]

- Please use HIGH SPEED HDMI cables that have the HDMI logo (as shown on the cover).**

It is recommended that you use Panasonic’s HDMI cable.

Recommended part number: RP-CDHG10 (1.0 m/3.3 ft.), RP-CDHG15 (1.5 m/4.9 ft.), RP-CDHG20 (2.0 m/6.6 ft.), RP-CDHG30 (3.0 m/9.8 ft.), RP-CDHG50 (5.0 m/16.4 ft.), etc.

- Non-HDMI-compliant cables cannot be used.

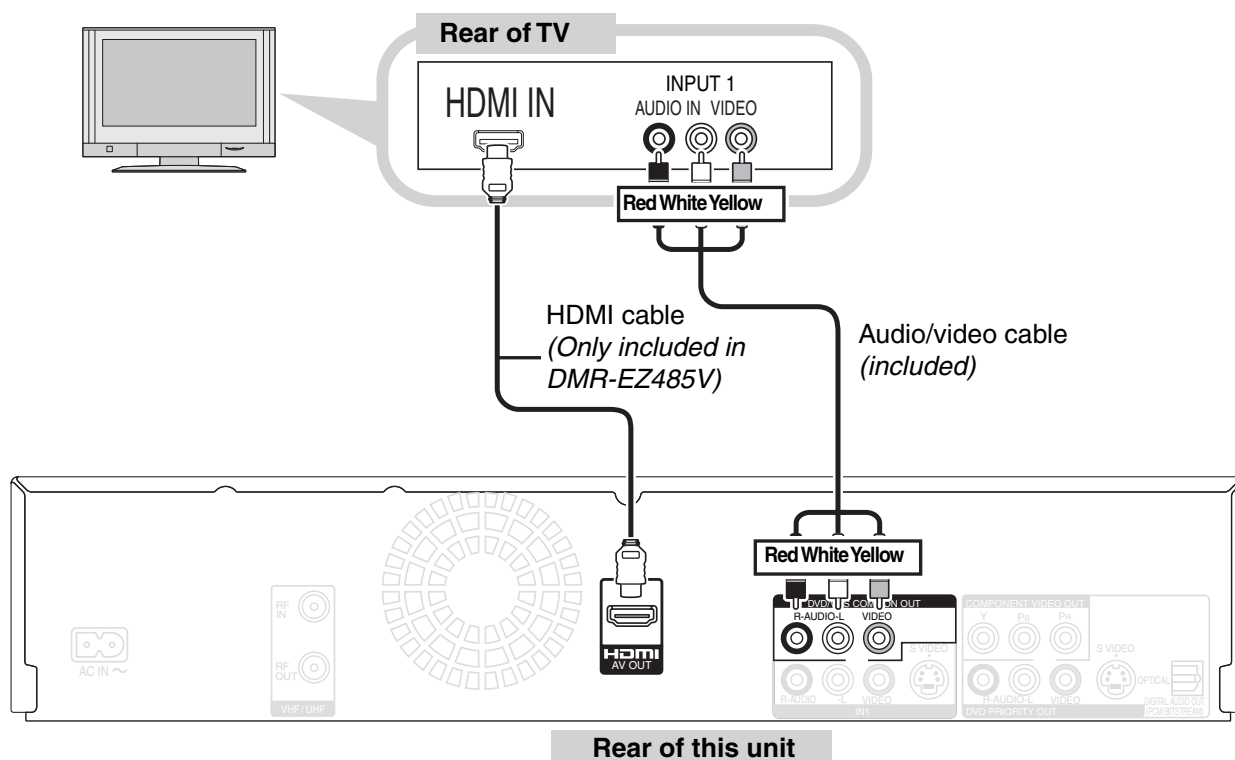

- Set “HDMI Priority” and “HDMI Audio Output” to “On” (→ 65, 66). (The default setting is “On”.)



Notes

- If connecting to equipment that is only compatible with 2 channels output, audio with 3 channels or more will be down-mixed (→ 91) and output as 2 channels (some discs cannot be down-mixed).
- For display units compatible with HDCP (High bandwidth Digital Content Protection) that are equipped with a digital DVI input terminal (PC monitors, etc.):
Depending on the unit, images may not display properly or at all when connecting with a DVI/HDMI switching cable (audio cannot be output).
- Usually you can watch video from HDMI input on TV. When you want to play back VHS while recording on DVD, switch to input 1 on TV.

Setting the Channels and Clock

Preparation:

- Turn on the TV and select the appropriate video input to suit the connections to the unit. (Example: AV input, CH3 or CH4)
- These are the first settings you make upon buying the unit. You don't need to make these settings again.



1 DVD/VHS POWER to turn the unit on.



- “HELLO” appears on the unit’s display.
- When this unit is connected to a Panasonic TV (VIERA) supporting HDAVI Control 3 via an HDMI cable (→ 11), it acquires the setting information from the TV. When the Quick Start Setting screen appears (→ 14, Step 1)

When this unit is connected to a TV via an HDMI cable, this step is not required.

2 TRACKING/VLOCK CH to select an RF output channel number.

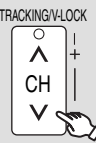

- Connection (without HDMI cable or Audio/Video cable): While viewing the unit’s front display, select “CH3” or “CH4”. If the selection is appropriate, then the step 3 screen will appear.
- Connection (with Audio/Video cable): While viewing the unit’s front display, select “OFF”.

3 Language:

▲, ▼ to select, then



- When the Quick Start Setting screen appears after this step (→ 14, Step 1)

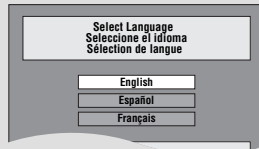

4 TV Aspect Ratio:

▲, ▼ to select “4:3 TV” or “16:9 Widescreen TV”, then



- When connecting to a 4:3 standard aspect TV: Select “4:3 TV”.
- When connecting to a 16:9 widescreen TV: Select “16:9 Widescreen TV”.

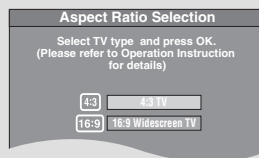

5 Quick Start Function:

▲, ▼ to select “On” or “Off”, then



then

then

then

then

then

then

then

then

then

then

then

then

then

then

then

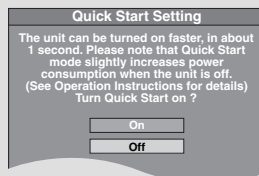

6 Automatic Clock and Channel Settings:

▲, ▼ to select “Yes” or “No”, then



- When connecting the cable from the wall (cable TV or antenna) to the unit’s RF IN: Select “Yes”. The unit then displays the source selection screen (→ 13).
- When not connecting the cable from the wall (cable TV or antenna) to the unit’s RF IN: Select “No”. The unit then displays “Set Clock Manually” screen (→ 13, Manual Clock Setting).

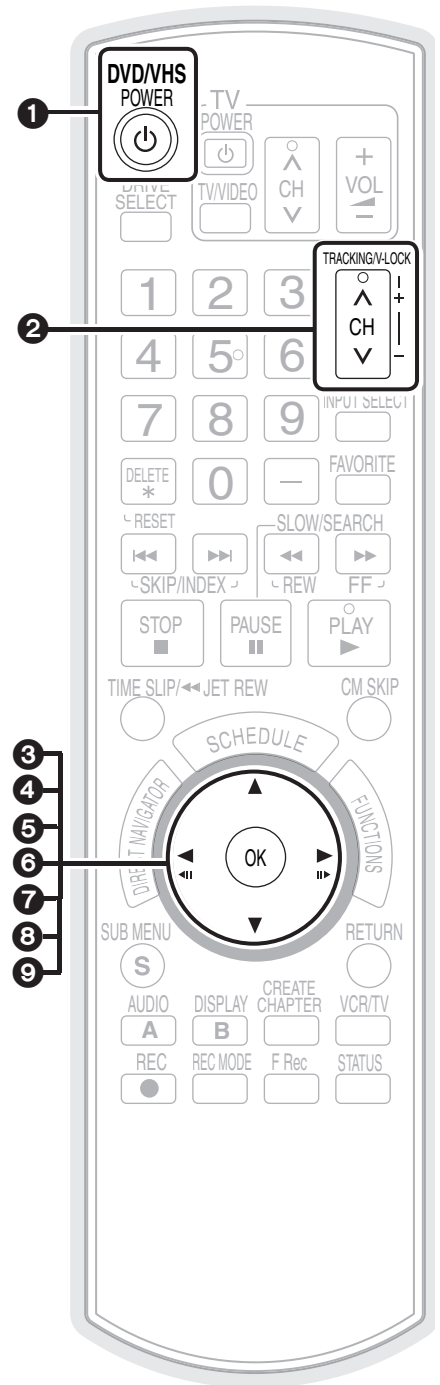
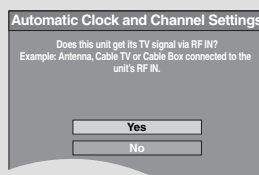



Tips

- “Quick Start” function (→ 58)
If you set Quick Start to on, you can start recording to DVD-RAM about 1 second after you press [DVD/VHS POWER] to turn the unit on and then sequentially press [REC].
The following happens when you have selected “On”.
– Power consumption in standby mode increases because power is supplied to the unit.

To return to the previous screen
Press [RETURN].

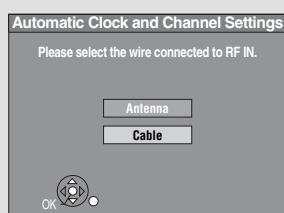
- 7** The types of transmission:
▲, ▼ to select “Antenna” or
“Cable”,
then 



- 8**  to start automatic channel/
clock setting.

- 9** Confirm the time, then 
– DST (Daylight Saving Time) shows the
summertime setting.
– Time Zone shows the time difference from
Greenwich Mean Time (GMT).



See “Notes”
(→ right)



Tips

- If the unit displays “**No channels were found.**”, turn off the unit and confirm the cable or antenna input is connected to the RF IN terminal. Restart the set up again (→ below).
- If “**Auto Clock Setting is incomplete.**” is displayed, press [OK] and set the clock manually (→ right).
- If the clock is not correct, set the clock with “Adjust Time Zone” (→ 58) or “Set Clock Manually” (→ 58).
- You can delete channels you don’t need after completing Auto Channel Setting (→ 55).

Restarting the Auto-Setup

(after relocation, for example)

1. When the unit is on and stopped, press and hold [CH v] and [CH ^] on the main unit at the same time for about 5 seconds. The unit turns off.
2. Press [DVD/VHS POWER] to turn the unit on. (The signal source and channel captions revert to their default values. All scheduled recordings are cleared.)

•To cancel in the middle

Press [RETURN].



Notes

- Conditions of the received channel may cause automatic channel/clock setting to take extra time.

Manual Clock Setting

Perform steps 1–6 on page 12.

- 7** ◀, ▶ to select the item you want
to change.

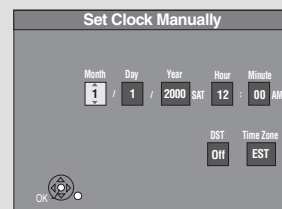

- 8** ▲, ▼ to change the setting.
– Repeat steps 7–8 to change other items.

- 9**  to confirm new date and
time.
– The clock starts.



Notes

- The automatic clock setting can take a few minutes.
- The channel and clock settings apply to both DVD and VHS drives.
- **Time Zone**

EST (Eastern Standard Time)	= GMT – 5
CST (Central Standard Time)	= GMT – 6
MST (Mountain Standard Time)	= GMT – 7
PST (Pacific Standard Time)	= GMT – 8
AST (Alaska Standard Time)	= GMT – 9
HST (Hawaii Standard Time)	= GMT – 10
For other areas: xx hr	

•DST (Daylight Saving Time)

If you select “On”, the clock is advanced one hour beginning at 2 a.m. on the second Sunday in March and ending at 2 a.m. on the first Sunday in November.
Set the DST period manually when it varies according to regions (→ below).

To set the DST period manually

1. Press [FUNCTIONS].
2. Press [▲, ▼] to select “Other Functions” then press [OK].
3. Press [▲, ▼] to select “Setup” then press [OK].
4. Press [▲, ▼] to select “Setup” then press [▶].
5. Press [▲, ▼] to select “Clock Settings” then press [OK].
6. Press [▲, ▼] to select “Set the time change dates for DST” then press [OK].
7. Press [▲, ▼ ◀, ▶] to set the “Month”, “Day”, “Hour”, and “Minute” then press [OK].

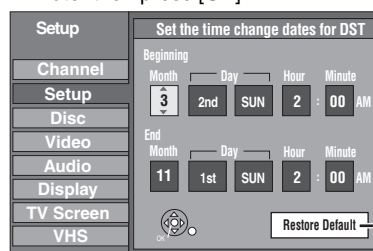

Reinitializes the
settings.

Setting the Channels and Clock

Acquiring the setting information from the TV (VIERA)

If this unit is connected to a Panasonic TV (VIERA) supporting HDAVI Control 3 via an HDMI cable, then the setting information on the TV is acquired by this unit when the unit is turned on for the first time. Please proceed to the following steps.

The following screen is displayed in the language set on the VIERA television.

–The language setting screen may be displayed depending on the usage environment. Press [▲, ▼] to select language, then press [OK].

- 1** Quick Start Function:
▲, ▼ to select “On” or “Off”,
then 

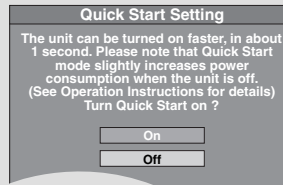

- 2** Channel information acquisition:
▲, ▼ to select “Set Channels via VIERA Link”, then 

- Acquires the following information from the TV (VIERA).
 - The types of transmission
 - Channel Map
 - Closed caption
- When the settings are complete, the time confirmation screen is displayed.

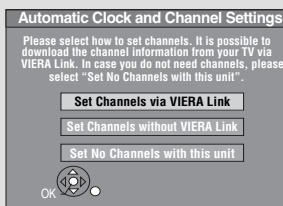

- 3** Confirm the time, then 
–For details of the time information (→ 13, Tips, Notes)



Tips

- If you do not want to acquire the setting information from the VIERA television

Press [▲, ▼] to select “Set Channels without VIERA Link” or “Set No Channels with this unit”, then press [OK] in step 2.

–When connecting the cable from the wall (cable TV or antenna) to the unit's RF IN:

Select “Set Channels without VIERA Link”.

The unit then displays the source selection screen (→ 13, left column, step 7).

–When not connecting the cable from the wall (cable TV or antenna) to the unit's RF IN:

Select “Set No Channels with this unit”.

The unit then displays “Set Clock Manually” screen (→ 13, Manual Clock Setting).

- If “Automatic Clock and Channel Settings” screen on page 12 is displayed, the channel information could not be acquired from the TV (VIERA). Please go to step 6 on page 12.

To return to the previous screen
Press [RETURN].

Notes

- Acquisition of the setting information is not supported by all Panasonic TVs (VIERA).
- The acquisition may take some time depending on the VIERA setting information.

Media Handling

Inserting Discs

OPEN/CLOSE



to open the tray.

- Insert a disc.
- Press [**▲** OPEN/CLOSE] again to close the tray.

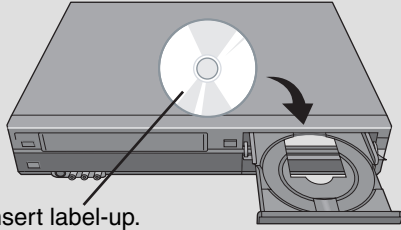

Notes

- When using 8 cm (3") DVD-RAM or 8 cm (3") DVD-R, remove the disc from the cartridge.
- It is not possible to record or play continuously from one side of a double sided disc to the other. You will need to eject the disc and turn it over.
- The unit may take some time to respond to [**▲** OPEN/CLOSE].

Inserting a Video Cassette

Insert a cassette.

- The unit turns on automatically.

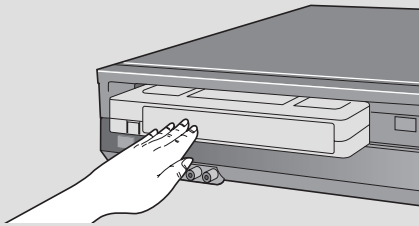

To eject:

From the main unit:

EJECT



- The unit turns on automatically.

or

From the remote control



to select the VHS drive.



Press and hold for 3 or more seconds.

Video Cassette Information

- Break off the video cassette's tab to prevent accidental erasure. Cover the hole with a double layer of adhesive tape when you want to use the video cassette for recording again.
- You can use video cassettes with the VHS and S-VHS marks, but the unit is unable to make full use of the characteristics of S-VHS video cassettes.

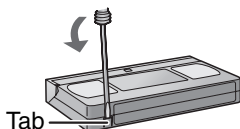

Inserting USB memory

You can insert the USB memory directly into the USB port.

Preparation

Before inserting any USB memory to this unit, ensure that the data stored in it has been backed up.

Opening the front panel

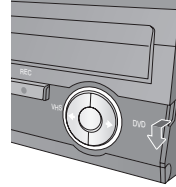

Pull down.

Inserting the USB memory

Check the orientation of the USB connector and insert it straight in.

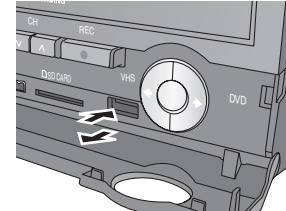

Removing the USB memory

Complete all USB memory-related operations and pull the USB memory straight out.

When "uSb"(USB) is flashing on the unit's display, do not turn off the unit or remove the USB memory.



Notes

- There are few USB memory devices that cannot be connected.
- Some USB devices inserted into this unit may cause this unit to stop operating. Such USB devices cannot be used on this unit.
- Confirm that "uSb"(USB) appears on the unit's display when a compatible USB memory is inserted while stopped.
- If a USB memory being accessed is pulled out, then the data may be damaged.

Inserting an SD Card

Opening the front panel

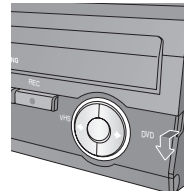

Pull down.

Inserting the card

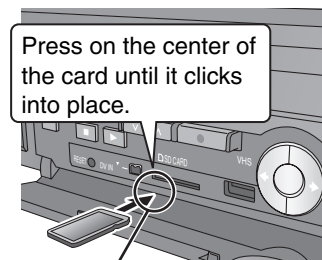

Insert the card label up with the cut-off corner on the right.

If you are using a miniSD card/microSD card, insert it into the miniSD card adaptor that comes with the card. Insert and remove this adaptor from the unit.

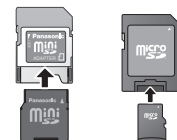

Removing the card

Press on the center of the card and pull it straight out.



Notes

When "SD" is flashing or when copying a picture or displaying the Album in the SD card, do not turn off the unit or remove the SD card. Such action may result in malfunction or loss of the card's contents.

Watching Television

This DVD recorder has a tuner which allows it to directly receive and record analog and terrestrial digital channels. High Definition (HD) programming is “down-converted” and recorded in Standard Definition (SD).

Preparation:

Turn on the television and select the appropriate video input to suit the connections to this unit (Example: AV input, CH3 or CH4).

- 1**  **to turn the unit on.**
– “HELLO” appears on the unit’s display.

If you connected this unit and a TV without an audio/video cable or an HDMI Cable

- 2**  **to watch video from this unit.**
– The TV indicator on this unit’s display does not light up.
– By pressing [VCR/TV] again, the TV indicator on this unit’s display will light up, and you can watch TV directly without passing the signal through this unit (TV mode).

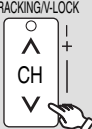
- 3**  **to select desired channel.**

You can also select channels with the numbered buttons.

• To directly enter channels for analog and digital broadcasts:

Antenna Mode:	Cable TV Mode:
e.g., “3”: [0] → [3] → [OK]	e.g., “5”: [0] → [0] → [5] → [OK]
“13”: [1] → [3] → [OK]	“15”: [0] → [1] → [5] → [OK]

• To enter the sub channel number for a digital broadcast:

Antenna Mode:	Cable TV Mode:
e.g., “3-1”: [3] → [-] → [1] → [OK]	e.g., “1-1”: [1] → [-] → [1] → [OK]
“13-1”: [1] → [3] → [1] → [OK]	“15-1”: [1] → [5] → [-] → [1] → [OK]

The hyphen appears automatically on “Antenna Mode” if you enter two numbers.

To set Favorite Channels

You can define a Favorite list containing your favorite channels only. (Up to 30 channels)

- After selecting the desired channel to set
Press [SUB MENU].
- Press [▲, ▼] to select “Set Favorite”, then press [OK].
- Press [▲, ▼] to select the position on the list, then press [OK].
– Press [◀, ▶] to change between pages.
– You can also select a list number (1-9 and 0) with the numbered buttons.

To delete the favorite channels registered

Press [▲, ▼] to select the channel on the list, then press [OK].

To select a channel from the Favorite list

- Press [FAVORITE].
- Press [▲, ▼] to select a channel, then press [OK].
– Press [◀, ▶] to change between pages.
– You can also select a channel with the numbered buttons.

Notes

- It is possible to select a channel from the Favorite list for instant or scheduled recording. (→ 18, 19)
- If you set “Surf Mode” to “Favorite” (→ 56), then only the Favorite channels can be selected using [CH ▲, ▼].
- You can register channels in the Favorite list from Channel Setting list. (→ 55, Setting favorite channels)



Notes

- This unit can receive most Basic Cable television channels. It cannot receive Premium Services that require additional fees or a separate decoder.
- This unit can receive music channels from digital broadcasters, but you cannot record them. Data broadcasts are not for viewing or recording.
- Multi-channel surround broadcast is output in stereo (on 2 channels).

Tips

- To zoom in on video
 - Press [SUB MENU].
 - Press [▲, ▼] to select “Zoom In”, then press [OK].

Playback

Preparation:

Turn on the television and select the appropriate video input to suit the connections to this unit (Example: AV input, CH3 or CH4).

Playing a Disc

Refer to “Advanced Disc Playback” (→ 30–31) for detailed information on playback of discs.

RAM -R -R DL -RW(V) +R +R DL +RW DVD-V -RW(VR) CD

1  **to turn the unit on.**
– “HELLO” appears on the unit’s display.

2  **to select the DVD drive.**
–The DVD indicator lights up on the unit.

3  **to open the tray** (Button located on front of the unit).
–Insert a disc.

4  **–The tray closes and play begins.**

Stopping Play

Press [■ STOP].

- The stopped position is memorized. (Resume play function)
- The stopped position is cleared when you press [■ STOP] two or more times, or press [▲ OPEN/CLOSE].

Pausing Play

Press [▢ PAUSE].

- Press again to restart play.

Playing a Video Cassette

Refer to “Advanced Video Cassette Playback” (→ 37–38) for detailed information on playback of video cassette.

VHS

1  **to turn the unit on.**
– “HELLO” appears on the unit’s display.

2  **to select the VHS drive.**
– The VHS indicator lights up on the unit.

3 **Insert a cassette.**
– Play starts automatically if you insert a cassette with the accidental erasure tab removed.

4  **–The tray closes and play begins.**

Stopping Play

Press [■ STOP].

Pausing Play

Press [▢ PAUSE].

- Press again to restart play.

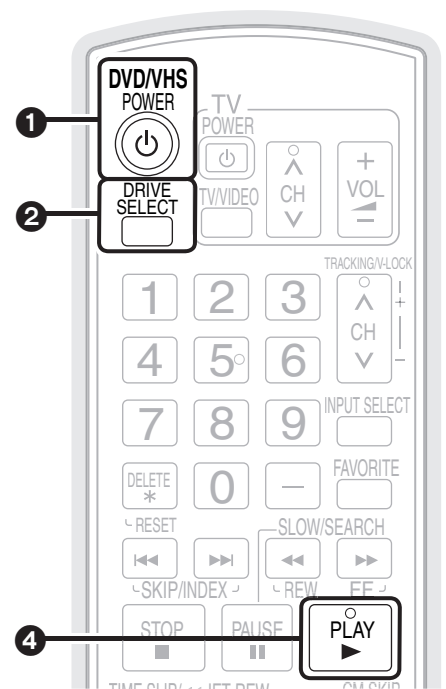

Tips

Icons such as “**RAM**” indicate usable discs. Refer to pages 74 and 75.

Notes

DVD

- **RAM -R -R DL -RW(V) +R +R DL +RW -RW(VR)**
Playback starts from the most recent recording.
- **DVD-V CD**
Playback starts from the beginning of the disc.
- **DivX**
DivX Menu screen appears (→ 36).
- The unit takes some time to read the disc before play starts.
- Discs continue to rotate while menus are displayed. Press [■ STOP] when you finish to preserve the unit’s motor and your television screen.

VHS

- Tapes are automatically rewound once they reach the end (except during scheduled recording, fast forwarding, etc.).
- Viewing pause or using slow playback in VP mode may result in a distorted image.
- You may have to adjust the tracking for tapes recorded on other VCRs (→ 38). In some cases, the picture quality may still be inferior; this is due to format constraints.

Recording Television Programs

Refer to “Important Notes for Recording” (→ 23) and “Advanced Recording” (→ 24–26) for detailed information on recording.

RAM -R -R DL -RW(V) +R +R DL +RW VHS

Digital broadcasts cannot be recorded to video tape.

Preparation:

- Turn on the television and select the appropriate video input to suit the connections to this unit (Example: AV input, CH3 or CH4).
- **RAM** If the disc is protected, release protection (→ 52).
- **VHS** Ensure accidental erasure tab is intact.

1  **to turn the unit on.**
– “HELLO” appears on the unit’s display.

2  **to select the drive (DVD or VHS).**

3 **Insert a disc or VHS cassette.**
– Insert a disc or VHS cassette with enough remaining blank space (→ 15).

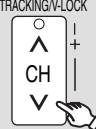
4  **to select desired channel.**

Antenna Mode:
e.g. channel 4-2

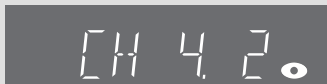



Cable TV Mode:
e.g. channel 102-45

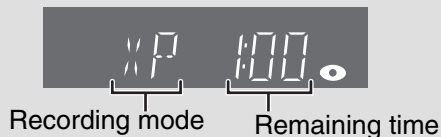

- To select with the numbered buttons (→ 16).
- When no channel setting is performed on the unit and broadcast is recorded directly from the cable box or satellite receiver, select a channel on the connected equipment and press [INPUT SELECT] to select “IN1” or “IN2”.

5  **to select the recording mode.**
– Recording mode should be determined by program length and available time on selected media (→ 24)



6  **to start recording.**

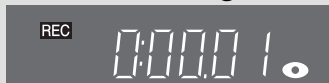

Pausing Recording

Press [|| PAUSE].

– Press again to restart recording.

Stopping Recording

Press [■ STOP].

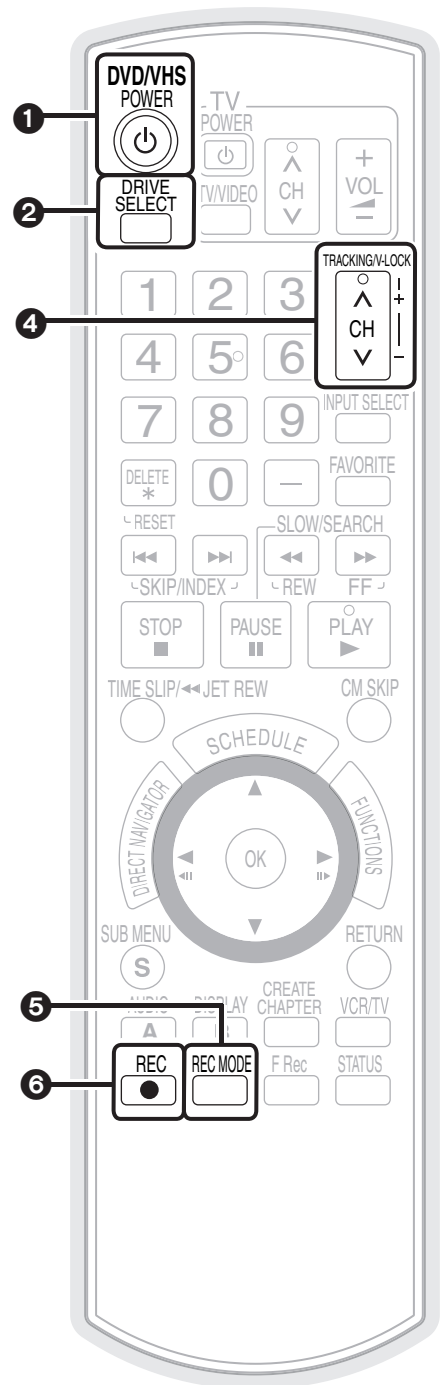

Tips

Icons such as “**RAM**” indicate usable discs. Refer to pages 74 and 75.

Notes

- **-R -R DL -RW(V) +R +R DL +RW**
It takes about 30 seconds for the unit to complete recording management information after recording finishes.
- You cannot change the channel or recording mode during recording.
- Simultaneous recording to both DVD and VHS is not possible.

Scheduled Recording

Refer to “Advanced Scheduled Recording” (→ 27) for detailed information on scheduled recording.

RAM -R -R DL -RW(V) +R +R DL +RW VHS

Digital broadcasts cannot be recorded to video tape.

Preparation:

- Turn on the television and select the appropriate video input to suit the connections to this unit (Example: AV input, CH3 or CH4).
- **RAM** If the disc is protected, release protection (→ 52).
- **VHS** Ensure accidental erasure tab is intact (→ 15).
- Insert a disc or VHS cassette with enough remaining blank space.
- Confirm that the clock on the unit's display is set to the correct time.
- If connected via a cable box or satellite receiver, set channel on that equipment before scheduled recording starts.

1

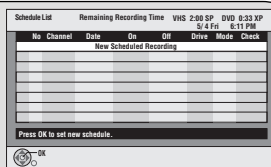

2

▲, ▼ to select “New Scheduled Recording”, then

3

◀, ▶ to move through the items and ▲, ▼ to set the items.

Channel/Input – TV Station/External Input

To select a favorite channel
(To set Favorite Channels, see page 16)

1. Press [SUB MENU].
2. Press [▲, ▼] to select “Change Surf Mode”, then press [OK].
3. Press [▲, ▼] to select “Favorite”, then press [OK].

Date/Frequency – You can set a daily or weekly program.

On (start time) / Off (end time)

– Hold button to change in 30-minute increments.

Drive – DVD or VHS

Mode – Recording mode, see page 24

Name (only for discs)

– Press [OK], see page 42.

Channel, Caption
Preview of selected channel

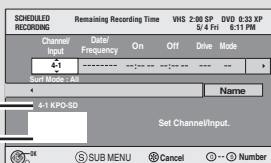

To delete all items

1. Press [SUB MENU].
2. Press [▲, ▼] to select “Delete”, then press [OK].

4

– Repeat steps 2–4 to program other recordings.

5



when you have finished programming.

- “Ⓞ” lights on the unit's display.
- **Scheduled recording can be started only when the unit is turned off.**



Tips

Icons such as “**RAM**” indicate usable discs. Refer to pages 74 and 75.



Notes

- **To prevent recording errors:**
Set a scheduled recording period slightly longer than the actual program (to make sure the program is recorded in full).
- Be sure to perform step 5 before the scheduled recording time. When the unit is turned off, “Ⓞ” lights on the unit's display to indicate scheduled recording standby has been activated.
- “Ⓞ” flashes when the unit cannot go to scheduled recording standby. (e.g., a recordable disc is not in the disc tray) It does not flash if Quick Start is off.
- When scheduled recordings are set to start one immediately after another, the unit cannot record the beginning of the later program.
- If two scheduled recording times overlap, the recording that started first always has priority. The second recording will start only after the first recording has finished.
- Scheduled recording cannot be executed on both DVD and VHS drives at the same time.
- When starting time for a scheduled recording is the same, the recording that you programmed later has priority.
- Depending on the Daylight Savings Time (DST) settings for this unit, scheduled recordings may be affected when the seasons change.

Copying Recordings

Copying Recordings (VHS → DVD)

When copying begins, the VHS tape is played back starting at the tape's current position, and recorded to the disc.

VHS → RAM -R -R DL -RW(V) +R +R DL +RW

Preparation:

- Turn on the television and select the appropriate video input to suit the connections to this unit (Example: AV input, CH3 or CH4).
- **RAM** If the disc is protected, release protection (→ 52).
- Insert a disc with enough space for recording.
- Set the DVD recording mode (determined by program length and available time on selected media → 24).
- Insert the VHS tape containing the program to be copied. Stop the tape at the point where you want to start copying from.

On the main unit

- 1** While both DVD and VHS are stopped
Press and hold for about 3 seconds.

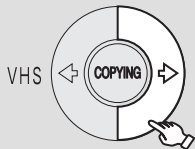

-R -R DL -RW(V) +R +R DL

- 2a** **to copy and automatically finalize when done** (see page 54 for more information on finalizing).
 – If you press [■ STOP], you can cancel copying.

– or –

- 2b** **to copy without finalizing.**
 – If you press [■ STOP], you can cancel copying.

- COPY will appear in the unit's display when the copying process begins.
- Copying is automatically stopped when the tape reaches its end or the disc becomes full.

Tips

• Additional navigation

You can begin the same kind of copy by using COPY Navigator. Use the operations listed below instead of step 1 shown above.

1. Press [FUNCTIONS].
2. Press [▲, ▼] to select "Copy" then press [OK].
COPY Navigator screen appears.
3. Press [▲, ▼] to select "VHS to DVD" then press [OK].

• Segmenting a recording to be copied

When copying from VHS to DVD, recordings on the DVD are divided according to index signals detected on the tape.

- Recordings that are too short may not be divided correctly.
- The time it takes to record may become longer than the original recording depending on the number of index signals.

• To cancel copying in the middle

- Press [■ STOP].
 – You can also press and hold [RETURN] for about 3 or more seconds to cancel copying in the middle.

However, you cannot stop finalizing after it has started.

• When copying multilingual broadcast program

-R -R DL -RW(V) +R +R DL +RW

Before starting copy, try playing the VHS and pressing [AUDIO], and then select audio track that you want to copy. Audio can also be switched during copy.

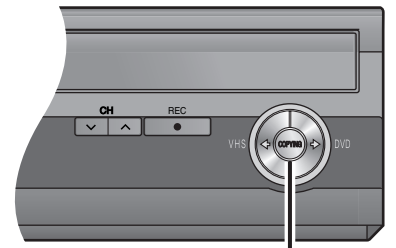

COPYING indicator

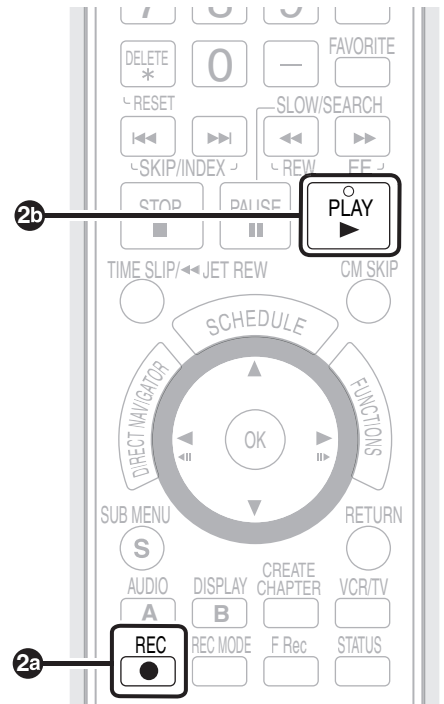

Tips

- Icons such as "**RAM**" indicate usable discs. Refer to pages 74 and 75.

Notes

- If copying doesn't complete due to shortage of remaining time, disc space, or other reasons, finalizing won't start.
- When copying doesn't start, the "COPYING" indicator on the main unit blinks for about 7 seconds. Check if the unit is properly prepared.
- If a part of a tape recorded in VP mode is copied to disc, noise may appear at the beginning of the copied part.

Copying Recordings (DVD → VHS)

All recordings on the disc are automatically copied onto the tape.
 If you start copying when the resume function is activated, the DVD is copied from the beginning of the recording where you previously stopped.
 To copy a whole disc, press [■ STOP] to deactivate it before copying (→ 17).

RAM -R -R DL -RW(V) -RW(VR) +R +R DL +RW → VHS

Finalized discs or DVD-Video cannot be copied on this unit.

Preparation:

- Turn on the television and select the appropriate video input to suit the connections to this unit (Example: AV input, CH3 or CH4).
- **VHS** Ensure accidental erasure tab is intact (→ 15).
- Insert a VHS tape with enough space for recording. Stop the tape at the point where you want to start copying to.
- Select the VHS recording mode (→ 24).
- Set "HDMI Output Display Aspect" to "Full" (→ 65).
 (The default setting is "Full".)
- Insert the disc containing the recording to be copied.

On the main unit

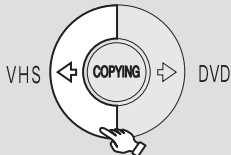

Press and hold for about 3 seconds.

- COPY will appear in the unit's display when the copying process begins.
- Copying automatically stops when playback of the disc finishes or the tape reaches its end.



Tips

• Additional navigation

You can begin the same kind of copy by using COPY Navigator. Use the operations listed below instead of step shown above.

1. Press [FUNCTIONS].
2. Press [▲, ▼] to select "Copy" then press [OK].
 COPY Navigator screen appears.
3. Press [▲, ▼] to select "DVD to VHS" then press [OK].

• When you start copying from the selected recording

1. Press [DRIVE SELECT] to select the DVD drive.
2. Press [DIRECT NAVIGATOR].
RAM When the Album View screen is displayed, press [A] to switch to the Recordings screen.
3. Press [▲, ▼, ◀, ▶] to select the recording you want to start, then press [OK].
4. Go to step "Copying Recordings (DVD → VHS)" shown above.

- Index signals are automatically recorded on the tape according to the division of recordings on the DVD [→ 37, VHS Index Search System (VISS)].

• To cancel copying in the middle

- Press [■ STOP].
- You can also press and hold [RETURN] for about 3 or more seconds to cancel copying in the middle.

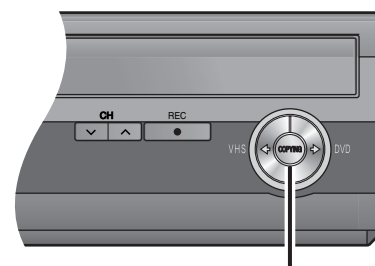

COPYING indicator



Tips

Icons such as "**RAM**" indicate usable discs. Refer to pages 74 and 75.



Notes

- When copying doesn't start, the "COPYING" indicator on the main unit blinks for about 7 seconds. Check if the unit is properly prepared.

Deleting Recordings

Important: Once deleted, contents cannot be recovered.

Preparation:

- Turn on the television and select the appropriate video input to suit the connections to this unit (Example: AV input, CH3 or CH4).
- Insert the disc containing the recording to be deleted.
- **RAM** If the disc is protected, release protection (→ 52).

Delete Navigator

RAM -R -R DL -RW(V) +R +R DL +RW

1  to select the DVD drive.

2 With the unit stopped

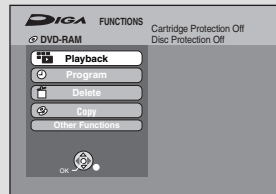

3 ▲, ▼ to select “Delete” then 

RAM When the Album View screen is displayed, press **A** to switch to the Recordings screen.

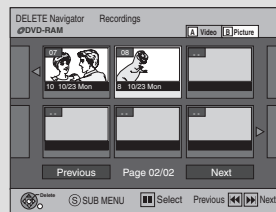

4 ▲, ▼, ◀, ▶ to select the recording, then 

5 ◀ to select “Delete”, then 



Tips

To return to the previous screen
Press [RETURN].

To view other pages
Press [▲, ▼, ◀, ▶] to select “Previous” or “Next”, then press [OK].
• You can also press [◀◀, ▶▶] to view other pages.

Multiple editing
Select with [▲, ▼, ◀, ▶], then press [|| PAUSE]. (Repeat.)
• A checkmark appears. Press [|| PAUSE] again to cancel.

Deleting Recordings During Playback

RAM -R -R DL -RW(V) +R +R DL +RW

1 During playback



2 ◀ to select “Delete” then 

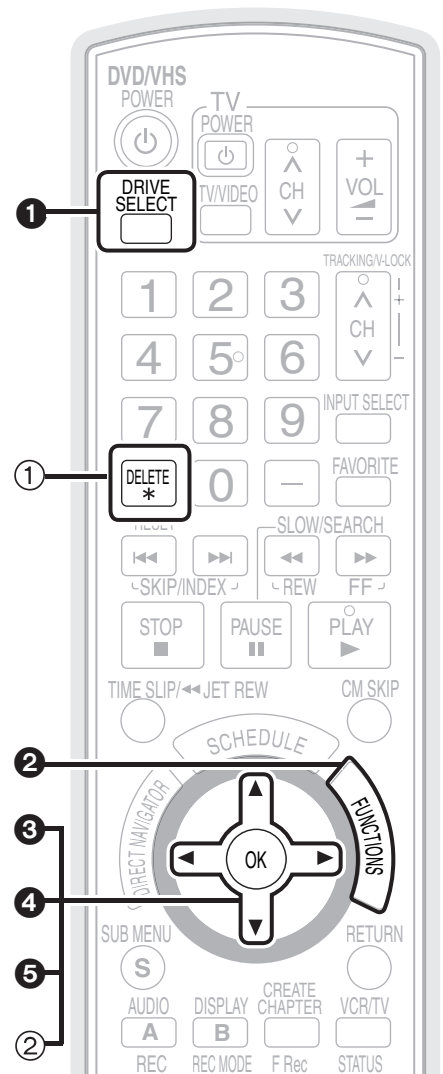

Notes

- You cannot delete while recording or copying.
- **+R +R DL +RW** Even if you have set protection on other equipment, such recordings are deleted.



Tips

- Icons such as “**RAM**” indicate usable discs. Refer to pages 74 and 75.
- **RAM** Deleting an item increases the available disc space, for the amount of space taken up by the item being deleted.
- **-R -R DL +R +R DL** Available disc space does not increase after deletion.
- **-RW(V) +RW** Available disc space increases when you delete the last recording (the recording space may increase slightly when other recordings are deleted).

Important Notes for Recording

Recording of multilingual broadcasts

Analog broadcasts:

RAM **VHS**

Both Main and SAP audio are recorded. You can change the audio during playback (→ 31, 38 Changing Audio during Playback).

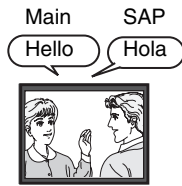

- If you record from external equipment (→ 28) Select both "Main" and "SAP" on the external equipment.

-R **-R DL** **-RW(V)** **+R** **+R DL** **+RW**

Select the Main or SAP audio before recording.

[→ 61, Multi-channel TV Sound (Analog)]

The selected audio only is recorded.

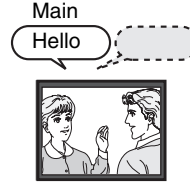

- If you record from external equipment (→ 28) Select "Main" or "SAP" on the external equipment.

Digital broadcasts:

Press [AUDIO] to switch audio (→ 25).

The selected audio only is recorded.

VHS Digital broadcasts cannot be recorded to video tape.

Recording of Widescreen broadcasts

RAM

Recorded in 16:9 aspect (Widescreen)



- If you have a regular 4:3 aspect TV and you receive 16:9 aspect images from a digital broadcast, they will appear in letterbox format (→ 91, Letterbox).

VHS Digital broadcasts cannot be recorded to video tape.

-R **-R DL** **-RW(V)** **+R** **+R DL** **+RW**

Recorded in 4:3 aspect



Copy-once Recording

- It is not possible to record digital broadcasts that allow "One time only recording" onto DVD-R, DVD-R DL, DVD-RW, +R, +R DL, +RW or 8 cm (3") DVD-RAM discs. Use the CPRM (→ 91) compatible DVD-RAM.

RAM CPRM compatible discs only

- When purchasing discs, check that they support CPRM.

12 cm (5")



Yes

-R **-R DL** **-RW(V)** **+R** **+R DL** **+RW**



No

Playing the disc on other DVD players

-R **-R DL** **-RW(V)** **+R** **+R DL**

The disc must be finalized after recording (→ 54).

All DVD-R, etc. discs recorded on this unit must be finalized before they can be played on other DVD players. Once finalized, DVD-R, etc. become "read-only" and can no longer be used for recording. DVD-RW can be reused after finalizing.

Whether DL discs recorded on this unit can be played on other DVD players will depend entirely on the capabilities of that player. 100% compatibility is not guaranteed.



Record to DVD-R, etc.



Finalize



Play on other DVD equipment

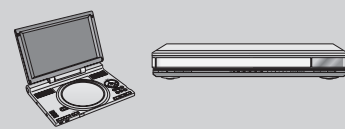

+RW We recommend you create the menu before playing a +RW disc on other equipment (→ 54).

RAM DVD-RAM can be played back on Panasonic DVD recorders and DVD-RAM compatible DVD players.

Recording to DVD-R DL and +R DL

DVD-R DL and +R DL discs have two layers of recording surface on one side.

- **-R DL** Recordings are divided when recording changes from the first layer to the second. Some images and audio may be lost at this point.

- **+R DL** Recordings continue through the layer change with only a slight pause similar to what you will see with commercial DVD-Video discs. Any recording exceeding 8 hours in length is automatically divided whether a layer change is required or not.

DVD-R DL

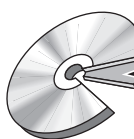

(Disc inner side)

The second layer

The available space

Recording 3

Layer change: Recording divided, some images and audio lost.

The first layer

Recording 1

Recording 2

(Disc outer side)

Recording/Playback direction

Advanced Recording

DVD Recording Modes and Estimated Disc Recording Time

Recording Mode	DVD-RAM		DVD-R, DVD-RW, +R, +RW (4.7 GB)	DVD-R DL ^{*3} , +R DL ^{*3} (8.5 GB)
	Single-sided (4.7 GB)	Double-sided ^{*1} (9.4 GB)		
XP (High quality)	1 hour	2 hours	1 hour	1 hour 45 minutes
SP (Standard play)	2 hours	4 hours	2 hours	3 hours 35 minutes
LP (Long play)	4 hours	8 hours	4 hours	7 hours 10 minutes
EP (Extra long play)	8 (6 ^{*2}) hours	16 (12 ^{*2}) hours	8 (6 ^{*2}) hours	14 hours 20 minutes (10 hours 45 minutes ^{*2})
FR (Flexible Recording)	8 hours maximum	8 hours maximum for one side	8 hours maximum	14 hours 20 minutes maximum

*1 It is not possible to record or play continuously from one side of a double sided disc to the other.

*2 When "Recording Time in EP Mode" has been set to "EP-Extended Play (6H)" in the Setup menu (→ 60).

The sound quality is better when using "EP-Extended Play (6H)" than when using "EP-Extended Play (8H)".

*3 Refer to "Recording to DVD-R DL and +R DL" (→ 23).

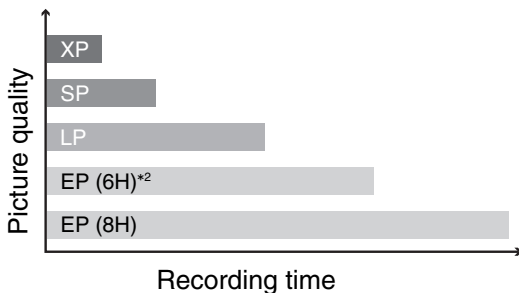

Notes

- This unit uses variable bit rate (VBR) recording which varies the amount of data recorded to suit the images, so actual recording times and remaining recording times shown by the unit will be different. (-R DL +R DL The difference will be especially noticeable.) Use a disc with plenty of remaining time to be sure.
- When recording to DVD-RAM using EP (8H) mode, play may not be possible on DVD players, even if they are compatible with DVD-RAM. In this case use EP (6H) mode.

FR (Flexible recording mode)

Using "Flexible Recording" is convenient in these kinds of situations:

- When the amount of free space on the disc makes selecting an appropriate recording mode difficult
- When you want to record a long program with the best picture quality possible
e.g., Recording a 90 minutes program to 4.7 GB DVD-RAM disc:
- If you select XP mode, the program will not fit on one disc.



A second disc is necessary for 30 minutes of the program.

- If you select SP mode, the program will fit on one disc.



However there will be 30 minutes remaining disc space.

- If you select "Flexible Recording" the program will fit on one disc perfectly.



You can set FR mode when programming scheduled recordings and flexible recording (→ 26).



Tips

Maximum number of recordings recorded to a disc

RAM	-R	-R DL	-RW(V)	99 recordings on a disc
+R	+R DL	+RW		49 recordings on a disc

VHS Recording Modes and Estimated Recording Time

Digital broadcasts cannot be recorded directly to video tape. To record digital broadcasts, use an external connection to a set-top-box or other equipment (→ 28).

Recording Mode	Durations
SP	You can record the length shown on the tape.
EP	3 times the length of SP mode.
VP	5 times the length of SP mode.
AUTO	Automatically switches the recording mode to EP mode during a scheduled recording if there is not enough tape left to record the program in SP mode.



Notes

- A tape recorded in VP mode by the unit cannot be played back by other VCRs.
- It takes more time for automatic tracking to work when playing tapes recorded with VP mode, and it may not work at all with some tapes. Do tracking manually if this is the case (→ 38).



Tips

- If the image quality is important to you or if you wish to store the tape for a long period, select "SP".
- The unit can play tapes recorded in LP mode on other equipment.

AUTO Mode

Scheduled recording

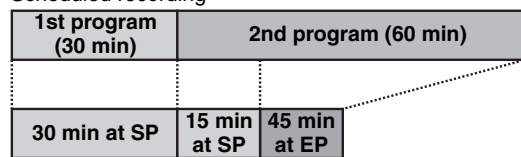

Video tape (e.g.: 60-minute cassette)

- It is not possible to automatically activate VP mode.
- The tape length must be set correctly (→ 66, Select Tape Length).
- Picture distortion may occur when SP switches to EP.
- AUTO Mode may not function on some tapes.

When the format confirmation screen is displayed

Important:

Formatting permanently deletes all disc contents (including computer data), regardless of protection status of disc.

RAM -RW(V) +RW

The following screen may appear when inserting a new disc, etc.

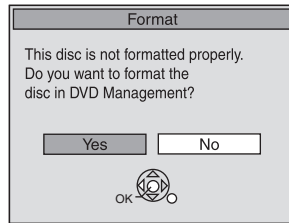

Only format the disc if you intend to use it for recording.

Do not format if you intend to view pre-recorded material from the disc.

◀ to select "Yes", then



Tips

- Refer to "Formatting Discs or Cards" (→ 53) for more details on formatting.
- It will take several minutes to format the disc. (DVD-RAM may take up to a maximum of 70 minutes.)

When removing a recorded disc

-R -R DL -RW(V) +R +R DL

After recording, if you press [▲ OPEN/CLOSE] to eject the disc, the following screen may appear.

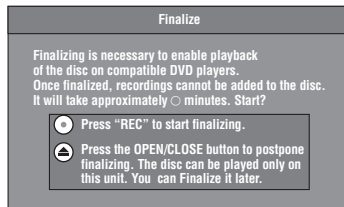

to start finalizing.

or

to eject the disc without finalizing.



Notes

You cannot stop finalizing once you have started it.



Tips

- If you want to provide the disc with a name or set play menu select, select "Disc Name" (→ 52) or "Playback will start with:" (→ 54) in "DVD Management" before finalizing.
- Refer to "Finalizing" (→ 54) for more details about finalizing.
- It will take a few minutes to finalize the disc. (some discs may take up to a maximum of 60 minutes.)

Selecting Audio Channels to record

Refer to "Recording of multilingual broadcasts" for detailed information (→ 23).

When receiving an analog broadcast

-R -R DL -RW(V) +R +R DL +RW

Select the audio (Main or SAP) in "Multi-channel TV Sound (Analog)" in the Setup menu (→ 61).

RAM

to select the audio.
Stereo → SAP → Mono

Changing during recording changes the recorded sound.

Stereo:	Main audio (stereo) If the broadcast is "Mono+SAP", audio will be monaural even if you select Stereo mode.
SAP:	Secondary audio program (SAP). When you record SAP, main audio is also recorded. In such cases, recorded SAP and main audio become monaural.
Mono:	Main audio (monaural). Select "Mono" if reception is poor during a stereo broadcast.

e.g., "Stereo" is selected
"(((" appears when the unit is receiving the audio type you selected.

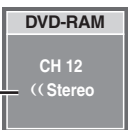

Notes

You cannot change the audio type in the following case.

- While a disc other than DVD-RAM is inserted when selecting an analog broadcast

When receiving a digital broadcast

to select the audio.

e.g., "English" is selected

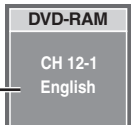

Notes

- You cannot change the audio type in the following case.
 - When there is no choice of languages in a digital broadcast
- Before scheduled recording of a digital broadcast with more than one language channel, set the language in "Multi-channel TV Sound (Digital)" in the Setup menu (→ 61).
- When broadcast offers no language data, such displays as "Audio 1 of 3" may appear. In such cases, recording may not be possible in the language selected through the "Multi-channel TV Sound (Digital)" in the Setup menu (→ 61).

Advanced Recording

Specifying the Recording Time

RAM -R -R DL -RW(V) +R +R DL +RW VHS

Digital broadcasts cannot be recorded to video tape.

This function allows specifying the length of recording time up to 4 hours.

During recording



repeatedly until the desired time is reached.

– The recording time and the unit's display changes as follows:

Counter (Cancel) → OFF 0:30 → OFF 1:00

OFF 4:00

OFF 1:30

← OFF 3:00 ← OFF 2:00 ←



Notes

- This function does not work during scheduled recording or Flexible Recording.
- Recording stops and the set time is cleared if you press [■ STOP].
- The unit turns off automatically when the time to stop recording is reached as long as you do not operate the unit.

Flexible Recording

RAM -R -R DL -RW(V) +R +R DL +RW

The unit sets the best possible picture quality that fits the recording within the remaining disc space.

The recording mode becomes FR mode. Refer to "FR (Flexible Recording)" (→ 24).

1

With the unit stopped

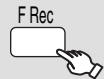

2

◀, ▶ to select "Hour" and "Min." and ▲, ▼ to set the recording time.

3

When you want to start recording ▲, ▼, ▶, ▶ to select "Start", then

OK

– Recording starts.



Tips

To exit the screen

Press [RETURN].

To stop recording partway

Press [■ STOP].

To show the remaining recording time

Press [STATUS] to show the remaining recording time.

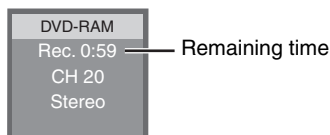

Playing while you are recording

- You can play DVD or VHS while recording to the other drive. The recording will not be affected
 - DVD playback (→ 17)
 - VHS playback (→ 17)



Notes

- During playing while you are recording, you cannot edit or delete recordings.
- You cannot play a tape with the DVD PRIORITY output terminals or HDMI AV OUT terminal while recording or making a scheduled recording on a disc (→ 70).
- Closed captions will not appear during simultaneous recording and playback.
- Use caution while operating the controls for playback. Pressing [■ STOP] when the recording device is selected will cancel the recording in progress.

Chasing Playback

RAM Allows playback from the beginning of what you are recording.

When recording to DVD-RAM



(at least 20 seconds after recording starts).

- If the "Status Messages" in the Setup menu is set to "Automatic" (→ 62), both "Play" and "Rec." indicators will be displayed on the status message screen for several seconds.



Tips

- **To stop play**
Press [■ STOP] once.
- **To stop recording**
Press [■ STOP], at least 2 seconds after chasing playback stops.

Simultaneous Record and Playback

RAM Allows playback of a previous recording, while recording something else.

1

When recording to DVD-RAM



2

▲, ▼, ▶, ▶ to select the recording to play, then



- If the "Status Messages" in the Setup menu is set to "Automatic" (→ 62), both "Play" and "Rec." indicators will be displayed on the status message screen for several seconds.



Tips

To stop play

Press [■ STOP].

To exit the DIRECT NAVIGATOR screen

Press [DIRECT NAVIGATOR].

To stop recording

After play stops

1. Press [DIRECT NAVIGATOR] to exit the screen.

2. Press [■ STOP].

Advanced Scheduled Recording

To cancel a scheduled recording in progress

1  to select the drive.

2 
 – Confirmation screen appears.

3  to select “Stop recording”, then 



Notes







Recording stops and ‘one-time’ programs are deleted from the Schedule List. Programs scheduled to record ‘Daily’ and ‘Weekly’ remain on the Schedule List and are set to begin at the next scheduled time.



Check, Change, or Delete Programs



The scheduled recording list can be viewed even when the unit is in “recording standby” mode.

1 
 – See “Tips” (→ right) for explanation of icons displayed.

2 ,  to select the program.

3a  to modify the program.
 , , ,  to make changes, then 

3b 
 or
  , then  to delete.
 – You cannot delete programs that are currently recording.

4  – “” lights on the unit’s display.

Notes

- If the program schedule is changed by the TV station, then this unit will not be able to detect the change.
- The password screen appears when setting parental ratings (→ 56). Unless you enter the correct password, recording a program with parental ratings may fail.

Tips

You can enter up to 16 programs a month in advance.

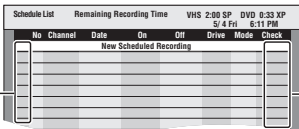

A Schedule List screen icons



- : Currently recording
- ⌚: Programs are overlapped. Recording of the program with the later start time starts when the earlier program finishes recording.
- ⊖: You stopped a weekly or daily scheduled recording. The icon disappears when the next scheduled recording starts.
- 🗄️: The disc was full. (not enough space)
- 🔒: The TV program may not be recorded due to copy-protect or ratings. (disc)
- ⊗: Recording stopped (Dirty disc, etc.)
- PG!**: Recording may become impossible when a wrong password is entered through the unit’s parental rating setting procedure.



B Check

- OK: Recordable (disc)
- (Date): The last day of daily or weekly recording. (disc)
- !: It may not be possible to record because:
 - the disc is write-protected.
 - there is no more space left (disc).
 - the number of possible recordings has reached its maximum (disc).
- Overlap: When the date and time overlap with another scheduled recording, only a part of the program can be recorded (disc).
- : When the drive is set to VHS, “--” is displayed.

To release the unit from recording standby (Before recording starts)

DVD/VHS POWER

 – The unit turns on and “” on the unit’s display goes out.

Be sure to press [ DVD/VHS POWER] to return the unit to standby mode before the scheduled recording time. Scheduled recording will work only if “” is displayed.

Recording from an External Device

Recording from a VCR, etc.

Connect cables while the power to both the unit and the external device is off.

Front of the unit

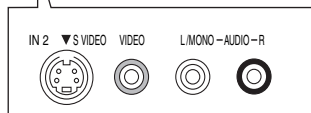

You can get a sharper, clearer picture by connecting with an S Video cable instead of the yellow video cable.

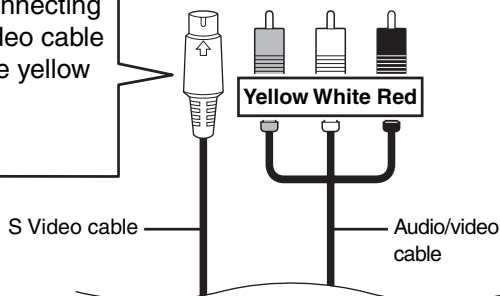

You can also connect to the IN1 on the rear.

Preparation:

- Turn on the unit and connected equipment.
- **RAM** If the disc is protected, release protection (→ 52).
- **VHS** Ensure accidental erasure tab is intact.
- When recording multilingual broadcasts (→ 23)

1 to select the drive (DVD or VHS).

2 Insert a disc or VHS cassette.

3 to select the recording mode (→ 24).

4

5 , to select "IN1" or "IN2", then .

–Rear Panel inputs are IN1.
–Front Panel inputs are IN2.

Tips

- If the external equipment only has a single audio output, connect it to the L/MONO (white) IN2 terminal.

Recording to DVD

RAM -R -R DL -RW(V) +R +R DL +RW

Perform steps 1–5 left.

6 Start play on an external device.

7 to start recording the program from an external device.

Recording to VHS

Perform steps 1–5 left.

6 to locate the point on the tape where you want to insert the recording.

7 when you reach that point.

8 to put the unit in recording standby.

9 Start play on the external device.

10 to start recording the program from the external device.

Tips

To skip unwanted parts

Press [PAUSE] to pause recording. (Press again to restart recording.)

To stop recording

Press [STOP].

Notes

If video is copied from another piece of equipment to this unit, then the video quality will be degraded.

Recording from a DV Camcorder

Connect the cable while the power to both the unit and the external device is off.

Front of the unit

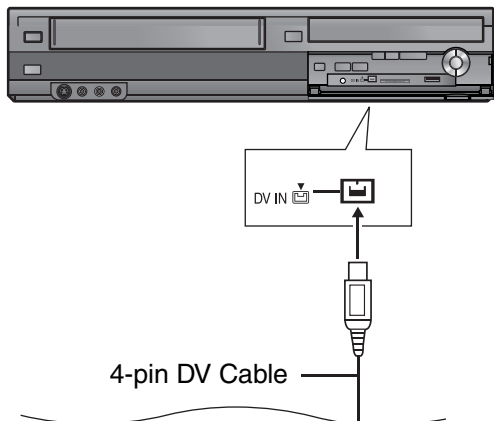

4-pin DV Cable

RAM -R -R DL -RW(V) +R +R DL +RW

Preparation:

- Turn on the unit.
- Insert a disc with enough remaining blank space.
- **RAM** If the disc is protected, release protection (→ 52).

- 1 Turn ON the DV equipment and pause play where you want to begin recording.

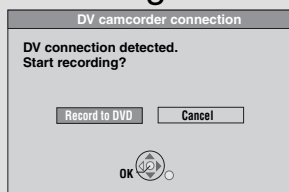

When "DV camcorder connection" screen does not appear

After performing step 1 (→ above).

1. Press [DRIVE SELECT] to select the DVD drive.
–External DV cannot be recorded to VHS.
2. With the unit stopped
Press [FUNCTIONS].
3. Press [▲, ▼] to select "Other Functions" then press [OK].
4. Press [▲, ▼] to select "DV Camcorder Rec." then press [OK].

You can proceed to step 4 (→ right).

- 2 ◀ to select "Record to DVD" then



- 3 REC MODE to select the recording mode for the disc (→ 24).

- 4 ◀ to select "Rec.," then OK



Notes

- If the desired audio is not recorded, select the kind of audio for "Select Audio Channel For DV Input" in the Setup menu (→ 62).
- **RAM** Programs are recorded as a single item; breaks in the images create chapters.
- Compatibility with video camcorders from other manufacturers is not guaranteed.
- It is not possible to operate the unit from the connected DV equipment.
- The DV equipment name may not be shown correctly.
- Date and time information is not recorded, even if displayed on the camcorder.
- The DV IN terminal is not meant to be connected to a computer.
- This unit uses a 4-pin "DV IN" connector;
Your DV camcorder may use a 4-pin or 6-pin external connector. Please consult your DV camcorder's manufacturer to confirm correct external connection.
- You cannot record discs and play discs simultaneously.
- If video is copied from another piece of equipment to this unit, then the video quality will be degraded.



Tips

When recording finishes

The confirmation screen appears.

Press [OK] to finish DV camcorder recording.

To stop recording

Press [■ STOP].



The confirmation screen appears. Press [OK].

- If the DV camcorder recording function does not work properly, check the connections and DV equipment settings, and turn the unit off and back on. If that does not work, follow the instructions for "Recording from a VCR, etc." (→ 28).

Advanced Disc Playback



Zoom in on video

1 During playback
SUB MENU

2 To zoom in:
,  to select "Zoom In", then









Tips

To return the picture to its original size
Press [, ] to select "Zoom out" in step 2, then press [OK].

Menu Screens on the TV

DVD-V

Generally, menu screens that appear on the TV may be navigated as follows:

, , ,  to select an item, then

You can sometimes use the numbered buttons to select an item.



Tips

To return to the menu screen
Press [DIRECT NAVIGATOR].





Notes





If "C" appears on the TV, the operation is prohibited by the unit or disc.

Selecting Recordings to Play

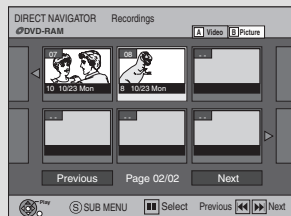
RAM -R -R DL -RW(V) +R +R DL +RW -RW(VR)

1 
RAM When the Album View screen is displayed, press  to switch to the Recordings screen.



2 , , ,  to select the recording you want to watch, then 









Tips

To select the recording with the numbered buttons

e.g., "5": [0] → [5]
"15": [1] → [5]





To view other pages

Press [, , , ] to select "Previous" or "Next", then press [OK].
– You can also press [, ] to view other pages.

To exit the DIRECT NAVIGATOR screen



Press [DIRECT NAVIGATOR].

DIRECT NAVIGATOR screen icons

-  Protected.
-  Not recorded due to recording protection (Digital broadcasts, etc.)
-  It cannot be played because data is damaged.
-  Currently recording.
-  "One time only recording" restriction (→ 91, CPRM)

Search



During playback



 OR 

- There are 5 search speeds. Each press increases the search speed.
- Press [ PLAY] to restart normal playback.

Skip













During playback or while paused

 OR 

- Each press increases the number of skips.
- **DivX:** Backward direction [] only.
Press [] to return only to the beginning of the program being played back.

Direct Play

During playback, you can access specific recordings or scenes through direct entry of the numbered buttons.

			e.g., "5": [0] → [5]
			"15": [1] → [5]
			MP3
			e.g., "5": [0] → [0] → [5]
			"15": [0] → [1] → [5]
			JPEG
			e.g., "5": [0] → [0] → [0] → [5]
			"15": [0] → [0] → [1] → [5]
			
			



Tips

Depending on the disc, some operations may not be possible.

Quick View (Play × 1.3)

RAM

Allows you to increase the play speed slightly without distorting the audio.

During playback

 (Press and hold.)



– Press again to return to normal speed.

Slow-motion Play

RAM -R -R DL -RW(V) +R +R DL +RW

DVD-V -RW(VR)

While paused

 OR 

- There are 5 slow-motion speeds. Each press increases the speed.
- Press  [PLAY] to restart normal playback.



Notes

If continued for approx. 5 minutes, slow-motion play pauses automatically (except **DVD-V**).

Frame-by-Frame Viewing

RAM -R -R DL -RW(V) +R +R DL +RW

DVD-V -RW(VR)

While paused



- Each press shows the next or previous frame.
- Press and hold to advance or reverse frame-by-frame in succession.
- Press  [PLAY] to restart normal playback.

Time Slip

RAM -R -R DL -RW(V) +R +R DL +RW -RW(VR)

Use to skip in 1-minute or 10-minute increments.

1



During playback



2

,  to select the time, then



- Each press of  or  advances the interval by 1 minute (press and hold for 10-minute intervals).

CM Skip

RAM -R -R DL -RW(V) +R +R DL +RW -RW(VR)

Skips 1-minute forward with each press.

During playback





Create Chapters

RAM

During playback



Tips

You can skip to the start of a chapter by pressing [, ].



Tips

Depending on the disc, some operations may not be possible.

Changing Audio during Playback

AUDIO



to select the audio.

Available audio will differ based on disc type. See below.

RAM -RW(VR) and **DivX**
Stereo → Mono L → Mono R

e.g.: **RAM**
“Stereo” is selected.

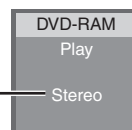

RAM -RW(VR) When playing an analog multilingual broadcast, you can choose between Main Audio and SAP Audio.

Main Audio ↔ SAP Audio

DVD-V

This allows you to change items like the audio channel number and the soundtrack language (→ 50).



e.g., English is the selected language.



Notes

If you cannot change the audio type when you have used only an optical digital audio cable for connection, set “Dolby Digital” to “PCM” (→ 61). Alternatively, you may connect to an amplifier or system component with an audio cable and change the input on the amplifier or system component to suit the connection (→ 72).

Playing Playlists

RAM -RW(VR)

You cannot create or edit playlists on this unit. However, you can play a playlist that has been created or edited on other equipment.

- 1  to select the DVD drive.

With the unit stopped

- 2 

- 3 ▲, ▼ to select “Other Functions”
then 

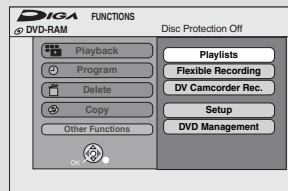



- 4 ▲, ▼ to select “Playlists”, then

- 5 ▲, ▼, ◀, ▶ to select the playlist
to play, then 

Playlist Properties

Perform steps 1–4 above

- 5 ▲, ▼, ◀, ▶ to select the playlist,
then 

- 6 ▲, ▼ to select “Properties”, then

– Playlist information (e.g., length and date) is shown.

View Chapters

Perform steps 1–4 left

- 5 ▲, ▼, ◀, ▶ to select the playlist,
then 

- 6 ▲, ▼ to select “View Chapters”,
then 

- 7 ▲, ▼, ◀, ▶ to select the
chapter, then 



Tips

To return to the playlist screen

Press [SUB MENU], then select “View Playlists” and press [OK].

To view other pages

Press [◀, ▶].

Playing MP3s

-R -R DL CD USB

MP3 recorded on DVD-R, DVD-R DL, CD-R/RW or USB memory can be played on this unit.

USB The screen shown below may be displayed when you insert a USB memory (→ 15).

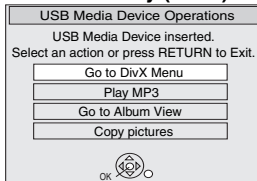

Press [▲, ▼] to select "Play MP3", then press [OK]. You can proceed to step 3 (→ below).

-R -R DL CD The screen shown below is displayed when you insert a disc containing MP3 files, DivX video contents and still pictures (JPEG).

e.g.,

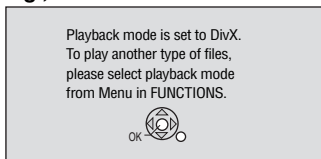

1. Press [OK] to exit the screen.
2. Press [FUNCTIONS].
3. Press [▲, ▼] to select "Menu", then press [OK].
4. Press [▲, ▼] to select "MP3 Music", then press [OK]. You can proceed to step 3 (→ below).

1



to select the DVD or USB drive.

2



Track list is shown.

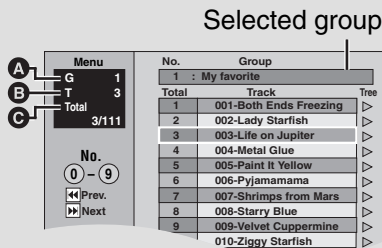

- A: Group No.
- B: Track No. in the group
- C: Track No./Total tracks in all groups

–When the DivX or JPEG Menu is displayed, perform steps 1–4 in "To select file type" on the right column selecting "MP3 Music" in step 4 to change the playback mode.

3

▲, ▼ to select a track, then to play.
–"13" indicates the track currently playing.



Tips

To select file type

1. Press [RETURN].
2. Press [FUNCTIONS].
3. Press [▲, ▼] to select "Menu", then press [OK].
4. Press [▲, ▼] to select "MP3 Music", then press [OK].

e.g.,

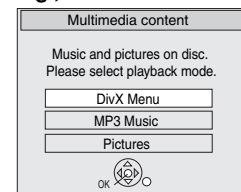

To stop playing

Press [■ STOP].

To exit the menu screen

Press [DIRECT NAVIGATOR].

To view other pages

Press [◀, ▶].

To select the track with the numbered buttons

e.g., "5": [0] → [0] → [5]
"15": [0] → [1] → [5]

Using the Tree Screen to Find a Group

1

From the track list

▶ while a track is highlighted to display the tree screen.

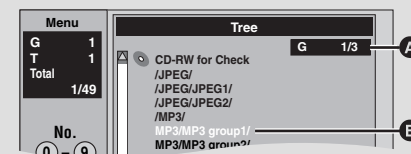

- A: Selected Group No./Total Group No. If the group has no compatible track, "--" is displayed as the group number.
- B: Selected Group

2

▲, ▼ to select a group, then



– The track list for the selected group appears.



Notes

- When there is a large amount of still picture data etc. within an MP3 file, play may not be possible.
- You cannot operate the scroll bar that appears in the tree screen.



Tips

To return to the track list

Press [RETURN].

Playing Still Pictures (JPEG)

RAM -R -R DL CD SD USB

Still pictures (JPEG) recorded on DVD-RAM, DVD-R, DVD-R DL, CD-R/RW, SD Memory Cards or USB memory can be played on this unit.

SD USB The screen shown below may be displayed when you insert an SD card or USB memory (→ 15).

e.g., **USB**

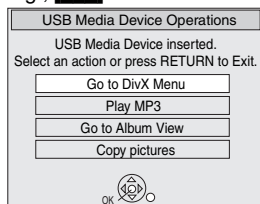

Press [▲, ▼] to select "Go to Album View", then press [OK]. You can proceed to step 3 (→ below).

-R -R DL CD The screen shown below is displayed when you insert a disc containing MP3 files, DivX video contents and still pictures (JPEG).

e.g.,

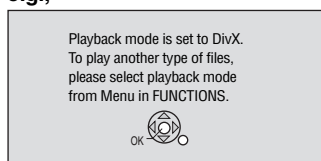

1. Press [OK] to exit the screen.
2. Press [FUNCTIONS].
3. Press [▲, ▼] to select "Menu", then press [OK].
4. Press [▲, ▼] to select "Pictures", then press [OK].
You can proceed to step 3 (→ below).

1 to select the drive (DVD, SD or USB) .

2 Album View screen

- **RAM** When the Recordings screen is displayed, press **B** to switch to the Album View screen.
- **-R -R DL CD USB** When the DivX or MP3 Menu is displayed, perform steps 1–4 in "To select file type" on the upper Tips on page 33, selecting "Pictures" in step 4 to change the playback mode.

3 ▲, ▼, ◀, ▶ to select an album, then .

– The Picture (JPEG) View screen appears.

4 ▲, ▼, ◀, ▶ to select a picture, then to view.

Notes

- You can use 8MB to 2GB SD memory cards, 4GB, 8GB, 16GB SDHC memory cards (→ 73).
- Still pictures cannot be played during recording on the DVD drive or copying.
- Thumbnails for large JPEG files and images with aspect ratios other than 4:3 may not display.

Tips

To stop viewing a picture

Press [■ STOP].

To exit the menu screen

Press [DIRECT NAVIGATOR].

To view other pages

Press [▲, ▼, ◀, ▶] to select "Previous" or "Next", then press [OK]. You can also press [◀◀, ▶▶] to view other pages.

To select the still picture or album with the numbered buttons

Album
e.g., "5": [0] → [0] → [5]
"15": [0] → [1] → [5]

Still picture
e.g., "5": [0] → [0] → [0] → [5]
"15": [0] → [0] → [1] → [5]

DIRECT NAVIGATOR screen icon

▶ Album that has not yet been viewed **(RAM)**

Slideshow

1 From the Album View screen
▲, ▼, ◀, ▶ to select an album, then .

2 ▲, ▼ to select "Start Slideshow", then .

Tips

To stop the Slideshow

Press [■ STOP].

To change Slideshow settings

- 1 In step 2 above, press [▲, ▼] to select "Slideshow settings", then press [OK].
- 2 Press [▲, ▼] to select each item.

Slide Interval

- Press [◀, ▶] to select desired interval (0 to 99 seconds), then press [OK].

Repeat Play

- Press [◀, ▶] to select "On" or "Off", then press [OK].

SNDTRK Instruction

- If you select "On", then a screen will be displayed showing the operations for a slideshow with soundtrack when a slideshow is played.
- Press [◀, ▶] to select "On" or "Off", then press [OK].

Slideshow with soundtrack

It is possible to play MP3 music recorded on a USB memory during a Slideshow.

Preparation:

- Insert a USB containing MP3 files.

- 1 From the Album View screen
▲, ▼, ◀, ▶ to select an album,
then  SUB MENU

- 2 ▲, ▼ to select
“Slideshow w/ SNDTRK”,
then  OK

Slideshow w/ SNDTRK
SNDTRK Folder

Tips

To select an MP3 folder to be played

- 1 In step 2 above, press [▲, ▼] to select “SNDTRK Folder”, then press [OK].
- 2 Press [◀, ▶] to select the folder, then press [OK].

Rotate Pictures

While playing a picture

- 1  SUB MENU

- 2 ▲, ▼ to select “Rotate Right” or “Rotate Left”,
then  OK

Control Panel
FUNCTIONS
Rotate Right
Rotate Left
Zoom In

Notes

To return the picture to its original position

Press [▲, ▼] to select the opposite rotation in step 2, then press [OK].

- Rotation information will not be stored.

–R –R DL CD

- When disc or album is protected
- When played on other equipment
- When copying pictures

Zoom

- 1 While playing a picture
 SUB MENU

- 2 To zoom in:
▲, ▼ to select “Zoom
In”, then  OK

Control Panel
FUNCTIONS
Rotate Right
Rotate Left
Zoom In

Tips

To return the picture to its original size

Press [▲, ▼] to select “Zoom out” in step 2, then press [OK].

- When zooming in, the still picture may be cut off.
- “Zoom In” information is not stored.
- “Zoom In” and “Zoom out” do not work with images that have a resolution larger than 640×480 pixels.

Picture Properties

While playing a picture
 STATUS
twice to display picture
properties.

Shooting Date
11/30 12:03 AM
Date 11/26/2006 0002/0030

 STATUS
again, to exit.

Notes

Depending on the camera or editing software; shooting dates may not be displayed correctly.

Playing DivX

-R -R DL CD USB

You can play CD-R/CD-RW, DVD-R, DVD-R DL discs and USB memories which contain DivX video contents that have been recorded on a computer.

USB When you insert a USB memory, the menu screen appears. (→ 33, left column)

Press [▲, ▼] to select "Go to DivX Menu", then press [OK]. You can proceed to step 3 (→ below).

-R -R DL CD When you insert a disc containing MP3 files, DivX video contents and still pictures (JPEG), the files selection screen appears. (→ 33, left column)



Press [OK]. You can proceed to step 3 (→ below).

1  to select the DVD or USB drive.

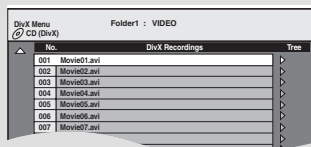
2  DivX file list is shown.



– When the MP3 or JPEG Menu is displayed, perform steps 1–4 in "To select file type" on the upper Tips on page 33, selecting "DivX Menu" in step 4 to change the playback mode.

3  to select the recording, then 

Notes

- Picture sizes set at the time of recording may prevent the unit from showing pictures in the proper aspect ratio. You may be able to adjust the aspect ratio through the TV.
- Successive play is not available.

Tips

To view other pages

Press [◀◀, ▶▶].

To stop playing

Press [■ STOP].

To exit the menu screen

Press [DIRECT NAVIGATOR].

To select the recording with the numbered buttons

e.g., "5": [0] → [0] → [5]
 "15": [0] → [1] → [5]

Using the Tree Screen to Find a Folder

From the DivX file list

1  while a recording is highlighted to display the tree screen.



- A:** Selected folder No./Total folder No. including DivX recording
- B:** Selected folder

2  to select a folder, then  – The file list for the folder appears.

Notes

- You cannot operate the scroll bar that appears in the tree screen.

Tips

To return to the previous screen

Press [RETURN].

Regarding DivX VOD content

DivX Video-on-Demand (VOD) content is encrypted for copyright protection. In order to play DivX VOD content on this unit, you first need to register the unit.

Follow the online instructions for purchasing DivX VOD content to enter the unit's registration code and register the unit.

For more information about DivX VOD, visit www.divx.com/vod

Display the unit's registration code.

(→ 58, "DivX Registration" in the "Setup" menu)

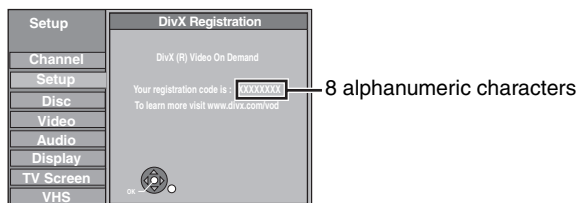

- After playing DivX VOD content for the first time, a new registration code is then displayed in "DivX Registration". Do not use this registration code to purchase or rent DivX VOD content. If you use this code to purchase (rent) DivX VOD content, and then play the content on this unit, you will no longer be able to play any content that you purchased (rented) using the old code.
- If you purchase or rent DivX VOD content using a registration code different from this unit's code, you will not be able to play that content. ("Authorization Error" is displayed.)

Regarding DivX content that can only be played a set number of times

Some DivX VOD content can only be played a set number of times. When you play this content, the remaining number of plays is displayed. You cannot play this content when the number of remaining plays is zero. ("Rental Expired" is displayed.)

When playing this content

• The number of remaining plays is reduced by one if:

- you press [⏻ DVD/VHS POWER].
 - you press [■ STOP].
 - you press [◀◀].
 - you press [◀▶, ▶▶] etc. and arrive at the end of the content or the start of the content being played.
 - you press [DRIVE SELECT] to change the drive.
 - you press [DIRECT NAVIGATOR].
- Resume play function does not work.

Advanced Video Cassette Playback

Zoom in on video

1 During playback
SUB MENU

2 To zoom in:
▲, ▼ to select "Zoom In", then





Tips

To return the picture to its original size

Press [▲, ▼] to select "Zoom out" in step 2, then press [OK].

Fast-forward/Rewind

With the unit stopped

 to fast-forward the tape.
 to rewind the tape.

Slow playback

During playback

 Press and hold for about 2 seconds.
– Press [▶ PLAY] to restart normal playback.





Notes

Slow playback is automatically canceled after 10 minutes.

Cue/Review

Allows to quickly review a portion of the video just played, or cue later portions of the tape.

During playback

 to cue later portions of the tape.
 to review portion just played.
– Press [▶ PLAY] to restart normal playback.



Notes

Cue/review is automatically canceled after 10 minutes.



Tips



For quicker operation

• Hold [◀◀, ▶▶] to start cue/review and release the button to restart normal playback.

Jet Search

Allows high speed search of video in forward or reverse direction.

During playback

 twice to Jet Search forward.
 twice to Jet Search in reverse.
– Press [▶ PLAY] to restart normal playback.



Notes

- The speed of Jet Search ($\times 27$ or $\times 35$) can be specified via the Setup menu (\rightarrow 66).
- Recordings made in EP or VP mode may experience distortions or vertical scroll at 35 times speed. If so, change speed to 27 times.
- Depending on your TV, the picture may not be in color or may be distorted.
- Jet Search is automatically canceled after 10 minutes.

Jet Rewind

Video tapes will rewind to the beginning of the tape at higher-speed.

TIME SLIP/◀◀JET REW





Notes

- Depending on the tape or an operating condition, the rewind speed may change somewhat.
- The tape counter is reset to "0:00.00" when the tape is rewound to the beginning.
- Depending on the tape, this function may not work.

VHS Index Search System (VISS)

The unit automatically records special index signals on a tape every time a recording is started (via [● REC], or a scheduled recording). The index search function makes use of these index signals to help you find the beginning of a desired program quickly and easily.

While stopped or during normal play

 or .
– Each press increases the number of skips.
– Press [■ STOP] to cancel the search.



Notes

- Up to 20 index signals can be searched in either direction.
- If you overshoot in either direction, press the opposite button to correct.
- For correct operation, make recordings of at least 5 minutes to ensure that index signals are not spaced too closely together.

Advanced Video Cassette Playback

S-VHS Quasi Playback (SQPB)

This unit can play tapes recorded in S-VHS.

- Some picture noise may occur depending on the type of tape used.
- It is not possible to fully obtain the high resolution S-VHS is capable of.
- This unit cannot record in S-VHS.

Repeat Playback

When the tape reaches the end of the program, it will automatically rewind to the beginning and play again.

During playback or while stopped



Press and hold for about 5 or more seconds.

- Repeat Playback goes on indefinitely until you cancel it.
- The “RPT” indication appears on the unit’s display.
- Press [■ STOP] to stop play.



Notes

Only works if there is at least 5 seconds blank space at the end of the program.

Changing Audio during Playback



repeatedly, to select the audio option.

Stereo → Mono L → Mono R
↑ No display (Normal audio track) ↓



Tips

Auto Bilingual Selection Function **VHS**

When a stereo broadcast or multilingual broadcast is recorded and played back on the unit, stereo sound will be automatically selected in the case of a stereo broadcast and SAP sound will be automatically selected in the case of a multilingual broadcast.

- This function may not work properly if the program is played back from a mid point. In a case like this, press [AUDIO] and select the right sound.
- The function will not work with a cassette which has been recorded from external equipment.

Adjusting the playback picture

Manual Tracking

The unit usually makes tracking adjustments automatically, but you may need to do it manually if noise appears on a tape recorded on other equipment.

During playback

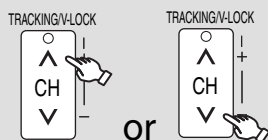

- Repeat until the picture noise disappears.

To return to auto tracking:

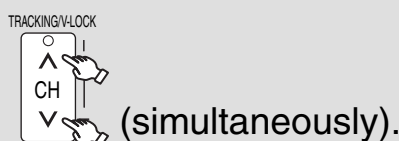

Tips

To remove the noise from a paused picture:
Start slow play (→ 37), then adjust the tracking.



Notes

- This function may not work with some tapes.
- You can also adjust the tracking with [CH ▲, ▼] on the main unit.

Vertical Locking Adjustment

Adjust the vertical synchronization to stop the picture from shaking while paused.

While paused

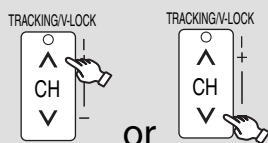

- Repeat until the shaking stops.

To return to the standard position:

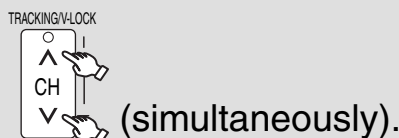

Notes

- This function may not work with some tapes.
- You can also adjust vertical synchronization with [CH ▲, ▼] on the main unit.

Status Messages

The following messages and displays appear to let you know what operations are being performed and the status of the unit.

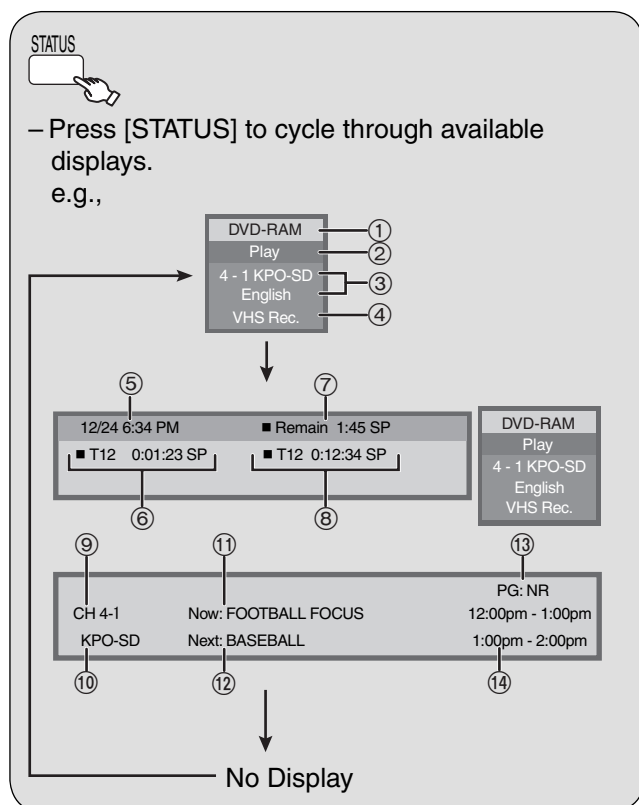

■ Display examples

- ① Current media
- ② Shows current recording or play status.
- ③ Channel information
- ④ Status of the other drive
- ⑤ The current date and time
- ⑥ Elapsed play time/Recording mode
- ⑦ Remaining recording time and recording mode (e.g.: “1:45 SP” indicates 1 hour and 45 minutes in SP mode)
 - Disc remaining time may slightly differ between different models.
- ⑧ Elapsed recording time and recording mode

Only displayed when receiving a digital broadcast:

- ⑨ Channel
- ⑩ Channel caption
- ⑪ Current program
- ⑫ Next program
- ⑬ Parental Rating of the program (→ 67)
- ⑭ Start and finish times of the program

On-screen Display Indicators for Video Cassette Playback

The following on-screen indicator will not be displayed when this unit is connected to the TV with the DVD PRIORITY output terminals or HDMI AV OUT terminal. This indicator is only displayed when playing a tape in this unit's VHS drive while recording a program on the DVD drive. The items displayed may differ depending on the operating conditions.

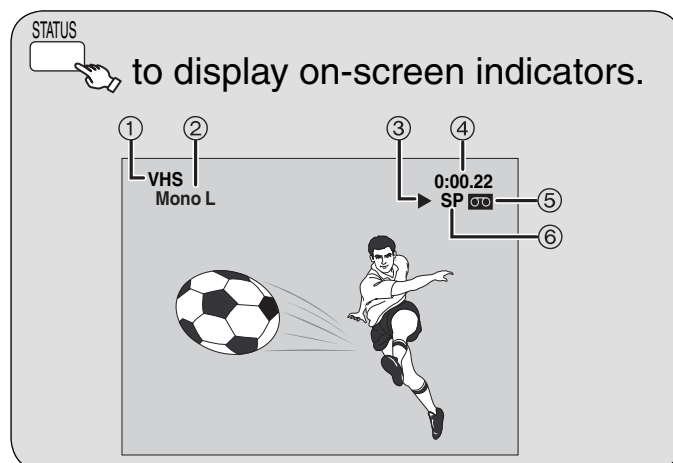

- ① VHS drive indicator
- ② Shows which sound mode is selected as follows:
Stereo: Hi-Fi stereo audio
Mono L: Mono L audio of the Hi-Fi stereo audio
Mono R: Mono R audio of the Hi-Fi stereo audio
No indicator: Normal audio
- ③ Operation status
- ④ Shows the tape counter and remaining tape time
Pressing [STATUS] to cycle the display as follows:
No display → Tape counter
↑ Remaining tape time ↓
 - Press [* DELETE] to reset the tape counter (elapsed time) to “0:00.00”. The tape counter is automatically reset when inserting a video cassette.
- ⑤ Video cassette-in indicator
- ⑥ Recording mode (→ 24)



Tips

To exit on-screen indicators
Press [STATUS] several times.



Notes

Remaining tape time display

- The displayed time is approximate.
- The displayed time will be incorrect if you set the wrong tape length in “Select Tape Length” in the Setup menu (→ 66) and if the tape is of poor quality.

Linked Operations with the TV (VIERA Link™ “HDAVI Control™”)

You can enjoy linked operations with the TV and receiver by using “HDAVI Control”.

What is VIERA Link “HDAVI Control”?

VIERA Link™ is a new name for EZ Sync™.

VIERA Link “HDAVI Control” is a convenient function that offers linked operations of this unit, and a Panasonic TV (VIERA) or receiver under “HDAVI Control”. You can use this function by connecting the equipment with an HDMI cable. See the operating instructions for connected equipment for operational details.

- VIERA Link “HDAVI Control”, based on the control functions provided by HDMI which is an industry standard known as HDMI CEC (Consumer Electronics Control), is a unique function that we have developed and added. As such, its operation with other manufacturers’ equipment that supports HDMI CEC cannot be guaranteed.
- This unit supports “HDAVI Control 3” function.
“HDAVI Control 3” is the newest standard (current as of December, 2007) for Panasonic’s HDAVI Control compatible equipment. This standard is compatible with Panasonic’s conventional HDAVI equipment.
- Please refer to individual manuals for other manufacturers’ equipment supporting VIERA Link function.

Preparation

1. Connect this unit to your TV or receiver with an HDMI cable (→ 11, 72).
2. Set “VIERA Link” to “On” (→ 66). (The default setting is “On”.)
3. Set the “HDAVI Control” operations on the connected equipment (e.g., TV).
 - **When using HDMI2 terminal of VIERA as “HDAVI Control”, set the input channel to HDMI2 on VIERA.**
4. Turn on all “HDAVI Control” compatible equipment and select this unit’s input channel on the connected TV so that the “HDAVI Control” function works properly.

When the connection or settings are changed, repeat this procedure.

(When the TV is on) Automatic input switching

When the TV is on and the following operations are performed, the TV’s input will automatically switch to HDMI input mode and the TV displays the corresponding action.

(Picture or sound may not be available for the first few seconds.)

Press [FUNCTIONS]^{※1}, [▶ PLAY]^{※2}, [DIRECT NAVIGATOR], [SCHEDULE], etc.

- If you operate the VHS when the unit is recording on the DVD drive, the output does not automatically switch.

(When the TV is off) Power on link

When the TV is off and the following operations are performed, the TV will automatically turn on and display the corresponding action.

(Picture or sound may not be available for the first few seconds.)

Press [▶ PLAY]^{※2}, [DIRECT NAVIGATOR], [SCHEDULE], etc.

- **DVD-V^{※3}**, etc.

The TV is automatically turned on when you insert a disc or a tape without the accidental erasure prevention tab.

- If you operate the VHS when the unit is recording on the DVD drive, the TV does not automatically turn on.

Power off link

When you turn the TV off, this unit is also automatically turned off. This unit automatically turns off even if the FUNCTIONS screen, the status message or the on-screen menu is displayed during playback.

Even if the TV is turned off, this unit will not turn off at the same time under the following conditions:

- when you press [● REC] and this unit is recording
- when scheduled recording is proceeding
- when copying
- when finalizing, etc.

- When this unit is connected to an “HDAVI Control” compatible Panasonic receiver with an HDMI cable, the receiver will also turn off.

※1 This button is available only when this unit is on.

※2 When this button is pressed, the playback image is not immediately displayed on the screen and it may not be possible to watch the contents from where playback started.

In this case, press [◀◀] or [◀◀] to go back to where playback started.

※3 Depending on discs, the TV may not automatically turn on.



Notes

- When this unit is connected to a Panasonic TV (VIERA) supporting HDAVI Control 3 and initially set up, it automatically acquires the TV setting information.
- These functions may not work normally depending on the equipment condition.
- About “HDAVI Control” function, read the operating instructions of the connected equipment (e.g., TV) too.

Easy control only with VIERA Remote Control

If you connect this unit via HDMI cable to a TV with “HDAVI Control 2” or “HDAVI Control 3” function, you can operate both units more conveniently.

You can operate this unit using the following buttons on the TV remote control.

[▲], [▼], [◀], [▶], [OK], [RETURN], [SUB MENU].

Use the remote control for this unit to operate any other buttons (numbered buttons, etc.) that are not listed above.

Using the FUNCTIONS window to operate this unit

Refer to TV operating instruction for operating the TV.

- 1 Display this unit’s “FUNCTIONS” window using the TV remote control.

• If this unit is set to off, it will automatically turn on.

- 2 Select the item you want to operate with the TV remote control, then

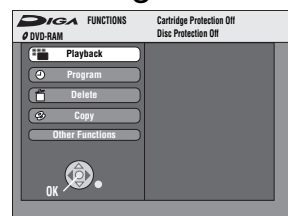

About the FUNCTIONS window (→ 42)

Using the SUB MENU window to operate this unit

By using the TV remote control, you can play discs and select the drive (DVD, VHS, SD or USB) using the “Control Panel” (→ below).

- 1 SUB MENU
e.g.,
- 2 Select an item, then

Control Panel	Control Panel is displayed (→ below).
FUNCTIONS	FUNCTIONS window is displayed (→ above).
Top Menu DVD-V	Top menu is displayed (→ 30).
Menu DVD-V	Menu is displayed (→ 30).
Drive Select	Select the DVD, VHS, SD or USB drive.
Set Favorite	Set Favorite list is displayed (→ 16).
Rotate Right (JPEG)	Rotate the still pictures (→ 35).
Rotate Left (JPEG)	
Zoom In	Enlarge or shrink the video or the still picture (→ 35).
Zoom out	

Using the Control Panel

Using the Control Panel, you can operate search backward, search forward, stop, etc. with the TV remote control.

Perform steps 1 and 2 of “Using the SUB MENU window to operate this unit”.

The Control Panel is displayed (→ right)

While playing a recording or DVD-Video, etc.

– [▲]: Pause, [▼]: Stop, [◀]: Search backward, [▶]: Search forward, [OK]: Play, [EXIT]: Exit the screen.

While playing still pictures

– [▼]: Stop, [◀]: View previous picture, [▶]: View next picture, [EXIT]: Exit the screen.

Control Panel

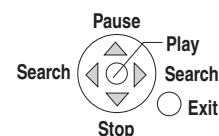

Notes

When you record a program by operating the TV (Direct TV Recording, etc.)

- It is recorded on a disc in the recording mode preset on this unit.
- If the Direct TV Recording mode has been activated on this unit, then a new program cannot be recorded using this mode.

■ When you want to leave the TV on and turn off only this unit

Press [DVD/VHS POWER] on this unit’s remote control to turn off

■ When not using “HDAVI Control”

Set “VIERA Link” in the setup menu to “Off” (→ 66).

FUNCTIONS Window

By using the FUNCTIONS window you may access the main functions quickly and easily.

With the unit stopped

1

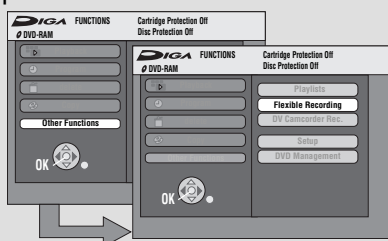

2

▲, ▼ to select a menu item, then 

– If you select “Other Functions”, press [▲, ▼] to select a menu item and press [OK].

Playback

▶ 30

You can select and play recorded programs.

Program

▶ 19

You can make scheduled recording settings.

Delete

▶ 22

You can delete recordings using DELETE Navigator.

Copy

▶ 20

You can copy recordings using COPY Navigator.

Copy New Pictures

▶ 48

You can copy still pictures.

Playlists

▶ 32

You can play playlists.

Flexible Recording

▶ 26

The unit sets the best possible picture quality that fits the recording within the remaining disc space.

DV Camcorder Rec.

▶ 29

DV automatic recording function

Setup

▶ 55

You can change the unit’s settings using Setup menu.

DVD and Card Management

▶ 52

You can manage discs through formatting, finalizing and other operations.

Entering Text

1

When viewing the Name screen.

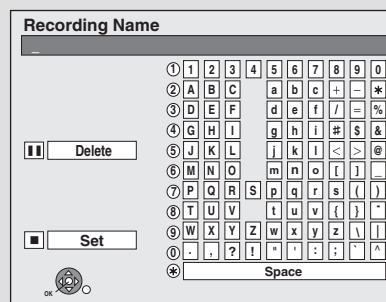

2

▲, ▼, ◀, ▶ to select characters, then 

–Repeat this step to enter other characters.

3



when you’ve finished entering text.



Tips

Using the numbered buttons to enter characters

e.g.: entering the letter “R”

1. Press [7] to move to the 7th row.
2. Press [7] twice to highlight “R”.
3. Press [OK].

To enter a space

Press [* DELETE] then press [OK].

To delete a character

Press [■ PAUSE] on a character in the name field.

To cancel in the middle

Press [RETURN].

Characters will not be saved.



Notes

Long recording names may not be displayed.

Recordings–Editing

Tips

Recording/Chapter

Normally, programs are recorded as a single item consisting of one chapter.

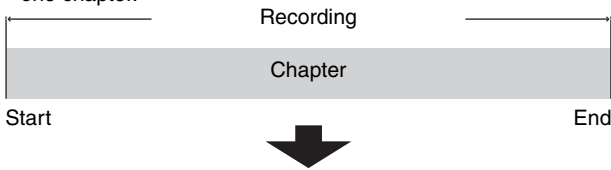

RAM You can divide a recording into multiple chapters.



After finalizing, recordings are divided into chapters of the following lengths.

-R -R DL -RW(V): Chapters are approx. 5 minutes long
+R +R DL: Chapters are approx. 8 minutes long

Maximum numbers of items on a disc

	RAM -R -R DL -RW(V)	+R +R DL +RW
Recordings	99	49
Chapters	Approx. 1000	Approx. 254

Accessing the Recording View

1 to select the DVD drive.

2 **RAM** When the Album View screen is displayed, press **A** to switch to the Recordings screen.

3 **▲, ▼, ◀, ▶** to select a recording.
 –Multiple editing (→ right, Tips)

4 **SUB MENU** to display the menu list.
To view more options
 Press **▲, ▼** to select “Edit Recording”, then press **[OK]**.
 •Items that cannot be selected are gray.
 e.g., **RAM**

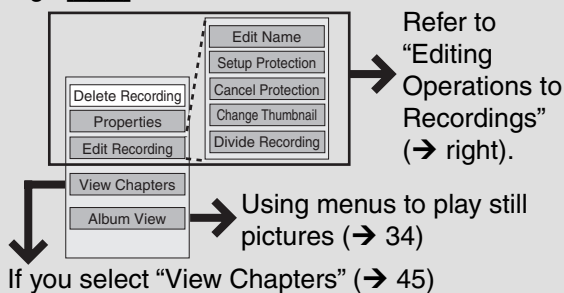

Notes

- You cannot edit during recording or copying.
- +R +R DL** Management information is recorded in unused sections when you edit discs. The available space on these discs decreases each time you edit their contents.

Tips

To exit the menu screen

Press **[DIRECT NAVIGATOR]**.

To view other pages

Press **▲, ▼, ◀, ▶** to select “Previous” or “Next”, then press **[OK]**.
 –You can also press **[◀◀, ▶▶]** to view other pages.

Multiple editing

Select with **▲, ▼, ◀, ▶**, then press **[PAUSE]**. (Repeat.)
 –A checkmark appears. Press **[PAUSE]** again to cancel.

Editing Operations to Recordings

Delete Recording

Perform steps 1–4 of “Accessing the Recording View”.

RAM -R -R DL -RW(V) +R +R DL +RW

Important: Once deleted, contents cannot be recovered.

5 **▲, ▼** to select “Delete Recording”, then

6 **◀** to select “Delete”, then

Recording Properties

Perform steps 1–4 of “Accessing the Recording View”.

RAM -R -R DL -RW(V) +R +R DL +RW -RW(VR)

5 **▲, ▼** to select “Properties”, then
 –Recording information is shown (e.g., date, time).

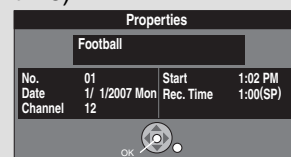

Recording Name

Perform steps 1–4 of “Accessing the Recording View”.

RAM -R -R DL -RW(V) +R +R DL +RW

5 **▲, ▼** to select “Edit Name” then
 –You can give a name for the recording (→ 42).

Continued on next page.

Recordings–Editing

Setup Protection/Cancel Protection

Perform steps 1–4 of “Accessing the Recording View” (→ 43).

RAM

Use to prevent accidental erasure of recordings.

5 ▲, ▼ to select “Setup Protection” or “Cancel Protection”, then 

6 ◀ to select “Yes”, then 

The lock symbol appears when the recording is protected.

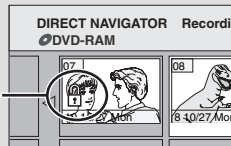

Change Thumbnail

Perform steps 1–4 of “Accessing the Recording View” (→ 43).

RAM -R -R DL -RW(V) +R +R DL +RW

Changes the thumbnail picture shown in the Recordings screen.

5 ▲, ▼ to select “Change Thumbnail”, then 

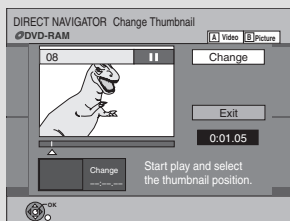

6  to start play.

7  at the point you want to use as your thumbnail.

–To change the thumbnail:
Restart play and press [▲, ▼] to select “Change” then press [OK] at the point you want to use as the thumbnail.

8 ▲, ▼ to select “Exit”, then 



Tips

For quicker editing

- Use Search (→ 30), Slow-motion Play or Time Slip (→ 31) to find the desired point.
- To skip to the start or end of a recording, press [I◀◀] (start) or [▶▶I] (end).
- For better precision, use Slow-motion Play and Frame by Frame Viewing (→ 31).

Divide Recording

Perform steps 1–4 of “Accessing the Recording View” (→ 43).

RAM

Once divided, recordings cannot be recombined.

5 ▲, ▼ to select “Divide Recording” then 



6  at the point you want to divide.

- For quicker editing (→ above, Tips)
- Selecting “Preview” then press [OK] plays the recording from 10 seconds prior, to 10 seconds after the division point.
- To change the point to divide at:
Restart play and press [▲, ▼] to select “Divide” then press [OK] to bring to the point where you want to divide.

7 ▲, ▼ to select “Exit” then 

8 ◀ to select “Divide” then 
–The recording is divided at that point.



Notes

- Divided recordings retain the name of the original.
- A short amount of video and audio just before and after the division point gets cut out.
- You cannot divide a recording when the resulting parts are too short or when the total number of recordings exceeds 99.

Chapters—Creating, Editing

Accessing the Chapter View

RAM

Allows individual viewing and editing of chapters.

1  to select the DVD drive.

2  **RAM** When the Album View screen is displayed, press **A** to switch to the Recordings screen.

3 **▲, ▼, ◀, ▶** to select a recording.

4  to display the menu list.

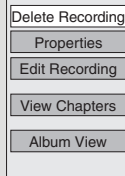

5 **▲, ▼** to select “View Chapters”, then .

6 **▲, ▼, ◀, ▶** to select a chapter.
–Multiple editing (→ below, Tips)

7a To play, .

7b To edit,  to display the menu list.

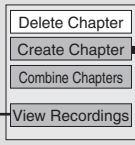

→ Refer to “Chapter Operations” (→ right).

You can go back to the Recordings Screen.

Tips

To exit the menu screen
Press [DIRECT NAVIGATOR].

To view other pages
Press [**▲, ▼, ◀, ▶**] to select “Previous” or “Next”, then press [OK].
–You can also press [**◀◀, ▶▶**] to view other pages.

Multiple editing
Select with [**▲, ▼, ◀, ▶**], then press [**|| PAUSE**]. (Repeat.)
–A checkmark appears. Press [**|| PAUSE**] again to cancel.

Chapter Operations

Create Chapter

Perform steps 1–7b of “Accessing the Chapter View” (→ left).

8 **▲, ▼** to select “Create Chapter” then .



9  at the point you want to divide.

10 **▲, ▼** to select “Exit” then .

Notes

A short portion of the recording just after the creation point may be lost.

Tips

For quicker editing (→ 44, Tips)

Delete Chapter

Important: Once deleted, recorded contents cannot be recovered.

Perform steps 1–7b of “Accessing the Chapter View” (→ left).

8 **▲, ▼** to select “Delete Chapter”, then .

9 **◀** to select “Delete”, then .

Combine Chapters

Perform steps 1–7b of “Accessing the Chapter View” (→ left).

8 **▲, ▼** to select “Combine Chapters”, then .

9 **◀** to select “Combine” then 
–The selected chapter gets combined with the next chapter.

Still Pictures–Editing

Accessing the Album/Picture View

RAM SD USB

- 1**  to select the drive (DVD, SD or USB).

- 2**  **RAM** When the Recordings screen is displayed, press **B** to switch to the Album View screen.
USB When the DivX or MP3 Menu is displayed, perform steps 1–4 in “To select file type” on the upper Tips on page 33, selecting “Pictures” in step 4 to change the playback mode.

Editing an album:

- 3a** ▲, ▼, ◀, ▶ to select the album.
 – Multiple editing (→ right, Tips)

Editing a still picture:

- 3b** 1. ▲, ▼, ◀, ▶ to select the album which contains the still picture to edit, then 
 2. ▲, ▼, ◀, ▶ to select the still picture.
 – Multiple editing (→ right, Tips)

- 4**  to display the menu list.

To view more options

Press [▲, ▼] to select “Edit Album”, then press [OK].

- Items that cannot be selected are gray.

e.g., **SD** Editing an album

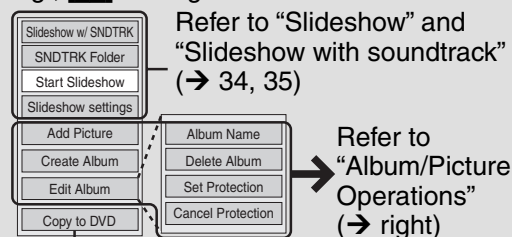

Refer to “Copying Still Pictures via the Album View Screen” (→ 48)

e.g., **SD** Editing a still picture

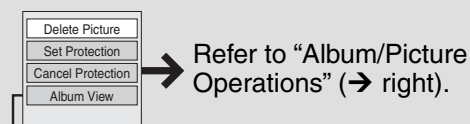

You can go back to the Album View screen.



Tips

To view other pages

Press [▲, ▼, ◀, ▶] to select “Previous” or “Next”, then press [OK].
 –You can also press [◀◀, ▶▶] to view other pages.

Multiple editing

Select with [▲, ▼, ◀, ▶], then press [■ PAUSE]. (Repeat.)
 –A checkmark appears. Press [■ PAUSE] again to cancel.

To exit the menu screen

Press [DIRECT NAVIGATOR].

To return to the previous screen

Press [RETURN].

Album/Picture Operations

Add Picture / Create Album

Perform steps 1–4 of “Accessing the Album/Picture View”.

- 5** ▲, ▼ to select “Add Picture” or “Create Album”, then 

- 6** ◀ to select “Yes”, then 

- 7** ▲, ▼, ◀, ▶ to select the album containing the still picture to add, then 

- 8** ▲, ▼ to select “Select pictures to copy” or “Copy all pictures”, then 

- If “Select pictures to copy” is selected:
Press [▲, ▼, ◀, ▶] to select the picture, then press [OK].
- If “Copy all pictures” is selected:
All the still pictures in the album will be copied.

- 9** ▶ to select “No” to finish copying, then 

–If you want to continue copying, select “Yes” and repeat steps 7–8.

Only when you select "Create Album"

10 ◀, ▶ to select "Yes" or "No", then



- If "Yes" is selected:
You can give a name for the album (→ 42).
- If "No" is selected:
The recording date of the first picture in the album becomes the album name.

Delete Album/Delete Picture

Important: Once deleted, contents cannot be recovered.

- When deleting an album, non-picture files in the album will also be deleted. (This does not apply to subordinate folders in the album.)

Perform steps 1–4 of "Accessing the Album/Picture View" (→ 46).

5 ▲, ▼ to select "Delete Album" or "Delete Picture", then



6 ◀, ▶ to select "Delete", then



Set Protection/Cancel Protection

Set protection to prevent pictures from being accidentally deleted.

Perform steps 1–4 of "Accessing the Album/Picture View" (→ 46).

5 ▲, ▼ to select "Set Protection" or "Cancel Protection", then



6 ◀ to select "Yes", then



–The lock symbol "🔒" appears when the still picture or the album is protected.



Notes

- Even if you set protection using this unit, the album may be deleted by other equipment.

Album Name

Perform steps 1–4 of "Accessing the Album/Picture View" (→ 46).

5 ▲, ▼ to select "Album Name", then



– You can give a name for the album (→ 42).



Notes

- Album names entered using this unit may not display on other equipment.

Copying Still Pictures

Importing Still Pictures from an SD card or USB memory

SD **USB** → **RAM**

This unit saves information about imported still pictures. Therefore, if still pictures are imported from the same SD card or USB memory, then only new still pictures will be imported.

1 With the unit stopped Insert an SD Card or USB memory.

The menu is automatically displayed.

e.g., **SD**

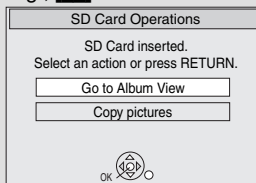

2 ▲, ▼ to select "Copy pictures", then

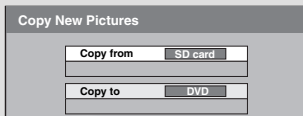

3 ◀, ▶ to select "Copy", then

–Copying starts.

Tips

You can also operate with the following steps

1. Press [DRIVE SELECT] to select the SD or USB drive.
2. While stopped
Press [FUNCTIONS].
3. Press [▲, ▼] to select "Other Functions", then press [OK].
4. Press [▲, ▼] to select "Copy New Pictures", then press [OK].

Notes

- Still pictures already imported cannot be re-imported to the same DVD-RAM.
- This unit saves the information on up to 4,000 still pictures. If additional still pictures are imported, then the older information will be deleted.

Copying Still Pictures via the Album View Screen

When you insert an SD card or USB memory, the menu may be displayed.

Press [RETURN] to exit the screen.

e.g., **SD**

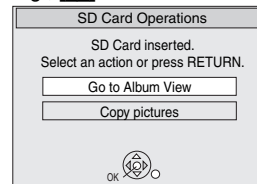

SD **USB** ↔ **RAM**

1 to select the copy source drive (DVD, SD or USB) .

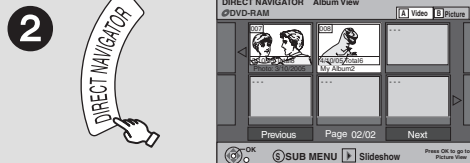

–**RAM** When the Recordings screen is displayed, press [B] to switch to the Album View screen.

–**USB** When the DivX or MP3 Menu is displayed, perform steps 1–4 in "To select file type" on the upper Tips on page 33, selecting "Pictures" in step 4 to change the playback mode.

3 ▲, ▼, ◀, ▶ to select an album, then

4 ▲, ▼ to select "Copy to SD", "Copy to USB" or "Copy to DVD", then

5 ◀, ▶ to select "Start copying", then

–Copying starts.



Tips

When copying finishes

The confirmation screen appears.

Press [OK] to finish copying.

To view other pages

Press [▲, ▼, ◀, ▶] to select “Previous” or “Next”, then press [OK].

– You can also press [◀◀, ▶▶] to view other pages.

Multiple editing

Select with [▲, ▼, ◀, ▶], then press [|| PAUSE].

(Repeat.)

– A checkmark appears. Press [|| PAUSE] again to cancel.



Notes

- If the space on the destination drive runs out or the number of files/folders to be copied exceeds the maximum, copying will stop partway through.
- Even if you input a name to the copy source folder, the name will not be retained to the copy destination folder.
- Still pictures cannot be copied between an SD card and a USB memory.



Tips

To stop copying in the middle

Press and hold [RETURN] for 3 seconds.

To return to the previous screen

Press [RETURN].

Deleting Still Pictures

Delete Navigator

RAM SD USB

Important: Once deleted, contents cannot be recovered.

1  to select the drive (DVD, SD or USB).

2 With the unit stopped  

3 ▲, ▼ to select “Delete” then 

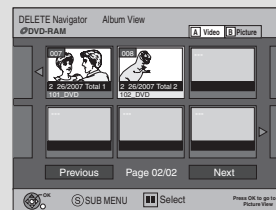



RAM When the Recordings screen is displayed, press **B** to switch to the Album View screen.

Deleting an album:

4a ▲, ▼, ◀, ▶ to select the album, then 

Deleting a still picture:

4b 1. ▲, ▼, ◀, ▶ to select the album, then 
2. ▲, ▼, ◀, ▶ to select the still picture, then 

5 ◀ to select “Delete”, then 



Notes

- You cannot delete while recording or copying.



Tips

To return to the previous screen

Press [RETURN].

To view other pages

Press [▲, ▼, ◀, ▶] to select “Previous” or “Next”, then press [OK].

– You can also press [◀◀, ▶▶] to view other pages.

Multiple editing

Select with [▲, ▼, ◀, ▶], then press [|| PAUSE]. (Repeat.)

– A checkmark appears. Press [|| PAUSE] again to cancel.

- Deleting an item increases the available space by the amount of space taken by the item deleted.

Setting DVD On-Screen Menus

Accessing the DVD On-Screen Menus

DVD

When playing discs, disc settings can be displayed and changed.

Menu options will differ based on disc type and contents.

1  to select the DVD drive.

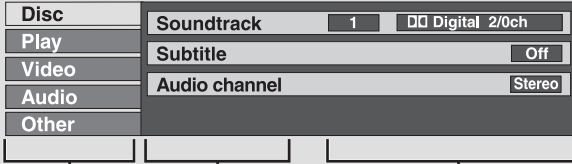
2  

The screenshot shows a menu with the following items and settings:

Disc	Soundtrack	1	Digital 2/0ch
Play	Subtitle	Off	
Video	Audio channel	Stereo	
Audio			
Other			

Labels below the screenshot: Menu (under Disc), Item (under Soundtrack), Setting (under 1).

3 ▲, ▼ to select a menu, then ►.

4 ▲, ▼ to select an item, then ►.

5 ▲, ▼ to select a setting.
Follow the on-screen prompts to change individual settings.



Notes

Some settings may not be changeable, based on the unit's current activity (playing, stopped, etc.) and disc contents.



Tips

To exit the DVD on-screen menus
Press [DISPLAY].

Disc Menu

RAM -R -R DL -RW(V) +R +R DL +RW DVD-V -RW(VR) and **DivX**

Soundtrack

RAM -R -R DL -RW(V) +R +R DL +RW -RW(VR)

The disc's audio attributes appear (→ right, Audio attributes).

DVD-V

Select the audio and language (→ right, Audio attributes, Soundtrack/Subtitle language).

DivX

Select the soundtrack number.

- Soundtrack numbers are displayed even when there is only one audio type.

Subtitle

RAM -R -R DL -RW(V) +R +R DL +RW -RW(VR)

(Only disc that contain subtitle on/off information)

Turn the subtitle on/off.

- Subtitle on/off information cannot be recorded using this unit.
- If the subtitles overlap the closed captions recorded on discs, turn the subtitles off.

DVD-V

Turn the subtitle on/off and select the language (→ below, Soundtrack/Subtitle language).

DivX

Turn the subtitle on/off and select the subtitle number.

- Subtitle numbers are displayed even if there are not multiple subtitles.

Audio channel

RAM -RW(VR) and **DivX**

"Changing Audio during Playback" (→ 31)

Angle

DVD-V

Change the number to select an angle.

Source Select (DivX)

- Automatic: The recording method of the DivX contents is automatically distinguished and output.
- Interlace: Select when the disc contents were recorded using interlace.
- Progressive: Select when the disc contents were recorded using progressive.

Soundtrack/Subtitle language

CES: Czech	MAL: Malay
CHI: Chinese	NLD: Dutch
DAN: Danish	NOR: Norwegian
DEU: German	POL: Polish
ENG: English	POR: Portuguese
ESP: Spanish	RUS: Russian
FIN: Finnish	SLK: Slovak
FRA: French	SVE: Swedish
HUN: Hungarian	THA: Thai
ITA: Italian	VIE: Vietnamese
JPN: Japanese	*: Others
KOR: Korean	

Audio attributes

LPCM/Digital/DTS/MPEG: Signal type

k (kHz): Sampling frequency

b (bit): Number of bits

ch (channel): Number of channels



Notes

- You cannot make a change when there is no recording.
- Some discs allow changes to soundtracks, subtitles, and angles only by using the disc's menus (→ 30).

Play Menu

RAM -R -R DL -RW(V) +R +R DL +RW DVD-V -RW(VR) CD

Repeat play

This function works only when the elapsed play time is displayed. Select the item for repeat play. Depending on the disc, the items that can be selected will differ.

Select "Off" to cancel.

Video Menu

RAM -R -R DL -RW(V) +R +R DL +RW DVD-V -RW(VR) and **DivX**

Picture

RAM -R -R DL -RW(V) +R +R DL +RW DVD-V -RW(VR)

Set picture mode

Normal: Default setting

Cinema: Mellows down movies, enhances detail in dark scenes.

DNR (Digital Noise Reduction)

RAM -R -R DL -RW(V) +R +R DL +RW DVD-V -RW(VR) and **DivX**

"On" reduces noise and picture degradation.

Progressive*1 (Progressive/24p*2)

Select the method of conversion for progressive output to suit the type of material being played.

Auto1 (normal): Film and video contents are detected automatically and converted properly.

Auto2: When using "Auto1" and video content is distorted as shown below.

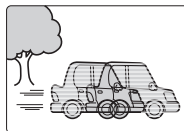

24p*2: **DVD-V** When this unit is connected to a TV supporting 1080/24p output via an HDMI cable, this unit displays each frame at 1/24 second intervals – the frame interval originally recorded in the film, thus faithfully reproducing the original cinema image.

If the settings are changed, then the screen will darken for a few seconds and then playback will start.

"Auto1" is set when you turn the unit off or open disc tray.

*1Only when you have selected "480p" or higher for "Component Output Signal" (→ 64) or "HDMI Resolution" (→ 65)

*2Only when you have selected "On" in "24p Output for DVD-Video" in Setup menu (→ 65)

Line-in NR (Only when IN1 or IN2 is selected)

Reduces video tape noise during recording. Depending on the video signal, jittering may occur.

On: Noise reduction works for any video input.

Off: Noise reduction is off. Select when you want to record input as is.

Audio Menu

RAM -R -R DL -RW(V) +R +R DL +RW DVD-V -RW(VR) and **DivX**

V. Surround Sound (Dolby Digital with 2.0 or more channels only)

RAM -R -R DL -RW(V) +R +R DL +RW DVD-V -RW(VR)

This function does not work for SAP recordings.

- Enjoy a surround-sound effect if you are using 2 front speakers (L/R) only.
- Turn off if it causes distortion.

Natural/Emphasis/Off

Dialog Enhancer (Dolby Digital, 3-channel or more only, including a center channel)

RAM -R -R DL -RW(V) +R +R DL +RW DVD-V -RW(VR) and **DivX**

When "On", the volume of the center channel is raised to make dialogue easier to listen.

Other Menu

Signal meter

Allows you to check the strength of the digital broadcast signal.

- Only the strength of the digital broadcast received through the antenna is displayed accurately.

Position

Change where this menu screen appears on your TV.

Language code list

Enter the code with the numbered buttons.

Abkhazian: 6566	Hausa: 7265	Romanian: 8279
Afar: 6565	Hebrew: 7387	Russian: 8285
Afrikaans: 6570	Hindi: 7273	Samoan: 8377
Albanian: 8381	Hungarian: 7285	Sanskrit: 8365
Amharic: 6577	Icelandic: 7383	Scots Gaelic: 7168
Arabic: 6582	Indonesian: 7378	Serbian: 8382
Armenian: 7289	Interlingua: 7365	Serbo-Croatian: 8372
Assamese: 6583	Irish: 7165	Shona: 8378
Aymara: 6589	Italian: 7384	Sindhi: 8368
Azerbaijani: 6590	Japanese: 7465	Singhalese: 8373
Bashkir: 6665	Javanese: 7487	Slovak: 8375
Basque: 6985	Kannada: 7578	Slovenian: 8376
Bengali, Bangla: 6678	Kashmiri: 7583	Somali: 8379
Bhutani: 6890	Kazakh: 7575	Spanish: 6983
Bihari: 6672	Kirghiz: 7589	Sundanese: 8385
Breton: 6682	Korean: 7579	Swahili: 8387
Bulgarian: 6671	Kurdish: 7585	Swedish: 8386
Burmese: 7789	Laotian: 7679	Tagalog: 8476
Byelorussian: 6669	Latin: 7665	Tajik: 8471
Cambodian: 7577	Latvian, Lettish: 7686	Tamil: 8465
Catalan: 6765	Lingala: 7678	Tatar: 8484
Chinese: 9072	Lithuanian: 7684	Telugu: 8469
Corsican: 6779	Macedonian: 7775	Thai: 8472
Croatian: 7282	Malagasy: 7771	Tibetan: 6679
Czech: 6783	Malay: 7783	Tigrinya: 8473
Danish: 6865	Malayalam: 7776	Tonga: 8479
Dutch: 7876	Maltese: 7784	Turkish: 8482
English: 6978	Maori: 7773	Turkmen: 8475
Esperanto: 6979	Marathi: 7782	Twì: 8487
Estonian: 6984	Moldavian: 7779	Ukrainian: 8575
Faroese: 7079	Mongolian: 7778	Urdu: 8582
Fiji: 7074	Nauru: 7865	Uzbek: 8590
Finnish: 7073	Nepali: 7869	Vietnamese: 8673
French: 7082	Norwegian: 7879	Volapük: 8679
Frisian: 7089	Oriya: 7982	Welsh: 6789
Galician: 7176	Pashto, Pushto: 8083	Wolof: 8779
Georgian: 7565	Persian: 7065	Xhosa: 8872
German: 6869	Polish: 8076	Yiddish: 7473
Greek: 6976	Portuguese: 8084	Yoruba: 8979
Greenlandic: 7576	Punjabi: 8065	Zulu: 9085
Guarani: 7178	Quechua: 8185	
Gujarati: 7185	Rhaeto-Romance: 8277	

DVD and Card Management

Accessing the Management Menus

Preparation:

- **RAM SD** Release protection (disc, cartridge, card → right).
- Insert a disc or card.

1  to select the drive (DVD or SD).

2 With the unit stopped



3 ▲, ▼ to select “Other Functions” then 

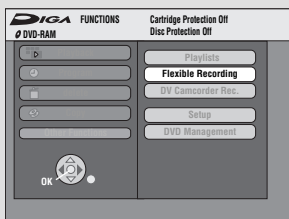

4 ▲, ▼ to select “DVD Management” or “Card Management”, then 

SD The only menu available in “Card Management” is “Format memory card”.

Tips

To return to the previous screen
Press [RETURN].

To exit the screen
Press [RETURN] several times.

Naming Discs

RAM -R -R DL -RW(V) +R +R DL +RW

Perform preparation steps 1–4 of “Accessing the Management Menus” (→ left).

5 ▲, ▼ select “Disc Name”, then



–You can give a name for the disc (→ 42).



Tips

- The disc name is displayed in the DVD MANAGEMENT window.
- With finalized discs and +RW, the name is displayed on the Top Menu.

Setting Protection

RAM

Perform preparation steps 1–4 of “Accessing the Management Menus” (→ left).

5 ▲, ▼ select “Disc Protection” then 

6 ◀ to select “Yes” then 

Protection of cartridge disc or card

RAM (With a cartridge)

With the write-protect tab in the protect position, you cannot record to, edit, format, or delete from the disc.

SD

Switch the write-protect switch to the “LOCK” position.





Deleting All Recordings

Important: Once deleted, contents cannot be recovered.

RAM

Perform preparation steps 1–4 of “Accessing the Management Menu” (→ 52).

5 ▲, ▼ to select “Delete All Recordings” then 

6 ◀ to select “Yes” then 

7 ◀ to select “Start” then 
–A message appears when deleting is finished.

8  to complete.



Notes

Deleting does not work if one or more recordings are protected.

Formatting Discs or Cards

Important: Once formatted, contents cannot be recovered.

RAM -RW(V) +RW -RW(VR) SD

Perform preparation steps 1–4 of “Accessing the Management Menu” (→ 52).

5 ▲, ▼ to select “Format Disc (DVD)” or “Format memory card” then 

6 ◀ to select “Yes” then 

7 ◀ to select “Start” then 
–Formatting starts (RAM may take up to a maximum of 70 minutes).
–A message appears when formatting is finished.

8  to complete.



Notes

- Do not disconnect the AC power supply cord while formatting. This can render the disc or the card unusable.
- When a disc or card has been formatted using this unit, it may not be possible to use it on any other equipment.
- **-R -R DL +R +R DL CD USB** Formatting cannot be performed.
- **-RW(V) -RW(VR)** You can format only as DVD-Video format on this unit.
- **RAM** Pressing [RETURN] during format will cancel the process. The disc must be reformatted if you do this.
- **RAM SD** The disc or card cannot be formatted if the write-protect tab or switch (→ 52) is switched to “PROTECT” or “LOCK”. Release the protection to continue.
- The message “Unable to format.” appears when trying to format discs the unit cannot use.

DVD and Card Management

Selecting Whether to Show the Top Menu First

-R -R DL -RW(V) +R +R DL +RW

Before finalizing a disc, select whether to show the Top Menu after finalizing.

Perform preparation steps 1–4 of “Accessing the Management Menus” (→ 52).

5 ▲, ▼ to select “Playback will start with:”, then 

6 ▲, ▼ to select desired item, then



- DVD's Top Menu:
The Top Menu appears first.
- First Recording:
The disc content is played without displaying the Top Menu.

Finalizing

-R -R DL -RW(V) +R +R DL

You can play these discs on compatible DVD players by finalizing it on the unit.

The menu you create with the unit can also be used on most DVD players.

Perform preparation steps 1–4 of “Accessing the Management Menus” (→ 52).

5 ▲, ▼ to select “Finalize”, then



6 ◀ to select “Yes”, then 

7 ◀ to select “Start”, then 

- Finalizing starts and cannot be canceled (may take up to 15 minutes).
(**-R DL +R DL** up to 60 minutes)
- A message appears when finalizing is finished.

8  to complete.

Notes

- Do not disconnect the AC power supply cord while finalizing. This can render the disc unusable.
 - When finalizing a high-speed recording compatible disc, it may take longer than displayed on the confirmation screen (approximately 4 times longer).
 - After finalizing
 - **-R -R DL +R +R DL** The disc becomes play-only and you can no longer record or edit it.
 - **-RW(V)** You can record and edit the disc after formatting although it becomes play-only after finalizing.
 - The disc finalized by this unit may not be able to play on other units depending on the condition of the recording.
 - There is a pause of several seconds between recordings and chapters during playback.
 - Recordings are divided into about 5-minute chapters* (**+R +R DL** 8 minutes)
- * This time varies greatly depending on the condition and mode of recording.

Tips

After you have finished recording and try to eject the disc, a screen asking if you want to finalize the disc appears (→ 25).

Create DVD Top Menu

+RW

+RW discs contain no Top Menu Data. Top Menu is a convenient function. We recommend creating the menu before playing a +RW disc on other equipment.

Perform preparation steps 1–4 of “Accessing the Management Menus” (→ 52).

5 ▲, ▼ to select “Create DVD Top Menu”, then 

6 ◀ to select “Start”, then 

7 ◀ to select “Start”, then 

- “Create DVD Top Menu” cannot be canceled once started.
- “Create DVD Top Menu” takes a few minutes.

8  to complete.

Notes

- Recording or editing on the disc may delete the Top menu. In that case, create the Top menu again.
- You cannot use the Top menu for playing on this unit.

Setup Menus

“Accessing the Setup Menu”

You will have to perform the following 3 steps for all other operations on page 55–66.

- 1** With the unit stopped



- 2** ▲, ▼ to select “Other Functions”, then 

- 3** ▲, ▼ to select “Setup”, then 



Notes

Changed settings remain intact even when switching the unit to standby.



Tips

To return to the previous screen

Press [RETURN]. Even if you have changed an option, the change is not activated until you press [OK].

To exit the screen

Press [RETURN] several times.

Set Channels Automatically

The channels are automatically set.

Select to suit the type of antenna you are using.

Perform steps 1–3 of “Accessing the Setup Menu” (→ above).

- 4** ▲, ▼ to select “Channel” then ►

- 5** ▲, ▼ to select “Set Channels Automatically”, then 

- 6** ▲, ▼ to select “Antenna” or “Cable”, then 

–When a TV (VIERA) supporting HDAVI Control 3 is connected via an HDMI cable, the following options will be displayed.

[Set Channels via VIERA Link] You can acquire the VIERA setting information
[Set Channels without VIERA Link]

- 7**  to complete.

Set Channels Manually

The captions you select or modify are used as channel names and displayed on the Direct Navigator screen.

Perform steps 1–3 of “Accessing the Setup Menu” (→ left).

- 4** ▲, ▼ to select “Channel”, then ►

- 5** ▲, ▼ to select “Set Channels Manually”, then 

- 6** ▲, ▼ to select channel.

–You can also select channels with the numbered buttons.

–You can also press [◀◀, ▶▶] to skip several lines.

Adding and Deleting Channels

To add channels, delete undesired channels, or channels that have poor reception.

After selecting a channel (→ above, step 6).

- 7** ◀, ▶ to select the “Add/Del” column.

- 8** ▲, ▼ to select “Added” or “Deleted”.

– After selecting the “Channel” column with [◀, ▶], repeat steps 6–8 to set other channels.

Setting favorite channels

You can define a Favorite list.

After selecting a channel (→ above, step 6).

- 7** ◀, ▶ to select the “Favorite” column, then 

- 8** ▲, ▼ to select the position on the list, then 

- 9**  to complete.

– After selecting the “Channel” column with [◀, ▶], repeat steps 6–9 to set other channels.

Setup Menus

Selecting the caption

After selecting a channel (→ 55, step 6, "Set Channels Manually").

7 ◀, ▶ to select the "Caption" column.

8 ▲, ▼ to select the caption.
– After selecting the "Channel" column with [◀, ▶], repeat steps 6–8 to set other channels.

Modifying the caption

After selecting a channel (→ 55, step 6, "Set Channels Manually").

7 ◀, ▶ to select the "Caption" column, then 

8 ▲, ▼ to select a character, then ▶ to move to the next character.
– Repeat this step to enter other characters.

9  to confirm changes.
– After selecting the "Channel" column with [◀, ▶], repeat steps 6–9 to set other channels.



Notes

Available characters for channel captions

A–Z, a–z, 0–9, _, -, (space)

Surf Mode

Select a channel group from which a channel can be selected with [CH ▲, ▼].

Perform steps 1–3 of "Accessing the Setup Menu" (→ 55).

4 ▲, ▼ to select "Channel", then ▶

5 ▲, ▼ to select "Surf Mode", then 

6 ▲, ▼ to select "All" or "Favorite", then 

[All] To select a channel from all of the channels set.
[Favorite] To select a channel from favorite channels.

Parental Rating

The V-chip systems (→ 57, Notes) used in this unit allows you to limit viewing and recording of certain programs that may contain scenes unsuitable for children. If the unit starts receiving a broadcast with the set rating information, a password screen appears and you will be unable to view or record until you enter the password. You can view or record after entering your password.

Perform steps 1–3 of "Accessing the Setup Menu" (→ 55).

4 ▲, ▼ to select "Channel", then ▶

5 ▲, ▼ to select "Parental Rating", then 

6 ▲, ▼ to select the rating, then 

- U.S TV Rating: U.S TV program ratings
- MPAA Rating: U.S movie ratings
- CELR Rating: Canadian English ratings
- CFLR Rating: Canadian French ratings
- Other: Only displayed when the unit has downloaded new rating from digital broadcast. Set in accordance with the instructions on the screen.

7 ▲, ▼, ◀, ▶ to select "On" for "Set".

e.g., U.S. TV Rating

Setup	U.S. TV Rating			
	Set	On		
Channel	TV-NR	Viewable		
Setup	TV-Y	Viewable		
Disc	TV-Y7	Viewable		
Video	TV-G	Viewable		
Audio	TV-PG	D	L	S
Display	TV-14	D	L	S
TV Screen	TV-MA	L	S	V
VHS				

- For details about ratings (→ 67, Parental Rating List)

8 ◀, ▶ to move to "Set", then ▲, ▼ to select the rating item, then ▶.

9 ▲, ▼ to select the limitation.
– The limitation options that appear depend on the rating you select in step 6. Select "Viewable", "--", or "Off" to cancel.

10 ◀, then 

11 Enter a 4-digit password with the numbered buttons, then 

– A screen appears confirming that you have set a password. Press [OK].
If you select “Off” for “Set”:
A screen appears confirming that you haven’t set a rating. Press [OK].

To change the password

After selecting “Parental Rating” (→ 56, step 5).

6 Enter a 4-digit password with the numbered buttons, then 

7 ▲, ▼ to select “Change Password”, then 

8 Enter the new password with the numbered buttons, then 

– A screen appears confirming that you have set a password. Press [OK].

Tips

To clear the password
(→ 81, To reset the ratings level settings)

Notes

- Recording may fail when a wrong password was entered for scheduled recording settings.
- “V-chip” technology enables restricted shows to be locked according to TV ratings.
- The V-chip system that is used in this set is capable of blocking “NR” programs (non rated, not applicable and none) as per FCC Rules Section 15.120(e)(2). If the option of blocking “NR” programs is chosen “unexpected and possibly confusing results may occur, and you may not receive emergency bulletins or any of the following types of programming:”
 - Emergency Bulletins (Such as EAS messages, weather warnings and others)
 - Locally originated programming
 - News ●Political
 - Public Service Announcements
 - Religious ●Sports ●Weather

Off Timer

Select how long the unit remains on when it is not being used. Perform steps 1–3 of “Accessing the Setup Menu” (→ 55).

4 ▲, ▼ to select “Setup”, then ▶

5 ▲, ▼ to select “Off Timer”, then 

6 ▲, ▼ to select “2 Hours”, “6 Hours” or “Off”, then 

Remote Control

Use this function to synchronize the codes for the remote control and the main unit.

Perform steps 1–3 of “Accessing the Setup Menu” (→ 55).

4 ▲, ▼ to select “Setup”, then ▶

5 ▲, ▼ to select “Remote Control”, then 

6 ▲, ▼ to select “Set Code 1”, “Set Code 2”, or “Set Code 3” then  to set.

7 While pressing and holding , press and hold the numbered button **1**, **2**, or **3** corresponding to the code set in step 6 for about 5 seconds to set.

8  to complete.

Clock Settings

Perform steps 1–3 of “Accessing the Setup Menu” (→ 55).

4 ▲, ▼ to select “Setup”, then ▶

5 ▲, ▼ to select “Clock Settings”, then 

Setup Menus

Set Clock Automatically

After selecting "Clock Settings" (→ 57, step 5).

6 ▲, ▼ to select "Set Clock Automatically", then 

7  to start auto setting.

The following screen appears when the setting is complete.



8  to complete.



Notes

- This may take some time, up to a few hours in some cases.
- If the following message appears

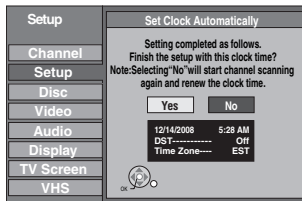

If the time is correct, press [◀] to select "Yes", then press [OK].

– If you select "No", auto setting starts again, then the above screen reappears. Repeat this step until the correct time appears.

- If the clock is not correct, set the clock with "Adjust Time Zone" (→ right) or "Set Clock Manually" (→ below).



Tips

To cancel in the middle
Press [RETURN].

Set Clock Manually

After selecting "Clock Settings" (→ 57, step 5).

6 ▲, ▼ to select "Set Clock Manually", then 

7 ◀, ▶ to select the item you want to change.

8 ▲, ▼ to change the setting.
–Repeat steps 7–8 to change other items.

9  to confirm new date and time and to initiate the clock.

Set the time change dates for DST

Set the beginning and end dates for DST. (→ 13).

Adjust Time Zone

Adjust the time zone (–1 or 1) if it was not set correctly with auto clock setting. You can set this menu only after "Set Clock Automatically" is completed. (→ left).

After selecting "Clock Settings" (→ 57, step 5).

6 ▲, ▼ to select "Adjust Time Zone", then 

7 ▲, ▼ to select "–1" or "1", then 

Quick Start

1 Sec. Quick Start for Recording on DVD-RAM. From the power off state, recording on DVD-RAM starts about 1 second after first pressing the [DVD/VHS POWER] and then sequentially pressing [● REC] (Quick Start Mode). Power consumption is also higher when the unit is turned off if this is set to "On".

Perform steps 1–3 of "Accessing the Setup Menu" (→ 55).

4 ▲, ▼ to select "Setup", then ▶

5 ▲, ▼ to select "Quick Start", then 

6 ▲, ▼ to select "On" or "Off", then 

DivX Registration

You need this registration code to purchase and play DivX Video-on-Demand (VOD) content (→ 36).

Perform steps 1–3 of "Accessing the Setup Menu" (→ 55).

4 ▲, ▼ to select "Setup", then ▶

5 ▲, ▼ to select "DivX Registration", then 

Restore Default Settings

This returns Setup menus to default settings, except for the clock, channel settings, ratings level, closed caption, and on-screen language.

Perform steps 1–3 of “Accessing the Setup Menu” (→ 55).

4 ▲, ▼ to select “Setup”, then ►

5 ▲, ▼ to select “Restore Default Settings”, then 

6 ▲, ▼ to select “Yes” or “No”, then 

Settings for Playback

Perform steps 1–3 of “Accessing the Setup Menu” (→ 55).

4 ▲, ▼ to select “Disc”, then ►

5 ▲, ▼ to select “Settings for Playback”, then 

Ratings

Set a ratings level to limit DVD-Video play.

Follow the on-screen instructions. Enter a 4-digit password with the numbered buttons when the password screen is shown.

After selecting “Settings for Playback” (→ above, step 5).

6 ▲, ▼ to select “Ratings”, then 

7 ▲, ▼ to select ratings limit, then 

8 Enter a 4-digit password, then 

– Do not forget your password.

- Setting ratings (When level 8 is selected)
 - [8 No Limit] All DVD-Video can be played.
 - [1] to [7] Prohibits play of DVD-Video with corresponding ratings recorded on them.
 - [0 Lock All] Prohibits play of all DVD-Video.
- Changing ratings (When level 0 to 7 is selected)
 - [Unlock Recorder] [Change Password] [Change Level] [Temporary Unlock]

Audio Language

After selecting “Settings for Playback” (→ left, step 5).

6 ▲, ▼ to select “Audio Language”, then 

7 ▲, ▼ to select “English”, “French”, “Spanish”, “Original”, “Other ****”, then 

Subtitle Language

After selecting “Settings for Playback” (→ left, step 5).

6 ▲, ▼ to select “Subtitle Language”, then 

7 ▲, ▼ to select “Automatic”, “English”, “French”, “Spanish”, “Other ****”, then 

Menu Language

After selecting “Settings for Playback” (→ left, step 5).

6 ▲, ▼ to select “Menu Language”, then 

7 ▲, ▼ to select “English”, “French”, “Spanish”, “Other ****”, then 



Notes

DVD-V Choose the language for audio, subtitles and disc menus.

If a language which is not recorded is selected, or if languages are already fixed on the disc, the language set as the default on the disc will be played instead.

[Original] The original language of each disc will be selected.

[Other ****] This is the language code setting. Input a code number with the numbered buttons (→ 51, “Language code list”).

[Automatic] If the language selected for “Audio Language” is not available, subtitles of that language will automatically appear if available on the disc.

Setup Menus

Settings for Recording

Recording Time in EP Mode

Select the maximum number of hours for recording in EP mode.
Perform steps 1–3 of “Accessing the Setup Menu” (→ 55).

4 ▲, ▼ to select “Disc”, then ►

5 ▲, ▼ to select “Settings for Recording”, then 

6 

7 ▲, ▼ to select “EP-Extended Play (6H)” or “EP-Extended Play (8H)”, then 

[EP-Extended Play (6H)]

You can record for 6 hours on an unused 4.7 GB disc.

[EP-Extended Play (8H)]

You can record for 8 hours on an unused 4.7 GB disc.

Still Mode (paused video)

Select the type of picture shown when you pause play (→ 91, “Frame and field”).
Perform steps 1–3 of “Accessing the Setup Menu” (→ 55).

4 ▲, ▼ to select “Video”, then ►

5 ▲, ▼ to select “Still Mode (paused video)”, then 

6 ▲, ▼ to select “Automatic”, “Field” or “Frame”, then 

[Field] Select if jittering occurs when “Automatic” is selected.

[Frame] Select if you cannot see small text or fine patterns clearly when “Automatic” is selected.

Black Level Control

Select “Lighter” or “Darker” to adjust the black level control to the desired setting for picture enhancement.
Perform steps 1–3 of “Accessing the Setup Menu” (→ 55).

4 ▲, ▼ to select “Video”, then ►

5 ▲, ▼ to select “Black Level Control”, then 

Input Level

Adjusts the black level of the input signal.
After selecting “Black Level Control” (→ above, step 5).

6 ▲, ▼ to select “Input Level”, then 

7 ▲, ▼ to select “Lighter” or “Darker”, then 

Output Level (Composite/SVideo)

Adjusts the black level of the output signal from the VIDEO OUT and S VIDEO OUT terminal.
After selecting “Black Level Control” (→ above, step 5).

6 ▲, ▼ to select “Output Level (Composite/SVideo)”, then 

7 ▲, ▼ to select “Lighter” or “Darker”, then 

Dynamic Range Compression

DVD-V (Dolby Digital only)

Change the dynamic range (→ 91) for easier listening at a low volume.

Perform steps 1–3 of “Accessing the Setup Menu” (→ 55).

4 ▲, ▼ to select “Audio”, then ►

5 ▲, ▼ to select “Dynamic Range Compression”, then 

6 ▲, ▼ to select “On” or “Off”, then 

Multi-channel TV Sound (Analog)

-R -R DL -RW(V) +R +R DL +RW

Select whether to record the main or secondary audio program (SAP) when recording to these discs. (You cannot select the audio type on the unit when recording audio from an external device. Select it on the external device.)

Perform steps 1–3 of “Accessing the Setup Menu” (→ 55).

4 ▲, ▼ to select “Audio”, then ►

5 ▲, ▼ to select “Multi-channel TV Sound (Analog)”, then 

6 ▲, ▼ to select “Main” or “Secondary Audio Program (SAP)”, then 

Multi-channel TV Sound (Digital)

Select the preferred digital broadcast language.

Perform steps 1–3 of “Accessing the Setup Menu” (→ 55).

4 ▲, ▼ to select “Audio”, then ►

5 ▲, ▼ to select “Multi-channel TV Sound (Digital)”, then 

6 ▲, ▼ to select “English”, “French” or “Spanish”, then 

Digital Audio Output

Change the settings when you have connected equipment through the unit’s DIGITAL AUDIO OUT terminal (→ 72).

Perform steps 1–3 of “Accessing the Setup Menu” (→ 55).

4 ▲, ▼ to select “Audio”, then ►

5 ▲, ▼ to select “Digital Audio Output”, then 

PCM Down Conversion

Select how to output audio with a sampling frequency of 96 kHz or 88.2 kHz. Signals are converted to 48 kHz or 44.1 kHz despite the settings if the signals have a sampling frequency of over 96 kHz or 88.2 kHz, or the disc has copy protection.

After selecting “Digital Audio Output” (→ left, step 5).

6 ▲, ▼ to select “PCM Down Conversion”, then 

7 ▲, ▼ to select “On” or “Off”, then 

[On] Signals are converted to 48 kHz or 44.1 kHz. (Choose when the connected equipment cannot process signals with sampling frequency of 96 kHz or 88.2 kHz.)

[Off] Signals are output as 96 kHz or 88.2 kHz. (Choose when the connected equipment can process signals with sampling frequency of 96 kHz or 88.2 kHz.)

Dolby Digital*

Choose whether to output by “Bitstream”, which processes Dolby Digital signals on other connected equipment, or to convert the signals to “PCM” (2ch) on the unit before output.



After selecting “Digital Audio Output” (→ left, step 5).

6 ▲, ▼ to select “Dolby Digital”, then 

7 ▲, ▼ to select “Bitstream” or “PCM”, then 

[Bitstream] When you have connected the unit to equipment displaying the Dolby Digital logo.

[PCM] When you have connected the unit to equipment that doesn’t have Dolby Digital logo.

* Incorrect settings can cause noise to be output which can be harmful to your ears and speakers, and audio will not be recorded properly on media such as mini discs.

Setup Menus

DTS*

Choose whether to output by “Bitstream”, which processes DTS signals on other connected equipment, or to convert the signals to “PCM” (2ch) on the unit before output.



After selecting “Digital Audio Output” (→ 61, step 5).

6 ▲, ▼ to select “DTS”, then

7 ▲, ▼ to select “Bitstream” or “PCM”, then

[Bitstream] When you have connected the unit to equipment displaying the DTS logo.

[PCM] When you have connected the unit to equipment that doesn't have the DTS logo.

Select Audio Channel For DV Input

You can select the kind of audio when recording from the unit's DV in terminal (→ 29).

Perform steps 1–3 of “Accessing the Setup Menu” (→ 55).

4 ▲, ▼ to select “Audio”, then ►

5 ▲, ▼ to select “Select Audio Channel For DV Input”, then

6 ▲, ▼ to select “Stereo 1”, “Stereo 2” or “Mix”, then

[Stereo 1] Records audio (L1, R1)

[Stereo 2] Records added audio such as narration (L2, R2) subsequent to original recording.

[Mix] Records both Stereo 1 and Stereo 2.

* Incorrect settings can cause noise to be output which can be harmful to your ears and speakers, and audio will not be recorded properly on media such as mini discs.

Status Messages

Choose whether to show status messages automatically or not.

Perform steps 1–3 of “Accessing the Setup Menu” (→ 55).

4 ▲, ▼ to select “Display”, then ►

5 ▲, ▼ to select “Status Messages”, then

6 ▲, ▼ to select “Automatic” or “Off”, then

On-screen Language

Choose the language for these menus and the on-screen messages.

Perform steps 1–3 of “Accessing the Setup Menu” (→ 55).

4 ▲, ▼ to select “Display”, then ►

5 ▲, ▼ to select “On-screen Language”, then

6 ▲, ▼ to select “English”, “Español” or “Français”, then

Black Background (Analog)

Select whether to show the black (gray) background, normally shown when TV reception is poor.

Perform steps 1–3 of “Accessing the Setup Menu” (→ 55).

4 ▲, ▼ to select “Display”, then ►

5 ▲, ▼ to select “Black Background (Analog)”, then

6 ▲, ▼ to select “On” or “Off”, then

Front Display

Changes the brightness of the unit's display.

Perform steps 1–3 of "Accessing the Setup Menu" (→ 55).

4 ▲, ▼ to select "Display", then ►

5 ▲, ▼ to select "Front Display", then 

6 ▲, ▼ to select "Bright", "Dim" or "Automatic", then 

[Automatic] The display turns dark during playback. When the unit is turned off, the unit's display disappears. While using this mode the standby power consumption can be reduced.

Closed Caption

Choose whether to show closed captions.

Perform steps 1–3 of "Accessing the Setup Menu" (→ 55).

4 ▲, ▼ to select "Display", then ►

5 ▲, ▼ to select "Closed Caption", then 

6 ▲, ▼ to select "Set", then 

7 ▲, ▼ to select "On", then 
– Select "Off" if you don't want closed captions.

Analog (Closed Caption) settings

After selecting "On" (→ above, step 7).

8 ▲, ▼ to select "Analog", then 

9 ▲, ▼ to select the item, then 

CC1–4 Information related to pictures (Appears at bottom of screen)

T1–4 Textual information (Appears over entire screen)

Digital (Closed Caption) settings

After selecting "On" (→ left, step 7).

8 ▲, ▼ to select "Digital", then 

9 ▲, ▼ to select the item, then 

[Primary]	Primary Language
[Secondary]	Secondary Language
[Service 3]	Service 3 Language
[Service 4]	Service 4 Language
[Service 5]	Service 5 Language
[Service 6]	Service 6 Language

Digital (Closed Caption) Detailed settings

After selecting "On" (→ left, step 7).

8 ▲, ▼ to select "Character Settings", then 

9 ▲, ▼ to select the item, then 

[Size]	Text size
[Font]	Text font
[Style]	Text style (Raised, Depressed, etc.)
[Foreground]	Color of text
[Fore Opacity]	Opacity of text
[Background]	Color of text box
[Back Opacity]	Opacity of text box
[Outline]	Outline color of text (Identify the setting options on the screen.)

10 ▲, ▼ to select the option, then 

Resets all settings for closed captions

After selecting "On" (→ left, step 7).

8 ▲, ▼ to select "CC reset", then 

Setup Menus

TV Aspect

This setting allows you to select the type of television connected.

Perform steps 1–3 of “Accessing the Setup Menu” (→ 55).

4 ▲, ▼ to select “TV Screen”, then ▶

5 ▲, ▼ to select “TV Aspect”, then 

6 ▲, ▼ to select “4:3” or “16:9”, then 



Notes

• Aspect 4:3/16:9

4:3

4:3 standard aspect television

16:9

16:9 widescreen television

- Digital programs broadcast in the 16:9 aspect ratio may appear with black bands at the edges of the screen on 4:3 aspect televisions. The bands are added to enable the correct aspect ratio to be shown.

4:3 TV settings for DVD-Video

You can select how to display the image on the TV when you watch 16:9 images (DVD-Video) on a 4:3 standard aspect TV. Perform steps 1–3 of “Accessing the Setup Menu” (→ 55).

4 ▲, ▼ to select “TV Screen”, then ▶

5 ▲, ▼ to select “4:3 TV settings for DVD-Video”, then 

6 ▲, ▼ to select “Pan and Scan (Stretch to fit)” or “Letterbox (Shrink to fit)”, then 

[Pan and Scan (Stretch to fit)]

Video recorded for a widescreen is played with the sides cut off if Pan & Scan was specified. If 16:9 software prohibits Pan & Scan, the image will appear in the letterbox style (with black bands above and below the picture) despite the setting here.

[Letterbox (Shrink to fit)]

Video recorded for a widescreen is played in the letterbox style.

4:3 TV settings for DVD-RAM

You can select how to display the image on the TV when you watch 16:9 images (DVD-RAM) on a 4:3 standard aspect TV.

Perform steps 1–3 of “Accessing the Setup Menu” (→ 55).

4 ▲, ▼ to select “TV Screen”, then ▶

5 ▲, ▼ to select “4:3 TV settings for DVD-RAM”, then 

6 ▲, ▼ to select “4:3”, “Pan and Scan (Stretch to fit)” or “Letterbox (Shrink to fit)”, then 

[4:3]

Recordings are played as recorded.

[Pan and Scan (Stretch to fit)]

Video recorded for a widescreen is played with the sides cut off.

[Letterbox (Shrink to fit)]

Video recorded for a widescreen is played in the letterbox style.

Component Output Signal

If you connected this unit and a TV with component video cables, select the item compatible with the connected equipment.

Perform steps 1–3 of “Accessing the Setup Menu” (→ 55).

4 ▲, ▼ to select “TV Screen”, then ▶

5 ▲, ▼ to select “Component Output Signal”, then 

6 ▲, ▼ to select “480i”, “480p”, “720p” or “1080i”, then 

[720p], [1080i]: Videos from DVD-Video or VHS are output with 480p, irrespective of the settings.

- If the video is distorted when the settings are changed, then press and hold [■] and [▶] on the main unit for 5 seconds or more to set it back to [480i].
- If this unit is connected to an amplifier via an HDMI cable and audio is not output when these settings are changed, then use a non-HDMI cable to connect the unit.
- If this unit is connected to an amplifier, etc. via an HDMI cable with “HDMI Priority” set to “On”, the video will be fixed to 480i. Turn it “Off” and set it again.
- If the “TV Aspect” is set to “4:3” (→ left), then “480i” or “480p” can only be selected.

Functions of HDMI

Perform steps 1–3 of “Accessing the Setup Menu” (→ 55).

4 ▲, ▼ to select “TV Screen”, then
▶

5 ▲, ▼ to select “Functions of HDMI”, then 

HDMI Priority

After selecting “Functions of HDMI” (→ above, step 5).

6 ▲, ▼ to select “HDMI Priority”, then 

7 ▲, ▼ to select “On” or “Off”, then 

[Off] When connecting equipment such as an amplifier with an HDMI cable and connecting TV (compatible with progressive video) with a Component Video Cable

HDMI Resolution*

You can only select items compatible with the connected equipment. This setting normally does not need to be changed. However if you are concerned about output picture quality, it may be improved by changing the setting.

•To enjoy High Quality Video up-converted to 1080p, you need to connect the unit directly to a 1080p-compatible HDTV. If this unit is connected to an HDTV through other equipment, it must also be 1080p compatible.

After selecting “Functions of HDMI” (→ above, step 5).

6 ▲, ▼ to select “HDMI Resolution”, then 

7 ▲, ▼ to select the item, then 

[Auto] Automatically selects the output resolution best suited to the connected television (1080p, 1080i, 720p or 480p).

[480i]

[480p]

[720p]

[1080i]

[1080p]

When setting video output to “1080p”, we recommend using a Panasonic HIGH SPEED HDMI cable to prevent video distortion.

24p Output for DVD-Video*

When this unit is connected to a TV supporting 1080/24p output via an HDMI cable, this unit displays each frame at 1/24 second intervals – the same interval originally shot with the film camera. After selecting “Functions of HDMI” (→ left, step 5).

6 ▲, ▼ to select “24p Output for DVD-Video”, then 

7 ▲, ▼ to select “On” or “Off”, then 

[On] Set to “On” and then set the Progressive/24p in the Video Menu in the On-screen Menu (→ 51) to “24p”. When the video is being output in 24 frames per second, no video is output from a video terminal other than the HDMI terminal.

HDMI Output Display Aspect*

Settings used when 4:3 aspect video is output on the television as 16:9 aspect.

After selecting “Functions of HDMI” (→ left, step 5).

6 ▲, ▼ to select “HDMI Output Display Aspect”, then 

7 ▲, ▼ to select “Full” or “Normal”, then 

[Full] Video output is enlarged to match the screen size.

[Normal] Video is output as 4:3 aspect. Side panels (black bars on the left and right) will appear on the screen.



Notes

Depending on the equipment to connect, some items may be shaded in gray on the display and cannot be selected, or changing settings may be unavailable.

*Above items can be set when you set “HDMI Priority” to “On”.

Setup Menus

HDMI RGB Output Range*

Effective when connected to a device that only supports RGB output.

After selecting "Functions of HDMI" (→ 65, step 5).

6 ▲, ▼ to select "HDMI RGB Output Range", then 

7 ▲, ▼ to select "Standard" or "Enhanced", then 

[Enhanced] When the black and white images are not distinct.

HDMI Audio Output

After selecting "Functions of HDMI" (→ 65, step 5).

6 ▲, ▼ to select "HDMI Audio Output", then 

7 ▲, ▼ to select "On" or "Off", then 

[Off] Audio is output from an amplifier when using the DIGITAL AUDIO OUT terminal (→ 72).

VIERA Link*

After selecting "Functions of HDMI" (→ 65, step 5).

6 ▲, ▼ to select "VIERA Link", then 

7 ▲, ▼ to select "On" or "Off", then 

[On] When "On" is selected, you can operate other "HDAVI Control" compatible devices using "HDAVI Control".

Notes

Depending on the equipment to connect, some items may be shaded in gray on the display and cannot be selected, or changing settings may be unavailable.

* Above items can be set when you set "HDMI Priority" to "On".

Select Tape Length

Set the length of tape you are using so the unit can show the correct remaining time.

Perform steps 1–3 of "Accessing the Setup Menu" (→ 55).

4 ▲, ▼ to select "VHS", then ►

5 ▲, ▼ to select "Select Tape Length", then 

6 ▲, ▼ to select "T120", "T160" or "T180", then 

[T120] T30, T60, T90 and T120 tapes

[T160] T140 and T160 tapes

[T180] T180 tapes

Jet Search

Set the speed for Jet Search (→ 37) when playing EP and VP tapes. It is possible to view the picture recorded in EP or VP mode at approx. 27 or 35 times speed.

Perform steps 1–3 of "Accessing the Setup Menu" (→ 55).

4 ▲, ▼ to select "VHS", then ►

5 ▲, ▼ to select "Jet Search", then 

6 ▲, ▼ to select "×27" or "×35", then 

[×27] Select [×27] if the picture is poor at [×35].

Parental Rating List

U.S. TV Rating (U.S. TV Programs Ratings)

TV-NR	[Viewable] [Blocked]	Not Rated.
TV-Y	[Viewable] [Blocked]	All children. The themes and elements in this program are specifically designed for a very young audience, including children from ages 2–6.
TV-Y7	[FV Blocked] [Viewable] [Blocked]	Directed to older children. Themes and elements in this program may include mild physical or comedic violence, or may frighten children under the age of 7.
TV-G	[Viewable] [Blocked]	General audience. It contains little or no violence, no strong language, and little or no sexual dialogue or situations.
TV-PG	[--]: Viewable [X]: Blocked ●D, L, S, V (all selected) ●Any combination of D, L, S, V	Parental guidance suggested. The program may contain infrequent coarse language, limited violence, some suggestive sexual dialogue and situations.
TV-14	[--]: Viewable [X]: Blocked ●D, L, S, V (all selected) ●Any combination of D, L, S, V	Parents strongly cautioned. This program may contain sophisticated themes, sexual content, strong language and more intense violence.
TV-MA	[--]: Viewable [X]: Blocked ●L, S, V (all selected) ●Any combination of L, S, V	Mature audiences only. This program may contain mature themes, profane language, graphic violence, and explicit sexual content.

[FV]: Fantasy/Cartoon Violence [D]: Dialogue with sexual content [L]: Offensive Language [S]: Sex [V]: Violence

MPAA Rating (U.S. Movie Ratings)

NR	[Viewable] [Blocked]	Not Rated.
MPAA	[Off]	MPAA Rating is set to off.
	[G]	General audiences. All ages admitted.
	[PG]	Parental guidance suggested. Some material may not be suitable for pre-teenagers.
	[PG-13]	Parents strongly cautioned. Some material may be inappropriate for children under 13.
	[R]	Restricted. Under 17 requires accompanying parent or adult guardian.
	[NC-17]	No one 17 and under admitted.
	[X]	Adults only.

CELR Rating (Canadian English Ratings)

E	[Viewable] [Blocked]	Exempt–Exempt programming includes: news, sports, documentaries and other information programming, talk shows, music videos, and variety programming.
CELR	[Off]	CELR Rating is set to off.
	[C]	Programming intended for children under age 8. No offensive language, nudity or sexual content.
	[C8+]	Programming generally considered acceptable for children 8 years and over. No profanity, nudity or sexual content.
	[G]	General programming, suitable for all audiences.
	[PG]	Parental Guidance suggested. Some material may not be suitable for children.
	[14+]	Programming contains themes or content which may not be suitable for viewers under the age of 14. Parents are strongly cautioned to exercise discretion in permitting viewing by pre-teens and early teens.
	[18+]	18+ years old. Programming restricted to adults. Contains constant violence or scenes of extreme violence.

CFLR Rating (Canadian French Ratings)

E	[Viewable] [Blocked]	Exempt–Exempt programming.
CFLR	[Off]	CFLR Rating is set to off.
	[G]	General–Programming intended for audience of all ages. Contains no violence, or the violence content is minimal or is depicted appropriately.
	[8 ans+]	8+ General–Not recommended for young children. Programming intended for a broad audience but contains light or occasional violence. Adult supervision recommended.
	[13 ans+]	Programming may not be suitable for children under the age of 13–Contains either a few violent scenes or one or more sufficiently violent scenes to affect them. Adult supervision strongly suggested.
	[16 ans+]	Programming may not be suitable for children under the age of 16–Contains frequent scenes of violence or intense violence.
		[18 ans+]

Other Settings

Using the Unit's Remote Control to Operate the TV and the Set Top Box (Cable Box, Satellite Receiver, etc.)

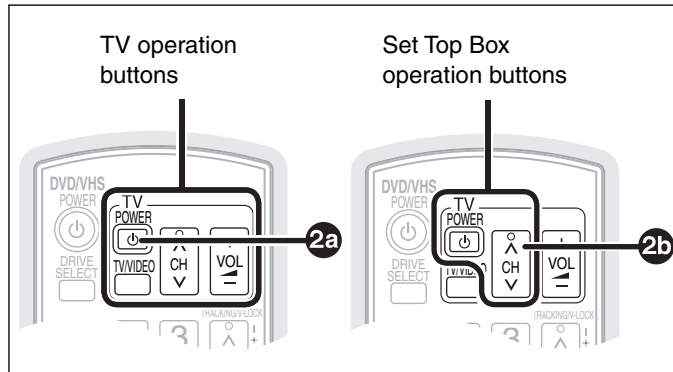

- 1 Point the remote control at the TV or Set Top Box.

To set the code for the TV:

- 2a While pressing and holding , enter the code from the table on the right using the numbered buttons.
e.g., 0250: press [0] → [2] → [5] → [0]

To set the code for the Set Top Box:

- 2b While pressing and holding , enter the code from the table on the right using the numbered buttons.
e.g., 1786: press [1] → [7] → [8] → [6]

- 3 Test the TV or Set Top Box functions of the remote control for operability.

–To switch to the Set Top Box mode:

Press and hold [CH ^] and [RETURN] simultaneously for 5 seconds or longer.

–To switch to the TV mode:

Press and hold [TV POWER] and [RETURN] simultaneously for 5 seconds or longer.

–If the functions do not work, repeat steps 1 to 3 using different codes, if available. Some TVs and Set Top Boxes may not be compatible with the unit's remote control.

Remote Control Codes for the TV

Manufacturer	Code
Panasonic	0051 / 0055 / 0250 / 0650
Advent	0761 / 0783 / 0815 / 0817 / 0842
Akai	0030 / 0098 / 0672 / 0702 / 0812
America Action	0180
AOC	0003 / 0019 / 0030 / 0052 / 0137 / 0185
Apex Digital	0748 / 0765 / 0767 / 0879 / 0890
Audiovox	0003 / 0092 / 0180 / 0451 / 0623 / 0802 / 0875 / 1937
Axion	1937
Bang & Olufsen	0620 / 1620
Broksonic	0003 / 0236 / 0463
Casio	0611 / 1205
Daewoo	0019 / 0039 / 0066 / 0067 / 0091 / 0092 / 0451 / 0623 / 0661 / 0672 / 1661
Emerson	0019 / 0038 / 0039 / 0154 / 0158 / 0171 / 0177 / 0178 / 0179 / 0180 / 0181 / 0182 / 0183 / 0185 / 0236 / 0270 / 0280 / 0282 / 0463 / 0623
Envision	0030 / 0813
Epson	0833 / 0840
Fisher	0154 / 0159
Fujitsu	0179 / 0186 / 0683 / 0809 / 0853
GE	0021 / 0027 / 0029 / 0047 / 0051 / 0055 / 0135 / 0138 / 0174 / 0178 / 0251 / 0279 / 0282 / 0451 / 0747 / 1347 / 1447
Go Video	0886
Haier	0768 / 1034
Hannspree	1348 / 1351 / 1352
Hewlett Packard	1088 / 1089 / 1101 / 1494 / 1502
Hisense	0748
Hitachi	0016 / 0032 / 0038 / 0056 / 0095 / 0097 / 0145 / 0151 / 0173 / 0227 / 0279 / 0409 / 0413 / 1145
InFocus	0736 / 0738 / 0741 / 0752 / 0781 / 1164 / 1516
JVC	0036 / 0053 / 0069 / 0160 / 0169 / 0182 / 0731 / 1253
KLH	0765 / 0767
LG	0178 / 0317 / 0442 / 0457 / 0700 / 0856 / 1178 / 1265
Loewe	0136
Magnavox	0020 / 0024 / 0028 / 0030 / 0036 / 0054 / 0096 / 0179 / 0186 / 0187 / 0230 / 0386 / 0706 / 0802 / 1254 / 1454
Marantz	0030 / 0054 / 0444 / 0704 / 0854 / 0855 / 1154
Memorex	0016 / 0106 / 0150 / 0154 / 0178 / 0179 / 0463
Mitsubishi	0014 / 0019 / 0093 / 0098 / 0150 / 0155 / 0178 / 0331 / 0358 / 0836 / 0868 / 1250
Norcent	0748 / 0824 / 1089
Optoma	0887
Orion	0179 / 0236 / 0463 / 1463
Philips	0054 / 0690 / 1154 / 1454
Philips Magnavox	0020 / 0024 / 0028 / 0030 / 0036 / 0054 / 0096 / 0179 / 0186 / 0187 / 0230 / 0386 / 0690 / 0706 / 0802 / 1154 / 1254 / 1454
Pioneer	0038 / 0166 / 0172 / 0679 / 0866
Polaroid	0765 / 0865 / 1262 / 1276 / 1314 / 1316 / 1326 / 1327 / 1328 / 1341 / 1498 / 1523
Proscan	0047 / 0747 / 1347 / 1447
Proview	0835 / 1401 / 1498
RCA	0018 / 0019 / 0029 / 0038 / 0047 / 0090 / 0135 / 0174 / 0278 / 0679 / 0747 / 1047 / 1147 / 1247 / 1347 / 1447 / 1547
Runco	0017 / 0030 / 0251 / 0497 / 0603
Sampo	0030 / 0032 / 0039 / 0052 / 0100 / 0110 / 1755
Samsung	0019 / 0030 / 0032 / 0056 / 0060 / 0178 / 0329 / 0408 / 0427 / 0587 / 0702 / 0766 / 0812 / 0814 / 1060
Sansui	0463
Sanyo	0088 / 0107 / 0146 / 0154 / 0159 / 0232 / 0484 / 0799 / 0893
Sharp	0039 / 0093 / 0153 / 0157 / 0165 / 0220 / 0281 / 0386 / 0398 / 0491 / 0688 / 0818 / 0851
Sony	0000 / 0011 / 0080 / 0111 / 0273 / 0353 / 0810 / 0834 / 0867 / 1100

■ Remote Control Codes for the TV (Continued)

Manufacturer	Code
Sva	0587 / 0748 / 0768 / 0865 / 0870 / 0871 / 0872
Sylvania	0020 / 0028 / 0030 / 0054 / 0065 / 0096 / 0171 / 0381
Symphonic	0171 / 0180
Syntax-Brilliant	1007 / 1144 / 1240 / 1255 / 1257 / 1258 / 1331
Tatung	0003 / 0049 / 0055 / 0396 / 1101 / 1756
Thomson	0209 / 0210 / 0047
Toshiba	0036 / 0060 / 0149 / 0154 / 0156 / 0650 / 0832 / 0845 / 1156 / 1164 / 1256 / 1265 / 1356 / 1656 / 1704
Ultra	0391
Viewsonic	0857 / 0864 / 0885 / 1755
Westinghouse	0885 / 0889 / 0890 / 1282 / 1577
Yamaha	0019 / 0030 / 0769 / 0833 / 0839
Zenith	0016 / 0017 / 0092 / 0178 / 0463 / 1265

■ Remote Control Codes for the Set Top Box:

Cable Box

Manufacturer	Code
Panasonic	0000 / 0107
ABC	0003 / 0008
Americast	0899
Bell South	0899
Digeo	1187
Director	0476
General Instrument	0003 / 0276 / 0476 / 0810
GoldStar	0144
Hamlin	0009 / 0273
Jerrold	0003 / 0276 / 0476 / 0810
Memorex	0000
Motorola	0276 / 0476 / 0810 / 1187 / 1376
Pace	0008 / 0237 / 1877
Paragon	0000
Philips	0317 / 1305
Pioneer	0144 / 0533 / 0877 / 1877
Pulsar	0000
Quasar	0000
Regal	0273 / 0279
Runco	0000
Samsung	0144
Scientific Atlanta	0008 / 0477 / 0877 / 1877
Sony	1006
Starcom	0003
Supercable	0276
Torx	0003
Toshiba	0000
Zenith	0000 / 0525 / 0899

Satellite Receiver

Manufacturer	Code
Panasonic	0152 / 0247 / 0701 / 1786
AlphaStar	0772
Chaparral	0216
Crossdigital	1109
DirecTV	0099 / 0247 / 0392 / 0566 / 0639 / 0724 / 0749 / 0819 / 1076 / 1108 / 1109 / 1142 / 1377 / 1392 / 1414 / 1442 / 1443 / 1444 / 1609 / 1639 / 1640 / 1749 / 1856
DISH Network	0775 / 1005 / 1170 / 1505 / 1775
Dishpro	0775 / 1005 / 1505 / 1775
Echostar	0775 / 1005 / 1170 / 1505 / 1775
Expressvu	0775 / 1775
GE	0392 / 0566
General Instrument	0869
GOI	0775 / 1775
Goodmans	1246
Hisense	1535
Hitachi	0819 / 1250
HTS	0775 / 1775
Hughes	0749 / 1442 / 1749

Satellite Receiver (Continued)

Manufacturer	Code
Hughes Network Systems	0749 / 1142 / 1442 / 1443 / 1444 / 1749
iLo	1535
Janeil	0152
Jerrold	0869
JVC	0775 / 1170 / 1775
LG	1226 / 1414
Magnavox	0722 / 0724
Memorex	0724
Mitsubishi	0749
Motorola	0856 / 0869
NEC	1270
Next Level	0869
Paysat	0724
Philips	0099 / 0722 / 0724 / 0749 / 0819 / 1076 / 1142 / 1442 / 1749
Pioneer	1442
Proscan	0392 / 0566
Proton	1535
RadioShack	0869
RCA	0143 / 0392 / 0566 / 0855 / 1392
Samsung	1108 / 1109 / 1142 / 1276 / 1377 / 1442 / 1609
Sanyo	1219
Sony	0639 / 1639 / 1640
Star Choice	0869
Toshiba	0749 / 0790 / 0819 / 1285 / 1749
UltimateTV	1392 / 1640
Uniden	0722 / 0724
US Digital	1535
USDTV	1535
Voom	0869
Zenith	1856

Cable Box/Digital Video Recorder Combination

Manufacturer	Code
Americast	0899
Digeo	1187
General Instrument	0476 / 0810
Jerrold	0476 / 0810
Motorola	0476 / 0810 / 1187 / 1376
Pace	0237 / 1877
Pioneer	0877 / 1877
Scientific Atlanta	0877 / 1877
Sony	1006
Supercable	0276
TiVo	1142 / 1442 / 1443 / 1444
Zenith	0899

Satellite Receiver / Digital Video Recorder Combination

Manufacturer	Code
DirecTV	0099 / 0392 / 0639 / 1076 / 1142 / 1377 / 1392 / 1442 / 1443 / 1444 / 1640
DISH Network	0775 / 1505
Dishpro	0775 / 1505
Echostar	0775 / 1170 / 1505
Expressvu	0775
Hughes Network Systems	1142 / 1442 / 1443 / 1444
JVC	1170
Motorola	0869
Philips	1142 / 1442
Proscan	0392
RCA	1392
Samsung	1442
Sony	0639 / 1640
Star Choice	0869
TiVo	1142 / 1442 / 1443 / 1444

Connection Options for Improved Playback Quality

You can enjoy a high-quality picture by using the following terminals for connection.

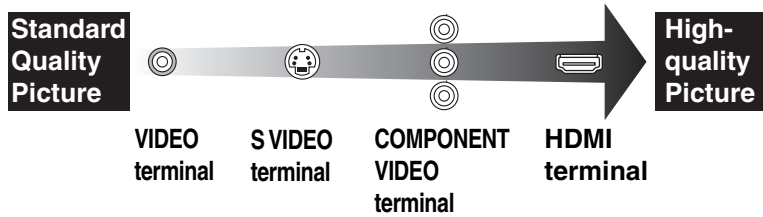

DVD output and DVD/VHS output

The unit has DVD/VHS common output terminals and DVD priority output terminals.

DVD/VHS common output

- Both DVD and VHS signals can be output.
- If connecting with the DVD/VHS common out terminals, closed caption cannot be displayed by this unit while playing a tape. Make the settings and display on a TV that supports Closed Captioning.

DVD priority output

- This is the dedicated terminal to enjoy pictures played on DVD in higher picture quality.
- The DVD priority out terminals can also output the VHS signal. However this is not possible during DVD recording or DVD scheduled recording.

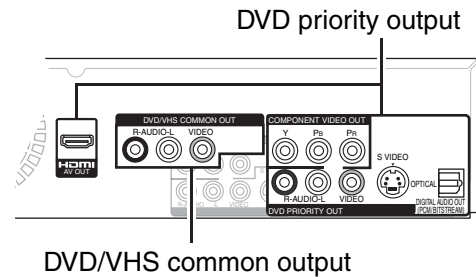

If connecting to the TV with the DVD priority output terminal, we recommend connecting to the TV with the DVD/VHS common output terminals as well.

Using an S Video Cable for Better Video (S Video Cable not included)

The S VIDEO OUT terminal provides a more vivid picture than the VIDEO OUT terminal. (Actual results depend on the television.)

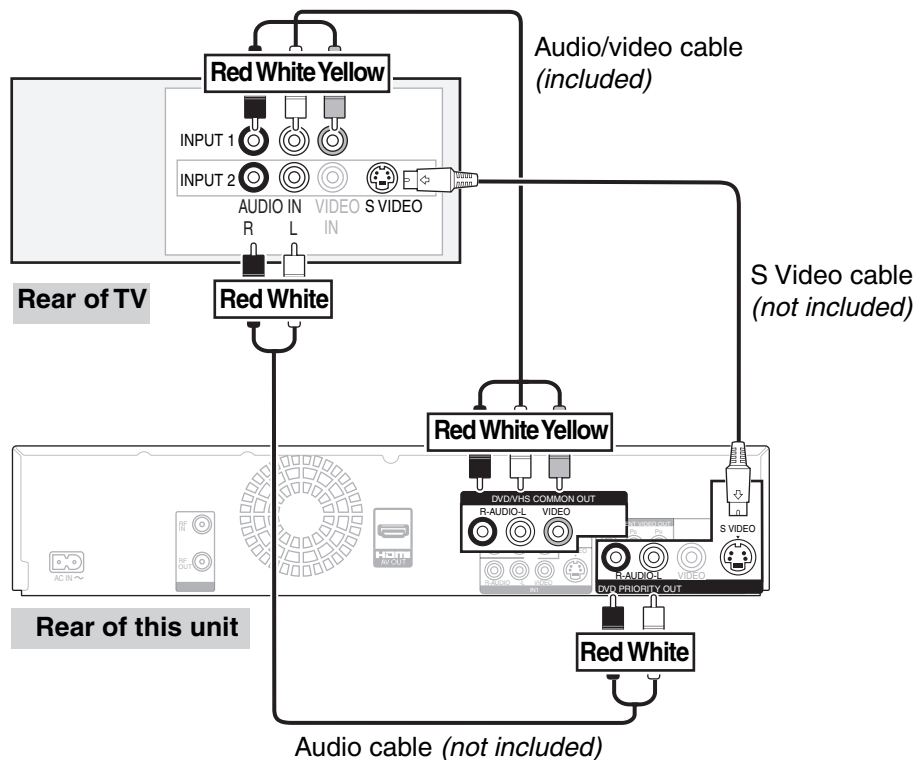

Notes

Usually you can watch video from input 2 on TV. When you want to playback VHS while recording on DVD, switch to input 1 on TV.

Using Component Video Cables for Better Video (Component Video Cables not included)

The COMPONENT VIDEO OUT terminals on this unit can be used for either interlace or progressive output (→ 91) to provide a purer picture than the S VIDEO OUT terminal.

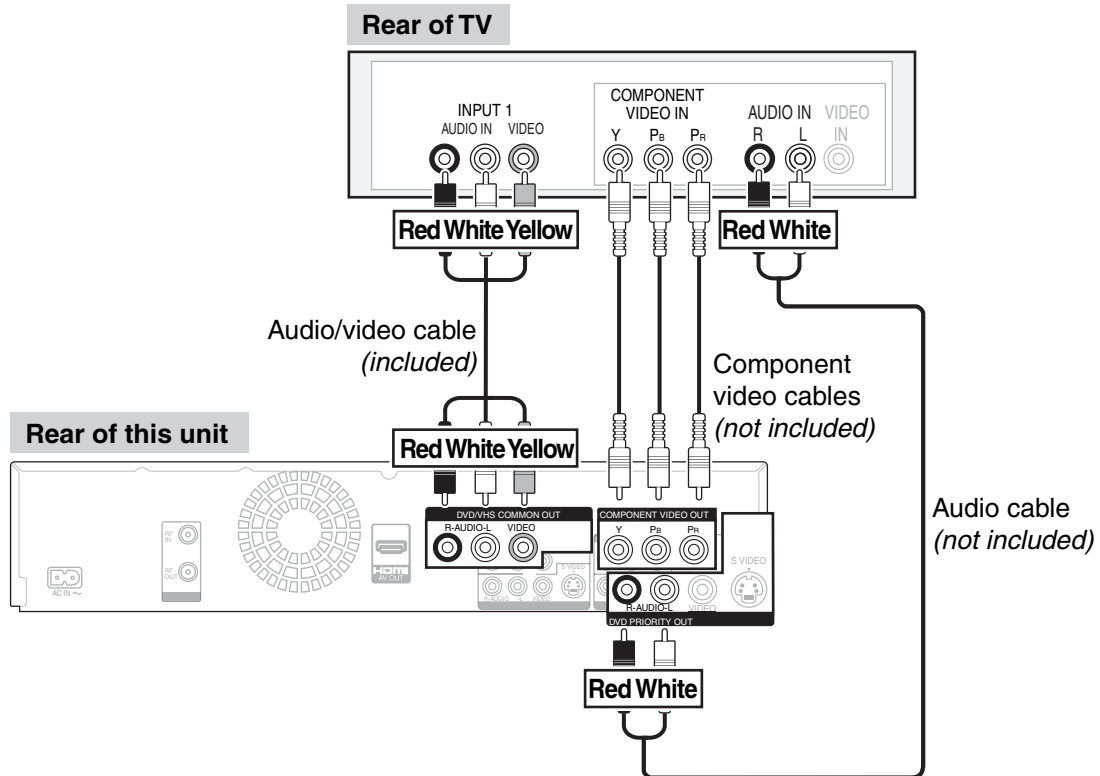

- Adjust settings in “Component Output Signal” (→ 64).



Notes

- Usually you can watch video from COMPONENT VIDEO input on TV. When you want to playback VHS while recording on DVD, switch to input 1 on TV.
- If this unit configured as above is connected to an amplifier, etc., then turn “HDMI Priority” in the Setup Menu to “Off” before connecting the HDMI cable. (→ 65)

Connection Options for Improved Playback Quality

You can enjoy better quality sound by changing the audio cable connection between this unit and your TV on page 8 to 10 as follows.

Using an Audio Cable for Better Sound (Audio Cable not included)

Use this connection to play sound through speakers connected to an amplifier or system component.

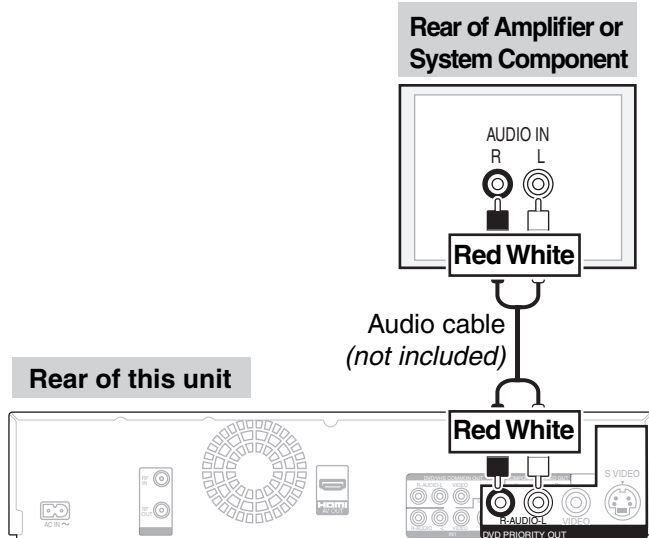

Using an Optical Digital Audio Cable for Better Sound (Optical Digital Audio Cable not included)

This method allows you to enjoy multi-channel surround sound on DVD-Video.

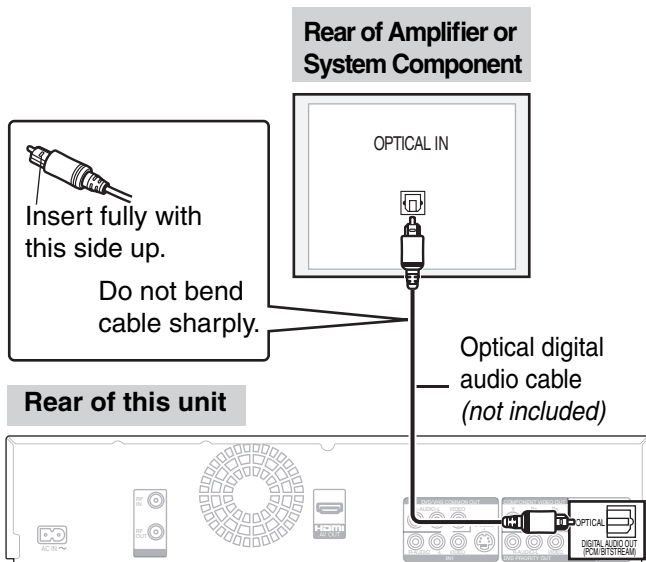

- Connect an amplifier or system component with a built-in decoder displaying these logo marks.



- Adjust settings in "Digital Audio Output" (→ 61).



Notes

- You cannot use DTS Digital Surround decoders not meant for DVD.
- Before purchasing an optical digital audio cable, check the terminal shape of the equipment to be connected.

Using an HDMI (High Definition Multimedia Interface) Cable

When connected to an HDMI compatible unit, an uncompressed digital audio and video signal is transmitted, enabling you to enjoy high quality digital video and audio with just one cable. When connecting to an HDMI-compatible HDTV (High Definition Television), the output can be switched to 1080p, 1080i or 720p HD video.

Regarding "HDAVI Control" function (→ 40)

- Please use HIGH SPEED HDMI cables that have the HDMI logo (as shown on the cover). It is recommended that you use Panasonic's HDMI cable. Recommended part number: RP-CDHG10 (1.0 m/3.3 ft.), RP-CDHG15 (1.5 m/4.9 ft.), RP-CDHG20 (2.0 m/6.6 ft.), RP-CDHG30 (3.0 m/9.8 ft.), RP-CDHG50 (5.0 m/16.4 ft.), etc.
- Non-HDMI-compliant cables cannot be used.

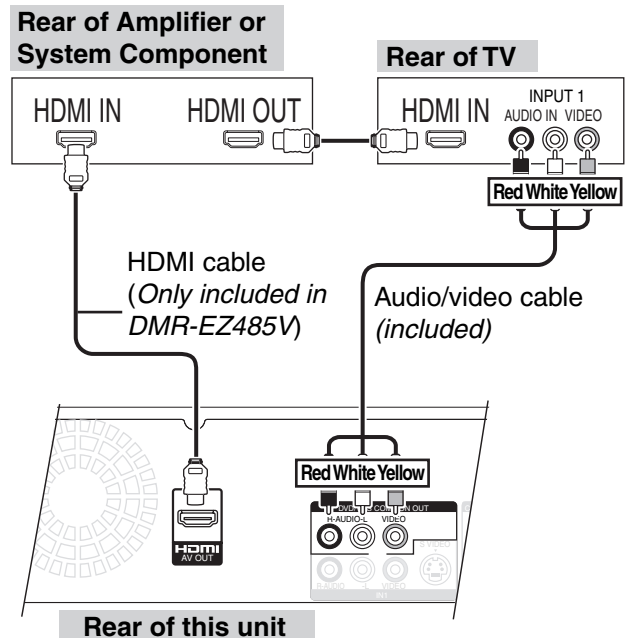

- Set "HDMI Priority" and "HDMI Audio Output" to "On" (→ 65, 66). (The default setting is "On".)



Notes

- If connecting to equipment that is only compatible with 2 channel output, audio with 3 channels or more will be down-mixed (→ 91) and output as 2 channels (some discs cannot be down-mixed).
- For display units compatible with HDCP (High bandwidth Digital Content Protection) that are equipped with a digital DVI input terminal (PC monitors, etc.): Depending on the unit, images may not display properly or at all when connecting with a DVI/HDMI switching cable (audio cannot be output).
- Usually you can watch video from HDMI input on TV. When you want to playback VHS while recording on DVD, switch to input 1 on TV.

SD Card and USB Memory Information

USB memories you can use with this unit

Type	Standard symbol	File format	Playing	Copying	Instructions
USB memory	USB	MP3	○	–	You can play MP3 files recorded onto the USB memory using a computer. (→ 33)
		Still pictures (JPEG)	○	○	You can play and copy still pictures taken on a digital camera etc. (→ 34, 48) –You can copy still pictures to/from DVD-RAM discs only. –You can copy albums only.
		DivX	○	–	You can play DivX files recorded onto the USB memory using a computer. (→ 36)

(○: Can do, –: Cannot do)

Compatible USB memories

- USB memories which are defined as USB mass storage class, and digital cameras that use PTP protocol.
 - USB memories that support USB 1.0/1.1 and USB 2.0 Full Speed/High Speed.*
 - *USB memories for USB 2.0 High Speed work as USB 2.0 Full Speed.
- USB memories of up to 32 GB can be used.
- USB memories that support bulk only transfer.
 - CBI (Control/Bulk/Interrupt) is not supported.
- Digital Cameras which require additional programme installation when connected to a PC are not supported.
- MTP (Media Transport Protocol) device is not supported.
- A multi-port USB card reader is not supported.
- FAT16 and FAT32 file systems are supported.
- UDF/NTFS/exFAT file system is not supported.
- Depending on the sector size, some files may not work.
- Only the first partition on USB memories with multi-partition is supported.

Despite meeting the conditions mentioned above, there may be USB memory that cannot be used with this unit.



Notes

- This unit does not support USB device charging.

SD Cards Usable with this Unit

Type	Standard symbol	File format	Instructions
<ul style="list-style-type: none"> • SD Memory Card (from 8 MB to 2 GB) • SDHC Memory Card (4GB, 8GB, 16GB) • miniSD Card* • microSD Card* 	SD	Still pictures (JPEG)	<ul style="list-style-type: none"> • You can play and copy still pictures taken on a digital camera, etc. (→ 34, 48) * A card adaptor included with the miniSD Card/microSD Card is necessary.





The card types mentioned above will be referred to as “SD Card” in these operating instructions.

Suitable SD Cards

- When using SD Memory Cards of 4 GB, 8 GB and 16 GB, only SD Memory Cards that display the SDHC logo can be used.
- Usable memory is slightly less than the card capacity.
- Please confirm the latest information on the following website.
<http://panasonic.co.jp/pavc/global/cs> (This site is in English only.)
- If the SD Card is formatted on other equipment, the time necessary for recording may be longer. Also, if the SD Card is formatted on a PC, you may not be able to use it on this unit.
- This unit is compatible with SD Memory Cards that meet SD Card Specifications FAT 12 and FAT 16 formats, as well as SDHC Memory Cards in FAT 32 format.
- SDHC Memory Cards used for recording with this unit can only be used with other SDHC Memory Card-compatible equipment. SDHC Memory Cards cannot be used with equipment that is only compatible with SD Memory Cards.
- We recommend using a Panasonic SD card.

Disc Information

Usable Discs for Recording and Playback

Disc type	Rewritable	Finalization Needed* ¹	Recording 16:9 aspect picture* ²	Recording broadcasts that allow one copy (CPRM) (→ 23)	Standard symbol
DVD-RAM 	○	—	○	○	RAM
DVD-R 	—	○	— (4:3 aspect)	—	-R before finalization DVD-V after finalization
DVD-R DL 	—	○	— (4:3 aspect)	—	-R DL before finalization DVD-V after finalization
DVD-RW 	○	○	— (4:3 aspect)	—	-RW(V) before finalization DVD-V after finalization
+R	—	○	— (4:3 aspect)	—	+R before finalization DVD-V after finalization
+R DL	—	○	— (4:3 aspect)	—	+R DL before finalization DVD-V after finalization
+RW	○	—	— (4:3 aspect)	—	+RW

- The explanations concerning discs are indicated by **DVD**, and those concerning video cassette are indicated by **VHS**.

*¹ Finalization needed for playback on other equipment (→ 54).

RAM can be played back on Panasonic DVD recorders and DVD-RAM compatible DVD players.

-R DL and **+R DL** can be played back only on equipment compatible with these discs.

*² For further information (→ 23, Important Notes for Recording)

- Use of Panasonic discs is recommended.
For available recording times for different discs under different recording modes, see “DVD Recording Modes and Estimated Disc Recording Time” on page 24.
Formatting and/or recording/initializing constraints may prevent you from playing or recording certain discs.
- Please see specifications (→ 92) for compatible disc versions and recording speeds.



Tips

- Visit Panasonic's homepage for more information about DVDs.
<http://www.panasonic.com/playDVD-R>
(This site is in English only.)
- Buy Discs from www.panasonic.com and receive Special 20% Discount!
Coupon Code: DVDMEDIA
*Offer good only in 50 United States.



Notes





- **RAM** will show an increase in available space whenever a recording has been erased.
- **-RW(V)** and **+RW** discs will only show an increase in available space when their last recording has been erased.
- **-R -R DL +R +R DL** The discs will show no increase in available space after deleting recordings.
- You may not be able to record depending on the condition of the discs and you may not be able to play them due to the condition of the recording.
- When recording multilingual broadcast, refer to page 23.

The manufacturer accepts no responsibility and offers no compensation for loss of recorded or edited material due to a problem with the unit or recordable media, and accepts no responsibility and offers no compensation for any subsequent damage caused by such loss.

Examples of causes of such losses are

- A disc recorded and edited with this unit is played in a DVD Recorder or computer disc drive manufactured by another company.
- A disc used as described above and then played again in this unit.
- A disc recorded and edited with a DVD Recorder or computer disc drive manufactured by another company is played in this unit.

Play-only Discs

Disc type	Standard symbol	Uses
 DVD-Video	DVD-V	High quality movie and music discs
 DVD-RW (DVD Video Recording format)	-RW(VR)	DVD-RW video recorded on another DVD recorder* <ul style="list-style-type: none"> You can play programs that allow "One time only recording" if they have been recorded to a CPRM compatible disc. By formatting (→ 53) the disc, you can record to it in DVD-Video format. It may be necessary to finalize the disc on the equipment used for recording.
 DVD-R  DVD-R DL	DivX, MP3, JPEG	<ul style="list-style-type: none"> DVD-R and DVD-R DL* with video recorded in DivX (→ 76) DVD-R and DVD-R DL* with music recorded in MP3 (→ 76) Still pictures (JPEG) recorded on DVD-R and DVD-R DL* (→ 76)
 Audio CD	CD	<ul style="list-style-type: none"> Recorded audio and music (including CD-R/RW*)
—	DivX, MP3, JPEG	<ul style="list-style-type: none"> CD-R and CD-RW* with video recorded in DivX (→ 76) CD-R and CD-RW* with music recorded in MP3 (→ 76) Still pictures (JPEG) recorded on CD-R/RW* (→ 76)

* Close the session after recording. Play may be impossible on some discs due to the condition of the recording.

• Operation and sound quality of CDs that do not conform to CD-DA specifications (copy control CDs, etc.) cannot be guaranteed.

• The producer of the disc can control how discs are played. So you may not always be able to control play as described in these operating instructions. Read the disc's instructions carefully.

Media Care

RAM Use cartridges to protect them from scratches and dirt.

Holding a disc or card

Handle discs by the edges to avoid inadvertently scratching or getting oil from your fingers on the disc. Do not touch the signal surface of discs (the shiny side) or the terminal surface (the metal part) of SD cards.

Cleaning discs

Discs are not indestructible and occasionally dirt or condensation may appear. Clean by gently wiping with a soft, dry lint-free cloth in a straight line from the center of the disc to the edge of the disc.

Return discs to their cases and SD cards to their cartridges when not in use; this helps to protect against scratches and dirt.

Video cassette

- Poor quality or damaged video cassettes can cause the heads to become dirty and malfunction.
- Never use video cassettes on which juice has been spilled or those that are extremely damaged since this will not only cause the heads to become dirty, but will also make the unit malfunction.

Discs that Cannot be Played

- 2.6/5.2 GB DVD-RAM, 12 cm (5")
- 3.95/4.7 GB DVD-R for Authoring
- DVD-R recorded in DVD Video Recording format
- DVD-R (DVD-Video format), DVD-R DL, DVD-RW (DVD-Video format), +R, +R DL recorded on another unit and not finalized (→ 91)
- PAL discs
- Discs recorded with AVCHD format
- DVD-Video with a region number other than "1" or "ALL"
- Blu-ray, HD DVD
- DVD-Audio
- Video CD
- DVD-ROM, +R 8 cm (3"), CD-ROM, CDV, CD-G, Photo CD, CVD, SVCD, SACD, MV-Disc, PD, etc.



Notes

Note about using a DualDisc:

The digital audio content side of a DualDisc does not meet the technical specifications of the Compact Disc Digital Audio (CD-DA) format so play may not be possible.

MP3s, DivXs and Still Pictures (JPEG)

MP3 File Information

Playable media	-R -R DL CD USB
File format	MP3 Files must have the extension ".mp3" or ".MP3".
Number of folders (groups)	Maximum number of folders (groups) recognizable: 99 folders (groups) (including the root folder)
Number of files (tracks)	Maximum number of files (tracks) recognizable: 999 files (tracks) (Total number for all the MP3, JPEG and other type of files.)
Bit rates	32 kbps to 320 kbps
Sampling frequency	16 kHz/22.05 kHz/24 kHz/ 32 kHz/44.1 kHz/48 kHz
ID3 tags	not compatible

- If there is a large amount of still picture data etc. within an MP3 file, play may not be possible.

Still Picture (JPEG) Information

Playable media	RAM -R -R DL CD SD USB
File format	JPEG Files must have the extension ".jpg" or ".JPG".
Number of pixels	between 34×34 and 6144×4096 (Sub sampling is 4:2:2 or 4:2:0)
Number of folders	RAM -R -R DL SD USB This unit can handle a maximum of 300 folders CD This unit can handle a maximum of 99 folders
Number of files	RAM -R -R DL SD USB This unit can handle a maximum of 3000 files CD This unit can handle a maximum of 999 files
MOTION JPEG	not compatible

- If a folder name or file name has been input using other equipment, the name may not be displayed properly or you may not be able to play or edit the data.

DivX File Information

Playable media	-R -R DL CD USB
File format	DivX • Files must have the extension ".DIVX", ".divx", ".AVI" or ".avi".
Number of folders	Maximum number of folders recognizable: 300 folders (including the root folder)
Number of files	Maximum number of DivX files recognizable*: 200 files
Support version	Plays all versions of DivX video (including DivX 6) with standard playback of DivX media files. Certified to the DivX Home Theater Profile. Video –Number of streams: Up to 1 –Codec: DIV3, DIV4, DIVX, DV50 –Picture size: 32×32 to 720×576 –FPS (Frame Per Second): Up to 30 fps Audio –Number of stream: Up to 8 –Format: MP3, Dolby Digital, MPEG –Multi channel: Dolby Digital is possible. MPEG multi is 2 ch conversion. • GMC (Global Motion Compensation) is not supported.



Notes

-R -R DL CD

- Compatible formats: ISO9660 level 1 or 2 (except for extended formats) and Joliet
- This unit is compatible with multi-session; however, reading or play of the disc may take time if there are a lot of sessions.
- Operation may take time to complete when there are many files (tracks) and/or folders (groups); some files (tracks) may not display or be playable.
- Images recorded at a very high resolution may take a long time to display.
- English alphabetical characters and Arabic numerals are displayed correctly. Other characters may not display correctly.
- The display order on this unit may differ from how the order is displayed on a computer.
- Depending on how you create the disc (writing software), files (tracks) and folders (groups) may not play in the order you number them.
- This unit is not compatible with packet-write format.
- Depending on the recording conditions, the disc may not play.



Tips

You can play MP3s on this unit by making folders as shown below. Depending on how you create the disc (writing software), play may not be in the order you number the folders.

How to structure MP3 folders
Prefix with 3-digit numbers in the order you want to play them.

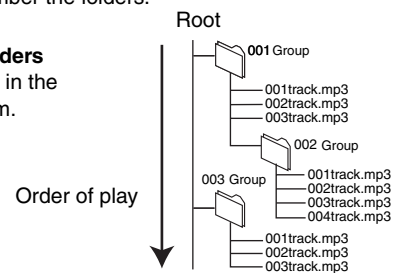

Frequently Asked Questions

Setup		Page
What equipment is necessary to play multi-channel surround sound?	<ul style="list-style-type: none"> You cannot play back multi-channel sound on this unit without other equipment. You must connect this unit with an HDMI cable or an optical digital audio cable to an amplifier with a built-in Dolby Digital or DTS decoder. 	72
Can the headphones and speakers be directly connected to the unit?	<ul style="list-style-type: none"> You cannot directly connect to the unit. Connect through the amplifier, TV, etc. 	–
The television has an S-VIDEO IN terminal, COMPONENT VIDEO IN terminals and HDMI IN terminal. Which should I connect with?	<ul style="list-style-type: none"> The output picture quality increases in the following order: VIDEO IN terminal → S-VIDEO IN terminal → COMPONENT VIDEO IN terminals → HDMI IN terminal. The unit will take longer to start up when connected with the HDMI IN terminal. 	–
Is my TV progressive output compatible?	<ul style="list-style-type: none"> All Panasonic TVs that have 480p input terminals are compatible. Consult the manufacturer if you have another brand of TV. 	–

Discs		Page
Can I play DVD-Video bought in another country?	<ul style="list-style-type: none"> You can play them if the video standard is NTSC. However, you cannot play DVD-Video if its region number does not include “1” or “ALL”. 	– Cover
Can a DVD-Video that does not have a region number be played?	<ul style="list-style-type: none"> Discs either without region number or region number “1” or “ALL” will not be played on this unit. 	–
What are the constraints regarding DVD-R, DVD-R DL, DVD-RW, +R, +R DL, and +RW compatibility with the unit?	<ul style="list-style-type: none"> The unit records and plays DVD-R, DVD-R DL, DVD-RW (DVD-Video format), +R, +R DL, and +RW, and plays DVD-RW (DVD Video Recording format). The unit also records and plays high speed recording compatible discs. After recording but before finalizing these discs (except +RW disc): <ul style="list-style-type: none"> You may not be able to play and record discs on this unit after recording them on other Panasonic products or other manufacturers' equipment. You may not be able to play and record discs on other equipment after recording them on this unit. After finalizing the disc, however, you will be able to play it on any DVD-Video compatible player. 	74, 75
		92 –
What are the constraints regarding CD-R and CD-RW compatibility with the unit?	<ul style="list-style-type: none"> This unit plays CD-R/CD-RW discs which have been recorded in one of the following standards: CD-DA, MP3, DivX and still pictures (JPEG). Close the session or finalize the disc after recording. This unit can recognize up to 99 folders (groups) and 999 files (tracks) on a disc with MP3 or still pictures (JPEG), 300 folders and 200 files on a disc with DivX. You cannot write to a CD-R or CD-RW with the unit. 	75, 76 –

Continued on next page.

Frequently Asked Questions

Recording		Page
Can I record from a commercially purchased video cassette or DVD?	<ul style="list-style-type: none"> Most commercially sold video cassettes and DVDs are copy protected; therefore, recording is usually not possible. 	–
Can DVD-R, DVD-R DL, DVD-RW (DVD-Video format), +R, +R DL, and +RW recorded on the unit be played on other equipment?	<ul style="list-style-type: none"> You can play these discs on compatible equipment such as DVD players after finalizing the disc on this unit. 	54
	<ul style="list-style-type: none"> +RW It is not necessary to finalize. To enable play on other DVD players, please use “Create DVD Top Menu” in the DVD Management menu. In any case, ability to play a disc depends on the condition of the recording, the quality of the disc, and the capability and format constraints of the DVD player. 	54 –
Can I record digital audio signals using the unit?	<ul style="list-style-type: none"> You cannot record digital signals. The digital audio terminals on the unit are for output only. (The audio recorded from a digital video camcorder using the DV camcorder recording function, however, is recorded digitally.) 	–
Can a digital audio signal from the unit be recorded to other equipment?	<ul style="list-style-type: none"> You can record if using the PCM signal. When recording DVD, change the “Digital Audio Output” settings to the following via the Setup menu: <ul style="list-style-type: none"> – PCM Down Conversion: “On” – Dolby Digital: “PCM” – DTS: “PCM” However, only <ul style="list-style-type: none"> – As long as digital recording from the disc is permitted. – As long as the recording equipment is compatible with 48 kHz sampling frequency. You cannot record MP3 signals. 	61 –
Can I switch to SAP during recording?	<ul style="list-style-type: none"> With DVD-RAM and a video cassette, you can, and the audio recorded also changes. Press [AUDIO] to change to SAP. 	23, 25
	<ul style="list-style-type: none"> You cannot change the audio type when recording an analog multilingual broadcast on a DVD-R, DVD-R DL, DVD-RW (DVD-Video format), +R, +R DL or +RW disc. Establish the appropriate setting before recording with “Multi-channel TV Sound (Analog)” in the Setup menu. 	23, 61
	<ul style="list-style-type: none"> Only one language channel is recorded from digital multilingual broadcasts, so you will be unable to change languages during recording. Set the language in “Multi-channel TV Sound (Digital)” in the Setup menu. 	23, 25, 61

USB		Page
What can or cannot be done using the USB port on this unit?	<ul style="list-style-type: none"> You can copy still pictures and play MP3, DivX or still picture files on a USB memory. 	33, 34, 36, 48
	<ul style="list-style-type: none"> A USB memory cannot be formatted on this unit. 	–
	<ul style="list-style-type: none"> Connections of digital cameras or camcorders through USB are not guaranteed. 	–
	<ul style="list-style-type: none"> Some USB memories cannot be used with this unit. 	73

Error Messages

On the Unit's Display		Page
H□□, F□□ (“□” stands for a service number.)	<ul style="list-style-type: none"> • An error has occurred. The number following “H” or “F” depends on the status of the unit. Check the items below and in the Troubleshooting Guide. If the service number still does not disappear after the check, reset the unit (→ 81, “To restore the unit if it freezes”). • If the service numbers fail to clear, note the service numbers and contact a qualified service person. 	–
RC □ (“□” stands for a number.)	<ul style="list-style-type: none"> • The remote control and the main unit are using different codes. Change the code on the remote control. 	57
HARD ERR (“HArD” and “Err” are alternately displayed.)	<ul style="list-style-type: none"> • If there is no change after turning the unit on and off, consult the dealer where the unit was purchased. 	–
NO READ (“NO” and “REAd” are alternately displayed.)	<ul style="list-style-type: none"> • The disc is dirty or badly scratched. The unit cannot record, play, or edit. • The disc may be incompatible or of poor quality. • You have used a lens cleaner and it has finished operation. Press [▲ OPEN/CLOSE] on the main unit to eject the disc. 	75 74, 75, 76 15
□□□□□□	<ul style="list-style-type: none"> • Displayed when the unit is started. This is not a malfunction. • The unit is carrying out its recovery process. You cannot operate the unit while “□” is displayed. 	–
FULL	<ul style="list-style-type: none"> • There are already 16 scheduled recording programs. Delete unnecessary scheduled recording programs. 	27
UNSUPPORT (“UNSUP” and “POrt” are alternately displayed.)	<ul style="list-style-type: none"> • You have inserted a disc the unit cannot play or record on. • You tried to operate with a non-compatible USB memory. 	74, 75 73
UNFORMAT (“UNFOR” and “MAT” are alternately displayed.)	<ul style="list-style-type: none"> • You have inserted a new DVD-RW/+RW or a DVD-RAM/DVD-RW (DVD-Video format) recorded on other equipment. You can format the disc when the format confirmation screen is displayed. 	25, 53
“HDD” is displayed on the unit's display.	<ul style="list-style-type: none"> • This unit is confirming that it is connected with equipment compatible with HDAVI Control. 	–
F74	<ul style="list-style-type: none"> • The HDMI connection could not be authenticated due to a transfer malfunction. Consult the dealer where the unit was purchased. 	–
F75	<ul style="list-style-type: none"> • The HDMI connection could not be authenticated due to an internal data malfunction. Consult the dealer where the unit was purchased. 	–
U59	<ul style="list-style-type: none"> • The unit is very warm. The unit switches to standby for safety reasons. Wait for about 30 minutes until the message disappears. Reinstall the unit in an area with adequate ventilation. Do not block the cooling fan on the rear of the unit. 	–
U61	<ul style="list-style-type: none"> • There was a power failure or the AC power supply cord was disconnected while the unit was on. The unit is carrying out its recovery process. This process restores the unit to normal operation. The unit is not broken. Wait until the message disappears. 	–
U72 U73	<ul style="list-style-type: none"> • The HDMI connection acts unusually. <ul style="list-style-type: none"> – The connected equipment is not HDMI compatible. – Please use HIGH SPEED HDMI cables that have the HDMI logo (as shown on the cover). – The HDMI cable is damaged. 	–
U76	<ul style="list-style-type: none"> • HDMI cannot be output because you are connected to a model that does not support copyright protection. 	–
U88	<ul style="list-style-type: none"> • There was something unusual detected with the disc while recording, playing or copying; there was a power failure or the AC power supply cord was disconnected while the unit was on. The unit is carrying out its recovery process. This process restores the unit to normal operation. The unit is not broken. Wait until the message disappears. 	83
U99	<ul style="list-style-type: none"> • The unit fails to operate properly. Press [⏻/I POWER] on the main unit to switch the unit to standby. Press [⏻/I POWER] on the main unit again to turn the unit on. 	–

Continued on next page.

Error Messages

On the TV		Page
Authorization Error. This unit is not authorized to play this recording.	<ul style="list-style-type: none"> You are trying to play the DivX VOD content that was purchased with a different registration code. You cannot play the content on this unit. (DivX) 	36
Cannot finish recording completely.	<ul style="list-style-type: none"> The program was copy-protected. The disc may be full. There are already 99 recordings (+R +R DL +RW 49 recordings). 	– – –
Cannot play.	<ul style="list-style-type: none"> You inserted an incompatible disc (discs recorded in PAL video, etc.). 	75
Cannot record on the disc.	<ul style="list-style-type: none"> The disc may be dirty or scratched. 	75
Unable to format.		
Please check the disc.		
Cannot record. Disc is full.	<ul style="list-style-type: none"> RAM -RW(V) +RW Create space by erasing unwanted recordings. Even if you erase recorded content from the DVD-R, DVD-R DL, +R or +R DL there is no increase in disc space. Available recording space on a DVD-RW (DVD-Video format) or +RW disc increases when the last recording is deleted (space may increase slightly when you delete other recordings). Use a new disc. 	22, 43, 53
Cannot record. The number of recordings has exceeded the maximum limit.		–
Error has occurred. Please press OK.	<ul style="list-style-type: none"> Press [OK] to start the recovery process. You cannot operate the unit while it is recovering ["□ □ □ □ □ □" (Self Check) appears on the unit's display]. 	–
No disc	<ul style="list-style-type: none"> You haven't inserted a disc. Correctly insert a disc that the unit can play. The disc is upside down. If it is a single-sided disc, insert it so the label is facing up. 	15, 74, 75 15
No folders.	<ul style="list-style-type: none"> There are no compatible folders on SD Card or USB memory. 	76
No SD card No valid SD card.	<ul style="list-style-type: none"> The card is not inserted. If this message is displayed while a compatible card is already inserted, turn off the unit, remove the card, then re-insert the card. The card inserted is not compatible or the card format does not match. 	15 73, 76
No VHS cassette.	<ul style="list-style-type: none"> There is no video cassette in the tape deck when playing or recording TV programs. Insert a video cassette. 	15
Now recording on DVD. To watch the VHS playback, connect a TV to DVD/VHS COMMON OUT terminal at the back of the unit, and select the appropriate input on the TV.	<ul style="list-style-type: none"> The VHS plays back while recording on DVD. You can watch the VHS playback by connecting to the DVD/VHS COMMON terminals. 	70
Please change the disc.	<ul style="list-style-type: none"> There may be a problem with the disc. Press [▲ OPEN/CLOSE] on the main unit to remove the disc to check for scratches and dirt. (The unit turns off automatically after you open the tray.) 	–
Please set the clock.	<ul style="list-style-type: none"> The clock is not set when recording programs or setting scheduled recording. Set the clock. 	57
The VHS cassette is protected.	<ul style="list-style-type: none"> A video cassette without the accidental erasure prevention tab has been inserted for recording TV programs. Use a video cassette with an accidental erasure prevention tab. 	15
Rental Expired.	<ul style="list-style-type: none"> The DivX VOD content has zero remaining plays. You cannot play it. (DivX) 	36
This is a non-recordable disc.	<ul style="list-style-type: none"> The unit cannot record on the disc you inserted. Insert a DVD-RAM or unfinalized DVD-R, DVD-R DL, DVD-RW (DVD-Video format), +R, +R DL, or +RW disc. The disc may be incompatible or of poor quality. 	74 74, 75, 76
This disc is not formatted properly.	<ul style="list-style-type: none"> You inserted an unformatted DVD-RAM, DVD-RW or +RW disc. Format the disc with the unit. 	53
⊘	<ul style="list-style-type: none"> The operation is prohibited by the unit, disc, or video cassette. 	–

Troubleshooting Guide

If the Antenna Connector doesn't Match

Use the following connection to suit the antenna lead to the unit's RF IN terminal, and the 75 Ω coaxial cable to the antenna terminals on your TV or other equipment. Refer to the other equipment's operating instructions for more information.

This unit

from the antenna

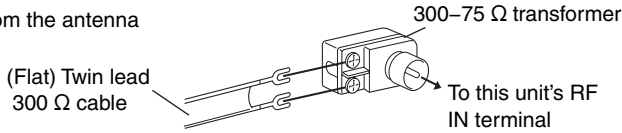

Other equipment (television etc.)

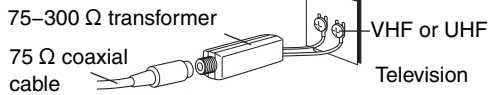

Changing RF Output Channel

If you connected this unit and a TV without an audio/video cable, interference (lines or patterning) or a very poor picture may appear on the TV. If this happens, follow the steps below to change the video playback channel (RF output channel) to remove the interference.

1



Press and hold for more than 5 seconds.

–The RF output channel number displays on the unit's display.

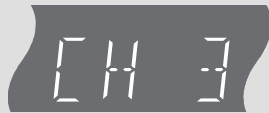
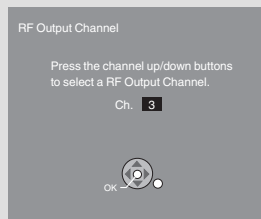

2

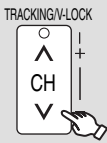

to select "CH 3" or "CH 4".

The unit's display
Each time you press the button:
CH 3 (Default setting) ↔ CH 4 ↔ OFF

For connections with the audio/video cable, set the RF output channel to "OFF".

3



to finish.



Notes

When you set the RF output channel to "CH 3" or "CH 4"
Video from this unit can be viewed on channels 3 and 4 on the TV. Press [VCR/TV] to switch to VCR mode and output video from this unit (→ 16).

To Reset This Unit

To reset the channel information and the clock settings

On the main unit

CH Press and hold both buttons for about 5 seconds.

To reset the ratings level settings

You can reset both parental rating (→ 56) and DVD-Video rating (→ 59).

1

With the unit stopped

OPEN/CLOSE



to open the disc tray.

2

On the main unit



Press and hold both buttons for about 5 seconds.

To restore the unit if it freezes

On the main unit

POWER



Press and hold for more than 10 seconds.

–The unit is off.

or

On the main unit

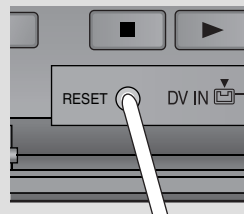

Press and hold for more than 1 second with a pointed object.

Troubleshooting Guide

Before requesting service, make the following checks. If you are in doubt about some of the check points, or if the solutions indicated in the chart do not solve the problem, refer to “Customer Services Directory” on page 94 if you reside in the U.S.A., or refer to the “Product information” on page 93 if you reside in Canada.

The following does not indicate a problem with the unit:

- Regular disc rotating sound.
- Poor reception due to atmospheric conditions.
- Image disturbance during search.
- Periodic interruptions to the reception due to satellite broadcasting breaks.
- Operations not working due to a poor-quality disc. (Try again using a Panasonic disc.)
- The unit freezing due to the activation of one of its safety devices (→ 81, To restore the unit if it freezes).

General Issues		Power	Page
No power.	<ul style="list-style-type: none"> ● Insert the AC power supply cord securely into a known active AC outlet. 		8 to 10
The unit switches to standby mode.	<ul style="list-style-type: none"> ● This is a power saving feature. Change “Off Timer” in the Setup menu to “Off” to always keep the unit on. 		57
	<ul style="list-style-type: none"> ● One of the unit’s safety devices is activated. Press [⏻/I POWER] on the main unit to turn the unit on. 		–
The power is turned off automatically.	<ul style="list-style-type: none"> ● If you connected this unit to an “HDMI Control” compatible TV with an HDMI cable, this unit will be automatically turned off when the TV is turned off. 		40

General Issues		Displays	Page
The display is dim.	<ul style="list-style-type: none"> ● Change “Front Display” in the Setup menu. 		63
“12:00A” is flashing on the unit’s display.	<ul style="list-style-type: none"> ● Set the clock. 		57
The recording time display, the copying process display, and the displayed recording times of MP3s are different from the actual time.	<ul style="list-style-type: none"> ● Times shown may disagree with actual times. 		–
	<ul style="list-style-type: none"> ● -R -R DL +R +R DL The remaining capacity does not increase even if recordings are deleted. 		–
	<ul style="list-style-type: none"> ● Available recording space on a DVD-RW (DVD-Video format) or +RW disc increases when you delete the last recording (space may increase slightly when you delete other recordings). 		–
	<ul style="list-style-type: none"> ● If you record or edit about 200 times or more, the remaining capacity of DVD-R, DVD-R DL, +R, or +R DL is reduced and then recording or editing may be disabled (for the second layer on DVD-R DL and +R DL, this happens after about 60 times). 		–
Compared to the actual recorded time, the elapsed time displayed is less.	<ul style="list-style-type: none"> ● The time during fast forward and rewind, or the process during copy may not be displayed accurately. 		–
	<ul style="list-style-type: none"> ● The displayed recording/play time is converted from the number of frames at 29.97 frames (equal to 0.999 seconds) to one second. There will be a slight difference between the time displayed and the actual elapsed time (e.g., actual one-hour elapsed time may display as approximately 59 minutes 56 seconds). This does not affect the recording. 		–

Cannot operate the TV or Set Top Box with the unit's remote control.	<ul style="list-style-type: none"> ● Change the manufacturer code on the remote control. ● Select TV or Set Top Box mode on the remote control. 	68 68
Cannot operate the DVD.	<ul style="list-style-type: none"> ● Press [DRIVE SELECT] to select the DVD drive when operating DVDs or CDs. – Make sure the TV is on the correct channel or input mode. 	17
Cannot operate the VHS.	<ul style="list-style-type: none"> ● Press [DRIVE SELECT] to select the VHS drive when operating VHS cassettes. – Make sure the TV is on the correct channel or input mode. 	17
The remote control doesn't work.	<ul style="list-style-type: none"> ● The remote control code is wrong. Change to the correct code. ● The batteries are depleted. Replace them with new ones. ● Point the remote control at the remote control sensor on the main unit. ● Remove obstacles between the remote control and main unit. ● Remove dust from the transmission window and the unit's sensor. ● Colored glass may obstruct the signal reception/transmission. ● Don't place the signal sensor in direct sunlight or in areas that may be subject to sun exposure. ● It may be necessary to set the code on the remote control again after changing the batteries. ● It may be necessary to set the manufacturer code again after changing the batteries. 	57 5 5 – – – – 57 68
The unit is on but cannot be operated.	<ul style="list-style-type: none"> ● Some operations are prohibited by the disc. ● The unit is warm ("U59" appears on the unit's display). Wait until "U59" disappears. ● One of the unit's safety devices may have been activated. Reset the unit as follows: Press [⏻/I POWER] on the main unit to switch to off. If the unit doesn't switch to off, reset the unit (→ 81, "To restore the unit if it freezes"). 	– – –
"U88" is displayed and the disc cannot be ejected.	<ul style="list-style-type: none"> ● The unit is carrying out the recovery process. Do the following to eject the disc: (1) Press [⏻/I POWER] on the main unit to switch to off. If the unit doesn't switch to off, reset the unit (→ 81, "To restore the unit if it freezes"). (2) While the unit is off, press and hold [■] and [CH ^] on the main unit at the same time for about 5 seconds. (Ejection may take extra time depending on discs.) The disc may be defective. Try another disc. 	–
Cannot eject a disc.	<ul style="list-style-type: none"> ● The unit is recording. ● The unit may have a problem. Eject the disc as in (2) above. 	– –
Startup is slow.	<ul style="list-style-type: none"> ● Startup takes time in the following situations: <ul style="list-style-type: none"> – A disc other than a DVD-RAM is inserted. – The clock is not set. – Immediately after a power failure or the AC power supply cord is connected. – When the unit is connected with an HDMI cable. 	–
A password screen appears and you are unable to view or record.	<ul style="list-style-type: none"> ● If the unit starts receiving a broadcast with the set rating information, a password screen appears and you will be unable to view or record. Enter your password to continue. 	56
Time is incorrect after using Auto Clock Setting.	<ul style="list-style-type: none"> ● Try again. If the time is still incorrect, set the clock manually. 	58

Troubleshooting Guide

General Issues	VIERA Link	Page
VIERA Link doesn't work	<ul style="list-style-type: none"> ● Check the HDMI cable connection. Check that "HDMI" is displayed on the front display when the power for the main unit is set to "On". 	–
	<ul style="list-style-type: none"> ● Make sure that "VIERA Link" is set to "On". 	66
	<ul style="list-style-type: none"> ● Check the "HDAVI Control" settings on the connected device. 	–
	<ul style="list-style-type: none"> ● If the connection for the equipment connected with an HDMI cable was changed, or if there was a power failure or the plug was removed from the household AC outlet, "HDAVI Control" may not work. In this case, perform the following operations. <ol style="list-style-type: none"> 1. When all equipment connected with the HDMI cable is turned on, turn the TV (VIERA) on again. 2. Change the TV (VIERA) settings for the "HDAVI Control" function to off, and then set to on again. (For more information, see the VIERA operating instructions.) 3. Switch the VIERA input to HDMI connection with this unit, and after this unit's screen is displayed check that "HDAVI Control" is working. 	–

General Issues	USB	Page
The contents of the USB memory cannot be read.	<ul style="list-style-type: none"> ● Check that the USB memory is inserted correctly. 	15
	<ul style="list-style-type: none"> ● The format of the USB memory or of its contents is not compatible with the unit. (The contents on the USB memory may be damaged.) 	73, 76
	<ul style="list-style-type: none"> ● The USB memory contains a folder structure and/or file extensions that are not compatible with this unit. 	76
	<ul style="list-style-type: none"> ● Turn off and then turn on the unit again. 	–
	<ul style="list-style-type: none"> ● USB memories connected using a USB extension cable, a USB multi card reader or USB hub may not be recognized by this unit. 	–
	<ul style="list-style-type: none"> ● The USB host function of this unit may not work with some USB memory devices. 	–
	<ul style="list-style-type: none"> ● USB memories with storage capacity of more than 32 GB may not work in some instances. 	–
	<ul style="list-style-type: none"> ● Some USB memories cannot be used with this unit. 	73

TV reception worsens after connecting the unit.	<ul style="list-style-type: none"> • This can occur because the signals are being divided between the unit and other equipment. It can be solved by using a signal booster, available from electronics retailers. 	–
The images from the unit do not appear on the TV. Picture is distorted.	<ul style="list-style-type: none"> • Make sure recorder is connected to an appropriate AV input of the TV. • Make sure the TV's input setting (e.g., VIDEO 1) is correct. • Press [VCR/TV] to change to VCR mode. • The TV isn't compatible with progressive signals. Press and hold [■] and [▶] on the main unit for about 5 seconds. The setting will change to interlace. • When connecting with component video cables to a television, check if there is also an HDMI cable connected to an amplifier. If so, turn off the equipment connected with an HDMI cable and set the "HDMI Priority" to "Off" in the Setup menu. • To output video from a device connected with an HDMI cable, set "HDMI Priority" to "On" in the Setup menu. • Picture may not be seen when more than 4 devices are connected with HDMI cables. Reduce the number of connected devices. 	8 to 11 – 16 – 65 65 –
Status messages do not appear.	<ul style="list-style-type: none"> • Select "Automatic" in "Status Messages" in the Setup menu. 	62
The black or gray background does not appear.	<ul style="list-style-type: none"> • Select "On" in "Black Background (Analog)" in the Setup menu. 	62
The 4:3 aspect ratio picture expands left and right. Screen size is wrong.	<ul style="list-style-type: none"> • If you connect an HDMI cable, set "HDMI Output Display Aspect" in the Setup menu to "Normal". • Check the settings for "TV Aspect", "4:3 TV settings for DVD-Video", or "4:3 TV settings for DVD-RAM" in the Setup menu. 	65 64
There is a lot of after-images when playing video.	<ul style="list-style-type: none"> • Set "DNR" in the Video menu to "Off". 	51
When playing DVD-Video using progressive output, one part of the picture momentarily appears to be doubled up.	<ul style="list-style-type: none"> • This problem is caused by the editing method or material used on DVD-Video, but should be corrected if you use interlaced output. • When you use the HDMI AV OUT terminal for video output, follow the steps below: (1) Connect this unit to the TV with any cable except the HDMI cable. (2) Set "HDMI Priority" in the Setup menu to "Off" (→ 65). (3) Set "Component Output Signal" in the Setup menu to "480i" (→ 64). 	51 –
There is no apparent change in picture quality when making adjustments in the Video menu using the on-screen menus.	<ul style="list-style-type: none"> • The effect cannot be seen with certain types of video. 	–

Troubleshooting Guide

Playback Issues	Sound	Page
<p>No sound. Low volume. Distorted sound. Cannot hear the desired audio type.</p>	<ul style="list-style-type: none"> ● Check the connections and the “Digital Audio Output” settings. Check the input mode on the amplifier if you have connected one. ● Check if TV is muted. ● Check if amplifier is muted. ● Press [AUDIO] to select the audio. ● Sound is not output while fast-forwarding during chasing playback and simultaneous record and playback. ● Set “V. Surround Sound” in the Audio menu to “Off” in the following cases: <ul style="list-style-type: none"> – When using discs that do not have surround sound effects, such as Karaoke discs – When playing analog multilingual broadcast recordings ● The sound effects will not work when the bitstream signal is output from the HDMI AV OUT terminal or the DIGITAL AUDIO OUT terminal. ● Audio may not be output due to how files were created. (DivX) ● Audio may not be heard when more than 4 devices are connected with HDMI cables. Reduce the number of connected devices. ● When the DIGITAL AUDIO OUT terminal is used for audio output and the unit is connected to the television with an HDMI cable, set “HDMI Audio Output” to “Off” in the Setup menu. ● Depending on the connected equipment, the sound may be distorted if this unit is connected with an HDMI cable. 	<p>61, 72</p> <p>–</p> <p>–</p> <p>31, 38</p> <p>–</p> <p>51</p> <p>–</p> <p>–</p> <p>–</p> <p>66</p> <p>–</p>
<p>Cannot switch audio.</p>	<ul style="list-style-type: none"> ● You cannot change the audio type when a DVD-R, DVD-R DL, DVD-RW (DVD-Video format), +R, +R DL, or +RW disc is in the disc tray. ● You cannot change the audio type when playing a recording of an analog multilingual broadcast on a DVD-R, DVD-R DL, DVD-RW (DVD-Video format), +R, +R DL or +RW disc. You can select “Main” or “Secondary Audio Program (SAP)” in “Multi-channel TV Sound (Analog)” in the Setup menu before recording. ● Only one language channel is recorded from digital multilingual broadcasts, so you will be unable to change languages during playback. ● You have used a digital connection. Set “Dolby Digital” to “PCM” or connect using an audio cable (analog connection). ● There are discs whose audio cannot be changed due to how the disc was created. 	<p>–</p> <p>23, 25, 61</p> <p>25</p> <p>61, 72</p> <p>–</p>

<p>Play fails to start even when [▶ PLAY] is pressed. Play starts but then stops immediately.</p>	<ul style="list-style-type: none"> ● Insert the disc correctly with the label facing up. ● Ensure disc is for the correct DVD-Video region number, and is not defective. ● The disc is dirty. ● You tried to play a blank disc or a disc that is unplayable on the unit. ● When recording to DVD-RAM using EP (8H) mode, play may not be possible on DVD players that are compatible with DVD-RAM. In this case use EP (6H) mode. ● You cannot play discs during DV Camcorder recording. ● If playing DivX VOD content, refer to the homepage where you purchased it. (DivX) 	<p>15 Cover 75 74, 75, 76 60 – 36</p>
<p>Audio and video momentarily pause.</p>	<ul style="list-style-type: none"> ● This occurs between playlist chapters. ● This occurs as scenes change during Quick View. ● -R DL +R DL Images and audio may be interrupted momentarily when play reaches the point where the recording passed from the first layer to the second. 	<p>– – 23</p>
<p>DVD-Video is not played.</p>	<ul style="list-style-type: none"> ● You have set a ratings level to limit DVD-Video play. Change this setting. 	<p>59</p>
<p>Alternative soundtrack and subtitles cannot be selected.</p>	<ul style="list-style-type: none"> ● The languages are not recorded on the disc. ● You may have to use the disc's own menus to select languages and audio tracks. 	<p>– 30</p>
<p>No subtitles.</p>	<ul style="list-style-type: none"> ● When progressive output is on, TV's closed captions cannot be displayed. Go to the Setup menu and turn this unit's closed captions on. ● If connecting with the DVD/VHS COMMON output terminals, closed caption cannot be displayed by this unit while playing tape. Make the settings and display on a TV that supports Closed Captioning. ● Subtitles are not recorded on the disc. ● Set "Subtitle" in the Disc menu to "On". 	<p>63 – – 50</p>
<p>Angle cannot be changed.</p>	<ul style="list-style-type: none"> ● This function depends on software availability. Angles can only be changed during scenes where different angles are recorded. 	<p>–</p>
<p>You have forgotten your ratings password.</p>	<ul style="list-style-type: none"> ● With the tray open, press and hold [● REC] and [▶] on the main unit simultaneously for about 5 or more seconds. 	<p>81</p>
<p>Quick View does not work.</p>	<ul style="list-style-type: none"> ● This does not work when audio is other than Dolby Digital. ● This does not work while recording in XP or FR mode. 	<p>– –</p>
<p>The resume play function does not work.</p>	<ul style="list-style-type: none"> ● Memorized positions are canceled when the unit is turned off or when the tray is opened. ● This function does not work when playing DivX VOD content. 	<p>– 36</p>
<p>It takes time before play starts.</p>	<ul style="list-style-type: none"> ● This is normal on DivX video. (DivX) 	<p>–</p>
<p>Picture stops.</p>	<ul style="list-style-type: none"> ● Picture may stop if the DivX files are greater than 2 GB. (DivX) 	<p>–</p>
<p>Cannot see the beginning of the recording played.</p>	<ul style="list-style-type: none"> ● (If you connected this unit to an "HDAVI Control" compatible TV with an HDMI cable) When [▶ PLAY] is pressed on this unit's remote control to start play, you may not be able to see the beginning of the recording played until the picture is displayed on the TV. Using [◀◀] or [◀], return to the beginning of the recording. 	<p>–</p>

Troubleshooting Guide

Playback Issues		VHS	Page
On-screen display indicators for video cassette playback do not appear.	<ul style="list-style-type: none"> Select "Automatic" in "Status Messages" in the Setup menu. <ul style="list-style-type: none"> Press [STATUS] to show the on-screen display indicators for video cassette playback. The on-screen indicator for video cassette playback will not be displayed when this unit is connected to the TV with the DVD PRIORITY output terminals or HDMI AV OUT terminal. 		39, 62
The gray background appears during playback.	<ul style="list-style-type: none"> You are playing a blank or poor quality portion of the tape. You can damage the unit if you play dirty or damaged tapes and this can cause the gray background to appear. 		–
Cannot hear the desired audio type.	<ul style="list-style-type: none"> Press [AUDIO] to select the audio. 		38
There is noise when playing a video tape.	<ul style="list-style-type: none"> Adjust the tracking. The tape is old or damaged. 		38
Cannot play.	<ul style="list-style-type: none"> Tapes recorded under a TV system other than NTSC (PAL, SECAM, etc.) cannot be played. 		–
The playback screen flickers.	<ul style="list-style-type: none"> The video head is dirty. The tape is old or damaged. 		3

Recording Issues		DVD Recording/Scheduled Recording/Copying/External Input	Page
Cannot record.	<ul style="list-style-type: none"> You haven't inserted a disc or the disc you inserted cannot be recorded on. Insert a disc the unit can record onto. 		74
	<ul style="list-style-type: none"> RAM -RW(V) +RW The disc is unformatted. Format the disc. 		53
	<ul style="list-style-type: none"> The write-protect tab on the cartridge is set to "PROTECT" or the disc is protected with the "DVD Management" settings. 		52
	<ul style="list-style-type: none"> Some programs have limitations on the number of times they can be recorded (CPRM). 		23, 74, 91
	<ul style="list-style-type: none"> The disc is full or nearly full. Delete unneeded recordings or use another disc. 		22, 43, 53
	<ul style="list-style-type: none"> You cannot record on finalized DVD-R, DVD-R DL, DVD-RW (DVD-Video format), +R, +R DL, or DVD-RW (DVD Video Recording format) discs. 		–
	<ul style="list-style-type: none"> If you repeatedly insert discs or turn the unit on and off about 50 times or more, the recording or editing of DVD-R, DVD-R DL, DVD-RW (DVD-Video format), +R, +R DL, and +RW discs may be disabled. 		–
	<ul style="list-style-type: none"> A DVD-R, DVD-R DL, DVD-RW (DVD-Video format), +R, +R DL, or +RW disc recorded on the unit may not be recordable on other Panasonic DVD recorders. 		–
<ul style="list-style-type: none"> The broadcast you are trying to record is copy-protected. 		–	

		Page
Recording does not stop even when [■ STOP] is pressed.	<ul style="list-style-type: none"> ● If you start recording immediately after turning on the unit while "Quick Start" is set to "On", you cannot stop recording for a few seconds. 	58
Scheduled recording does not work properly.	<ul style="list-style-type: none"> ● The scheduled recording program is incorrect or different scheduled recording times overlap. Correct the program. ● The unit is not on scheduled recording standby. ("⊙" on the unit's display is not on.) Press [⏻ DVD/VHS POWER] to turn the unit off and make sure that "⊙" is on. ● The clock is not correct. Set the clock. 	27 19, 27 57
The scheduled recording program remains even after recording finishes.	<ul style="list-style-type: none"> ● The scheduled recording program remains if set to daily or weekly. 	19, 27
Part or all of a recording has been lost.	<ul style="list-style-type: none"> ● If the power shuts down or the plug is disconnected from the household AC outlet while recording or editing, the program may be lost or the disc may become unusable. We cannot offer any guarantee regarding lost recordings or discs. You will have to format the disc (RAM -RW(V) +RW) or use a new disc. 	–
Cannot copy VHS to DVD.	<ul style="list-style-type: none"> ● The write-protect tab on the cartridge is set to "PROTECT" or the disc is protected with the "DVD Management" settings. ● Some video tapes on the market (including rental videos) are copy-protected to prevent illegal reproductions. Copy-protected video tapes cannot be properly recorded. ● You cannot use the copying function when the FUNCTIONS window, the Scheduled Recording List screen, etc. are displayed. 	52 – –
Cannot copy DVD to VHS.	<ul style="list-style-type: none"> ● A video cassette without the accidental erasure prevention tab is inserted. Use a video cassette with an accidental erasure prevention tab. ● Some DVDs on the market (including rental DVD) are copy-protected to prevent illegal reproductions. Copy-protected DVDs cannot be properly recorded. ● You cannot use the copying function when the FUNCTIONS window, the Scheduled Recording List screen, etc. are displayed. 	– – –
The sound level after editing is not equal on DVD and on VHS.	<ul style="list-style-type: none"> ● The sound level on DVD and VHS may not match depending on the disc. When the sound level in a particular part of the sound source is soft or loud, the sound may be recorded loudly or softly on a video tape. 	–
Stripe-shaped black noise is recorded.	<ul style="list-style-type: none"> ● An external playback device is interfering with the TV because the device is too close to the TV. Move the device away from the TV. 	–
Cannot record video or sound from the external device.	<ul style="list-style-type: none"> ● The external device is not correctly connected. ● The proper external input channel (IN1, IN2, or DV) is not selected. Press [INPUT SELECT] to change. 	28, 29 28
The DV Camcorder recording function does not work.	<ul style="list-style-type: none"> ● If images cannot be recorded or if the recording is aborted, check the connections and the DV equipment settings. ● You cannot start recording until the images from the DV equipment appear on the television. ● Recording may not be performed as desired if the time codes on the tape in the DV equipment are not successive. ● Depending on the equipment, the DV Camcorder recording may not operate properly. ● You can only record audio/video images on a DV tape. 	29 – – – –

Troubleshooting Guide

Recording Issues

VHS Recording

Page

“  ” flashes when I try to start recording.	<ul style="list-style-type: none"> • A video cassette is not inserted. Insert a video cassette with an accidental erasure prevention tab. 	15
Cannot record.	<ul style="list-style-type: none"> • The accidental erasure prevention tab has been removed. Cover the hole with adhesive tape. 	15
Cannot record a TV program.	<ul style="list-style-type: none"> • Digital broadcasts cannot be recorded to video tape. 	–

Editing Issues

DVD & SD

Page

Cannot format.	<ul style="list-style-type: none"> • The disc is dirty. Wipe with a damp cloth and then wipe dry. • Disc may be defective or of poor quality. • You tried formatting a disc that is not compatible with the unit. • +RW Discs created on a computer may not be formatted. 	75 – 53 –
Cannot create chapters.	<ul style="list-style-type: none"> • The unit writes the chapter division information to the disc when you turn it off or remove the disc. The information is not written if there is an interruption in the power. • These operations are not possible with still pictures. 	– –
Cannot delete chapters.	<ul style="list-style-type: none"> • When the chapter is too short to delete, use “Combine Chapters” to make the chapter longer RAM. 	45
The available recording time doesn’t increase even after deleting recordings on the disc.	<ul style="list-style-type: none"> • Available space on DVD-R, DVD-R DL, +R, or +R DL does not increase even after deleting previous recordings. • Available space on DVD-RW (DVD-Video format) or +RW increases when you delete the last recording. 	– –

Editing Issues

Still Pictures

Page

Cannot display the Direct Navigator screen.	<ul style="list-style-type: none"> • This screen cannot be displayed while recording or copying. 	–
Cannot edit or format a card.	<ul style="list-style-type: none"> • Release the card’s protection setting. With some cards, the “Write Protection Off” message sometimes appears on the screen even when protection has been set. 	52
The contents of the card cannot be read.	<ul style="list-style-type: none"> • The card format is not compatible with the unit. The contents on the card may be damaged. • Format using FAT 12, FAT 16 or FAT 32 with other equipment or format the card with this unit. • The card contains a folder structure and/or file extensions that are not compatible with this unit. • Turn off and then turn on the unit again. • SD Memory Cards (from 8 MB to 2 GB) or SDHC Memory Card (4 GB, 8 GB, 16 GB) can be used with this unit. 	73 53 76 – –
Copying, deleting, and setting protection take a long time.	<ul style="list-style-type: none"> • When there are a lot of folders and files, it may sometimes take a few hours. • When repeating copying or deleting, it may sometimes take a long time. Format the disc or card. 	– 53

Glossary

Bitstream

This is a signal compressed and converted into digital form. It is converted back to a multi-channel audio signal, e.g., 5.1-channel, by a decoder.

CPRM (Content Protection for Recordable Media)

CPRM is technology used to protect broadcasts that are allowed to be recorded only once. Such broadcasts can be recorded only with CPRM-compatible recorders and discs.

Decoder

A decoder restores the coded audio signals on DVDs to normal. This is called decoding.

DivX

A video compression format developed by DivX, Inc. that compresses video files without any considerable loss of video quality.

Dolby Digital

This is a method of coding digital signals developed by Dolby Laboratories. Apart from stereo (2-channel) audio, these signals can also be multi-channel audio. A large amount of audio information can be recorded on one disc using this method.

Down-mixing

This is the process of remixing the multi-channel audio found on some discs into two channels. It is useful when you want to listen to the 5.1-channel audio recorded on DVDs through your TV's speakers. Some discs prohibit down-mixing. If this is the case, this unit can only output the front two channels.

DTS (Digital Theater Systems)

This surround system is used in many movie theaters. There is good separation between the channels, so realistic sound effects are possible.

Dynamic range

Dynamic range is the difference between the lowest level of sound that can be heard above the noise of the equipment and the highest level of sound before distortion occurs. Dynamic range compression means reducing the gap between the loudest and softest sounds. This means you can hear dialog clearly at low volume.

Film and Video

DVD-Video are recorded using either film or video. The unit can determine which type has been used, then uses the most suitable method of progressive output.

Film is 24 or 30 frames per second, with motion picture film generally being 24 frames per second.

Video is 60 fields per second (2 fields making up 1 frame).

Finalize

A process that makes play of a recorded CD-R, CD-RW, DVD-R, etc. possible on equipment that can play such media. You can finalize DVD-R, DVD-R DL, DVD-RW (DVD-Video format), +R, and +R DL on the unit. After finalizing, the disc becomes play-only and you can no longer record or edit. However, finalized DVD-RW can be formatted to become recordable.

Folder

This is a place on the memory card where groups of data are stored together. In the case of this unit, it refers to the place where still pictures (JPEG) are stored.

Formatting

Formatting is the process of making media such as DVD-RAM recordable on recording equipment.

You can format DVD-RAM, DVD-RW (only as DVD-Video format), +RW and SD Card on this unit.

Formatting irrevocably erases all contents.

Frame and field

Frame refers to the single images that constitute the video you see on your TV. Each frame consists of 2 fields.



Frame

Field

Field

- A frame still shows 2 fields, so there may be some blurring between them, but picture quality is generally better.
- A field still shows less picture information so it may be rougher, but there is no blurring.

HDMI (High-Definition Multimedia Interface)

Unlike conventional connections, it transmits uncompressed digital video and audio signals on a single cable. This unit supports high-definition video output (720p, 1080i and 1080p) from HDMI AV OUT terminal. To enjoy high-definition video a high definition compatible television is required.

JPEG (Joint Photographic Experts Group)

This is a system used for compressing/decoding color still pictures. If you select JPEG as the storage system on digital cameras, etc., the data will be compressed to 1/10-1/100 of its original size. The benefit of JPEG is less deterioration in picture quality considering the degree of compression.

MP3 (MPEG Audio Layer 3)

An audio compression method that compresses audio to approximately one-tenth of its size without any significant loss of audio quality.

Pan & Scan/Letterbox

In general, DVD-Video are produced with the intention that they will be viewed on a widescreen TV (16:9 aspect ratio), so images often don't fit regular TVs (4:3 aspect ratio). 2 styles of picture, "Pan & Scan" and "Letterbox", deal with this problem.

Pan & Scan: The sides are cut off so the picture fills the screen.



Letterbox: Black bands appear at the top and bottom of the picture so the picture itself appears in an aspect ratio of 16:9.



Progressive/Interlace

NTSC, the video signal standard, has 480 interlaced (i) scan lines, whereas progressive scanning uses twice the number of scan lines. This is called 480p.

Using progressive output, you can enjoy the high-resolution video recorded on media such as DVD-Video.

Your TV must be compatible to enjoy progressive video.

Protection

You can prevent accidental erasure by setting writing protection or erasure protection.

Sampling frequency

Sampling is the process of converting the heights of sound wave (analog signal) samples taken at set periods into digits (digital encoding). Sampling frequency is the number of samples taken per second, so larger numbers mean more faithful reproduction of the original sound.

Thumbnail

This refers to a miniature representation of a picture used to display multiple pictures in the form of a matrix.

1080i

In one high definition image, 1080 alternating scan lines pass every 1/60th of a second to create an interlace image. Because 1080i more than doubles current television broadcasts of 480i, the detail is much clearer and creates a more realistic and rich image.

1080p

In one high definition image, 1080 scan lines pass at the same time every 1/60th of a second to create a progressive image. Since progressive video does not alternate scan lines like interlace, there is a minimal amount of screen flicker.

720p

In one high definition image, 720 scan lines pass at the same time every 1/60th of a second to create a progressive image. Since progressive video does not alternate scan lines like interlace, there is a minimal amount of screen flicker.

Specifications

Power supply:	AC 120 V, 60 Hz
Power consumption:	Approx. 40 W
Standby mode: (Shipping Condition)	Approx. 3.5 W
(User Setting: Quick Start: ON)	Approx. 17.6 W

Recordable discs:

DVD-RAM:	2X SPEED (Ver. 2.0) 2-3X SPEED (Ver. 2.1) 2-5X SPEED (Ver. 2.2)
DVD-R (SL):	1X SPEED (Ver. 2.0) 1-4X SPEED (Ver. 2.0) 1-8X SPEED (Ver. 2.0) 1-16X SPEED (Ver. 2.1)
DVD-R (DL):	2-4X SPEED (Ver. 3.0) 2-8X SPEED (Ver. 3.0)
DVD-RW:	1X SPEED (Ver. 1.1) 1-2X SPEED (Ver. 1.1) 2-4X SPEED (Ver. 1.2) 2-6X SPEED (Ver. 1.2)
+R (SL):	2.4X SPEED (Ver. 1.0) 2.4-4X SPEED (Ver. 1.1) 2.4-8X SPEED (Ver. 1.2) 2.4-16X SPEED (Ver. 1.3)
+R (DL):	2.4X SPEED (Ver. 1.0) 2.4-8X SPEED (Ver. 1.1)
+RW:	2.4X SPEED (Ver. 1.1) 2.4-4X SPEED (Ver. 1.2)

Recording system:

DVD-RAM:	DVD Video Recording format
DVD-R:	DVD-Video format
DVD-R DL (Dual Layer):	DVD-Video format
DVD-RW:	DVD-Video format
+R	
+R DL (Double Layer)	
+RW	

Recording time:

Max. 8 hours (using 4.7 GB disc)	
XP: Approx. 1 hour	SP: Approx. 2 hours
LP: Approx. 4 hours	EP: Approx. 6 hours or 8 hours

Playable discs:

DVD-RAM:	DVD Video Recording format
DVD-R:	DVD-Video format, MP3, JPEG, DivX
DVD-R DL (Dual Layer):	DVD-Video format, MP3, JPEG, DivX
DVD-RW:	DVD Video Recording format, DVD-Video format
+R	
+R DL (Double Layer)	
+RW	
DVD-Video, CD-Audio (CD-DA)	
CD-R/CD-RW (CD-DA, MP3, JPEG, DivX)	

Optical pick-up:

System with 1 lens, 2 integration units
(662 nm wavelength for DVDs, 780 nm wavelength for CDs)

LASER Specification:

Class I LASER Product	
Wave Length:	780 nm (CDs) 662 nm (DVDs)
Laser Power:	No hazardous radiation is emitted with the safety protection

Television system:

TV system:	NTSC system, 525 lines, 60 fields
Antenna reception input:	
Analog TV Channel:	2 ch to 69 ch
Analog CATV Channel:	1 ch to 135 ch
Digital TV Channel:	2 ch to 69 ch
Digital CATV Channel:	1 ch to 135 ch
RF converter output:	Provide 3 ch or 4 ch

Quick Start for Recording

1 Sec. Quick Start for Recording on DVD-RAM*

* From the power off state, recording on DVD-RAM starts about 1 second after first pressing the Power button and then sequentially pressing the REC button (Quick Start Mode).

Video system:

Recording system: (for DVD)	MPEG2 (Hybrid VBR)
Input:	LINE (pin jack) × 2 S connector × 2
	Y: 1.0 Vp-p; 75 Ω C: 0.286 Vp-p; 75 Ω
Output: (for DVD PRIORITY 1)	LINE (pin jack) × 2 S connector × 1
	Y: 1.0 Vp-p; 75 Ω C: 0.286 Vp-p; 75 Ω
Component video output: (for DVD PRIORITY)	Y, P _B , P _R × 1 (480i/480p/720p/1080i)
	Y: 1.0 Vp-p; 75 Ω P _B : 0.7 Vp-p; 75 Ω P _R : 0.7 Vp-p; 75 Ω

Audio system:

Recording system: (for DVD)	Dolby Digital (2 ch)
Analog Input:	LINE (pin jack) × 2 Reference input: 309 mVrms FS: 2 Vrms (1 kHz, 0 dB) Input impedance: 22 kΩ
Analog Output: (for DVD PRIORITY 1)	LINE (pin jack) × 2 Reference output: 309 mVrms FS: 2 Vrms (1 kHz, 0 dB) Output impedance: 1 kΩ (Load impedance: 10 kΩ)
Number of channels: (for DVD)	Recording: 2 channels Playback: 2 channels
Number of track: (for VHS)	HiFi: 2 track Normal: 1 track
Digital Output: (for DVD PRIORITY)	Digital audio optical output connector × 1 (PCM, Dolby Digital, DTS)

VHS:

Recording format:	VHS Video Cassette System Standard with FM audio
Heads:	4 Helical Scan Heads for Video 2 Helical Scan Heads for FM audio 1 Fixed Head for Normal audio
Tape speed/Recording time:	SP: 33.35 mm/s, 120 min (with T-120 cassette) EP: 11.12 mm/s, 360 min (with T-120 cassette)
FF/REW time:	FF/REW: Approx. 60 s (with T-120 cassette) Jet REW: Approx. 43 s (with T-120 cassette)

HDMI Output:

19 Pin type A × 1

HDMI: 480i/480p/720p/1080i/1080p

● This unit supports "HDAVI Control 3" function.

DV Input: IEEE 1394 Standard, 4 Pin × 1

USB Port: Type A × 1

SD Card Slot: SD Memory Card Slot: × 1

Compatible media:

SD Memory Card*

*Includes SDHC compatible card (Class is not supported.) and miniSD Cards (A miniSD Adaptor needs to be inserted.)

Format: FAT12, FAT16* (In case of SD Memory Card)

FAT32* (In case of SDHC Memory Card)

*Long file name is unsupported.

Still Picture (JPEG)

Image File Format: JPEG conforming DCF (Design rule for Camera File system) Sub sampling 4:2:2, 4:2:0

Number of pixels: 34 × 34 to 6144 × 4096

Regional Code: # 1

Clock unit: Quartz-controlled 12-hour digital display

Operating temperature range:
5 °C to 40 °C (41 °F to 104 °F)

Operating humidity range:
35 % to 80 % RH (no condensation)

Dimensions (W × H × D):
430 mm × 84 mm × 345 mm
[16⁵/₁₆" × 3³/₁₆" × 13⁵/₁₆"]

Mass (Weight): Approx. 5.4 kg (11.90 lbs)

● Specifications are subject to change without notice.
● Useable capacity will be less (SD Card).

Product Service

- 1. Damage requiring service**—The unit should be serviced by qualified service personnel if:
 - (a) The AC power supply cord or AC adaptor has been damaged; or
 - (b) Objects or liquids have gotten into the unit; or
 - (c) The unit has been exposed to rain; or
 - (d) The unit does not operate normally or exhibits a marked change in performance; or
 - (e) The unit has been dropped or the cabinet damaged.
- 2. Servicing**—Do not attempt to service the unit beyond that described in these operating instructions. Refer all other servicing to authorized servicing personnel.
- 3. Replacement parts**—When parts need replacing ensure the servicer uses parts specified by the manufacturer or parts that have the same characteristics as the original parts. Unauthorized substitutes may result in fire, electric shock, or other hazards.
- 4. Safety check**—After repairs or service, ask the servicer to perform safety checks to confirm that the unit is in proper working condition.

Product information

For product information or assistance with product operation: In the U.S.A., refer to “Customer Services Directory” on page 94. In Canada, contact the Panasonic Canada Inc. Customer Care Centre at 1-800-561-5505, or visit the website (www.panasonic.ca), or an authorized Servicentre closest to you.

The model number and serial number of this product can be found on either the back or the bottom of the unit. Please note them in the space provided below and keep for future reference.

MODEL NUMBER

SERIAL NUMBER

User memo:

DATE OF PURCHASE

DEALER NAME

DEALER ADDRESS

TELEPHONE NUMBER

Manufactured under license from Dolby Laboratories. Dolby and the double-D symbol are trademarks of Dolby Laboratories.

“DTS” is a registered trademark of DTS, Inc. and “DTS 2.0+Digital Out” is a trademark of DTS, Inc.

U.S. Patent Nos. 6,836,549; 6,381,747; 7,050,698; 6,516,132; and 5,583,936.

This product incorporates copyright protection technology that is protected by U.S. patents and other intellectual property rights. Use of this copyright protection technology must be authorized by Macrovision, and is intended for home and other limited viewing uses only unless otherwise authorized by Macrovision. Reverse engineering or disassembly is prohibited.

Official DivX® Certified product.
Plays all versions of DivX® video (including DivX®6) with standard playback of DivX® media files.
DivX, DivX Certified, and associated logos are trademarks of DivX, Inc. and are used under license.

HDMI, the HDMI logo and High-Definition Multimedia Interface are trademarks or registered trademarks of HDMI Licensing LLC.

HDAVI Control™ is a trademark of Matsushita Electric Industrial Co., Ltd.

EZ Sync™ is a trademark of Matsushita Electric Industrial Co., Ltd.

VIERA Link™ is a trademark of Matsushita Electric Industrial Co., Ltd.

- SDHC Logo is a trademark.
- Portions of this product are protected under copyright law and are provided under license by ARIS/SOLANA/4C.

Limited Warranty (ONLY FOR U.S.A.)

Panasonic Consumer Electronics Company,
Division of Panasonic Corporation of North America
One Panasonic Way Secaucus, New Jersey 07094

Panasonic Puerto Rico, Inc.
Ave. 65 de Infantería, Km. 9.5
San Gabriel Industrial Park, Carolina, Puerto Rico 00985

Panasonic DVD Recorder Limited Warranty

Limited Warranty Coverage

If your product does not work properly because of a defect in materials or workmanship, Panasonic Consumer Electronics Company or Panasonic Puerto Rico, Inc. (collectively referred to as "the warrantor") will, for the length of the period indicated on the chart below, which starts with the date of original purchase ("warranty period"), at its option either (a) repair your product with new or refurbished parts, or (b) replace it with a new or a refurbished product. The decision to repair or replace will be made by the warrantor.

Product or Part Name	Parts	Labor
DVD Recorder	One (1) Year	One (1) Year
Rechargeable Batteries, DVD-RAM Disc (in exchange for defective item)	Ten (10) Days	Not Applicable

During the "Labor" warranty period there will be no charge for labor. During the "Parts" warranty period, there will be no charge for parts. You must carry-in or mail-in your product during the warranty period. If non-rechargeable batteries are included, they are not warranted. This warranty only applies to products purchased and serviced in the United States or Puerto Rico. This warranty is extended only to the original purchaser of a new product which was not sold "as is". A purchase receipt or other proof of the original purchase date is required for warranty service.

Carry-In or Mail-In Service

For Carry-In or Mail-In Service in the United States call 1-800-211-PANA (7262) or visit Panasonic Web Site: <http://www.panasonic.com>
For assistance in Puerto Rico call Panasonic Puerto Rico, Inc. (787)-750-4300 or fax (787)-768-2910.

Limited Warranty Limits And Exclusions

This warranty ONLY COVERS failures due to defects in materials or workmanship, and DOES NOT COVER normal wear and tear or cosmetic damage. The warranty ALSO DOES NOT COVER damages which occurred in shipment, or failures which are caused by products not supplied by the warrantor, or failures which result from accidents, misuse, abuse, neglect, mishandling, misapplication, alteration, faulty installation, set-up adjustments, misadjustment of consumer controls, improper maintenance, power line surge, lightning damage, modification, or commercial use (such as in a hotel, office, restaurant, or other business), rental use of the product, service by anyone other than a Factory Servicenter or other Authorized Servicer, or damage that is attributable to acts of God.

THERE ARE NO EXPRESS WARRANTIES EXCEPT AS LISTED UNDER "LIMITED WARRANTY COVERAGE". THE WARRANTOR IS NOT LIABLE FOR INCIDENTAL OR CONSEQUENTIAL DAMAGES RESULTING FROM THE USE OF THIS PRODUCT, OR ARISING OUT OF ANY BREACH OF THIS WARRANTY. (As examples, this excludes damages for lost time, travel to and from the servicer, loss of media or images, data or other recorded content. The items listed are not exclusive, but are for illustration only.)
ALL EXPRESS AND IMPLIED WARRANTIES, INCLUDING THE WARRANTY OF MERCHANTABILITY, ARE LIMITED TO THE PERIOD OF THE LIMITED WARRANTY.

Some states do not allow the exclusion or limitation of incidental or consequential damages, or limitations on how long an implied warranty lasts, so the exclusions may not apply to you.

This warranty gives you specific legal rights and you may also have other rights which vary from state to state. If a problem with this product develops during or after the warranty period, you may contact your dealer or Servicenter. If the problem is not handled to your satisfaction, then write to the warrantor's Consumer Affairs Department at the addresses listed for the warrantor.

PARTS AND SERVICE WHICH ARE NOT COVERED BY THIS LIMITED WARRANTY ARE YOUR RESPONSIBILITY.

Customer Services Directory

Obtain Product Information and Operating Assistance; locate your nearest Dealer or Servicenter; purchase Parts and Accessories; or make Customer Service and Literature requests by visiting our Web Site at:

<http://www.panasonic.com/consumersupport>

or, contact us via the web at:

<http://www.panasonic.com/contactinfo>

You may also contact us directly at:

1-800-211-PANA (7262),

Monday-Friday 9 am-9 pm; Saturday-Sunday 10 am-7 pm, EST.

For hearing or speech impaired TTY users, TTY : 1-877-833-8855

Accessory Purchases

Purchase Parts, Accessories and Instruction Books online for all Panasonic Products by visiting our Web Site at:

<http://www.pstc.panasonic.com>

or, send your request by E-mail to:

npcparts@us.panasonic.com

You may also contact us directly at:

1-800-332-5368 (Phone) 1-800-237-9080 (Fax Only) (Monday – Friday 9 am to 9 pm, EST.)

Panasonic Service and Technology Company

20421 84th Avenue South, Kent, WA 98032

(We Accept Visa, MasterCard, Discover Card, American Express, and Personal Checks)

For hearing or speech impaired TTY users, TTY : 1-866-605-1277

Service in Puerto Rico

Panasonic Puerto Rico, Inc.

Ave. 65 de Infantería, Km. 9.5, San Gabriel Industrial Park, Carolina, Puerto Rico 00985

Phone (787)750-4300, Fax (787)768-2910

As of January 2007

Limited Warranty (ONLY FOR CANADA)

Panasonic Canada Inc.

PANASONIC PRODUCT – LIMITED WARRANTY

Panasonic Canada Inc. warrants this product to be free from defects in material and workmanship and agrees to remedy any such defect for a period as stated below from the date of original purchase.

Technics Audio Product	One (1) year, parts and labour
Panasonic Portable/Clock Radio (without Tape, CD, MD)	One (1) year, parts and labour
Panasonic Audio/SD Audio Product	One (1) year, parts and labour
Panasonic DVD Product	One (1) year, parts and labour
Panasonic Combination DVD Player/VCR	One (1) year, parts and labour
Panasonic Combination DVD Recorder/VCR	One (1) year, parts and labour
Accessories including rechargeable batteries	Ninety (90) days

LIMITATIONS AND EXCLUSIONS

This warranty does not apply to products purchased outside Canada or to any product which has been improperly installed, subjected to usage for which the product was not designed, misused or abused, damaged during shipping, or which has been altered or repaired in any way that affects the reliability or detracts from the performance, nor does it cover any product which is used commercially. Dry cell batteries are also excluded from coverage under this warranty.

This warranty is extended to the original end user purchaser only. A purchase receipt or other proof of date of original purchase is required before warranty service is performed.

THIS EXPRESS, LIMITED WARRANTY IS IN LIEU OF ALL OTHER WARRANTIES, EXPRESS OR IMPLIED, INCLUDING ANY IMPLIED WARRANTIES OF MERCHANTABILITY AND FITNESS FOR A PARTICULAR PURPOSE.

IN NO EVENT WILL PANASONIC CANADA INC. BE LIABLE FOR ANY SPECIAL, INDIRECT OR CONSEQUENTIAL DAMAGES.

In certain instances, some jurisdictions do not allow the exclusion or limitation of incidental or consequential damages, or the exclusion of implied warranties, so the above limitations and exclusions may not be applicable.

WARRANTY SERVICE

FOR PRODUCT OPERATION ASSISTANCE, please contact:

Our Customer Care Centre:	Telephone #:	(905) 624-5505
	1-800 #:	1-800-561-5505
	Fax #:	(905) 238-2360
	Email link:	"Customer support" on www.panasonic.ca

FOR PRODUCT REPAIRS, please locate your nearest Authorized Servicentre at www.panasonic.ca :

Link : "Servicentres™ locator" under "Customer support"

IF YOU SHIP THE PRODUCT TO A SERVICENTRE

Carefully pack and send prepaid, adequately insured and preferably in the original carton.
Include details of the defect claimed, and proof of date of original purchase.

Referencia rápida en español (Spanish Quick Reference)

Conexión básica

Nota: Puede que los terminales en el panel trasero de su TV no sean similares a como se ilustran a continuación. Por favor consulte las etiquetas de los terminales con atención para asegurar conexiones correctas.

Conexión a una televisión mediante señal directa de cable o antena (sin pasar por receptor de cable ni receptor satelital)

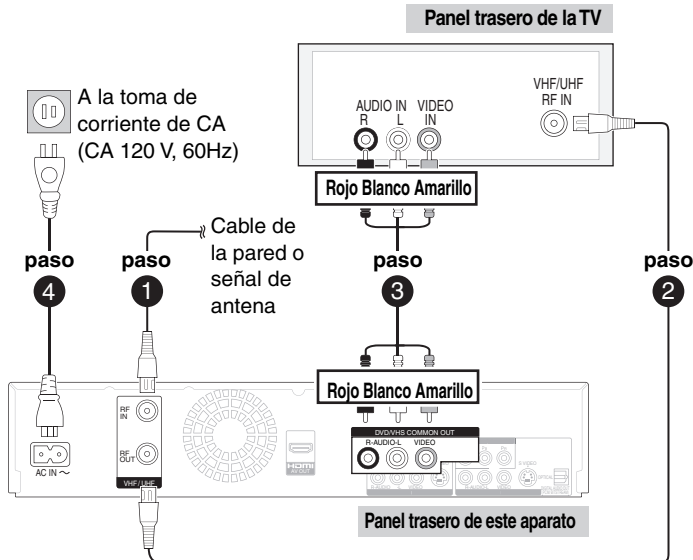

■ Conexión (con un cable de audio/vídeo)

Conéctelo en orden consecutivo del paso 1 al 4.

- Después de conectarlo, fije el canal de salida RF en posición "OFF" (→ derecha).

■ Conexión (sin cable de audio/vídeo)

No es necesario que conecte el paso 3.

- Después de conectarlo, fije el canal de salida RF en posición "CH3" ó "CH4" (→ derecha).

Para disfrutar de una mejor calidad de imagen

- El terminal S VIDEO OUT logra una imagen más viva que la del terminal VIDEO OUT. (Los resultados reales dependen de la televisión).
- Los terminales COMPONENT VIDEO OUT en este aparato se pueden utilizar para la salida entrelazada o progresiva, para proporcionar una imagen más pura que la del terminal S VIDEO OUT.
- Cuando esté conectado a una unidad compatible con señales HDMI, se transmitirá una señal digital de audio y vídeo sin comprimir, lo que le permitirá disfrutar de mayor calidad de imagen y sonido con solo un cable.

Preparación:

Ponga en marcha el televisor y seleccione la fuente de imagen adecuada correcta de acuerdo a las conexiones de la unidad. (Por ejemplo: entrada AV, CH3 ó CH4.)

Ajuste de los canales y el reloj

- 1** para encender el aparato.
- Cuando esta unidad esté conectada a un televisor Panasonic (VIERA) que admita señales HDAVI Control 3 y esté correctamente configurado, éste automáticamente recopilará la información de configuración del televisor. Siga los mensajes que le aparecerán en pantalla.

- 2** para seleccionar una salida RF en el canal número.
- Conexión (sin cable de audio/vídeo): Cuando vea la pantalla delantera de la unidad, seleccione "CH3" ó "CH4". Si la selección es correcta, le aparecerá la ventana relativa al paso 3.
 - Conexión (con un cable de audio/vídeo): Cuando vea la pantalla delantera de la unidad, seleccione "OFF".

- 3** para seleccionar el idioma, y luego para confirmar.



- 4** para seleccionar la relación de aspecto de la TV en "TV de 4:3" o en "TV ancho de 16:9", y luego para confirmar.

- Al conectar a una TV con relación de aspecto 4:3 seleccione "TV de 4:3".
- Al conectar a una TV con pantalla panorámica de 16:9 seleccione "TV ancho de 16:9".

- 5** para seleccionar la función de inicio rápido "Encendido" u "Apagado", luego para confirmar.

- 6** para seleccionar si se recibirá o no señal de TV desde el terminal RF IN del aparato y luego para confirmar.

- Si selecciona "No", entonces se muestra la pantalla "Ajuste manual del reloj" en el aparato (→ 97).

7 ▲, ▼ para seleccionar el “Antena” o “Cable”, luego 

8  para iniciar el ajuste automático de canales/reloj.

9 Confirmar la hora, luego 
 –HL (horario de verano) muestra el ajuste para el horario de verano.
 –Huso h. (zona horaria) muestra la diferencia de hora con la hora del Meridiano de Greenwich (GMT).



Consejos prácticos

Cuando la pantalla “Ajuste manual del reloj” se muestra

- Oprima [◀, ▶] para seleccionar la opción que desee modificar y oprima [▲, ▼] para cambiar el ajuste.
- Oprima [OK].
El reloj se pone en funcionamiento.

Cómo ver un programa de televisión

1  para encender el aparato.

Si ha conectado la unidad y el televisor sin un cable de audio/vídeo o sin cable HDMI.

2  para ver el video desde este aparato.

- El indicador TV en el panel delantero de este aparato no se ilumina.
- Al oprimir [VCR/TV] de nuevo, el indicador TV en el panel delantero de este aparato se iluminará, y podrá ver la TV directamente sin tener que pasar la señal a través del mismo (modo TV).

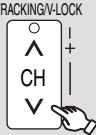
3  para seleccionar el canal deseado.

También puede seleccionar canales con los botones numéricos.

•Para introducir directamente los canales para emisiones análogas y digitales:

Modo Antena:
 p.ej., “3”: [0] → [3] → [OK]
 “13”: [1] → [3] → [OK]

Modo Cable TV:
 p.ej., “5”: [0] → [0] → [5] → [OK]
 “15”: [0] → [1] → [5] → [OK]

•Para introducir el número de canal inferior para una emisión digital:

Modo Antena:
 p.ej., “3-1”: [3] → [-] → [1] → [OK]
 “13-1”: [1] → [3] → [1] → [OK]

Modo Cable TV:
 p.ej., “1-1”: [1] → [-] → [1] → [OK]
 “15-1”: [1] → [5] → [-] → [1] → [OK]

Reproducción de discos o videocasetes

RAM -R -R DL -RW(V) +R +R DL +RW DVD-V -RW(VR) CD VHS

1  para encender el aparato.

2  para seleccionar el dispositivo (DVD o VHS).

3 Inserte un disco o videocasete VHS.

4 

Consejos prácticos

Detener la reproducción
 Oprima [■ STOP].

- DVD**
- La posición de detención se memoriza.
 - La posición de detención se borrará al pulsar el botón [■ STOP] dos o más veces, o al pulsar [▲ OPEN/CLOSE].

Pausar la reproducción
 Oprima [▬ PAUSE].
 –Oprima de nuevo para reiniciar la reproducción.

Selección de grabaciones para reproducir
RAM -R -R DL -RW(V) +R +R DL +RW -RW(VR)
 Realice los pasos 1 a 3 de “Reproducción de discos o videocasetes” (→ arriba).

- Oprima [DIRECT NAVIGATOR].
- Oprima [▲, ▼, ▶, ◀] para seleccionar la grabación que desea ver, luego oprima [OK].

Referencia rápida en español (Spanish Quick Reference)

Grabación de programas de televisión

RAM -R -R DL -RW(V) +R +R DL +RW VHS

Las emisiones digitales no pueden ser grabadas en cintas de video.

Preparación:

- **RAM** Si el disco está protegido, libere la protección.
- **VHS** Asegúrese de que la pestaña contra borradura accidental esté intacta.
- Use un disco o casete VHS con suficiente espacio en blanco disponible.

1  para encender el aparato.

2  para seleccionar el dispositivo (DVD o VHS).

3 Inserte un disco o videocasete VHS.

4  para seleccionar el canal deseado.
–Para seleccionar con los botones numéricos (→ 97)

5  para seleccionar el modo de grabación.

6  para comenzar a grabar.



Consejos prácticos

Pausar la grabación

Oprima [PAUSE].

–Oprima de nuevo para reiniciar la grabación.

Detener la grabación

Oprima [STOP].

Grabación programada

RAM -R -R DL -RW(V) +R +R DL +RW VHS

Las emisiones digitales no pueden ser grabadas en cintas de video.

Preparación:

- **RAM** Si el disco está protegido, libere la protección.
- **VHS** Asegúrese de que la pestaña contra borradura accidental esté intacta.
- Inserte un disco o casete VHS con suficiente espacio en blanco disponible.
- Confirme que el reloj en el visualizador del aparato esté ajustado con la hora correcta.
- Si está conectado vía un receptor de señal de cable o satelital, ajuste el canal ahí antes de que inicie la grabación programada.

1 

2 ▲, ▼ para seleccionar “Nueva grabación programada”, luego 

3 ◀, ▶ para desplazarse a través de los elementos, y ▲, ▼ para ajustarlos.

Canal/Entrada – Emisora de TV/Entrada externa

Fecha/Frecuencia – Puede ajustar un programa diario o semanal.

Act. (hora de inicio) / Des. (hora de finalización)
– Mantenga el botón oprimido para cambiar en incrementos de 30 minutos.

Unid. – DVD o VHS

Modo – Modo de grabación

Nombre (sólo para discos)

– Oprima [OK], para introducir el texto en la pantalla de nombre.

Canal, Subtítulo

Vista preliminar del canal seleccionado

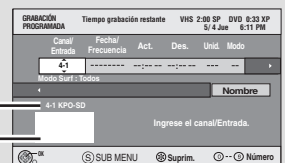

4  –Repita los pasos 2 a 4 para programar otras grabaciones.

5  cuando haya finalizado los cambios de programación.
–El indicador “Ⓟ” se enciende en el visualizador del aparato.

Copiar

Copiar (VHS → DVD)

VHS → RAM -R -R DL -RW(V) +R +R DL +RW

Preparación:

- **RAM** Si el disco está protegido, libere la protección.
- Inserte un disco con suficiente espacio en blanco disponible.
- Seleccione el modo de grabación de DVD.
- Inserte la cinta VHS que contenga el programa a ser copiado. Detenga la cinta en el punto desde el que quiera empezar a copiar.

En el aparato principal

- 1 Mientras que tanto el dispositivo de DVD, como de VHS se encuentran detenidos



Oprima y mantenga oprimiendo por alrededor de 3 segundos.

-R -R DL -RW(V) +R +R DL

- 2a  para copiar y automáticamente finalizar al acabar.

-Si oprime [■ STOP], puede cancelar el copiado.

- O -

- 2b  para copiar sin finalizar.

-Si oprime [■ STOP], puede cancelar el copiado.

-La copia se finaliza automáticamente cuando la cinta alcanza su final o cuando el disco se llena.

Copiar (DVD → VHS)

RAM -R -R DL -RW(V) -RW(VR) +R +R DL +RW

→ VHS

Preparación:

- **VHS** Asegúrese de que la pestaña contra borrado accidental esté intacta.
- Inserte una cinta VHS con suficiente espacio en blanco disponible. Detenga la cinta en el punto al que quiera empezar a copiar.
- Seleccione el modo de grabación de VHS.
- Inserte el disco que contenga el programa a ser copiado.

En el aparato principal

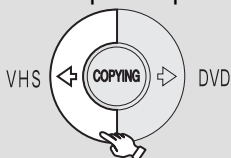

Oprima y mantenga oprimiendo por alrededor de 3 segundos.

-La copia automáticamente se detiene cuando la reproducción del disco finaliza o cuando la cinta llega al final.

Borrado de grabaciones con el navegador de borrado (BORRAR Navegador)

Importante: Una vez borrados, los contenidos no podrán recuperarse.

RAM -R -R DL -RW(V) +R +R DL +RW

Preparación:

- Inserte un disco y oprima [▲ OPEN/CLOSE] de nuevo para cerrar la bandeja.
- Si el disco está protegido, libere la protección.

- 1  para seleccionar el dispositivo DVD.

- 2 Con el aparato sin estar en ejecución



- 3 ▲, ▼ para seleccionar "Borrar", y luego 

- 4 ▲, ▼, ◀, ▶ para seleccionar la grabación, y luego 

- 5 ◀ para seleccionar "Borrar", y luego 



Consejos prácticos

Para volver a la pantalla anterior

Oprima [RETURN].

Para ver otras páginas

Oprima [▲, ▼, ◀, ▶] para seleccionar "Atrás" o "Avanza" y oprima [OK].

- También puede oprimir [◀◀, ▶▶] para ver otras páginas.

Edición múltiple

Seleccione con [▲, ▼, ◀, ▶] y oprima [■ PAUSE]. (Repetir.)

- Aparece una marca de verificación. Oprima [■ PAUSE] de nuevo para cancelar.

Borrar grabaciones durante la reproducción

1. Durante la reproducción, pulse [DELETE].
2. Pulse [◀] para seleccionar "Borrar"; a continuación, pulse [OK].

Index

- A** **Angle** 50
- Audio**
 - attributes 50
 - language 59
 - receiving, recording 25, 61
- Auto Bilingual Selection** 38
- Auto Mode** 24
- C** **Change Thumbnail** 44
- Channel**
 - adding, deleting 55
 - audio 50
 - captions 56
 - favorite channel 16, 55
 - Set Channels Automatically 55
- Chasing Playback** 26
- Cleaning**
 - disc 75
 - lens 3
 - main unit 3
 - video heads 3
- Clock Settings** 57
- Closed Caption** 63
- CM Skip** 31
- Connection**
 - amplifier, system component 72
 - antenna 8, 81
 - cable box 9
 - DV IN terminal 29
 - external device 28, 29
 - HDMI 11
 - satellite receiver 10
 - television 8, 9, 10, 11, 70, 71
- Copying Recordings** 20, 21
- Copying Still Pictures** 48
- CPRM** 91
- Create Chapter** 31, 45
- Create DVD Top Menu** 54
- D** **Delete**
 - album 47, 49
 - all recordings 53
 - chapter 45
 - recording 22, 43
 - still picture 47, 49
- Delete Navigator** 22, 49
- Dialog Enhancer** 51
- Direct Navigator** 30, 43
- Divide Recording** 44
- DivX** 36, 76, 91
- DNR** 51
- DST** 13
- DV Camcorder recording** 29
- DVD-RAM, DVD-R, DVD-R DL, DVD-RW, +R, +R DL, +RW** 74
- E** **Enter name**
 - album 42, 47
 - disc 42, 52
 - recording 42, 43
- Erase prevention tab** 15
- External Device** 28, 29
- F** **Finalize** 25, 54, 91
- Flexible Recording** 26
- Format** 25, 53, 91
- FR (Flexible Recording) Mode** 24
- FUNCTIONS Window** 42
- H** **HDAVI Control** 40, 41
- HDMI** 11, 65, 72, 91
- J** **Jet Rewind** 37
- JPEG** 34, 76, 91
- L** **Language**
 - code list 51
 - on-screen 62
 - soundtrack 50
 - subtitle 50
- M** **Menu**
 - DivX 36
 - MP3 33
 - on-screen 50
 - Pictures 34
 - Setup 55
- Mode**
 - recording 24
 - still mode 60
- MP3** 33, 76, 91
- N** **Noise reduction (NR)**
 - DNR 51
 - Line-in NR 51
- O** **On-screen**
 - language 62
 - menus 50
 - status messages 39
- P** **Parental Rating** 56
- PCM Down Conversion** 61
- Picture** 51
- Playlist** 32
- Progressive** 91
- Properties**
 - playlist 32
 - recording 43
 - still picture 35
- Protection**
 - album 47
 - card 52
 - cartridge 52
 - disc 52
 - recording 44
 - still picture 47
- Q** **Quick Start** 58
- Quick View** 31
- R** **Ratings** 59
- Record**
 - Flexible Recording 26
 - from a VCR 28
 - mode 24
 - scheduled 19, 27
- Remaining tape time** 39
- Repeat play** 38, 50
- Restore Default Settings** 59
- Resume play function** 17
- S** **Scheduled recording** 19, 27
- SD Card** 15, 73
- Setup menu** 55
- Simultaneous record and playback** 26
- Soundtrack** 50
- Status Messages** 39
- Still Pictures**
 - Copying 48
 - edit 46
 - play 34
- Subtitle** 50
- S-VHS Quasi Playback (SQPB)** 38
- T** **Thumbnail** 91
- Time Slip** 31
- Tracking** 38
- TV aspect** 64
- U** **USB**
 - Copy 48
 - Insert 15
 - Play
 - DivX 36
 - MP3 33
 - still picture 34
 - Supported formats 73
- V** **VHS settings** 66
- VIERA Link** 40, 41, 66
- VISS** 37
- VP mode** 24
- V. Surround Sound** 51

–If you see this symbol–

Information on Disposal in other Countries outside the European Union



This symbol is only valid in the European Union. If you wish to discard this product, please contact your local authorities or dealer and ask for the correct method of disposal.



This manual was printed with soy based ink.

For U.S.A.

Panasonic Consumer Electronics Company, Division of Panasonic Corporation of North America
 One Panasonic Way Secaucus,
 New Jersey 07094
<http://www.panasonic.com>

© 2007 Matsushita Electric Industrial Co., Ltd.
 Printed in China

For Canada

Panasonic Puerto Rico, Inc.
 Ave. 65 de Infantería, Km. 9.5
 San Gabriel Industrial Park, Carolina,
 Puerto Rico 00985

Panasonic Canada Inc.
 5770 Ambler Drive
 Mississauga, Ontario
 L4W 2T3
www.panasonic.ca

(En) (Sp)

RQT9056-P
 F1207SN0