

Operating Instructions

DVD Recorder Model No. **DMR-ES40V**

DIGA

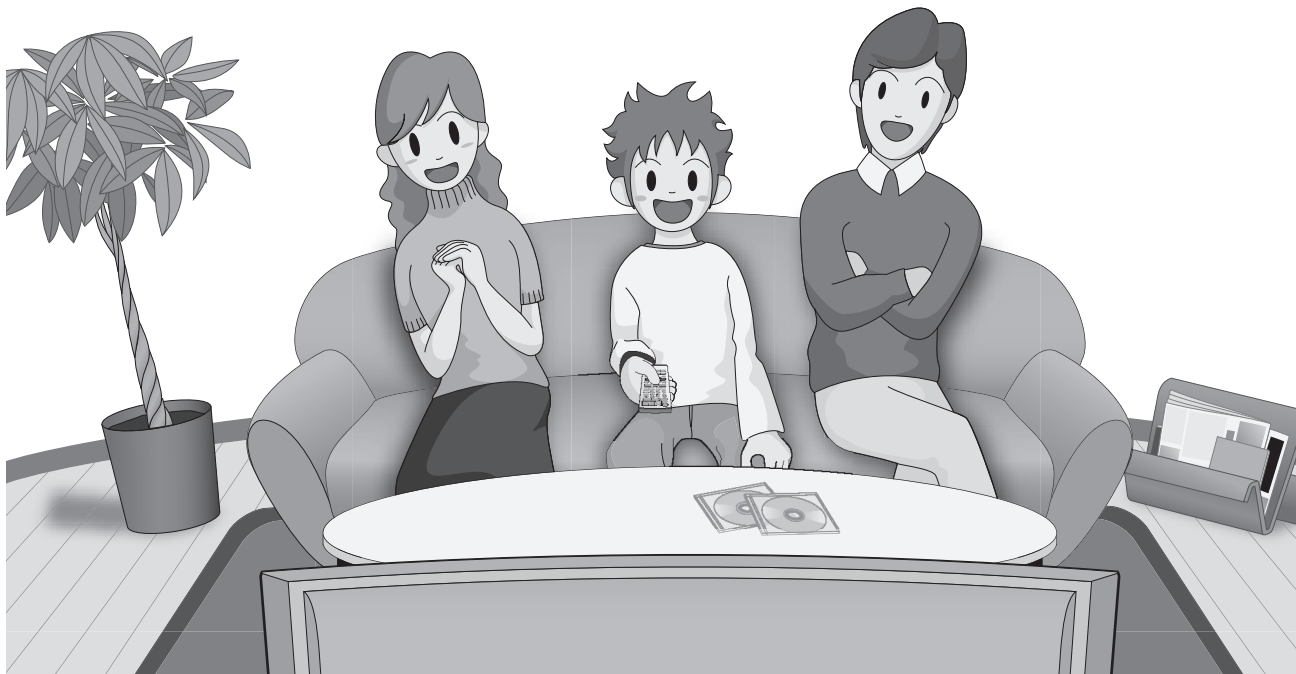

Dear Customer

Thank you for purchasing this product. For optimum performance and safety, please read these instructions carefully.

Before connecting, operating or adjusting this product, please read the instructions completely.
Please keep this manual for future reference.

If you have any questions contact

In the U.S.A.: 1-800-211-PANA (7262)

In Canada: 1-800-561-5505

For U.S.A. only
The warranty can be found on page 66.

For Canada only
The warranty can be found on page 67.

La guía rápida en español se encuentra en la página 70-79.

Getting started

Warning and Important Information

CAUTION!

THIS PRODUCT UTILIZES A LASER.
 USE OF CONTROLS OR ADJUSTMENTS OR PERFORMANCE OF PROCEDURES OTHER THAN THOSE SPECIFIED HEREIN MAY RESULT IN HAZARDOUS RADIATION EXPOSURE. DO NOT OPEN COVERS AND DO NOT REPAIR YOURSELF. REFER SERVICING TO QUALIFIED PERSONNEL.

WARNING:

TO REDUCE THE RISK OF FIRE, ELECTRIC SHOCK OR PRODUCT DAMAGE, DO NOT EXPOSE THIS APPARATUS TO RAIN, MOISTURE, DRIPPING OR SPLASHING AND THAT NO OBJECTS FILLED WITH LIQUIDS, SUCH AS VASES, SHALL BE PLACED ON THE APPARATUS.

CAUTION!

DO NOT INSTALL OR PLACE THIS UNIT IN A BOOKCASE, BUILT-IN CABINET OR IN ANOTHER CONFINED SPACE. ENSURE THE UNIT IS WELL VENTILATED. TO PREVENT RISK OF ELECTRIC SHOCK OR FIRE HAZARD DUE TO OVERHEATING, ENSURE THAT CURTAINS AND ANY OTHER MATERIALS DO NOT OBSTRUCT THE VENTILATION VENTS.



CAUTION

RISK OF ELECTRIC SHOCK
DO NOT OPEN



CAUTION: TO REDUCE THE RISK OF ELECTRIC SHOCK, DO NOT REMOVE SCREWS. NO USER-SERVICEABLE PARTS INSIDE. REFER SERVICING TO QUALIFIED SERVICE PERSONNEL.



The lightning flash with arrowhead symbol, within an equilateral triangle, is intended to alert the user to the presence of uninsulated "dangerous voltage" within the product's enclosure that may be of sufficient magnitude to constitute a risk of electric shock to persons.



The exclamation point within an equilateral triangle is intended to alert the user to the presence of important operating and maintenance (servicing) instructions in the literature accompanying the appliance.

-If you see this symbol-

Information on Disposal in other Countries outside the European Union



This symbol is only valid in the European Union. If you wish to discard this product, please contact your local authorities or dealer and ask for the correct method of disposal.

THE FOLLOWING APPLIES ONLY IN THE U.S.A.

Note to CATV system installer:

This reminder is provided to call the CATV system installer's attention to Article 820-40 of the NEC that provides guidelines for proper grounding and, in particular, specifies that the cable ground shall be connected to the grounding system of the building, as close to the point of cable entry as practical.

The socket outlet shall be installed near the equipment and easily accessible or the mains plug or an appliance coupler shall remain readily operable.

THE FOLLOWING APPLIES ONLY IN THE U.S.A.

FCC Note:

This equipment has been tested and found to comply with the limits for a Class B digital device, pursuant to Part 15 of the FCC Rules. These limits are designed to provide reasonable protection against harmful interference in a residential installation. This equipment generates, uses, and can radiate radio frequency energy and, if not installed and used in accordance with the instructions, may cause harmful interference to radio communications. However, there is no guarantee that interference will not occur in a particular installation. If this equipment does cause harmful interference to radio or television reception, which can be determined by turning the equipment off and on, the user is encouraged to try to correct the interference by one or more of the following measures:

- Reorient or relocate the receiving antenna.
- Increase the separation between the equipment and receiver.
- Connect the equipment into an outlet on a circuit different from that to which the receiver is connected.
- Consult the dealer or an experienced radio/TV technician for help.

FCC Caution: To assure continued compliance, follow the attached installation instructions and use only shielded interface cables when connecting to peripheral devices. Any changes or modifications not expressly approved by the party responsible for compliance could void the user's authority to operate this equipment.

This device complies with Part 15 of the FCC Rules. Operation is subject to the following two conditions: (1) This device may not cause harmful interference, and (2) this device must accept any interference received, including interference that may cause undesired operation.

Responsible Party:
 Panasonic Corporation of North America
 One Panasonic Way
 Secaucus, NJ 07094
 Telephone No.: 1-800-211-7262

DANGER	• VISIBLE AND INVISIBLE LASER RADIATION WHEN OPEN. AVOID DIRECT EXPOSURE TO BEAM. (FDA 21 CFR)
CAUTION	• VISIBLE AND INVISIBLE LASER RADIATION WHEN OPEN. AVOID EXPOSURE TO BEAM. (IEC60825-1)
ATTENTION	• RAYONNEMENT LASER VISIBLE ET INVISIBLE EN CAS D'OUVERTURE. EXPOSITION DANGEREUSE AU FAISCEAU.
ADVARSEL	• SYNLIG OG USYNLIG LASERSTRÅLING VED ÅBNING. UNDGÅ UDSETTELSE FOR STRÅLING.
VARO!	• AVATTAESSA OLET ALTIINNA NÄKYVÄÄ JA NÄKYMÄTÖN LASERSATEILYLLÄ. ÄLÄ KATSO SÄTEESEEN.
WARNING	• SYNLIG OG OSYNLIG LASERSTRÅLING NÄR DENNA DEL ÄR ÖPPNAD. BETRakta EJ STRÅLEN.
ADVARSEL	• SYNLIG OG USYNLIG LASERSTRÅLING NÄR DEKSEL ÅPNES. UNNGÅ EKSPONERING FOR STRÅLEN.
VORSICHT	• SICHTBARE UND UNSICHTBARE LASERSTRAHLUNG. WENN ABDECKUNG GEÖFFNET, NICHT DEM STRAHL AUSSETZEN.
注意	• 打开时有可见及不可见激光辐射。避免激光束照射。
注意	• ここを開くと可視及び不可視のレーザー光が出ます。ビームを直接見たり、触れたりしないでください。 RQLS0233

(Inside of product)

Getting started

IMPORTANT SAFETY INSTRUCTIONS

Read these operating instructions carefully before using the unit. Follow the safety instructions on the unit and the applicable safety instructions listed below. Keep these operating instructions handy for future reference.

- (1) Read these instructions.
- (2) Keep these instructions.
- (3) Heed all warnings.
- (4) Follow all instructions.
- (5) Do not use this apparatus near water.
- (6) Clean only with dry cloth.
- (7) Do not block any ventilation openings. Install in accordance with the manufacturer's instructions.
- (8) Do not install near any heat sources such as radiators, heat registers, stoves, or other apparatus (including amplifiers) that produce heat.
- (9) Do not defeat the safety purpose of the polarized or grounding-type plug. A polarized plug has two blades with one wider than the other. A grounding-type plug has two blades and a third grounding prong. The wide blade or the third prong are provided for your safety. If the provided plug does not fit into your outlet, consult an electrician for replacement of the obsolete outlet.
- (10) Protect the power cord from being walked on or pinched particularly at plugs, convenience receptacles, and the point where they exit from the apparatus.
- (11) Only use attachments/accessories specified by the manufacturer.
- (12) Use only with the cart, stand, tripod, bracket, or table specified by the manufacturer, or sold with the apparatus. When a cart is used, use caution when moving the cart/apparatus combination to avoid injury from tip-over.
- (13) Unplug this apparatus during lightning storms or when unused for long periods of time.
- (14) Refer all servicing to qualified service personnel. Servicing is required when the apparatus has been damaged in any way, such as power-supply cord or plug is damaged, liquid has been spilled or objects have fallen into the apparatus, the apparatus has been exposed to rain or moisture, does not operate normally, or has been dropped.



Precautions for installation

Do not place the unit on amplifiers or equipment that may become hot.
The heat can damage the unit.



Before moving the unit, ensure the disc tray is empty.
Failure to do so will risk severely damaging the disc and the unit.

■ Cautions as to condensation

Condensation can cause unreliable playback of VHS recordings. Condensation may form in the following cases,

- The unit is brought from cold surroundings into a well-heated room.
- The unit is suddenly brought from cool surroundings, such as an air-conditioned room or car, to a place which is hot and humid.
- During the rainy season.

In any of the above-mentioned conditions, do not operate the unit for at least 2 hours. The unit is not equipped with a dew sensor.

■ Other precautions for installation

- The unit should not be installed or operated near large magnets or electromagnetic devices. Such devices can damage pre-recorded VHS recordings.
- Do not place any heavy objects atop the unit, and do not install it in a confined space. Please allow for adequate air circulation.
- The unit should not be mounted in a vertical position. It's designed to operate in the horizontal position.

About descriptions in these operating instructions

- Pages to be referred to are indicated as (→ ○○).
- The explanations concerning discs are indicated by [DVD], and those concerning video are indicated by [VHS].
- These operating instructions describe operations mainly using the remote control.
- The contents of the screens used in these instructions may not necessarily match what you will see on your screen.
- The displays shown in these instructions are examples. Actual display depends on discs.

Useful features

You can enjoy both DVD and VHS with the unit. This DVD Recorder can record images and sounds in high quality to rapid random access capable DVD media. This has resulted in many new features that outperform older tape formats. The following information summarizes a few of these features.

■ DVD

Progressive output (→ 14, 19)

If you connect the unit with a progressive output compatible TV, you can enjoy higher-quality and less flickering images than conventional TVs (of the interlace output type) can present.

Finalize (→ 31)

This function enables you to play recorded DVD-R, DVD-RW (DVD-Video format) and +R on other players.

Instant play (→ 33)

This function can quickly find and play a video program you wish to watch. Direct Navigator guides you to the beginning of a previously recorded video program immediately.

Quick view (→ 20)

This function allows you to watch news, information and other programs in a short time.

Chasing play (→ 26)

There is no need to wait until recording is complete. Without stopping recording, you can play the video program currently being recorded from its beginning.

Instant recording (→ 24)

You no longer need to search for empty disc space. By pressing the recording button, the unit finds available recording space and begins recording right away.

Simultaneous recording and play (→ 26)

With this function, you can play a previously recorded video program while recording another program.

Time slip (→ 21, 26)

This function enables you to jump to the scene you specify during play and also while recording.

One touch transfer (dub) (→ 55, 56)

This function can copy video from VHS to DVD and vice versa.

■ VHS

Long recording (→ 49)

With this function, you can record approx. 10 hours of video onto a T-120 cassette, for example.

Getting started

Contents

Getting started	
Warning and Important Information	2
IMPORTANT SAFETY INSTRUCTIONS.....	3
Precautions for installation.....	3
About descriptions in these operating instructions	3
Useful features.....	3
Contents	4
Concerning discs	6
• Discs you can use for recording and play [12 cm (5")/8 cm (3")].....	6
• Play-only discs [12 cm (5")/8 cm (3")].....	7
• Discs that cannot be played	7
• Concerning logo marks	7
• Disc handling.....	8
• Inserting discs	8
Maintenance	8
Using DVD-R, DVD-RW and +R on this unit	9
Accessories	9
Remote control	10
• Batteries and remote control	10
Main unit	11
• The unit's display.....	11
STEP 1 Connection	12
• Connecting a TV and VCR.....	12
• Connecting a cable TV box/satellite receiver	13
• If the antenna connector does not match	13
- Other antenna connections to the unit	13
- Other antenna connections from the unit to the TV	13
• DVD output and DVD/VHS output.....	14
• Connecting an amplifier or system component	14
- To enjoy multi-channel surround sound on DVD-Video (digital connection).....	14
- Connection to a stereo amplifier (analog connection).....	14
• To enjoy even higher fidelity.....	14
- Connection to the S-VIDEO IN terminal.....	14
- Connection to the COMPONENT VIDEO IN terminals	14
STEP 2 Plug-in Auto Tuning	15
• If Plug-in Auto Tuning fails	16
• Adding and deleting channels	16
STEP 3 Channel settings.....	16
• Guide channel settings for VCR Plus+ system.....	16
• Channel captions.....	17
- Preset Channel Captions.....	17
- Manual Channel Captions.....	17
STEP 4 Set up to match your TV and remote control.....	18
• When other Panasonic products respond to this remote control.....	18
• TV operation.....	18
• Selecting TV type	19
• Removing Interference	19

DVD

Playback	
Playing discs	20
• To stop play	20
• To pause play.....	20
• When a menu screen appears on the TV	20
Quick View (Play X1.3)	20
Fast forward and rewind — SEARCH.....	20
Skipping	20
Slow-motion play	20
Frame-by-frame viewing	21
Direct play.....	21
Erasing a title that is being played	21
CM Skip	21
Create chapters	21
Displaying the TV image as a picture-in-picture/ Selecting an amount of time to skip — Time Slip.....	21
Changing audio during play	21
Playing discs which contain both MP3 and still pictures.....	22
Using menus to play MP3 discs.....	22
• Using the tree screen to find a group	23
To show the JPEG Menu.....	23
- Playing a still picture	23
- Start Slide Show/Slide Interval.....	23
- To select the still pictures in another folder.....	23

Recording

Recording TV programs	24
• Recording procedures.....	24
• Recording modes and approximate recording times	24
Selecting audio to record	25
Specifying the time when recording will stop.....	25
Watching the TV while recording.....	25
Flexible Recording mode (FR)	25
Playing while you are recording	26
• Chasing play	26
• Simultaneous recording and play.....	26
• TIME SLIP.....	26
• Playing VHS while recording.....	26
• DV automatic recording (DV AUTO RECORDING)	27
Cautions for using scheduled recording on DVD	28
Scheduled Recording	28
• Using VCR Plus+ system.....	28
• Manual programming.....	29
Check, change or delete programs	29

Editing

DISC MANAGEMENT	30
- Disc Name	30
- Disc Protection	30
- Erase All Titles	30
- Format Disc	31
- Playback will start with:.....	31
- Finalize	31
Entering text	32
Using the Direct Navigator	33
• Selecting recorded titles to play	33
• Editing titles with SUB MENU button	33
- Erase Title	33
- Properties	33
- Edit Title	34
- View Chapters	35
Playing playlists.....	36
• Other functions for playlists.....	37
- Properties	37
- View Chapters	37

Convenient functions

Using DISPLAY menus	38
• Common procedures	38
- Disc menu	38
- Play menu	39
- Video menu	39
- Audio menu	39
- Other menu	39
Changing the unit's settings	40
Entering a password (Ratings)	40
Summary of settings.....	41
Clock Settings	44
- Set Clock Automatically.....	44
- Adjust Time Zone	44
- Set Clock Manually.....	44
FUNCTIONS window	45
Status displays	45

Getting started

VHS

Playback

Inserting a video cassette	46
Video cassette information	46
• Video cassettes	46
• Video cassette care	46
• Maintenance	46
Playing a video cassette	47
Fast-forward/Rewind	47
Cue/Review	47
Jet Search	47
Slow	47
Jet Rewind	47
S-VHS Quasi Playback (SQPB)	48
Repeat Playback	48
Adjusting the playback picture	48
• Manual tracking	48
• Vertical locking adjustment	48

Recording

Recording TV programs	49
• Recording procedures	49
• Specifying the time when recording will stop	49
• Watching the TV while recording	49
• Playing DVD while VHS recording	49
Cautions for using scheduled recording on VHS	50
Scheduled Recording	50
• Using VCR Plus+ system	50
• Manual programming	51
Auto SP/EP mode	51
Check, change or delete programs	51

Convenient functions

VHS Index Search System (VISS)	52
Changing the unit's settings	52
- Summary of settings	52
When the DVD side is not recording	53
When the DVD side is recording	53
Changing audio	53
Auto Bilingual Choice Function	53

DVD/VHS

Transferring (Dubbing)

Before transferring (dubbing)	54
Transfer (Dubbing) from VHS	55
• One Touch Transfer (Dubbing) (VHS → DVD)	55
Transfer (Dubbing) from DVD	56
• One Touch Transfer (dubbing) (DVD → VHS)	56
Recording from an external device	57
• Manual recording	57
- DVD	57
- VHS	57

Reference

Glossary	58
Frequently asked questions	59
Error messages	60
• Common	60
• DVD	60
• VHS	60
Troubleshooting guide	61
• Common	61
• DVD	63
• VHS	65
Product Service	65
• Product information	65
Limited Warranty (ONLY FOR U.S.A.)	66
Limited Warranty (ONLY FOR CANADA)	67
Specifications	68
Index	69

Español

Cómo empezar

Conexión con un televisor y un VCR	70
• Conexión al terminal S-VIDEO IN	70
• Conexión a los terminales COMPONENT VIDEO IN	70
Sintonización automática por enchufe	71
Ajustes del canal de guía para el sistema VCR Plus+	71
Selección del tipo de televisor	71

DVD

Reproducción

Reproducción de los discos	72
----------------------------------	----

Grabación

Grabación de programas televisivos	74
• Reproducción durante la grabación	75
Grabación temporizada	76
• Uso del sistema VCR Plus+	76
• Programación manual	76
• Controle, cambie o borre el programa	76

VHS

Reproducción

Reproducción de un cassette de vídeo	77
--	----



Grabación

Grabación de programas televisivos	78
Grabación temporizada	78
• Uso del sistema VCR Plus+	78
• Programación manual	79
• Controle, cambie o borre el programa	79

Getting started

Concerning discs

■ Discs you can use for recording and play [12 cm (5")/8 cm (3")]

Disc type	DVD-RAM ● 4.7 GB/9.4 GB, 12 cm (5") ● 2.8 GB, 8 cm (3")	DVD-R (DVD-Video format) ● 4.7 GB, 12 cm (5") ● 1.4 GB, 8 cm (3")	DVD-RW (DVD-Video format) ● 4.7 GB, 12 cm (5") ● 1.4 GB, 8 cm (3")	+R ● 4.7 GB, 12 cm (5")
Logo				—
Indicated in these instructions with	RAM	-R before finalization DVD-V after finalization	-RW(V) before finalization DVD-V after finalization	+R before finalization DVD-V after finalization
Main use	Re-writable discs	One time recording discs (recordable until the disc is full)	Re-writable discs	One time recording discs (recordable until the disc is full)
Maximum recording time	Approx. 8 hours (Approx. 16 hours on a double-sided disc*)	Approx. 8 hours	Approx. 8 hours	Approx. 8 hours
Play on other player	Only on DVD-RAM compatible players. It is not necessary to finalize the disc. (→ 58)	Only after finalizing the disc. (→ 31, 58)	Only after finalizing the disc. (→ 31, 58)	Only after finalizing the disc. (→ 31, 58)
What you can do on this unit (✓: Possible, ✗: Impossible)				
Chasing playback	✓	✗	✗	✗
Recording broadcasts that allow one copy	✓ (CPRM (→ 58) compatible discs only)	✗	✗	✗
Recording both Main and SAP of MTS broadcast	✓	✗ Only one is recorded. (→ 42, Select MTS)	✗ Only one is recorded. (→ 42, Select MTS)	✗ Only one is recorded. (→ 42, Select MTS)
Recording 16:9 aspect picture	✓	✗ (The picture is recorded in 4:3 aspect.)	✗ (The picture is recorded in 4:3 aspect.)	✗ (The picture is recorded in 4:3 aspect.)
Entering text	✓	✓	✓	✓
Erasing titles	✓	✓ (Available space does not increase after erasing.)	✓ (Disc space increases only when the last recorded title is erased.)	✓ (Available space does not increase after erasing.)

* You cannot consecutively record or play both sides.

- We recommend using Panasonic discs. We recommend using DVD-RAM discs with cartridges to protect them from scratches and dirt.
- Discs from other manufactures may not be recorded or played due to the condition of the recording.
- You may not be able to record to DVD-R, DVD-RW and +R discs on this unit or play them due to the condition of the recording.
- You cannot record programs that allow "One time only recording" to CPRM compatible DVD-R and DVD-RW on this unit. You can record other programs as DVD-Video format.
- You can use high speed recording compatible discs on this unit.

■ DVD Video Recording format

This is a recording method which allows you to record and edit TV broadcasts and so on.

- Digital broadcasts that allow "One time only recording" can be recorded to a CPRM compatible disc. You can record to CPRM compatible DVD-RAM on this unit.
- Play is only possible on a compatible DVD player.

Use a DVD-RAM to record in DVD Video Recording format.

■ DVD-Video format





This recording method is the same as commercially available DVD-Video.

- Digital broadcasts that allow "One time only recording" cannot be recorded.
- These can be played on a DVD player. However programs recorded on this unit must be finalized to be played on other DVD players.

Use a DVD-R or DVD-RW to record in DVD-Video format.

Getting started

■ Play-only discs [12 cm (5")/8 cm (3")]

Disc type	DVD-Video	DVD-RW (DVD Video Recording format)	+RW	Audio CD		Video CD
Logo			—		—	
Indicated in these instructions with	DVD-V	-RW(VR)	DVD-V	CD		VCD
Instructions	High quality movie and music discs	DVD-RW* recorded on another DVD recorder <ul style="list-style-type: none"> You can play programs that allow "One time only recording" if they have been recorded to a CPRM compatible disc. By formatting (→ 31) the disc, you can record to it in DVD-Video format and play it on the unit. It may be necessary to finalize the disc on the equipment used for recording.	+RW* recorded on another DVD recorder	Recorded audio and music (including CD-R/RW*)	CD-R* and CD-RW* with music recorded in MP3 (→ 22) Still pictures (JPEG) recorded on CD-R/RW*	Recorded music and video (including CD-R/RW*)

* Play may be impossible on some DVD-RW (DVD Video Recording format), +RW, CD-R or CD-RW discs due to the condition of the recording.

- You can play still pictures (JPEG), CD-DA, Video CD and MP3 format data recorded on CD-R/RW. Close the session or finalize the disc after recording.
- The producer of the disc can control how discs are played. So you may not always be able to control play as described in these operating instructions. Read the disc's instructions carefully.

Note about using a DualDisc

The digital audio content side of a DualDisc does not meet the technical specifications of the Compact Disc Digital Audio (CD-DA) format so play may not be possible.

Region number supported by this unit

Region numbers are allocated to DVD players and DVD-Video according to where they are sold.

- The region number of this unit is "1".
- The unit will play DVDs marked with labels containing "1" or "ALL".



Example:



■ Discs that cannot be played

- 2.6/5.2 GB DVD-RAM, 12 cm (5")
- 3.95/4.7 GB DVD-R for Authoring
- DVD-R recorded in DVD Video Recording format
- DVD-R (DVD-Video format), DVD-RW (DVD-Video format), +R recorded on another unit and not finalized (→ 58, Finalize)
- PAL discs (you can still play the audio on DVD-Audio)
- DVD-Video with a region number other than "1" or "ALL"
- DVD-Audio
- Blu-ray
- DVD-ROM, DVD-R DL, +R DL, +R 8cm (3"), CD-ROM, CDV, CD-G, Photo CD, CVD, SVCD, SACD, MV-Disc, PD, DivX Video Disc, etc.

■ Concerning logo marks

	Dolby Digital (→ 42) This is a method of coding digital signals developed by Dolby Laboratories. Apart from stereo (2 channel) audio, these signals can also be multi-channel audio. A large amount of audio information can be recorded on one disc using this method.
	DTS Digital Surround (→ 42) This surround system is used in many movie theaters around the world. The separation between channels is good and the compression ratio is low, so realistic sound effects are possible.

The manufacturer accepts no responsibility and offers no compensation for loss of recorded or edited material due to a problem with the unit or recordable media, and accepts no responsibility and offers no compensation for any subsequent damage caused by such loss.

Examples of causes of such losses are

- A disc recorded and edited with this unit is played in a DVD Recorder or computer disc drive manufactured by another company.
- A disc used as described above and then played again in this unit.
- A disc recorded and edited with a DVD Recorder or computer disc drive manufactured by another company is played in this unit.

Getting started

■ Disc handling

■ How to hold a disc

Do not touch the recorded surface.

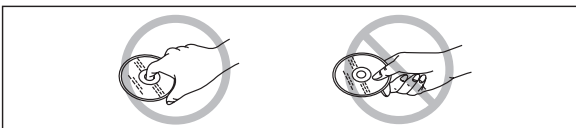

■ Concerning non-cartridge discs

Be careful about scratches and dirt.

■ If there is dirt or condensation on the disc

Wipe with a damp cloth and then wipe dry.

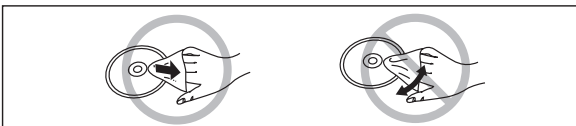

■ Handling precautions

- Do not attach labels or stickers to discs. (This may cause disc warping and unbalanced rotation, rendering it unusable.)
- Write on the label side of the disc only with a soft, oil-based felt pen. Do not use ballpoint pens or other hard writing implements.
- Do not use record cleaning sprays, benzine, thinner, static electricity prevention liquids or any other solvent.
- Do not use scratch-proof protectors or covers.
- Do not drop, stack, or cause impact to discs. Do not place objects on them.
- Do not use the following discs:
 - Discs with exposed adhesive from removed stickers or labels (rental discs etc.).
 - Discs that are badly warped or cracked.
 - Irregularly shaped discs, such as heart shapes.

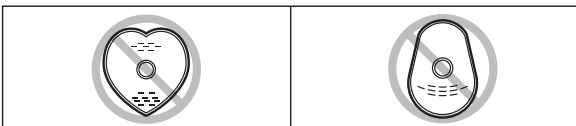

- Do not place in the following areas:
 - In direct sunlight.
 - In very dusty or humid areas.
 - Near a heater.
 - Locations susceptible to significant differences in temperature changes (condensation can occur).
 - Where static electricity or electromagnetic waves occur.
- To protect discs from scratches and dirt, return them to their cases or cartridges when you are not using them.

■ Inserting discs

- 1 Press [**▲**, OPEN/CLOSE] on the main unit to open the tray.
 - You can insert a cartridge or non-cartridge disc.
- 2 Press [**▲**, OPEN/CLOSE] on the main unit to close the tray.

Note

- A double-sided disc should be loaded with the side you want to record/play facing down.
- It is not possible to record continuously from one side of a double-sided disc to the other. You will need to eject the disc and turn it over.
- When using 8 cm (3") DVD-RAM or 8 cm (3") DVD-R, remove the disc from the cartridge.

Non-cartridge disc

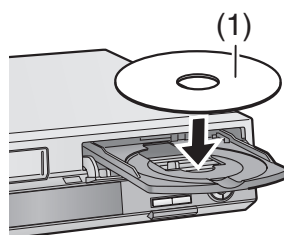

Cartridge disc

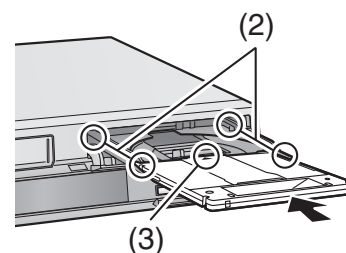

- (1) Insert label-up.
- (2) Insert fully so it clicks into place.
- (3) Insert label-up with the arrow facing in.

Maintenance

The precision parts in the unit are readily affected by the environment, especially temperature, humidity, and dust. Cigarette smoke also can cause malfunction or breakdown.

To clean the unit, wipe with a soft, dry cloth.

- Never use alcohol, thinner or benzine to clean the unit.
- Before using chemically treated cloth, carefully read the instructions that came with the cloth.

Observe the following points to ensure continued listening and viewing pleasure.

Dust and dirt may adhere to the unit's lens over time, possibly making it impossible to record or play discs. Use the **DVD lens cleaner** about once every year, depending on frequency of use and the operating environment. Carefully read the lens cleaner's instructions before use.

DVD lens cleaner: RP-CL720PP

■ When the unit is not to be used for a long time

To save power, unplug it from the household AC outlet. The unit consumes a small amount of power even when it is turned off.

Standby power consumption

		Front Display (→ 43)	
		Automatic	Bright
Quick Start (→ 41)	On	Approx. 9 W	Approx. 11 W
	Off	Approx. 2.1 W	Approx. 2.1 W

■ Quick Start (→ 41)

1 Sec. Quick Start for Recording on DVD-RAM*

* When the unit is turned off, press [**⏻**, DVD/VHS POWER] and then [**●**, REC] (Quick Start Mode). Recording on DVD-RAM starts about 1 second after pressing these buttons.

Getting started

Using DVD-R, DVD-RW and +R on this unit

Restrictions with DVD-R, etc.*

- 16:9 aspect programs are recorded in 4:3 aspect.
- Both Main and SAP cannot be recorded for MTS broadcasts.
- Playing the disc on other DVD players is not possible before finalizing.

* DVD-R, DVD-RW and +R are collectively referred to as "DVD-R, etc." on this page.

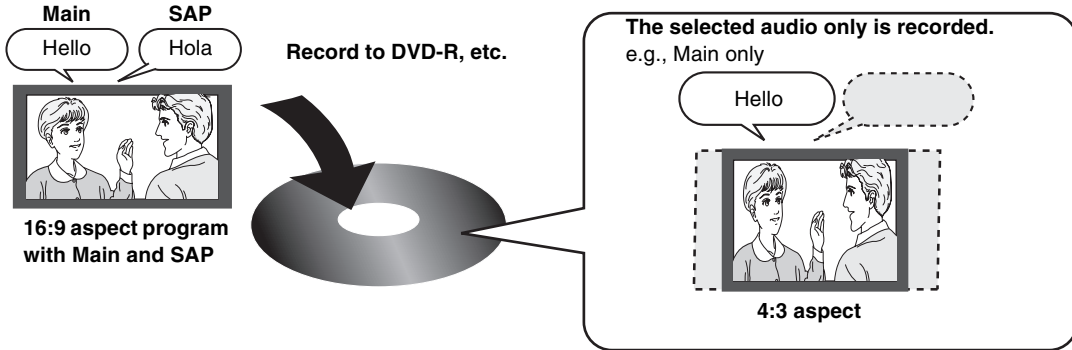

Therefore, follow the steps below when you use DVD-R, etc.

■ When recording an SAP program to DVD-R, etc.

Select the audio to record before recording or transferring (dubbing).

Some television programs are broadcast in SAP (Secondary Audio Program). You have to select the audio recording type before recording or transferring (dubbing) them to DVD-R, etc.

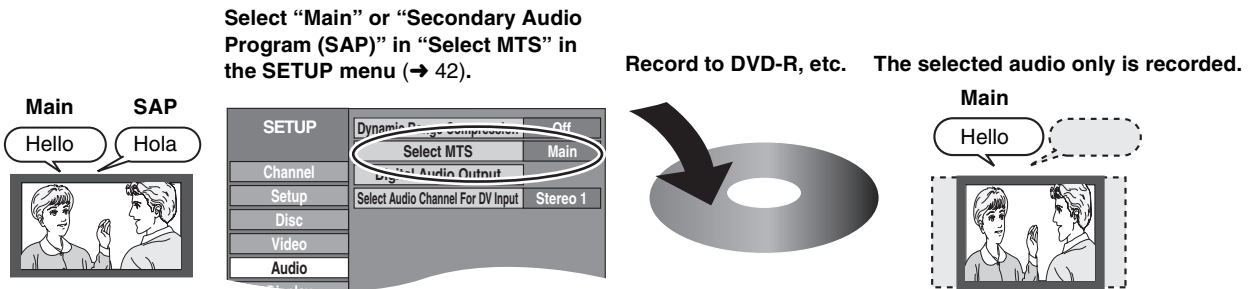

■ Playing the disc on other DVD players

The disc must be finalized after recording or transferring (dubbing) (→ 31).

It is necessary to finalize DVD-R, etc. on this unit after recording or transferring (dubbing) titles to them. You can then play them as a commercially sold DVD-Video. However the discs become play-only and you can no longer record or transfer (dub).*

* You can record and transfer (dub) again if you format DVD-RW.

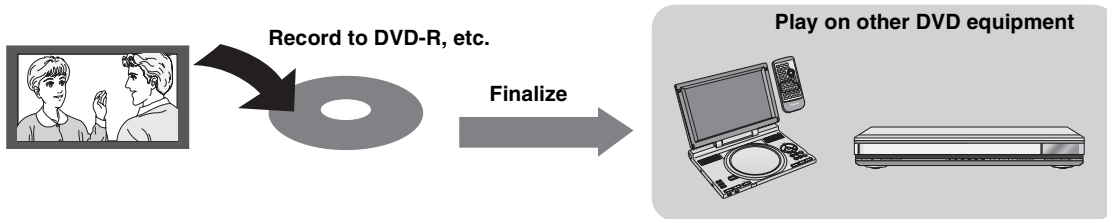

Accessories

Please check and identify the supplied accessories. Use product numbers indicated in parentheses when asking for replacement parts. (Product numbers correct as of January 2005. These may be subject to change.)

Only for U.S.A.: To order accessories, refer to "Accessory Purchases" on page 66.

Only for Canada: To order accessories, call the dealer from whom you have made your purchase.

- 1 AC power supply cord (K2CB2CB00006)
- 1 75 Ω coaxial cable (K2KZ2BA00001)
- 1 Remote control (EUR7720LB0)
- 2 Batteries for the remote control

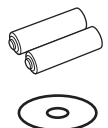
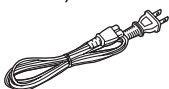

• For use with the unit only. Do not use it with other equipment. Also, do not use cords belonging to other equipment with the unit.

- 1 Audio/Video cable (K2KA6BA00003)



(U.S.A. only)
Product Registration Card

Please complete and return the included product registration card, or register via the Internet at:
<http://www.prodreg.com/panasonic/>

Getting started

Remote control

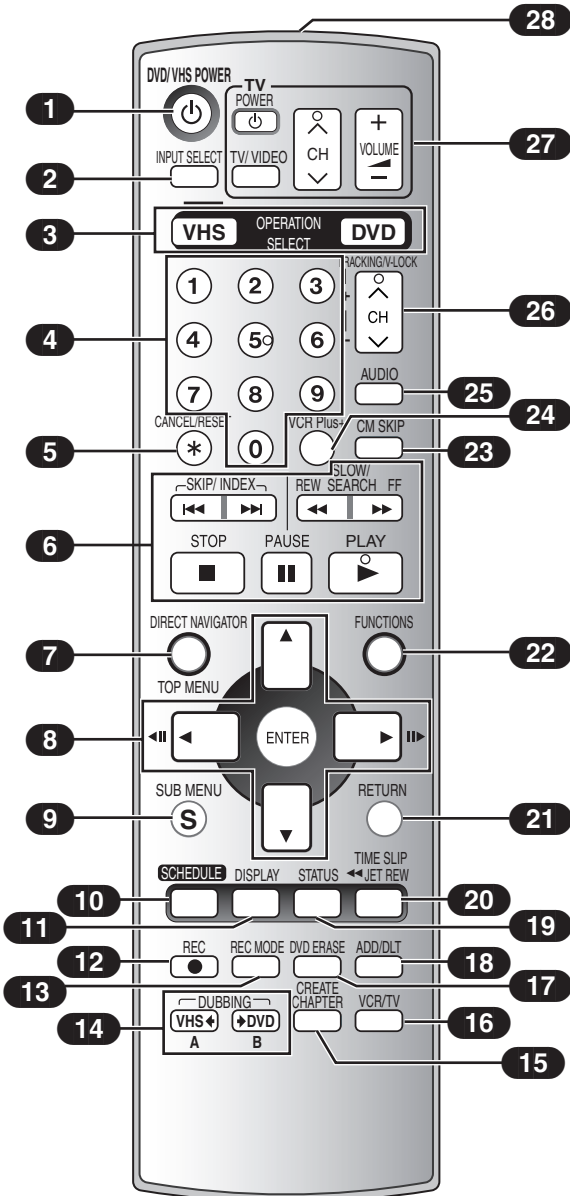

■ [VHS] and [DVD] button

[DVD]

- Before performing DVD operations, be sure to press the [DVD] button. Also, make sure the DVD indicator lights up on the unit.



[VHS]

- Before performing VHS operations, be sure to press the [VHS] button. Also, make sure the VHS indicator lights up on the unit.



- 1 Turn the unit on → 15
- 2 Input select (IN1, IN2 or DV) → 57
- 3 Select drive (DVD or VHS) → above
- 4 Select channels and title numbers etc./Enter numbers
- 5 Cancel/Reset the tape counter
- 6 Basic operations for recording and play
- 7 Show Top menu/Direct Navigator → 22, 33
- 8 Selection/Enter, Frame-by-frame → 15, 21
- 9 Show sub menu → 23, 33, 37
- 10 Show scheduled recording list → 29, 51
- 11 Show on-screen menu → 38
- 12 Start recording → 24, 49, 57
- 13 Change recording mode → 24, 49
- 14 One touch transfer (dub) (DVD, VHS) → 55, 56
- 15 Create chapters → 21
- 16 Select VCR/TV → 19
- 17 Erase items → 21
- 18 Add/delete channel → 16
- 19 Show status messages → 45, 53
- 20 Skip the specified time/
Display the TV image as a picture-in-picture
Jet rewind button (JET REW) → 21, 26, 47
- 21 Return to previous screen
- 22 Show FUNCTIONS window → 45, 52
- 23 Skip a minute forward → 21
- 24 Show VCR Plus+ screen → 28, 50
- 25 Select audio → 21, 25, 53
- 26 Channel select/
TRACKING/V-LOCK → 48
- 27 TV operations → 18, 25, 49
- 28 Transmission window

Note

- Buttons such as the [●, REC] button do not protrude as much as other buttons to stop them from being pressed accidentally.
- The word “button” is not used in these operating instructions so “Press the [ENTER] button.” is shown as “Press [ENTER].”
- You can use this remote control to operate your TV if you set the TV manufacturer code (→ 18).

■ Batteries and remote control

■ About batteries

- Insert so the poles (+ and -) match those in the remote control.
- Do not use rechargeable type batteries.

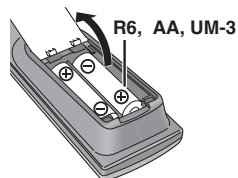

Do not:

- mix old and new batteries.
- use different types at the same time.
- heat or expose to flame.
- take apart or short circuit.
- attempt to recharge alkaline or manganese batteries.
- use batteries if the covering has been peeled off.

Mishandling of batteries can cause electrolyte leakage which can damage items the fluid contacts and may cause a fire.

Remove if the remote control is not going to be used for a long period of time. Store in a cool, dark place.

Note

- If you cannot operate the unit or TV using the remote control after changing the batteries, please re-enter the codes (→ 18).

■ How to use the remote control

Aim at the sensor, avoiding obstacles, at a maximum range of 7 m (23 feet) directly in front of the unit.

Remote control signal sensor

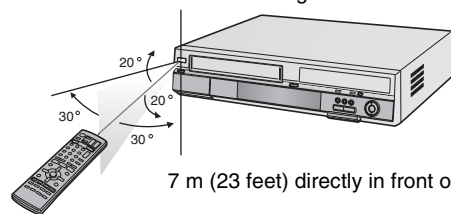

Note

- Keep the transmission window and the unit's sensor free from dust.
- Operation can be affected by strong light sources, such as direct sunlight, inverter fluorescent lamps, and the glass doors on cabinets.

Getting started

Main unit

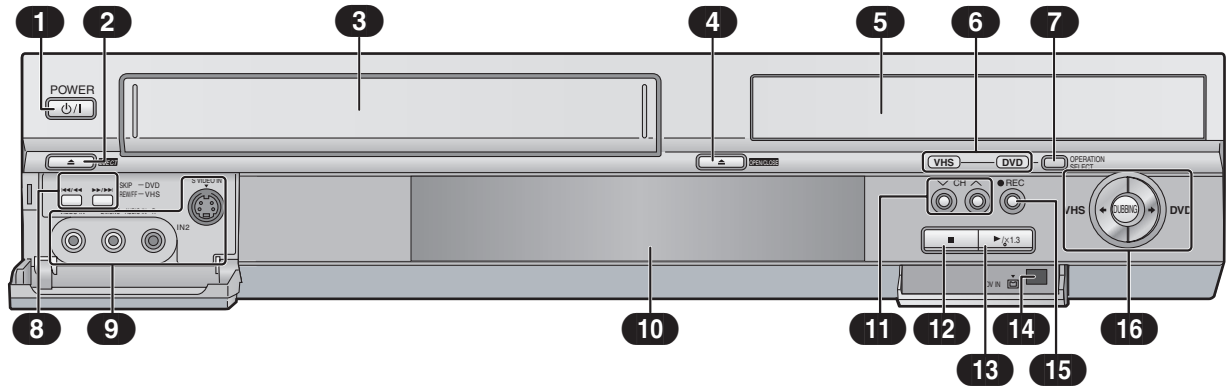

- 1 Remote control signal sensor/ DVD/VHS POWER on/off button (⏻/I, POWER) → 15**
 - To switch the unit from on to standby mode or vice versa. In the standby mode, the unit is still consuming a small amount of power.
- 2 Cassette eject button (⏏, EJECT) → 46**
- 3 Cassette compartment**
- 4 Disc tray open/close button (⏏, OPEN/CLOSE) → 8**
- 5 Disc tray**
- 6 DVD/VHS drive indicator**
 - Lights when the DVD or VHS drive is selected.
- 7 Operation select button**
- 8 DVD-SKIP, VHS-REW/FF buttons (⏮/⏪, ⏩/⏭) → 20, 47**
- 9 IN2 input terminals (IN2) → 57**
- 10 The unit's display**
- 11 Channel up/down buttons (CH, ^, v) → 48**
- 12 Stop button (■) → 20, 47**
- 13 Play/X1.3 button (▶/x1.3) → 20, 47**
- 14 DV IN → 27**
- 15 Recording button (●, REC) → 24, 49**
- 16 One Touch Transfer (Dubbing) operation button**
 - From VHS to DVD → 55
 - From DVD to VHS → 56

■ Off Timer
 The unit automatically switches to standby when it has not been used for about 6 hours.
 You can turn this feature off or change the time to 2 hours.
 (→ 41, "Off Timer")

■ The unit's display

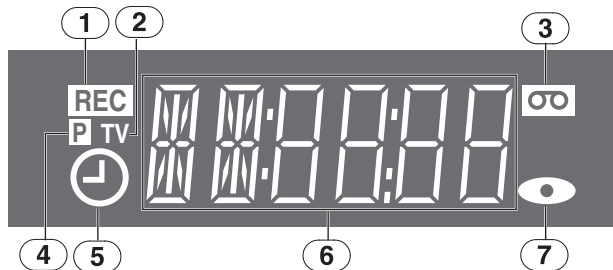

- 1 Recording indicator**
 - The recording indicator for the drive selected. When the power is off, it doesn't matter which drive is selected.
 - On: During recording
 - Flashes: During pause recording
- 2 TV indicator**
 - The indicator lights during the TV mode and it goes out during the VCR mode. You can switch the mode by using [VCR/TV]. (→ 19)
- 3 Tape indicator**
- 4 Progressive indicator**
 - The indicator lights during outputting in progressive.
- 5 Scheduled recording indicator (⊖) (→ 28, 50)**
 - The scheduled recording indicator lights only when the unit's power is off.
 - On: When a scheduled recording program is registered and recordable disc or tape is inserted.
 - Flashes: The scheduled recording indicator flashes when the unit cannot start (e.g. there is no disc, tape, etc.) the scheduled recording.
- 6 Main display**
 - Digital Clock, Counter, etc.
- 7 Disc indicator**

Getting started

STEP 1 Connection

- Please read "Precautions for installation". (→ 3)
- Before connection, turn off all equipment and read the appropriate operating instructions.

■ Connecting a TV and VCR

— indicates included accessories.
 - - - indicates accessories not included.

- Red
- White
- Yellow

■ Connection (without Audio/Video cable)

Connect in numerical order ① to ③.

The unit supplies a signal to the TV via the 75 Ω coaxial cable on channel 3 or 4. It is possible to view the video picture on your TV in the same way that you watch TV broadcasts.

- After this connection, set the RF output channel to "CH3" or "CH4" (→ 15).

■ Connection (with Audio/Video cable)

Connect in numerical order ① to ④.

- After this connection, set the RF output channel to "OFF" (→ 15).

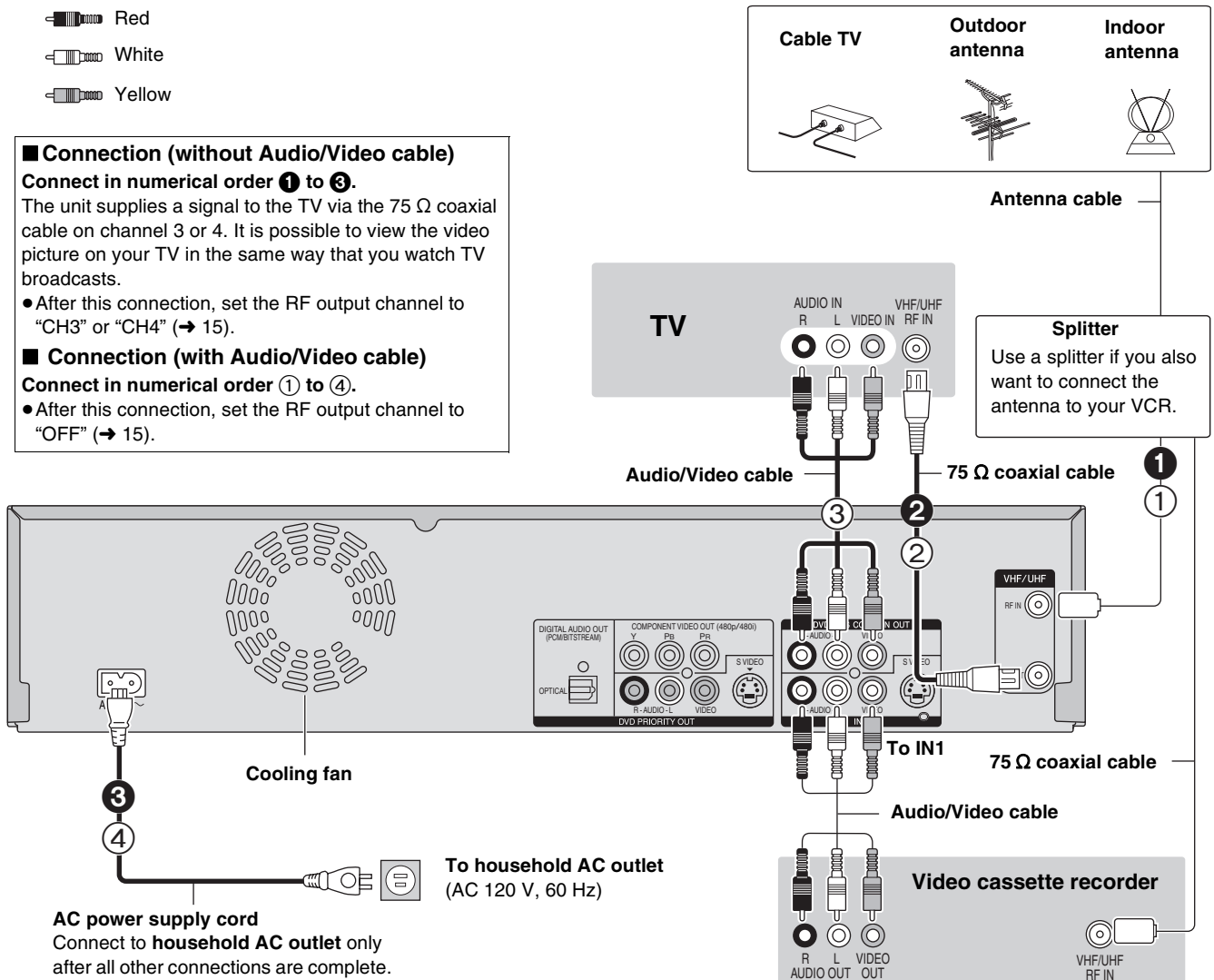

AC power supply cord
 Connect to household AC outlet only after all other connections are complete.

- If the antenna connector doesn't match (→ 13)

■ Do not connect the unit through a video cassette recorder

Video signals sent through video cassette recorders will be affected by copyright protection systems and the picture will not be shown correctly on the TV.

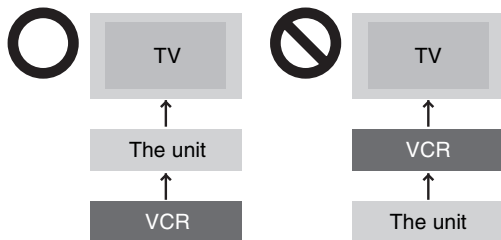

- When connecting the unit to a TV with a built-in VCR, connect to the input terminals on the TV, not the VCR.

■ Connection examples with other equipment

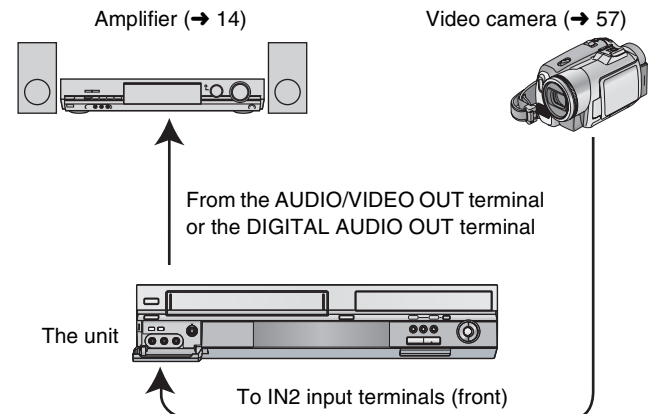

For your reference

- The equipment connections described are examples.
- Peripheral equipment and optional cables are sold separately unless otherwise indicated.

Getting started

■ Connecting a cable TV box/satellite receiver

- You need to subscribe to a cable TV or satellite TV service to enjoy viewing their programming.
- Consult your service provider regarding an appropriate cable TV box or satellite receiver.
- You can enjoy viewing cable TV or satellite TV programming.
- You can record and view scrambled and unscrambled channels simultaneously if connections are made as shown in the diagram below.

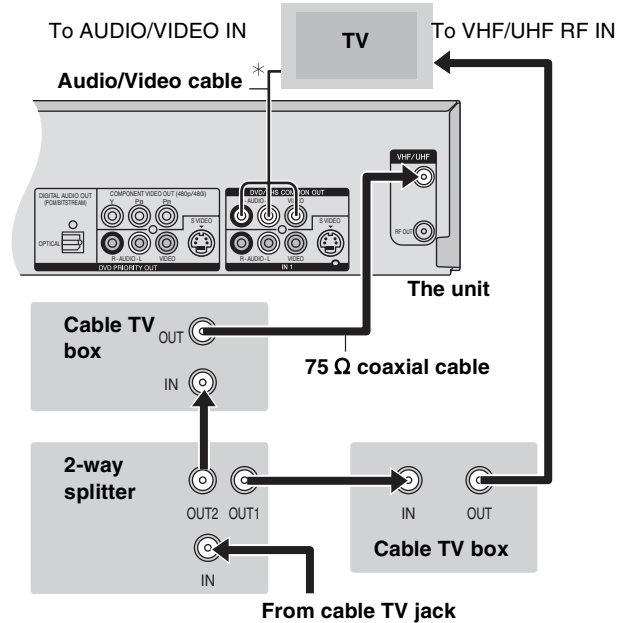
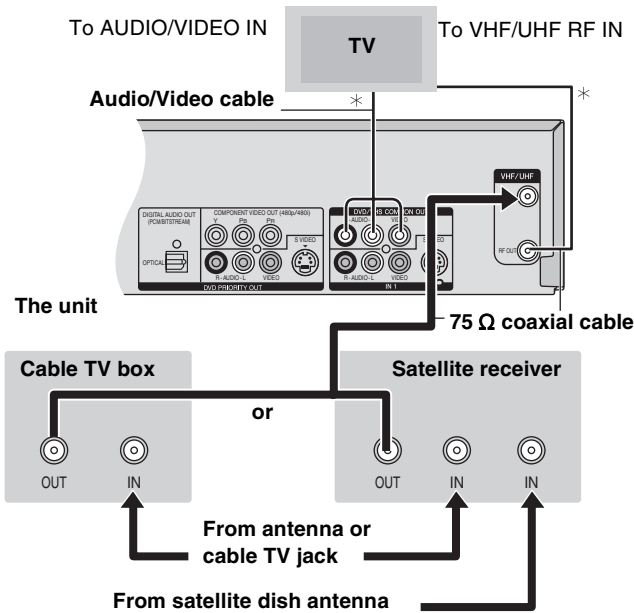

* For more information on connections (→ 12)

■ If the antenna connector does not match

▶ Other antenna connections to the unit

Use one of the following connections to suit your antenna lead.

- If your TV has both lead and coaxial VHF terminals, use the lead connection to minimize signal loss.

■ A single twin lead

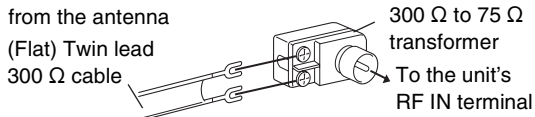

■ A twin lead and a coaxial cable

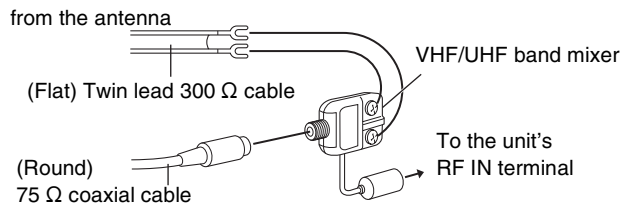

■ 2 twin leads

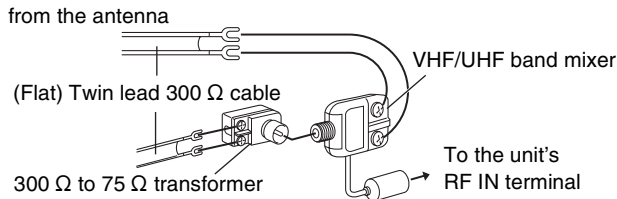

▶ Other antenna connections from the unit to the TV

Use one of the following connections to suit the antenna terminals on your TV. Refer to the TV's operating instructions.

■ A twin lead and coaxial plug terminal

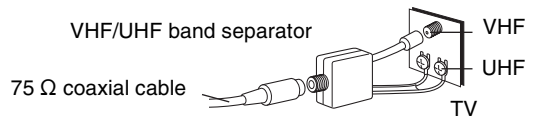

■ A twin lead terminal

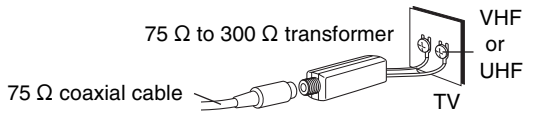

■ 2 twin lead terminals

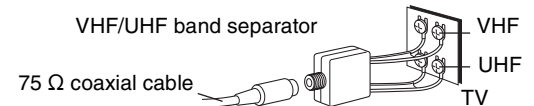

■ Multiple antenna terminals

- Connect to one of the ANT terminals, then change the TV's setting as necessary.

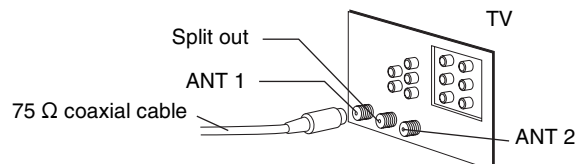

Getting started

DVD output and DVD/VHS output

The unit has DVD/VHS COMMON output terminals and DVD PRIORITY output terminals.

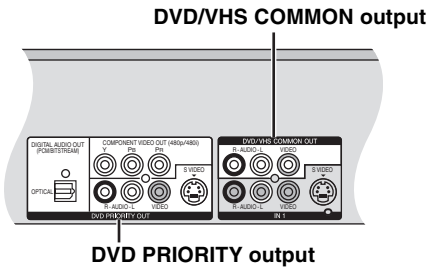

DVD/VHS COMMON OUT

• For DVD/VHS COMMON output terminals, both DVD and VHS signals can be output.

DVD PRIORITY OUT

• You can also playback a tape with the DVD PRIORITY output terminal except while recording, or making a scheduled recording, on the DVD.

Connecting an amplifier or system component

To enjoy multi-channel surround sound on DVD-Video (digital connection)

DVD only

- Connect an amplifier with a built-in Dolby Digital or DTS decoder. (→ 7)
- Change the settings in "Digital Audio Output". (→ 42)
- You cannot use any amplifier with a DTS Digital Surround decoder not suited to DVD.

- (1) Rear panel of the unit
- (2) Optical digital output terminal
- (3) **Optical digital audio cable** (not supplied)
 - Ⓐ Insert fully, with this side facing up. (Do not bend when connecting.)
- (4) Optical digital input terminal
- (5) Amplifier's rear panel

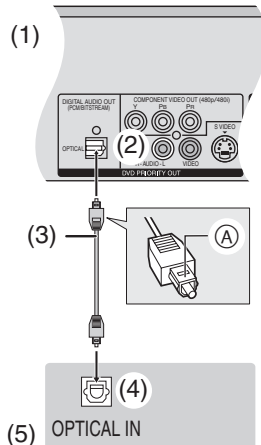

Connection to a stereo amplifier (analog connection)

- (1) Rear panel of the unit
- (2) Audio output terminals (L/R)
- (3) Audio cable (not supplied)
 - Ⓐ Red (R)
 - Ⓑ White (L)
- (4) Audio input terminals (L/R)
- (5) Amplifier's rear panel

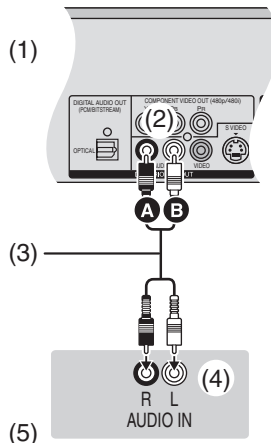

To enjoy even higher fidelity

Connection to the S-VIDEO IN terminal

S-VIDEO OUT terminal

The S-VIDEO OUT terminal achieves a more vivid picture than the VIDEO OUT terminal. (Actual results depend on the TV.)

- (1) Audio input terminals (L/R)
- (2) S-Video input terminal
- (3) Audio cable (not supplied)
 - Ⓐ Red (R)
 - Ⓑ White (L)
- (4) S-Video cable (not supplied)
- (5) Rear panel of the unit
- (6) Audio output terminals (L/R)
- (7) S-Video output terminal

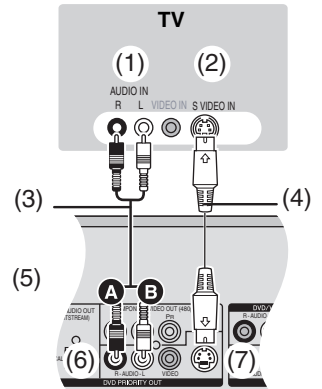

Connection to the COMPONENT VIDEO IN terminals

COMPONENT VIDEO OUT terminals

These terminals can be used for either interlace or progressive output (→ 58) and provide a purer picture than the S-VIDEO OUT terminal.

- Connect to terminals of the same color.

- (1) Component input terminals
- (2) Audio input terminals (L/R)
- (3) Component video cable (not supplied)
- (4) Audio cable (not supplied)
 - Ⓐ Red (R)
 - Ⓑ White (L)
- (5) Rear panel of the unit
- (6) COMPONENT VIDEO OUT terminals
- (7) Audio output terminals (L/R)

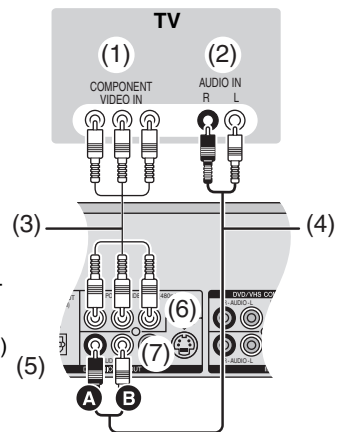

Getting started

STEP 2 Plug-in Auto Tuning

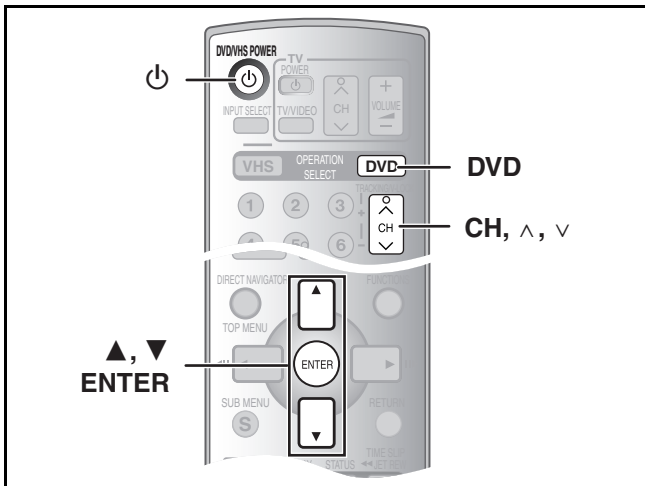

After plugging the unit into your household AC outlet and pressing [⏻, DVD/VHS POWER] to turn the unit on for the first time, the unit assists you in setting the on-screen language, and automatically tunes in all the channels it can receive and sets the clock.

The unit automatically determines the type of transmission (airwaves or cable) and puts them into channels as follows.

	Band	Channel
Antenna Mode (Airwaves)	VHF	2 to 13
	UHF	14 to 69
CableTV Mode (Cable)	VHF	2 to 13
	CATV LOW BAND	95 to 99
	CATV MID/SUPER BAND	14 to 36
	CATV HYPER BAND	37 to 65
	ULTRA BAND	66 to 94 100 to 125
	SPECIAL CATV CHANNEL	1

Preparation

- Press [DVD].
- Turn on the TV and select the appropriate video input to suit the connections to the unit. (Example: AV input, CH3 or CH4)
- If you connect the unit through a cable TV box or satellite receiver (→ 13), tune to your local PBS for Auto Clock Setting to work. If there is no local PBS, set the clock manually (→ 44, "Set Clock Manually").

1 Press [⏻, DVD/VHS POWER].

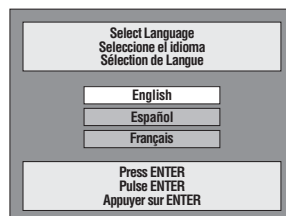

2 Press [CH, ^, v] to select an RF output channel number.

Connection (without Audio/Video cable):

Select "CH3" or "CH4" which displays the screen on the right.

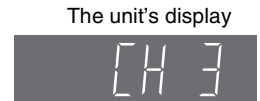

Connection (with Audio/Video cable):

Select "OFF"

The unit's display

Each time you press the button:

CH3 (Default setting) ↔ CH4 ↔ OFF

3 Use [▲, ▼] to select the language and press [ENTER].

4 Press [ENTER] to start Plug-in Auto Tuning.

- The unit then proceeds with Auto Clock Setting. The time is displayed when Auto Clock Setting is finished.

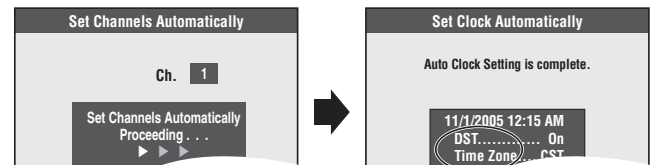

- DST, Daylight Saving Time, shows the summertime setting.
- Time Zone shows the time difference from Greenwich Mean Time (GMT).

EST (Eastern Standard Time) = GMT -5

CST (Central Standard Time) = GMT -6

MST (Mountain Standard Time) = GMT -7

PST (Pacific Standard Time) = GMT -8

AST (Alaska Standard Time) = GMT -9

HST (Hawaii Standard Time) = GMT -10

For other areas: xx hr

5 Press [ENTER].

■ If the clock is an hour slower or faster than the actual time

Select "-1" or "+1" in "Adjust Time Zone" in the SETUP menu (→ 44).

■ If the unit couldn't set the clock automatically

Set the time manually (→ 44, "Set Clock Manually").

■ To start Plug-in Auto Tuning again

Signal source, RF output channel, channel caption, and guide channel settings for VCR Plus+ system all revert to the default values when you perform the procedure below. Scheduled recording settings are also cleared.

When the unit is on and stopped

1 Press and hold [CH, ^] and [CH, v] on the main unit for about 5 seconds.

The unit turns off.

2 Press [⏻, DVD/VHS POWER] to turn the unit on. Plug-in Auto Tuning starts.

Getting started

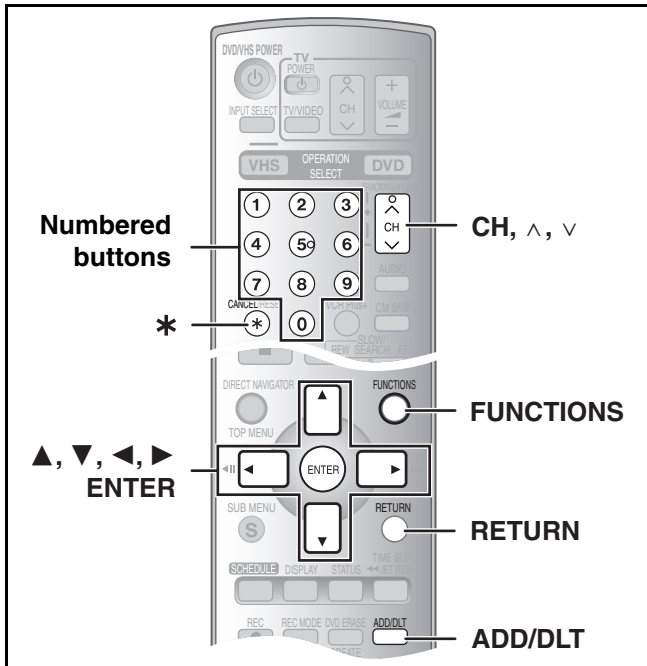

■ If Plug-in Auto Tuning fails

- 1 While stopped Press [FUNCTIONS].
- 2 Select "Other Functions" with [▲, ▼] and press [ENTER].

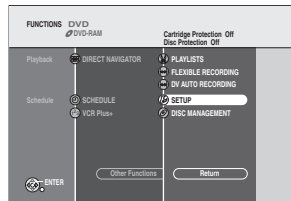

- 3 Select "SETUP" with [▲, ▼] and press [ENTER].

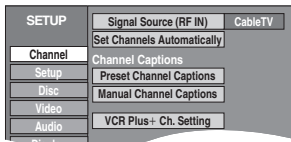

- 4 Select "Channel" with [▲, ▼] and press [◀, ▶].
- 5 Select "Signal Source (RF IN)" with [▲, ▼] and press [ENTER].

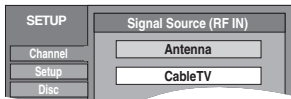

- 6 Select "Antenna" or "CableTV" with [▲, ▼] and press [ENTER].
- 7 Select "Set Channels Automatically" with [▲, ▼] and press [ENTER].
- 8 Press [ENTER].
 - Auto Channel Setting starts. This takes a few minutes.
- 9 Press [ENTER].

■ To cancel in the middle

Press [RETURN].

■ To exit the screen

Press [RETURN] several times.

■ Adding and deleting channels

Add or delete channels if necessary channels are not set or unnecessary channels are set.

- 1 Press the numbered buttons to select a channel.

Antenna Mode (Airwaves)

e.g., "5": [0]→[5]
"15": [1]→[5]

e.g., "5": [0]→[0]→[5]
"15": [0]→[1]→[5]

e.g., "5": [0]→[0]→[5]
"15": [0]→[1]→[5]

e.g., "5": [0]→[0]→[5]
"15": [0]→[1]→[5]

e.g., "5": [0]→[0]→[5]
"15": [0]→[1]→[5]

• You can also use [CH, ^, v] to select a channel.

- 2 Press [ADD/DLT].

e.g., The channel is deleted.

Channel 15 Deleted

STEP 3 Channel settings

■ Guide channel settings for VCR Plus+ system

Set these guide channels so you can use VCR Plus+® system for scheduled recording. Before starting the settings, prepare a chart showing the station names, guide channels and channel numbers.

e.g., :

Station name	Guide channel*	Channel number**	Channel setting
CBS	04	04	Unnecessary
HBO	33	15	Enter channel 15 next to Guide Channel 33.
Nickelodeon	38	20	Enter channel 20 next to Guide Channel 38.

* Look up the guide channels for the stations in magazines.

** Write down all the stations you can receive.

• If you have connected a cable TV box or satellite receiver, the VCR Plus+ system does not work so you do not have to set the guide channels.

- 1 While stopped Press [FUNCTIONS].
- 2 Select "Other Functions" with [▲, ▼] and press [ENTER].
- 3 Select "SETUP" with [▲, ▼] and press [ENTER].
- 4 Select "Channel" with [▲, ▼] and press [◀, ▶].
- 5 Select "VCR Plus+ Ch. Setting" with [▲, ▼] and press [ENTER].
e.g., "Signal Source (RF IN)" is set to "CableTV".

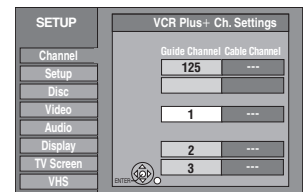
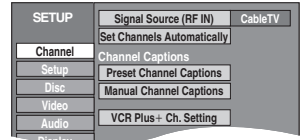

- 6 Use [▲, ▼] to select the guide channel you want to set and press [▶].

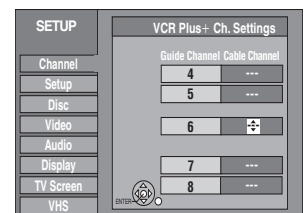

Getting started

- 7 Use [▲, ▼] to select the channel corresponding to the guide channel and press [◀].**
 - To delete a number, press [CANCEL/RESET, *].
 - Repeat steps 6 and 7 to enter other channels.
- 8 Press [ENTER].**

- **To return to the previous screen**
Press [RETURN].
- **To exit the screen**
Press [RETURN] several times.

VCR Plus+ and PlusCode are registered trademarks of Gemstar Development Corporation.
The VCR Plus+ system is manufactured under license from Gemstar Development Corporation.

Pats. 5,307,173; 5,335,079; 4,908,713; 4,751,578; and 4,706,121

Channel captions

You can use the preset captions, or manually enter new ones yourself.
The captions you enter are used as channel names and displayed on the Direct Navigator screen.

- 1 While stopped Press [FUNCTIONS].**
- 2 Select “Other Functions” with [▲, ▼] and press [ENTER].**
- 3 Select “SETUP” with [▲, ▼] and press [ENTER].**
- 4 Select “Channel” with [▲, ▼] and press [◀, ▶].**
 - Go to the item you want to set next.

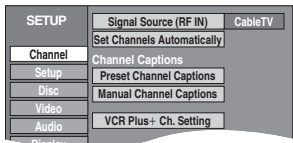
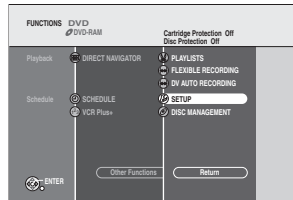

Manual Channel Captions

- Follow steps 1 to 4 of “Channel captions”.
- 5 Select “Manual Channel Captions” with [▲, ▼] and press [ENTER].**
- 6 Use [▲, ▼] to select the channel and press [▶].**
 - Channels are only displayed if they contain a station and if preset captions have not been added.
- 7 Use [▲, ▼] to select the first character and press [▶].**
 - You can choose from the following characters:
A to Z, 0 to 9, -, &, !, /, (space)
 - To delete the caption, press [CANCEL/RESET, *].
 - Repeat this step to enter the other characters.

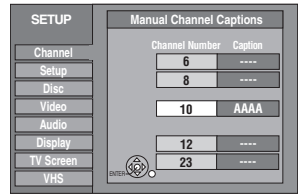

- 8 Use [◀, ▶] to return to the “Channel Number” column.**
 - Repeat steps 6 to 8 to enter other channels.
- 9 Press [ENTER].**

- **To return to the previous screen**
Press [RETURN].
- **To exit the screen**
Press [RETURN] several times.

Preset Channel Captions

- Follow steps 1 to 4 of “Channel captions”.
- 5 Select “Preset Channel Captions” with [▲, ▼] and press [ENTER].**

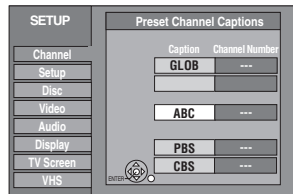

- 6 Use [▲, ▼] to select the caption and press [▶].**

You can choose from the following captions.
ABC, PBS, CBS, CNN, FOX, ESPN, NBC, HBO, A&E, AMC, FAM, MAX, MTV, SHOW, TBS, USA, TNT, CBC, UPN, CTV, WB, TSN, DSC, GLOB
- 7 Use [▲, ▼] to select the channel corresponding to the caption and press [◀].**
 - Channels are displayed only when they contain a station and if captions have not been added manually.
 - To delete the channel number, press [CANCEL/RESET, *].
 - Repeat steps 6 and 7 as necessary.
- 8 Press [ENTER].**

- **To return to the previous screen**
Press [RETURN].
- **To exit the screen**
Press [RETURN] several times.

Getting started

STEP 4 Set up to match your TV and remote control

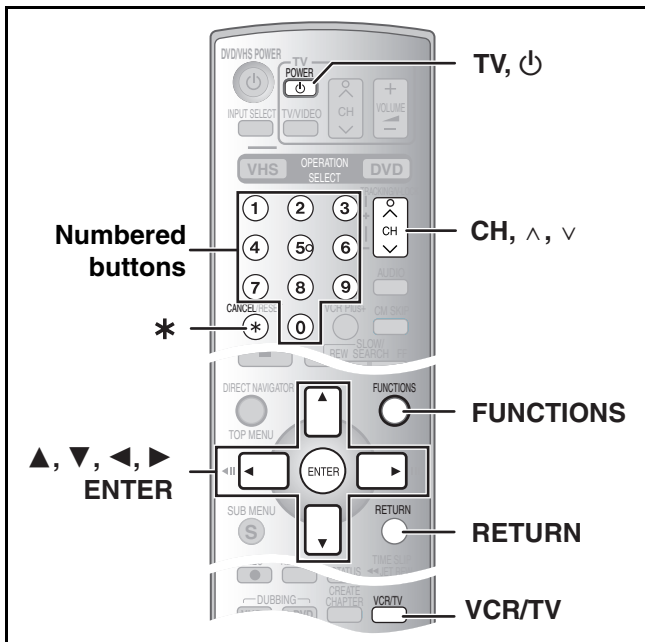

When other Panasonic products respond to this remote control

If other Panasonic products are placed close together, change the remote control code on the main unit and on the remote control (the two must match). When changing the remote control code, make sure the two codes are same.

Under normal circumstances use the factory set code "1".

1 While stopped
Press [FUNCTIONS].

2 Select "Other Functions" with [\blacktriangle , \blacktriangledown] and press [ENTER].

3 Select "SETUP" with [\blacktriangle , \blacktriangledown] and press [ENTER].

4 Select "Setup" with [\blacktriangle , \blacktriangledown] and press [\blacktriangleleft , \blacktriangleright].

5 Select "Remote Control Code" with [\blacktriangle , \blacktriangledown] and press [ENTER].

6 Use [\blacktriangle , \blacktriangledown] to select the code (1, 2 or 3) and press [ENTER].

• The code on the unit has been set.

7 While pressing [ENTER], press and hold the numbered button ([1], [2] or [3]) corresponding to the code you selected in step 6 for about 2 seconds.

• The code on the remote control has been set.

8 Press [ENTER].

When the following indicator appears on the unit's display



The unit's remote control code

Change the code on the remote control to match the main unit's code (\rightarrow step 7).

To return to the previous screen

Press [RETURN].

To exit the screen

Press [RETURN] several times.

TV operation

To turn the TV on/off, change the TV input mode, select the TV channel and change the TV volume by means of this remote control, set the remote control as follows.

Point the remote control at the TV

While pressing [$\text{\textcircled{P}}$ POWER TV], enter the code using the numbered buttons.

e.g., 01: press [0] \rightarrow [1].

Manufacturer and Code No.

Panasonic		PHILIPS (RC-5)	03
National	01, 02	RCA	05
QUASAR		SAMSUNG	14, 18, 19
FISHER	10	SANYO	10
GE	05	SHARP	06, 07
GOLDSTAR	15, 16, 17	SONY	08
HITACHI	12	SYLVANIA	03
JVC	11	THOMSON	05
LG	15, 16, 17	TOSHIBA	09
MAGNAVOX	03	ZENITH	04
MITSUBISHI	13		

• Test by turning on the TV and changing channels. Repeat the procedure until you find the code that allows correct operation.

• If your TV brand is not listed or if the code listed for your TV does not allow control of your TV, this remote control is not compatible with your TV.

Getting started

■ Selecting TV type

You do not have to change the setting when connected to a 4:3 standard aspect TV that is not compatible with progressive output. (→ 58)

- 1 While stopped
Press [FUNCTIONS].
- 2 Select "Other Functions" with [▲, ▼] and press [ENTER].
- 3 Select "SETUP" with [▲, ▼] and press [ENTER].
- 4 Select "TV Screen" with [▲, ▼] and press [◀, ▶].
- 5 Select "TV Type" with [▲, ▼] and press [ENTER].

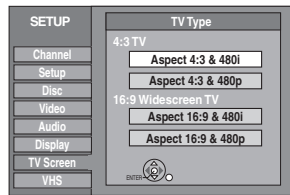

- Aspect 4:3/Aspect 16:9:

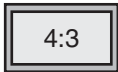

4:3 standard aspect TV

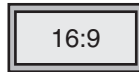

16:9 widescreen TV

- 480p/480i:

Select "480p" if the TV is compatible with progressive output.

- 6 Use [▲, ▼] to select the item and press [ENTER].

When progressive output is selected, the following screen appears:

- When progressive output is selected, you will not be able to see the picture unless the TV is connected to the COMPONENT VIDEO OUT terminal on this unit. This is not a malfunction.

- (1) Select "Yes" with [◀] and press [ENTER].
 - A confirmation screen appears.
- (2) Press [ENTER].

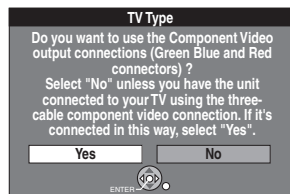

To change to interlace

- When the picture is distorted, press and hold [CANCEL/RESET, *] until the picture is displayed correctly.

■ To return to the previous screen

Press [RETURN].

■ To exit the screen

Press [RETURN] several times.

■ Removing Interference

Connection (without Audio/Video cable) only
TV screen



Picture with interference

In some cases, there may be interference (lines or patterning) or a very poor picture on the TV when the DVD Recorder is connected. If this happens, follow the steps below to change the video playback channel (RF output channel). This will remove the interference.

- 1 Press [FUNCTIONS] for more than 5 seconds.
The RF output channel number is displayed on the unit display.
- 2 Press [CH, ▲, ▼] to select a channel number (CH3 or CH4).

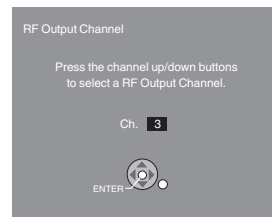

The unit's display



The unit's display

Each time you press the button:
CH3 (Default setting) ↔ CH4 ↔ OFF

- Set the RF output channel of the DVD Recorder to "OFF" (RF OFF) when the DVD Recorder is connected to a TV via the Audio/Video cable.

- 3 Press [ENTER] to finish this setting.



The clear picture

■ When you set the RF output channel to "CH3" or "CH4"

A picture is output on CH3 or CH4 from RF output.

Press [VCR/TV] to switch the mode from TV to VCR, and vice versa.

- When the TV mode is selected, the "TV" indicator lights on the unit's display and you can watch TV.
- When the "TV" indicator does not light, then the VCR mode is selected and you can watch images from the unit.

Frame-by-frame viewing

RAM -R -RW(V) +R (Motion picture parts only) **DVD-V -RW(VR) VCD**

While paused

Press [**◀▶▶**] ([**◀**]) or [**▶▶▶**] ([**▶**]).

- Each press shows the next or previous frame.
- Press and hold to change in succession forward or backward.
- Press [**▶**], PLAY] to restart playback.
- **VCD** Forward direction ([**▶▶▶**], [**▶**]) only.

Direct play

RAM -R -RW(V) +R DVD-V -RW(VR) VCD CD

You can play from the title, chapter or track you select.

During play

Press the numbered buttons to select an item.

CD (MP3 and JPEG disc only)

e.g.: "5": [0]→[5] "5": [0]→[0]→[5]
 "15": [1]→[5] "15": [0]→[1]→[5]

- This works only with some discs when stopped (screen saver is displayed → right).



Erasing a title that is being played

RAM -R -RW(V) +R

Once title is erased, it cannot be restored. Make certain before proceeding.

1 During play

Press [**DVD ERASE**].

2 Press [**◀**] to select "Erase" and press [**ENTER**].

For your reference

- You cannot erase while recording or transferring (dubbing).
- **-R +R** Available space does not increase after erasing.
- **-RW(V)** Disc space increases only when the last recorded title is erased.

CM Skip

RAM -R -RW(V) +R -RW(VR)

You can skip approximately 1 minute with one press.

During play

Press [**CM SKIP**].

Create chapters

RAM

During play or while paused

Press [**CREATE CHAPTER**].

- Press [**◀◀**], SKIP] or [**▶▶**], SKIP] to skip to the start of a chapter.
- You cannot activate this function when you are carrying out TIME SLIP (→ 26) or transfer (dub).

Displaying the TV image as a picture-in-picture/Selecting an amount of time to skip — Time Slip

RAM -R -RW(V) +R -RW(VR)

Press [TIME SLIP] during play and the PIP (Picture-In-Picture) screen (TV image) is displayed in the lower right part of the main screen. You can watch both playback images and TV images at the same time. In the main screen, you can also instantly access a scene you want to view by specifying an amount of time you want to skip.

1 During play

Press [**TIME SLIP**].

- The PIP screen (TV images) appears.
- You can change the channel being received by pressing [CH, ▲, ▼].
- You will hear the playback audio of the main screen.

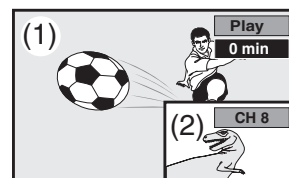

- (1) Play images
 (2) Currently receiving images

2 While observing the time indicator at the top right

Press [**▲**, **▼**] to set an amount of time to skip and press [**ENTER**].

- Play skips the amount of time you specified.
- The time indicator will go off after about 5 seconds, but will turn on again when you set the time.

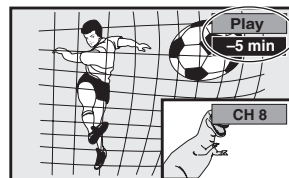

■ To clear the PIP screen

Press [TIME SLIP].

For your reference

- The blue background does not appear on the PIP screen. (→ 43)
- You cannot change the channel being received while recording.

Changing audio during play

Press [**AUDIO**] to select the audio type.

- You can select audio types depend on the recording medium.

RAM -RW(VR) VCD (→ 45)
 Stereo → Mono L → Mono R
 ↑

e.g.: **RAM**
 "Stereo" is selected.



RAM -RW(VR) [When playing an SAP broadcast recorded on DVD-RAM, DVD-RW (DVD Video Recording format)]
 MAIN ↔ SAP

DVD-V (→ 38)

This allows you to change items like the audio channel number and the sound track language.



e.g.: English is the selected language.

Note

- If you cannot change the audio type when you have used only an optical digital cable for connection, set "Dolby Digital" to "PCM" (→ 42). Alternatively, you may connect to an amplifier with an Audio/Video cable and change the input on the amplifier to suit the connection.

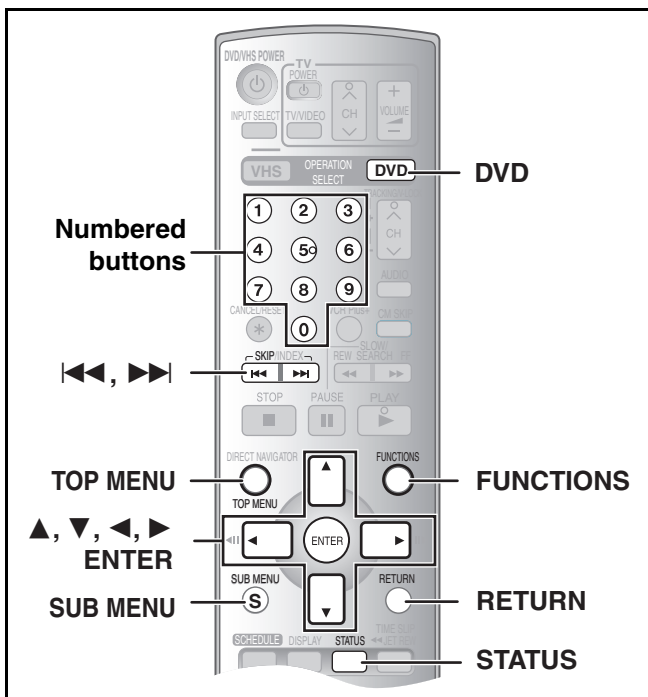

Preparation

- Press [DVD].

Playing discs which contain both MP3 and still pictures

CD

The screen shown below is displayed when you insert a disc containing MP3 files and still pictures (JPEG).

Press [ENTER].

■ To play MP3

Refer to "Using menus to play MP3 discs".

(→ right)

■ To play still pictures

Refer to "To show the JPEG Menu". (→ 23)

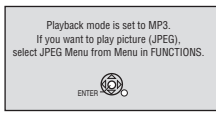

- You can play MP3 and still pictures (JPEG) on this unit by making folders as shown below. However depending on how you create the disc (writing software), play may not be in the order you numbered the folders.
- English alphabetical characters and Arabic numerals are displayed correctly. Other characters may not be displayed correctly.
- When the highest level folders are "DCIM" folders, they are displayed first on the tree.

Structure of MP3 folders

Prefix with 3-digit numbers in the order you want to play them.

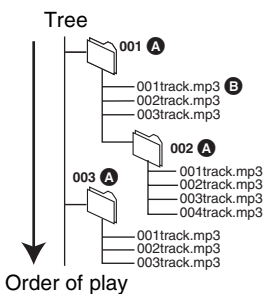

Structure of still pictures (JPEG)

Files inside a folder are displayed in the order they were updated or taken.

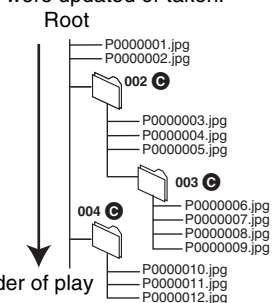

- A** Folder = Group
- B** File = Track
- C** Folder

Regarding MP3 and still pictures (JPEG)

- Compatible formats: ISO9660 level 1 or 2 (except for extended formats) and Joliet
- Maximum number of files (tracks) and folders (groups) recognizable: 999 files (tracks) and 99 folders (groups)
- This unit is compatible with multi-session but reading or play of the disc may take time if there are a lot of sessions.
- Operation may take time to complete when there are many files (tracks) and/or folders (groups) and some files (tracks) may not display or be playable.
- The display order on this unit may differ from how the order is displayed on a computer.
- Depending on how you create the disc (writing software), files (tracks) and folders (groups) may not play in the order you numbered them.
- This unit is not compatible with packet-write format.
- Depending on the recording, some items may not be playable.

Regarding MP3

- File format: MP3
 - Files must have the extension ".mp3" or ".MP3".
- Bit rates: 32 kbps to 320 kbps
- Sampling frequency: 16 kHz/22.05 kHz/24 kHz/32 kHz/44.1 kHz/48 kHz
- This unit is not compatible with ID3 tags.
- If there is a large amount of still picture data etc. within a MP3 file, play may not be possible.

Regarding still pictures (JPEG)

- File format: JPEG (non-compressed RGB chunky format)
 - Files must have the extension ".jpg" and ".JPG".
- Number of pixels: 34 × 34 to 3840 × 2160 (Sub sampling is 4:2:2 or 4:2:0)
 - This unit cannot play images that have resolutions beyond the range shown.
- MOTION JPEG is not supported.

Using menus to play MP3 discs

CD

The unit plays MP3 files recorded on CD-R/RW designed for audio recording that are finalized (→ 58) on a computer. Files are treated as tracks and folders are treated as groups.

1 During stop or play Press [TOP MENU].

- The file list appears.

Selected Group No. and Name

G:
The Group Number

T:
Track Number in the Group

Total:
Selected Track Number/
Total Track Number

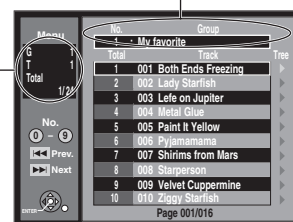

2 Press [▲, ▼] to select the track and press [ENTER].

- Play starts on the selected track.
- "□" indicates the track currently playing.
- You can also directly select the track with the numbered buttons.

e.g.:
"6": [0] → [0] → [6]
"10": [0] → [1] → [0]

■ Using the tree screen to find a group (→ 23)

■ To show other groups

Press [◀] (Prev.) or [▶] (Next) to show other pages.

- After listing all the tracks in one group, the list for the next group appears.

■ To exit the file list

Press [TOP MENU] or [RETURN].

■ Using the tree screen to find a group

- While the file list is displayed (→ 22)
Press [▶] while a track is highlighted to display the tree screen.



Selected Group Number/Total Group Number

- If the group has no track, “—” is displayed as group number.

- You cannot select groups with no MP3 files.
- Press [◀, ▶] to jump layers in the tree screen.

- Press [▲, ▼] to select a group and press [ENTER].

- The file list for the selected group appears.

■ To return to the file list

Press [RETURN].

To show the JPEG Menu

CD [with MP3 files and still pictures (JPEG)]

- While stopped
Press [FUNCTIONS].
- Select “MENU” with [▲, ▼] and press [ENTER].
- Select “JPEG Menu” with [▲, ▼] and press [ENTER].

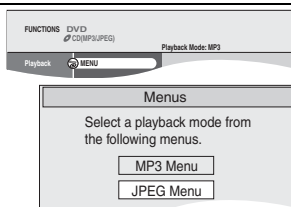

CD [with still pictures (JPEG) only]

Press [TOP MENU].

- Depending on the JPEG file size, the thumbnail may not be shown correctly.
- Except for 4:3 JPEG thumbnails, the thumbnail may not be shown correctly.

■ To show other pages

Press [◀] (Previous) or [▶] (Next) to show other pages.

- You can also press [▲, ▼, ▶, ▶] to select “Previous” or “Next” and press [ENTER] to show other pages.

■ To exit the JPEG Menu

Press [TOP MENU] or [RETURN].

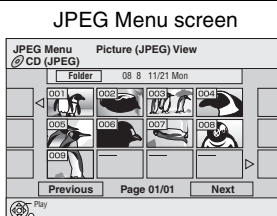

▶ Playing a still picture

- Make sure that the JPEG Menu screen appears by following the steps in “To show the JPEG Menu”.

Use [▲, ▼, ▶, ▶] to select a still picture you want to watch and press [ENTER].

- You can also select a still picture by entering a 3-digit with the numbered buttons.
e.g.: “5”: [0]→[0]→[5]
“15”: [0]→[1]→[5]
- You can watch the still pictures in order by pressing [◀] (previous) or [▶] (next).

To rotate a still picture

- Press [SUB MENU].
 - Select “Rotate Right” or “Rotate Left” with [▲, ▼] and press [ENTER].
- Rotation information will not be stored.

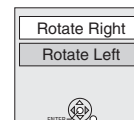

To show the picture properties

- Press [STATUS] twice.
- Press [STATUS] again, the properties disappear.

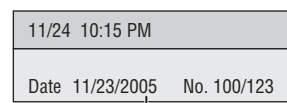

Shooting Date

▶ Start Slide Show/Slide Interval

- Make sure that the JPEG Menu screen appears by following the steps in “To show the JPEG Menu”.

You can display still pictures one by one with constant interval.

- Select “Folder” with [▲] and press [SUB MENU].
- Select “Start Slide Show” with [▲, ▼] and press [ENTER].

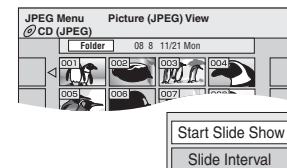

■ To exit the Slide Show

Press [TOP MENU].

To Change the display timing

- Select “Slide Interval” with [▲, ▼] in step 2 and press [ENTER].
 - Press [◀, ▶] to select the desired timing (0 to 30 seconds) and press [ENTER].
- When the selected JPEG file size is large, the actual slide interval may be longer than the selected timing.

▶ To select the still pictures in another folder

- Make sure that the JPEG Menu screen appears by following the steps in “To show the JPEG Menu”.

- Select “Folder” with [▲] and press [ENTER].
- Select the folder with [▲, ▼] and press [ENTER].

- Ⓐ Selected folder no./Total folder no.
- Ⓑ You cannot select folders that contain no compatible files.

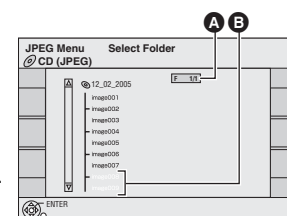

Recording TV programs

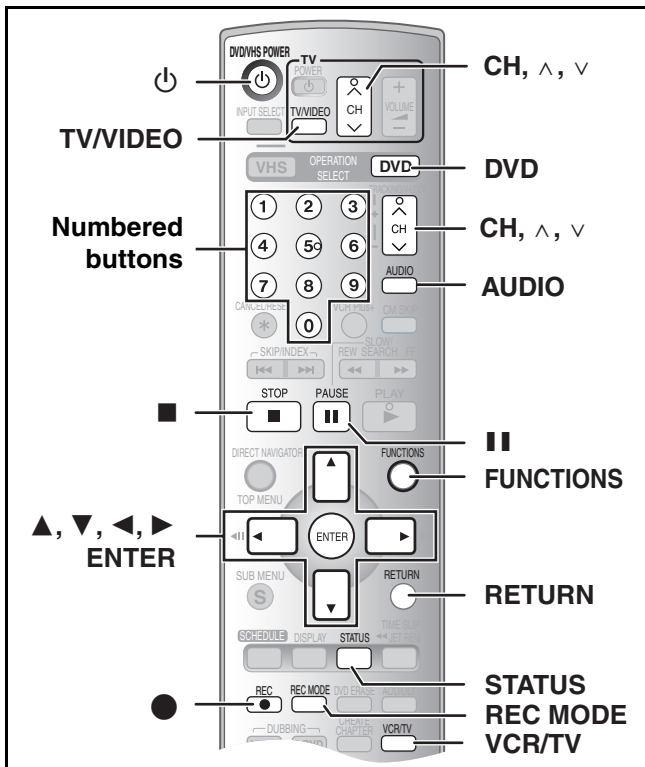

Preparation

- Press [DVD].

Recording procedures

RAM -R -RW(V) +R

- You can record up to 99 titles on a disc (49 titles **+R**).
- It is not possible to record digital broadcasts that allow "One time only recording" onto DVD-R, DVD-RW, +R or 8 cm (3") DVD-RAM discs. Use a CPRM compatible DVD-RAM.
- Recording will take place on open space on the disc. Data will not be overwritten.
- If there is no space left on the recording disc, you will need to erase unwanted titles (→ 21, 33) or use a new disc.

When recording to DVD-R, DVD-RW (DVD-Video format) or +R

- When recording MTS broadcasts
 - If you do not connect a cable TV box
 - Select "Main" or "Secondary Audio Program (SAP)" in "Select MTS" in the SETUP menu (→ 42).
 - If you connect a cable TV box
 - Select "Main" or "SAP" on the cable TV box.
- The aspect ratio of the recorded image will be 4:3.
- **In order to play a DVD-R, DVD-RW (DVD-Video format) or +R recorded using this unit on another playback source, the disc must first be finalized (→ 31).**

Preparation

- Release protection (disc → 30, cartridge → 30). **RAM**
- Select an audio type you want to record. (→ 25)

1 Press [DVD/VHS POWER] to turn the unit on.

2 Insert a disc. (→ 8)

- When using a DVD-RAM for the first time with the unit, format it to ensure accurate recording (→ 31, "Format Disc").

3 Press [CH, ^, v] to select the channel.

To select with the numbered buttons:

Antenna Mode (Airwaves)

e.g., "5": [0]→[5]

"15": [1]→[5]

CableTV Mode (Cable)

e.g., "5": [0]→[0]→[5]

"15": [0]→[1]→[5]

"115": [1]→[1]→[5]



4 Press [REC MODE] to select the recording mode (XP, SP, LP or EP).



Remaining time on the disc

5 Press [●, REC] to start recording.



- You cannot change the channel or recording mode during recording. You can change them while recording is paused, but the subsequent material is recorded as a separate title.

To pause recording

Press [II, PAUSE]. (Press again to restart recording.)

- Title is not split into separate titles.
- You can also press [●, REC] to restart recording.

To stop recording

Press [■, STOP].

- Recorded as 1 title until the position where stopped.
- It takes about 30 seconds for the unit to complete recording management information after recording finishes. **-R -RW(V) +R**

Recording modes and approximate recording times

(Unit: hour)

	DVD-RAM		DVD-R DVD-RW +R (4.7 GB)
	Single-sided (4.7 GB)	Double-sided (9.4 GB)	
XP (High quality)	1	2	1
SP (Normal)	2	4	2
LP (Long play)	4	8	4
EP (Extra long play)	8 (6*)	16 (12*)	8 (6*)

- Depending on the content being recorded, the recording times may become shorter than indicated.

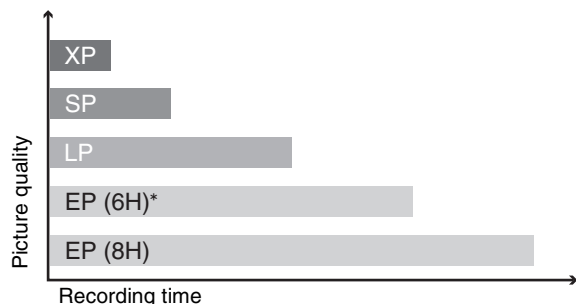

* When "Recording Time in EP Mode" has been set to "EP-Extended Play (6H)" in the SETUP menu. (→ 41)

The sound quality is lower compared to other recording modes when using "EP-Extended Play (8H)".

Note

When recording to DVD-RAM using EP (8H) mode, play may not be possible on DVD players that are compatible with DVD-RAM. In this case use EP (6H) mode.

FR (Flexible Recording mode → 25):

- You can set FR mode when programming scheduled recordings.

Selecting audio to record

RAM

Press [AUDIO].

Stereo → SAP → Mono



Stereo:	Main audio (stereo). If the broadcast is "Mono+SAP", audio will be monaural even if you select Stereo mode.
SAP:	Secondary audio program (SAP). If recorded in SAP, main audio is also recorded.
Mono:	Main audio (monaural). Select "Mono" if reception is poor during a stereo broadcast.

e.g., "Stereo" is selected.
 "(" appears when the unit is receiving the audio type you selected.



-R -RW(V) +R

Select the audio [Main or Secondary Audio Program (SAP)] in "Select MTS" in the SETUP menu. (→ 42)

Specifying the time when recording will stop

While recording

Press [●, REC] to select the recording time.

- You can also press [●, REC] on the main unit.

The unit's display

Each time you press the button:

Counter (Cancel) → OFF 0:30 → OFF 1:00 → OFF 1:30

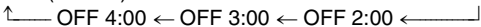

For your reference

- This does not work during scheduled recording or Flexible Recording.
- Recording stops and the set time is cleared if you press [■, STOP].
- The set time is cleared if you change the recording mode or channel while recording is paused.

Watching the TV while recording

Preparation

- Connection (without Audio/Video cable)
 - Make sure that the "TV" indicator is lit on the unit's display. If it is not lit, press [VCR/TV] to light it.
- Connection (with Audio/Video cable)
 - Press [TV/VIDEO] to change the input mode to "TV".

Press TV's [CH, ^, v] to select the desired TV channel.

For your reference

- You can also do this if the unit is making a scheduled recording.
- The recording is unaffected.

Flexible Recording mode (FR)

RAM -R -RW(V) +R

The unit calculates a recording rate that enables the recording to fit in the time you set (within the remaining time on the disc) with the best picture quality.

Using "FLEXIBLE RECORDING" is convenient in these kinds of situations.

- When the amount of free space on the disc makes selecting an appropriate recording mode difficult
- When you want to record a long program with the best picture quality possible
 e.g., Recording a 90 minute program to disc
 If you select XP mode, the program will not fit on one disc.



A second disc is necessary for 30 minutes of the program.

If you select SP mode, the program will fit on one disc.



However there will be 30 minutes remaining disc space



If you select "FLEXIBLE RECORDING" the program will fit on one disc perfectly.

Preparation

- Press [DVD].
- Select the channel to record.

- While stopped**
Press [FUNCTIONS].
- Select "Other Functions" with [▲, ▼] and press [ENTER].
- Select "FLEXIBLE RECORDING" with [▲, ▼] and press [ENTER].
- Press [▲, ▼, ◀, ▶] to set the recording time.
 - Maximum recording time is 8 hours.
- Select "Start" with [▲, ▼, ◀, ▶] and press [ENTER].
 - Recording starts.

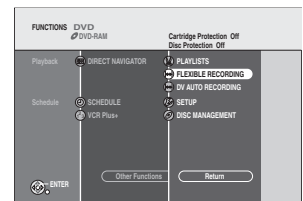

■ To exit the FLEXIBLE RECORDING window without recording

Press [RETURN].

■ To stop recording in the middle

Press [■, STOP].

■ To show the time remaining until recording finishes

Press [STATUS].



Remaining time

Recording

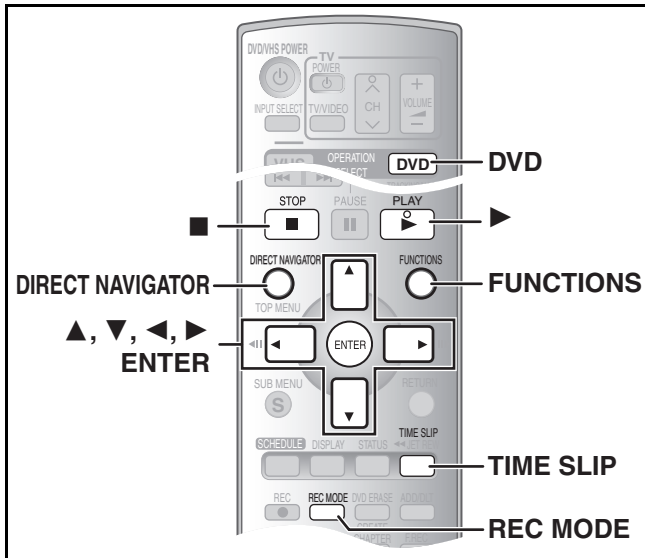

Preparation

- Press [DVD].

Playing while you are recording

RAM

Hint

- Sound is not output while fast-forwarding.

Chasing play

You can start play from the beginning of the title while continuing to record it.

While recording or scheduled recording

Press [▶, PLAY].

- Play starts while recording proceeds.

For your reference

- After recording has started, it will take time before this feature can be used.

Simultaneous recording and play

You can play a title previously recorded while you are recording another title.

1 While recording or scheduled recording

Press [DIRECT NAVIGATOR]. (→ 33)

- : Currently recording

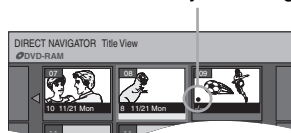

2 Use [▲, ▼, ◀, ▶] to select a title and press [ENTER].

- Play starts while recording proceeds.

To exit the Direct Navigator screen

Press [DIRECT NAVIGATOR].

For your reference

- During simultaneous recording and play, you cannot edit or erase titles with the Direct Navigator or playlists.

TIME SLIP

Press [TIME SLIP] while recording. Play starts from 30 seconds earlier. You can start play from even earlier by specifying an amount of time to skip on the time indicator.

1 While recording or scheduled recording Press [TIME SLIP].

- The PIP screen (image currently being recorded) is displayed.
- On the main screen, play starts from 30 seconds earlier.
- You will hear the playback audio.

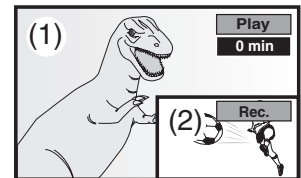

- (1) Play starts from 30 seconds earlier.
- (2) The image currently being recorded.

2 While observing the time indicator at the top right Press [▲, ▼] to set the amount of time to skip and press [ENTER].

- Play skips the amount of time you set.
- The time indicator goes off after about 5 seconds. However it turns on again when you set the time.

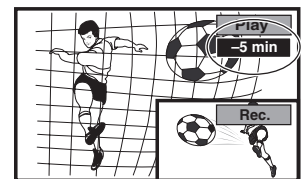

To show the play images in full

Press [TIME SLIP].

- Press [TIME SLIP] to return to the PIP screen.

For your reference

- The image on the PIP screen may be distorted or flicker depending on the scene. However, this does not affect the image recorded.

To stop play and recording

1 Press [■, STOP]. Play stops.

(Wait 2 or more seconds.)

2 Press [■, STOP]. Recording stops.

- You cannot stop recording with [■, STOP] during scheduled recording. To stop scheduled recording, press [■, STOP], then [ENTER] within 5 seconds.
- You can also press and hold [■] on the main unit for 3 or more seconds to stop scheduled recording.

Playing VHS while recording

You can play tapes while recording. The recording will not be affected.

- VHS playback (→ 47)

■ DV automatic recording (DV AUTO RECORDING)

RAM

When the “DV AUTO RECORDING” function is used, programs are recorded as a title. At the same time chapters are created at each break in the images automatically.

Preparation

- (1) Turn off the main unit and DV equipment, then connect the equipment with the unit's DV input terminal (→ 57).
- (2) Turn on the main unit and DV equipment.
- (3) Pause play of the DV equipment at the point you want recording to start.
- (4) Press [DVD].

1 While stopped

Press [FUNCTIONS].

2 Select “Other Functions” with [▲, ▼] and press [ENTER].

3 Select “DV AUTO RECORDING” with [▲, ▼] and press [ENTER].

4 Press [REC MODE] to select the recording mode. (→ 24)

5 Select “Rec.” with [◀, ▶] and press [ENTER].

- Recording starts.

■ When recording finishes

The confirmation screen appears. Press [ENTER] to finish DV automatic recording.

■ To stop recording

Press [■, STOP].

■ Notes on DV automatic recording

- Only one piece of DV equipment (e.g., digital video camcorder) can be connected to the unit via the DV input terminal.
- Video camcorders from other manufacturers are not guaranteed to work.
- It is not possible to operate the unit from the connected DV equipment.
- The DV input on this unit is for use with DV equipment only. (It cannot be connected to a computer, etc.)
- The DV equipment name may not be shown correctly.
- Depending on the DV equipment, the images or audio may not be input properly.
- The date and time information on the tape in the DV equipment will not be recorded.
- You cannot recording and play simultaneously.
- When you are recording from a digital video camcorder, there may be a slight delay (approx. 1 second) between pressing [ENTER] and recording starting. To ensure you record everything you want, start recording slightly earlier.

If the DV automatic recording function does not work properly, check the connections and DV equipment settings, and turn the unit off and back on.

If that does not work, follow the instructions for “Recording from an external device” (→ 57).

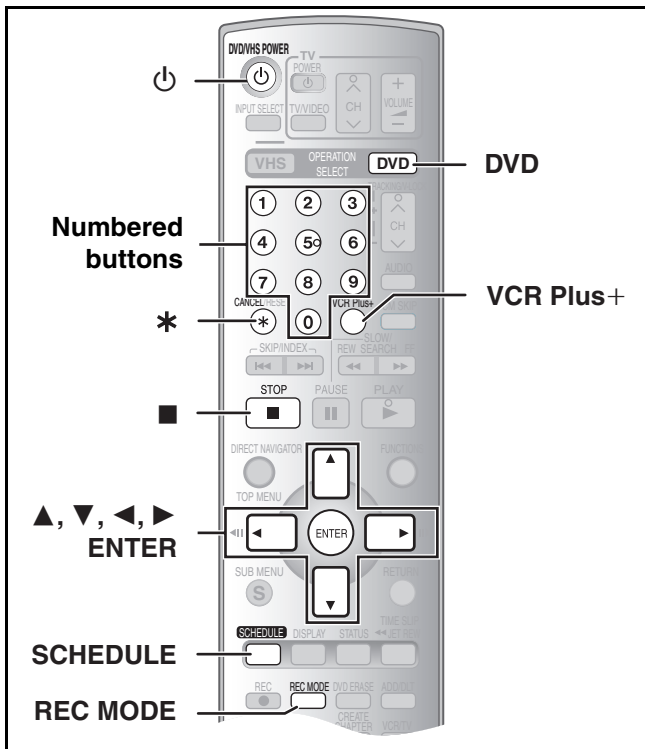

RAM -R -RW(V) +R

Preparation

- Press [DVD].

Cautions for using scheduled recording on DVD

■ Scheduled recording automatically starts at the set time.

- Scheduled recording can be started only when the unit is turned off. About 1 minute before the scheduled recording starts, the unit switches on. When it finishes, the unit switches back off. If another program is also being played back, the unit does not switch back off.

■ Scheduled recording cannot be activated on both DVD and VHS at the same time.

Make sure the scheduled recording start times do not overlap on both DVD (→ 29) and VHS (→ 51) Scheduled Recording List screens.

When the scheduled recording settings overlap:

- When the start time of both scheduled recordings is the same, the scheduled recording of the last one set has priority.

Scheduled Recording

You can enter up to 16 programs a month in advance.

Preparation

- Release protection (disc → 30, cartridge → 30) **RAM**.
- Insert a disc (→ 8) and confirm there is sufficient empty space for recording on it (→ 45).
- Check that the clock is set to the correct time.

■ Using VCR Plus+ system

Entering the PlusCode® numbers is an easy way of scheduled recording. You can find these codes in TV listings in newspapers and magazines.

- When connecting a cable TV box or satellite receiver, the VCR Plus+ system does not work. Program the scheduled recording manually (→ 29).

1 Press [VCR Plus+].



2 Press the numbered buttons to enter the PlusCode number.

- Press [◀] to move back to correct a digit.

3 Press [ENTER].

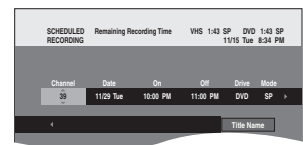

- Confirm the program and correct it if necessary using [▲, ▼, ◀, ▶] ("Manual programming" → 29, step 2).
- When "XP" is displayed in the unit's display, the recording mode automatically changes to "FR" in order to prevent loss of recording when there is not enough space. Change to "XP" mode if you want to set scheduled recording using "XP" mode.
- "Invalid Entry" is displayed when you enter the wrong PlusCode number. Reenter the PlusCode number.
- **To enter the name of the program**
Press [◀, ▶] to select "Title Name" and press [ENTER] (→ 32).

4 If the program is correct

Press [ENTER].

- Make sure that the scheduled recording has been programmed correctly on the SCHEDULED LIST screen (→ 29).
- Repeat steps 1–4 to program other recordings.

5 Press [SCHEDULE].

- The message "Turn recorder off for Scheduled Recording." is shown on the TV.

6 Press [⏻, DVD/VHS POWER].

- Scheduled recording can be started only when the unit is turned off.
- The unit turns off and "⏻" lights on the unit's display to indicate scheduled recording standby has been activated.

■ To release the unit from scheduled recording standby

Press [⏻, DVD/VHS POWER].

The unit turns on and "⏻" goes out.

- Be sure to press [⏻, DVD/VHS POWER] to return the unit to standby mode before the scheduled recording time. Scheduled recording will work only if "⏻" is displayed.

■ To stop recording while a program is working

1 Press [DVD]

2 Press [■, STOP], then [ENTER] within 5 seconds.

- You can also press and hold [■] on the main unit for 3 or more seconds to stop recording.

Note

Refer to Note in Manual programming (→ 29).

Manual programming

- When connecting a cable TV box or satellite receiver, select the channel on the cable TV box or satellite receiver before scheduled recording starts.

1 Press [SCHEDULE].

- Make sure "New Scheduled Recording" is selected.

New Scheduled Recording is selected.

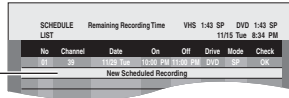

2 Press [ENTER], then move and change the items using [▲, ▼, ◀, ▶].

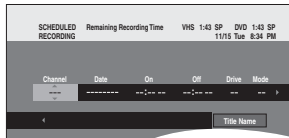

- You may use the numbered buttons to enter "Channel", "Date", "On", and "Off".

- Channel** (Program Position/TV Station Name)
- Date**

You can also make a daily or weekly program. Each daily or weekly program is counted as one program.

- On** (start time)/**Off** (finish time)
The time increases or decreases in 30-minute increments if you hold down the button.
- Drive** (Recording drive)
Select recording drive to "DVD".
- Mode** (Recording mode)
You can also press [REC MODE] to change the recording mode.

XP↔SP↔LP↔EP↔FR↔XP... (→ 24)

- Title Name**
Press [◀, ▶] to select "Title Name" and press [ENTER] (→ 32).

3 Press [ENTER] when you have finished making changes.

- "Invalid Entry" is displayed when you enter the wrong item. Reenter the item.
- Make sure that the scheduled recording has been programmed correctly on the SCHEDULE LIST screen (→ right).
- To continue programming:
Select "New Scheduled Recording" and repeat steps 2–3.

4 Press [SCHEDULE].

- The message "Turn recorder off for Scheduled Recording." is shown on the TV.

5 Press [⏻, DVD/VHS POWER].

- Scheduled recording can be started only when the unit is turned off.
- The unit turns off and "⏻" lights on the unit's display to indicate scheduled recording standby has been activated.

To release the unit from scheduled recording standby Press [⏻, DVD/VHS POWER].

The unit turns on and "⏻" goes out.

- Be sure to press [⏻, DVD/VHS POWER] to return the unit to standby mode before the scheduled recording time. Scheduled recording will work only if "⏻" is displayed.

To stop recording while a program is working

- Press [DVD]
- Press [■, STOP], then [ENTER] within 5 seconds.
 - You can also press and hold [■] on the main unit for 3 or more seconds to stop recording.

Note

- When the unit is carrying out a scheduled recording, you can utilize playback. **RAM**

- "⏻" flashes when the unit cannot perform scheduled recording (non-recordable disc or protected disc, etc.). Check the disc carefully.
- The actual time recorded may be longer than the program itself when TV programs are recorded using VCR Plus+ system.
- When recording more than one program in a row, for DVD-RAM the first few seconds, and for DVD-R, DVD-RW (DVD-Video format) or +R about the first 30 seconds of all programs from the second one onwards will not be recorded.
- If you set "DST" (Daylight Saving Time) to "On" when manually setting the clock (→ 44), scheduled recording may not work when summer switches to winter and vice versa.

Check, change or delete programs

Even when the unit is turned off, you can display the scheduled recording list by pressing [SCHEDULE].

1 Press [SCHEDULE].

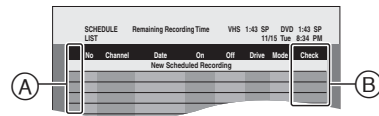

Icon explanations (A)

- Currently recording
- Ⓜ** Programs are overlapped. Recording of the program with the later start time starts when the earlier program finishes recording.
- ⊖** You stopped a weekly or daily scheduled recording. The icon disappears when the next scheduled recording starts.
- Ⓛ** The disc was full. (not enough space)
- Ⓢ** The TV program may not be recorded due to copy-protection.
- ⓧ** Recording stopped (Dirty disc, etc.)

Check (B)

OK: Recordable

→ **(Date):** The last day of daily or weekly recording.

!: It may not be possible to record because:

- the disc is write-protected
- there is no more space left
- the number of possible titles has reached its maximum.

Overlap: When the date and time overlap with another scheduled recording, only a part of the program can be recorded.

—: Scheduled recording for VHS.

2 Press [▲, ▼] to select the program.

- You may also select program by inputting a 2-digit number using the numbered buttons.

e.g.: "5": [0]→[5]

"15": [1]→[5]

- Press [◀, ▶] to move to the preceding or following page.

3 Press [CANCEL/RESET, *] to delete,

You cannot delete programs that are currently recording.

or press [ENTER] to change.

The scheduled recording setting screen appears.

4 If you pressed [ENTER] in step 3,

Use [▲, ▼, ◀, ▶] to change and press [ENTER].

5 Press [SCHEDULE].

- The message "Turn recorder off for Scheduled Recording." is shown on the TV.

To put the unit on scheduled recording standby

Press [⏻, DVD/VHS POWER].

- The unit turns off and "⏻" lights on the unit's display to indicate scheduled recording standby has been activated.

For your reference

- Programs that failed to record are not deleted from the list immediately (indicated in gray), but are deleted from the list automatically at 4 a.m. 2 days later.
- During scheduled recording, you can change the end time as long as the recording mode is not "FR".

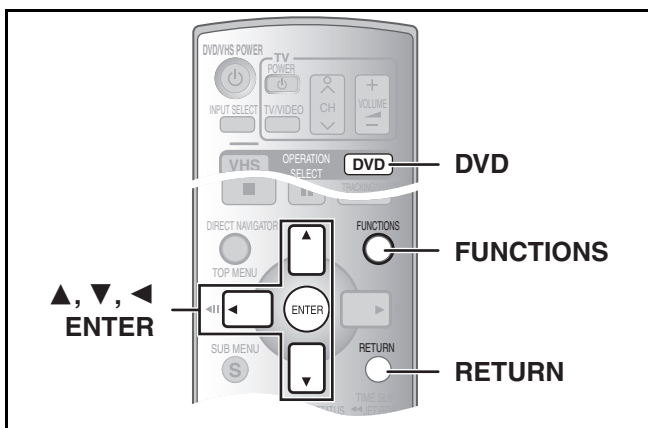

DISC MANAGEMENT

RAM -R -RW(V) +R

Preparation

- Release protection (disc → right, cartridge → right). **RAM**
- Insert a disc (→ 8).
- Press [DVD].

1 While stopped Press [FUNCTIONS].

2 Select “Other Functions” with [▲, ▼] and press [ENTER].

3 Select “DISC MANAGEMENT” with [▲, ▼] and press [ENTER].

e.g., DVD-RAM

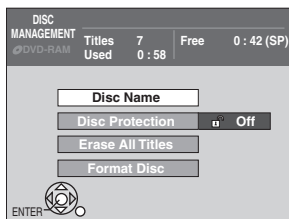

e.g., DVD-RAM

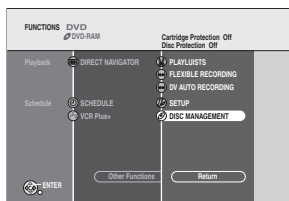

e.g., DVD-R

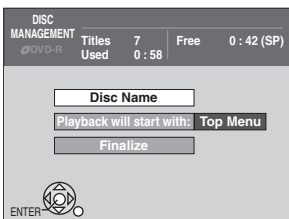

4 Use [▲, ▼] to select a desired item and press [ENTER].

You can change various settings.

- After this operation, follow the desired operation.

■ To stop in the middle

Press [RETURN].

▶ Disc Name

RAM -R -RW(V) +R

- Follow steps 1 to 3 of “DISC MANAGEMENT”.

4 Select “Disc Name” with [▲, ▼] and press [ENTER].

Refer to “Entering text” (→ 32).

- The disc name is displayed in the FUNCTIONS window.

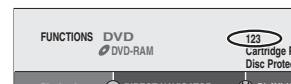

- With a finalized DVD-R, DVD-RW (DVD-Video format) and +R, the name is displayed on the Top Menu.

▶ Disc Protection

RAM

- Follow steps 1 to 3 of “DISC MANAGEMENT”.

This allows you to protect the whole disc from accidental erasure and release disc protection.

4 Select “Disc Protection” with [▲, ▼] and press [ENTER].

5 Select “Yes” with [◀] and press [ENTER].

- To protect

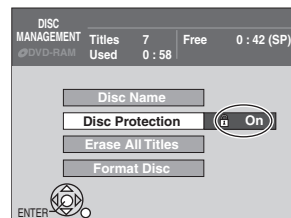
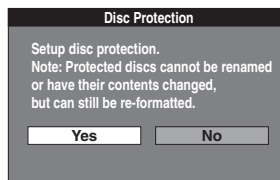

- To release protection

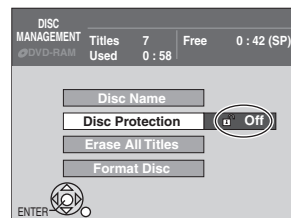
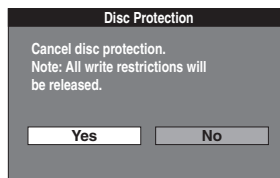

■ Protection of cartridge disc

You can protect the contents of your discs.

- With the write-protect tab in the protect position, you cannot record to, edit, or erase from the disc.

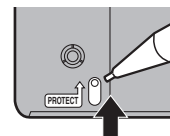

▶ Erase All Titles

RAM

- Follow steps 1 to 3 of “DISC MANAGEMENT”.

Once erased, the recorded contents are lost and cannot be restored. Make certain before proceeding.

4 Select “Erase All Titles” with [▲, ▼] and press [ENTER].

5 Select “Yes” with [◀] and press [ENTER].

6 Select “Start” with [◀] and press [ENTER].

- A message appears when finished.

7 Press [ENTER].

Note

- Erasing all video titles will result in all playlists also being erased.
- Erase does not work if one or more titles are protected.

▶ Format Disc

RAM -RW(V) -RW(VR)

- Follow steps 1 to 3 of "DISC MANAGEMENT".

Formatting erases all contents (including computer data), and they cannot be restored. Check carefully before proceeding.
The contents are erased when you format a disc even if you have set protection.

4 Select "Format Disc" with [▲, ▼] and press [ENTER].

5 Select "Yes" with [◀] and press [ENTER].

e.g., DVD-RAM

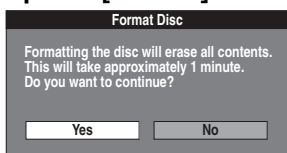

6 Select "Start" with [◀] and press [ENTER].

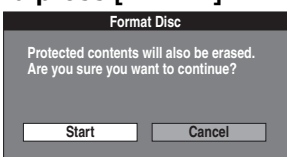

- Formatting starts.
- A message appears when formatting is finished.

Note

- Formatting normally takes a few minutes; however it may take up to a maximum of 70 minutes. **(RAM)**
- **Do not disconnect the AC power supply cord while formatting.** This can render the disc unusable.

7 Press [ENTER].

To stop formatting **RAM**

Press [RETURN].

- You can cancel formatting if it takes more than 2 minutes. The disc must be reformatted if you do this.

Note

- When a disc has been formatted using this unit, it may not be possible to use it on any other equipment.
- DVD-R, +R and CD-R/RW cannot be formatted.
- You can format DVD-RW only as DVD-Video format on this unit.
- The disc cannot be formatted if the write protect tab (→ 30) is switched to "PROTECT". Release the protection to continue.
- The message "**Unable to format**" appears when trying to format discs the unit cannot use.

▶ Playback will start with:

-R -RW(V) +R

- Follow steps 1 to 3 of "DISC MANAGEMENT".

Select whether to show the top menu after finalizing the disc. Do this before finalizing the disc.

4 Select "Playback will start with:" with [▲, ▼] and press [ENTER].

5 Use [▲, ▼] to select a desired item and press [ENTER].

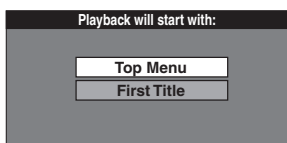

- Top Menu: The top menu appears first.
- First Title: The disc content is played without displaying the top menu.

▶ Finalize

-R -RW(V) +R

- Follow steps 1 to 3 of "DISC MANAGEMENT".
- Make selection from "Playback will start with:" before finalizing the disc. (→ below left)

You can play DVD-R, DVD-RW (DVD-Video format) or +R on compatible DVD players by finalizing it on the unit, effectively making it into DVD-Video that complies with DVD-Video standards.

The menu you create with the unit can also be used on DVD players.

4 Select "Finalize" with [▲, ▼] and press [ENTER].

5 Select "Yes" with [◀] and press [ENTER].

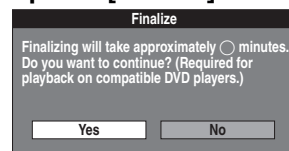

6 Select "Start" with [◀] and press [ENTER].

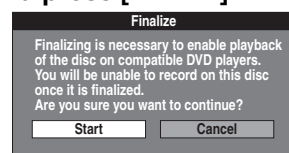

- Finalizing starts.
 - You cannot cancel finalizing.
 - A message appears when finalizing is finished.
- Note**
- Finalizing takes about 15 minutes.
 - **Do not disconnect the AC power supply cord while finalizing.** This can render the disc unusable.

7 Press [ENTER].

Note

- You can only finalize DVD-R, DVD-RW (DVD-Video format) or +R that were recorded on the unit.
- When finalizing a high-speed recording compatible disc, it may take longer than displayed on the confirmation screen (approximately 4 times).
- After finalizing
 - The disc becomes play-only and you can no longer record or edit it. **-R +R**
 - You can record and edit the disc after formatting (→ left) although it becomes play-only after finalizing. **-RW(V)**
 - DVD-R, DVD-RW (DVD-Video format) or +R finalized on the unit may not be playable on other players depending on the condition of the recording.
 - There is a pause of several seconds between titles during play.
 - Titles are divided into about 5-minute chapters*.
 - * This time varies greatly depending on the condition and mode of recording.

- Visit Panasonic's homepage for more information about DVDs.

For U.S.A.: <http://www.panasonic.com/playDVD-R>
For Canada: <http://www.panasonic.ca>

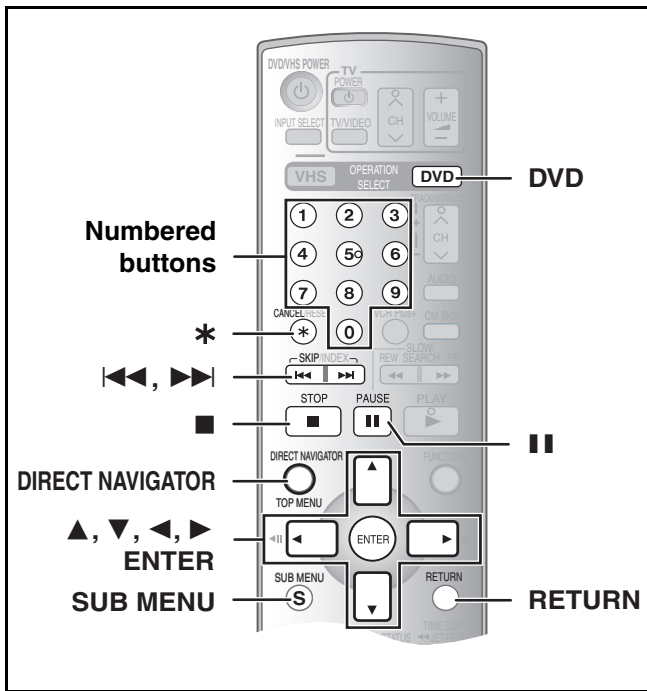

2 Use [▲, ▼, ◀, ▶] to select the character you want to enter and press [ENTER].

Repeat this step to enter other characters.

•To erase a character

You can move back one space by pressing [■, PAUSE].

- You can also erase the characters by pressing [◀] after you move the cursor to the Name field by pressing [▲, ▼].

•Using the numbered buttons to enter characters

e.g., entering the letter "R".

(1) Press [7] to move to the 7th row.

(2) Press [7] twice to highlight "R".

(3) Press [ENTER].

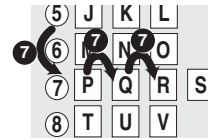

•To enter space

Press [CANCEL/RESET, *] and press [ENTER].

3 After you have finished naming

Press [■, STOP].

The title is entered and the screen disappears.

■To cancel in the middle

Press [RETURN].

•Characters will not be saved.

For your reference

If you enter a long name, only part of it is shown in the TOP MENU after finalization (→ 31). When entering a title name, the name that will appear in the TOP MENU can be previewed in "Top Menu Preview (Finalized Disc)" window. **-R -RW(V) +R**

Entering text

RAM -R -RW(V) +R

You can give names to recorded titles, etc.

The maximum number of characters:

RAM	Characters
•Title	64
•Title (scheduled recording)	44
•Disc	64

-R -RW(V) +R	Characters
•Title	44
•Disc	40

Note

•If a name is long, part of it may not be shown in some screens.

Preparation

- Insert a recorded disc.
- Release protection (Disc → 30, title → 34, cartridge → 30). **RAM**
- Press [DVD].

1 Show Enter Name screen.

Refer to the following pages regarding display of the Enter Name Screen.

- Title (→ 34)
- Title (scheduled recording) (→ 28, 29)
- Disc (→ 30)

Name field: shows the text you have entered

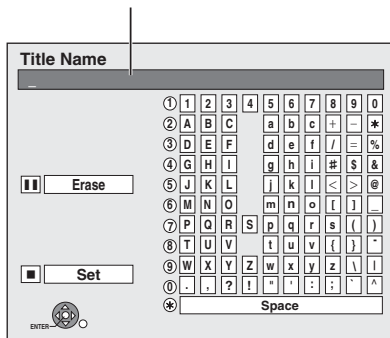

Using the Direct Navigator

RAM -R -RW(V) +R -RW(VR)

Press [DIRECT NAVIGATOR] and the list of titles recorded (Title View) is shown. You can play and edit a desired title.

For your reference

- You cannot edit during recording or transferring (dubbing), etc.
- The maximum number of items on a disc:
 - Title: 99 (+R) 49 titles
 - Chapter: Approximately 1000 (+R) Approximately 254 (Depends on the state of recording.)

■ Selecting recorded titles to play

Preparation

- Insert a disc that has been recorded on.
- Press [DVD].

1 Press [DIRECT NAVIGATOR].

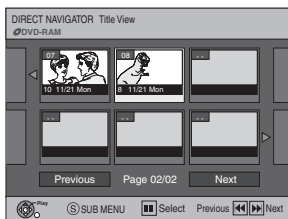

2 Use [▲, ▼, ◀, ▶] to select the title you want to watch and press [ENTER].

- Play starts.
- You can also select titles by entering a 2-digit number with the numbered buttons.
 - e.g.: "5": [0]→[5]
 - "15": [1]→[5]
- If you enter a number larger than the total number of titles, the last title is selected.
- "To show other pages" → lower right

■ To clear the title list

Press [RETURN].

For your reference

- Direct Navigator screen icons
 - 🔒 : Title protected
 - x: Unable to play
 - : Currently recording
 - 📅: Title with "One time only recording" restriction (→ 58, CPRM)

■ Editing titles with SUB MENU button

Note

- Once erased, divided or shortened, the title cannot be restored to its original state. Make certain before proceeding.

Preparation

- Release protection (disc → 30, cartridge → 30). **RAM**
- Press [DVD].

1 Press [DIRECT NAVIGATOR].

2 Use [▲, ▼, ◀, ▶] to select a desired title.

- "To show other pages", → below

3 Press [SUB MENU].

4 Use [▲, ▼] to select a desired item and press [ENTER].

- After this operation, follow the desired operation.

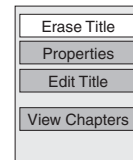

■ To stop in the middle

Press [RETURN].

For your reference

- When the title is protected (→ 34), some items are not accessible. Release the protection to access the inaccessible items. **RAM**

▶ Erase Title

RAM -R -RW(V) +R (Multiple editing is possible. → below)

- Follow steps 1 to 3 of "Editing titles with SUB MENU button".

Once title is erased using this procedure, it cannot be retrieved.

Check the title carefully before erasing to ensure it isn't one you want to keep.

4 Select "Erase Title" with [▲, ▼] and press [ENTER].

e.g.: DVD-RAM

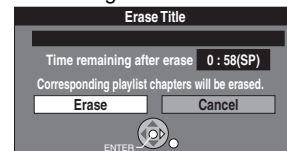

5 Select "Erase" with [◀] and press [ENTER].

For your reference

- The disc's available recording time may not increase after erasing short titles.
- The available recording space on DVD-R or +R does not increase when you erase titles.
- Available recording space on a DVD-RW (DVD-Video format) increases only when the last recorded title is erased. It does not increase if other titles are erased.

▶ Properties

RAM -R -RW(V) +R -RW(VR)

- Follow steps 1 to 3 of "Editing titles with SUB MENU button".

Title information (e.g., date and time) is shown.

4 Select "Properties" with [▲, ▼] and press [ENTER].



Various operations

■ To show other pages

Press [▲, ▼, ◀, ▶] to select "Previous" or "Next" and press [ENTER].

- You can also press [◀◀, SKIP] or [▶▶, SKIP] to show other pages.

■ Multiple editing

Select with [▲, ▼, ◀, ▶] and press [■, PAUSE]. (Repeat) A check mark appears. Press [■, PAUSE] again to cancel.

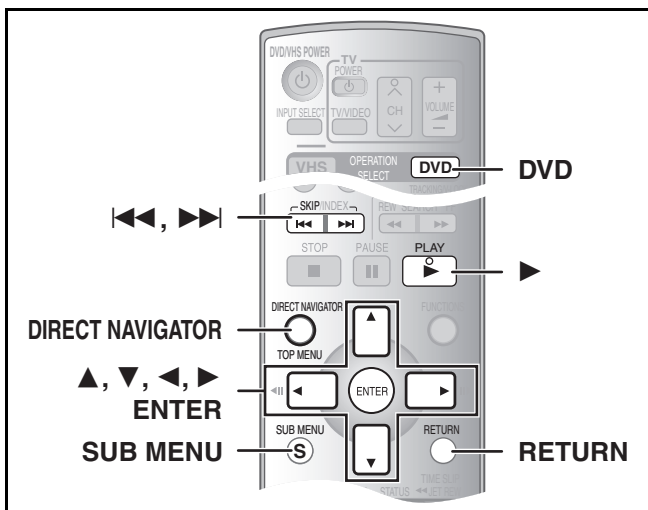

▶▶ Edit Title

RAM -R -RW(V) +R

You can perform various kinds of title editing.

Preparation

- Release protection (disc → 30, cartridge → 30). **RAM**
- Press [DVD].

- 1 Press [DIRECT NAVIGATOR] and use [▲, ▼, ◀, ▶] to select a desired title.
 - “To show other pages” → 33
 - “Multiple editing” → 33

- 2 Press [SUB MENU].

e.g.: DVD-RAM

- 3 Select “Edit Title” with [▲, ▼] and press [ENTER].

- 4 Use [▲, ▼] to select a desired item and press [ENTER].

- The editing screen for the selected item appears.

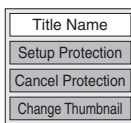

■ To return to the previous screen

Press [RETURN].

■ To exit the screen

Press [RETURN] several times.

▶▶ Title Name

RAM -R -RW(V) +R

- Follow steps 1 to 3 of “Edit Title”.

- 4 Select “Title Name” with [▲, ▼] and press [ENTER].

Refer to “Entering text”. (→ 32)

▶▶ Setup Protection/Cancel Protection

RAM (Multiple editing → 33)

- Follow steps 1 to 3 of “Edit Title”.

You can prevent accidental erasure of titles by setting and canceling the write-protection.

- 4 Select “Setup Protection” or “Cancel Protection” with [▲, ▼] and press [ENTER].

- 5 Select “Yes” with [◀] and press [ENTER].

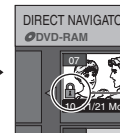

Set up Protection:
The padlock mark appears.

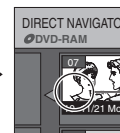
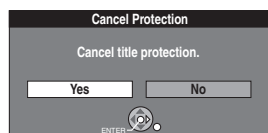

Cancel Protection:
The padlock mark disappears.

For your reference

Titles will be erased even if they are protected if you format the disc with DISC MANAGEMENT (→ 31).

▶▶ Change Thumbnail

RAM -R -RW(V) +R

- Follow steps 1 to 3 of “Edit Title”.

You can change the image to be shown as a thumbnail picture in the Title View.

- 4 Select “Change Thumbnail” with [▲, ▼] and press [ENTER].

- 5 Press [▶, PLAY] to play.

- 6 Press [ENTER] at the point you want to display.

(→ 35, “For quicker editing”)

- To change to another point in the same title:

- Select “Change” with [▲, ▼] and press [▶, PLAY] and then repeat step 6.

- 7 Select “Exit” with [▲, ▼] and press [ENTER].

- The thumbnail picture will be changed at this point.

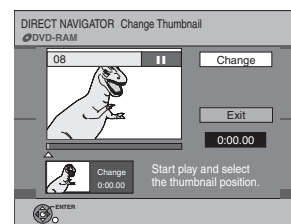

▶ View Chapters

RAM **-R** **-RW(V)** **+R** **-RW(VR)**

- 1 Press [DIRECT NAVIGATOR] and use [▲, ▼, ◀, ▶] to select a desired title.
 - “To show other pages” → 33
- 2 Press [SUB MENU].
- 3 Select “View Chapters” with [▲, ▼] e.g.: DVD-RAM and press [ENTER].
- 4 Select a desired chapter with [▲, ▼, ◀, ▶].
 - To start play → Press [ENTER].
 - To edit → Follow the steps below.
- 5 Press [SUB MENU].
- 6 Select a desired item with [▲, ▼] and press [ENTER].

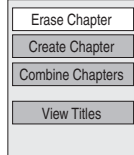

Title/Chapter
Programs are recorded as a single title consisting of one chapter.

Title

Chapter

Start End

↓

You can divide a title into multiple chapters. **RAM**
(→ 21, “Create chapters”, → right “Create Chapter”)

Title

•Titles are divided into chapters about 5 minutes after finalizing (→ 31). **-R** **-RW(V)** **+R**

▶▶ Erase Chapter

RAM (Multiple editing → 33)

- Follow steps 1 to 5 of “View Chapters”.
- Once erased, the recorded contents are lost and cannot be restored.** Make certain before proceeding.
- When you erase a chapter, the title may also be erased.
- 6 Select “Erase Chapter” with [▲, ▼] and press [ENTER].
 - 7 Select “Erase” with [◀] and press [ENTER].

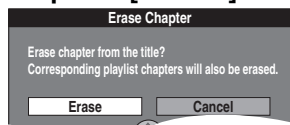

▶▶ Create Chapter

RAM

- Follow steps 1 to 5 of “View Chapters”.
- 6 Select “Create Chapter” with [▲, ▼] and press [ENTER].
 - 7 Press [ENTER] at the point you want to divide. (→ below, “For quicker editing”)
 - Repeat this step to divide at other points.

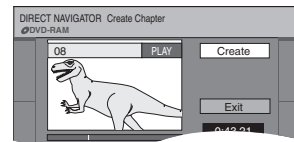

- 8 Select “Exit” with [▼] and press [ENTER].

Note

- A short portion of the recording just after the creation point may be lost.

For your reference

- It is not possible to carry out “Create” when the resulting part(s) are extremely short.

▶▶ Combine Chapters

RAM

- Follow steps 1 to 5 of “View Chapters”.
- 6 Select “Combine Chapters” with [▲, ▼] and press [ENTER].
 - 7 Select “Combine” with [◀] and press [ENTER].
 - The selected chapter and next chapter are combined.

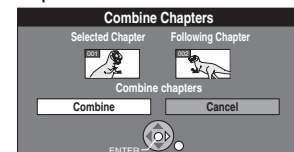

▶▶ View Titles

RAM **-R** **-RW(V)** **+R** **-RW(VR)**

- Follow steps 1 to 5 of “View Chapters”.
- 6 Select “View Titles” with [▲, ▼] and press [ENTER].

You go back to Title View.

For quicker editing

- Use search (→ 20), Time Slip (→ 21) or slow-motion (→ 20) to find the desired point.
- Press [◀◀, SKIP] or [▶▶, SKIP] to skip to the beginning or end of a title.

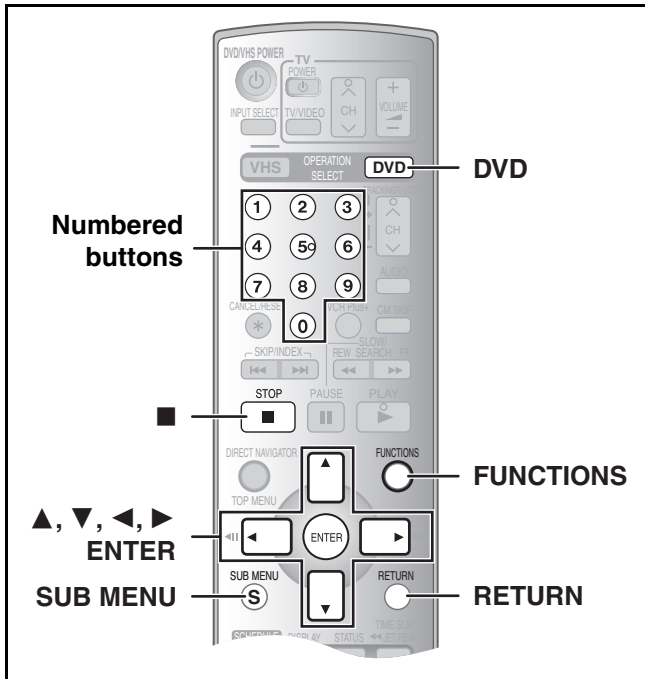

■ To exit the screen

Press [RETURN] several times.

For your reference

- You can use fast-forward, fast-rewind, pause, and slow-motion while playing chapters just as you can during normal play.

Playing playlists

RAM **-RW(VR)** (Play only)

Note

- You cannot create or edit playlists on this unit. However, you can play a playlist that has been created or edited on a different equipment.

Preparation

- Release protection (disc → 30, cartridge → 30). **RAM**
- Press [DVD].

1 While stopped
Press [FUNCTIONS].

2 Select “Other Functions” with [▲, ▼] and press [ENTER].

3 Select “PLAYLISTS” with [▲, ▼] and press [ENTER].

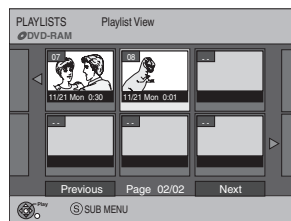

4 Use [▲, ▼, ◀, ▶] to select a playlist and press [ENTER].

- Chapters are not displayed if you have not yet created a playlist with the disc.
- You can also select a playlist from the Playlist View by entering a 2-digit number with the numbered buttons.
e.g.: “5”: [0]→[5]
“15”: [1]→[5]
- If you enter a number larger than the total number of playlists, the last playlist is selected.
- “To show other pages” → 33

■ To stop playlist play

Press [■, STOP]. (The Playlist View screen appears.)

■ To return to the previous screen

Press [RETURN].

Other functions for playlists

RAM -RW(VR) (Properties only)

Preparation

- Press [DVD].

- 1 While stopped
Press [FUNCTIONS].
- 2 Select “Other Functions” with [▲, ▼] and press [ENTER].
- 3 Select “PLAYLISTS” with [▲, ▼] and press [ENTER].
- 4 Use [▲, ▼, ◀, ▶] to select a playlist.
• “To show other pages” → 33
- 5 Press [SUB MENU].
- 6 Use [▲, ▼] to select a desired item and press [ENTER].

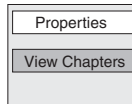

To return to the previous screen

Press [RETURN].

To exit the screen

Press [RETURN] several times.

Properties

RAM -RW(VR)

- Follow steps 1 to 5 of “Other functions for playlists”.

- 6 Select “Properties” with [▲, ▼] and press [ENTER].

Playlist information (e.g., date and length) is shown.

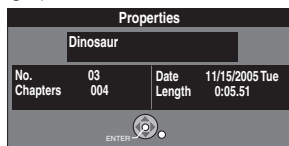

View Chapters

RAM -RW(VR) (Play only)

- Follow steps 1 to 5 of “Other functions for playlists”.

You can play the chapters in a playlist.

- 6 Select “View Chapters” with [▲, ▼] and press [ENTER].

- 7 Use [▲, ▼, ◀, ▶] to select a desired chapter.

- You can also select a chapter from the chapter view by entering a 3-digit number with the numbered buttons.
e.g.: “5”: [0]→[0]→[5]
“15”: [0]→[1]→[5]
- If you enter a number larger than the total number of chapters, the last chapter is selected.
- “To show other pages” → 33

Back to Playlist View

- 8 Press [SUB MENU] and then press [ENTER].



To stop chapter play

Press [■, STOP]. (The Chapter View screen appears.)

Using DISPLAY menus

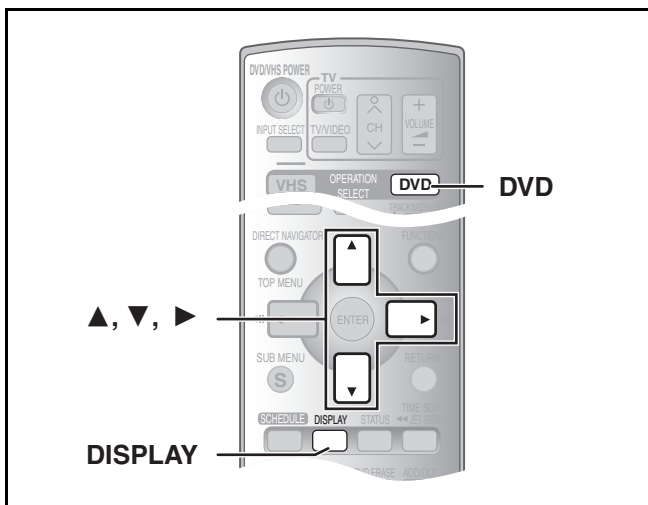

RAM -R -RW(V) +R DVD-V -RW(VR) VCD CD

Common procedures

Preparation

- Press [DVD].

1 Press [DISPLAY].

Disc	Soundtrack	1*	Digital 2/0ch
Play	Subtitle	Off	
Video	Audio channel	Stereo	
Audio			
Other			
	Menu	Item	Setting

2 Select a menu with [▲, ▼] and press [▶].

3 Select an item with [▲, ▼] and press [▶].

4 Select a setting with [▲, ▼].

- Different operations are required depending on settings. Follow the on-screen instructions.

To exit the screen

Press [DISPLAY].

For your reference

- The screens depend on the disc contents.
- Depending on the condition of the unit (playing, stopped, etc.) and the type of software you are playing, there are some items that you cannot select or change.

Disc menu

RAM -R -RW(V) +R DVD-V -RW(VR) VCD

Disc	Soundtrack	1*	Digital 2/0ch
Play	Subtitle	Off	
Video	Audio channel	Stereo	
Audio			
Other			

Soundtrack

RAM -R -RW(V) +R -RW(VR)

The disc's audio attributes appear.

DVD-V

Select the audio and language. (See [B] Audio attributes)

Subtitle

DVD-V

Turn the subtitle on/off and select the language (See [A] Sound track/Subtitle language)

RAM -R -RW(V) +R -RW(VR) (Only discs that contain subtitle on/off information)

Turn the subtitle on/off.

- Subtitle on/off information cannot be recorded using this unit.
- If the subtitles overlap the closed captions recorded on discs, turn the subtitles off.

Audio channel RAM -RW(VR) VCD

→ 21, Changing audio during play

Angle DVD-V

Change the number to select an angle.

PBC (Playback control) VCD (→ 58)

Indicates whether menu play (playback control) is on or off.

[A] Sound track/Subtitle language

ENG: English	SVE: Swedish	CHI: Chinese
FRA: French	NOR: Norwegian	KOR: Korean
DEU: German	DAN: Danish	MAL: Malay
ITA: Italian	POR: Portuguese	VIE: Vietnamese
ESP: Spanish	RUS: Russian	THA: Thai
NLD: Dutch	JPN: Japanese	*: Others

[B] Audio attributes

LPCM/PPCM/Digital/DTS/MPEG: Signal type
 k (kHz): Sampling frequency
 b (bit): Number of bits
 ch (channel): Number of channels

For your reference

- The display changes according to the disc content. You cannot make a change when there is no recording.
- Some discs allow changes to sound tracks, subtitles, and angles only by using the disc's setup menus. (→ 20)

▶ Play menu

RAM -R -RW(V) +R DVD-V -RW(VR) VCD CD

Disc	Repeat play	Off
Play		
Video		
Audio		
Other		

Repeat play

This function works only when the elapsed play time is displayed.
Select the item for repeat play. Depending on the disc, the items that can be selected will differ.

RAM -R -RW(V) +R -RW(VR)

Title↔Off

DVD-V

Title↔Chapter↔Off

VCD CD (except MP3 discs)

Track↔All↔Off

CD (MP3 discs only)

Track↔Group↔Off

While playing a playlist

RAM

Playlists↔Off

▶ Video menu

RAM -R -RW(V) +R DVD-V -RW(VR) VCD

Disc	Picture	Normal
Play	MPEG-DNR	On
Video	Progressive	On
Audio	Transfer	Auto 1
Other	Line-in NR	Off

Picture

To select the picture mode during play
Normal: Default setting
Cinema: Mellows movies, enhances detail in dark scenes.

MPEG-DNR

Reduces noise and picture degradation.
On↔Off

*Progressive (→ 58)

Select "On" to enable progressive output.
• Select "Off" if the picture is stretched horizontally.
• When progressive output is on, closed captions cannot be displayed.
On↔Off

*Transfer (When "Progressive" is set to "On")

Select the method of conversion for progressive output to suit the type of material being played (→ 58, Film and Video).

Auto1 (normal):

Detects 24 frame-per-second film content and appropriately converts it.

Auto2: Select when the video content is distorted by using Auto1.

Line-in NR (Only when IN1 or IN2 is selected)

Reduces video tape noise during transfer (dub).
Depending on the software, jittering may occur.
Off: Noise reduction is off. Select when you want to record input as is.
On: Noise reduction works for any video input.

* Only when you have selected "480p" in "TV Type" (→ 19).

▶ Audio menu

RAM -R -RW(V) +R DVD-V -RW(VR)

Disc	V.S.S.	Off
Play	Dialog Enhancer	Off
Video		
Audio		
Other		

V.S.S.

RAM -R -RW(V) +R DVD-V -RW(VR)

(Only for Dolby Digital with 2.0 or more channels)
Enjoy a surround-sound effect if you are using 2 front speakers (L/R) only.
Natural↔Emphasis↔Off

Note

- Turn V.S.S. off if it causes distortion.
- Turn V.S.S. off for SAP recordings.

Dialog Enhancer

RAM -R -RW(V) +R DVD-V -RW(VR)

(Dolby Digital, 3-channel or over only, including a center channel)
The volume of the center channel is raised to make dialog easier to hear.
On↔Off

▶ Other menu

Disc		
Play		
Video		
Audio		
Other	Position	1

Position

To change the display position
1 (Standard) –5:
The higher the setting the lower the screen moves.

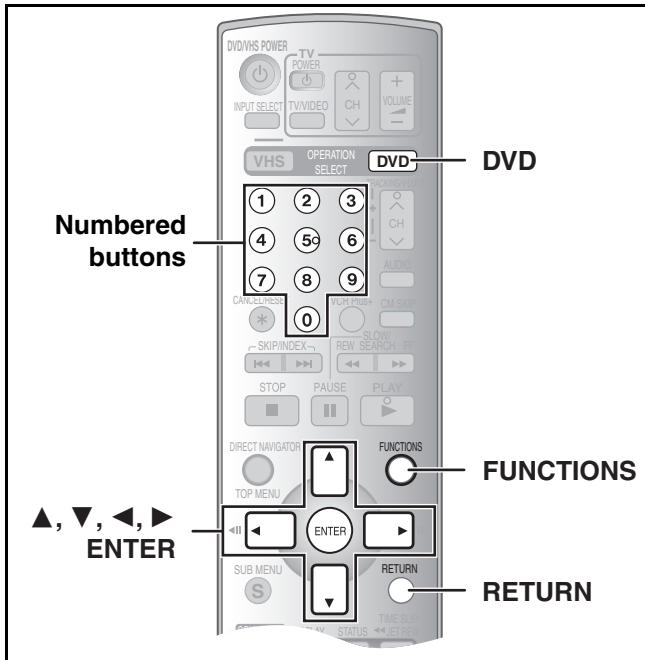

Entering a password (Ratings)

You can limit play of DVDs unsuitable for some audiences (children, for example). Play and changes to the settings are not possible unless you enter a password. (→ 41)

Preparation

- Press [DVD].

When setting ratings

The password screen is shown when you select levels 0 to 7.

1 Input a 4-digit password with the numbered buttons.

- If you enter a wrong number, press [◀] to erase it before you press [ENTER].

- Do not forget your password.

2 Press [ENTER].

3 Press [ENTER].

The password is entered and the unit is locked.

Now, when you insert a DVD-Video that exceeds the ratings limit you set, a message appears on the TV.

Follow the on-screen instructions.

When changing ratings

The password screen is shown when you select "Ratings". (→ 41)

1 Input a 4-digit password with the numbered buttons and press [ENTER].

- Unlock Recorder:** To unlock the unit and return the rating to 8
- Change Password:** To change your password
- Change Level:** To change the rating level
- Temporary Unlock:** To temporarily unlock the unit (the unit locks again if you switch it to standby or open the disc tray)

2 Select a desired item with [▲, ▼] and press [ENTER].

Actual screens depend on the operation. Follow the on-screen instructions.

Changing the unit's settings

Use the following procedure to change the settings if necessary.

1 While stopped Press [FUNCTIONS].

2 Select "Other Functions" with [▲, ▼] and press [ENTER].

3 Select "SETUP" with [▲, ▼] and press [ENTER].

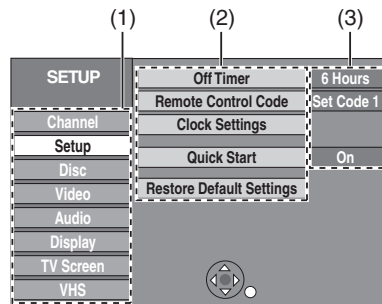
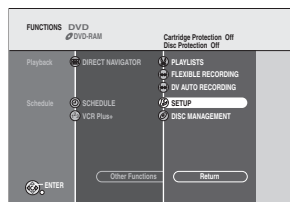

- (1) Menus
- (2) Items
- (3) Options

4 Select a menu with [▲, ▼] and press [◀, ▶].

5 Select an item to be changed with [▲, ▼] and press [ENTER].

6 Select an option with [▲, ▼] and press [ENTER].

- Some options require different operations. Follow the displayed instructions.

■ To return to the previous screen

Press [RETURN]. Even if you have changed an option, the change is not activated until you press [ENTER].

■ To exit the screen

Press [RETURN] several times.

For your reference

- The settings remain intact even if you switch the unit to standby.

Summary of settings

This description shows the initial settings for the unit. For details on menu operation. (→ 40)

- Underlined items are the factory default settings.
- / indicates settings effective for both DVD and VHS.
- indicates settings effective for DVD only.

■ Channel /

Signal Source (RF IN) (→ 16)

Select to suit the type of antenna you are using.
[Antenna] [CableTV]

Set Channels Automatically (→ 16)

Preset Channel Captions (→ 17)

Manual Channel Captions (→ 17)

VCR Plus+ Ch. Setting (→ 16)

■ Setup /

Off Timer

Select how long the unit remains on when it is not being used.
[2 Hours] [6 Hours] [Off]

Remote Control Code (→ 18)

[Set Code 1] [Set Code 2] [Set Code 3]

Clock Settings

Press [ENTER] to show the following settings.

Set Clock Automatically (→ 44)

Set Clock Manually (→ 44)

Adjust Time Zone (→ 44)

This corrects the time set in Auto Clock Setting.
The status is not displayed on the Set Up menu when the Auto Clock Setting is not set.
[-1] [0] [+1]

Quick Start

About 1 second after turning on the unit, you can start recording to DVD-RAM.
Power consumption in standby mode increases when Quick Start is set to "On". The unit performs self maintenance for a few minutes every morning starting at 4:00 am. The unit's buttons, including [POWER /I], do not work during this self maintenance. (Self maintenance does not start if the unit is on, or a scheduled recording is taking place, at this time.)
[On] [Off]

Restore Default Settings

This returns SETUP menus to default settings, except for the clock, channel settings, ratings level, and on-screen language.
[Yes] [No]

■ Disc

Settings for Playback

Press [ENTER] to show the following settings.

Ratings (→ 40)

Set a ratings level to limit DVD-Video play.

Setting ratings (When level 8 is selected)

[8 No Limit]: All DVD-Video can be played.
[1] to [7]: Prohibits play of DVD-Video with corresponding ratings recorded on them.
[0 Lock All]: Prohibits play of all DVD-Video.

Changing ratings (When level 0 to 7 is selected)

[Unlock Recorder] [Change Password]
[Change Level] [Temporary Unlock]

Audio Language

[English] [French] [Spanish] [Original] [Other *****]

Subtitle Language

[Automatic] [English] [French] [Spanish] [Other *****]

Menu Language

[English] [French] [Spanish] [Other *****]

Choose the language for audio, subtitles and disc menus. **DVD-V**

- If a language which is not recorded is selected, or if languages are already fixed on the disc, the language set as the default on the disc will be played instead.

Original

The original language of each disc will be selected.

Other *****

This is the language code setting.
Input a code number with the numbered buttons. (→ 43, "Language code list")

Automatic

If the language selected for "Audio Language" is not available, subtitles of that language will automatically appear if available on the disc.

Settings for Recording

Press [ENTER] to show the following settings.

Recording Time in EP Mode

Select the maximum number of hours for recording in EP mode (→ 24, "Recording modes and approximate recording times").
[EP-Extended Play (6H)] [EP-Extended Play (8H)]

EP-Extended Play (6H)	You can record for 6 hours on an unused 4.7 GB disc.
EP-Extended Play (8H)	You can record for 8 hours on an unused 4.7 GB disc.

- Underlined items are the factory default settings.

■ Video

Still Mode

When "On" is selected for "Progressive" (→ 39), the setting for "Still Mode" is not effective.

Select the type of picture shown when you pause play. (→ 58, "Frame and field")

[Automatic] [Field] [Frame]

Field	Select if jittering occurs when "Automatic" is selected.
Frame	Select if you cannot see small text or fine patterns clearly when "Automatic" is selected.

Black Level Control

Select "Normal", "Lighter" or "Darker" to adjust the black level control to the desired setting for picture enhancement.

Press [ENTER] to show the following settings.

Input Level

Adjusts the black level of the input signal.

[Lighter] [Darker]

Output Level (Composite/SVideo)

Adjusts the black level of the output signal from the VIDEO OUT and S-VIDEO OUT terminal.

[Lighter] [Darker]

Output Level (Component)

Adjusts the black level of the output signal from the COMPONENT VIDEO OUT (Y/Pb/Pr) terminals.

[Lighter] [Normal] [Darker]

■ Audio

Dynamic Range Compression

DVD-V (Dolby Digital only)

Change the dynamic range (→ 58) for easier listening in low volume.

[On] [Off]

Select MTS

Select whether to record the main or secondary audio type (SAP) when recording or transferring (dubbing) to DVD-R, DVD-RW (DVD-Video format) or +R. (You cannot select the audio type on the unit when recording audio to DVD-R, DVD-RW (DVD-Video format) or +R from an external device. Select it on the external device.)

[Main] [Secondary Audio Program (SAP)]

Digital Audio Output

Change the settings when you have connected equipment through the unit's DIGITAL AUDIO OUT terminal (→ 14).

Press [ENTER] to display the menu.

PCM Down Conversion

Select how to output audio with a sampling frequency of 96 kHz or 88.2 kHz.

- Signals are converted to 48 kHz or 44.1 kHz despite the above settings if the signals have a sampling frequency of over 96 kHz or 88.2 kHz, or the disc has copy protection.

[On] [Off]

On	Signals are converted to 48 kHz or 44.1 kHz. (Choose when the connected equipment cannot process signals with sampling frequency of 96 kHz or 88.2 kHz.)
Off	Signals are output as 96 kHz or 88.2 kHz. (Choose when the connected equipment can process signals with sampling frequency of 96 kHz or 88.2 kHz.)

Dolby Digital

Choose whether to output by "Bitstream" which processes Dolby Digital signals on other connected equipment or to convert the signals to "PCM (2ch)" on the unit before output.

[Bitstream] [PCM]

Bitstream	When you have connected the unit to a piece of equipment having Dolby Digital logo.
PCM	When you have connected the unit to a piece of equipment that doesn't have Dolby Digital logo*.

DTS

Choose whether to output by "Bitstream" which processes DTS signals on other connected equipment or to convert the signals to "PCM (2ch)" on the unit before output.

[Bitstream] [PCM]

Bitstream	When you have connected the unit to a piece of equipment having DTS logo.
PCM	When you have connected the unit to a piece of equipment that doesn't have DTS logo*.

- * Incorrect settings can cause noise to be output which can be harmful to your ears and speakers, and audio will not be recorded properly on media such as mini discs.

Select Audio Channel For DV Input

Select the kind of sound when recording from the unit's DV terminal.

[Stereo 1] [Stereo 2] [Mix]

Stereo 1	Records sound (L1, R1) when DV recording is taking place.
Stereo 2	Records added sound such as narration (L2, R2) subsequent to original recording.
Mix	Records both Stereo 1 and Stereo 2. • When recording MTS broadcast, select the type of audio in advance from "Select MTS" (→above)

Convenient functions



• Underlined items are the factory default settings.

■ Display /

Status Messages

Choose whether to show status messages automatically or not.

[Automatic] [Off]

On-screen Language

Choose the language for these menus and the on-screen messages.

[English] [Español] [Français]

Blue Background

Select whether to show the blue background, normally shown when TV reception is poor.

[On] [Off]

Front Display

Changes the brightness of the unit's display.

[Bright] [Dim] [Automatic]

Automatic	The display turns dark during play, and reappears momentarily if a button is pressed. When the unit is turned off, the unit's display disappears. While using this mode the standby power consumption can be reduced.
------------------	---

■ TV Screen

TV Type (→ 19)

Choose the setting to suit your TV and preference.

[Aspect 4:3 & 480i] [Aspect 4:3 & 480p]

[Aspect 16:9 & 480i] [Aspect 16:9 & 480p]

4:3 TV Settings for DVD-Video

You can select how to display the image on the TV when you watch 16:9 images (DVD-Video) on a 4:3 standard aspect TV. (→ 58)

[Pan and Scan (Stretch to fit)] [Letterbox (Shrink to fit)]

Pan and Scan (Stretch to fit) 	Video recorded for a widescreen is played with the sides cut off if Pan & Scan was specified. If 16:9 software prohibits Pan & Scan, the image will appear in the letterbox style (with black bands above and below the picture) despite the setting here.
Letterbox (Shrink to fit) 	Video recorded for a widescreen is played in the letterbox style.

4:3 TV Settings for DVD-RAM

You can select how to display the image on the TV when you watch 16:9 images (DVD-RAM) on a 4:3 standard aspect TV. (→ 58)

[4:3] [Pan and Scan (Stretch to fit)] [Letterbox (Shrink to fit)]

4:3	Titles are played as recorded.
Pan and Scan (Stretch to fit)	Video recorded for a widescreen is played with the sides cut off.
Letterbox (Shrink to fit)	Video recorded for a widescreen is played in the letterbox style.

■ VHS (→ 52)

TAPE SELECT

JET SEARCH

Language code list							
Abkhazian: 6566	Chinese: 9072	Hausa: 7265	Lithuanian: 7684	Romanian: 8279	Telugu: 8469		
Afar: 6565	Corsican: 6779	Hebrew: 7387	Macedonian: 7775	Russian: 8285	Thai: 8472		
Afrikaans: 6570	Croatian: 7282	Hindi: 7273	Malagasy: 7771	Samoan: 8377	Tibetan: 6679		
Albanian: 8381	Czech: 6783	Hungarian: 7285	Malay: 7783	Sanskrit: 8365	Tigrinya: 8473		
Ameharic: 6577	Danish: 6865	Icelandic: 7383	Malayalam: 7776	Scots Gaelic: 7168	Tonga: 8479		
Arabic: 6582	Dutch: 7876	Indonesian: 7378	Maltese: 7784	Serbian: 8382	Turkish: 8482		
Armenian: 7289	English: 6978	Interlingua: 7365	Maori: 7773	Serbo-Croatian: 8372	Turkmen: 8475		
Assamese: 6583	Esperanto: 6979	Irish: 7165	Marathi: 7782	Shona: 8378	Twí: 8487		
Aymara: 6589	Estonian: 6984	Italian: 7384	Moldavian: 7779	Sindhi: 8368	Ukrainian: 8575		
Azerbaijani: 6590	Faroese: 7079	Japanese: 7465	Mongolian: 7778	Singhalese: 8373	Urdu: 8582		
Bashkir: 6665	Fiji: 7074	Javanese: 7487	Nauru: 7865	Slovak: 8375	Uzbek: 8590		
Basque: 6985	Finnish: 7073	Kannada: 7578	Nepali: 7869	Slovenian: 8376	Vietnamese: 8673		
Bengali, Bangla: 6678	French: 7082	Kashmiri: 7583	Norwegian: 7879	Somali: 8379	Volapük: 8679		
Bhutani: 6890	Frisian: 7089	Kazakh: 7575	Oriya: 7982	Spanish: 6983	Welsh: 6789		
Bihari: 6672	Galician: 7176	Kirghiz: 7589	Pashto, Pushto: 8083	Sundanese: 8385	Wolof: 8779		
Breton: 6682	Georgian: 7565	Korean: 7579	Persian: 7065	Swahili: 8387	Xhosa: 8872		
Bulgarian: 6671	German: 6869	Kurdish: 7585	Polish: 8076	Swedish: 8386	Yiddish: 7473		
Burmese: 7789	Greek: 6976	Laotian: 7679	Portuguese: 8084	Tagalog: 8476	Yoruba: 8979		
Byelorussian: 6669	Greenlandic: 7576	Latin: 7665	Punjabi: 8065	Tajik: 8471	Zulu: 9085		
Cambodian: 7577	Guarani: 7178	Latvian, Lettish: 7686	Quechua: 8185	Tamil: 8465			
Catalan: 6765	Gujarati: 7185	Lingala: 7678	Rhaeto-Romance: 8277	Tatar: 8484			

Convenient functions

Clock Settings

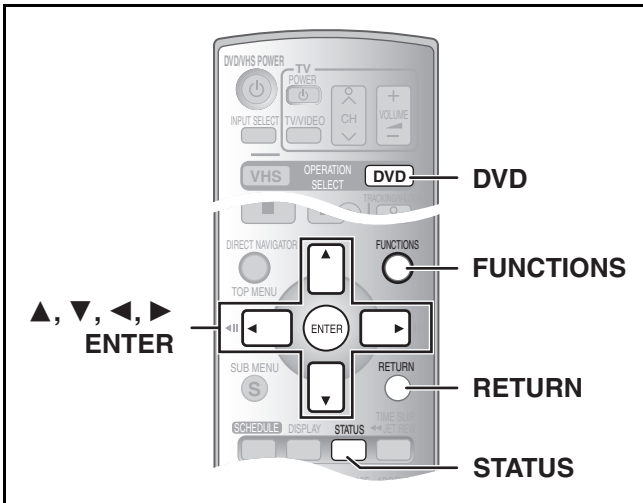

- 1 While stopped Press [FUNCTIONS].
- 2 Select "Other Functions" with [▲, ▼] and press [ENTER].
- 3 Select "SETUP" with [▲, ▼] and press [ENTER].
- 4 Select "Setup" with [▲, ▼] and press [◀, ▶].
- 5 Select "Clock Settings" with [▲, ▼] and press [ENTER].

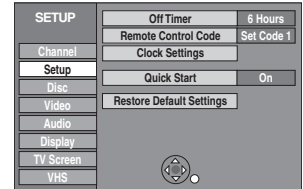
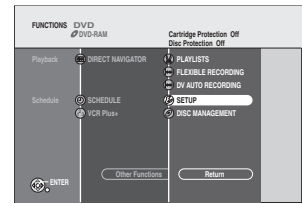

▶ Set Clock Automatically

• Follow steps 1 to 5 of "Clock Settings".

- 6 Select "Set Clock Automatically" with [▲, ▼] and press [ENTER].
- 7 Press [ENTER].
 - Auto setting starts. This can take some time, up to a few hours in some cases. The following screen appears when setting is complete.

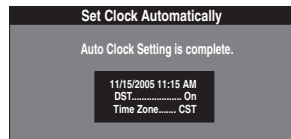

- If the time was not set correctly, use manual clock setting or time zone adjust.
- DST, (Daylight Saving Time) shows the summertime setting.
- Time Zone shows the time difference from Greenwich Mean Time (GMT).

EST (Eastern Standard Time) = GMT -5
 CST (Central Standard Time) = GMT -6
 MST (Mountain Standard Time) = GMT -7
 PST (Pacific Standard Time) = GMT -8
 AST (Alaska Standard Time) = GMT -9
 HST (Hawaii Standard Time) = GMT -10
 For other areas: xx hr

- 8 Press [ENTER].

■ To cancel in the middle
 Press [RETURN].

▶ Adjust Time Zone

• Follow steps 1 to 5 of "Clock Settings".

Adjust the time zone (-1 or +1) if it was not set correctly with auto clock setting.
 You cannot change this setting if you set the clock manually.

- 6 Select "Adjust Time Zone" with [▲, ▼] and press [ENTER].
- 7 Select "-1" or "+1" with [▲, ▼] and press [ENTER].

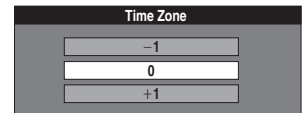

■ To return to the previous screen
 Press [RETURN].

▶ Set Clock Manually

• Follow steps 1 to 5 of "Clock Settings".

- 6 Select "Set Clock Manually" with [▲, ▼] and press [ENTER].

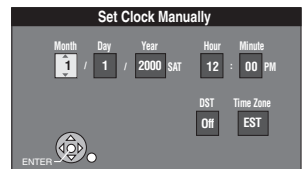

- 7 Use [◀, ▶] to select the item you want to change, and press [▲, ▼] to change the setting.
 - DST (Daylight Saving Time): On or Off
 If you select "On", the clock is advanced one hour starting at 2 a.m. on the first Sunday in April and ending at 2 a.m. on the last Sunday in October.
 - Time Zone (→ left)
- 8 Press [ENTER].
 - The clock starts.

■ To return to the previous screen
 Press [RETURN].

FUNCTIONS window

By using the FUNCTIONS window you can access the main functions quickly and easily.

Preparation

- Press [DVD].

1 While stopped

Press [FUNCTIONS].

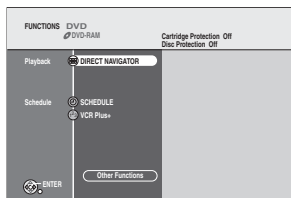

- Functions displayed depend on the type of disc.

2 Select an item with [▲, ▼] and press [ENTER].

- If you selected "Other Functions", press [▲, ▼] to select an item and press [ENTER].

■ To exit the FUNCTIONS window

Press [FUNCTIONS].

Status displays

Status messages appear on the TV when operating the unit, to show you what operation was performed and what condition the unit is in.

Press [STATUS] to change the information displayed.

The display changes each time you press the button.

For example, DVD-RAM

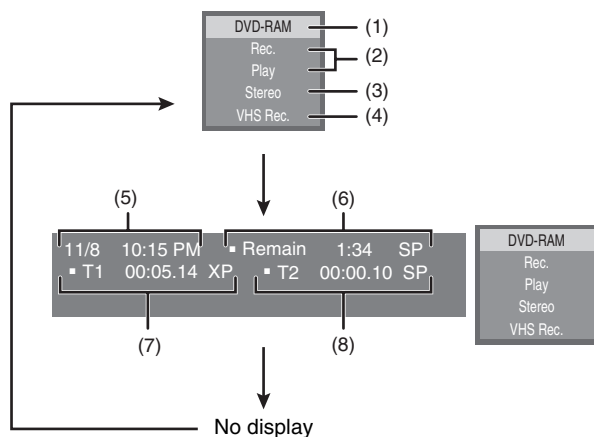

■ Display examples

(1) Current medium

(2) Current recording or play status, input channel

- Shows the current state of the unit and the input channel.

(3) Audio type (→ 21, 25)

(4) Other drive mode

(5) The current date and time

(6) Available recording time and recording mode

(e.g.: "1:34 SP" indicates 1 hours and 34 minutes in SP mode)

- Disc remaining time may slightly differ between different models.

(7) Elapsed play time

(8) Recording time

- Shows recording time, recording mode and a rough guide to how much space has been used for recording on the disc.

Inserting a video cassette

The surface on which you can see a roll of tape should face up.

Insert a video cassette.

- The unit is automatically turned on.

When the status display (→ right) appears. (→ 53)
The remaining tape time counter begins when you insert a tape. Depending on the tape, this may take up to approximately 30 seconds.

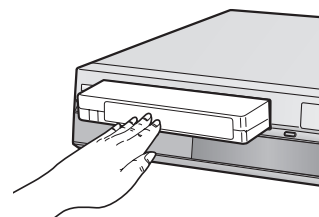

■ To eject a video cassette

- You can eject a video cassette even when the unit is in standby mode. It does not switch back to standby mode after the video cassette is ejected.

For main unit

- Press [**▲**, EJECT] on the main unit.

For remote control

- Press [VHS] and then press and hold [**■**, STOP] for about 3 or more seconds.

Video cassette information

■ Video cassettes

- Break off the video cassette's tab to prevent accidental erasure. Cover the hole with a double layer of adhesive tape when you want to use the video cassette for recording again.
- You can use video cassettes with the VHS and S-VHS marks, but the unit is unable to make full use of the characteristics of S-VHS video cassettes.

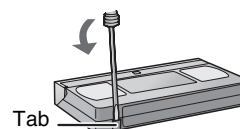

■ Video cassette care

- Poor quality or damaged video cassettes can cause the heads to become dirty and malfunction. Store your video cassettes carefully and discard them when they become dirty or damaged.
- Never use video cassettes on which juice has been spilled or those that are extremely damaged since this will not only cause the heads to become dirty, but will also make the unit malfunction.

■ Maintenance

Cleaning the video heads

Dirt on the video heads can cause poor recording and play.



If the picture does not improve, use an optional head-cleaning cassette (part number NV-TCL30PT). If the problem persists, seek advice from a qualified service person.

Playing a video cassette

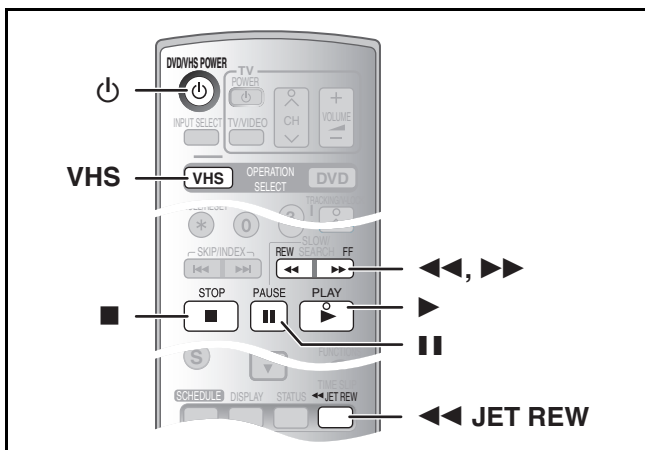

Preparation

- Select the unit viewing channel (e.g. the AV input) on the TV.
- Press [VHS].

- 1 Press [⏻, DVD/VHS POWER] to turn the unit on.
- 2 Insert a recorded video cassette. (→ 46)
- 3 Press [▶, PLAY].

- Play starts automatically if you insert a video cassette with the tab removed.

■ To pause play

Press [⏸, PAUSE]. (Press again to restart play.)

■ To stop play

Press [■, STOP].

Note

- When the tape reaches its end, the unit automatically rewinds it to the beginning. This function does not work during scheduled recording, fast-forwarding and specified stop recording.
- Jet Search, cue, review or slow playback will be automatically canceled after 10 minutes and for pause it will be canceled after 5 minutes.
- When viewing a still picture or during slow playback, the picture that appears in VP mode may be distorted.
- When playing back a tape which was recorded on another VCR, it may be necessary to adjust the tracking (→ 48). In some cases the picture quality may still be inferior. This is due to format constraints.
- When the unit starts making a scheduled recording on the DVD during VHS playback, some picture distortion may occur.
- When the TV is connected to the DVD PRIORITY output terminal on this unit and the unit starts making a recording or scheduled recording on the DVD, you cannot watch pictures played back on VHS.

Fast-forward/Rewind

While stopped

Press [◀◀] (backward)/[▶▶] (forward).

Cue/Review

During play

Tap or keep pressing [◀◀] (backward)/[▶▶] (forward).

- If you keep pressing these buttons, normal playback restarts by releasing them.
- Tap [▶, PLAY] to restart normal playback.

Jet Search

During play

Tap [◀◀] (backward)/[▶▶] (forward) twice. You can increase Cue/Review search speed.

- Press [▶, PLAY] to restart normal playback.
- You can select search speed to view the recorded picture. (→ 52)
- The picture recorded in EP or VP mode may be distorted if it is played at approx. 35 times speed. A vertical scroll may occur. It is not a malfunction but if it happens, change to approx. 27 times speed.
- The picture may not be in color or may be distorted depending on the TV.

Slow

During play

Press and hold [⏸, PAUSE] for about 2 seconds or more.

- Press [▶, PLAY] to restart normal playback.

Jet Rewind

To perform a Higher Speed Rewind

Press [◀◀JET REW].

The "J. REW" indication appears on the TV screen.

- Depending on the tape or an operating condition, the rewind speed may change somewhat.
- The tape counter is reset to "00:00.00" when the tape is rewound to the beginning.
- Depending on the tape, this function may not work.

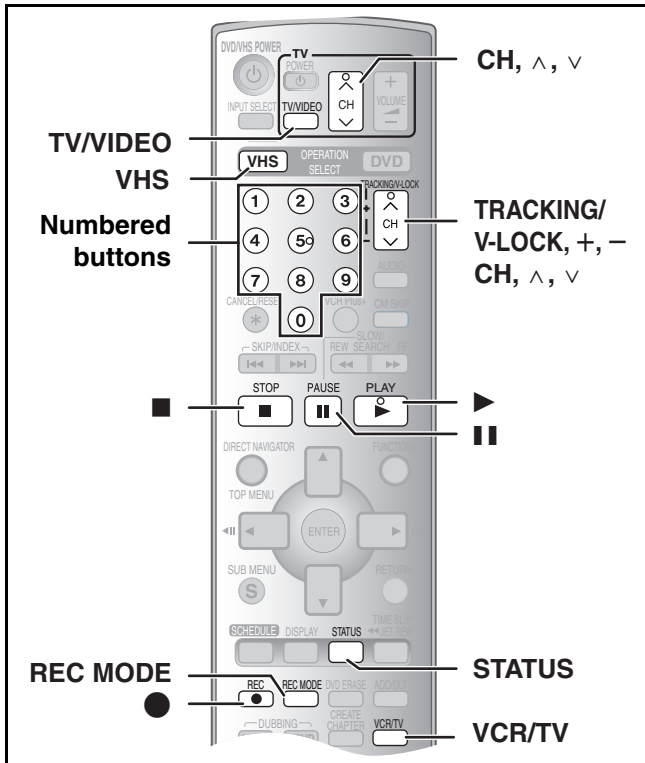

Preparation

- Press [VHS].

S-VHS Quasi Playback (SQPB)

It is also possible to play back tapes recorded in the S-VHS system.

- Some picture noise may occur depending on the type of tape used.
- It is not possible to fully obtain the high resolution that S-VHS is capable of.
- It is not possible to record in the S-VHS system with the unit.

Repeat Playback

During play or while stopped
Keep pressing [▶, PLAY] for about 5 or more seconds.



- The "RPT" indication appears on the unit's display.
- At the end of the program, the tape rewinds to the beginning of the program and plays it again (it only works if there is at least 5 seconds blank space at the end of the program). This repeats until you cancel it.

■ To restart normal playback

Press [▶, PLAY].

■ To stop play

Press [■, STOP].

Adjusting the playback picture

■ Manual tracking

The unit usually makes tracking adjustments, but you may need to do it manually if noise appears on a tape recorded on other equipment.

During play

Press [TRACKING/V-LOCK, +] or [TRACKING/V-LOCK, -].

Repeat until the noise disappears.

■ Vertical locking adjustment

Adjust the vertical synchronization to stop the picture from jiggling while paused.

While paused

Press [TRACKING/V-LOCK, +] or [TRACKING/V-LOCK, -].

Repeat until the jiggling stops.

■ To return to auto tracking

Press both [TRACKING/V-LOCK, +] and [TRACKING/V-LOCK, -] simultaneously.

■ To remove the noise from a paused picture

Start slow play, then adjust the tracking.

Note

- This function may not work with some TV models and tapes.
- You can also adjust the tracking and vertical synchronization with [CH, ^, v] on the main unit.

Recording TV programs

Recording procedures

Preparation

- Select the unit viewing channel (e.g. AV input) on the TV.
- Check that the clock is set to the correct time. If it has not been set, set it (→ 44).
- Press [VHS].

1 Insert a video cassette with an intact accidental erasure prevention tab. (→ 46)

2 Press [CH, ^, v] to select a TV channel.

- If you keep pressing these buttons, the channels change quickly.
- For VHS, the “DV” channel can be selected however it cannot be recorded.

To select channels with the numbered buttons:

Antenna Mode (Airwaves)

e.g., “5”: [0]→[5]
 “15”: [1]→[5]

CableTV Mode (Cable)

e.g., “5”: [0]→[0]→[5]
 “15”: [0]→[1]→[5]
 “115”: [1]→[1]→[5]

3 Press [REC MODE] to select a recording mode.

Each time you press the button:

SP→EP→VP
 ↑

4 Press [●, REC] to start recording.

To pause recording

Press [||, PAUSE]. (Press again to restart recording.)

To stop recording

Press [■, STOP].

Recording mode

SP: You can record the length shown on the tape.

EP: 3 times the length of SP mode.

VP: 5 times the length of SP mode.

- To have a longer recording capacity, select “EP” or “VP”.
- If the image quality is important to you or if you wish to store the tape for a long period, select “SP”.
- The unit can play tapes recorded in LP mode on other equipment.

VP mode:

- **A tape recorded in VP mode by the unit cannot be played back by other VCRs. It is recommended to distinguish it from other tapes by writing “VP” on the tape label, etc.**
- It takes more time for automatic tracking to work when playing tapes recorded with VP mode, and it may not work at all with some tapes. Do tracking manually if this is the case (→ 48).

Note

- **Even if the video cassette you use is labeled “S-VHS”, it is not possible to record in the S-VHS system with the unit. It records in the normal VHS system.**
- You cannot change channels while recording. You can change channels while in pause mode.
- When recording is paused for 5 or more minutes, the unit returns to stop mode.

To display the approximate remaining tape time

- 1 Select “TAPE SELECT” from the “VHS” menu and select the corresponding tape length. (→ 52)
- 2 Press [STATUS] several times.

The display changes as follows each time [STATUS] is pressed.

Input channel → **Remaining tape time** → Counter
 ↑

- The remaining tape time may not be displayed correctly depending on the tape used.

Specifying the time when recording will stop

Preparation

- Press [VHS].

While recording

Press [●, REC] to select recording time.

- You can also press [●, REC] on the main unit.

The unit's display

Each time you press the button:

Counter (Cancel) → OFF 0:30 → OFF 1:00 → OFF 1:30
 ↑ OFF 4:00 ← OFF 3:00 ← OFF 2:00 ←

For your reference

- When the recording time ends, the unit will turn off itself.
- This does not work during scheduled recording.
- Recording stops and the set time is cleared if you press [■, STOP].

Watching the TV while recording

Preparation

- Connection (without Audio/Video cable)
 - Make sure that the “TV” indicator is lit on the unit's display. If it is not lit, press [VCR/TV] to light it.
- Connection (with Audio/Video cable)
 - Press [TV/VIDEO] to change the input mode to “TV”.

Press TV's [CH, ^, v] to select a desired TV channel.

For your reference

- You can also do this if the unit is making a scheduled recording.
- The recording is not affected.

Playing DVD while VHS recording

You can play discs while recording. The recording will not be affected.

- DVD playback (→ 20)

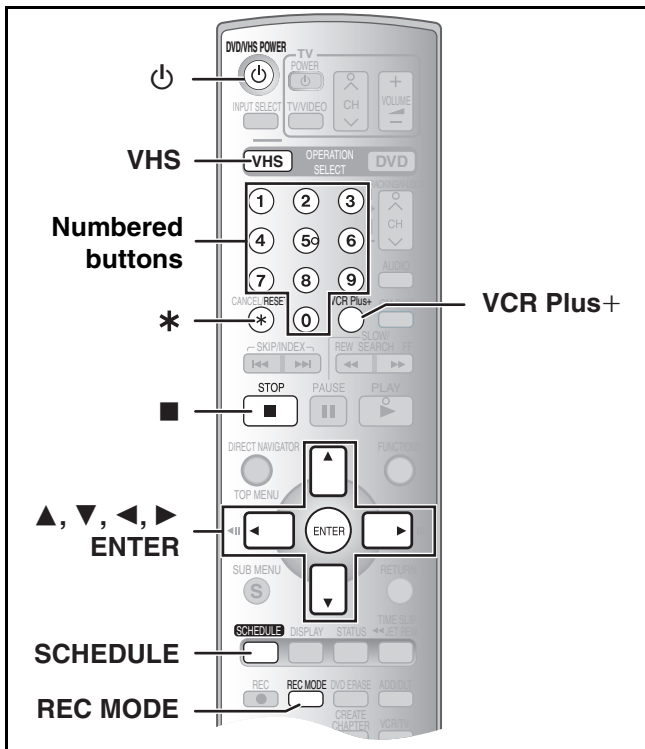

Cautions for using scheduled recording on VHS

■ Scheduled recording automatically starts at the set time.

- Scheduled recording can be started only when the unit is turned off. About 1 minute before the scheduled recording starts, the unit switches on. When it finishes, the unit switches back off. If another program is also being played back, the unit does not switch back off.

■ Scheduled recording cannot be activated on both DVD and VHS at the same time.

Make sure the scheduled recording start times do not overlap on both DVD (→ 29) and VHS (→ 51) Scheduled Recording screens.

When the scheduled recording settings overlap:

- When the start time of both scheduled recordings is the same, the scheduled recording of the last one set has priority.

Scheduled Recording

You can enter up to 16 programs a month in advance.

Preparation

- Select the unit viewing channel (e.g. AV input) on the TV.
- Check that the clock is set to the correct time. If it has not been set, set it (→ 44).
- Insert a video cassette with an intact accidental erasure prevention tab. (→ 46)
- Press [VHS].

■ Using VCR Plus+ system

Entering the PlusCode® numbers is an easy way of scheduled recording. You can find these codes in TV listings in newspapers and magazines.

- When connecting a cable TV box or satellite receiver, the VCR Plus+ system does not work. Program the scheduled recording manually (→ 51).

1 Press [VCR Plus+].



2 Press the numbered buttons to enter the PlusCode number.

- Press [◀] to move back to correct a digit.

3 Press [ENTER].

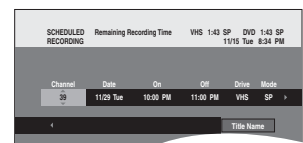

- Confirm the program and correct it if necessary using [▲, ▼, ◀, ▶]. ("Manual programming" → 51, step 2)
- "Invalid Entry" is displayed when you enter the wrong PlusCode number. Reenter the PlusCode number.

4 If the program is correct

Press [ENTER].

- Make sure that the scheduled recording has been programmed correctly on the SCHEDULED LIST screen (→ 51).
- Repeat steps 1–4 to program other recordings.

5 Press [SCHEDULE].

- The message "Turn recorder off for Scheduled Recording." is shown on the TV.

6 Press [⏻, DVD/VHS POWER].

- Scheduled recording can be started only when the unit is turned off.
- The unit turns off and "⏻" lights on the unit's display to indicate scheduled recording standby has been activated.

■ To release the unit from scheduled recording standby Press [⏻, DVD/VHS POWER].

The unit turns on and "⏻" goes out.

- Be sure to press [⏻, DVD/VHS POWER] to return the unit to standby mode before the scheduled recording time. Scheduled recording will work only if "⏻" is displayed.

■ To stop recording while a program is working

1 Press [VHS]

2 Press [■, STOP], then [ENTER] within 5 seconds.

- You can also press and hold [■] on the main unit for 3 or more seconds to stop recording.

Note

Refer to Note in Manual programming (→ 51).

Manual programming

- When connecting a cable TV box or satellite receiver, select the channel on the cable TV box or satellite receiver before scheduled recording starts.

1 Press [SCHEDULE].

- Make sure "New Scheduled Recording" is selected.

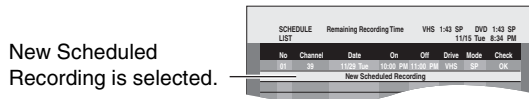

2 Press [ENTER], then move and change the items using [▲, ▼, ◀, ▶].

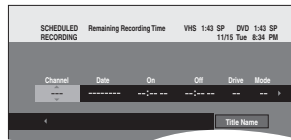

- You may use the numbered buttons to enter "Channel", "Date", "On", and "Off".
- Channel** (Program Position/TV Station Name)
- Date**
You can also make a daily or weekly program.
- On** (start time)/**Off** (finish time)
The time increases or decreases in 30-minute increments if you hold down the button.
- Drive** (Recording drive)
Select recording drive to "VHS".
- Mode** (Recording mode)
You can also press [REC MODE] to change the recording mode.
SP ↔ EP ↔ VP ↔ AUTO* ↔ SP.. (→ 49)
* Auto SP/EP mode (→ right)
- Title Name**
Cannot be used.

3 Press [ENTER] when you have finished making changes.

- "Invalid Entry" is displayed when you enter the wrong item. Reenter the item.
- Make sure that the scheduled recording has been programmed correctly on the SCHEDULE LIST screen (→ right).
- To continue programming:
Select "New Scheduled Recording" and repeat steps 2–3.

4 Press [SCHEDULE].

- The message "Turn recorder off for Scheduled Recording." is shown on the TV.

5 Press [⏻, DVD/VHS POWER].

- Scheduled recording can be started only when the unit is turned off.
- The unit turns off and "⏻" lights on the unit's display to indicate scheduled recording standby has been activated.

To release the unit from scheduled recording standby Press [⏻, DVD/VHS POWER].

The unit turns on and "⏻" goes out.

- Be sure to press [⏻, DVD/VHS POWER] to return the unit to standby mode before the scheduled recording time. Scheduled recording will work only if "⏻" is displayed.

To stop recording while a program is working

1 Press [VHS]

2 Press [■, STOP], then [ENTER] within 5 seconds.

- You can also press and hold [■] on the main unit for 3 or more seconds to stop recording.

Note

- "⏻" flashes when the unit cannot perform scheduled recording (e.g., video cassette with no accidental erasure prevention tab or no video cassette in the cassette compartment).
- The actual time recorded may be longer than the program itself when TV programs are recorded using VCR Plus+ system.
- If you set (→ 44) "DST" (Daylight Saving Time) to "On" when manually setting the clock, scheduled recording may not work when summer switches to winter and vice versa.

Auto SP/EP mode

If, at the beginning of a scheduled recording, there is not enough tape remaining to complete the recording, the SP/EP function will automatically run the tape at EP mode for recording. This ensures that the entire program will be recorded. If EP mode is not enough to stretch the remaining tape to fit the whole program you will not be able to record the whole TV program.

Scheduled recording

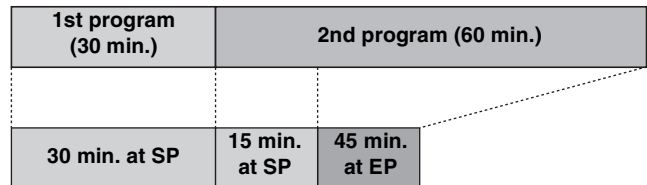

Video tape (e.g.: 60-minute cassette)

- It is not possible to automatically activate VP mode.
- The tape length must be set correctly. (→ 52)
- Some tapes may not work correctly.
- If the recording mode changes from SP to EP during a scheduled recording, some picture distortion occurs at that point.

Check, change or delete programs

- Even when the unit is turned off, you can display the scheduled recording list by pressing [SCHEDULE].

1 Press [SCHEDULE].



2 Press [▲, ▼] to select a program.

3 Press [CANCEL/RESET, *] to delete, or press [ENTER] to change.

You cannot delete programs that are currently recording. The scheduled recording setting screen appears.

4 If you press [ENTER] in step 3

Use [▲, ▼, ◀, ▶] to change and press [ENTER].

5 Press [SCHEDULE].

- The message "Turn recorder off for Scheduled Recording." is shown on the TV.

To put the unit on scheduled recording standby Press [⏻, DVD/VHS POWER].

- The unit turns off and "⏻" lights on the unit's display to indicate scheduled recording standby has been activated.

For your reference

- Programs that failed to record are not deleted from the list immediately, but are deleted from the list automatically at 4 a.m. 2 days later.

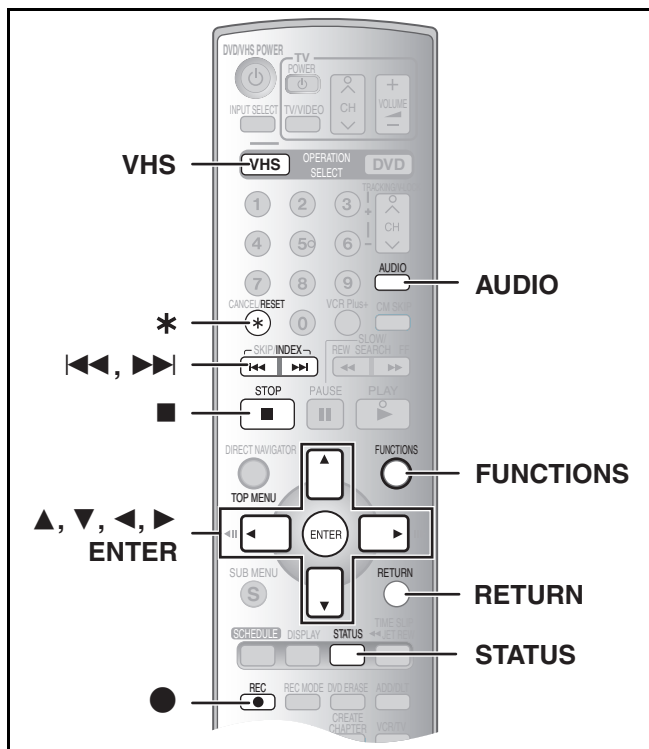

Preparation

- Select the unit viewing channel on the TV.
- Press [VHS].

VHS Index Search System (VISS)

The unit automatically records special index signals on the tape every time a recording is started. The index search function makes use of these index signals to let you find the beginning of a desired program quickly and easily.

■ Index signals are recorded in the following cases.

- When a recording is started by pressing [●, REC].
- When scheduled recording is started.

Preparation

- Insert a recorded video cassette.

While stopped or during normal play
Press [◀◀] or [▶▶].

- Each press increases the number of skips.



■ To cancel the index search

Press [■, STOP].

Note

- Up to 20 index signals can be searched for in both directions.
- If you press either one of the buttons too much, you can control the number of skips by pressing the opposite button.
- The figure on the display decreases by 1 each time an index signal is located.
- This feature may not work correctly if the index signals are too close together. Make recordings of at least 5 minutes.

Changing the unit's settings

- 1 While stopped
Press [FUNCTIONS].
- 2 Select "Other Functions" with [▲, ▼] and press [ENTER].
- 3 Select "SETUP" and press [ENTER].
- 4 Select "VHS" with [▲, ▼] and press [◀, ▶].
- 5 Select an item to be changed with [▲, ▼] and press [ENTER].
- 6 Select an option with [▲, ▼] and press [ENTER].

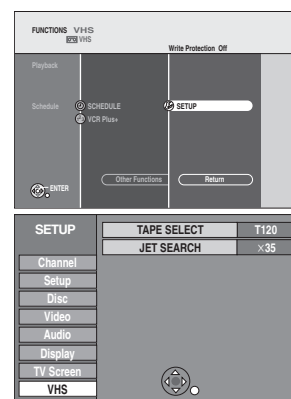

■ To return to the previous screen

Press [RETURN]. Even if you have changed an option, the change is not activated until you press [ENTER].

■ To exit the screen

Press [RETURN] several times.

For your reference

- The settings remain intact even if you switch the unit to standby.

▶ Summary of settings

This description shows the initial settings for the unit. For details on menu operation (→ above).

- Underlined items are the factory default settings.

■ VHS

TAPE SELECT

Set the length of tape you are using so the unit can show the correct remaining time.

[T120] [T160] [T180]

[T120]: T30, T60, T90 and T120 tapes

[T160]: T140 and T160 tapes

[T180]: T180 tapes

JET SEARCH (→ 47)

Set the speed for JET SEARCH when playing EP and VP tapes.

- It is possible to view the picture recorded in EP or VP mode at approx. 27 or 35 times speed.

[×27] [×35]

- Select [×27] if the picture is poor at [×35].

Depending on the following, the status message displayed will change.

■ DVD side not recording:

VHS operation when not recording or making a scheduled recording on the DVD side.

■ DVD side recording:

VHS operation when recording or making a scheduled recording on the DVD side.

When the DVD side is not recording

Press [STATUS] to change the information displayed.

The display changes each time you press the button.

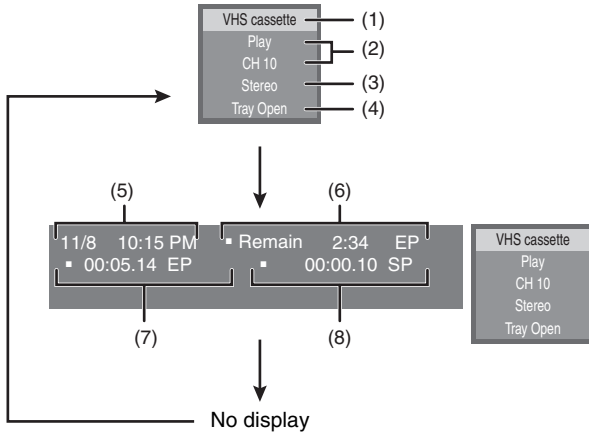

■ Display examples

- (1) A VHS cassette is inserted/not inserted
- (2) Current recording or play status, input channel
 - Shows the current state of the unit and the input channel.
- (3) Audio type (→ right)
- (4) Other drive operation
- (5) The current date and time
- (6) Available recording time and recording mode (e.g.: "2:34 EP" indicates 2 hours and 34 minutes in EP mode)
- (7) Elapsed play time
- (8) Recording time
 - Shows recording time, recording mode and a rough guide to how much space has been used for recording on the tape.

When the DVD side is recording

To see these displays, set the "Status Messages" item in the "Display" to "Automatic". (→ 43)

Press [STATUS].

The time and operation details appear on the screen for about 5 seconds.

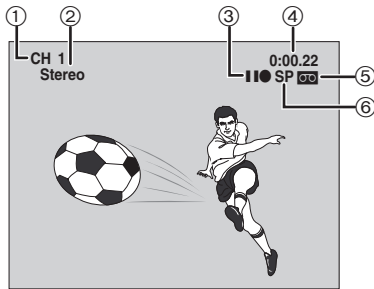

① Channel display

②	<p>Stereo/Mono/SAP indication Indicates whether a program is broadcast in stereo, mono or SAP.</p> <p>Audio indicators (appear only in playback) The Left (Mono L) and Right (Mono R) indicators show which sound mode is selected as follows: Stereo: Stereo indicators appear. Mono L: The Mono L indicator appears. Mono R: The Mono R indicator appears. Normal: Neither the L nor R indicator appears.</p>
③	<p>Operation status display</p>
④	<p>Shows the time and tape counter Pressing [STATUS] once makes the on-screen display appear. After that, press the button repeatedly to change the display as follows: Present time → Tape counter → Remaining tape time ↑</p> <p>During Index search: "01" to "20" is displayed. During Jet Rewind: "J. REW" is displayed.</p> <ul style="list-style-type: none"> • Press [CANCEL/RESET, *] to reset the tape counter (elapsed time) to "0:00.00". The tape counter is automatically reset to "0:00.00" when inserting a video cassette. • The remaining time is approximate. It will be incorrect if you set the wrong tape time in "TAPE SELECT" in the "VHS" menu and if the tape is of poor quality.
⑤	<p>Cassette-in indicator Shows whether you have inserted a video cassette.</p>
⑥	<p>Recording mode indicator (→ 49)</p>

Note

- These displays do not appear when paused or during slow play.
- The on-screen display may be distorted depending on the playback tape or the input signal.

Changing audio

While playing tapes
Press [AUDIO].

The audio changes as follows:

	Stereo program	SAP program
DVD side not recording	Ⓐ	Ⓑ
DVD side recording	Ⓐ	Ⓐ

Ⓐ: Stereo → Mono L → Mono R → No display (Normal audio track)
↑

Ⓑ: MAIN+SAP → MAIN → SAP → No display (Normal audio track)
↑

Auto Bilingual Choice Function

When a stereo broadcast or SAP broadcast is recorded and played back on the unit, stereo sound will be automatically selected in the case of a stereo broadcast and SAP sound will be automatically selected in the case of a dual-sound broadcast (Mono and SAP or Stereo and SAP).

- This function may not work properly if the program is played back from a mid point. In a case like this, press [AUDIO] and select the right sound.
- The function will not work with a cassette which has been recorded using external equipment.

Before transferring (dubbing)

You cannot transfer (dub) titles which have been treated to prevent copying.

Direction		Type of transfer (dubbing) you want	Suitable methods
From	To		
VHS	DVD-RAM, DVD-R, DVD-RW, or +R	Easy transferring (dubbing) with one button <ul style="list-style-type: none"> When you want to transfer (dub) from the selected start point to the end of the tape 	One Touch Transfer (→ 55)
DVD-RAM, DVD-R, DVD-RW or +R	VHS	Easy transferring (dubbing) with one button <ul style="list-style-type: none"> When you want to transfer (dub) a whole disc When you want to transfer (dub) from the beginning of the selected title to the end of the disc 	One Touch Transfer (→ 56)
Finalized disc [DVD-R, DVD-RW (DVD-Video format), +R], +RW or DVD-Video on sale that are not copy-protected, etc.	VHS	Easy transferring (dubbing) with one button	Cannot transfer

■ Caution for transfer (dubbing) from VHS to DVD

- Copy-protected video tapes cannot be dubbed. Most video tapes are copy-protected to prevent illegal reproduction and they cannot be recorded.
- When a copy-protected tape is inserted, a message appears on the display and the recording stops on the spot.
- If a part of a tape recorded in VP mode is dubbed to disc, noise may appear at the beginning of the dubbed part.

Only the following operations are allowed while transferring (dubbing):

- Stopping transfer by pressing and holding [RETURN] for about 3 seconds or more.
- Stopping transfer by pressing [■, STOP].
- Changing audio (→ 53)
- Adjusting the picture
- Changing operating drive

When transfer (dubbing) is started, the following operations also start automatically

- "Status Messages" on "Display" → "Off" (→ 43)

■ Caution for transfer (dubbing) from DVD to VHS

- Copy-protected discs cannot be dubbed. Most discs are copy-protected to prevent illegal reproduction and they cannot be recorded.
- If you set "TV Type" to progressive (→ 19), the setting switches to interlace when the transfer (dubbing) starts. However it returns to progressive when the transfer (dubbing) finishes.

Only the following operations are allowed while transferring (dubbing):

- Stopping transfer by pressing and holding [RETURN] for about 3 seconds or more.
- Stopping transfer by pressing [■, STOP].
- Changing operating drive

When transfer (dubbing) is started, the following operations also start automatically

- "Status Messages" on Display → "Off" (→ 43)
- Audio output when playing back DVD → Stereo (L R) **RAM**

If you start transfer (dubbing) when the resume play function (→ 20) is working, the transfer (dubbing) is executed from the beginning of the title which contains the starting position of playback to the end of the disc.

Transfer (Dubbing) from VHS

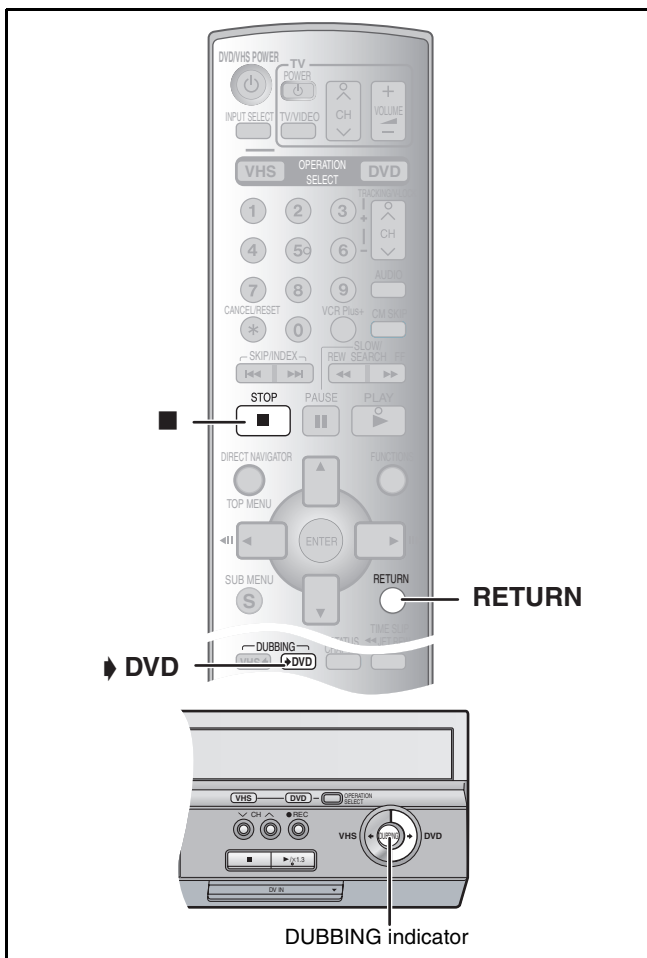

■ To stop transfer (dubbing) in the middle

Press [■, STOP] or press and hold [RETURN] for about 3 seconds or more.

Note

- When the transfer (dubbing) is not started or not executed, the "DUBBING" indicator blinks for about 7 seconds. Check if the unit is properly prepared.

■ Dividing a title to be dubbed

In One Touch Transfer (Dubbing) from VHS to DVD, the title is divided by index signal detected and then recorded. You can search desired titles with Direct Navigator's Title View (→ 33) after transfer (dub) to DVD.

- Titles recorded within 15 minutes (25 minutes in VP mode) of each other may not be divided properly.
- The recording time may become longer than the original title depending on the number of index signals.

■ One Touch Transfer (Dubbing) (VHS → DVD)

RAM -R -RW(V) +R

You can transfer (dub) programs recorded on a tape onto a disc* with one stroke of the button.

In One Touch Transfer (Dubbing), programs are automatically transferred (dubbed) onto the disc from the location of playback at the time when the transfer (dubbing) of the tape starts.

* Available discs for transfer (dubbing) from tape are DVD-RAM, non-finalized DVD-R, DVD-RW (DVD-Video format) and +R.

Preparation

- Select the unit viewing channel (e.g. AV input) on the TV.

DVD

- Release protection (disc → 30, cartridge → 30). **RAM**
- Insert a disc and confirm there is sufficient empty space for recording on it. (→ 8, 45)
- Select the recording mode. (→ 24)
- When SAP broadcast program is played back on VHS, select the audio to be recorded on disc in "Select MTS" in the "SETUP" menu. (→ 42) **-R -RW(V) +R**

VHS

- Insert the video cassette containing the program to be copied (→ 46).

- 1 While both DVD and VHS are stopped
Press and hold [▶ DVD, DUBBING] for about 3 seconds or more.

On the main unit, press [▶ DVD].

- Check if transfer (dubbing) starts properly.
- The "DUBBING" indicator on the main unit lights.
- Dub is automatically completed when the tape reaches its end or the disc becomes full.



Transfer (Dubbing) from DVD

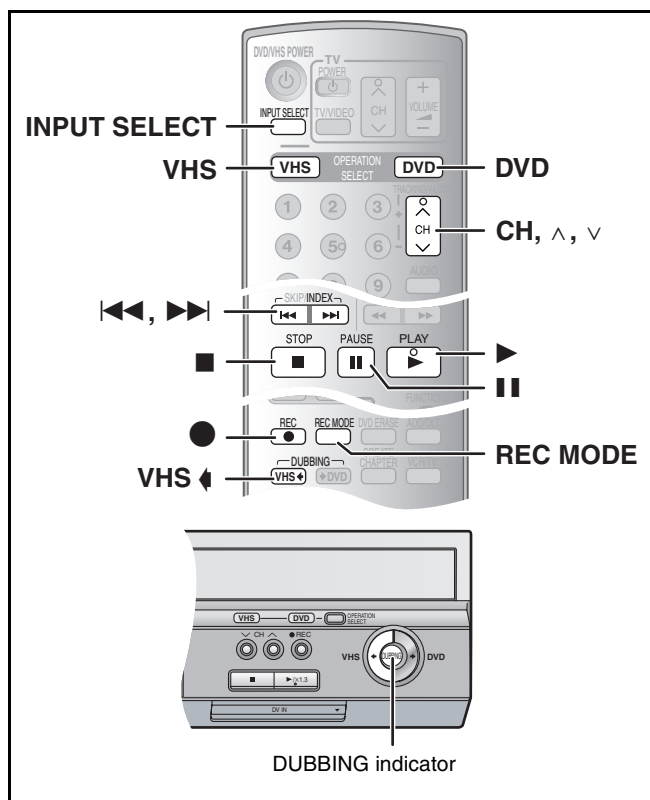

■ One Touch Transfer (dubbing) (DVD → VHS)

RAM -R -RW(V) +R

You can transfer (dub) titles recorded on a disc* onto a tape with one touch of the button.

In One Touch Transfer (dubbing), all contents on the disc are automatically dubbed onto the tape.

* Available discs for transfer (dubbing) onto tape are DVD-RAM, non-finalized DVD-R, DVD-RW (DVD-Video format) and +R.

Preparation

- Select the unit viewing channel (e.g. AV input) on the TV.

DVD

- Insert the disc containing the program to be copied (→ 8).

VHS

- Insert a video cassette with an accidental erasure prevention tab. (→ 46)
- Confirm that the remaining tape time is sufficient for recording. (→ 53)
- Select the recording mode. (→ 49)

■ When you transfer (dub) a whole disc Make sure that the DVD is stopped.

- When the resume play function is working, press [■, STOP] to de-activate it. (→ 20)

■ When you transfer (dub) a title from the beginning of the selected title to the end of the disc

- When you transfer (dub) a playlist from the beginning of the selected playlist to the last playlist Press [▶, PLAY] to play back the desired title or playlist (→ 36).

- You can transfer (dub) (a title or playlist) while playback is paused by pressing [⏸, PAUSE].
- You cannot transfer (dub) a playlist which is longer than 8 hours. (When you transfer (dub) multiple playlists, the playlist which is longer than 8 hours is omitted.)

1 Press and hold [VHS ↙, DUBBING] for about 3 seconds or more.

On the main unit, press [VHS ↙].

- Check if transfer (dubbing) starts properly.
- The “DUBBING” indicator on the main unit lights.
- Dubbing is automatically completed when playback of the disc is finished or the tape reaches its end.



■ To stop transfer (dubbing) in the middle

Press [■, STOP].

Note

- When the transfer (dubbing) is not started or not executed, the “DUBBING” indicator blinks for about 7 seconds. Check if the unit is properly prepared.
- If you start transfer (dubbing) when the resume play function is working, the DVD is dubbed from the beginning of the title where play last stopped.

■ About Recording VISS (→ 52)

In One Touch Dubbing from DVD to VHS, the index signal is automatically recorded for each title. You can search desired titles with [◀◀] or [▶▶].

Recording from an external device

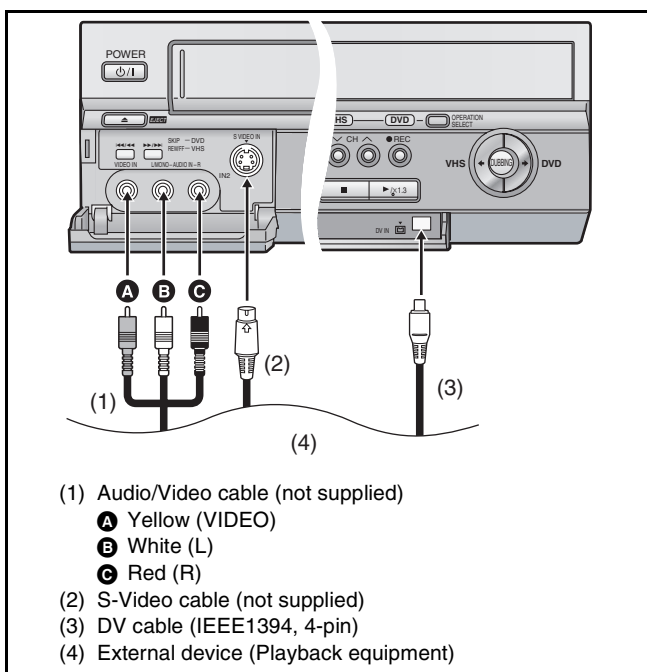

When connecting to the IN2/DV input terminals on the front of the unit

- You can also connect to the IN1 input terminals on the rear of the unit.

Before connecting any cables, first make sure that the power for the unit and the external device are off. Then, after connecting cables, turn on both.

If the audio output of the other equipment is monaural

Connect to L/MONO. (Both left and right channels are recorded when connected through L/MONO.)

- The S-VIDEO terminal achieves a more vivid picture than the VIDEO terminal.

When recording from the unit's DV input terminal (→ 27)

- The audio recorded through the DV input terminal is the audio selected in the "Select Audio Channel For DV Input" (→ 42).
- When recording from DV equipment (e.g., digital video camcorder), you can record audio/video recordings from DV tape only.
- The DV input on this unit is for use with DV equipment only.

Manual recording

Preparation

- Connect an external device to this unit's input terminals (→ above).

DVD **RAM -R -RW(V) +R**

- Release protection (disc → 30, cartridge → 30). **RAM**
- Press [DVD].

VHS

- Insert a video cassette with an accidental erasure prevention tab. (→ 46)
- Press [VHS].

DVD

Follow the above steps 1 to 2.

- 3 Start play on the external device.
- 4 Press [●, REC] at the point where you want to start recording.

To skip unwanted parts

Press [II, PAUSE] to pause recording. (Press again to restart recording.)

To stop recording

Press [■, STOP].

Note

- When recording using the unit's input terminals, only the sound received at the time of recording will be recorded. As long as secondary audio that is recorded on the media in the external device is not output to the unit in play, it is not recorded.
- When recording using IN1 or IN2 terminals, only the sound received at the time of recording will be recorded.

For your reference

- Almost all videos and DVD software on sale have been treated to prevent illegal copying. Such software cannot be recorded.

- 1 Press [REC MODE] to select the recording mode. (DVD → 24, VHS → 49)

• DVD **RAM -R -RW(V) +R**

- It is also possible to perform Flexible Recording (FR). (→ 25)

- 2 While stopped

Press [CH, ^, v] or [INPUT SELECT] to select the input channel for the equipment you have connected.

- Select IN1, IN2 or DV.
- For VHS, the "DV" channel can be selected however it cannot be recorded.

VHS

Follow the above steps 1 to 2.

- 3 Press [▶, PLAY].
 - Start playing the video cassette and find the recording start point.
- 4 Press [II, PAUSE], then press [●, REC].
 - Put the unit in recording standby mode.
- 5 Start play on the external device.
- 6 Press [II, PAUSE] at the point where you want to start recording.

Glossary

Bitstream

This is a signal compressed and converted into digital form. It is converted back to a multi-channel audio signal, e.g., 5.1-channel, by a decoder.

CPRM (Content Protection for Recordable Media)

CPRM is technology used to protect broadcasts that are allowed to be recorded only once. Such broadcasts can be recorded only with CPRM compatible recorders and discs.

Decoder

A decoder restores the coded audio signals on DVDs to normal. This is called decoding.

Down-mixing

This is the process of remixing the multi-channel audio found on some discs into two channels. It is useful when you want to listen to the 5.1-channel audio recorded on DVDs through your TV's speakers. Some discs prohibit down-mixing. If this is the case, this unit can only output the front two channels.

Dynamic range

Dynamic range is the difference between the lowest level of sound that can be heard above the noise of the equipment and the highest level of sound before distortion occurs. Dynamic range compression means reducing the gap between the loudest and softest sounds. This means you can hear dialog clearly at low volume.

Film and Video

DVD-Videos are recorded using either film or video. The unit can determine which type has been used, then uses the most suitable method of progressive output.

- Film is 24 or 30 frames per second, with motion picture film generally being 24 frames per second.
- Video is 60 fields per second (2 fields making up 1 frame).

Finalize

A process that makes play of a recorded CD-R, CD-RW, DVD-R, etc. possible on equipment that can play such media. You can finalize DVD-R, DVD-RW (DVD-Video format) and +R on the unit. After finalizing, the disc becomes play-only and you can no longer record or edit. However, finalized DVD-RW can be formatted to become recordable.

Formatting

Formatting is the process of making media such as DVD-RAM recordable on recording equipment. You can format DVD-RAM and DVD-RW (only as DVD-Video format) on the unit. Formatting irrevocably erases all contents on the disc.

Frame and field

Frame refers to the single images that constitute the video you see on your TV. Each frame consists of 2 fields.

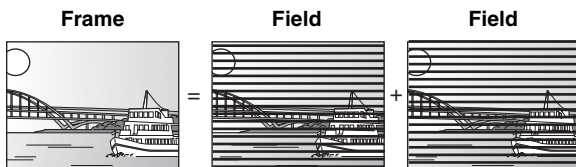

- A frame still shows 2 fields, so there may be some blurring between them, but picture quality is generally better.
- A field still shows less picture information so it may be rougher, but there is no blurring.

JPEG (Joint Photographic Experts Group)

This is a system used for compressing/decoding color still pictures. If you select JPEG as the storage system on digital cameras, etc., the data will be compressed to 1/10–1/100 of its original size. The benefit of JPEG is less deterioration in picture quality considering the degree of compression.

MP3 (MPEG Audio Layer 3)

An audio compression method that compresses audio to approximately one-tenth of its size without any considerable loss of audio quality. You can play MP3s you have recorded onto CD-R and CD-RW.

Pan & Scan/Letterbox

In general, DVD-Video are produced with the intention that they will be viewed on a widescreen TV (16:9 aspect ratio), so images often don't fit regular TVs (4:3 aspect ratio). 2 styles of picture, "Pan & Scan" and "Letterbox", deal with this problem.

Pan & Scan: The sides are cut off so the picture fills the screen.



Letterbox: Black bands appear at the top and bottom of the picture so the picture itself appears in an aspect ratio of 16:9.



Playback control (PBC)

If a Video CD has playback control, you can select scenes and information with menus displayed on the screen. (The unit is compatible with version 2.0 and 1.1.)

Progressive/Interlace

NTSC, the video signal standard, has 480 interlaced (i) scan lines, whereas progressive scanning uses twice the number of scan lines. This is called 480p.

Using progressive output, you can enjoy the high-resolution video recorded on media such as DVD-Video.

Your TV must be compatible to enjoy progressive video.

Protection

You can prevent accidental erasure by setting writing protection or erasure protection.

Sampling frequency

Sampling is the process of converting the heights of sound wave (analog signal) samples taken at set periods into digits (digital encoding). Sampling frequency is the number of samples taken per second, so larger numbers mean more faithful reproduction of the original sound.

Thumbnail

This refers to a miniature representation of a picture used to display multiple pictures in the form of a list.

Frequently asked questions

Set up		Page
What equipment is necessary to play multi channel surround sound?	<ul style="list-style-type: none"> • DVD-Video: You can play DVD-Video multi channel surround by digitally connecting an amplifier equipped with a Dolby Digital and a DTS decoder. 	14
Can the headphones and speakers be directly connected to the unit?	<ul style="list-style-type: none"> • You cannot directly connect to the unit. Connect through the amplifier etc. 	14
The TV has both S-VIDEO IN terminal and COMPONENT VIDEO IN terminals. Which terminal should I connect with?	<ul style="list-style-type: none"> • We recommend the COMPONENT VIDEO IN terminal. Component signal outputs the color difference signals (PB/PR) and luminance signal (Y) separately in order to achieve high fidelity in reproducing colors. If the TV is compatible with progressive output, a high quality picture can be output because the unit's component video output terminal outputs a progressive output signal. 	14
Is my TV progressive output compatible?	<ul style="list-style-type: none"> • All Panasonic TVs that have 480p input terminals are compatible. Consult the manufacturer if you have another brand of TV. 	–

Disc		Page	
Can I play DVD-Video and Video CDs bought in another country?	<ul style="list-style-type: none"> • You can play them if the video standard is NTSC. • However, you cannot play DVD-Video if its region number does not include "1" or "ALL". 	– 7	
Can a DVD-Video that does not have a region number be played?	<ul style="list-style-type: none"> • The DVD-Video region number indicates the disc conforms to a standard. You cannot play discs that do not have a region number. 	–	
Please tell me about DVD-R, DVD-RW, +R and +RW compatibility with the unit.	<ul style="list-style-type: none"> • The unit records and plays DVD-R, DVD-RW (DVD-Video format) and +R, and plays DVD-RW (DVD Video Recording format) and +RW. • The unit also records and plays high speed recording compatible DVD-R, DVD-RW, +R discs. • After formatting +R discs <ul style="list-style-type: none"> - You may not be able to play +R discs on this unit after formatting them on other Panasonic products or other manufacturer's equipment. - You may not be able to play +R discs on other equipment after formatting them on this unit. If you finalize the disc on the equipment used for formatting, play becomes possible.	6, 7 6 –	
	Please tell me about CD-R and CD-RW compatibility with the unit.	<ul style="list-style-type: none"> • This unit plays CD-R/CD-RW discs which have been recorded in one of the following standards: CD-DA, Video CD, MP3 and still pictures (JPEG). Close the session or finalize the disc after recording. This unit can recognize up to 99 folders (groups) and 999 files (tracks) on a disc with MP3 or still pictures (JPEG). • You cannot write to a CD-R or CD-RW with the unit. 	7, 22, 23 7

Recording		Page
Can I record from a commercially purchased video cassette or DVD?	<ul style="list-style-type: none"> • Most commercially sold video cassettes and DVD are copy protected; therefore, recording is usually not possible. 	–
Can DVD-R, DVD-RW (DVD-Video format) and +R recorded on the unit be played on other equipment?	<ul style="list-style-type: none"> • You can play on compatible equipment such as DVD players after finalizing the disc on this unit. However, depending on the condition of the recording, the quality of the disc and capabilities of the DVD player, play may not be possible. 	31
Can I record digital audio signals using the unit?	<ul style="list-style-type: none"> • You cannot record digital signals. The digital audio terminals on the unit are for output only. (The audio recorded using the DV automatic recording function from a digital video camcorder, for example, is recorded digitally.) 	–
Can a digital audio signal from the unit be recorded to other equipment?	<ul style="list-style-type: none"> • You can record if using the PCM signal. When recording DVD, change the "Digital Audio Output" settings to the following from the SETUP menu. <ul style="list-style-type: none"> - PCM Down Conversion "On" - Dolby Digital "PCM" - DTS "PCM" However, only <ul style="list-style-type: none"> - As long as digital recording from the disc is permitted. - As long as the recording equipment is compatible with 48 kHz of sampling frequency. • You cannot record MP3 signals. 	42 –
	Can I switch to SAP during recording?	<ul style="list-style-type: none"> • With DVD-RAM, you can, and the audio recorded also changes. Just press [AUDIO]. • With DVD-R, DVD-RW (DVD-Video format), +R you cannot. Change before recording with "Select MTS" in the SETUP menu.

Error messages

Common

On the unit's display		Page
H□□, F□□, U□□ (“□□” stands for a number.)	<ul style="list-style-type: none"> An error has occurred. The number following “H”, “F” or “U” depends on the status of the unit. Reset procedure: (“The unit is on but cannot be operated.” → 62) If the service numbers fail to clear, note the service numbers and contact a qualified service person. 	–

DVD

On the TV		Page
Cannot finish recording completely.	<ul style="list-style-type: none"> The program was copy-protected. The disc may be full. There are already 99 recorded titles (+R 49 recorded titles). 	–
Cannot play.	<ul style="list-style-type: none"> You inserted an incompatible disc (Discs recorded in PAL video, etc.). 	–
Cannot record on the disc.	<ul style="list-style-type: none"> The disc may be dirty or scratched. 	8
Unable to format.		
Please check the disc.		
Cannot record. Disc is full.	<ul style="list-style-type: none"> Create space by erasing any unwanted titles. RAM -RW(V) [Even if you erase recorded content from the DVD-R or +R, there is no increase in disc space. Available disc space on DVD-RW (DVD-Video format) increases only when the last recorded title is erased.] Use a new disc. 	21, 30, 33
Cannot record. The number of titles has exceeded the maximum limit.		–
Error has occurred. Please press ENTER.	<ul style="list-style-type: none"> Press [ENTER] to start recovery process. You cannot operate the unit while it is recovering (“SLF CHECK” appears on the unit's display). 	–
No disc	<ul style="list-style-type: none"> You haven't inserted a disc. Correctly insert a disc that the unit can play. The disc is upside down. If it is a single-sided disc, insert it so the label is facing up. 	6, 8, 8
Please change the disc.	<ul style="list-style-type: none"> There may be a problem with the disc. Press [▲, OPEN/CLOSE] to remove it and check it for scratches or dirt. (The unit turns off automatically after you open the tray.) 	8
This is a non-recordable disc.	<ul style="list-style-type: none"> The unit cannot record on the disc you inserted. Insert a DVD-RAM or unformatted DVD-R, DVD-RW (DVD-Video format) or +R. You inserted an unformatted DVD-RAM or DVD-RW. Format the disc with the unit. 	–
This disc is not formatted properly.		31
⊘	<ul style="list-style-type: none"> The operation is prohibited by the unit or disc. 	20

On the unit's display		Page
RC □ (“□” stands for a number.)	<ul style="list-style-type: none"> The remote control and main unit are using different codes. Change the code on the remote control. 	18
Err	<ul style="list-style-type: none"> The disc is dirty or badly scratched. The unit cannot record, play, or edit. You have used a lens cleaner and it has finished. Press [▲, OPEN/CLOSE] to eject the disc. You have inserted a disc the unit cannot play or record on. You have inserted a DVD-RAM or DVD-RW that is unformatted or recorded on other equipment. If there is no change after turning the unit on and off, consult the dealer where the unit was purchased. 	8, 8, 7, 31, –
oooooo (self check)	<ul style="list-style-type: none"> There was something unusual detected with the disc while recording, playing or transferring (dubbing), there was a power failure or the AC plug was disconnected while the unit was on. The unit is carrying out its recovery process. This process restores the unit to normal operation. The unit is not broken. Wait until the message disappears. <div style="display: flex; align-items: center;">  <div style="margin-left: 10px;"> <p>The symbol “o” appears at the bottom left of the unit's display. The number of symbols increases one by one until six appear. They then disappear one by one until none remain. This continues during self check.</p> </div> </div>	61
U59	<ul style="list-style-type: none"> The unit is very warm. The unit switches to standby for safety reasons. Wait for about 30 minutes until the message disappears. Select a position with good ventilation when installing the unit. Do not block the cooling fan on the rear of the unit. 	–
U99	<ul style="list-style-type: none"> The unit fails to operate properly. Press [POWER ⏻/⏻] on the main unit to switch the unit to standby. Now press [POWER ⏻/⏻] on the main unit again to turn the unit on. 	–

VHS

On the TV		Page
No VHS cassette.	<ul style="list-style-type: none"> A video cassette is not inserted when recording programs. Insert a video cassette with an accidental erasure prevention tab. 	46
Please check write protect tab on the VHS cassette.	<ul style="list-style-type: none"> A video cassette without the accidental erasure prevention tab is inserted when recording programs. Use a video cassette with an accidental erasure prevention tab. 	46

Troubleshooting guide

Before requesting service, make the following checks. If you are in doubt about some of the check points, or if the remedies indicated in the chart do not solve the problem, refer to the "Customer Services Directory" on page 66 if you reside in the U.S.A., or refer to "Product information" on page 65 if you reside in Canada. In other areas, consult your dealer.

The following do not indicate a problem with the unit:	
<ul style="list-style-type: none"> ● Regular disc rotating sound. The sound of the disc rotating may become louder especially when finalizing a DVD-R, DVD-RW (DVD-Video format) or +R. ● Poor reception due to atmospheric condition. ● Image disturbance during search. ● Periodic interruptions to reception due to satellite broadcasting breaks. ● Operations do not work due to a poor-quality disc. (Try again using a Panasonic disc.) ● The unit freezes due to the activation of one of its safety devices. (Press and hold [POWER ⏻/⏪] on the main unit for 10 seconds.) 	

Common

Power		Page
No power	● Insert the AC power supply cord securely into a known active AC outlet.	12
The unit switches to the standby mode.	<ul style="list-style-type: none"> ● This is a power saving feature. Change "Off Timer" in the "SETUP" menu, if you would prefer. ● One of the unit's safety devices is activated. Press [POWER ⏻/⏪] on the main unit to turn the unit on. 	41 —
Cooling fan rotating sounds are heard when the unit is off.	● The cooling fan sometimes operates to cool active circuits in the unit while it is turned off. To detect user operation and to prepare for quick REC&PLAY, some circuits need to be active even when the unit is turned off.	—

Displays		Page
The display is dim.	● Change "Front Display" in the SETUP menu.	43
"12:00 A" is flashing on the unit's display.	● Set the clock.	44
The recording time display, the transfer (dubbing) process display and the displayed recording time of MP3 are different from the actual time.	<ul style="list-style-type: none"> ● The time on the unit's display and the remaining recording time on the screen may be indicated less or more than the actual value. ● In DVD-R or +R, the remaining capacity does not increase even if titles are erased. ● Available recording space on a DVD-RW (DVD-Video format) increases only when the last recorded title is erased. It does not increase if other titles are erased. ● If you repeat recording or editing about 200 times or more, the remaining capacity of the DVD-R or the +R is reduced and then recording or editing may be disabled. ● The time during fast forward and rewind, or the process during transfer (dub) may not be displayed accurately. 	— — — — —
Compared to the actual recorded time, the elapsed time displayed is less.	● The displayed recording/play time is converted from the number of frames at 29.97 frames (equal to 0.999 seconds) to one second. There will be a slight difference between the time displayed and the actual elapsed time (e.g., actual one-hour elapsed time may display as approximately 59 minutes 56 seconds). This does not affect the recording.	—
The tape counter isn't changing.	<ul style="list-style-type: none"> ● The tape counter does not change while playing unrecorded parts. The "second" display changes as follows:  <ul style="list-style-type: none"> ● The unit's display also appears like this if the tape is dirty or damaged. Consult your dealer if this is the case. 	— —
"ooooo" is displayed and the disc cannot be ejected.	<ul style="list-style-type: none"> ● The unit is carrying out the recovery process. Do the following to eject the disc. <ol style="list-style-type: none"> (1) Press [POWER ⏻/⏪] on the main unit to switch to standby. If the unit doesn't switch to standby, press and hold [POWER ⏻/⏪] on the main unit for about 10 seconds. The unit is forcibly switched to standby. (2) The unit may have a problem. While the unit is off, press and hold [■] and [CH, ^] on the main unit at the same time for about 5 seconds. Remove the disc and consult the dealer. 	—

Operation		Page
Cannot operate the TV.	<ul style="list-style-type: none"> ● Change manufacturer code. Some TVs cannot be operated even if you change the code. ● Press [TV/VIDEO] to change the input mode to "TV". 	18 25, 49
Cannot operate the DVD.	<ul style="list-style-type: none"> ● Press [DVD] when operating DVD. 	10
Cannot operate the VHS.	<ul style="list-style-type: none"> ● Press [VHS] when operating VHS. 	10
The remote control doesn't work.	<ul style="list-style-type: none"> ● The remote control code is wrong. Change to the correct code. ● The batteries are depleted. Replace them with new ones. ● Point the remote control at the remote control sensor on the main unit. ● Remove obstacles between the remote control and main unit. ● Don't place the signal sensor in direct sunlight or in areas that may be subject to sunlight exposure. ● If you repeatedly insert discs or turn the unit on and off about 50 times or more, the recording or editing of DVD-R, DVD-RW (DVD-Video format), +R may be disabled. 	18 10 10 – – –
The unit is on but cannot be operated.	<ul style="list-style-type: none"> ● Some operations are prohibited by the disc. ● The unit is warm ("U59" appears on the unit's display). Wait until "U59" disappears. ● One of the unit's safety devices may have been activated. Reset the unit as follows: (1) Press [POWER \odot /I] on the main unit to switch to standby. If the unit doesn't switch to standby, press and hold [POWER \odot /I] on the main unit for about 10 seconds. The unit is forcibly switched to standby. Alternatively, disconnect the AC power supply cord, wait for about 1 minute, then reconnect it. (2) Press [POWER \odot /I] to turn the unit on.	– – –
Cannot eject a disc.	<ul style="list-style-type: none"> ● The unit is recording. ● The unit may have a problem. While the unit is off, hold down [■] and [CH, ^] on the main unit simultaneously for about 5 seconds. Remove the disc and consult the dealer. 	– –
Startup is slow	<ul style="list-style-type: none"> ● Make sure that "Quick Start" is set to "On". Even if "Quick Start" is set to "On", startup is slow if the clock is not set, there was a power failure or the AC plug has just been connected. ● A few dozen seconds after turning on the unit, you can play a disc or start recording to discs other than DVD-RAM. ● Startup takes time for a few minutes after 4:00 a.m. due to system maintenance of this unit. 	41 – –
Takes time to read DVD-RAM	<ul style="list-style-type: none"> ● It may take time to read a disc if it is being used for the first time in this unit or it has not been used for a long time. 	–

Picture		Page
TV reception worsens after connecting the unit.	<ul style="list-style-type: none"> ● This can occur because the signals are being divided between the unit and other equipment. It can be solved by using a signal booster, available from audio-visual suppliers. 	–
The images from the unit do not appear on the TV.	<ul style="list-style-type: none"> ● Make sure that the TV is connected to the VIDEO OUT terminal, S-VIDEO OUT terminal or COMPONENT VIDEO OUT terminals on the unit. 	12, 14
Picture is distorted.	<ul style="list-style-type: none"> ● Make sure that the TV's input setting (e.g., VIDEO 1) is correct. ● The TV isn't compatible with progressive signals. Press and hold [CANCEL] on the remote control or press and hold [■] and [▶ DVD, DUBBING] at the same time on the main unit until the picture is displayed correctly. The setting will change to interlace. ● Make sure that progressive output has not been selected when the connected TV is not progressive compatible. Press and hold [CANCEL] until the picture displays correctly. The setting will return 480i. 	– – –

Recording, Scheduled recording, Transfer (dubbing), External input		Page
Scheduled recording does not work properly.	<ul style="list-style-type: none"> When connected to cable TV box or satellite receiver, the VCR Plus+ system does not work. The scheduled recording program is incorrect or different scheduled recording times overlap. Correct the program. 	– 29, 51
VCR Plus+ system does not work properly.	<ul style="list-style-type: none"> The unit is not on schedule recording standby. (“⊖” on the unit’s display is not on.) Press [⏻, DVD/VHS POWER] to turn the unit off and make sure that “⊖” is on. The clock is not correct. Set the clock. Correct the guide channels with “VCR Plus+ Ch. Setting” in the SETUP menu. The same guide channel is set to 2 or more channel positions. Set the guide channel correctly or delete unnecessary channels. Scheduled recording will not be activated during formatting, transfer (dubbing) and other such operations which should not be interrupted when they are being carried out. 	28, 50 44 16 16 –
Scheduled recording does not stop even when [■, STOP] is pressed.	<ul style="list-style-type: none"> Press [■, STOP] and then [ENTER] within 5 seconds to turn “⊖” off. Recording stops. If you start recording immediately after turning on the unit while “Quick Start” is set to “On”, you cannot then stop recording for a few seconds. 	29, 51 41
The scheduled recording program remains even after recording finishes.	<ul style="list-style-type: none"> The scheduled recording program remains if set to daily or weekly. 	29, 51
Cannot transfer (dub) VHS to DVD.	<ul style="list-style-type: none"> The write-protect tab on the cartridge is set to “PROTECT” or the disc is protected with “DISC MANAGEMENT”. Some video tapes on the market (including rental videos) are copy-protected to prevent illegal reproductions. Copy-protected video tapes cannot be properly recorded. You cannot use the transfer (dubbing) function when the FUNCTIONS window, the Scheduled Recording List screen, etc. are displayed. 	30 – –
Cannot transfer (dub) DVD to VHS.	<ul style="list-style-type: none"> A video cassette without the accidental erasure prevention tab is inserted. Use a video cassette with an accidental erasure prevention tab. Some DVDs on the market (including rental DVD) are copy-protected to prevent illegal reproductions. Copy-protected DVDs cannot be properly recorded. You cannot use the transfer (dubbing) function when the FUNCTIONS window, the Scheduled Recording List screen, etc. are displayed. 	46 – –
The sound level after transferring (dubbing) is not equal on DVD and on VHS.	<ul style="list-style-type: none"> The sound level on DVD and VHS may not match depending on the disc. When the sound level in a particular part of the sound source is soft or loud, the sound may be recorded loudly or softly on a video tape. 	–
Stripe-shaped black noise is recorded.	<ul style="list-style-type: none"> The device in playback is interfering with the TV because the device is too close to the TV. Move the device away from the TV. 	–
Cannot record video or sound from the external device.	<ul style="list-style-type: none"> The external device is not correctly connected. The proper external input channel (IN1 or IN2) is not selected. 	57 57

■ DVD

DVD Picture		Page
Status messages do not appear.	<ul style="list-style-type: none"> Select “Automatic” in “Status Messages” in the SETUP menu. 	43
The blue background does not appear.	<ul style="list-style-type: none"> Select “On” in “Blue Background” in the SETUP menu. 	43
The 4:3 aspect ratio picture expands left and right.	<ul style="list-style-type: none"> Use the TV to change the aspect. If your TV does not have that function, set “Progressive” in the Video menu to “Off”. 	39
Screen size is wrong.	<ul style="list-style-type: none"> Check the settings for “TV Type”, “4:3 TV Settings for DVD-Video”, or “4:3 TV Settings for DVD-RAM” in the SETUP menu. 	43
There is a lot of after-image when playing video.	<ul style="list-style-type: none"> Set “MPEG-DNR” in the Video menu to “Off”. 	39
When playing DVD-Video using progressive output, one part of the picture momentarily appears to be doubled up.	<ul style="list-style-type: none"> Set “Progressive” in the Video menu to “Off”. This problem is caused by the editing method or material used on DVD-Video, but should be corrected if you use interlace output. 	39
There is no apparent change in picture quality when adjusted with the Video menu in the on-screen menus.	<ul style="list-style-type: none"> The effect cannot be seen with certain types of video. 	–

DVD Sound		Page
No sound. Low volume. Distorted sound. Cannot hear the desired audio type.	● Check the connections and “Digital Audio Output” settings. Check the input mode on the amplifier if you have connected one.	12–14, 42
	● Press [AUDIO] to select the audio.	21, 25
	● Set “V.S.S.” in the Audio menu to “Off” in the following cases. - When using discs that do not have surround sound effects such as Karaoke discs. - When playing MTS broadcast titles. ● The disc may have a restriction on the method of audio output. Refer to the disc’s jacket.	39 –
Cannot switch audio.	● You cannot change the audio type when a DVD-R, a DVD-RW (DVD-Video format) or a +R is in the disc tray.	–
	● You cannot change the audio type when playing a DVD-R, a DVD-RW (DVD-Video format) or a +R. (You can select “Main” or “Secondary Audio Program (SAP)” in “Select MTS” in the SETUP menu before recording.)	42
	● You have used a digital connection. Set “Dolby Digital” to “PCM” or connect using audio cables (analog connection).	14, 42
	● There are discs whose audio cannot be changed because of how the disc was created.	–

DVD Play		Page
Play fails to start even when [▶, PLAY] is pressed. Play starts but then stops immediately.	● Insert the disc correctly with the label facing up.	8
	● The disc is dirty.	8
	● You tried to play a blank disc or a disc that is unplayable on the unit.	6, 7
	● You tried to play a +RW that needs to be finalized on the equipment used for recording.	–
	● When recording to DVD-RAM using EP (8H) mode, play may not be possible on DVD players that are compatible with DVD-RAM. In this case use EP (6H) mode.	41
Audio and video momentarily pause.	● This occurs between playlist chapters.	–
	● This occurs as scenes change during Quick View.	20
DVD-Video is not played.	● Some DVD-Video cannot be played when you change the ratings level.	41
Alternative sound track and subtitles cannot be selected.	● Multiple languages are not recorded on the disc.	–
	● You may have to use the disc’s own menus to select languages.	20
No subtitles.	● When progressive output is on, closed captions cannot be displayed.	–
	● Subtitles are not recorded on the disc.	–
	● Set “Subtitle” in the Disc menu to “On”.	38
Angle cannot be changed.	● This function depends on software availability. Angles can only be changed during scenes where different angles are recorded.	–
You have forgotten your ratings password.	● With the tray open, keep pressing [●, REC] and [▶/×1.3] on the main unit simultaneously for about 5 or more seconds.	–
Quick View does not work.	● This does not work when audio is other than Dolby Digital.	–
	● This does not work while recording.	–
The resume play function does not work.	● Memorized positions are canceled when the unit is turned off or when the tray is opened.	–

DVD Recording, scheduled recording		Page
Cannot record.	● You haven’t inserted a disc or the disc you inserted cannot be recorded on. Insert a disc the unit can record onto.	6
	● The disc is unformatted. Format the disc. (RAM -RW(V))	31
	● The write-protect tab on the cartridge is set to “PROTECT” or the disc is protected with “DISC MANAGEMENT”.	30
	● Some programs have limitations on the number of times they can be recorded (CPRM).	6, 58
	● The disc is full or nearly full. Erase unneeded titles or use another disc.	21, 30, 33
	● You cannot record on finalized DVD-R, DVD-RW (DVD-Video format), +R or DVD-RW (DVD Video Recording format) discs.	31
	● If you repeatedly insert discs or turn the unit on and off about 50 times or more, the recording or editing of DVD-R, DVD-RW (DVD-Video format), +R may be disabled.	–
	● A DVD-R, DVD-RW (DVD-Video format), +R recorded on the unit may not be recordable on other Panasonic DVD recorders.	–
	● The material you are trying to record is copy-protected.	–
	A part or whole of a recorded title has been lost.	● If the power shuts down or the plug is disconnected from the household AC outlet while recording or editing, the program may be lost or the disc may become unusable. We cannot offer any guarantee regarding lost titles or discs. You will have to format the disc (RAM -RW(V)) or use a new disc.
The DV automatic recording function does not work.	● If images cannot be recorded or if the recording is aborted, check the connections and DV equipment settings.	57
	● You cannot start recording until the images from the DV equipment appear on the TV.	–
	● Recording may not be performed as desired if the time codes on the tape in the DV equipment are not successive.	–
	● Depending on the equipment, the DV automatic recording may not operate properly.	–

DVD Edit

		Page
Cannot format.	• The disc is dirty. Wipe with a damp cloth and then wipe dry.	8
	• You tried formatting a disc that is not compatible with the unit.	7
Cannot create chapters.	• The unit writes the chapter division information to the disc when you turn it off or remove the disc. The information is not written if there is an interruption in the power before this.	–
	• These operations are not possible with still pictures.	–
Cannot erase chapters.	• When the chapter is too short to erase, use “Combine Chapters” to make the chapter longer.	35
The available recording time doesn't increase even after erasing recordings on the disc.	• Available recording space on the DVD-R or the +R does not increase even after erasing previously recorded titles.	–
	• Available recording space on a DVD-RW (DVD-Video format) increases only when the last recorded title is erased. It does not increase if other titles are erased.	–

■ VHS

VHS Picture

		Page
OSD messages do not appear.	• Go to “Display” and select “Automatic” in “Status Messages”.	43
	• Press [STATUS] to show the on-screen messages constantly.	53
The blue background appears during play.	• You are playing a blank or poor quality part of the tape.	–
	• You can damage the unit if you play dirty or damaged tapes and this can cause the blue background to appear. Consult your dealer.	–
Picture is distorted.	• When the unit starts making a scheduled recording on the DVD during VHS playback, some picture distortion may occur. This does not indicate a problem with the unit.	–
Cannot see the picture.	• When the TV is connected to the DVD PRIORITY output terminal on this unit, you cannot watch pictures played back on VHS while recording, or making a scheduled recording, on the DVD. Connect to the DVD/VHS COMMON output terminals to be able to watch pictures played back on VHS.	14

VHS Sound

		Page
Cannot hear the desired audio type.	• Press [AUDIO] to select the audio.	53
There is noise when playing a video tape.	• Adjust the tracking.	48
	• The tape is old or damaged.	–

VHS Play

		Page
Cannot play.	• Tapes recorded under a TV system other than NTSC (PAL, SECAM, etc.) cannot be played.	–
The playback screen flickers.	• The video head is dirty.	–
	• The tape is too old or damaged.	–

VHS Recording, scheduled recording

		Page
“⊖” flashes when I try to start recording. Cannot record.	• The erasure prevention tab has been removed. Cover the hole with adhesive tape.	46
	• Insert a video cassette.	46
Cannot record TV program.	• The desired channel is not selected. Select the desired TV program.	49, 50

Product Service

- Damage requiring service** — The unit should be serviced by qualified service personnel if:
 - The AC power supply cord or AC adaptor has been damaged; or
 - Objects or liquids have gotten into the unit; or
 - The unit has been exposed to rain; or
 - The unit does not operate normally or exhibits a marked change in performance; or
 - The unit has been dropped or the cabinet damaged.
- Servicing** — Do not attempt to service the unit beyond that described in these operating instructions. Refer all other servicing to authorized servicing personnel.
- Replacement parts** — When parts need replacing ensure the servicer uses parts specified by the manufacturer or parts that have the same characteristics as the original parts. Unauthorized substitutes may result in fire, electric shock, or other hazards.
- Safety check** — After repairs or service, ask the servicer to perform safety checks to confirm that the unit is in proper working condition.

■ Product information

For product information or assistance with product operation:

In the U.S.A., refer to “Customer Services Directory” on page 66.

In Canada, contact the Panasonic Canada Inc. Customer Care Centre at 1-800-561-5505, or visit the website (www.panasonic.ca), or an authorized Servicentre closest to you.

The model number and serial number of this product can be found on either the back or the bottom of the unit. Please note them in the space provided below and keep for future reference.

MODEL NUMBER _____ DMR-ES40V
 SERIAL NUMBER _____

User memo:

DATE OF PURCHASE _____
 DEALER NAME _____
 DEALER ADDRESS _____

 TELEPHONE NUMBER _____

Reference

Limited Warranty (ONLY FOR U.S.A.)

**Panasonic Consumer Electronics Company,
Division of Panasonic Corporation of North America**
One Panasonic Way, Secaucus, New Jersey 07094

Panasonic Puerto Rico, Inc.
Ave. 65 de Infantería, Km. 9.5
San Gabriel Industrial Park, Carolina, Puerto Rico 00985

Panasonic DVD Recorder Limited Warranty

Limited Warranty Coverage

If your product does not work properly because of a defect in materials or workmanship, Panasonic Consumer Electronics Company or Panasonic Puerto Rico, Inc. (collectively referred to as "the warrantor") will, for the length of the period indicated on the chart below, which starts with the date of original purchase ("warranty period"), at its option either (a) repair your product with new or refurbished parts, or (b) replace it with a new or a refurbished product. The decision to repair or replace will be made by the warrantor.

Product or Part Name	Parts	Labor
DVD Recorder	One (1) Year	One (1) Year
Rechargeable Batteries, DVD-RAM Disc (in exchange for defective item)	Ten (10) Days	Not Applicable

During the "Labor" warranty period there will be no charge for labor. During the "Parts" warranty period, there will be no charge for parts. You must carry-in or mail-in your product during the warranty period. If non-rechargeable batteries are included, they are not warranted. This warranty only applies to products purchased and serviced in the United States or Puerto Rico. This warranty is extended only to the original purchaser of a new product which was not sold "as is". A purchase receipt or other proof of the original purchase date is required for warranty service.

Carry-In or Mail-In Service

For Carry-In or Mail-In Service in the United States call 1-800-211-PANA (7262) or visit Panasonic Web Site: <http://www.panasonic.com>
For assistance in Puerto Rico call Panasonic Puerto Rico, Inc. (787)-750-4300 or fax (787)-768-2910.

Limited Warranty Limits And Exclusions

This warranty ONLY COVERS failures due to defects in materials or workmanship, and DOES NOT COVER normal wear and tear or cosmetic damage. The warranty ALSO DOES NOT COVER damages which occurred in shipment, or failures which are caused by products not supplied by the warrantor, or failures which result from accidents, misuse, abuse, neglect, mishandling, misapplication, alteration, faulty installation, set-up adjustments, misadjustment of consumer controls, improper maintenance, power line surge, lightning damage, modification, or commercial use (such as in a hotel, office, restaurant, or other business), rental use of the product, service by anyone other than a Factory Servicenter or other Authorized Servicer, or damage that is attributable to acts of God.

THERE ARE NO EXPRESS WARRANTIES EXCEPT AS LISTED UNDER "LIMITED WARRANTY COVERAGE". THE WARRANTOR IS NOT LIABLE FOR INCIDENTAL OR CONSEQUENTIAL DAMAGES RESULTING FROM THE USE OF THIS PRODUCT, OR ARISING OUT OF ANY BREACH OF THIS WARRANTY. (As examples, this excludes damages for lost time, travel to and from the servicer, loss of media or images, data or other recorded content. The items listed are not exclusive, but are for illustration only.) **ALL EXPRESS AND IMPLIED WARRANTIES, INCLUDING THE WARRANTY OF MERCHANTABILITY, ARE LIMITED TO THE PERIOD OF THE LIMITED WARRANTY.**

Some states do not allow the exclusion or limitation of incidental or consequential damages, or limitations on how long an implied warranty lasts, so the exclusions may not apply to you.

This warranty gives you specific legal rights and you may also have other rights which vary from state to state. If a problem with this product develops during or after the warranty period, you may contact your dealer or Servicenter. If the problem is not handled to your satisfaction, then write to the warrantor's Consumer Affairs Department at the addresses listed for the warrantor.

PARTS AND SERVICE WHICH ARE NOT COVERED BY THIS LIMITED WARRANTY ARE YOUR RESPONSIBILITY.

Customer Services Directory

Obtain Product Information and Operating Assistance; locate your nearest Dealer or Servicenter; purchase Parts and Accessories; or make Customer Service and Literature requests by visiting our Web Site at:

<http://www.panasonic.com/consumersupport>

or, contact us via the web at:

<http://www.panasonic.com/contactinfo>

You may also contact us directly at:

1-800-211-PANA (7262),
Monday-Friday 9 am-9 pm; Saturday-Sunday 10 am-7 pm, EST.

For hearing or speech impaired TTY users, TTY : 1-877-833-8855

Accessory Purchases

Purchase Parts, Accessories and Instruction Books online for all Panasonic Products by visiting our Web Site at:

<http://www.pasc.panasonic.com>

or, send your request by E-mail to:

npcparts@us.panasonic.com

You may also contact us directly at:

1-800-332-5368 (Phone) 1-800-237-9080 (Fax Only) (Monday – Friday 9 am to 8 pm, EST.)

Panasonic Services Company
20421 84th Avenue South, Kent, WA 98032

(We Accept Visa, MasterCard, Discover Card, American Express, and Personal Checks)

For hearing or speech impaired TTY users, TTY : 1-866-605-1277

Service in Puerto Rico

Panasonic Puerto Rico, Inc.

Ave. 65 de Infantería, Km. 9.5, San Gabriel Industrial Park, Carolina, Puerto Rico 00985

Phone (787)750-4300, Fax (787)768-2910

Reference

Limited Warranty (ONLY FOR CANADA)

Panasonic Canada Inc.

PANASONIC PRODUCT – LIMITED WARRANTY

Panasonic Canada Inc. warrants this product to be free from defects in material and workmanship and agrees to remedy any such defect for a period as stated below from the date of original purchase.

Panasonic DVD Recorder One (1) year, parts and labour

In-home Service will be carried out only to locations accessible by roads and within 50 km of an authorized Panasonic service facility.

LIMITATIONS AND EXCLUSIONS

This warranty does not apply to products purchased outside Canada or to any product which has been improperly installed, subjected to usage for which the product was not designed, misused or abused, damaged during shipping, or which has been altered or repaired in any way that affects the reliability or detracts from the performance, nor does it cover any product which is used commercially. Dry cell batteries are also excluded from coverage under this warranty.

This warranty is extended to the original end user purchaser only. A purchase receipt or other proof of date of original purchase is required before warranty service is performed.

THIS EXPRESS, LIMITED WARRANTY IS IN LIEU OF ALL OTHER WARRANTIES, EXPRESS OR IMPLIED, INCLUDING ANY IMPLIED WARRANTIES OF MERCHANTABILITY AND FITNESS FOR A PARTICULAR PURPOSE.

IN NO EVENT WILL PANASONIC CANADA INC. BE LIABLE FOR ANY SPECIAL, INDIRECT OR CONSEQUENTIAL DAMAGES.

In certain instances, some jurisdictions do not allow the exclusion or limitation of incidental or consequential damages, or the exclusion of implied warranties, so the above limitations and exclusions may not be applicable.

WARRANTY SERVICE

FOR PRODUCT OPERATION ASSISTANCE, please contact:

Our Customer Care Centre:	Telephone #:	(905) 624-5505
	1-800 #:	1-800-561-5505
	Fax #:	(905) 238-2360
	Email link:	"Contact Us" on www.panasonic.ca

FOR PRODUCT REPAIRS, please locate your nearest Authorized Servicentre at www.panasonic.ca :

Link : "Servicentres™ locator" under "Customer support"

Panasonic Factory Service:

<u>Richmond, British Columbia</u>	<u>Mississauga, Ontario</u>
Panasonic Canada Inc.	Panasonic Canada Inc.
12111 Riverside Way	5770 Ambler Drive
Richmond, BC V6W 1K8	Mississauga, ON L4W 2T3
Tel: (604) 278-4211	Tel: (905) 624-8447
Fax: (604) 278-5627	Fax: (905) 238-2418

IF YOU SHIP THE PRODUCT TO A SERVICENTRE

Carefully pack and send prepaid, adequately insured and preferably in the original carton.
Include details of the defect claimed, and proof of date of original purchase.

Reference

Specifications

■ **Power Supply:** AC 120 V, 60 Hz
■ **Power Consumption:** 29 W

■ **Recording system:** DVD Video Recording format (DVD-RAM)
DVD-Video format (DVD-R)
DVD-Video format (DVD-RW)

■ **Recordable discs:**
DVD-RAM:
Ver. 2.0
Ver. 2.1/3×-SPEED DVD-RAM Revision 1.0
Ver. 2.2/5×-SPEED DVD-RAM Revision 2.0
DVD-R:
for General Ver. 2.0
for General Ver. 2.0/4×-SPEED DVD-R Revision 1.0
for General Ver. 2.x/8×-SPEED DVD-R Revision 3.0
DVD-RW:
Ver. 1.1
Ver. 1.1/2×-SPEED DVD-RW Revision 1.0
Ver. 1.2/4×-SPEED DVD-RW Revision 2.0
+R:
Ver. 1.0
Ver. 1.1
Ver. 1.2

■ **Recording time:** Max. 8 hours (using 4.7 GB disc)
XP: 60 minutes, SP: 120 minutes
LP: 240 minutes, EP: 360 minutes or
480 minutes

■ **Playable discs:** DVD-RAM, DVD-R, DVD-RW, +R, +RW,
DVD-Video, CD-Audio (CD-DA), Video CD,
CD-R/CD-RW (CD-DA, Video CD, MP3,
JPEG formatted discs)

■ **Optical pick-up:** System with 1 lens, 2 integration units
(662 nm wavelength for DVDs,
780 nm wavelength for CDs)

■ LASER Specification

Class 1 LASER Product

Wave Length: 780 nm (CDs), 662 nm (DVDs)
Laser Power: No hazardous radiation is emitted with the
safety protection

■ Video system

TV system: NTSC system, 525 lines, 60 fields
Recording system: MPEG2 (Hybrid VBR)
Input: LINE (pin jack) × 2: 1.0 Vp-p; 75 Ω
S connector × 2: Y: 1.0 Vp-p; 75 Ω
C: 0.286 Vp-p; 75 Ω
Output: LINE (pin jack) × 2: one is DVD PRIORITY
1.0 Vp-p; 75 Ω
S connector × 1: DVD PRIORITY
Y: 1.0 Vp-p; 75 Ω
C: 0.286 Vp-p; 75 Ω

**Component video
output (480p/480i):** DVD PRIORITY
Y: 1.0 Vp-p; 75 Ω
PB: 0.7 Vp-p; 75 Ω
PR: 0.7 Vp-p; 75 Ω

D-connector output: Not provided

Antenna reception

input: TV Channel: 2 ch to 69 ch, 75 Ω
CATV Channel: 1 ch to 125 ch, 75 Ω

RF converter output: CH3 or CH4, 75 Ω

■ Audio system

Recording system: Dolby Digital (XP/SP/LP/EP)
Input: LINE (pin jack) × 2
Reference input: 309 mVrms
FS: 2 Vrms (1 kHz, 0 dB)
Input impedance: 22 kΩ
Output: LINE (pin jack) × 2: one is DVD PRIORITY
Reference output: 309 mVrms
FS: 2 Vrms (1 kHz, 0 dB)
Output impedance: 1 kΩ
(Load impedance: 10 kΩ)

**Number of
channels:** Recording: 2 channels
Playback: 2 channels

**Other input/output
connectors:** Digital audio optical output connector

■ **Dimensions:** Approx. 430 mm (W) × 89 mm (H) × 353 mm (D)
[Approx. 16^{15/16}" (W) × 3^{8/16}" (H) × 13^{14/16}" (D)]
Approx. 5.4 kg (12.0 lbs.)

Mass:
**Operating
temperature range:** 5 °C to 40 °C (41 °F to 104 °F)

**Operating humidity
range:** 35% to 80% RH (no condensation)
Clock unit: Quartz-controlled 12-hour digital display

Power consumption Standby mode: Approx. 10 W

■ **DV Input:** IEEE 1394 Standard (4 pin)

Note

Mass and dimensions shown are approximate.
Specifications are subject to change without notice.

Reference

Index

COMMON

Antenna System	16
Channel	
adding, deleting	16
audio (DVD)	38
Auto Channel Setting	16
captions	17
guide channel VCR Plus+ system	16
Cleaning	
disc, lens, main unit	8
video heads	46
Clock setting	44
Connection	
amplifier, system component	14
antenna	13
antenna, television	12
cable TV box/satellite receiver	13
external device	57
On-screen Language	43
Quick Start	8, 41
Status displays	45, 53
TV Type	19
VCR Plus+ system	
guide channel	16
scheduled recording (DVD)	28
scheduled recording (VHS)	50

DVD

Angle	38
Audio	
attributes	38
channel	38
playback	21
receiving, recording	25
Change Thumbnail	34
Chasing play	26
CM Skip	21
CPRM system	6, 58
Create chapters	21, 35
Dialog Enhancer	39
Direct Navigator	33
Display menus	38
DV Automatic Recording	27
Enter Name	
disc	30
operation	32
title	28, 29, 34
Erase	
chapter	35
title	21, 30, 33
Finalize	31, 58
Flexible Recording	25
Format disc	31
FUNCTIONS window	45
Language	
audio	41
code list	43
sound track	38
subtitle	38, 41
MP3	22
MPEG-DNR	39
One Touch Transfer (Dub)	55

PCM Down Conversion	42
Picture	39
Progressive	14, 19, 39, 58
Properties	
playlist	37
title	33
Protection	
cartridge	30
disc	30
title	34
Quick View	20
Ratings	40, 41
Recording modes	24
Repeat play	39
Restore Default Settings	41
Scheduled recording	28
SETUP menu	40
Simultaneous recording and play	26
Sound track	38
Subtitle	38, 41
Time Slip	21, 26
Transfer	39
TV Type	19
V.S.S.	39

VHS

Audio	53
Auto Bilingual Choice	53
Auto SP/EP mode	51
Intact erasure prevention tab	46
Jet Rewind	47
On-screen display	53
One Touch Transfer (Dub)	56
Remaining tape time	53
Repeat Playback	48
Scheduled recording	50
SQPB	48
Tracking	48
VISS	52
VP mode	49

Cómo empezar

• Antes de conectar, apague todo equipo y lea las instrucciones correspondientes de funcionamiento.

Referencia

- Las conexiones del equipo descritas sirven en concepto de ejemplo.
- Los equipos periféricos y los cables opcionales se venden por separado si no está indicado de otro modo.

Conexión con un televisor y un VCR

— indica los accesorios incluidos.
 - - - indica los accesorios no incluidos.

-  Rojo
-  Blanco
-  Amarillo

Conexión (sin cable audio/vídeo)

Conecte por orden numérico de ① a ④.

La unidad envía una señal al televisor a través del cable coaxial de 75 Ω en el canal 3 o 4. Es posible ver la imagen de vídeo en su televisor de la misma manera que la que ve en los programas TV.

- Después de esta conexión, ajuste el canal de salida RF "CH3" o "CH4" (→ 71).

Conexión (con cable audio/vídeo)

Conecte por orden numérico de ① a ④.

- Conecte por orden numérico, ajuste "OFF" del canal de salida RF (→ 71).

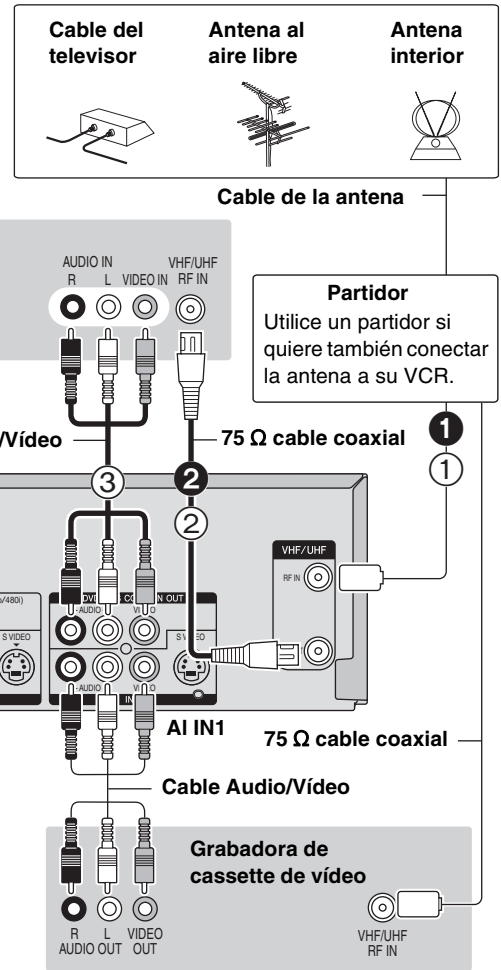
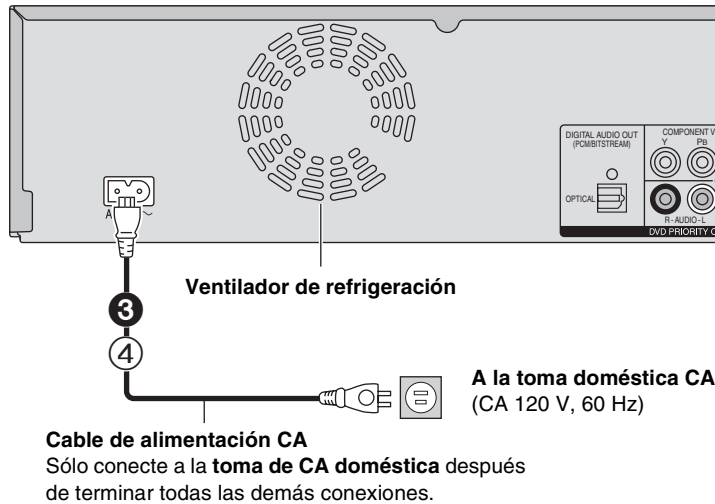

Conexión al terminal S-VIDEO IN

Terminal S-VIDEO OUT

El terminal S-VIDEO OUT hace conseguir una imagen más nítida que el terminal VIDEO OUT. (Los resultados reales dependen del televisor.)

- 1) Terminales de entrada de audio (L/R)
- 2) Terminal de entrada S-Vídeo
- 3) Cable de audio (no suministrado)
 - A Rojo (R)
 - B Blanco (L)
- 4) Cable S-Vídeo (no suministrado)
- 5) Panel trasero de la unidad
- 6) Terminales de salida de audio (L/R)
- 7) Terminal de salida S-Vídeo

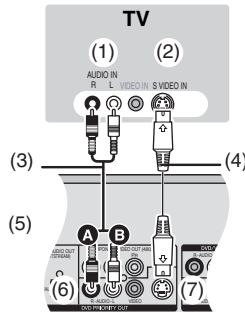

Conexión a los terminales COMPONENT VIDEO IN

Terminales COMPONENT VIDEO OUT

Estos terminales pueden ser usados para la salida sea entrelazada sea progresiva y para proporcionar una imagen más nítida que el terminal de S-VIDEO OUT.

- Conecte a los terminales del mismo color.

- 1) Terminales de entrada componente
- 2) Terminales de entrada de audio (L/R)
- 3) Cable de vídeo del componente (no suministrado)
- 4) Cable de audio (no suministrado)
 - A Rojo (R)
 - B Blanco (L)
- 5) Panel trasero de la unidad
- 6) Terminales COMPONENT VIDEO OUT
- 7) Terminales de salida de audio (L/R)

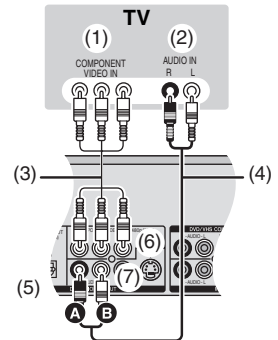

Cuando la unidad no ha de ser usada durante un largo tiempo

Para ahorrar energía, desenchúfela de la toma doméstica CA. Esta unidad consume una pequeña cantidad de corriente aun cuando está apagada.

Consumo de corriente en la espera

		Visualización frontal	
		Automático	Alta
Accionamiento rápido	Act	Aprox. 9 W	Aprox. 11 W
	Des	Aprox. 2,1 W	Aprox. 2,1 W

Accionamiento rápido

Inicio rápido de 1 s. para grabar en el DVD-RAM*

* Cuando la unidad está apagada, pulsar [⏻, DVD/VHS POWER] y después [●, REC] (Modo de Accionamiento rápido).

La grabación en el DVD-RAM inicia cerca de 1 segundo después de pulsar estas teclas.

Cómo empezar

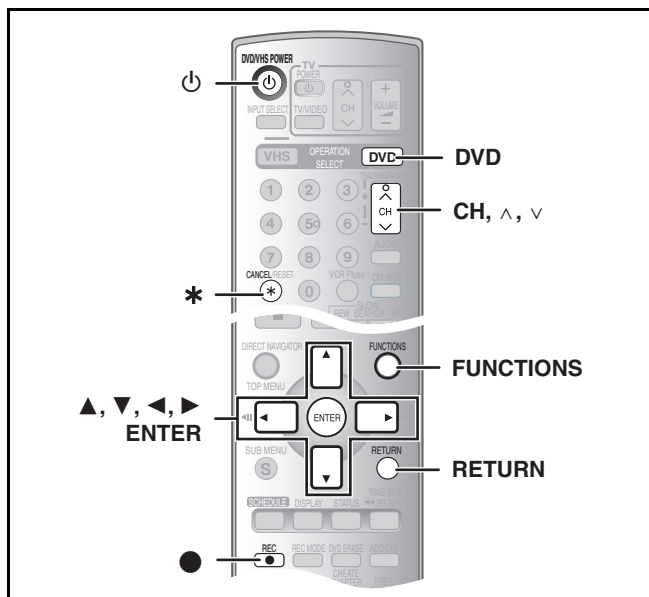

Sintonización automática por enchufe

Operaciones preliminares

- Pulse [DVD].
- Encienda el televisor y seleccione la entrada de vídeo correspondiente para conformar las conexiones a esta unidad. (Por ejemplo: la entrada AV, CH3 o CH4)
- Si conecta la unidad a una caja del televisor de cable o a un receptor de satélite, sintonice su PBS local para que funcione el ajuste automático del reloj. Si no hay PBS local, ajuste el reloj manualmente ("Ajustar manualmente el reloj").

1 Pulse [DVI, DVD/VHS POWER].

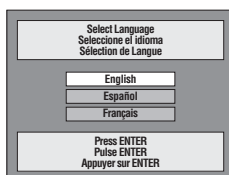

2 Pulse [CH, ^, v] para seleccionar un número de canal de salida RF.

Conexión (sin cable audio/vídeo):
 Seleccione "CH3" o "CH4" que visualiza la pantalla a la derecha.

Conexión (con cable audio/vídeo):
 Seleccione "OFF".

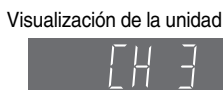

Visualización de la unidad

Cada vez que pulsa la tecla:

CH 3 (ajuste predeterminado) ↔ CH4 ↔ OFF

3 Utilice [▲, ▼] para seleccionar el idioma y pulse [ENTER].

4 Pulse [ENTER] para iniciar la sintonización automática por enchufe.

- Luego, la unidad procede al ajuste automático del reloj. El temporizador se visualiza cuando finaliza.

5 Pulse [ENTER].

Si el reloj adelanta o atrasa una hora respecto a la hora actual
 Seleccione "-1" o "+1" en "Ajustar del huso horario" en el menú SETUP.

Si la unidad no puede ajustar automáticamente el reloj
 Ajuste la hora manualmente. ("Ajustar manualmente el reloj")

Ajustes del canal de guía para el sistema VCR Plus+

Ajuste estos canales de guía de manera que se pueda usar el sistema VCR Plus+® para la grabación temporizada. Antes de proceder a los ajustes, prepare el papel que muestra los nombres de las estaciones, los canales de guía y los números de los canales.

por ej.:

Nombre de la estación	Canal de guía*	Número del canal**	Ajuste del canal
CBS	04	04	Innecesario
HBO	33	15	Introduzca el canal 15 sucesivo al canal de guía 33.
Nickelodeon	38	20	Introduzca el canal 20 sucesivo al canal de guía 38.

* Mire en los canales de guía para las estaciones en revistas.

** Apunte todas las estaciones que puede recibir.

- Si ha conectado una caja de televisor de cable o un receptor de satélite, el sistema VCR Plus+ no funciona, así que no debe ajustar los canales de guía.

- 1 Durante la parada Pulse [FUNCTIONS].
- 2 Seleccione "Otras funciones" con [▲, ▼] y pulse [ENTER].
- 3 Seleccione "SETUP" con [▲, ▼] y pulse [ENTER].
- 4 Seleccione "Canal" con [▲, ▼] y pulse [◀, ▶].
- 5 Seleccione "VCR Plus+ Ajuste canal" con [▲, ▼], luego pulse [ENTER].
- 6 Utilice [▲, ▼] para seleccionar el canal de guía que quiere ajustar y pulse [▶].
- 7 Utilice [▲, ▼] para seleccionar el canal correspondiente al de guía y pulse [◀].
 - Para borrar un número, pulse [CANCEL/RESET, *].
 - Repita los pasos 6 y 7 para introducir otros canales.
- 8 Pulse [ENTER].

Selección del tipo de televisor

No debe cambiar el ajuste cuando está conectado a un televisor que tiene el aspecto estándar de 4:3 y no es compatible con la salida progresiva.

- 1 Durante la parada Pulse [FUNCTIONS].
- 2 Seleccione "Otras funciones" con [▲, ▼] y pulse [ENTER].
- 3 Seleccione "SETUP" con [▲, ▼] y pulse [ENTER].
- 4 Seleccione "Pantalla TV" con [▲, ▼] y pulse [◀, ▶].
- 5 Seleccione "Tipo TV" con [▲, ▼], luego pulse [ENTER].

- Aspecto 4:3/Aspecto 16:9:



- 480p/480i:

Seleccione "480p" si el televisor es compatible con la salida progresiva.

6 Utilice [▲, ▼] para seleccionar el detalle, luego pulse [ENTER].

- Cuando está seleccionada una salida progresiva aparece una pantalla de confirmación con las instrucciones que seguir.

Para volver a la pantalla anterior

Pulse [RETURN].

Para salir de la pantalla

Pulse varias veces [RETURN].

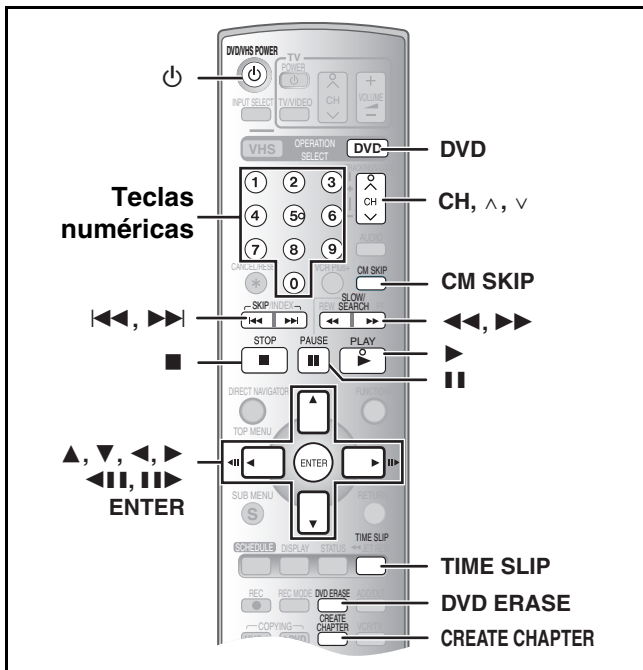

Introducción de discos

- 1 Pulse [**▲**, OPEN/CLOSE] en la unidad principal para abrir la bandeja.
 - Puede Ud. insertar un disco de cartucho o sin cartucho.
- 2 Pulse [**▲**, OPEN/CLOSE] en la unidad principal para cerrar la bandeja.

Nota

- Tiene que cargarse un disco de doble cara con el lado que quiere grabar/reproducir mirando hacia abajo.
- No es posible grabar continuamente de un lado de un disco de doble cara al otro. Es necesario que se expulse el disco y se lo revuelva.
- Cuando utiliza un DVD-RAM de 8 cm (3") o DVD-R de 8 cm (3"), quite el disco del cartucho.

Disco sin cartucho

Disco de cartucho

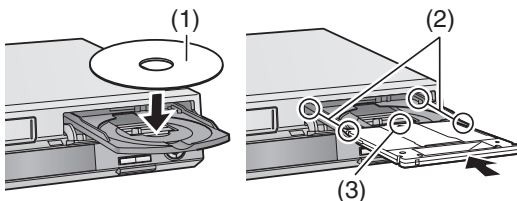

- (1) Inserte etiqueta arriba.
- (2) Insértelo completamente en su lugar hasta que haga un ruido seco.
- (3) Insertar el disco con la etiqueta hacia arriba y la flecha hacia el interior.

Reproducción de los discos

Operaciones preliminares

- Encienda el televisor y seleccione la entrada de vídeo correspondiente para conformar las conexiones a esta unidad.
- Pulse [DVD].

RAM -R -RW(V) +R DVD-V -RW(VR) VCD CD

- 1 Pulse [**⏻**, DVD/VHS POWER] para encender la unidad.
- 2 Inserte un disco. (→ arriba)
- 3 Pulse [**▶**, PLAY].
 - La bandeja se cierra y comienza la reproducción. (La unidad emplea un tiempo para la adquisición de los datos del disco antes de comenzar la reproducción.)
 - La reproducción inicia desde el último título grabado.

RAM -R -RW(V) +R -RW(VR)
 - La reproducción inicia a partir del comienzo del disco.

DVD-V VCD CD

Para detener la reproducción

RAM -R -RW(V) +R DVD-V -RW(VR) VCD CD

Durante la reproducción

Pulse [**■**, STOP].

- La posición de parada se memoriza. (Excepto si se reproduce desde el Direct Navigator y cuando se reproduce de una lista.)

Función de reanudación de la reproducción

Pulse [**▶**, PLAY] para reanudar la reproducción desde esta posición.

Posición de parada

- Si se pulsa [**■**, STOP] más veces, la posición se borra.
- La posición se borra si la unidad se apaga o si la bandeja está abierta.

Para interrumpir provisionalmente la reproducción

RAM -R -RW(V) +R DVD-V -RW(VR) VCD CD

Durante la reproducción

Pulse [**⏸**, PAUSE].

- Pulse de nuevo o [**▶**, PLAY] para reiniciar la reproducción.

Cuando en el televisor aparece la pantalla de un menú

VCD

Pulse las teclas numéricas para seleccionar un detalle.

por ej.: "5": [0]→[5] "15": [1]→[5]

DVD-V

Pulse [**▲**, **▼**, **◀**, **▶**] para seleccionar un detalle, luego pulse [ENTER].

- Algunas veces para seleccionar un detalle puede usar las teclas numéricas.

Otros botones usados para hacer funcionar los menús

Lea las instrucciones del disco para más información acerca del funcionamiento.

Nota

- Si aparece "⊘" en el televisor, la unidad o el disco prohíben la operación.

Vista rápida (Reproducción ×1.3)

RAM

Puede ser aumentada la velocidad de reproducción sin distorsionar el audio.



Durante la reproducción

Pulse y mantenga [**▶**, PLAY].

Para volver a la velocidad normal

Pulse [**▶**, PLAY].

Avance rápido y rebobinado — SEARCH

RAM -R -RW(V) +R DVD-V -RW(VR) VCD CD

Durante la reproducción

Pulse [**◀◀**, SLOW/SEARCH] o [**▶▶**, SLOW/SEARCH].

- Hay 5 velocidades de búsqueda. Cada vez que se pulsa la tecla la velocidad de búsqueda aumenta.
- Pulse [**▶**, PLAY] para volver a iniciar la reproducción.



Salto

RAM -R -RW(V) +R DVD-V -RW(VR) VCD CD

Durante la reproducción o mientras está en pausa

Pulse [**◀◀**, SKIP] o [**▶▶**, SKIP].

- Cada presión hace aumentar el número de saltos.

Reproducción de cámara lenta

RAM -R -RW(V) +R (Sólo partes de imagen en movimiento)

DVD-V -RW(VR) VCD

Durante la pausa

Pulse [**◀◀**, SLOW/SEARCH] o [**▶▶**, SLOW/SEARCH].

- Cuando continúa la reproducción de cámara lenta durante cerca de 5 minutos, ella se detiene automáticamente (excepto DVD-V VCD).
- Hay 5 velocidades de reproducción. Cada vez que se pulsa la tecla la velocidad de reproducción aumenta.
- Pulse [**▶**, PLAY] para volver a iniciar la reproducción.
- VCD Sólo dirección en avance ([▶▶], SLOW/SEARCH)).

■ Visión cuadro por cuadro

RAM -R -RW(V) +R (Sólo partes de imagen en movimiento)
DVD-V -RW(VR) VCD

Durante la pausa

Pulse [**◀▶▶**] (**[◀]**) o [**▶▶▶**] (**[▶]**).

- Cada vez que se pulsa aparece el cuadro siguiente o el anterior.
- Mantenga pulsado para cambiar sucesivamente hacia delante o hacia atrás.
- Pulse [**▶**, **PLAY**] para volver a iniciar la reproducción.
- **VCD** Sólo dirección en avance (**[▶▶▶]**, **[▶]**).

■ Reproducción directa

RAM -R -RW(V) +R DVD-V -RW(VR) VCD CD

Puede reproducir desde el título, capítulo o pista que selecciona.

Durante la reproducción

Pulse las teclas numéricas para seleccionar el detalle.

CD (Sólo disco MP3 y JPEG)

por ej.: "5": [0]→[5] "5": [0]→[0]→[5]
 "15": [1]→[5] "15": [0]→[1]→[5]

- Éste sólo funciona con algunos discos cuando está parada (está visualizado el salva pantalla → a la derecha).

Salva pantalla



■ Borrado de un título que se está reproduciendo

RAM -R -RW(V) +R

Una vez borrado el título no puede ser restablecido. Asegúrese antes de proceder.

1 Durante la reproducción

Pulse [**DVD ERASE**].

2 Pulse [**◀**] para seleccionar "Borrar" y pulse [**ENTER**].

■ Salto CM

RAM -R -RW(V) +R -RW(VR)

Puede saltar por cerca de 1 minuto por cada vez que se pulsa.

Durante la reproducción

Pulse [**CM SKIP**].

■ Crear capítulos

RAM

Durante la reproducción o mientras está en pausa

Pulse [**CREATE CHAPTER**].

- Pulse [**◀◀◀**, **SKIP**] o [**▶▶▶**, **SKIP**] para saltar al comienzo del capítulo.
- No puede activar esta función cuando está ejecutando **TIME SLIP** (→ 75) o envía (copia).

■ Visualización de la imagen TV como imagen en imagen/Selección de la cantidad de tiempo a saltar — Time Slip

RAM -R -RW(V) +R -RW(VR)

Pulse [**TIME SLIP**] durante la reproducción y abajo a la derecha de la pantalla principal se va a visualizar la pantalla (imagen del televisor) del PIP (de imagen en imagen). Puede ver al mismo tiempo tanto la reproducción de imágenes como las imágenes del televisor. En la pantalla principal, puede también acceder inmediatamente a una escena que quiere ver especificando un cierto tiempo que quiere saltar.

1 Durante la reproducción

Pulse [**TIME SLIP**].

- Aparece la pantalla PIP (imágenes del televisor).
- Puede cambiar el canal que está recibiendo pulsando [**CH**, **▲**, **▼**].
- Escuchará el audio de la reproducción de la pantalla principal.

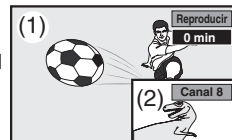

- (1) Imágenes reproducidas
- (2) Imágenes actuales en recepción

2 Mientras observa el indicador del tiempo arriba a la derecha

Pulse [**▲**, **▼**] para ajustar el tiempo a saltar, luego pulse [**ENTER**].

- La reproducción salta por el tiempo que ha especificado.
- El indicador del tiempo se apagará a los 5 segundos aproximadamente, pero ajustando el tiempo volverá a encenderse.

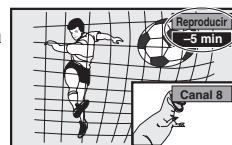

Para despejar la pantalla PIP

Pulse [**TIME SLIP**].

Referencia

- El fondo azul no aparece en la pantalla PIP.
- No se puede cambiar el canal recibido mientras se va grabando.

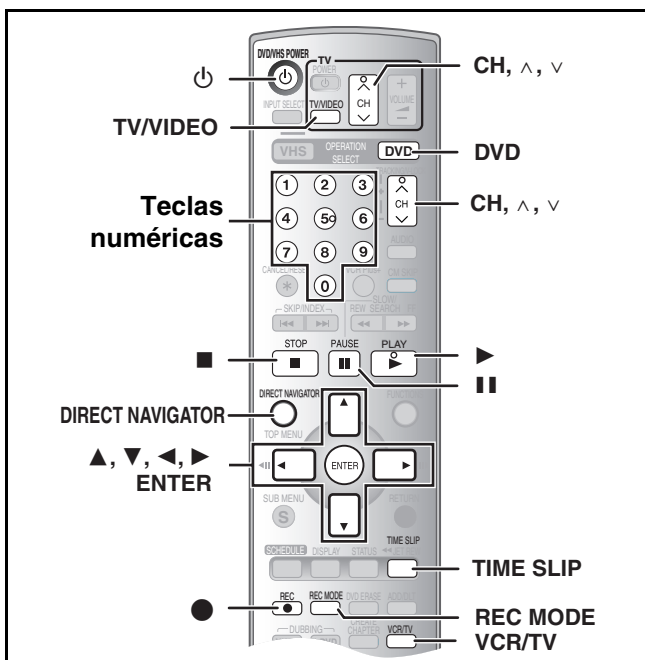

Grabación de programas televisivos

RAM -R -RW(V) +R

- Puede grabar hasta 99 títulos en un disco (49 títulos +R).
- No es posible grabar emisiones digitales que permiten "Grabación sólo una vez" en discos DVD-R, DVD-RW, +R o DVD-RAM de 8 cm (3"). Utilice un DVD-RAM compatible con CPRM.
- La grabación tendrá lugar en un espacio abierto en el disco. Los datos no se sobrescribirán.
- Si no queda espacio en el disco de grabación, será necesario borrar los títulos innecesarios (→ 73) o utilizar un nuevo disco.

Cuando graba en el DVD-R, DVD-RW (formato DVD-Vídeo) o +R

- Cuando graba programas MTS
 - Si no conecte una caja TV de cable
Seleccione "Principal" o "Programa Audio Sec. (SAP)" en "Seleccionar MTS" en el menú SETUP.
 - Si conecte una caja TV de cable
Seleccione "Main" or "SAP" en la caja TV de cable.
- La relación de aspecto de la imagen grabada será 4:3.
- **A fin de reproducir en otra fuente de reproducción un DVD-R, DVD-RW (formato DVD-Vídeo) o +R grabado usando esta unidad, antes el disco ha de ser finalizado.**

Operaciones preliminares

- Quite la protección. **RAM**
- Seleccione un tipo de audio que quiere grabar.
- Pulse [DVD].

1 Pulse [DVD/POWER] para encender la unidad.

2 Inserte un disco. (→ 72)

- Cuando con esta unidad utiliza un DVD-RAM por la primera vez, formáteelo para garantizar una esmerada grabación.

3 Pulse [CH, ^, v] para seleccionar el canal.

Para seleccionar con las teclas numéricas:

Modo Antena (Ondas hertzianas)

por ej.: "5": [0]→[5] "15": [1]→[5]

Modo Cable TV (Cable)

por ej.: "5": [0]→[0]→[5] "15": [0]→[1]→[5]

"115": [1]→[1]→[5]

4 Pulse [REC MODE] para seleccionar el modo de grabación (XP, SP, LP o EP).

5 Pulse [●, REC] para iniciar la grabación.

- No es posible cambiar de canal o el modo durante la grabación. Es posible cambiarlos cuando la grabación se encuentra en pausa, pero el material que sigue se grabará con un título separado.

Para detener temporalmente la grabación

Pulse [||, PAUSE]. (Pulse nuevamente la tecla para reanudar la grabación.)

- El título no puede dividirse en un título separado.
- Puede pulsar también [●, REC] para reiniciar a grabar.

Para detener la grabación

Pulse [■, STOP].

- Grabado como 1 título hasta donde se detiene la posición.
- Una vez terminada la grabación, lleva más o menos 30 segundos para que la unidad complete la información de gestión de la grabación. **-R -RW(V) +R**

■ Modos de grabación y tiempo aproximado de grabación

(Unidad: hora)

	DVD-RAM		DVD-R DVD-RW +R (4,7 GB)
	De un solo lado (4,7 GB)	Doble lado (9,4 GB)	
XP (Alta calidad)	1	2	1
SP (Normal)	2	4	2
LP (Larga duración)	4	8	4
EP (Reproducción de muy larga duración)	8 (6*)	16 (12*)	8 (6*)

- Según el contenido a ser grabado, los tiempos de grabación pueden salir más cortos que los señalados.

* Cuando en el menú SETUP se ha ajustado a "EP-Repr.ón ampliada (6H)" el "Tiempo de grab. en el modo EP".

La calidad del sonido se baja, en comparación con otros modos de grabación, cuando se usa "EP-Repr.ón ampliada (8H)".

■ Indicación del tiempo en que se parará la grabación Durante la grabación

Pulse [●, REC] para seleccionar el tiempo de grabación.

- Se puede también pulsar [●, REC] en la unidad principal.

Visualización de la unidad

Cada vez que pulsa la tecla:

Contador (suprimir) → OFF 0:30 → OFF 1:00 → OFF 1:30

↑ OFF 4:00 ← OFF 3:00 ← OFF 2:00 ←

■ Recepción de las transmisiones televisivas durante la grabación

Operaciones preliminares

- Conexión (sin cable audio/vídeo)
 - Asegúrese de que el indicador TV esté encendido en la visualización de la unidad. Por si no lo estuviese, pulse [VCR/TV] para encenderlo.
- Conexión (con cable audio/vídeo)
 - Pulse [TV/VIDEO] para cambiar el modo de entrada en "TV".

Pulse [CH, ^, v] del televisor para seleccionar los canales TV deseados.

Reproducción durante la grabación

RAM

Reproducción seguida

Es posible empezar la reproducción desde el comienzo de un título mientras lo sigue grabando.

Durante la grabación o la grabación temporizada

Pulse [▶, PLAY].

- La reproducción inicia mientras que procede la grabación.

Grabación y reproducción simultáneas

Puede reproducir un título grabado anteriormente mientras que está grabando otro título.

1 Durante la grabación o la grabación temporizada

Pulse [DIRECT NAVIGATOR].

2 Utilice [▲, ▼, ◀, ▶] para seleccionar el título, luego pulse [ENTER].

- La reproducción inicia mientras que procede la grabación.

Para salir de la pantalla del Direct Navigator

Pulse [DIRECT NAVIGATOR].

TIME SLIP

Pulse [TIME SLIP] mientras que graba; la reproducción inicia a partir de 30 segundos antes de aquel momento. Puede iniciar a reproducir incluso antes indicando en el específico indicador un cierto tiempo a saltar.

1 Durante la grabación o la grabación temporizada

Pulse [TIME SLIP].

- Se visualiza la pantalla PIP (imágenes que se están grabando actualmente).

- En la pantalla principal, la reproducción inicia a partir de 30 segundos antes de aquel momento.

- Escuchará el audio de la reproducción.

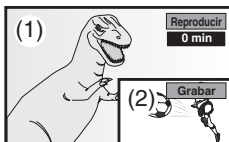

- (1) Reproduce las imágenes (30 segundos antes)
- (2) Imagen que se está grabando actualmente

2 Mientras observa el indicador del tiempo arriba a la derecha

Pulse [▲, ▼] para ajustar el tiempo a saltar, luego pulse [ENTER].

- La reproducción salta por el tiempo que se ha seleccionado.
- El indicador del tiempo se apagará a los 5 segundos aproximadamente, pero ajustando el tiempo volverá a encenderse.



Para visualizar completamente las imágenes de reproducción

Pulse [TIME SLIP].

- Pulse [TIME SLIP] para volver a la pantalla PIP.

Referencia

- Según la escena, la imagen de la pantalla PIP puede resultar distorsionada o bien parpadear. Sin embargo, esto no afecta la imagen grabada.

Para detener la reproducción y la grabación

1 Pulse [■, STOP]. La reproducción se detiene. (Espere 2 segundos o más.)

2 Pulse [■, STOP]. La grabación se detiene.

- No es posible detener la grabación con [■, STOP] durante la grabación temporizada. Para detener la grabación temporizada pulse [■, STOP], luego [ENTER] dentro de 5 segundos.

- Puede también seguir pulsando [■] en la unidad principal durante más de 3 segundos para detener la grabación temporizada.

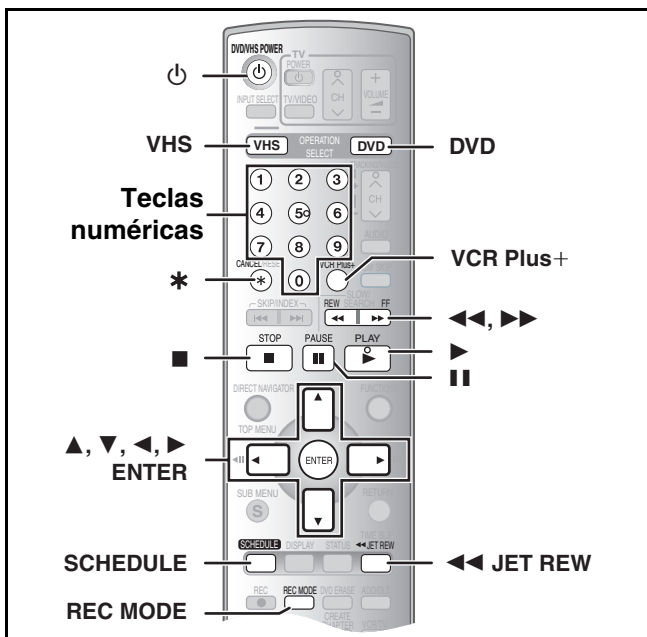

Grabación temporizada

Puede introducir hasta 16 programas con un adelanto de un mes.

Operaciones preliminares

- Quite la protección **RAM**.
- Inserte un disco (→ 72) y asegúrese de que haya bastante espacio vacío para grabarlo encima.
- Controle que el reloj esté ajustado a la hora correcta.
- Pulse [DVD].

■ Uso del sistema VCR Plus+

El introducir los números PlusCode® es una manera sencilla de grabación temporizada. Puede encontrar estos códigos en las guías TV de los periódicos y revistas.

- Cuando conecte una caja TV de cable o un receptor de satélite, el sistema VCR Plus+ no funciona. Programe la grabación temporizada manualmente (→ abajo).

- 1 Pulse [VCR Plus+].**
- 2 Pulse las teclas numéricas para introducir el número PlusCode.**
 - Pulse [◀] para volver a la cifra correcta.
- 3 Pulse [ENTER].**
 - Cerciórese del programa y, si lo necesita, corrija usando [▲, ▼, ◀, ▶]. (→ abajo, paso 2)
- 4 Si el programa es correcto Pulse [ENTER].**
 - Repita los pasos 1–4 para programar otras grabaciones.
- 5 Pulse [SCHEDULE].**
- 6 Pulse [⏻, DVD/VHS POWER].**
 - La grabación temporizada sólo puede ser iniciada cuando la unidad está apagada.
 - La unidad se apaga y en el visualizador de la unidad se enciende “⏻” para señalar que la espera de la grabación temporizada ha sido activada.

■ Programación manual

- Cuando se conecte una caja TV de cable o un receptor de satélite, seleccione el canal en la caja TV de cable o receptor de satélite antes de que comience la grabación temporizada.

- 1 Pulse [SCHEDULE].**
 - Cerciórese de que esté seleccionado “Nueva grabación programada”.
- 2 Pulse [ENTER], luego desplace y cambie los detalles usando [▲, ▼, ◀, ▶].**
 - Pueden usarse las teclas numéricas para introducir “Canal”, “Fecha”, “Act.” y “Des.”.
 - **Canal** (Posición del programa/Nombre de la estación de TV)
 - **Fecha**
Puede crear usted un programa diario o semanal. Todos los programas diarios o semanales se cuentan como un solo programa.

- **Act.** (hora de encendido)/**Des.** (hora final)
Si mantiene pulsado el botón, el tiempo aumentará o disminuirá en incrementos de 30 minutos.
- **Unid.** (Unidad de grabación)
Seleccione la unidad de grabación “DVD”.
- **Modo** (Modo de grabación)
Para cambiar el modo de grabación, puede pulsar también [REC MODE].
XP↔SP↔LP↔EP↔FR↔XP... (→ 74)
- **Nombre tít.**
Pulse [◀, ▶] para seleccionar “Nombre tít.” luego pulse [ENTER].

- 3 Al terminar las correcciones pulse [ENTER].**
 - Para continuar programando:
Seleccione “Nueva grabación programada” y repita los pasos 2–3.
- 4 Pulse [SCHEDULE].**
- 5 Pulse [⏻, DVD/VHS POWER].**
 - La grabación temporizada sólo puede ser iniciada cuando la unidad está apagada.
 - La unidad se apaga y en el visualizador de la unidad se enciende “⏻” para señalar que la espera de la grabación temporizada ha sido activada.

■ Para hacer salir la unidad de la espera de la grabación temporizada Pulse [⏻, DVD/VHS POWER].

- Tenga cuidado de pulsar [⏻, DVD/VHS POWER] para que la unidad vuelva al modo de espera antes de la hora de la grabación temporizada. La grabación temporizada sólo funcionará si está visualizado “⏻”.

■ Para detener la grabación mientras un programa está trabajando

- 1 Pulse [DVD].**
- 2 Pulse [■, STOP], luego [ENTER] dentro de 5 segundos.**
 - Puede también mantener pulsado [■] en el DVD de la unidad principal durante 3 o más segundos para detener la grabación.

■ Controle, cambie o borre el programa

Aun cuando la unidad está apagada, puede visualizar la lista de la grabación temporizada pulsando [SCHEDULE].

- 1 Pulse [SCHEDULE].**
- 2 Pulse [▲, ▼] para seleccionar el programa.**
- 3 Pulse [CANCEL/RESET, *] para eliminar, o pulse [ENTER] para cambiar.**
No es posible eliminar programas en fase de grabación. Se visualiza la pantalla de ajuste de la grabación temporizada.
- 4 Si pulsa [ENTER] en el paso 3, Utilice [▲, ▼, ◀, ▶] para cambiar luego pulse [ENTER].**
- 5 Pulse [SCHEDULE].**

■ Para poner la unidad en espera de la grabación temporizada Pulse [⏻, DVD/VHS POWER].

- La unidad se apaga y en el visualizador de la unidad se enciende “⏻” para señalar que la espera de la grabación temporizada ha sido activada.

Referencia

- Los programas cuya grabación no tuvo éxito no se borran inmediatamente de la lista (destacados en gris), pero se borran automáticamente a las 4 de la mañana 2 días después.
- Durante la grabación temporizada puede cambiar el tiempo final mientras el modo de grabación no es “FR”.

■ Precauciones al usar la grabación temporizada en DVD y VHS La grabación temporizada inicia automáticamente a la hora establecida.

- La grabación temporizada sólo puede ser iniciada cuando la unidad está apagada. Cerca de un 1 minuto antes de que inicie la grabación temporizada, la unidad se enciende. Cuando termine, la unidad vuelve a apagarse. Por si hay también otro programa a ser reproducido, la unidad no vuelve a apagarse.

La grabación temporizada no puede activarse en DVD y VHS conjuntamente.

Verifique si el tiempo inicial de la grabación temporizada no se superpone en la pantalla de programación temporizada tanto del DVD (→ arriba) como del VHS (→ 79).

Cuando se superponen los ajustes de la grabación temporizada:

- Cuando el tiempo inicial de las dos grabaciones temporizadas es el mismo, la última tiene la prioridad.

■ Introducción de un cassette de vídeo

La superficie en la que puede ver el rollo de la cinta tiene que mirar hacia arriba.

Inserte un cassette de vídeo.

- Esta unidad se enciende automáticamente.

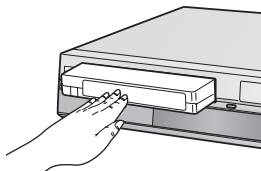

Sólo cuando aparece la visualización de estado (→ derecha).

11/8 10:15 PM ■ Espacio 2:34 EP
■ 00:05.14

Cuando inserte una cinta demarra el contador de tiempo de la cinta que queda. Según el tipo de cinta, esto puede emplear más o menos 30 segundos.

■ Para expulsar el cassette de vídeo

- Puede expulsar el cassette de vídeo cuando la unidad está en el modo de espera. Ésta vuelve en espera una vez que haya expulsado el cassette de vídeo.

Por lo que respecta a la unidad principal

- Pulse [▲, EJECT] en la unidad principal.

Por lo que respecta al mando a distancia

- Pulse [VHS] luego mantenga pulsado [■, STOP] durante 3 segundos o más.

■ Cassette de vídeo

- Haga disparar la lengüeta del cassette de vídeo para evitar un borrado accidental. Cubra el orificio con una doble capa de cinta adhesiva para cuando quiere usar el cassette de vídeo para una nueva grabación.
- Puede usar los cassettes de vídeo con las marcas VHS y S-VHS, pero esta unidad no permite disfrutar plenamente las características de los cassette de vídeo S-VHS.

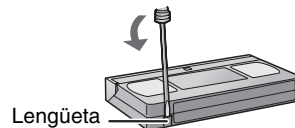

Reproducción de un cassette de vídeo

Operaciones preliminares

- Seleccione el canal que ve la imagen de la unidad (por ejemplo la entrada AV) en el televisor.
- Pulse [VHS].

1 Pulse [⏻, DVD/VHS POWER] para encender la unidad.

2 Inserte un cassette de vídeo grabado. (→ arriba)

3 Pulse [▶, PLAY].

- La reproducción inicia automáticamente si inserta un cassette de vídeo al que se ha quitado su lengüeta.

Para interrumpir provisionalmente la reproducción

Pulse [⏸, PAUSE]. (Pulse nuevamente la tecla para reanudar la reproducción.)

Para detener la reproducción

Pulse [■, STOP].

Nota

- Cuando está apagada la unidad, un cassette de vídeo insertado puede ser reproducido pulsando [▶, PLAY].
- Cuando la cinta llega al fin, esta unidad la rebobina automáticamente hasta el comienzo. Esta función no obra durante la grabación temporizada, el avance rápido y la grabación con parada especificada.
- La búsqueda Jet, la localización progresiva, el rebobinado o la reproducción lenta se quitan automáticamente a los 10 minutos, y para la pausa se quitan a los 5 minutos.
- Cuando ve una imagen fija o una reproducción lenta, la imagen que aparece en el modo VP puede resultar distorsionada.
- Cuando reproduce una cinta que fue grabada en otro VCR, puede ser necesario ajustar la pista. En algunos casos, la calidad de la imagen podría resultar todavía inferior. Esto se debe al formato limitado.
- Cuando la unidad inicia a hacer una grabación temporizada en el DVD mientras se reproduce un VHS, puede haber unas distorsiones en las imágenes.
- Cuando un televisor está conectado en la salida DVD PRIORITY de esta unidad y la unidad demarra grabando o empieza una grabación temporizada en el DVD, no se pueden reproducir imágenes de un VHS.

■ Avance rápido/Rebobinado

Durante la parada

Pulse [◀◀] (atrás)/[▶▶] (en avance).

■ Localización progresiva/Rebobinado

Durante la reproducción

Dé un ligero golpe en o mantenga pulsado [◀◀] (atrás)/[▶▶] (en avance).

- Si mantiene pulsadas estas teclas, la normal reproducción vuelve a iniciar soltándolas.

- Dé un golpecito en [▶, PLAY] para volver a iniciar la normal reproducción.

■ Búsqueda Jet

Durante la reproducción

Dé un ligero golpe en [◀◀] (atrás)/[▶▶] (en avance) dos veces. Puede aumentar la localización progresiva/velocidad de búsqueda en rebobinado.

- Pulse [▶, PLAY] para volver a iniciar la normal reproducción.
- Puede seleccionar la velocidad de búsqueda para ver la imagen grabada.
- La imagen grabada en el modo EP o VP puede resultar distorsionada si se reproduce a una velocidad aproximada de 35 veces. Puede ocurrir un desplazamiento vertical. Esto no es un funcionamiento defectuoso pero si tiene lugar, cambie a una velocidad aproximada de 27 veces.
- La imagen podría ser incolora o podría resultar distorsionada según el televisor.

■ Lento

Durante la reproducción

Pulse y mantenga [⏸, PAUSE] durante 2 segundos o más.

- Pulse [▶, PLAY] para volver a iniciar la normal reproducción.

■ Rebobinado Jet

Para ejecutar un rebobinado a una velocidad más rápida

Pulse [◀◀JET REW].

La indicación "J. REW" aparece en la pantalla del televisor.

- Según la cinta o la condición de funcionamiento, la velocidad de rebobinado puede variar un poco.
- El contador de la cinta se repone a "00:00.00" cuando la cinta se rebobina desde el comienzo.
- Según la cinta, esta función podría no obrar.

■ Cuasi reproducción S-VHS (SQPB)

Es también posible reproducir cintas grabadas en el sistema S-VHS.

- Pueden tener lugar algunos ruidos según el tipo de cinta utilizada.
- No es posible conseguir plenamente una resolución más alta que la que es capaz el S-VHS.
- No es posible grabar en el sistema S-VHS con esta unidad.

■ Reproducción repetida

Durante la reproducción o mientras que está detenida

Mantenga pulsado [▶, PLAY] durante 5 o más segundos.

- En el visualizador aparece la indicación "RPT".



- Al fin del programa, la cinta se rebobina hasta el comienzo del programa y lo va a reproducir otra vez (esto sólo funciona si quedan al menos 5 segundos de espacio en blanco al fin del programa). Esto se repite hasta que lo cancela.

Para reiniciar la reproducción normal

Pulse [▶, PLAY].

Para detener la reproducción

Pulse [■, STOP].

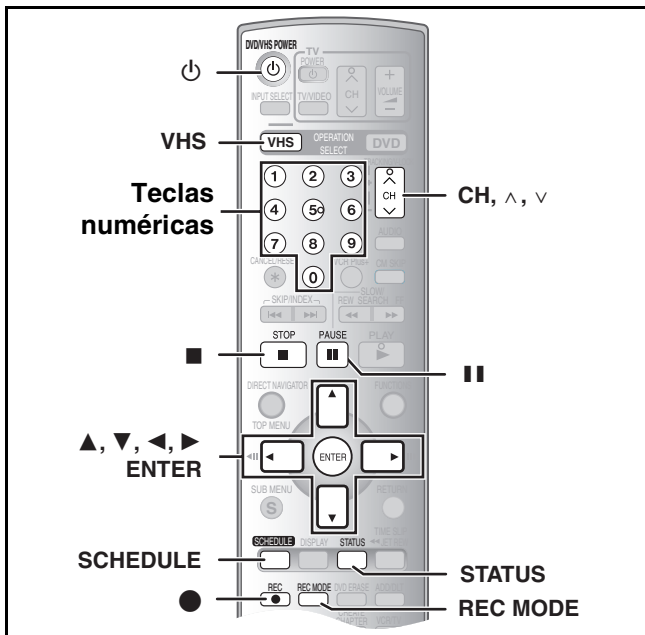

Nota

- Aunque el cassette que usa tenga la etiqueta "S-VHS", no es posible grabar en el sistema S-VHS con esta unidad. Esta se graba en el normal sistema VHS.
- No puede cambiar canales mientras graba. Puede cambiar canales mientras está en el modo de pausa.
- Cuando la grabación está en pausa durante más de 5 minutos, la unidad vuelve al modo de parada.

■ Para visualizar el tiempo aproximado que queda en la cinta

1 Seleccione "SELECCIONAR CINTA" desde el menú VHS y elija la longitud correspondiente de la cinta.

2 Pulse varias veces [STATUS].

El visualizador cambia tan pronto como se pulsa cada vez [STATUS].

Canal de entrada → Tiempo que queda en la cinta → Contador

- El tiempo que queda en la cinta podría no visualizarse correctamente según la cinta usada.

■ Indicación del tiempo en que se parará la grabación Durante la grabación

Pulse [●, REC] para seleccionar el tiempo de grabación.

- Se puede también pulsar [●, REC] en la unidad principal.

Visualización de la unidad

Cada vez que pulsa la tecla:

Contador (suprimir) → OFF 0:30 → OFF 1:00 → OFF 1:30
 ↑ OFF 4:00 ← OFF 3:00 ← OFF 2:00 ←

Referencia

- Esto no funciona durante las grabaciones temporizadas.
- Pulsando [■, STOP] la grabación se detiene y el horario configurado se borra.

■ Recepción de las transmisiones televisivas durante la grabación (→ 74)

Grabación temporizada

Puede introducir hasta 16 programas con un adelanto de un mes.

Operaciones preliminares

- Seleccione el canal que ve la imagen de la unidad (por ejemplo la entrada AV) en el televisor.
- Controle que el reloj esté ajustado a la hora correcta. Por si no lo estuviese, ajústelo.
- Inserte un cassette de vídeo que tenga la lengüeta de protección contra el borrado accidental intacta. (→ 77)
- Pulse [VHS].

■ Uso del sistema VCR Plus+

Se refiera a "Uso del sistema VCR Plus+", paso 1-6. (→ 76)

Grabación de programas televisivos

Operaciones preliminares

- Seleccione el canal que ve la imagen de la unidad (por ejemplo la entrada AV) en el televisor.
- Controle que el reloj esté ajustado a la hora correcta. Por si no lo estuviese, ajústelo.
- Pulse [VHS].

1 Inserte un cassette de vídeo que tenga la lengüeta de protección contra el borrado accidental intacta. (→ 77)

2 Pulse [CH, ^, v] para seleccionar un canal TV.

Para seleccionar los canales con las teclas numéricas:

Modo Antena (Ondas hertzianas)
 por ej., "5": [0]→[5] "15": [1]→[5]

Modo Cable TV (Cable)
 por ej., "5": [0]→[0]→[5] "15": [0]→[1]→[5]
 "115": [1]→[1]→[5]

3 Pulse [REC MODE] para seleccionar el modo de grabación.

Cada vez que pulsa la tecla: SP→EP→VP→SP

4 Pulse [●, REC] para iniciar la grabación.

Para detener temporalmente la grabación

Pulse [■, PAUSE]. (Pulse nuevamente la tecla para reanudar la grabación.)

Para detener la grabación

Pulse [■, STOP].

Modos de grabación

SP: Puede grabar la longitud señalada en la cinta.

EP: Tres veces la longitud del modo SP.

VP: Cinco veces la longitud del modo SP.

- Para conseguir una capacidad de grabación más larga, seleccione "EP" o "VP".
- Si la calidad de la imagen es importante para Ud. o bien si quiere almacenar la cinta durante un largo período, seleccione "SP".
- Esta unidad puede reproducir cintas grabadas con el modo LP en otro equipo.

Modo VP:

- Una cinta grabada en el modo VP por esta unidad no puede ser reproducida por otro modo VCR. Se recomienda que se la distingue de otra cinta indicando "VP" en su etiqueta, etc.
- Lleva más tiempo para que funcione la pista automática cuando se reproducen cintas en el modo VP y, en algunas cintas, podría no funcionar de ninguna manera. Si fuese el caso, haga la localización manualmente.

■ Programación manual

- Cuando se conecte una caja TV de cable o un receptor de satélite, seleccione el canal en la caja TV de cable o receptor de satélite antes de que comience la grabación temporizada.

1 Pulse [SCHEDULE].

- Cerciórese de que esté seleccionado "Nueva grabación programada".

2 Pulse [ENTER], luego desplace y cambie los detalles usando [▲, ▼, ◀, ▶].

- Pueden usarse las teclas numéricas para introducir "Canal", "Fecha", "Act." y "Des."
- **Canal** (Posición del programa/Nombre de la estación de TV)
- **Fecha**
Puede crear usted un programa diario o semanal.
- **Act.** (hora de encendido)/**Des.** (hora final)
Si mantiene pulsado el botón, el tiempo aumentará o disminuirá en incrementos de 30 minutos.
- **Unid.** (Unidad de grabación)
Seleccione la unidad de grabación "VHS".
- **Modo** (Modo de grabación)
Para cambiar el modo de grabación, puede pulsar también [REC MODE].
SP ↔ EP ↔ VP ↔ AUTO* ↔ SP... (→ 78)
* Modo SP/EP automático (→ derecha)
- **Nombre tít.**
No puede ser usado.

3 Al terminar las correcciones pulse [ENTER].

- Para continuar programando:
Seleccione "Nueva grabación programada" y repita los pasos 2-3.

4 Pulse [SCHEDULE].

5 Pulse [⏻, DVD/VHS POWER].

- La grabación temporizada sólo puede ser iniciada cuando la unidad está apagada.
- La unidad se apaga y en el visualizador de la unidad se enciende "⏻" para señalar que la espera de la grabación temporizada ha sido activada.

■ Para hacer salir la unidad de la espera de la grabación temporizada

Pulse [⏻, DVD/VHS POWER].

- Tenga cuidado de pulsar [⏻, DVD/VHS POWER] para que la unidad vuelva al modo de espera antes de la hora de la grabación temporizada. La grabación temporizada sólo funcionará si está visualizado "⏻".

■ Para detener la grabación mientras un programa está trabajando

1 Pulse [VHS].

2 Pulse [■, STOP], luego [ENTER] dentro de 5 segundos.

- Puede también mantener pulsado [■] en el DVD de la unidad principal durante 3 o más segundos para detener la grabación.

Nota

- "⏻" destellan cuando la unidad no puede ejecutar la grabación temporizada (por ejemplo, el cassette de vídeo no tiene la lengüeta de protección contra el borrado accidental o bien no hay ningún cassette de vídeo en su respectivo compartimiento).
- El tiempo real grabado podría alargarse más allá del programa mismo cuando los programas TV se graban usando el sistema VCR Plus+.
- Si ajusta "HL" (Tiempo de ahorro de la luz del día) a "Act" cuando ajusta manualmente el reloj, la grabación temporizada podría no funcionar cuando del verano cambia al invierno y viceversa.

■ Modo SP/EP automático

Si al comienzo de la grabación temporizada, no queda cinta bastante para terminarla, la función SP/EP hará marchar automáticamente la cinta al modo EP para la grabación. Esto garantiza que será grabado el entero programa. Si el modo EP no es bastante para alargar la cinta para que se adapte al entero programa, no será posible grabar el entero programa TV.

Primer programa (30 min.)	Segundo programa (60 min.)		Programación temporizada
30 min. en SP	15 min. en SP	45 min. en EP	

- No es posible activar automáticamente el modo VP.
- La longitud de la cinta ha de ser ajustada correctamente.
- Algunas cintas podrían no funcionar correctamente.
- Si cambia el modo de grabación de SP a EP durante la grabación temporizada, en aquel punto podría tener lugar una breve distorsión de la imagen.

■ Controle, cambie o borre el programa

Se refiera a "Controle, cambie o borre el programa", paso 1-5. (→ 76)

■ Precauciones al usar la grabación temporizada en DVD y VHS (→ 76)

Manufactured under license from Dolby Laboratories.
"Dolby" and the double-D symbol are trademarks of Dolby Laboratories.

"DTS" and "DTS 2.0+ Digital Out" are trademarks of Digital Theater Systems, Inc.

Apparatus Claims of U.S. Patent Nos. 4,631,603, 4,577,216, and 4,819,098, licensed for limited viewing uses only.

This product incorporates copyright protection technology that is protected by method claims of certain U.S. patents and other intellectual property rights owned by Macrovision Corporation and other rights owners. Use of this copyright protection technology must be authorized by Macrovision Corporation, and is intended for home and other limited viewing uses only unless otherwise authorized by Macrovision Corporation. Reverse engineering or disassembly is prohibited.

MPEG Layer-3 audio decoding technology licensed from Fraunhofer IIS and Thomson multimedia.

Panasonic Consumer Electronics Company, Division of Panasonic Corporation of North America
One Panasonic Way, Secaucus,
New Jersey 07094
<http://www.panasonic.com>

Panasonic Puerto Rico, Inc.
Ave. 65 de Infantería, Km. 9.5
San Gabriel Industrial Park, Carolina,
Puerto Rico 00985

Panasonic Canada Inc.
5770 Ambler Drive
Mississauga, Ontario
L4W 2T3
www.panasonic.ca