

Panasonic®

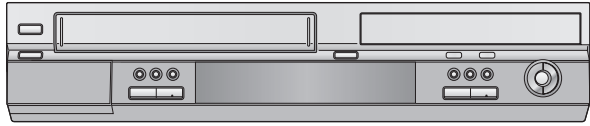

Operating Instructions

DVD Recorder Model No. **DMR-ES30V**

DIGA

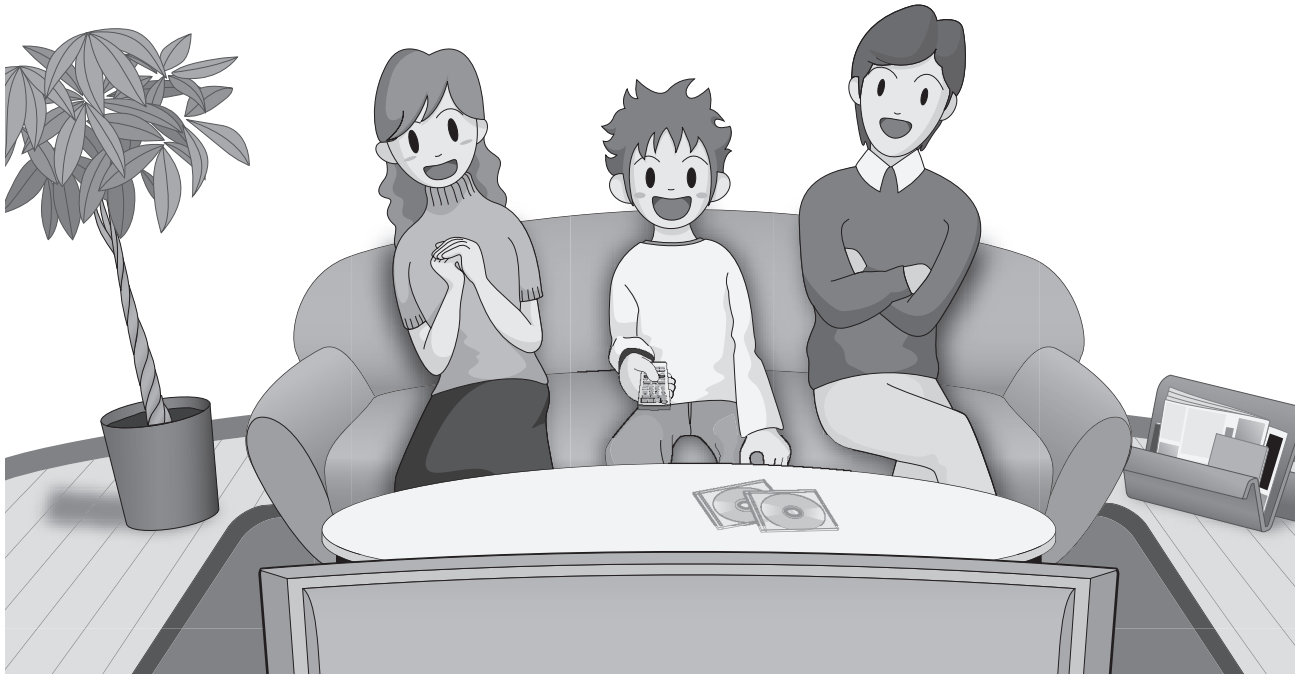

Dear Customer

Thank you for purchasing this product. For optimum performance and safety, please read these instructions carefully.

Before connecting, operating or adjusting this product, please read the instructions completely.
Please keep this manual for future reference.

Getting started

Playback

Recording

Editing

Convenient functions

DVD

Playback

Recording

Convenient functions

VHS

Transferring (Dubbing)

Reference

Getting started

Warning and Important Information

CAUTION!

THIS PRODUCT UTILIZES A LASER.
USE OF CONTROLS OR ADJUSTMENTS OR PERFORMANCE OF PROCEDURES OTHER THAN THOSE SPECIFIED HEREIN MAY RESULT IN HAZARDOUS RADIATION EXPOSURE. DO NOT OPEN COVERS AND DO NOT REPAIR YOURSELF. REFER SERVICING TO QUALIFIED PERSONNEL.

WARNING:

TO REDUCE THE RISK OF FIRE, ELECTRIC SHOCK OR PRODUCT DAMAGE, DO NOT EXPOSE THIS APPARATUS TO RAIN, MOISTURE, DRIPPING OR SPLASHING AND THAT NO OBJECTS FILLED WITH LIQUIDS, SUCH AS VASES, SHALL BE PLACED ON THE APPARATUS.

CAUTION!

- DO NOT INSTALL OR PLACE THIS UNIT IN A BOOKCASE, BUILT-IN CABINET OR IN ANOTHER CONFINED SPACE. ENSURE THE UNIT IS WELL VENTILATED. TO PREVENT RISK OF ELECTRIC SHOCK OR FIRE HAZARD DUE TO OVERHEATING, ENSURE THAT CURTAINS AND ANY OTHER MATERIALS DO NOT OBSTRUCT THE VENTILATION VENTS.
- DO NOT OBSTRUCT THE UNIT'S VENTILATION OPENINGS WITH NEWSPAPERS, TABLECLOTHS, CURTAINS, AND SIMILAR ITEMS.
- DO NOT PLACE SOURCES OF NAKED FLAMES, SUCH AS LIGHTED CANDLES, ON THE UNIT.
- DISPOSE OF BATTERIES IN AN ENVIRONMENTALLY FRIENDLY MANNER.

THIS UNIT IS INTENDED FOR USE IN TROPICAL CLIMATES.

This product may receive radio interference caused by mobile telephones during use. If such interference is apparent, please increase separation between the product and the mobile telephone.

The socket outlet shall be installed near the equipment and easily accessible or the mains plug or an appliance coupler shall remain readily operable.

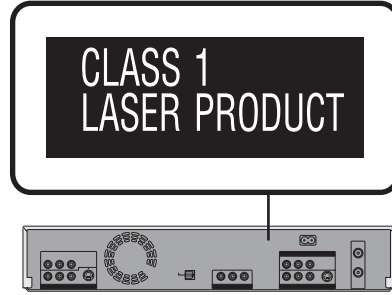

DANGER	• VISIBLE AND INVISIBLE LASER RADIATION WHEN OPEN. AVOID DIRECT EXPOSURE TO BEAM. (FDA 21 CFR)
CAUTION	• VISIBLE AND INVISIBLE LASER RADIATION WHEN OPEN. AVOID EXPOSURE TO BEAM. (IEC60825-1)
ATTENTION	• RAYONNEMENT LASER VISIBLE ET INVISIBLE EN CAS D'OUVERTURE. EXPOSITION DANGEREUSE AU FAISCEAU.
ADVARSEL	• SYNLIG OG USYNLIG LASERSTRÅLING VED ÅBNING. UNDGÅ UDSÆTTELSE FOR STRÅLING.
VARO!	• AVATTAESSA OLET ALTIIN NÄKYVÄÄ JA NÄKYMÄTÖN LASERSÄTEILYLLE. ÄLÄ KATSO SÄTEESEEN.
VARNING	• SYNLIG OCH OSYNLIG LASERSTRÅLNING NÄR DENNA DEL ÄR ÖPPNAD. BETRakta EJ STRÅLEN.
ADVARSEL	• SYNLIG OG USYNLIG LASERSTRÅLING NÄR DEKSEL ÅPNES. UNNGÅ EKSPONERING FOR STRÅLEN.
VORSICHT	• SICHTBARE UND UNSICHTBARE LASERSTRÄHLUNG. WENN ABDECKUNG GEÖFFNET, NICHT DEM STRAHL AUSSETZEN.
注意	• 打开时有可见及不可见激光辐射。避免激光束照射。
注意	• ここを開くと可視及び不可視のレーザー光が出ます。ビームを直接見たり、触れたりしないでください。 RQLS0233

(Inside of product)

Information on Disposal in other Countries outside the European Union

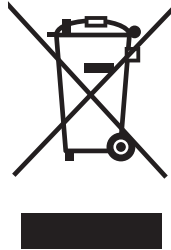

This symbol is only valid in the European Union.

If you wish to discard this product, please contact your local authorities or dealer and ask for the correct method of disposal.

Getting started

Precautions

Do not place the unit on amplifiers or equipment that may become hot.
The heat can damage the unit.



Before moving the unit, ensure the disc tray is empty. Failure to do so will risk severely damaging the disc and the unit.

■ Precautions for installation

- The unit should not be installed or operated near large magnets or electromagnetic devices. Such devices can damage pre-recorded VHS recordings.
- Do not place any heavy objects atop the unit, and do not install it in a confined space. Please allow for adequate air circulation.
- The unit should not be mounted in a vertical position. It's designed to operate in the horizontal position.

■ Important

Your attention is drawn to the fact that the recording of pre-recorded tapes or discs or other published or broadcast material may infringe copyright laws.

■ For your safety

Do not remove outer cover.

Touching internal parts of the unit is dangerous, and may seriously damage it.

To prevent electric shock, do not remove cover. There are no user serviceable parts inside. Refer all servicing to qualified service personnel.

■ Conserve the environment

See "Power Save" of page 43.

■ Cautions before you operate this unit

Avoid:

- Humidity and dust.
- Extreme heat such as direct sunlight.
- Magnets or electromagnetic objects.
- Touching internal parts of the unit.
- Water or some other liquid.
- Lightning. (Disconnect the aerial plug from the unit during lightning storms.)
- Anything heavy on the unit.
- Connecting or handling the equipment with wet hands.
- Using a cell phone near the unit because it may cause noise affecting the picture and sound.

Do:

- Wipe the unit with a clean and dry cloth.
- Install the unit in a horizontal position.
- Keep the unit, TV and other equipment switched off until all connections are finished.

■ Notes on these instructions

- Company names, product names and all other names in these instructions are the trademarks or registered trademarks of their respective corporations.
- These operating instructions describe operations mainly using the remote control.
- The contents of the screens used in these instructions may not necessarily match what you will see on your screen.

■ Displays

The displays shown in these instructions are examples. Actual displays depend on discs.

- In certain circumstances, icons will be displayed in grey and will not respond if clicked on. This means that the function represented by the icon is disabled.

About descriptions in these operating instructions

- Pages to be referred to are indicated as (→ ○○).
- The explanations concerning discs are indicated by [DVD], and those concerning video are indicated by [VHS].

Useful features

You can enjoy both DVD and VHS with the unit. This DVD Recorder can record images and sounds in high quality to rapid random access capable DVD media. This has resulted in many new features that outperform older tape formats. The following information summarizes a few of these features.

■ DVD

Progressive output (→ 15, 18)

If you connect the unit with a progressive output-compatible TV, you can enjoy higher-quality and less-flicker images than conventional TVs (of the interlace output type) can present.

Finalize (→ 29)

This function enables you to play recorded DVD-R, DVD-RW (DVD-Video format) and +R on other players.

Instant play (→ 31)

There is no need to rewind or search forward. Direct Navigator guides you to the beginning of a previously recorded video immediately.

Quick view (→ 19)

This function allows you to watch news, information and other programmes in a short time.

Chasing play (→ 25)

There is no need to wait until recording is complete. Without stopping recording, you can play the video currently being recorded from its beginning.

Instant recording (→ 23)

You no longer need to search for empty disc space. By pressing the recording button, the unit finds available recording space and begins recording right away.

Simultaneous recording and play (→ 25)

With this function, you can play a previously recorded video programme while recording another programme.

Time slip (→ 20, 25)

This function enables you to jump to the scene you specify during play and also while recording.

■ VHS

Longrun Head System

This longrun head system enables approximately 8,000 hours of recording/playback with high quality images. Newly developed head cylinder with narrower head windows and tapered cylinder design effectively protect heads from dust and prevents head clogging.

- Plus, "Alumina" Head Cleaner enhances the cleaning efficiency.
- Based on in-house tests with Panasonic Video Cassettes. Actual head life may vary according to conditions of use, tape type, temperature, humidity, etc.

■ Common

One touch transfer (dub) (→ 57, 60)

This function can copy video from VHS to DVD and vice versa.

Parallel recording with twin tuner

The twin tuner lets you record two TV programmes simultaneously—one onto a DVD disc and the other onto a tape.

Getting started

Contents

Getting started

Warning and Important Information	2
Precautions	3
About descriptions in these operating instructions	3
Useful features	3
Concerning discs	6
• Discs you can use for recording and play [12 cm/8 cm]	6
• Play-only discs [12 cm/8 cm]	7
• Discs that cannot be played	7
• Concerning logo marks	7
• Which Disc Types is Playable on What TV	8
• Inserting discs	8
• Disc handling	9
Maintenance	9
Using DVD-R, DVD-RW and +R on this unit	10
Remote control	11
• Batteries and remote control	12
Main unit	12
• The unit's display	13
Accessories	13
STEP 1 Connection	14
• Connecting a TV	14
• Connecting an amplifier or system component	15
- To enjoy multi-channel surround sound on DVD-Video (digital connection)	15
- Connection to a stereo amplifier (analog connection)	15
• DVD output and DVD/VHS output	15
• To enjoy even higher fidelity	15
- Connection to the S Video terminal	15
- Connection to the component video terminals	15
STEP 2 Auto-Setup	16
• Auto-Setup	16
STEP 3 Set up to match your TV and remote control	17
• When other Panasonic products respond to this remote control	17
• Selecting TV type	17
• TV operation	17
• To enjoy progressive video	18
- Note to owners of progressive compatible PAL system televisions	18

DVD

Playback

Playing discs	19
• When a menu screen appears on the TV	19
Quick View (Play X1.3)	19
Starting play from where you stopped it (Resume Function)	19
Fast forward and rewind — SEARCH	19
Skipping	19
Slow-motion play	19
Frame-by-frame viewing	19
Direct play	20
Erasing a title that is being played	20
Displaying the TV image as a picture-in-picture/ Selecting an amount of time to skip — Time Slip	20
Create chapters	20
Changing audio during play	21
Playing discs which contain both MP3 and still pictures	21
Using menus to play MP3 discs	21
• Using the tree screen to find a group	22
To show JPEG Menu	22
- Playing a still picture	22
- Start Slide Show/Slide Interval	22
- To select the still pictures in another folder	22

Recording

Recording TV programmes	23
• Recording procedures	23
• Recording modes and approximate recording times	23
Specifying the time when recording will stop	24
Watching the TV while recording	24
Flexible Recording mode (FR)	24
Playing while you are recording	25
• Chasing play	25

• Simultaneous recording and play	25
• TIME SLIP	25
• Playing/Recording VHS while recording	25
Timer Recording	26
• Manual programming	26
Check, change or delete programmes	27

Editing

DISC MANAGEMENT	28
- Disc Name	28
- Disc Protection	28
- Erase all titles	28
- Format Disc	29
- Auto-Play Select	29
- Finalize	29
Entering text	30
Using the Direct Navigator	31
• Selecting recorded titles to play	31
• Editing titles with SUB MENU button	31
- Erase	31
- Properties	31
- Edit	32
- Chapter View	33
Using playlist	34
• Creating playlists	34
• Playing playlists	35
• Editing playlists with SUB MENU button	35
- Erase	35
- Properties	35
- Edit	36
- Chapter View	37

Convenient functions

Using DISPLAY menus	38
• Common procedures	38
- Disc menu	38
- Play menu	39
- Picture menu	39
- Sound menu	39
- Other menu	39
Changing the unit's settings	40
• Common procedures	40
Entering a password (Ratings)	40
Summary of settings	41
Channel Settings	44
- Selecting the manual tuning	44
- Adding, deleting, and moving channels	45
- Auto-Setup Restart	45
Clock Settings	46
Child Lock	46
FUNCTIONS window	47
Status displays	47
• Changing the information displayed	47
• Display examples	47

Getting started

VHS

Playback

Inserting a video cassette	48
Video cassette information	48
• Video cassettes	48
• Video cassette care	48
• Maintenance	48
Setting Up	48
• Fine Tuning	48
Playing a video cassette	49
Fast-forward/Rewind	49
Cue/Review	49
Jet Search	49
Slow-motion play	49
Jet Rewind	49
S-VHS Quasi Playback (SQPB)	50
Repeat Playback	50
Playing a tape with high image quality	50
Adjusting the playback picture	50
• Manual tracking	50
• Vertical locking adjustment	50

Recording

Recording TV programmes	51
• Recording procedures	51
• Specifying the time when recording will stop	51
• Watching the TV while recording	51
• Playing/Recording DVD while VHS recording	51
Timer Recording	52
• Manual programming	52
Recording mode Auto Change Function	53
Check, change or delete programmes	53

Convenient functions

VHS Index Search System (VISS)	54
Changing the unit's settings	54
• Common procedures	54
- Summary of settings	54
QUICK ERASE	55
Various indications in on-screen display	55
Changing audio	55

DVD/VHS

Transferring (Dubbing)

Before transferring (dubbing)	56
Transfer (Dubbing) from VHS	57
• One Touch Transfer (Dubbing) (VHS → DVD)	57
• GUI (Graphical User Interface) Transfer (Dubbing) (VHS → DVD)	58
• Manual Transfer (Dubbing) (VHS → DVD)	59
Transfer (Dubbing) from DVD	60
• One Touch Transfer (dubbing) (DVD → VHS)	60
• GUI (Graphical User Interface) Transfer (Dubbing) (DVD → VHS)	61
• Transfer (Dubbing) a finalized disc (DVD-R, DVD-RW, +R, +RW) or DVD-Video	62
• Manual Transfer (Dubbing) (DVD → VHS)	64
Recording from an external device	65
- DVD	65
- VHS	65



Reference

Glossary	66
Frequently asked questions	67
Error messages	68
• Common	68
• DVD	68
Troubleshooting guide	69
• Common	69
• DVD	71
• VHS	73
Specifications	74

Getting started

Concerning discs

■ Discs you can use for recording and play [12 cm/8 cm]

Disc type	DVD-RAM ● 4.7 GB/9.4 GB, 12 cm ● 2.8 GB, 8 cm	DVD-R (DVD-Video format) ● 4.7 GB, 12 cm ● 1.4 GB, 8 cm	DVD-RW (DVD-Video format) ● 4.7 GB, 12 cm ● 1.4 GB, 8 cm	+R ● 4.7 GB, 12 cm
Logo				—
Indicated in these instructions with	RAM	-R before finalization DVD-V after finalization	-RW(V) before finalization DVD-V after finalization	+R before finalization DVD-V after finalization
Main use	Re-writable discs	One time recording discs (recordable until the disc is full)	Re-writable discs	One time recording discs (recordable until the disc is full)
Maximum recording time	Approx. 8 hours (Approx. 16 hours on a double-sided disc*)	Approx. 8 hours	Approx. 8 hours	Approx. 8 hours
Play on other player	Only on DVD-RAM compatible players. It is not necessary to finalize the disc. (→ 66)	Only after finalizing the disc. (→ 29, 66)	Only after finalizing the disc. (→ 29, 66)	Only after finalizing the disc. (→ 29, 66)
What you can do on this unit (✓: Possible, ✗: Impossible)				
Chasing playback	✓	✗	✗	✗
Recording broadcasts that allow one copy	✓ (CPRM (→ 66) compatible discs only)	✗	✗	✗
Recording both M 1 and M 2 of bilingual broadcast	✓	✗ Only one is recorded. (→ 42, Bilingual Audio Selection)	✗ Only one is recorded. (→ 42, Bilingual Audio Selection)	✗ Only one is recorded. (→ 42, Bilingual Audio Selection)
Recording 16:9 aspect picture	✓	✗ (The picture is recorded in 4:3 aspect.)	✗ (The picture is recorded in 4:3 aspect.)	✗ (The picture is recorded in 4:3 aspect.)
Entering text	✓	✓	✓	✓
Erasing titles	✓	✓ (Available space does not increase after erasing.)	✓ (Disc space increases only when the last recorded title is erased.)	✓ (Available space does not increase after erasing.)
Creating playlists	✓	✗	✗	✗

* You cannot consecutively record or play both sides.

- We recommend using Panasonic discs. We recommend using DVD-RAM discs with cartridges to protect them from scratches and dirt.
- Discs from other manufactures may not be recorded or played due to the condition of the recording.
- You may not be able to record to DVD-R, DVD-RW and +R discs on this unit or play them due to the condition of the recording.
- You cannot record programmes that allow “One time only recording” to CPRM compatible DVD-R and DVD-RW on this unit. You can record other programmes as DVD-Video format.
- You can use high speed recording compatible discs on this unit.
- This unit cannot record to discs containing both PAL and NTSC signals. Play of discs recorded with both PAL and NTSC on another unit is not guaranteed.

■ DVD Video Recording format

This is a recording method which allows you to record and edit TV broadcasts and so on.

- Digital broadcasts that allow “One time only recording” can be recorded to a CPRM compatible disc. You can record to CPRM compatible DVD-RAM on this unit.
- Play is only possible on a compatible DVD player.

Use a DVD-RAM to record in DVD Video Recording format.

■ DVD-Video format





This recording method is the same as commercially available DVD-Video.

- Digital broadcasts that allow “One time only recording” cannot be recorded.
- These can be played on a DVD player. However programmes recorded on this unit must be finalized to be played on other DVD players.

Use a DVD-R or DVD-RW to record in DVD-Video format.

Getting started

■ Play-only discs [12 cm/8 cm]

Disc type	DVD-Video	DVD-Audio	DVD-RW (DVD Video Recording format)	+RW	CD		Video CD
Logo				–		–	
Indicated in these instructions with	DVD-V	DVD-A	-RW(VR)	DVD-V	CD		VCD
Instructions	High quality movie and music discs	High fidelity music discs ● Played on this unit in 2 channels	DVD-RW recorded on another DVD recorder* ● You can play programmes that allow “One time only recording” if they have been recorded to a CPRM compatible disc. ● By formatting (→ 29) the disc, you can record to it in DVD-Video format and play it on the unit. It may be necessary to finalize the disc on the equipment used for recording.	+RW recorded on another DVD recorder*	Recorded audio and music (including CD-R/RW*)	CD-R* and CD-RW* with music recorded in MP3 (→ 21) Still pictures (JPEG and TIFF) recorded on CD-R/RW*	Recorded music and video (including CD-R/RW*)

* Play may be impossible on some DVD-RW (DVD Video Recording format), +RW, CD-R or CD-RW discs due to the condition of the recording.

- You can play still pictures (JPEG/TIFF), CD-DA, Video CD and MP3 format data recorded on CD-R/RW. Close the session or finalize the disc after recording.
- The producer of the disc can control how discs are played. So you may not always be able to control play as described in these operating instructions. Read the disc's instructions carefully.

Note about using a DualDisc

The digital audio content side of a DualDisc does not meet the technical specifications of the Compact Disc Digital Audio (CD-DA) format so play may not be possible.

Regarding DVD-Audio

Some multi-channel DVD-Audio will prevent down-mixing (→ 66) of all or part of their contents if this is the manufacturer's intention. Tracks that are prevented from being down-mixed will not play properly on this unit (e.g. audio is played from the front two channels only). Refer to the disc's jacket for more information.

■ Region number supported by this unit

Region numbers are allocated to DVD players and DVD-Video according to where they are sold.

- The region number of this unit is “2”.
- The unit will play DVDs marked with labels containing “2” or “ALL”.



Example:



■ Discs that cannot be played

- 2.6/5.2 GB DVD-RAM, 12 cm
- 3.95/4.7 GB DVD-R for Authoring
- DVD-R recorded in DVD Video Recording format
- DVD-R (DVD-Video format), DVD-RW (DVD-Video format), +R recorded on another unit and not finalized (→ 66, Finalize)
- DVD-Video with a region number other than “2” or “ALL”
- Blu-ray
- DVD-ROM, DVD-R DL, +R DL, +R 8cm, CD-ROM, CDV, CD-G, Photo CD, CVD, SVCD, SACD, MV-Disc, PD, DivX Video Disc, etc.

■ Concerning logo marks

	Dolby Digital (→ 42) This is a method of coding digital signals developed by Dolby Laboratories. Not only stereo (2 channel) audio, these signals can also be multi-channel audio. A large amount of audio information can be recorded on one disc by this method.
	DTS Digital Surround (→ 42) This surround system is used in many movie theatres around the world. The separation between channels is good and the compression ratio is low, so realistic sound effects are possible.

The manufacturer accepts no responsibility and offers no compensation for loss of recorded or edited material due to a problem with the unit or recordable media, and accepts no responsibility and offers no compensation for any subsequent damage caused by such loss.

Examples of causes of such losses are

- A disc recorded and edited with this unit is played in a DVD Recorder or computer disc drive manufactured by another company.
- A disc used as described above and then played again in this unit.
- A disc recorded and edited with a DVD Recorder or computer disc drive manufactured by another company is played in this unit.

Getting started

Which Disc Types is Playable on What TV

When you use the discs recorded either PAL or NTSC, refer to this table.

TV type	Disc	Playable ⁺¹
Multi-system TV	PAL	✓
	NTSC	✓ ⁺²
NTSC TV	PAL	×
	NTSC	✓ ⁺³
PAL TV	PAL	✓
	NTSC	✓ ⁺⁴ (PAL60)

⁺¹ Playable (✓: Possible, ×: Impossible)

⁺² If you select "NTSC" in "TV System" (→ 42), the picture may be clearer.

⁺³ Select "NTSC" in "TV System" (→ 42).

⁺⁴ If your TV is not equipped to handle PAL 525/60 signals the picture will not be appear correctly.

Optional accessories

(Product numbers correct as of April 2005. These may be subject to change.)

DVD-RAM

9.4 GB, double-sided, cartridge type:

LM-AD240ME (compatible with high speed recording 5×)

LM-AD240LE (compatible with high speed recording 3×)

4.7 GB, single-sided, cartridge type:

LM-AB120ME (compatible with high speed recording 5×)

LM-AB120LE (compatible with high speed recording 3×)

4.7 GB, single-sided, non-cartridge:

LM-AF120ME (compatible with high speed recording 5×)

LM-AF120LE (compatible with high speed recording 3×)

DVD-R

4.7 GB, single-sided, non-cartridge:

LM-RF120ME (compatible with high speed recording 8×)

LM-RF120LE (compatible with high speed recording 4×)

Inserting discs

1 Press [▲, OPEN/CLOSE] on the main unit to open the tray.

• You can insert a cartridge or non-cartridge disc.

2 Press [▲, OPEN/CLOSE] on the main unit to close the tray.

• If you insert a DVD-RAM with the write-protect tab set to "PROTECT" (→ 28), play starts automatically.

Note

- A double-sided disc should be loaded with the side you want to record/play facing down.
- It is not possible to record continuously from one side of a double-sided disc to the other. You will need to eject the disc and turn it over.
- When using 8 cm DVD-RAM or 8 cm DVD-R, remove the disc from the cartridge.

Non-cartridge disc

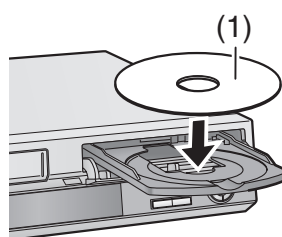

Cartridge disc

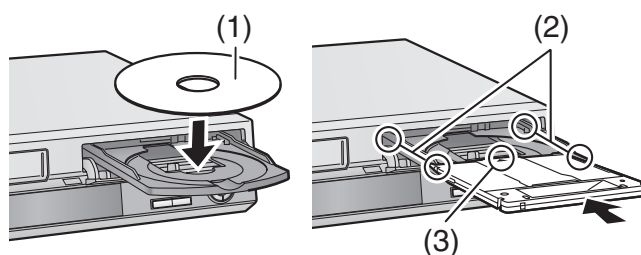

(1) Insert label-up.

(2) Insert fully so it clicks into place.

(3) Insert label-up with the arrow facing in.

Getting started

■ Disc handling

■ How to hold a disc

Do not touch the recorded surface.

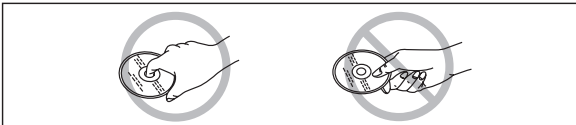

■ Concerning non-cartridge discs

Be careful about scratches and dirt.

■ If there is dirt or condensation on the disc

Wipe with a damp cloth and then wipe dry.

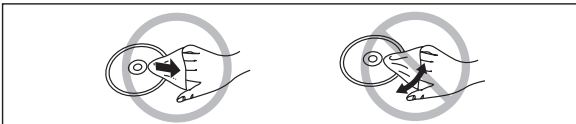

■ Handling precautions

- Do not attach labels or stickers to discs. (This may cause disc warping and unbalanced rotation, rendering it unusable.)
- Write on the label side of the disc only with a soft, oil-based felt pen. Do not use ballpoint pens or other hard writing implements.
- Do not use record cleaning sprays, benzine, thinner, static electricity prevention liquids or any other solvent.
- Do not use scratch-proof protectors or covers.
- Do not drop, stack, or cause impact to discs. Do not place objects on them.
- Do not use the following discs:
 - Discs with exposed adhesive from removed stickers or labels (rental discs etc.).
 - Discs that are badly warped or cracked.
 - Irregularly shaped discs, such as heart shapes.

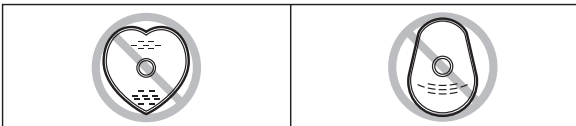

- Do not place in the following areas:
 - In direct sunlight.
 - In very dusty or humid areas.
 - Near a heater.
 - Locations susceptible to significant differences in temperature (condensation can occur).
 - Where static electricity or electromagnetic waves occur.
- To protect discs from scratches and dirt, return them to their cases or cartridges when you are not using them.

Maintenance

The precision parts in the unit are readily affected by the environment, especially temperature, humidity, and dust. Cigarette smoke also can cause malfunction or breakdown.

To clean the unit, wipe with a soft, dry cloth.

- Never use alcohol, paint thinner or benzine to clean the unit.
- Before using chemically treated cloth, carefully read the instructions that came with the cloth.

Observe the following points to ensure continued listening and viewing pleasure.

Dust and dirt may adhere to the unit's lens over time, making it impossible to record or play discs.

Use the **DVD lens cleaner** about once every year, depending on frequency of use and the operating environment.

Carefully read the lens cleaner's instructions before use.

DVD lens cleaner: RP-CL720E

Getting started

Using DVD-R, DVD-RW and +R on this unit

Restrictions with DVD-R, etc.*

- 16:9 aspect programmes are recorded in 4:3 aspect.
- The main (M 1) or secondary audio (M 2) only can be recorded for bilingual broadcasts.
- Playing the disc on other DVD players is not possible before finalizing.

* DVD-R, DVD-RW (DVD-Video format) and +R are collectively referred to as "DVD-R, etc." on this page.

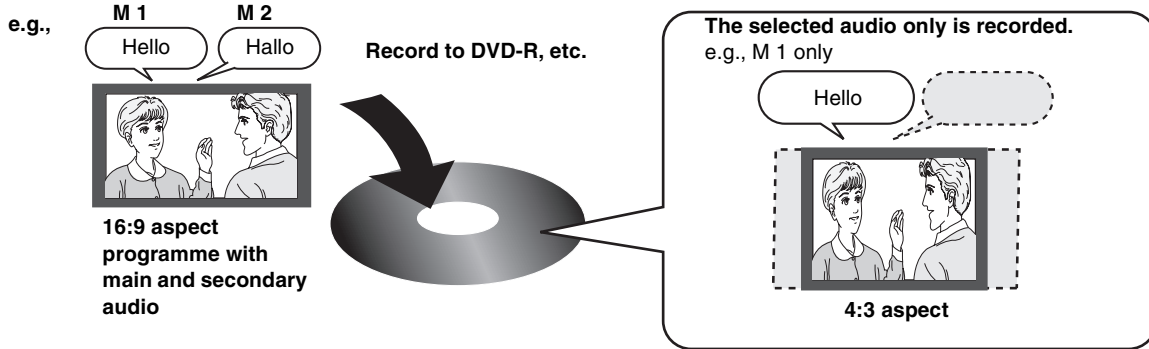

Therefore, follow the steps below when you use DVD-R, etc.

■ When recording a bilingual programme to DVD-R, etc.

Select the audio to record before recording or transferring (dubbing).

Some television programmes are broadcast with main (M 1) or secondary audio (M 2). You have to select the audio recording type before recording them to DVD-R, etc.

- When recording from TV tuner

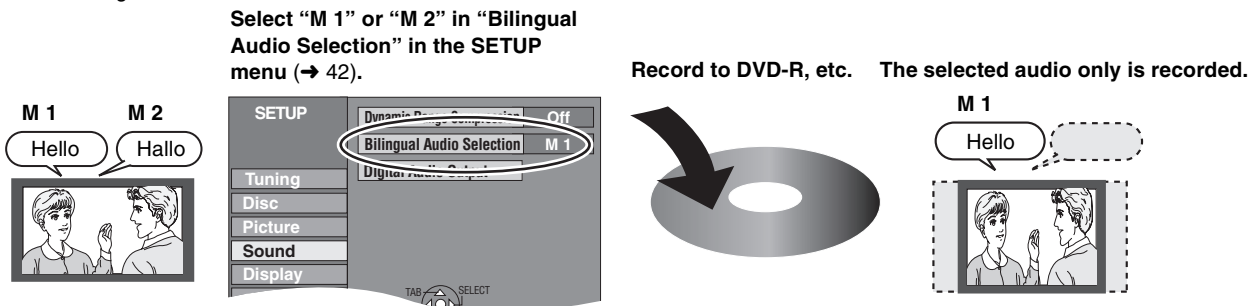

- When recording from the external equipment or transferring (dubbing) from VHS
- Select M 1 or M 2 on the external equipment or VHS.

■ Playing the disc on other DVD players

The disc must be finalized after recording or transferring (dubbing) (→ 29).

It is necessary to finalize DVD-R, etc. on this unit after recording or transferring (dubbing) titles to them. You can then play them as a commercially sold DVD-Video. However the discs become play-only and you can no longer record or transfer (dub).*

* You can record and transfer (dub) again if you format DVD-RW.

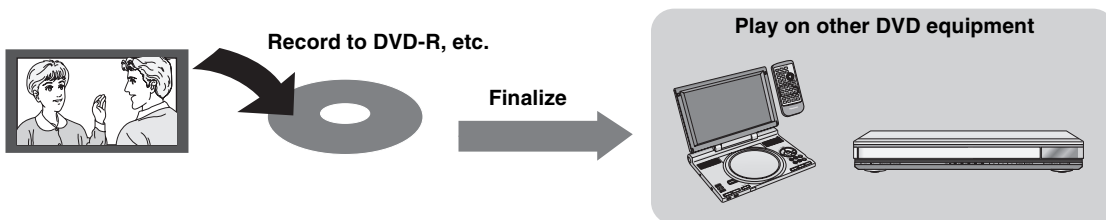

Getting started

Remote control

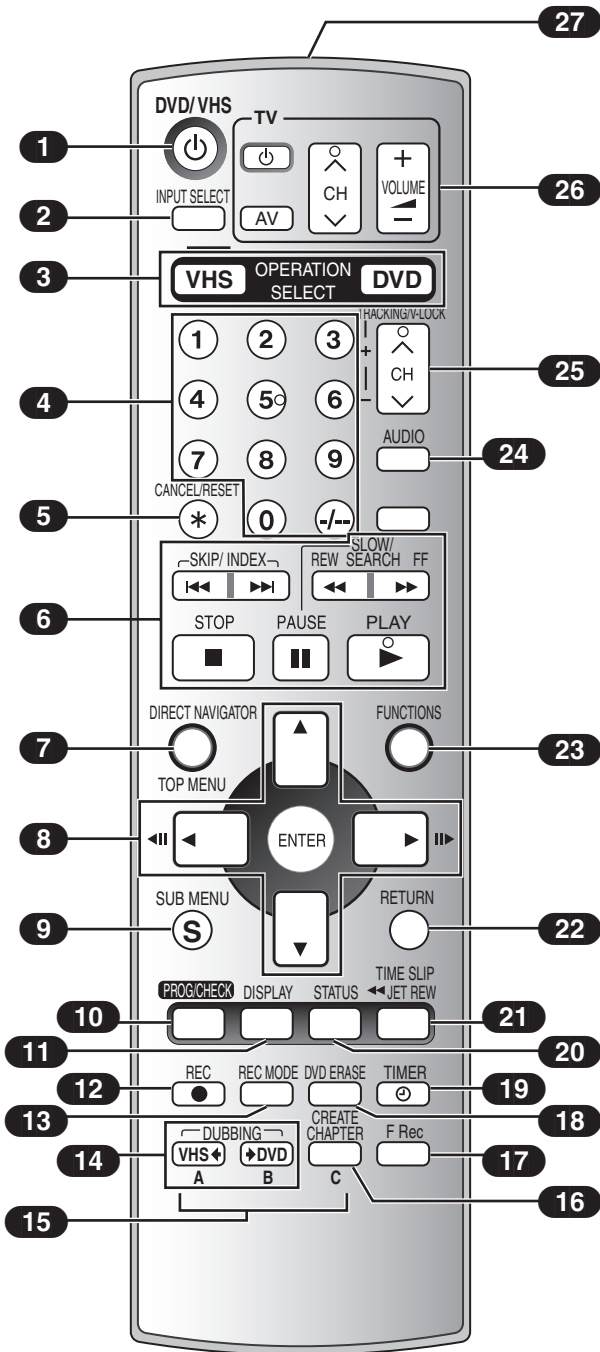

■ [VHS] and [DVD] button 3

[DVD]

- Before performing DVD operations, be sure to press the [DVD] button. Also, make sure the DVD indicator lights up on the unit.



[VHS]

- Before performing VHS operations, be sure to press the [VHS] button. Also, make sure the VHS indicator lights up on the unit.



- 1 Turn the unit on. → 16
- 2 Input select (AV1, AV2, AV3, TP or DC). → 65
- 3 Select drive (DVD or VHS) → above
- 4 Select channels and title numbers etc./Enter numbers
- 5 Cancel/Reset the tape counter
- 6 Basic operations for recording and play
- 7 Show Top menu/Direct Navigator → 21, 31
- 8 Selection/Enter, Frame-by-frame. → 16, 19
- 9 Show sub menu → 22, 31, 35
- 10 Show timer recording list. → 26, 52
- 11 Show DISPLAY menu → 38
- 12 Start recording → 23, 51, 59, 64, 65
- 13 Change recording mode → 23, 51
- 14 One touch transfer (dubbing) (DVD, VHS) → 57, 60
View select (A, B) → 61
- 15 Manual tuning operation (A, B, C). → 45
- 16 Create chapters. → 20
- 17 Start Flexible Recording → 24
- 18 Erase items → 20
- 19 Timer recording standby/release → 26, 52
- 20 Show status messages → 47, 55
- 21 Skip the specified time/Display the TV image as a picture-in-picture (TIME SLIP). → 20, 25
Jet rewind button (JET REW) → 49
- 22 Return to previous screen
- 23 Show FUNCTIONS window → 47
Show VHS FUNCTIONS menu → 54
- 24 Select audio. → 21, 55
- 25 Channel select → 23, 51
TRACKING/V-LOCK → 50
- 26 TV operations → 17, 24, 51
- 27 Transmission window

Note

- Buttons such as the [●, REC] button do not protrude as much as other buttons to stop them from being pressed accidentally.
- The word "button" is not used in these operating instructions so "Press the [ENTER] button." is shown as "Press [ENTER]."
- You can use this remote control to operate your TV if you set the TV manufacturer code (→ 17).

Getting started

Batteries and remote control

About batteries

- Insert so the poles (+ and -) match those in the remote control.
- Do not use rechargeable type batteries.

Do not:

- mix old and new batteries.
- use different types at the same time.
- heat or expose to flame.
- take apart or short circuit.
- attempt to recharge alkaline or manganese batteries.
- use batteries if the covering has been peeled off.

Mishandling of batteries can cause electrolyte leakage which can damage items the fluid contacts and may cause a fire.

Remove if the remote control is not going to be used for a long period of time. Store in a cool, dark place.

Note

- If you cannot operate the unit or TV using the remote control after changing the batteries, please re-enter the codes (→ 17).

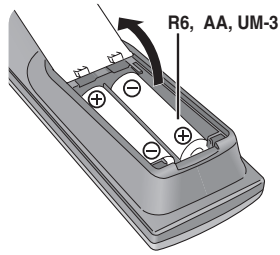

How to use the remote control

Aim at the sensor, avoiding obstacles, at a maximum range of 7 m directly in front of the unit.

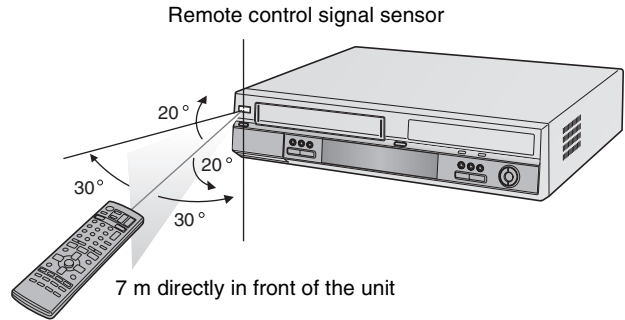

Note

- Keep the transmission window and the unit's sensor free from dust.
- Operation can be affected by strong light sources, such as direct sunlight, inverter fluorescent lamps, and the glass doors on cabinets.

Main unit

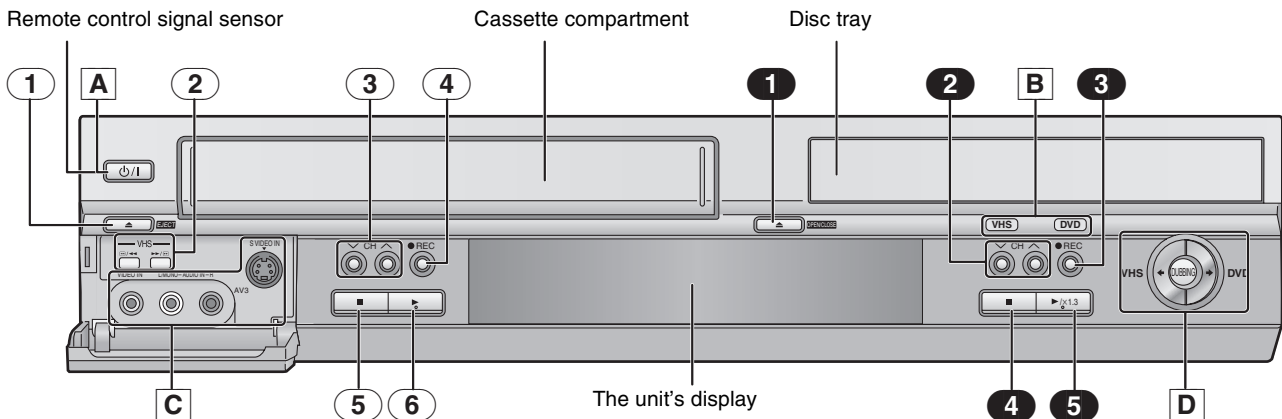

Common to DVD/VHS

- A** Standby/on switch (⏻/⏻) → 16
Press to switch the unit from on to standby mode or vice versa. In standby mode, the unit is still consuming a small amount of power.
- B** DVD/VHS drive indicator
• Lights when the DVD or VHS drive is selected.
- C** AV3 input terminals (AV3) → 65
- D** One Touch Transfer (Dubbing) operation button
• From VHS to DVD → 57
• From DVD to VHS → 60

DVD

- 1** Disc tray open/close button (⏻, OPEN/CLOSE) → 8
- 2** DVD Channel up/down buttons (CH, ⏶, ⏷) → 23
- 3** DVD Recording button (●, REC) → 23
- 4** DVD Stop button (■) → 19
- 5** DVD Play/x1.3 button (▶/x1.3) → 19

VHS

- 1** Cassette eject button (⏻, EJECT) → 48
- 2** VHS Search buttons (⏪/⏩, ⏴/⏵)
- 3** VHS Channel up/down buttons (CH, ⏶, ⏷) → 50, 51
- 4** VHS Recording button (●, REC) → 51
- 5** VHS Stop button (■) → 49
- 6** VHS Play button (▶) → 49

Getting started

The unit's display

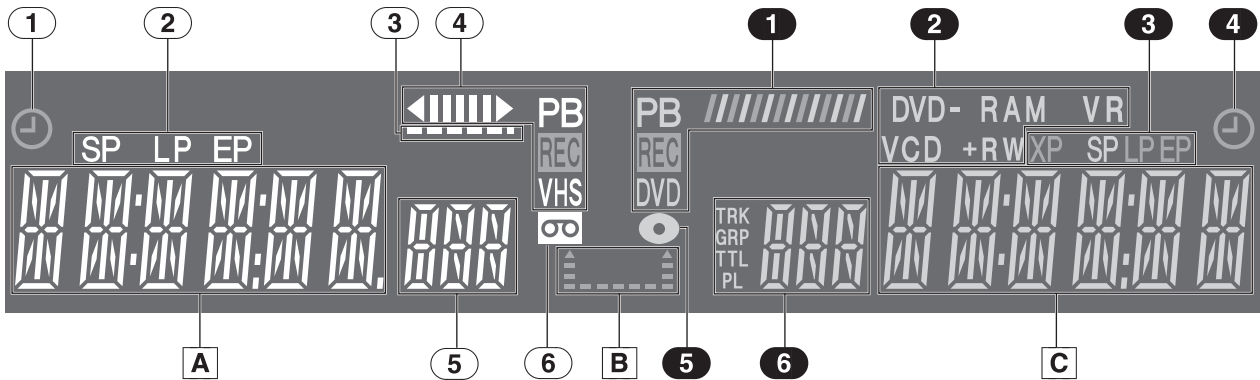

Common to DVD/VHS

- A Main display**
 - Current time
 - VHS recording and play counter
 - Miscellaneous messages, etc.
- B Transferring (Dubbing) direction indicator**
- C Main display**
 - Disc recording and play counter
 - Miscellaneous messages, etc.

VHS

- 1 Timer recording indicator (⊖) (→ 52)**

On:
When a timer recording programme is registered and recordable tape is inserted.

Flashes:
When the unit cannot record a timer recording programme (e.g. there is no tape, the unit is not on standby, etc.).
- 2 Recording mode indicator (→ 51)**
 - SP: When recording or playing in Normal mode.
 - LP: When recording or playing in Long play mode.
 - EP: When recording or playing in Extra long play mode.
- 3 Remaining tape time indicator**
- 4 Tape operation status**
 - The operation status of the unit, such as playback or fast-forward, is displayed.
- 5 Channel**
- 6 Tape indicator**

DVD

- 1 Disc operation status**
- 2 Disc type**
- 3 Recording mode indicator (→ 23)**
 - XP SP LP EP (all on): FR mode (→ 24)
- 4 Timer recording indicator (⊖) (→ 26)**

On:
When a timer recording programme is registered and a recordable disc is inserted.

Flashes:
When the unit cannot record a timer recording programme (e.g. there is no disc, the unit is not on standby, etc.).
- 5 Disc indicator**
- 6 Channel position indicator**
 - TRK:** Track number
 - GRP:** Group number
 - TTL:** Title number
 - PL:** Playlist number

Accessories

 Please check and identify the supplied accessories. Use numbers indicated in parentheses when asking for replacement parts. (Product numbers correct as of April 2005. These may be subject to change.)

2 AC mains leads



1 RF coaxial cable



For Saudi Arabia

1 Remote control (EUR7720KX0)



• For use with the unit only. Do not use it with other equipment. Also, do not use cords belonging to other equipment with the unit.

1 Audio/Video cable



2 Batteries for the remote control R6 size

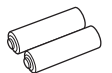

Getting started

STEP 1 Connection

- Please read "Precautions". (→ 3)
- Before connection, turn off all equipment and read the appropriate operating instructions.

■ Connecting a TV

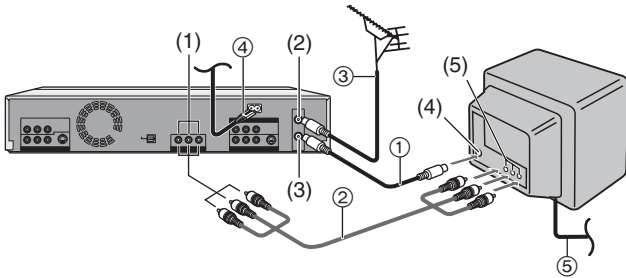

■ Connect as following steps

- ① RF Coaxial cable (supplied)
- ② Audio/Video cable (supplied)
- ③ Aerial lead (not supplied)
- ④ AC mains leads (supplied)
 - Use the AC mains lead that matches the socket for the area you live in.
- ⑤ AC mains leads (not supplied)

Sockets

- (1) Audio/Video Output sockets (DVD/VHS COMMON OUT)
- (2) Aerial Input socket
- (3) Aerial Output socket
- (4) Aerial Input socket
- (5) Audio/Video Input sockets

■ Do not connect the unit through a video cassette recorder

Video signals sent through video cassette recorders will be affected by copyright protection systems and the picture will not be shown correctly on the TV.

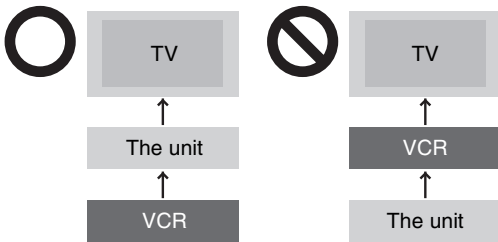

- When connecting the unit to a TV with a built-in VCR, connect to the input terminals on the TV, not the VCR.

■ Connection examples with other equipment

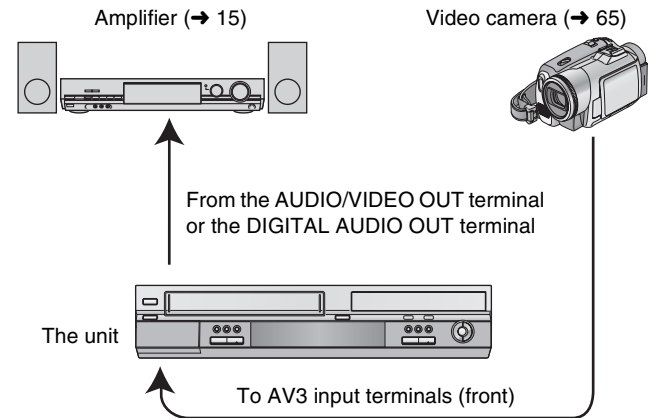

For your reference

- The equipment connections described are examples.
- Peripheral equipment and optional cables are sold separately unless otherwise indicated.

■ When the unit is not to be used for a long time

To save power, unplug it from the household mains socket. The unit consumes a small amount of power even when it is turned off.

Standby power consumption

		Power Save (→ 43)	
		On	Off
Quick Start (→ 43)	On	—	Approx. 15 W
	Off	Approx. 4 W	Approx. 7 W

- When "Power Save" is set to "On", the "Quick Start" function does not work.

■ Quick Start (→ 43)

1 Sec. Quick Start for Recording on DVD-RAM*

* From the power off state, recording on DVD-RAM starts about 1 second after first pressing the [⏪, DVD/VHS] and then sequentially pressing the [●, REC] (Quick Start Mode).

Getting started

■ Connecting an amplifier or system component

▶ To enjoy multi-channel surround sound on DVD-Video (digital connection)

DVD only

- Connect an amplifier with a built-in Dolby Digital or DTS decoder. (→ 7)
- Change the settings in "Digital Audio Output". (→ 42)
- You cannot use any amplifier with a DTS Digital Surround decoder not suited to DVD.
- Even if using this connection, output will be only 2 channels when playing DVD-Audio.

- (1) Rear panel of the unit
- (2) Optical digital output terminal
- (3) **Optical digital audio cable** (not supplied)
Do not bend when connecting.
A Insert fully, with this side facing up.
- (4) Optical digital input terminal
- (5) Amplifier's rear panel

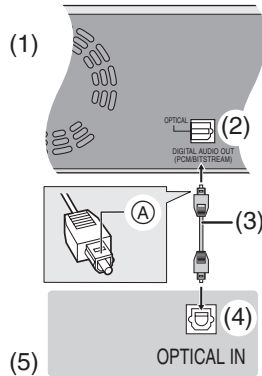

▶ Connection to a stereo amplifier (analog connection)

DVD only

- (1) Rear panel of the unit
- (2) Audio output terminals (L/R)
- (3) Audio cable (not supplied)
A Red (R)
B White (L)
- (4) Audio input terminals (L/R)
- (5) Amplifier's rear panel

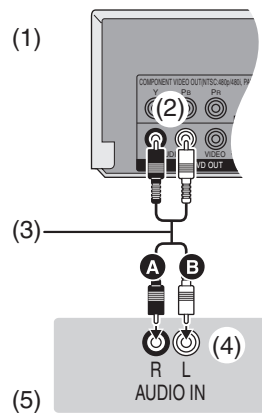

■ DVD output and DVD/VHS output

The unit has DVD/VHS COMMON OUT terminals and DVD OUT terminals.

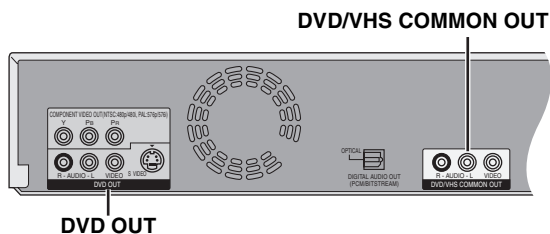

DVD/VHS COMMON OUT

- For DVD/VHS COMMON OUT terminals, both DVD and VHS signals can be output.

DVD OUT

- This is the dedicated terminal to enjoy pictures played on DVD in higher picture quality. (→ right)
- The DVD OUT terminals can only output the DVD signal. If your TV is connected to the DVD OUT terminals, the VHS picture is not displayed on your TV unless you select the TP channel (→ 59).

■ To enjoy even higher fidelity

▶ Connection to the S Video terminal

DVD only

S VIDEO OUT terminal

The S VIDEO OUT terminal achieves a more vivid picture than the VIDEO OUT terminal. (Actual results depend on the TV.)

- (1) Audio input terminals (L/R)
- (2) S Video input terminal
- (3) Audio cable (not supplied)
A Red (R)
B White (L)
- (4) S Video cable (not supplied)
- (5) Rear panel of the unit
- (6) Audio output terminals (L/R)
- (7) S Video output terminal

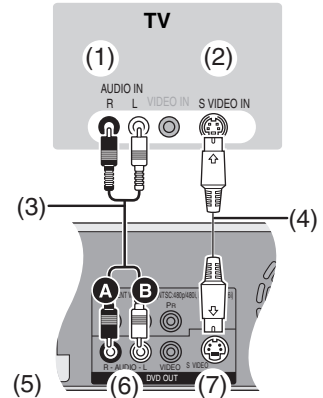

▶ Connection to the component video terminals

DVD only

COMPONENT VIDEO OUT terminal

These terminals can be used for either interlace or progressive output (→ 66) and provide a purer picture than the S VIDEO OUT terminal.

Connection using these terminals outputs the colour difference signals (Pb/Pr) and luminance signal (Y) separately in order to achieve high fidelity in reproducing colours.

If the TV is compatible with progressive output, a high quality picture can be output because the unit's component video output terminal outputs a progressive output signal.

- For progressive output → 18

- Connect to terminals of the same colour.

- (1) Audio input terminals (L/R)
- (2) Component input terminals
- (3) Audio cable (not supplied)
A Red (R)
B White (L)
- (4) Video cables (not supplied)
- (5) Rear panel of the unit
- (6) Component video output terminals
- (7) Audio output terminals (L/R)

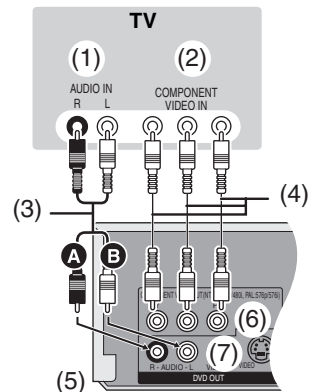

Getting started

STEP 2 Auto-Setup

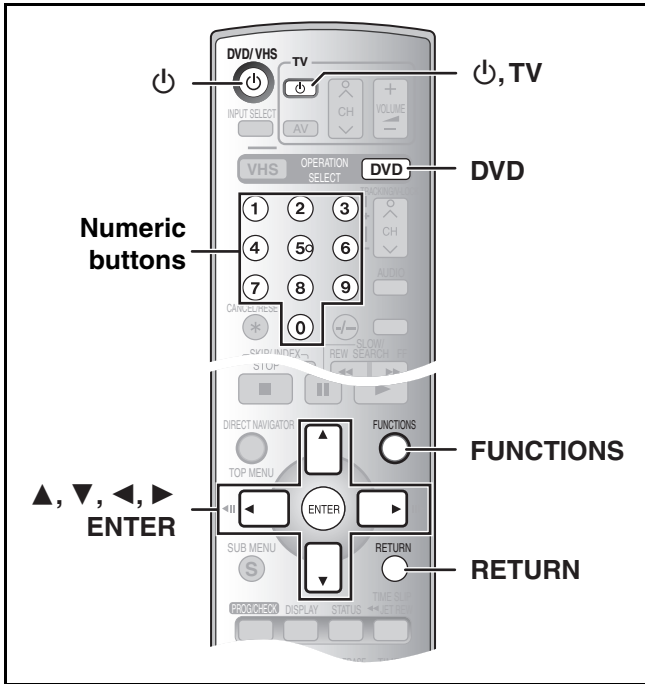

Preparation

- Press [DVD].

■ Auto-Setup

Auto-Setup automatically tunes all available stations.

- 1 Switch on the TV.**
- 2 Select the AV input on your TV.**
- 3 Press [⏻, DVD/VHS] to switch the unit on.**
- 4 Select the country with [▲, ▼].**
 - Select "Others".



- 5 Press [ENTER].**

- Auto-Setup starts. This takes about 5 minutes.



Auto-Setup is complete when you see the clock setting menu.

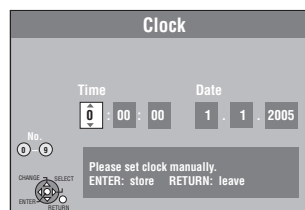

- 6 Press [◀, ▶] to select the item you want to change.**

This is a 24-hour clock.

The items change as follows:

Hour ↔ Minute ↔ Second ↔ Day ↔ Month ↔ Year

Reset the clock regularly to maintain accuracy (→ 46).

- 7 Press [▲, ▼] to change the setting.**

You can also use the numeric buttons for setting.

- 8 Press [ENTER] when you have finished the settings.**

The clock starts and the television displays the channel being received.

■ To stop in the middle

Press [RETURN].

To confirm that stations have been tuned correctly (→ 44)

To restart Auto-Setup (→ 45)

You can also use the following method to restart Auto-Setup. When the unit is on and stopped.

Press and hold down [▲, CH] and [CH, ▼] on the DVD main unit simultaneously for about 5 seconds.

- All the settings except for the ratings level including the password and time settings return to the factory preset. The timer recording programmes are also cancelled.

Getting started

STEP 3 Set up to match your TV and remote control

Preparation

- Press [DVD].

■ When other Panasonic products respond to this remote control

Change the remote control code on the main unit and on the remote control (the two must match) if you place other Panasonic products close together. When changing the remote control code, make sure the two codes are same.

Use "MODE 1", the factory set code, under normal circumstances.

- 1 While stopped
Press [FUNCTIONS].
- 2 Select "To Others" with [▲, ▼] and press [ENTER].

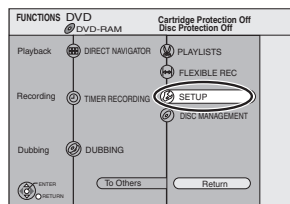

- 3 Select "SETUP" with [▲, ▼] and press [ENTER].
- 4 Select "Others" with [▲, ▼] and press [◀, ▶].
- 5 Select "Remote Control" with [▲, ▼] and press [ENTER].
- 6 Use [▲, ▼] to select the code ("MODE 1", "MODE 2" or "MODE 3") and press [ENTER].
 - The code on the unit has been set.
- 7 While pressing [ENTER], press and hold for about 2 seconds the numeric button ([1], [2] or [3]) corresponding to the code you selected in step 6.
 - The code on the remote control has been set.
- 8 Press [ENTER].

■ When the following indicator appears on the unit's display



Change the code on the remote control to match the main unit's code (→ step 7).

■ Selecting TV type

Choose the setting to suit your television and preference.

- 1 While stopped
Press [FUNCTIONS].
- 2 Press [▲, ▼] to select "To Others" and press [ENTER].

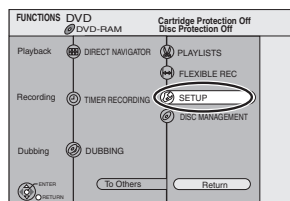

- 3 Press [▲, ▼] to select "SETUP" and press [ENTER].
- 4 Press [▲, ▼] to select "Connection" and press [◀, ▶].
- 5 Press [▲, ▼] to select "TV Aspect" and press [ENTER].
- 6 Press [▲, ▼] to select the TV aspect and press [ENTER].

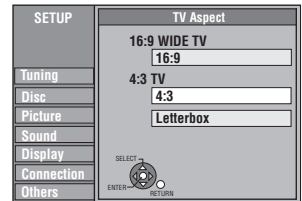

- **16:9:** 16:9 widescreen television
- **4:3:** 4:3 aspect television

RAM Titles are recorded as they appear on screen.

DVD-V Video recorded for a widescreen is played as Pan & Scan (unless prohibited by the producer of the disc) (→ 66).

- **Letterbox:** 4:3 aspect television
Widescreen picture is shown in the letterbox style (→ 66).

■ TV operation

To turn the TV on/off, change the TV input mode, select the TV channel and change the TV volume by means of this remote control, set the remote control as follows.

Point the remote control at the TV

While pressing [TV], enter the code using the numeric buttons.

e.g., 01: press [0] → [1].

Manufacturer and Code No.

Brand	Code
Panasonic/National	01/02/03/04
GOLDSTAR/LG	15/16
HITACHI	08
JVC	07
MITSUBISHI	09/10
NEC	13
PHILIPS	12
SAMSUNG	17/18
SANYO	14/19
SHARP	11
SONY	05
TOSHIBA	06

- Test by turning on the TV and changing channels. Repeat the procedure until you find the code that allows correct operation.
- If your TV brand is not listed or if the code listed for your TV does not allow control of your TV, this remote control is not compatible with your TV.

■ To return to the previous screen
Press [RETURN].

■ To exit the screen
Press [RETURN] several times.

Getting started

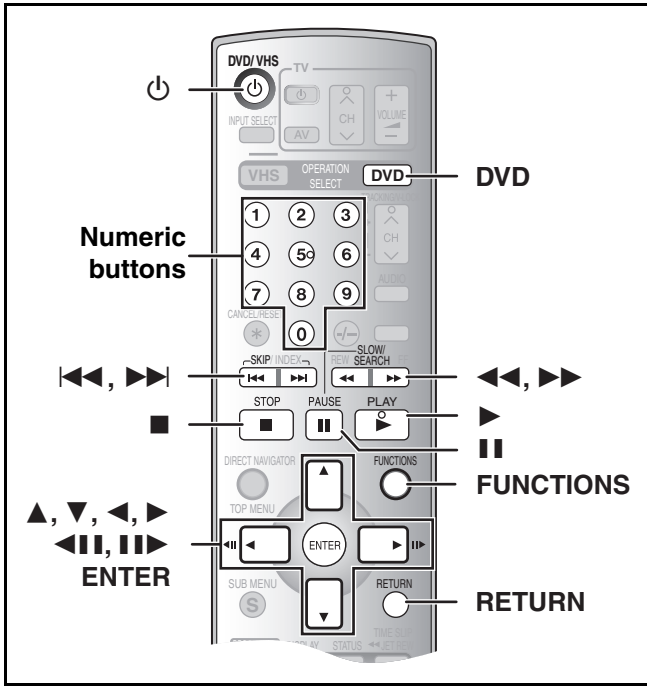

Preparation

- Press [DVD].

To enjoy progressive video

You can enjoy progressive video by connecting the unit's COMPONENT VIDEO OUT terminals to an LCD/plasma television or LCD projector compatible with progressive scan (→ 66).

- 1 While stopped
Press [FUNCTIONS].
- 2 Press [▲, ▼] to select "To Others" and press [ENTER].
- 3 Press [▲, ▼] to select "SETUP" and press [ENTER].
- 4 Press [▲, ▼] to select "Connection" and press [◀, ▶].
- 5 Press [▲, ▼] to select "Progressive" and press [ENTER].
- 6 Press [▲, ▼] to select "On" and press [ENTER].
Output becomes progressive.

Note

- When connected to a regular television (CRT: Cathode ray tube) or a multi system television using PAL mode, even if it is progressive compatible, progressive output can cause some flickering. Turn off "Progressive" if this occurs (→ 39).
- If the unit is connected to the television through VIDEO OUT or S VIDEO OUT terminal, output will be interlace irrespective of the settings.

To return to the previous screen

Press [RETURN].

To exit the screen

Press [RETURN] several times.

Note to owners of progressive compatible PAL system televisions

- If you have an LCD/plasma television or LCD projector Using progressive output, you can enjoy high-resolution video recorded on media such as DVD-Video. Connect this unit's component video output terminals to your television and turn on the progressive output setting (→ 15, left).

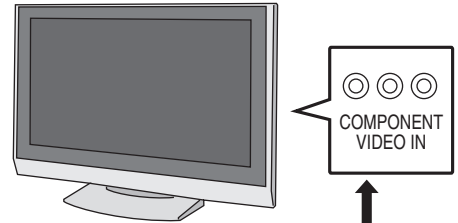

Progressive output

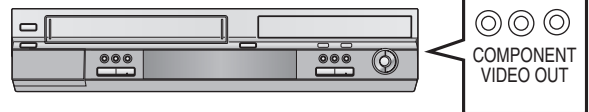

- If you have a regular television (CRT: cathode ray tube) Use component output with progressive "Off" (factory setting → 42), even if it is progressive compatible, because progressive output can cause some flickering. This is the same for multi system televisions using PAL mode.

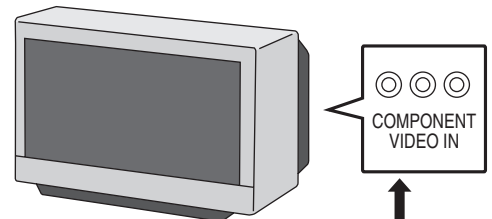

Progressive output

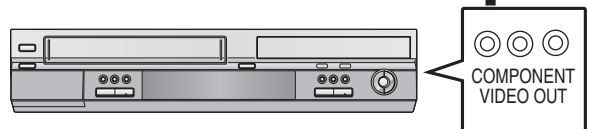

Preparation

- Select the unit viewing channel (e.g. AV input) on the TV.
- Press [DVD].

Playing discs

RAM -R -RW(V) +R DVD-A DVD-V -RW(VR) VCD CD

1 Press [⏻, DVD/VHS] to turn the unit on.

2 Insert a disc. (→ 8)

3 Press [▶, PLAY].

- The disc tray closes and play begins. (The unit takes some time to read the disc before play starts.)
- Playback starts from the most recently recorded title.

RAM -R -RW(V) +R -RW(VR)

- Playback starts from the beginning of the disc.

DVD-A DVD-V VCD CD

To stop play

Press [■, STOP]. (→ right, Resume Function)

- The screen saver on the right may appear when you stop play. Press [■, STOP] again and you can use the unit's tuner to watch TV.

DVD-A DVD-V VCD CD

Screen saver



To pause play

Press [⏸, PAUSE]. (Press again to restart play.)

When a menu screen appears on the TV

VCD

Press the numeric buttons to select an item.

e.g.: "5": [0]→[5]

"15": [1]→[5]

DVD-A DVD-V

Press [▲, ▼, ◀, ▶] to select an item and press [ENTER].

- You can sometimes use the numeric buttons to select an item.

Other buttons used to operate menus

Read the disc's instructions for further details about operation.

Note

- If "⊙" appears on the TV, the operation is prohibited by the unit or disc.

Quick View (Play ×1.3)

RAM

The play speed can be increased without distorting the audio.

During Play

Press and hold [▶, PLAY].



To return to normal speed

Press [▶, PLAY].

Starting play from where you stopped it (Resume Function)

RAM -R -RW(V) +R DVD-A DVD-V -RW(VR) VCD CD

1 During Play

Press [■, STOP].

- The unit memorizes the position. When stop position is memorized (resume), the indicator on the right appears in the unit's display. (Excluding when playing from the Direct Navigator and when playing a playlist.)



2 Press [▶, PLAY].

- Play starts from where you stopped it.

To cancel the resume function

Press [■, STOP] several times until the indicator disappears.

(This function is also canceled when you turn the unit off or the tray is opened.)



Fast forward and rewind — SEARCH

RAM -R -RW(V) +R DVD-A DVD-V -RW(VR) VCD CD

During Play

Press [◀◀, SLOW/SEARCH] or [▶▶, SLOW/SEARCH].

e.g., DVD-RAM



- There are 5 search speeds. Each press increases the search speed.
- Press [▶, PLAY] to restart playback.

For your reference

- Sound is output only in the first level of fast forward. In the case of DVD-Audio (except motion picture parts), CD and MP3, it is output in all levels.
- Depending on the disc, search may not be possible.

Skipping

RAM -R -RW(V) +R DVD-A DVD-V -RW(VR) VCD CD

During play or while paused

Press [◀◀, SKIP] or [▶▶, SKIP].

- Each press increases the number of skips.

Slow-motion play

RAM -R -RW(V) +R DVD-A (Motion picture parts only) DVD-V -RW(VR) VCD

While paused

Press [◀◀, SLOW/SEARCH] or [▶▶, SLOW/SEARCH].

- When slow motion play is continued for about 5 minutes it pauses automatically (excluding DVD-A DVD-V VCD).
- There are 5 play speeds. Each press increases the play speed.
- Press [▶, PLAY] to restart playback.
- VCD Forward direction [▶▶, SLOW/SEARCH] only.

Frame-by-frame viewing

RAM -R -RW(V) +R DVD-A (Motion picture parts only) DVD-V -RW(VR) VCD

While paused

Press [◀◀◀] ([◀]) or [▶▶▶] ([▶]).

- Each press shows the next or previous frame.
- Press and hold to change in succession forward or backward.
- Press [▶, PLAY] to restart playback.
- VCD Forward direction [▶▶▶] ([▶]) only.

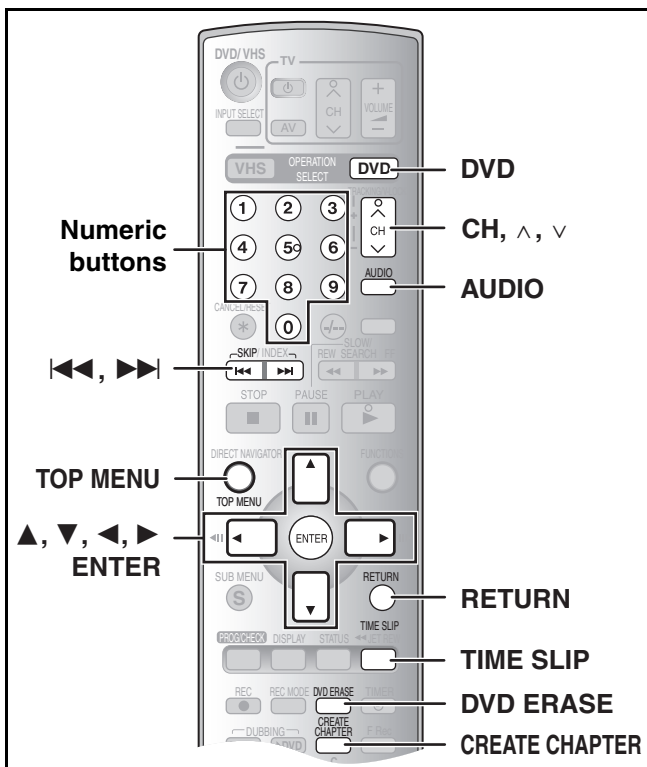

Preparation

- Press [DVD].

Direct play

RAM -R -RW(V) +R DVD-A DVD-V -RW(VR) VCD CD

You can play from the title, chapter or track you select.

During Play

Press the numeric buttons to select an item.

[CD] (MP3, JPEG and TIFF disc only)

e.g.: "5": [0]→[5] "5": [0]→[0]→[5]
 "15": [1]→[5] "15": [0]→[1]→[5]

DVD-A

A group number can be specified while the screen saver (→ 19) is displayed.

e.g.: "5": [5]

- This works only when stopped (screen saver is displayed) with some discs.
- **Playing bonus groups**
 Some discs contain bonus groups. If a password screen appears after selecting a group, enter the password with the numeric buttons and press [ENTER]. For the password, refer to the disc's jacket, etc.

Erasing a title that is being played

RAM -R -RW(V) +R

Once title is erased, it cannot be restored. Make certain before proceeding.

- 1 **During Play**
Press [DVD ERASE].
- 2 Press [◀] to select "Erase" and press [ENTER].

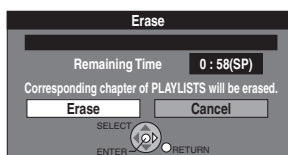

For your reference

- You cannot erase while recording or transferring (dubbing).
- -R +R Available space does not increase after erasing.
- -RW(V) Disc space increases only when the last recorded title is erased.

Displaying the TV image as a picture-in-picture/Selecting an amount of time to skip — Time Slip

RAM -R -RW(V) +R -RW(VR)

Press [TIME SLIP] during play and the PIP (Picture-In-Picture) screen (TV image) is displayed in the lower right part of the main screen. You can watch both playback images and TV images at the same time. In the main screen, you can also instantly access a scene you want to view by specifying an amount of time you want to skip.

1 During play

Press [TIME SLIP].

- The PIP screen (TV images) appears.
- You can change the channel being received by pressing [CH, ^, v].
- You will hear the playback audio of the main screen.

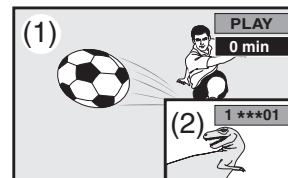

(1) Play images
 (2) Currently receiving images

2 While observing the time indicator at the top right

Press [▲, ▼] to set an amount of time to skip and press [ENTER].

- Play skips the amount of time you specified.
- The time indicator will go off after about 5 seconds, but will turn on again when you set the time.
- Press [▲, ▼] to alter in 1-minute units. Press and hold [▲, ▼] to alter in 10-minute units.



To clear the PIP screen

Press [TIME SLIP].

For your reference

- The grey background does not appear on the PIP screen (→ 42).
- You cannot change the channel being received while the PIP screen is being recorded.

Create chapters

RAM

During play

Press [CREATE CHAPTER].

- Press [◀◀, SKIP] or [▶▶, SKIP] to skip to the start of a chapter.
- You cannot activate this function when you are carrying out time slip (→ above, 25) or transfer (dub).
- You cannot create chapters when the unit is in the timer recording standby mode.

Changing audio during play

Press [AUDIO] to select the audio type.

- You can select audio types depend on the recording medium.

RAM -RW(VR) VCD
 LR→L→R
 ↑

e.g.: **RAM**
"L R" is selected.

DVD-RAM PLAY
 L R

DVD-A DVD-V (→ 38)
 This allows you to change items like the audio channel number and the soundtrack language.

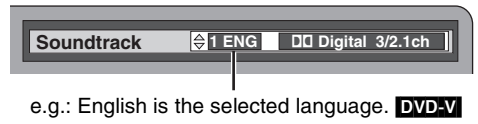

Note

- If you cannot change the audio type when you have used only an optical digital cable for connection, set "Dolby Digital" to "PCM" (→ 42). Alternatively, you may connect to an amplifier with an Audio/Video cable and change the input on the amplifier to suit the connection.

Playing discs which contain both MP3 and still pictures

CD

The screen shown below is displayed when you insert a disc containing MP3 files and still pictures (JPEG/TIFF).

Press [ENTER].

- To play MP3**
Refer to "Using menus to play MP3 discs" (→ right)
- To play still pictures**
Refer to "To show JPEG Menu" (→ 22)

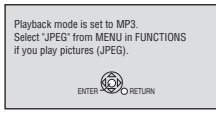

- You can play MP3 and still pictures (JPEG/TIFF) on this unit by making folders as shown below. However depending on how you create the disc (writing software), play may not be in the order you numbered the folders.
- English alphabetical characters and Arabic numerals are displayed correctly. Other characters may not be displayed correctly.
- When the highest level folders are "DCIM" folders, they are displayed first on the tree.

Structure of MP3 folders

Prefix with 3-digit numbers in the order you want to play them.

```

Tree
├── 001 A
│   ├── 001track.mp3 B
│   ├── 002track.mp3
│   └── 003track.mp3
├── 002 A
│   ├── 001track.mp3
│   ├── 002track.mp3
│   ├── 003track.mp3
│   └── 004track.mp3
└── 003 A
    ├── 001track.mp3
    ├── 002track.mp3
    └── 003track.mp3
                
```

Order of play

Structure of still pictures (JPEG/TIFF)

Files inside a folder are displayed in the order they were updated or taken.

```

Root
├── P0000001.jpg
├── P0000002.jpg
├── 002 C
│   ├── P0000003.jpg
│   ├── P0000004.jpg
│   └── P0000005.jpg
├── 003 C
│   ├── P0000006.jpg
│   ├── P0000007.jpg
│   ├── P0000008.jpg
│   └── P0000009.jpg
└── 004 C
    ├── P0000010.jpg
    ├── P0000011.jpg
    └── P0000012.jpg
                
```

Order of play

A Folder = Group
B File = Track
C Folder

Regarding MP3 and still pictures (JPEG/TIFF)

- Compatible formats: ISO9660 level 1 or 2 (except for extended formats) and Joliet
- Maximum number of files (tracks) and folders (groups) recognizable: 999 files (tracks) and 99 folders (groups)
- This unit is compatible with multi-session but reading or play of the disc may take time if there are a lot of sessions.
- Operation may take time to complete when there are many files (tracks) and/or folders (groups) and some files (tracks) may not display or be playable.
- The display order on this unit may differ from how the order is displayed on a computer.
- Depending on how you create the disc (writing software), files (tracks) and folders (groups) may not play in the order you numbered them.
- This unit is not compatible with packet-write format.
- Depending on the recording, some items may not be playable.

Regarding MP3

- File format: MP3
Files must have the extension ".mp3" or ".MP3".
- Bit rates: 32 kbps to 320 kbps
- Sampling frequency: 16 kHz/22.05 kHz/24 kHz/32 kHz/44.1 kHz/48 kHz
- This unit is not compatible with ID3 tags.

Regarding still pictures (JPEG/TIFF)

- File format: JPEG, TIFF (non-compressed RGB chunky format)
Files must have the extension ".jpg", ".JPG", ".tif" and ".TIF".
- Number of pixels: 34×34 to 6144×4096
(Sub sampling is 4:2:2 or 4:2:0)
- Operation may take time to complete when playing TIFF format still pictures.
- MOTION JPEG is not supported.

Using menus to play MP3 discs

CD

The unit plays MP3 files recorded on CD-R/RW designed for audio recording that are finalized (→ 66) on a computer. Files are treated as tracks and folders are treated as groups.

1 During stop or play Press [TOP MENU].

- The file list appears.

Selected Group No. and Name

G:
The Group Number

T:
Track Number in the Group

TOTAL:
Selected Track Number/
Total Track Number

2 Press [▲, ▼] to select the track and press [ENTER].

- Play starts on the selected track.
 - "□" indicates the track currently playing.
 - You can also directly select the track with the numeric buttons.
- e.g.:
- "6": [0] → [0] → [6]
 "10": [0] → [1] → [0]

Using the tree screen to find a group (→ 22)

To show other groups

Press [◀] (Prev.) or [▶] (Next) to show other pages.

- After listing all the tracks in one group, the list for the next group appears.

To exit the file list

Press [TOP MENU] or [RETURN].

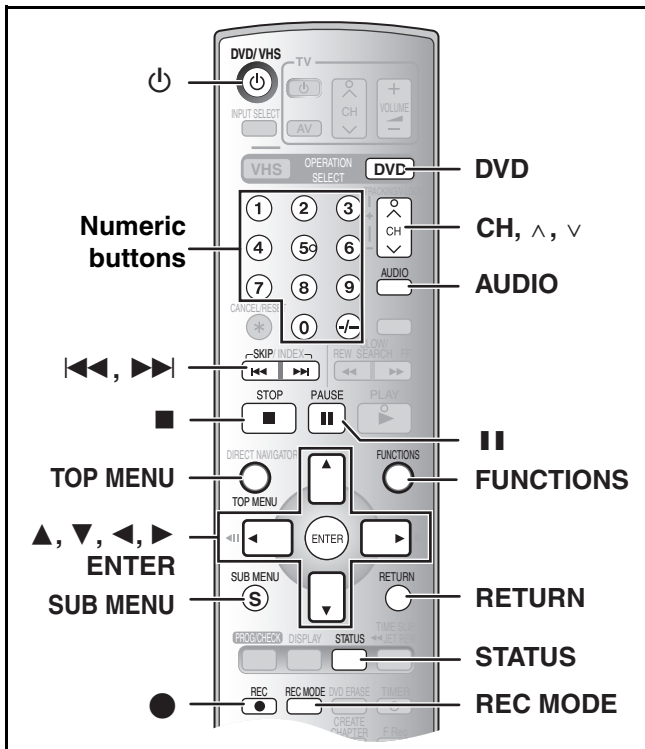

Preparation

- Press [DVD].

Using the tree screen to find a group

- 1 While the file list is displayed (→ 21)
Press [▶] while a track is highlighted to display the tree screen.



Selected Group Number/Total Group Number

- If the group has no track, “—” is displayed as group number.

- A folder which has no MP3 files is indicated in black. You cannot select groups with no MP3 files.
- Press [◀, ▶] to jump layers in the tree screen.

- 2 Press [▲, ▼] to select a group and press [ENTER].
 - The file list for the selected group appears.

To return to the file list

Press [RETURN].

To show JPEG Menu

[CD] [with MP3 files and still pictures (JPEG/TIFF)]

- 1 Press [FUNCTIONS].
- 2 Select “MENU” with [▲, ▼] and press [ENTER].
- 3 Select “JPEG” with [▲, ▼] and press [ENTER].

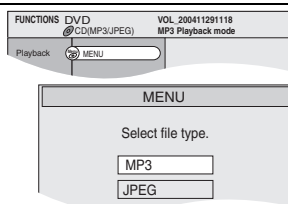

[CD] [with still pictures (JPEG/TIFF) only]

Press [TOP MENU].

To show other pages

Press [◀◀] (Previous) or [▶▶] (Next) to show other pages.

- You can also press [▲, ▼, ◀, ▶] to select “Previous” or “Next” and press [ENTER] to show other pages.

To exit the JPEG Menu

Press [TOP MENU] or [RETURN].

JPEG Menu screen

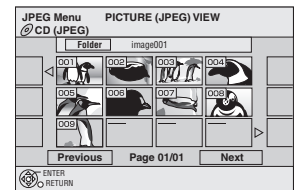

▶ Playing a still picture

- Make sure that JPEG Menu screen appears by following the steps “To show JPEG Menu”.

Use [▲, ▼, ◀, ▶] to select a still picture you want to watch and press [ENTER].

- You can also select a still picture by entering a 3-digit with the numeric buttons.
e.g.: “5”: [0]→[0]→[5] “15”: [0]→[1]→[5]
- You can watch the still pictures in order by pressing [◀] (previous) or [▶] (next).

To rotate a still picture

- 1 Press [SUB MENU].
- 2 Select “Rotate RIGHT” or “Rotate LEFT” with [▲, ▼] and press [ENTER].

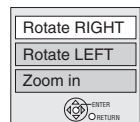

- Rotation information will not be stored.

To zoom in/out

- 1 Press [SUB MENU].
- 2 Select “Zoom in” with [▲, ▼] and press [ENTER].
 - To return the picture to its original size, repeat step 1 and press [▲, ▼] to select “Zoom out” in step 2 and then press [ENTER].
 - When zooming in, the still picture may be cut off.
 - The enlargement information will not be stored.
 - The “Zoom in”/“Zoom out” function is only available for still pictures smaller than 640×480 pixels.

To show the picture properties

- 1 Press [STATUS] twice.
- Press [STATUS] again, the properties disappear.

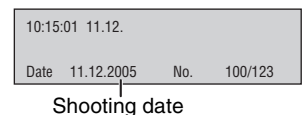

▶ Start Slide Show/Slide Interval

- Make sure that JPEG Menu screen appears by following the steps “To show JPEG Menu”.

You can display still pictures one by one with constant interval.

- 1 Select “Folder” with [▲] and press [SUB MENU].
- 2 Select “Start Slide Show” with [▲, ▼] and press [ENTER].

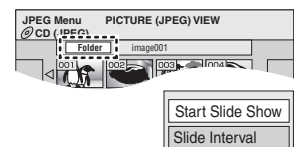

To Change the display timing

- 1 Select “Slide Interval” with [▲, ▼] in step 2 and press [ENTER].
- 2 Press [◀, ▶] to select the desired timing (0 to 30 seconds) and press [ENTER].

▶ To select the still pictures in another folder

- Make sure that JPEG Menu screen appears by following the steps “To show JPEG Menu”.

You can display still pictures one by one with a constant interval.

- 1 Select “Folder” with [▲] and press [ENTER].
- 2 Select the folder with [▲, ▼] and press [ENTER].

- Ⓐ Selected folder no./Total folder no.
- Ⓑ You cannot select folders that contain no compatible files.

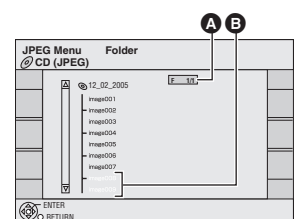

To return to the file list

Press [RETURN].

Recording TV programmes

Recording procedures

RAM **-R** **-RW(V)** **+R**

- You can record up to 99 titles on a disc (49 titles **+R**).
- It is not possible to record digital broadcasts that allow “One time only recording” onto DVD-R, DVD-RW, +R or 8 cm DVD-RAM discs. Use a CPRM compatible DVD-RAM.
- Recording will take place on open space on the disc. Data will not be overwritten.
- If there is no space left on the recording disc, you will need to erase unwanted titles (→ 20, 31) or use a new disc.

When recording to DVD-R, DVD-RW (DVD-Video format) or +R

- When recording bilingual TV broadcast
 - If you do not connect external equipment
Select “M 1” or “M 2” in “Bilingual Audio Selection” in the SETUP menu (→ 42).
 - If you connect external equipment
Select M 1 or M 2 on the external equipment.
- The aspect ratio of the recorded image will be 4:3.
- **In order to play a DVD-R, DVD-RW (DVD-Video format) or +R recorded using this unit on another playback source, the disc must first be finalized (→ 29).**

Preparation

- Select the unit viewing channel (e.g. AV input) on the TV.
- Release protection (disc → 28, cartridge → 28). **RAM**
- Press [DVD].

1 Insert a disc. (→ 8)

- If the “Format” screen appears (→ right, Format screen).

2 Press [CH, ▲, ▼] to select the channel.



To select with the numeric buttons:

e.g., 5: [5]
15: [-/-] → [1] → [5]

3 Press [REC MODE] to select the recording mode (XP, SP, LP or EP).



Remaining time on the disc

4 Press [●, REC] to start recording.

- You cannot change the channel or recording mode during recording. You can change them while recording is paused, but the material is recorded as a separate title.



- **RAM** You can change the audio being received by pressing [AUDIO] during recording. (Does not affect the recording of audio.)

To pause recording

Press [II, PAUSE]. (Press again to restart recording.)

- Title is not split into separate titles.
- You can also press [●, REC] to restart recording.

To stop recording

Press [■, STOP].

- Recorded as 1 title until the position where stopped.
- It takes about 30 seconds for the unit to complete recording management information after recording finishes. **-R** **-RW(V)** **+R**

Format screen

When you insert a new DVD-RW or a DVD-RAM/DVD-RW (DVD-Video format) recorded on a computer or other equipment, a format confirmation screen is displayed. Format the disc to use it. However, all the recorded contents are erased.

Press [◀] to select “Yes” and press [ENTER].

(For details → 29, Format Disc)

Recording modes and approximate recording times

(Unit: hour)

	DVD-RAM		DVD-R DVD-RW +R (4.7 GB)
	Single-sided (4.7 GB)	Double-sided (9.4 GB)	
XP (High quality)	1	2	1
SP (Normal)	2	4	2
LP (Long play)	4	8	4
EP (Extra long play)	8 (6*)	16 (12*)	8 (6*)

- Depending on the content being recorded, the recording times may become shorter than indicated.

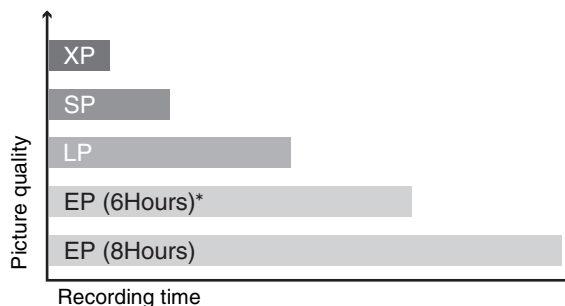

* When “Recording time in EP mode” has been set to “EP (6Hours)” in the SETUP menu. (→ 41)

The sound quality is better when using “EP (6Hours)” than when using “EP (8Hours)”.

Note

When recording to DVD-RAM using “EP (8Hours)” mode, play may not be possible on DVD players that are compatible with DVD-RAM. In this case use “EP (6Hours)” mode.

FR (Flexible Recording mode → 24):

- You can set FR mode when transferring (dubbing) or programming timer recordings.

Quick Start (→ 43)

1 Sec. Quick Start for Recording on DVD-RAM*

* From the power off state, recording on DVD-RAM starts about 1 second after first pressing the [⏏, DVD/VHS] and then sequentially pressing the [●, REC] (Quick Start Mode).

“Quick Start” is set to “On” at the time of purchase.

Note

- Startup takes up to a minute when:
 - You play a disc or start recording to discs other than DVD-RAM.
 - You want to make other operations.
 - The clock has not been set.

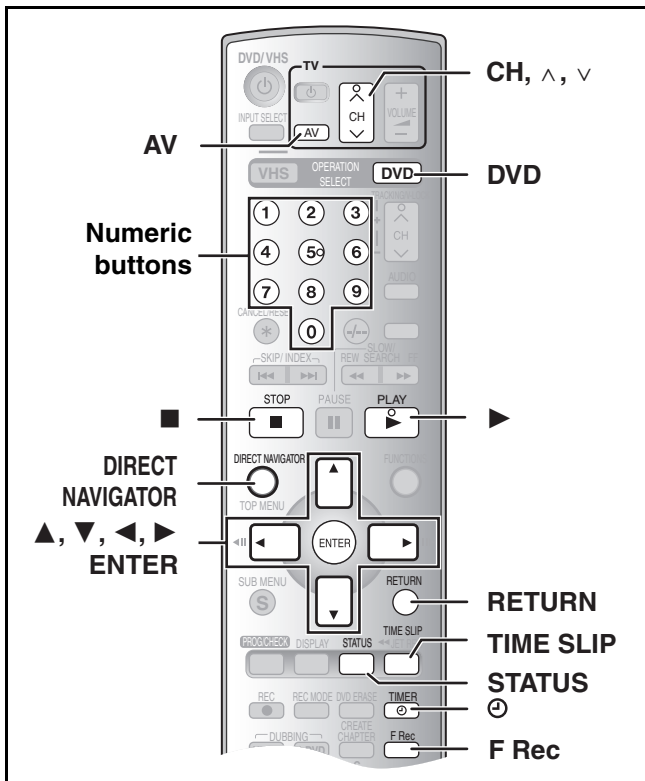

Preparation

- Press [DVD].

Specifying the time when recording will stop

RAM -R -RW(V) +R

While recording

Press [●, REC] on the DVD main unit to select the recording time.

The unit's display

Each time you press the button:

Counter (Cancel) → OFF 30 (min.) → OFF 60 (min.) → OFF 90 (min.)
 ↑ OFF 240 (min.) ← OFF 180 (min.) ← OFF 120 (min.) ←

For your reference

- This does not work during timer recording or Flexible Recording.
- Recording stops and the set time is cleared if you press [■, STOP].
- The set time is cleared if you change the recording mode or channel while recording is paused.

Watching the TV while recording

- 1 Press [AV] to change the input mode to "TV".
- 2 Press TV's [CH, ^, v] to select the desired TV channel.

For your reference

- You can also do this if the unit is making a timer recording.
- The recording is unaffected.

Flexible Recording mode (FR)

RAM -R -RW(V) +R

The unit calculates a recording rate that enables the recording to fit in the time you set (within the remaining time on the disc) with the best picture quality.

Using "FLEXIBLE REC" is convenient in these kind of situations.

- When the amount of free space on the disc makes selecting an appropriate recording more difficult.
- When you want to record a long programme with the best picture quality possible.

e.g., Recording a 90 minute programme to disc

If you select XP mode, the programme will not fit one disc.

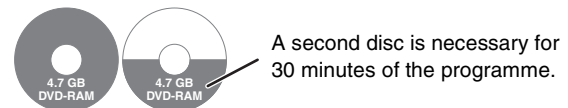

If you select SP mode, the programme will fit one disc.

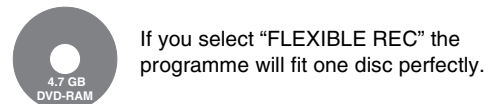
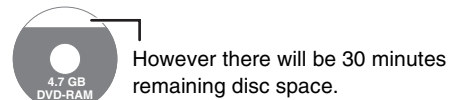

Preparation

- Select the channel to record.

1 While stopped

Press [F Rec].

2 Press [▲, ▼, ◀, ▶] to set the recording time.

- You can also set the recording time with the numeric buttons.
- Maximum recording time is 8 hours. (Depends on disc capacity)

3 Select "Start" with [▲, ▼, ◀, ▶] and press [ENTER].

- Recording starts.



■ To exit the FLEXIBLE REC window without recording Press [RETURN].

■ To stop recording in the middle Press [■, STOP].

■ To show the time remaining until recording finishes Press [STATUS].

- It is displayed in units of minutes.

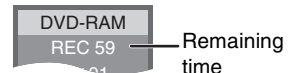

For your reference

- During a Flexible Recording, all recording mode indicators light up on the unit's display.
- It is not possible to change the channel or recording mode while Flexible Recording is paused.

Playing while you are recording

RAM

- Sound is not output while fast-forwarding.

■ Chasing play

You can start play from the beginning of the title while continuing to record it.

While recording or timer recording

Press [▶, PLAY].

- Play starts while recording proceeds.

For your reference

- Play cannot be started until at least 2 seconds after recording starts.

■ Simultaneous recording and play

You can play a title previously recorded while you are recording another title.

1 While recording or timer recording

Press [DIRECT NAVIGATOR]. (→ 31)

- Currently recording

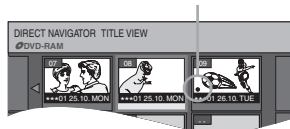

2 Use [▲, ▼, ◀, ▶] to select a title and press [ENTER].

- Play starts while recording proceeds.

■ To exit the Direct Navigator screen

Press [DIRECT NAVIGATOR].

For your reference

- During simultaneous recording and play, you cannot edit or erase titles with the Direct Navigator or playlists.
- Even if you start play while the unit is on standby for timer recording, recording starts when the time you set is reached.

■ TIME SLIP

Press [TIME SLIP] while recording; play starts from 30 seconds previous to that moment. You can start play from even earlier by specifying an amount of time to skip on the time indicator.

1 While recording or timer recording

Press [TIME SLIP].

- The PIP screen (images being currently recorded) is displayed.
- On the main screen, play starts from 30 seconds previous to that moment.
- You will hear the playback audio.

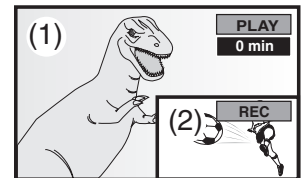

- (1) Play images (30 seconds before)
- (2) Currently recording

2 While observing the time indicator at the top right

Press [▲, ▼] to set an amount of time to skip and press [ENTER].

- Play skips the amount of time you specified.
- The time indicator will go off after about 5 seconds, but will turn on again when you set the time.
- Press [▲, ▼] to alter in 1-minute units. Press and hold [▲, ▼] to alter in 10-minute units.



■ To show the play images in full

Press [TIME SLIP].

- Press [TIME SLIP] to return to the PIP screen.

For your reference

- The image on the PIP screen may be distorted or flicker depending on the scene. However, this does not affect the image recorded.

■ To stop play and recording

1 Press [■, STOP]. Play stops.

(Wait 2 or more seconds.)

2 Press [■, STOP]. Recording stops.

- You cannot stop recording with [■, STOP] during timer recording. To stop timer recording, press [⊖, TIMER].
- You can also press and hold [■] on the DVD main unit for 3 or more seconds to stop timer recording.

■ Playing/Recording VHS while recording

You can play or record tapes while recording. The recording will not be affected.

- VHS playback (→ 49)
- VHS recording (→ 51)
- When a tuner channel is recorded on DVD, you can record the other channel on VHS.

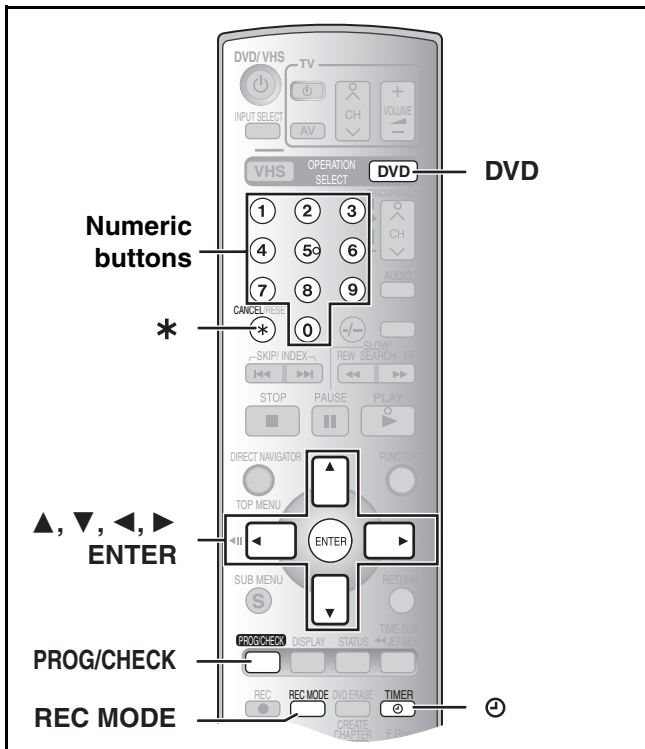

RAM -R -RW(V) +R

Timer Recording

You can enter up to 16 programmes a month in advance.

Preparation

- Select the unit viewing channel (e.g. AV input) on the TV.
- Check that the clock is set to the correct time. If it has not been set, set it (→ 46).
- Release protection (disc → 28, cartridge → 28) **RAM**.
- Insert a disc (→ 8) and confirm there is sufficient empty space for recording on it (→ 47).
- **-R -RW(V) +R** When recording bilingual broadcasts, only the audio selected in “Bilingual Audio Selection” (→ 42) is recorded (“M 1” or “M 2”).
- Press [DVD].

Manual programming

1 Press [PROG/CHECK].

- Make sure “New Timer Programme” is selected.

“New Timer Programme” is selected.

TIMER RECORDING		Remain	2:00 SP
No.	Name	Date	Start Stop Mode
	New Timer Programme		

2 Press [ENTER].

3 Press [◀, ▶] to move and change the items with [▲, ▼].

- You may use the numeric buttons to enter “Name”, “Date”, “Start”, and “Stop”.
- **Name** (Programme Position/TV Station Name)
- **Date**
You can also make a daily or weekly programme. Each daily or weekly programme is counted as one programme.
- **Start** (start time)/**Stop** (finish time)
The time increases or decreases in 30-minute increments if you hold down the button.
- **Mode** (Recording mode)
XP ↔ SP ↔ LP ↔ EP ↔ FR (→ 23)

TIMER RECORDING		Remain	2:00 SP
Name	Date	Start	Stop Mode
			SP

You can also press [REC MODE] to change the recording mode.

• Programme Name

Press [◀, ▶] to select “Programme Name” and press [ENTER] (→ 30).

4 Press [ENTER] when you have finished making changes.

- Make sure that the timer recording has been programmed correctly on the TIMER RECORDING screen (→ 27).
- “Invalid Entry” is displayed when you enter the wrong item. Re-enter the item.
- To continue programming
Select “New Timer Programme” and repeat steps 2–4.

5 Press [⏸, TIMER].

- “⏸” lights on the DVD unit’s display.

The timer recording standby mode is activated on DVD.

However, the unit may not be turned off automatically.

- You can play a DVD-RAM on DVD, play or record on VHS even if the timer recording standby mode is activated on DVD.
- Timer recording can be started whether the unit is turned on or off.

6 Turn the unit off when you do not play on DVD (DVD-RAM) or, play or record on VHS.

- If the timer recording is started with keeping the unit turned on, the unit is not turned off automatically even after the timer recording is completed. You can turn the unit off during timer recording.

■ To release the unit from recording standby

Press [⏸, TIMER].

“⏸” goes out.

- Be sure to press [⏸, TIMER] before the programme start time to put the unit on recording standby. Timer recording will work only if “⏸” is displayed.

■ To cancel recording when recording has already begun

Press [⏸, TIMER].

- You can also press and hold [■] on the DVD main unit for more than 3 seconds to stop recording.

Note

- “⏸” flashes for about 5 seconds when the unit cannot go to timer recording standby (non-recordable disc or protected disc, etc.). Check the disc carefully.
- If the unit is not put in the timer recording standby mode at the latest 10 minutes before the programmed timer recording starting time, the “⏸” flashes on the unit display. In this case, press [⏸, TIMER] to put the unit in the timer recording standby mode.
- When you programme successive timer recordings to start immediately one after the other, the unit cannot record the part at the beginning of the later programmes [a few seconds when recording with DVD-RAM and approximately 30 seconds when recording with DVD-R, DVD-RW (DVD-Video format) and +R].

Check, change or delete programmes

Even when the unit is turned off, you can display the timer recording list by pressing [PROG/CHECK].

Preparation

- Press [DVD].

1 Press [PROG/CHECK].

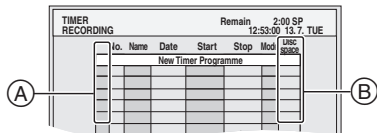

Icon explanations (A)

- Currently recording
- Ⓜ Programmes are overlapped. Recording of the programme with the later start time starts when the earlier programme finishes recording.
- Ⓣ The disc was full (not enough space).
- Ⓛ The TV programme may not be recorded due to copy-protect.
- Ⓧ Recording stopped. (Dirty disc, etc.)

Disc space (B)

OK: Recordable

→ **(Date):** The last day of daily or weekly recording.

- I:** It may not be possible to record because:
- the disc is write-protected
 - there is no more space left
 - the number of possible titles has reached its maximum.

2 Press [▲, ▼] to select the programme.

- You may also select programme by inputting a 2-digit number using the numeric buttons.

e.g.: "5": [0]→[5]

"15": [1]→[5]

- Press [◀, ▶] to move to the preceding or following page.

3 Press [*, CANCEL] to delete, or press [ENTER] to change.

- You cannot delete or change programmes that are currently recording.

4 If you pressed [ENTER] in step 3, Use [▲, ▼, ▶, ◀] to change and press [ENTER].

- To continue changing programmes steps 2–4.

5 Press [⊖, TIMER].

- "⊖" lights on the DVD unit's display.

The timer recording standby mode is activated on DVD.

However, the unit may not be turned off automatically.

- You can play a DVD-RAM on DVD, play or record on VHS even if the timer recording standby mode is activated on DVD.
- Timer recording can be started whether the unit is turned on or off.

6 Turn the unit off when you do not play on DVD (DVD-RAM) or, play or record on VHS.

- If the timer recording is started with keeping the unit turned on, the unit is not turned off automatically even after the timer recording is completed. You can turn the unit off during timer recording.

For your reference

- Programmes that failed to record are deleted from the timer recording list at 4 a.m. 2 days later.

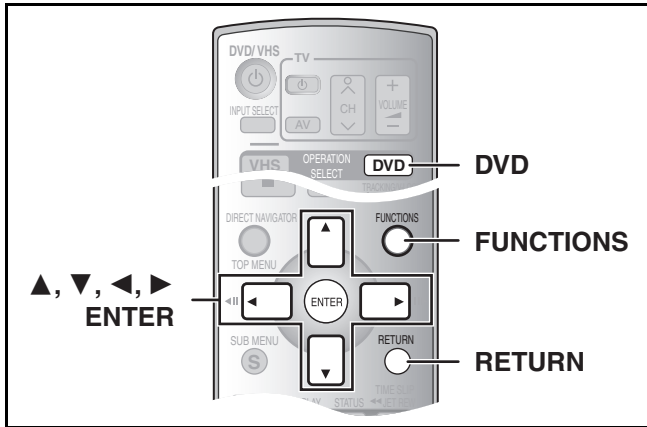

DISC MANAGEMENT

RAM -R -RW(V) +R

Preparation

- Release protection (disc → right, cartridge → right). **RAM**
- Insert a disc (→ 8).
- Press [DVD].

- 1 While stopped
Press [FUNCTIONS].
- 2 Select "To Others" with [▲, ▼] and press [ENTER].

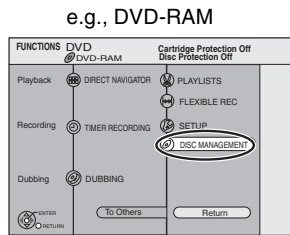

- 3 Select "DISC MANAGEMENT" with [▲, ▼] and press [ENTER].

e.g., DVD-RAM

e.g., DVD-R

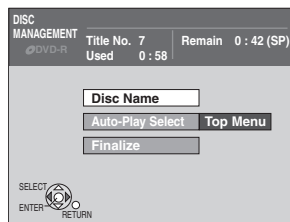
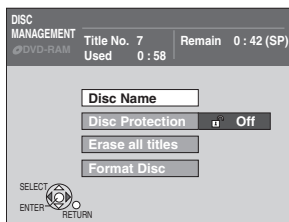

- 4 Use [▲, ▼] to select a desired item and press [ENTER].

You can change various settings.
• After this operation, follow the desired operation.

■ To return to the previous screen

Press [RETURN].

■ To exit the screen

Press [RETURN] several times.

▶ Disc Name

RAM -R -RW(V) +R

- Follow steps 1 to 3 of "DISC MANAGEMENT".

- 4 Select "Disc Name" with [▲, ▼] and press [ENTER].

Refer to "Entering text" (→ 30).

- The disc name is displayed in the FUNCTIONS window.
- With a finalized DVD-R, DVD-RW (DVD-Video format) and +R, the name is displayed on the top menu.

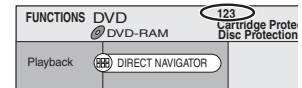

▶ Disc Protection

RAM

- Follow steps 1 to 3 of "DISC MANAGEMENT".

This allows you to protect the whole disc from accidental erasure and release disc protection.

- 4 Select "Disc Protection" with [▲, ▼] and press [ENTER].

- 5 Select "Yes" with [◀] and press [ENTER].

- To protect

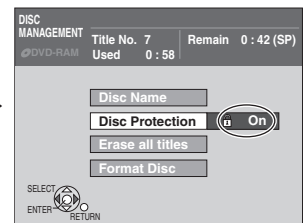
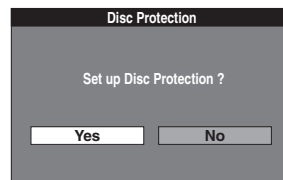

- To release protection

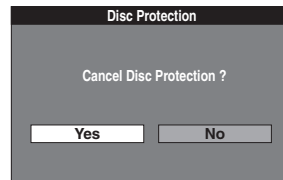

■ Protection of cartridge disc **RAM**

You can protect the contents of your discs.

- With the write-protect tab in the protect position, you cannot record to, edit, or erase from the disc.

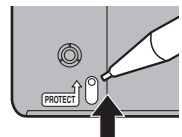

▶ Erase all titles

RAM

- Follow steps 1 to 3 of "DISC MANAGEMENT".

Once erased, the recorded contents are lost and cannot be restored. Make certain before proceeding.

- 4 Select "Erase all titles" with [▲, ▼] and press [ENTER].

- 5 Select "Yes" with [◀] and press [ENTER].

- 6 Select "Start" with [◀] and press [ENTER].

- A message appears when finished.

- 7 Press [ENTER].

Note

- Erasing all video titles will result in all playlists also being erased.
- Erase does not work if one or more titles are protected.

▶ Format Disc

RAM -RW(V) -RW(VR)

- Follow steps 1 to 3 of "DISC MANAGEMENT".

Formatting erases all contents (including computer data), and they cannot be restored. Check carefully before proceeding.
The contents are erased when you format a disc even if you have set protection.

4 Select "Format Disc" with [▲, ▼] and press [ENTER].

5 Select "Yes" with [◀] and press [ENTER].

e.g., DVD-RAM

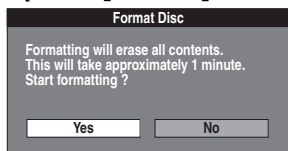

6 Select "Start" with [◀] and press [ENTER].

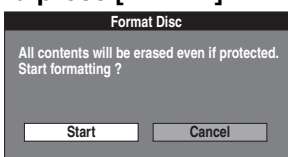

- Formatting starts.
- A message appears when formatting is finished.

Note

- Formatting normally takes a few minutes; however it may take up to a maximum of 70 minutes (**RAM**).
- **Do not disconnect the AC mains lead while formatting.** This can render the disc unusable.

7 Press [ENTER].

To stop formatting **RAM**

Press [RETURN].

- You can cancel formatting if it takes more than 2 minutes. The disc must be reformatted if you do this.

Note

- When a disc has been formatted using this unit, it may not be possible to use it on any other equipment.
- DVD-R, +R and CD-R/RW cannot be formatted.
- You can format DVD-RW only as DVD-Video format on this unit.
- The disc cannot be formatted if the write-protect tab (→ 28) is switched to "PROTECT". Release the protection to continue.
- The message "**Unable to format**" appears when trying to format discs the unit cannot use.

▶ Auto-Play Select

-R -RW(V) +R

- Follow steps 1 to 3 of "DISC MANAGEMENT".

Select whether to show the top menu after finalizing the disc. Do this before finalizing the disc.

4 Select "Auto-Play Select" with [▲, ▼] and press [ENTER].

5 Use [▲, ▼] to select a desired item and press [ENTER].

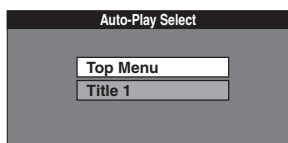

- Top Menu: The top menu appears first.
- Title 1: The disc content is played without displaying the top menu.

▶ Finalize

-R -RW(V) +R

- Follow steps 1 to 3 of "DISC MANAGEMENT".
- Make selection from "Auto-Play Select" before finalizing the disc. (→ below left)

You can play DVD-R, DVD-RW (DVD-Video format) or +R on compatible DVD players by finalizing it on the unit, effectively making it into DVD-Video that complies with DVD-Video standards.

The menu you create with the unit can also be used on DVD players.

4 Select "Finalize" with [▲, ▼] and press [ENTER].

5 Select "Yes" with [◀] and press [ENTER].

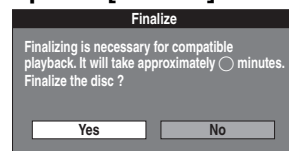

6 Select "Start" with [◀] and press [ENTER].

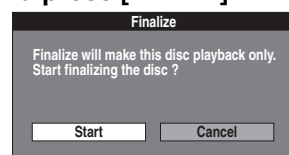

- Finalizing starts.
- You cannot cancel finalizing.
- A message appears when finalizing is finished.

Note

- Finalizing takes up to 15 minutes.
- **Do not disconnect the AC mains lead while finalizing.** This can render the disc unusable.

7 Press [ENTER].

Note

- You can only finalize DVD-R, DVD-RW (DVD-Video format) or +R that were recorded on the unit.
- When finalizing a high-speed recording compatible disc, it may take longer than displayed on the confirmation screen (approximately 4 times).
- After finalizing
 - The disc becomes play-only and you can no longer record or edit it. **-R +R**
 - You can record and edit the disc after formatting (→ left) although it becomes play-only after finalizing. **-RW(V)**
 - Discs finalized on the unit may not be playable on other players depending on the condition of the recording.
 - There is a pause of several seconds between titles during play.
 - Titles are divided into about 5-minute chapters*.
 - * This time varies greatly depending on the condition and mode of recording.

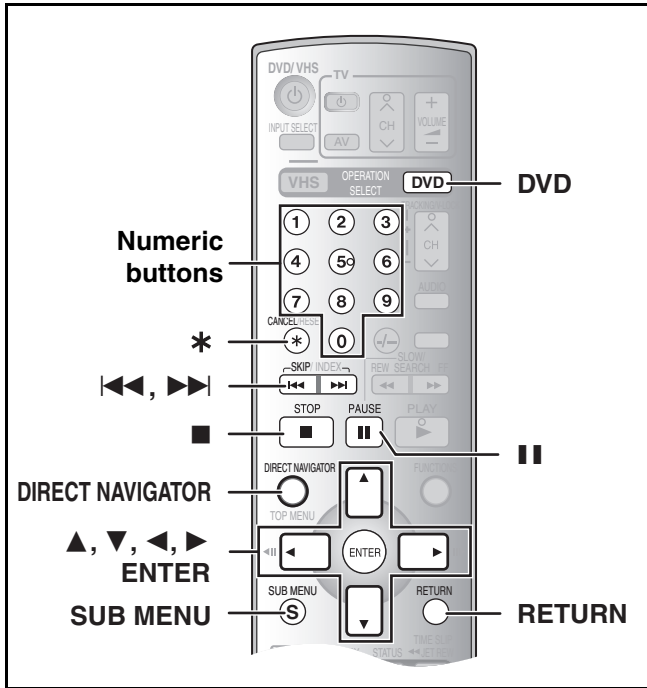

2 Use [▲, ▼, ◀, ▶] to select the character you want to enter and press [ENTER].

Repeat this step to enter other characters.

•To erase a character

Press [▲, ▼, ◀, ▶] to select the character in the name field and press [■, PAUSE].

•Using the numeric buttons to enter characters

e.g., entering the letter "R".

(1) Press [7] to move to the 7th row.

(2) Press [7] twice to highlight "R".

(3) Press [ENTER].



•To enter space

Press [* , CANCEL] and press [ENTER].

•Add/recall names (→ below)

3 After you have finished naming

Press [■, STOP].

The name is entered and the screen disappears.

■To cancel in the middle

Press [RETURN].

•Characters will not be saved.

Entering text

RAM -R -RW(V) +R

You can give names to recorded titles, etc.

The maximum number of characters:

RAM	Characters
•Title	64
•Title (timer recording)	44
•Playlist	64
•Disc	64

-R -RW(V) +R	Characters
•Title	44
•Disc	40

Note

•If a name is long, only part of it is displayed on the title list (→ 31) and the playlist screen (→ 35).

Preparation

- Insert a recorded disc.
- Release protection (disc → 28, title → 32, cartridge → 28). **RAM**
- Press [DVD].

1 Show Enter Name screen.

Refer to the following pages regarding display of the Enter Name Screen.

- Title (→ 32)
- Title (timer recording) (→ 26)
- Playlist (→ 36)
- Disc (→ 28)

Name field: shows the text you have entered

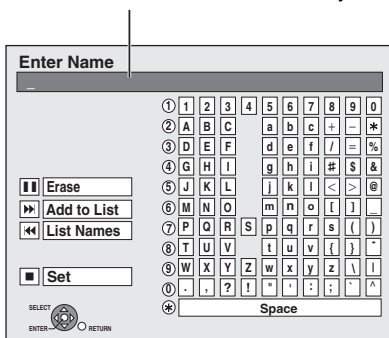

■To add a name

You can save frequently used names and recall them later.

Maximum number of saved names: 20

Maximum number of characters per name: 20

•After entering the name (step 1–2, Entering text)

1 Press [▲, ▼, ◀, ▶] to select "Add to List" and press [ENTER].

•You can also press [▶▶], SKIP to select "Add to List".

2 Press [◀] to select "Add" and press [ENTER].

•Press [RETURN] to cancel.

■To recall an added name

1 Press [▲, ▼, ◀, ▶] to select "List Names" and press [ENTER].

•You can also press [◀◀], SKIP to select "List Names".

2 Press [▲, ▼, ◀, ▶] to select the name to be recalled and press [ENTER].

■To erase an added name

1 Press [▲, ▼, ◀, ▶] to select "List Names" and press [ENTER].

•You can also press [◀◀], SKIP to select "List Names".

2 Press [▲, ▼, ◀, ▶] to select the name to be erased.

3 Press [SUB MENU] to show "Erase Name" and press [ENTER].

4 Press [◀] to select "Erase" and press [ENTER].

5 Press [RETURN].

For your reference

If you enter a long name, only part of it is shown in the Top Menu after finalization (→ 29). When entering a title name, the name that will appear in the Top Menu can be previewed in "Title on TOP MENU" window. **-R -RW(V) +R**

Using the Direct Navigator

RAM -R -RW(V) +R -RW(VR)

Press [DIRECT NAVIGATOR] and the list of titles recorded (TITLE VIEW) is shown. You can play and edit a desired title.

For your reference

- You cannot edit during recording or transferring (dubbing), etc.
- The maximum number of items on a disc:
 - Titles: 99 (+R) 49 titles)
 - Chapters: Approximately 1000 (+R) Approximately 254)
 - (Depends on the state of recording.)

■ Selecting recorded titles to play

Preparation

- Insert a disc that has been recorded on.
- Press [DVD].

1 Press [DIRECT NAVIGATOR].

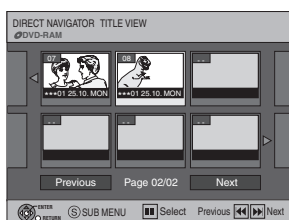

2 Use [▲, ▼, ◀, ▶] to select the title you want to watch and press [ENTER].

- Play starts.
- You can also select titles by entering a 2-digit number with the numeric buttons.
 - e.g.: "5": [0]→[5]
 - "15": [1]→[5]
- If you enter a number larger than the total number of titles, the last title is selected.
- To show other pages → lower right

■ To stop play

Press [■, STOP]. (The TITLE VIEW screen appears.)

■ To exit the screen

Press [DIRECT NAVIGATOR].

For your reference

- Direct Navigator screen icons
 - 🔒 : Title protected
 - 🔒 : Copy-protected so it was not recorded.
 - x : Unable to play
 - : Currently recording
 - 📅 : Title with "One time only recording" restriction (→ 66, CPRM)
 - 📺 : NTSC/📺 : PAL
- Title recorded using a different encoding system from that of the TV system currently selected on the unit.

■ Editing titles with SUB MENU button

Note

- Once erased, divided or partially erased, the title cannot be restored to its original state. Make certain before proceeding.

Preparation

- Release protection (disc → 28, cartridge → 28). **RAM**
- Press [DVD].

1 Press [DIRECT NAVIGATOR].

2 Use [▲, ▼, ◀, ▶] to select a desired title.

- To show other pages → below

3 Press [SUB MENU].

4 Use [▲, ▼] to select a desired item and press [ENTER].

- After this operation, follow the desired operation.

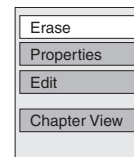

■ To return to the previous screen

Press [RETURN].

■ To exit the screen

Press [RETURN] several times.

For your reference

- When the title is protected (→ 32), some items are not accessible. Release the protection to access the inaccessible items. **RAM**

▶ Erase

RAM -R -RW(V) +R (Multiple editing → below)

- Follow steps 1 to 3 of "Editing titles with SUB MENU button".

Once erased, the recorded contents are lost and cannot be restored. Make certain before proceeding.

4 Select "Erase" with [▲, ▼] and press [ENTER].

5 Select "Erase" with [◀] and press [ENTER].

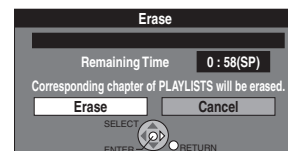

For your reference

- The disc's available recording time may not increase after erasing short titles.
- The available recording space on DVD-R or +R does not increase when you erase titles.
- Available recording space on a DVD-RW (DVD-Video format) increases only when the last recorded title is erased. It does not increase if other title are erased.

▶ Properties

RAM -R -RW(V) +R -RW(VR)

- Follow steps 1 to 3 of "Editing titles with SUB MENU button".

Title information (e.g., date and time) is shown.

4 Select "Properties" with [▲, ▼] and press [ENTER].

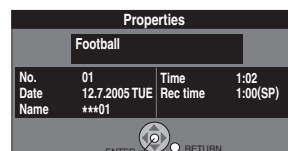

Various operations

■ To show other pages

Press [▲, ▼, ◀, ▶] to select "Previous" or "Next" and press [ENTER].

- You can also press [◀◀, SKIP] or [▶▶, SKIP] to show other pages.

■ Multiple editing

Select with [▲, ▼, ◀, ▶] and press [■, PAUSE]. (Repeat this to select multiple items.)

A check mark appears. Press [■, PAUSE] again to cancel.

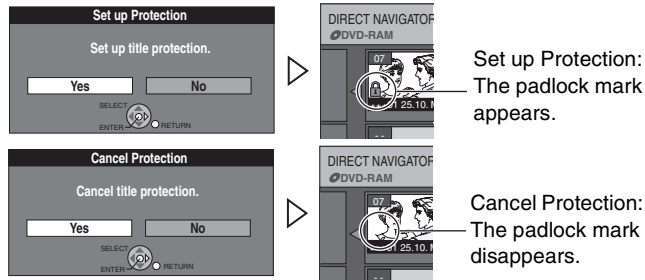
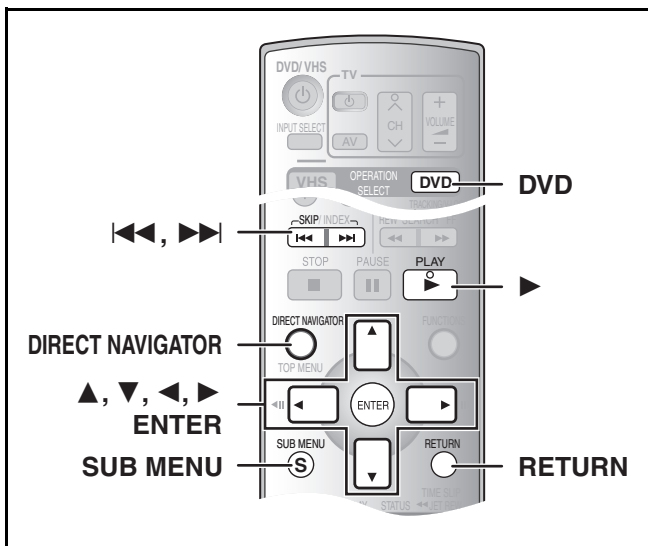

Set up Protection:
The padlock mark appears.

Cancel Protection:
The padlock mark disappears.

▶ Edit

You can perform various kinds of title editing.

Preparation

- Release protection (disc → 28, cartridge → 28). **RAM**
- Press [DVD].

- 1 Press [DIRECT NAVIGATOR] and use [▲, ▼, ◀, ▶] to select a desired title.
 - To show other pages → 31
 - Multiple editing → 31
- 2 Press [SUB MENU].
- 3 Select "Edit" with [▲, ▼] and press [ENTER].
- 4 Use [▲, ▼] to select a desired item and press [ENTER].
 - The editing screen for the selected item appears.

e.g.: DVD-RAM

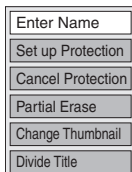

■ To return to the previous screen

Press [RETURN].

■ To exit the screen

Press [RETURN] several times.

▶▶ Enter Name

RAM -R -RW(V) +R

- Follow steps 1 to 3 of "Edit".

- 4 Select "Enter Name" with [▲, ▼] and press [ENTER].

Refer to "Entering text". (→ 30)

▶▶ Set up Protection/Cancel Protection

RAM (Multiple editing → 31)

- Follow steps 1 to 3 of "Edit".

You can prevent accidental erasure of titles by setting and canceling the write-protection.

- 4 Select "Set up Protection" or "Cancel Protection" with [▲, ▼] and press [ENTER].
- 5 Select "Yes" with [◀] and press [ENTER].

For your reference

Titles will be erased even if they are protected if you format the disc with DISC MANAGEMENT (→ 29).

▶▶ Partial Erase

RAM

- Follow steps 1 to 3 of "Edit".

You can remove unnecessary parts of the title such as commercials.

- 4 Select "Partial Erase" with [▲, ▼] and press [ENTER].
- 5 Press [ENTER] at the start point and end point of the section you want to erase.
 - For quicker editing → 33
- 6 Select "Exit" with [▲, ▼] and press [ENTER].
- 7 Select "Erase" with [◀] and press [ENTER].

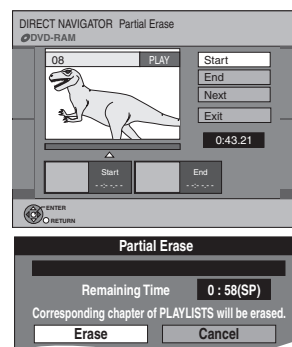

■ To erase another part of the same title

After setting the point of "Start" and "End" in step 5, select "Next" in step 6 and perform step 7, then repeat steps 5–7.

For your reference

- You may not be able to specify start and end points within 3 seconds of each other.
- The disc's available recording time may not increase after erasing short parts of titles.

▶▶ Change Thumbnail

RAM -R -RW(V) +R

- Follow steps 1 to 3 of "Edit".

You can change the image to be shown as a thumbnail picture in the TITLE VIEW.

- 4 Select "Change Thumbnail" with [▲, ▼] and press [ENTER].
- 5 Press [▶, PLAY] to play.
- 6 Press [ENTER] at the point you want to display.
 - For quicker editing → 33
 - To change to another point in the same title
 - Select "Change" with [▲, ▼] and press [▶, PLAY] and then repeat step 6.
- 7 Select "Exit" with [▲, ▼] and press [ENTER].
 - The thumbnail picture will be changed at this point.

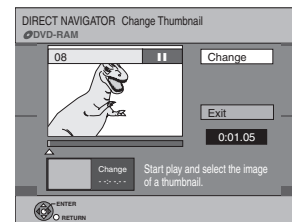

▶▶ Divide Title

RAM

- Follow steps 1 to 3 of "Edit".

You can divide a selected title into two. You must be careful when dividing a title because it cannot be recovered after the procedure.

- 4 Select "Divide Title" with [▲, ▼] and press [ENTER].

- 5 Press [ENTER] at the point you want to divide the title.

- For quicker editing → lower right

- To change the point to divide - Select "Divide" with [▲, ▼] and press [▶, PLAY], and then press [ENTER].

- 6 Select "Exit" with [▲, ▼] and press [ENTER].

- 7 Select "Divide" with [◀] and press [ENTER].

- The title is divided at that point.

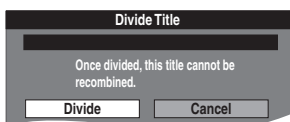
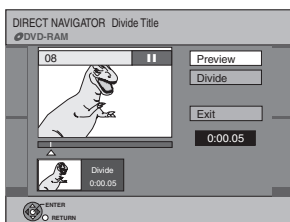

■ To check the division point

By selecting "Preview" in step 5 and pressing [ENTER], play will begin from 10 seconds prior to the division point to 10 seconds after the division point.

For your reference

- The divided titles retain the name of the original title. They also retain the CPRM property (→ 66) of the original.
- Video and audio just before and after the division point will be momentarily cut out.
- It is not possible to carry out "Divide" in the following cases:
 - When the resulting part(s) are extremely short.
 - When the total number of titles is more than 99.

▶ Chapter View

RAM -R -RW(V) +R

- 1 Press [DIRECT NAVIGATOR] and use [▲, ▼, ◀, ▶] to select a desired title.

- To show other pages → 31

- 2 Press [SUB MENU].

- 3 Select "Chapter View" with [▲, ▼] and press [ENTER].

- 4 Select a desired chapter with [▲, ▼, ◀, ▶].

- To start play → Press [ENTER].
- To edit → Follow the steps below.

e.g.: DVD-RAM

- 5 Press [SUB MENU].

- 6 Select a desired item with [▲, ▼] and press [ENTER].

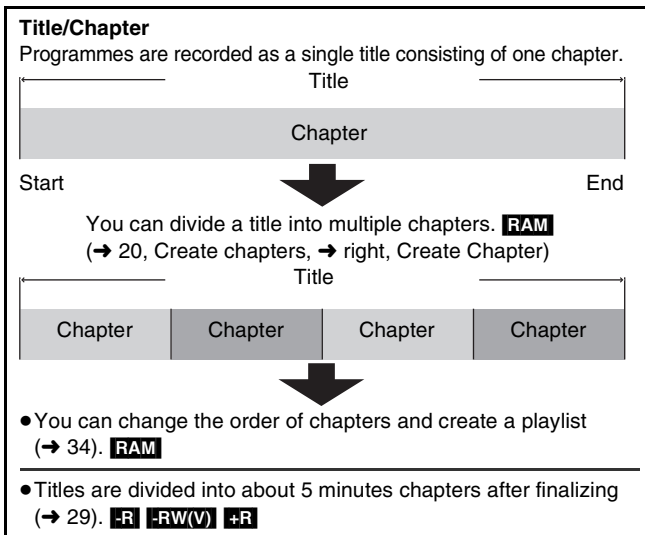
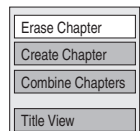

▶▶ Erase Chapter

RAM (Multiple editing → 31)

- Follow steps 1 to 5 of "Chapter View".

Once erased, the recorded contents are lost and cannot be restored. Make certain before proceeding.

- 6 Select "Erase Chapter" with [▲, ▼] and press [ENTER].

- 7 Select "Erase" with [◀] and press [ENTER].

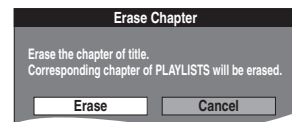

▶▶ Create Chapter

RAM

- Follow steps 1 to 5 of "Chapter View".

- 6 Select "Create Chapter" with [▲, ▼] and press [ENTER].

- 7 Press [ENTER] at the point you want to divide.

- For quicker editing → below
- Repeat this step to divide at other points.



- 8 Select "Exit" with [▲, ▼] and press [ENTER].

▶▶ Combine Chapters

RAM

- Follow steps 1 to 5 of "Chapter View".

- 6 Select "Combine Chapters" with [▲, ▼] and press [ENTER].

- 7 Select "Combine" with [◀] and press [ENTER].

- The selected chapter and next chapter are combined.

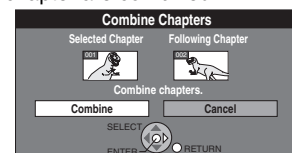

▶▶ Title View

RAM -R -RW(V) +R -RW(VR)

- Follow steps 1 to 5 of "Chapter View".

- 6 Select "Title View" with [▲, ▼] and press [ENTER].

You go back to TITLE VIEW.

For quicker editing

- Use search (→ 19), Time Slip (→ 20) or slow-motion (→ 19) to find the desired point.
- Press [◀◀, SKIP] or [▶▶, SKIP] to skip to the end of a title.

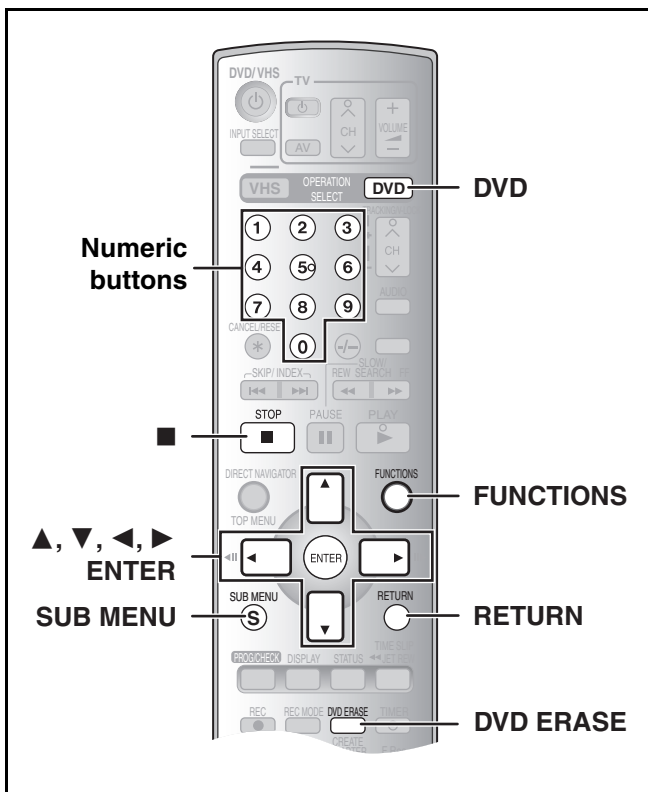

■ Creating playlists

RAM

Preparation

- Release protection (disc → 28, cartridge → 28)
- Press [DVD].

- 1 While stopped**
Press [FUNCTIONS].
- 2 Select “To Others” with [▲, ▼] and press [ENTER].**

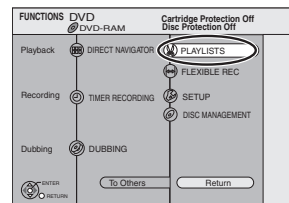

- 3 Select “PLAYLISTS” with [▲, ▼] and press [ENTER].**
• The PLAYLIST VIEW appears.



- 4 Select “Create” with [▲, ▼, ◀, ▶] and press [ENTER].**

- 5 Use [◀, ▶] to select the source title and press [▼].**

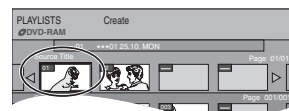

- When you want to select all chapters in the title, use [◀, ▶] to select the source title and press [ENTER], then skip to step 7.

- 6 Use [◀, ▶] to select the chapter you want to add to a playlist and press [ENTER].**
• Press [▲] to cancel.



- You can also create a new chapter in the source title.
Press [SUB MENU] to select “Create Chapter” and press [ENTER] (→ 33, Create Chapter).

- 7 Use [◀, ▶] to select the position to insert the chapter and press [ENTER].**



- The chapter is registered in the playlist.
- Repeat steps 6–7 to add other chapters.
- To select other source titles, press [▲] several times to return to step 5.

- 8 Press [RETURN].**

■ To return to the previous screen

Press [RETURN].

■ To exit the screen

Press [RETURN] several times.

Using playlist

RAM

You can create a playlist by gathering your favorite chapters (→ 33) from your recordings. You can also play and edit the created playlist.

Playlist

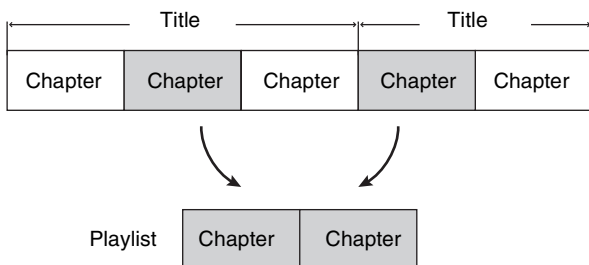

- Editing playlists doesn't modify titles.
- Playlists are not recorded separately so this doesn't use much capacity.

- The maximum number of items on a disc:
 - Playlists: 99
 - Chapters in play lists: Approximately 1000 (Depends on the state of recording.)
- If you exceed the maximum numbers of items for a disc, all the items entered will not be recorded.

■ Playing playlists

RAM -RW(VR) (Play only)

Preparation

- Create playlists. (→ 34)
- Press [DVD].

1 While stopped
Press [FUNCTIONS].

2 Select “To Others” with [▲, ▼] and press [ENTER].

3 Select “PLAYLISTS” with [▲, ▼] and press [ENTER].



4 Use [▲, ▼, ◀, ▶] to select a playlist and press [ENTER].

- Playlists are not displayed if you have not created any playlist on the disc.
- You can also select a playlist from the PLAYLIST VIEW by entering a 2-digit number with the numeric buttons.
e.g.: “5”: [0]→[5]
“15”: [1]→[5]
- To show other pages → 31

■ To stop playlist play

Press [■, STOP]. (The PLAYLIST VIEW screen appears.)

■ To return to the previous screen

Press [RETURN].

■ To exit the screen

Press [RETURN] several times.

■ To erase a playlist during play

- 1 Press [DVD ERASE].
 - A confirmation message will be displayed.
- 2 Use [◀] to select “Erase” and press [ENTER].

For your reference

- You can use fast-forward, fast-rewind, pause, and slow-motion while playing playlists just as you can during normal play.

■ Editing playlists with SUB MENU button

RAM -RW(VR) (Properties only)

Preparation

- Create playlists. (→ 34)
- Release protection (disc → 28, cartridge → 28). **RAM**
- Press [DVD].

1 While stopped
Press [FUNCTIONS].

2 Select “To Others” with [▲, ▼] and press [ENTER].

3 Select “PLAYLISTS” with [▲, ▼] and press [ENTER].

4 Use [▲, ▼, ◀, ▶] to select a playlist.

- To show other pages → 31

5 Press [SUB MENU].

6 Use [▲, ▼] to select a desired item and press [ENTER].

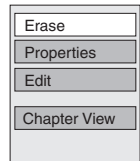

■ To return to the previous screen

Press [RETURN].

■ To exit the screen

Press [RETURN] several times.

▶ Erase

RAM (Multiple editing → 31)

- Follow steps 1 to 5 of “Editing playlists with SUB MENU button”.

6 Select “Erase” with [▲, ▼] and press [ENTER].

7 Select “Erase” with [◀] and press [ENTER].

- The playlist is erased.



- Once erased, the playlists are lost and cannot be restored. Make certain before proceeding.
- Even if you erase the playlist, the original title is not erased.

▶ Properties

RAM -RW(VR)

- Follow steps 1 to 5 of “Editing playlists with SUB MENU button”.

6 Select “Properties” with [▲, ▼] and press [ENTER].

Playlist information (e.g., date and length) is shown.

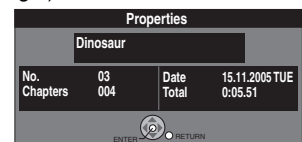

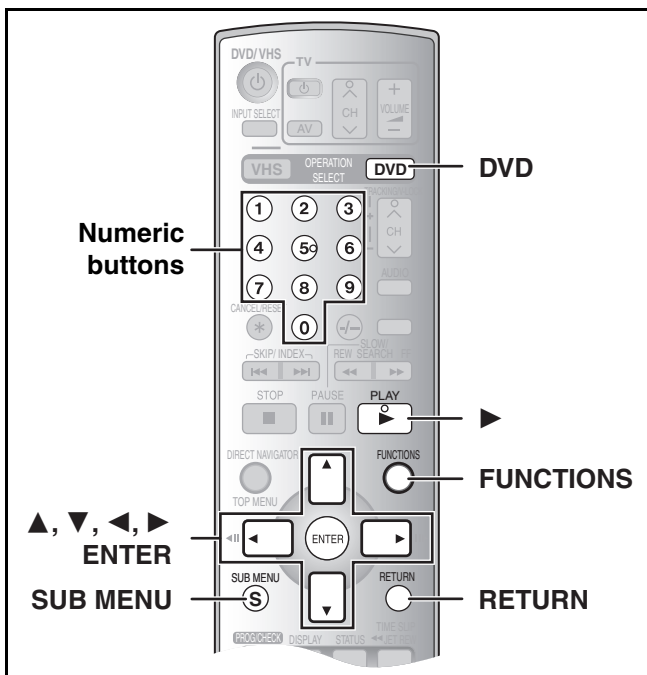

▶ Edit

RAM

You can perform various kinds of playlist editing.

Preparation

- Create playlists (→ 34).
- Release protection (disc → 28, cartridge → 28).
- Press [DVD].

- 1 While stopped**
Press [FUNCTIONS].
- 2 Select “To Others” with [▲, ▼] and press [ENTER].**

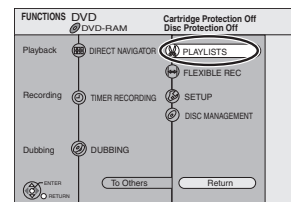

- 3 Select “PLAYLISTS” with [▲, ▼] and press [ENTER].**
 - Playlists are not displayed if you have not created any playlist on the disc.
- 4 Use [▲, ▼, ◀, ▶] to select a playlist.**
 - To show other pages → 31
- 5 Press [SUB MENU], then select “Edit” with [▲, ▼] and press [ENTER].**
- 6 Use [▲, ▼] to select a desired item and press [ENTER].**

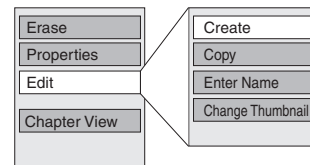

■ To return to the previous screen

Press [RETURN].

■ To exit the screen

Press [RETURN] several times.

▶▶ Create

• Follow steps 1 to 5 of “Edit”.

- 6 Select “Create” with [▲, ▼] and press [ENTER].**
Refer to “Creating playlists”, steps 5–8. (→ 34)

▶▶ Copy

(Multiple editing → 31)

• Follow steps 1 to 5 of “Edit”.

- 6 Select “Copy” with [▲, ▼] and press [ENTER].**
- 7 Select “Copy” with [◀] and press [ENTER].**



▶▶ Enter Name

• Follow steps 1 to 5 of “Edit”.

- 6 Select “Enter Name” with [▲, ▼] and press [ENTER].**

Refer to “Entering text”. (→ 30)

▶▶ Change Thumbnail

• Follow steps 1 to 5 of “Edit”.

You can change the image to be shown as a thumbnail picture in the PLAYLIST VIEW.

- 6 Select “Change Thumbnail” with [▲, ▼] and press [ENTER].**
- 7 Press [▶, PLAY] to play.**
- 8 Press [ENTER] at the point you want to display.**

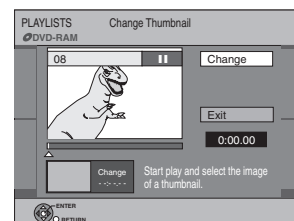

- For quicker editing → 33
- **To change to another point**
 - Select “Change” with [▲, ▼] and press [▶, PLAY], and then repeat step 8.
- 9 Select “Exit” with [▲, ▼] and press [ENTER].**
 - The displayed scene is changed at this point.

▶ Chapter View

RAM -RW(VR) (Play only)

- Follow steps 1 to 4 of "Edit".

You can play/edit the chapters in a playlist.

5 Press [SUB MENU], and select "Chapter View" with [▲, ▼] and press [ENTER].

6 Use [▲, ▼, ◀, ▶] to select a desired chapter.

- You can also select a chapter from the chapter view by entering a 3-digit number with the numeric buttons.
e.g.: "5": [0]→[0]→[5]
"15": [0]→[1]→[5]
- If you enter a number larger than the total number of chapters, the last chapter is selected.
- Editing chapters in a playlist does not modify the source titles and source chapters.
- To show other pages → 31
- To start play → Press [ENTER].
- To edit → Follow the steps below.

7 Press [SUB MENU].

8 Use [▲, ▼] to select a desired item and press [ENTER].

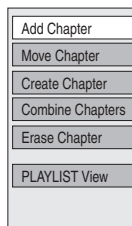

▶▶ Add Chapter

RAM

- Follow steps 1 to 7 of "Chapter View".

8 Select "Add Chapter" with [▲, ▼] and press [ENTER].

Refer to "Creating playlists", steps 5–8. (→ 34)

▶▶ Move Chapter

RAM

- Follow steps 1 to 7 of "Chapter View".

8 Select "Move Chapter" with [▲, ▼] and press [ENTER].

9 Use [▲, ▼, ◀, ▶] to select the position to insert the chapter and press [ENTER].

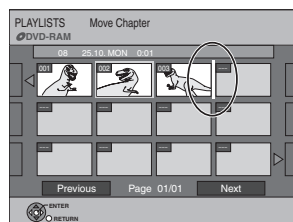

▶▶ Create Chapter

RAM

- Follow steps 1 to 7 of "Chapter View".

8 Select "Create Chapter" with [▲, ▼] and press [ENTER].

9 Press [ENTER] at the point you want to divide.

- For quicker editing → 33

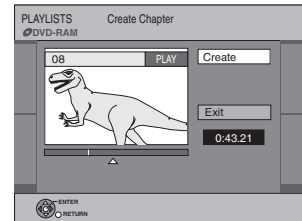

- Repeat this step to divide at other points.

10 Select "Exit" with [▲, ▼] and press [ENTER].

▶▶ Combine Chapters

RAM

- Follow steps 1 to 7 of "Chapter View".

8 Select "Combine Chapters" with [▲, ▼] and press [ENTER].

9 Select "Combine" with [◀] and press [ENTER].

- The selected chapter and next chapter are combined.

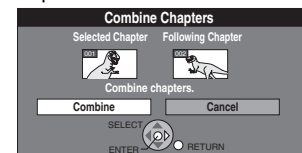

▶▶ Erase Chapter

RAM (Multiple editing → 31)

- Follow steps 1 to 7 of "Chapter View".

8 Select "Erase Chapter" with [▲, ▼] and press [ENTER].

9 Select "Erase" with [◀] and press [ENTER].

- Even if you erase the chapter, the original title is not erased.
- The playlist itself is erased if you erase all the chapters in it.

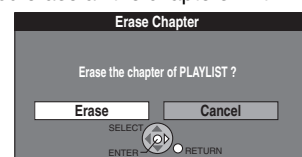

▶▶ PLAYLIST View

RAM -RW(VR)

- Follow steps 1 to 7 of "Chapter View".

8 Select "PLAYLIST View" with [▲, ▼] and press [ENTER].

You go back to PLAYLIST VIEW.

Using DISPLAY menus

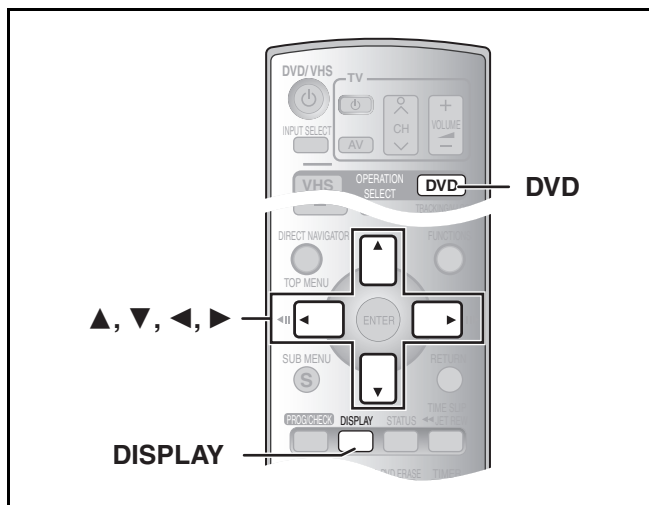

RAM -R -RW(V) +R DVD-A DVD-V -RW(VR) VCD CD

Common procedures

Preparation

- Press [DVD].

1 Press [DISPLAY].

Disc	Soundtrack	1	DD Digital 2/0ch
Play	Subtitle		Off
Picture	Audio channel		L R
Sound			
Other			
	Menu	Item	Setting

2 Select a menu with [▲, ▼] and press [▶].

3 Select an item with [▲, ▼] and press [▶].

4 Select a setting with [▲, ▼].

- Different operations are required depending on settings. Follow the on-screen instructions.

To exit the screen

Press [DISPLAY].

For your reference

- The screens depend on the disc contents.
- Depending on the condition of the unit (playing, stopped, etc.) and the type of software you are playing, there are some items that you cannot select or change.

▶ Disc menu

RAM -R -RW(V) +R DVD-A DVD-V -RW(VR) VCD

Disc	Soundtrack	1	DD Digital 2/0ch
Play	Subtitle		Off
Picture	Audio channel		L R
Sound			
Other			

Soundtrack

RAM -R -RW(V) +R -RW(VR)

The disc's audio attributes appear. (See [B] Audio attributes)

DVD-A DVD-V

Select the audio and language. (See [A] Soundtrack/Subtitle language, [B] Audio attributes)

Subtitle

DVD-A DVD-V

Turn the subtitle on/off and select the language (See [A] Soundtrack/Subtitle language)

RAM -R -RW(V) +R -RW(VR) (Only disc that contain subtitle on/off information)

Turn the subtitle on/off.

- Subtitle on/off information cannot be recorded using this unit.

Audio channel RAM -RW(VR) VCD

→ 21, Changing audio during play

Angle DVD-A DVD-V

Change the number to select an angle.

STILL-P (Still picture) DVD-A

Selects the play method for still pictures.

Slide Show: Plays according to the default order on the disc.

Page: Select the still picture number and play.

- **RANDOM:** Plays in random order.

- **Return:** Returns to the default still picture on the disc.

PBC (Playback control) VCD (→ 66)

Indicates whether menu play (playback control) is on or off.

[A] Soundtrack/Subtitle language

ENG: English	SVE: Swedish	CHI: Chinese
FRA: French	NOR: Norwegian	KOR: Korean
DEU: German	DAN: Danish	MAL: Malay
ITA: Italian	POR: Portuguese	VIE: Vietnamese
ESP: Spanish	RUS: Russian	THA: Thai
NLD: Dutch	JPN: Japanese	*: Others

[B] Audio attributes

LPCM/PPCM/DD Digital/DTS/MPEG: Signal type

k (kHz): Sampling frequency

b (bit): Number of bits

ch (channel): Number of channels

For your reference

- The display changes according to the disc content. You cannot make a change when there is no recording.
- Some discs allow changes to soundtracks, subtitles, and angles only by using the disc's setup menus (→ 19).

▶ Play menu



Repeat Play

This function works only when the elapsed play time is displayed.
Select the item for repeat play. Depending on the disc, the items that can be selected will differ.

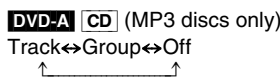
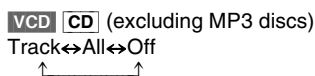

While playing a playlist

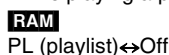

▶ Picture menu

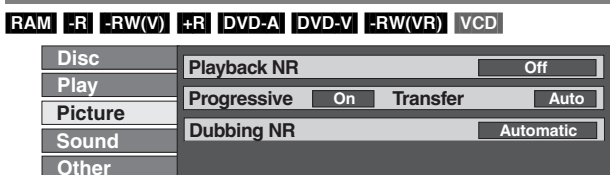

Playback NR

Reduces noise and picture degradation.
On ↔ Off

* Progressive (→ 66)

Select "On" to enable progressive output.
• Select "Off" if the picture is stretched horizontally.
On ↔ Off

* Transfer (Only when "Progressive" is set to "On")

Select the method of conversion for progressive output to suit the type of material being played (→ 66, Film and Video).

When the output signal is PAL

- Auto:** Detects 25 frame-per-second film content and appropriately converts it.
Video: Select when using "Auto", and the video content is distorted.

When the output signal is NTSC

Auto1 (normal):

Detects 24 frame-per-second film content and appropriately converts it.

Auto2: Compatible with 30 frame-per-second film content in addition to 24 frame-per-second film content.

Video: Select this when using "Auto1" and "Auto2", and the video content is distorted.

Dubbing NR (Only when AV1, AV2, AV3 or TP is selected)

Reduces video tape noise during transfer (dub).
Depending on the software, jittering may occur.

Automatic:

Noise reduction only works on picture input from a video tape.

On: Noise reduction works for any video input.

Off: Noise reduction is off. Select when you want to record input as is.

* Only when you have set "Progressive" to "On" in the SETUP menu. (→ 18)

▶ Sound menu

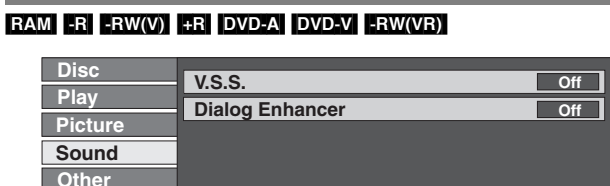

V.S.S.



(Only for Dolby Digital with 2.0 or more channels)

Enjoy a surround-like effect if you are using 2 front speakers (L/R) only.

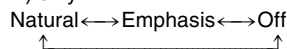

Note

- Turn V.S.S. off if it causes distortion.
- V.S.S. does not work for bilingual recordings.

Dialog Enhancer



(Dolby Digital, 3-channel or over only, including a centre channel)

The volume of the centre channel is raised to make dialog easier to hear.

On ↔ Off

▶ Other menu



Position

To change the display position

1 (Standard) –5:

The higher the setting the lower the screen moves.

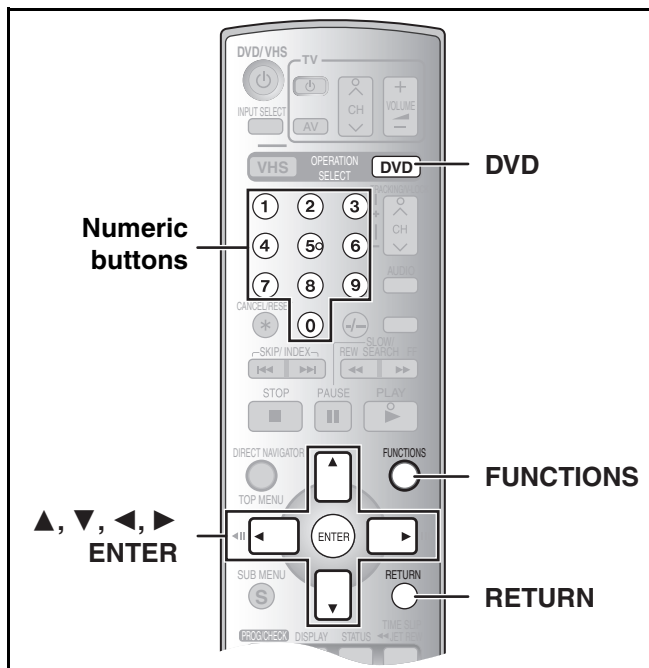

• Even if you have changed an option, the change is not activated until you press [ENTER].

■ To exit the screen

Press [RETURN] several times.

For your reference

• The settings remain intact even if you switch the unit to standby.

Entering a password (Ratings)

You can limit play of DVDs unsuitable for some audiences (children, for example). Play and changes to the settings are not possible unless you enter a password.

Preparation

• Press [DVD].

When setting ratings (→ 41)

The password screen is shown when you select levels 0 to 7.

1 Input a 4-digit password with the numeric buttons.

• If you enter a wrong number, press [◀] to erase it before you press [ENTER].

• **Do not forget your password.**

2 Press [ENTER].

3 Press [ENTER].

The password is entered and the unit is locked.

Now, when you insert a DVD-Video that exceeds the ratings limit you set, a message appears on the TV.

Follow the on-screen instructions.

When changing ratings (→ 41)

The password screen is shown when you select "Ratings".

1 Input a 4-digit password with the numeric buttons and press [ENTER].

Unlock Recorder: To unlock the unit and return the rating to 8

Change Password: To change your password

Change Level: To change the rating level

Temporary Unlock: To temporarily unlock the unit (the unit locks again if you switch it to standby or open the disc tray)

2 Select a desired item with [▲, ▼] and press [ENTER].

Actual screens depend on the operation. Follow the on-screen instructions.

Changing the unit's settings

Preparation

• Press [DVD].

■ Common procedures

Use the following procedure to change the settings if necessary.

1 While stopped

Press [FUNCTIONS].

2 Select "To Others" with [▲, ▼] and press [ENTER].

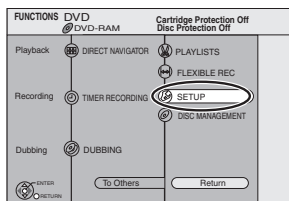

3 Select "SETUP" with [▲, ▼] and press [ENTER].

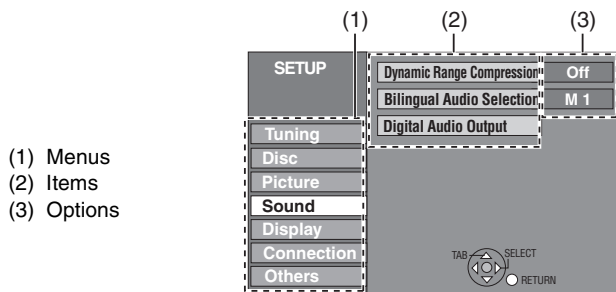

(1) Menu

(2) Items

(3) Options

4 Select a menu with [▲, ▼] and press [◀, ▶].

5 Select an item to be changed with [▲, ▼] and press [ENTER].

6 Select an option with [▲, ▼] and press [ENTER].

• Some options require different operations. Follow the displayed instructions.

■ To return to the previous screen

Press [RETURN].

Summary of settings

This description shows the initial settings for the unit. For details on menu operation. (→ 40)

- Underlined items are the factory default settings.
- indicates settings effective for both DVD and VHS.
- indicates settings effective for DVD only.

■ Tuning

Manual (→ 44)

Auto-Setup Restart (→ 45)

■ Disc

Settings for playback

Press [ENTER] to show the following settings.

Ratings (→ 40)

Set a ratings level to limit DVD-Video play.

Setting ratings (When level 8 is selected)

[8 No Limit]: All DVD-Video can be played.

[1] to [7]: Prohibits play of DVD-Video with corresponding ratings recorded on them.

[0 Lock All]: Prohibits play of all DVD-Video.

Changing ratings (When level 0 to 7 is selected)

[Unlock Recorder] [Change Password]

[Change Level] [Temporary Unlock]

DVD-Audio Video mode Playback

Select "On" to play the DVD-Video content on some DVD-Audio.

[On] [Off]

On	The setting returns to "Off" when you change the disc or turn the unit off.
-----------	---

Soundtrack

[English] [French] [German] [Italian] [Spanish] [Original]

[Other ****]

Subtitle

[Automatic] [English] [French] [German] [Italian]

[Spanish] [Other ****]

Menus

[English] [French] [German] [Italian] [Spanish]

[Other ****]

Choose the language for audio, subtitles and disc menus. **DVD-V**

- If a language which is not recorded is selected, or if languages are already fixed on the disc, the language set as the default on the disc will be played instead.

Original

The original language of each disc will be selected.

Other ****

This is the language code setting.

Input a code number with the numeric buttons. (→ 43, Language code list)

Automatic

If the language selected for "Soundtrack" is not available, subtitles of that language will automatically appear if available on the disc.

Settings for recording

Press [ENTER] to show the following settings.

Recording time in EP mode

Select the maximum number of hours for recording in EP mode (→ 23, Recording modes and approximate recording times).

[EP (6Hours)] [EP (8Hours)]

EP (6Hours)	You can record for 6 hours on an unused 4.7 GB disc.
EP (8Hours)	You can record for 8 hours on an unused 4.7 GB disc.

■ Picture

Comb Filter

Select the picture sharpness when recording.

The setting is fixed with "On" if you set "TV System" (→ 42) to "NTSC".

[On] [Off]

On	Pictures become clear and vivid. Normally, use this setting.
Off	Select it when recording noisy pictures.

Still Mode

Select the type of picture shown when you pause play.

(→ 66, Frame and field)

[Automatic] [Field] [Frame]

Field	Select if jittering occurs when "Automatic" is selected.
Frame	Select if you cannot see small text or fine patterns clearly when "Automatic" is selected.

• Underlined items are the factory default settings.

■ Sound

Dynamic Range Compression

DVD-V (Dolby Digital only)

Change the dynamic range (→ 66) for easier listening in low volume.

[On] [Off]

Bilingual Audio Selection

Select whether to record the main or secondary audio type when recording to DVD-R, DVD-RW (DVD-Video format) or +R. (You cannot select this when recording from an external device or TP channel. Select it on the external device or VHS.)

[M 1] [M 2]

Digital Audio Output

Change the settings when you have connected equipment through the unit's DIGITAL AUDIO OUT terminal (→ 15).

Note

Incorrect settings can cause noise to be output which can be harmful to your ears and speakers, and audio will not be recorded properly on media such as mini discs.

Press [ENTER] to show the following settings.

PCM Down Conversion

Select how to output audio with a sampling frequency of 96 kHz or 88.2 kHz.

- Signals are converted to 48 kHz or 44.1 kHz despite the above settings if the signals have a sampling frequency of over 96 kHz or 88.2 kHz, or the disc has copy protection.

[On] [Off]

On	Signals are converted to 48 kHz or 44.1 kHz. (Choose when the connected equipment cannot process signals with sampling frequency of 96 kHz or 88.2 kHz.)
Off	Signals are output as 96 kHz or 88.2 kHz. (Choose when the connected equipment can process signals with sampling frequency of 96 kHz or 88.2 kHz.)

Dolby Digital

Choose whether to output by "Bitstream" which processes Dolby Digital signals on other connected equipment or to convert the signals to "PCM" (2 channels) on the unit before output.

[Bitstream] [PCM]

Bitstream	When you have connected the unit to a piece of equipment having Dolby Digital logo.
PCM	When you have connected the unit to a piece of equipment that doesn't have Dolby Digital logo.

DTS

Choose whether to output by "Bitstream" which processes DTS signals on other connected equipment or to convert the signals to "PCM" (2 channels) on the unit before output.

[Bitstream] [PCM]

Bitstream	When you have connected the unit to a piece of equipment having DTS logo.
PCM	When you have connected the unit to a piece of equipment that doesn't have DTS logo.

MPEG

Choose whether to output by "Bitstream" which processes MPEG signals on other connected equipment or to convert the signals to "PCM" (2 channels) on the unit before output.

[Bitstream] [PCM]

Bitstream	When you have connected the unit with a built-in MPEG decoder.
PCM	When you have connected the unit that doesn't have a built-in MPEG decoder.

■ Display

On-Screen Messages

Choose whether to show status messages automatically or not.

[Automatic] [Off]

Grey Background

Select whether to show the grey background, normally shown when TV reception is poor.

[On] [Off]

FL Display

Changes the brightness of the unit's display.

[Bright] [Dim] [Automatic]

Automatic	The display turns dark during play, and reappears momentarily if a button is pressed. When the unit is turned off, the unit's display disappears. While using this mode the standby power consumption can be reduced.
------------------	---

- When "Power Save" is set to "On" (→ 43), this setting is automatically set to "Automatic".

■ Connection

TV Aspect (→ 17)

[16:9] [4:3] [Letterbox]

Progressive (→ 18)

[On] [Off]

On	Select when connecting to an LCD or plasma television with component video input terminals.
Off	Select when connecting to a regular television (CRT: Cathode ray tube) even if it is progressive compatible.

TV System

[PAL] [NTSC]

PAL	Select when connecting to a PAL or Multi-system TV. Programmes recorded using NTSC are played as PAL60. Select to record TV programmes and PAL input from other equipment.
NTSC	Select when connecting to a NTSC TV. Programmes recorded using NTSC are played as NTSC. Select to record NTSC input from other equipment. TV programmes cannot be recorded properly on DVD.

- To change the TV system (PAL/NTSC) setting: While stopped, keep pressing [■] on the DVD main unit and [▲ OPEN/CLOSE] on the main unit for 5 or more seconds.

• Underlined items are the factory default settings.

■ Others

Remote Control (→ 17)

[MODE 1] [MODE 2] [MODE 3]

Clock (→ 46)

Power Save

[On] [Off]

On	The power consumption is greatly reduced when the unit is turned off. <ul style="list-style-type: none"> • “FL Display” (→ 42) is automatically set to “Automatic”. • The “Quick Start” (→ right) function does not work. (It is automatically turned to “Off”.) • The power save function is not activated when either DVD or VHS is in the standby mode.
Off	The power consumption is not reduced when the unit is turned off.

• If “Quick Start” (→ right) is set to “On”, “Power Save” is automatically turned to “Off”.

Quick Start

1 Sec. Quick Start for Recording on DVD-RAM*

* From the power off state, recording on DVD-RAM starts about 1 second after first pressing the [⏪, DVD/VHS] and then sequentially pressing the [●, REC] (Quick Start Mode).

Power consumption is also higher when the unit is turned off if this is set to “On”.

[On] [Off]

• If this is set to “On”, “Power Save” is automatically turned to “Off”.

Country (→ 16)

[Australia] [New Zealand] [Others]

Shipping Condition

All the settings except for the ratings level including the password and time settings return to the factory preset. The timer recording programmes are also cancelled.

[Yes] [No]

Default Settings

All the settings other than the programmed channels, time settings, country settings, disc language settings, rating level including the password and remote control code return to the factory presets.

[Yes] [No]

Language code list

Abkhazian: 6566	Chinese: 9072	Hausa: 7265	Lithuanian: 7684	Romanian: 8279	Telugu: 8469
Afar: 6565	Corsican: 6779	Hebrew: 7387	Macedonian: 7775	Russian: 8285	Thai: 8472
Afrikaans: 6570	Croatian: 7282	Hindi: 7273	Malagasy: 7771	Samoan: 8377	Tibetan: 6679
Albanian: 8381	Czech: 6783	Hungarian: 7285	Malay: 7783	Sanskrit: 8365	Tigrinya: 8473
Ameharic: 6577	Danish: 6865	Icelandic: 7383	Malayalam: 7776	Scots Gaelic: 7168	Tonga: 8479
Arabic: 6582	Dutch: 7876	Indonesian: 7378	Maltese: 7784	Serbian: 8382	Turkish: 8482
Armenian: 7289	English: 6978	Interlingua: 7365	Maori: 7773	Serbo-Croatian: 8372	Turkmen: 8475
Assamese: 6583	Esperanto: 6979	Irish: 7165	Marathi: 7782	Shona: 8378	Twi: 8487
Aymara: 6589	Estonian: 6984	Italian: 7384	Moldavian: 7779	Sindhi: 8368	Ukrainian: 8575
Azerbaijani: 6590	Faroese: 7079	Japanese: 7465	Mongolian: 7778	Singhalese: 8373	Urdu: 8582
Bashkir: 6665	Fiji: 7074	Javanese: 7487	Nauru: 7865	Slovak: 8375	Uzbek: 8590
Basque: 6985	Finnish: 7073	Kannada: 7578	Nepali: 7869	Slovenian: 8376	Vietnamese: 8673
Bengali, Bangla: 6678	French: 7082	Kashmiri: 7583	Norwegian: 7879	Somali: 8379	Volapük: 8679
Bhutani: 6890	Frisian: 7089	Kazakh: 7575	Oriya: 7982	Spanish: 6983	Welsh: 6789
Bihari: 6672	Galician: 7176	Kirghiz: 7589	Pashto, Pushto: 8083	Sundanese: 8385	Wolof: 8779
Breton: 6682	Georgian: 7565	Korean: 7579	Persian: 7065	Swahili: 8387	Xhosa: 8872
Bulgarian: 6671	German: 6869	Kurdish: 7585	Polish: 8076	Swedish: 8386	Yiddish: 7473
Burmese: 7789	Greek: 6976	Laotian: 7679	Portuguese: 8084	Tagalog: 8476	Yoruba: 8979
Byelorussian: 6669	Greenlandic: 7576	Latin: 7665	Punjabi: 8065	Tajik: 8471	Zulu: 9085
Cambodian: 7577	Guarani: 7178	Latvian, Lettish: 7686	Quechua: 8185	Tamil: 8465	
Catalan: 6765	Gujarati: 7185	Lingala: 7678	Rhaeto-Romance: 8277	Tatar: 8484	

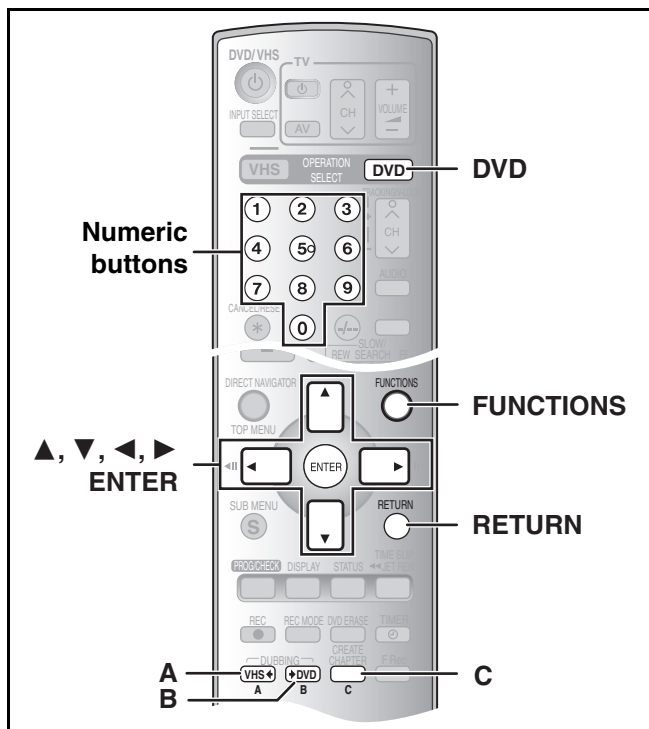

▶ Selecting the manual tuning

• Follow steps 1 to 4 of “Channel Settings”.

5 Select “Manual” with [▲, ▼] and press [ENTER].

6 Press [▲, ▼, ◀, ▶] to select the desired TV station and press [ENTER].

• The TUNING BOX screen appears.

Pos	Name	Ch	Pos	Name	Ch
1	***01	4	11	-----	---
2	***02	2	12	-----	---
3	***03	5	13	-----	---
4	***04	8	14	-----	---
5	***05	10	15	-----	---
6	-----	---	16	-----	---
7	-----	---	17	-----	---
8	-----	---	18	-----	---
9	-----	---	19	-----	---
10	-----	---	20	-----	---

Pos	1
Name	***01
Channel	4
Fine Tuning	Auto
Mono	Off

■ Handling the TUNING BOX screen

Press [▲, ▼] to select the desired field and press [▶].

Pos:

To change the order in which the TV stations are assigned to the programme positions.

Press [▲, ▼] or numeric buttons to select the number of the desired programme position and press [ENTER].

Name:

To enter or change the name of a TV station.

Press [▲, ▼, ◀, ▶] to enter station name and press [ENTER].

• If the station name needs a blank space, select the blank between “Z” and “*”.

Channel:

To enter newly available TV stations or change the channel number of an already tuned TV station.

Press [▲, ▼] or the numeric buttons to enter the channel number of the desired TV station.

• Wait a few moments until the desired TV station has been tuned.

• After the desired TV station is tuned, press [ENTER].

Fine Tuning:

To obtain the best tuning condition.

Press [▲, ▼] to obtain the best tuning condition and press [ENTER].

• If you do not want to change the tuning condition, press [▶] to return to the original condition “Auto” and press [ENTER].

Mono:

To select the type of sound to be recorded.

Select “Off” with [▲, ▼] and press [ENTER].

• Select “On” if the stereo sound is distorted due to inferior reception conditions, or if you want to record the normal (Mono) sound during a stereo, bilingual or NICAM broadcast.

■ To return to the previous screen

Press [RETURN].

■ To exit the screen

Press [RETURN] several times.

Channel Settings

Channel settings made here are applied to VHS as well.

Preparation

• Press [DVD].

1 While stopped

Press [FUNCTIONS].

2 Select “To Others” with [▲, ▼] and press

[ENTER].

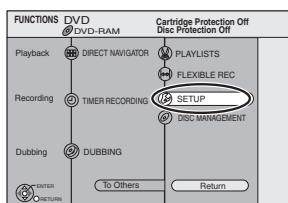

3 Select “SETUP” with [▲, ▼] and press [ENTER].

4 Select “Tuning” with [▲, ▼] and press [◀, ▶].

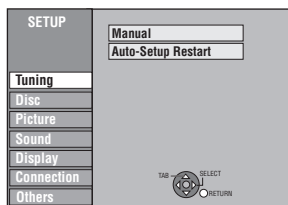

▶ Adding, deleting, and moving channels

• Follow steps 1 to 4 of “Channel Settings”.

5 Select “Manual” with [▲, ▼] and press [ENTER].

6 Press [▲, ▼, ◀, ▶] to select the desired TV station and press the [A], [B], [C] buttons to select “Delete”, “Add”, “Move”.

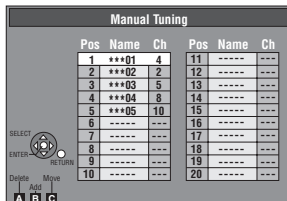

To delete a programme position “Delete”:

Press [A].

To insert a blank programme position “Add”:

Press [B].

To move a TV station to another programme position “Move”:

Press [C], and then press [▲, ▼, ◀, ▶] to select the new

programme position to which you want to assign the TV station.

Press [ENTER].

■ To return to the previous screen

Press [RETURN].

■ To exit the screen

Press [RETURN] several times.

▶ Auto-Setup Restart

You can use the SETUP menus to start auto channel setting.

• Follow steps 1 to 4 of “Channel Settings”.

5 Select “Auto-Setup Restart” with [▲, ▼] and press [ENTER].

• The confirmation screen appears.

6 Select “Yes” with [◀] and press [ENTER].

• If the country setting screen appears

Select “Others” with [▲, ▼] and press [ENTER].

Auto-Setup restarts.

■ To return to the previous screen

Press [RETURN].

■ To exit the screen

Press [RETURN] several times.

■ To stop in the middle

Press [RETURN].

Tuner System/List of TV Reception Channels

Tuner System	Channel Coverage	VHF	UHF	CATV
PAL-BGH	CCIR	E2 to E12	E21 to E69	S01 to S05, M1 to M10, U1 to U10, S21 to S41

Note

• This unit does not support SECAM system.

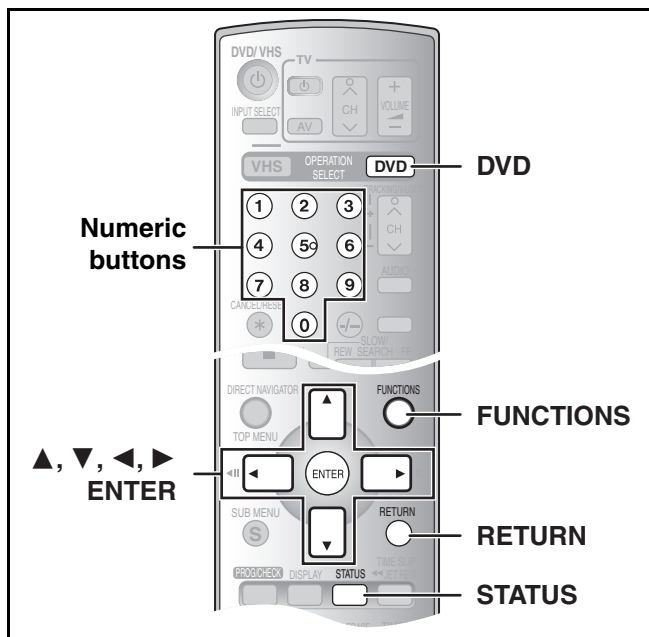

Child Lock

The child lock deactivates all buttons on the unit and remote control. Use it to prevent other people from operating the unit.

- This setting is applied to VHS as well.

To activate the child lock

Hold down [ENTER] and [RETURN] simultaneously until "X HOLD" appears on the unit's display.

- If you press a button while the child lock is on, "X HOLD" appears on the unit's display and operation is disabled.

To cancel the child lock

Hold down [ENTER] and [RETURN] simultaneously until "X HOLD" disappears.

Clock Settings

- In the case of a power failure, the clock setting remains in memory for approximately 60 minutes.
- Clock settings made here are applied to VHS as well.

Preparation

- Press [DVD].

- 1 While stopped**
Press [FUNCTIONS].
- 2 Select "To Others" with [▲, ▼] and press [ENTER].**
- 3 Select "SETUP" with [▲, ▼] and press [ENTER].**
- 4 Press [▲, ▼] to select the "Others" and press [◀, ▶].**
- 5 Press [▲, ▼] to select "Clock" and press [ENTER].**

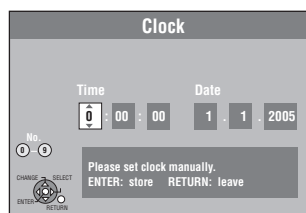

- 6 Press [◀, ▶] to select the item you want to change.**

The items change as follows:

Hour ↔ Minute ↔ Second ↔ Day ↔ Month ↔ Year

- 7 Press [▲, ▼] to change the setting.**
 - You can also use the numeric buttons for setting.
- 8 Press [ENTER] when you have finished the settings.**
 - The clock starts.

■ To return to the previous screen

Press [RETURN].

■ To exit the screen

Press [RETURN] several times.

FUNCTIONS window

By using the FUNCTIONS window you can access the main functions quickly and easily.

Preparation

- Press [DVD].

- 1 While stopped
Press [FUNCTIONS].

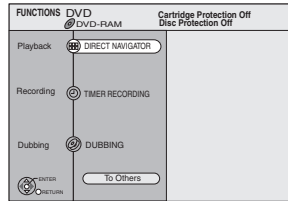

- Functions displayed depend on the type of disc.

- 2 Select an item with [▲, ▼] and press [ENTER].
 - If you select "To Others" and press [ENTER], select an item with [▲, ▼] and press [ENTER].

■ To exit the FUNCTIONS window

Press [FUNCTIONS].

Status displays

Preparation

- Press [DVD].

■ Changing the information displayed

Status messages appear on the TV when operating the unit, to show you what operation was performed and what condition the unit is in.

Press [STATUS] to change the information displayed.

The display changes each time you press the button.
For example, DVD-RAM

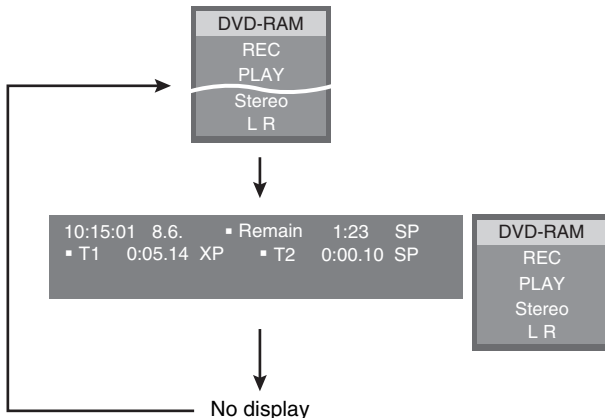

■ Display examples

- (1) Current medium
- (2) Current recording or play status, input channel
 - Shows the current state of the unit and the input channel.
 - REC: Recording
 - PAUSE: Recording paused
 - PLAY: Playing
 - PLAY X1.3: Quick Viewing (Play × 1.3)
 - ||: Playing paused
 - ▶▶: Fast forwarding (5 speeds)
 - ◀◀: Rewinding (5 speeds)
 - ⏪: Slow-motion (5 speeds)
 - ◀: Reverse slow-motion (5 speeds)
 - OPEN/CLOSE: Indicates the status of the disc tray
- (3) TV audio type being received
 - Stereo: STEREO/NICAM stereo broadcast
 - M1/M2: Bilingual/NICAM dual-sound broadcast
 - M1: NICAM monaural broadcast
- (4) Selected audio type (→ 21)

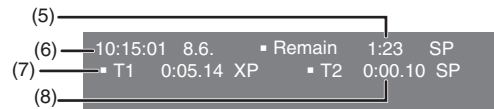
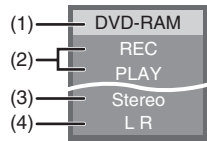

- (5) Available recording time and recording mode
(e.g.: "1:23 SP" indicates 1 hour and 23 minutes in SP mode)
- (6) The current date and time
- (7) Elapsed play time/Recording mode
- (8) Recording time/Recording mode

Inserting a video cassette

The surface on which you can see a roll of tape should face up, **Insert a video cassette.**

- The unit is automatically turned on.

■ To eject a video cassette

- You can eject a video cassette even when the unit is in standby mode. It switches back to standby once it ejects the video cassette.

For main unit

- Press [▲, EJECT] on the main unit.

For remote control

- Press [VHS] and then press and hold [■, STOP] for about 3 or more seconds.

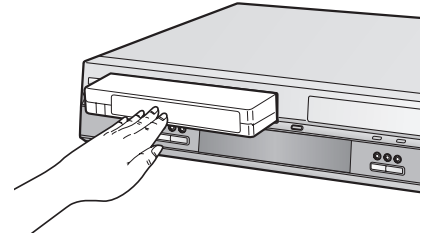

Video cassette information

■ Video cassettes

- Break off the video cassette's tab to prevent accidental erasure. Cover the hole with a double layer of adhesive tape when you want to use the video cassette for recording again.
- You can use video cassettes with the VHS and S-VHS marks, but the unit is unable to make full use of the characteristics of S-VHS video cassettes.

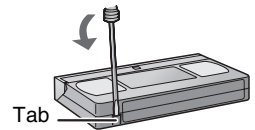

■ Video cassette care

- Poor quality or damaged video cassettes can cause the heads to become dirty and malfunction. Store your video cassettes carefully and discard them when they become dirty or damaged.
- Never use video cassettes on which liquids have been spilled or those that are extremely damaged since this will not only cause the heads to become dirty, but will also make the unit malfunction.

■ Maintenance

Cleaning the video heads

Dirt on the video heads can cause poor recording and play.



If this happens, insert and eject a cassette 5–10 times successively to remove the dirt from the video heads. If the problem persists, seek advice from a qualified service person.

Setting Up

The tuning on DVD is automatically applied to the one on VHS. Therefore, tuning on VHS is not required. When only the video output on VHS does not look natural, use the Fine Tuning function on VHS as below.

■ Fine Tuning

You can finely tune the reception on VHS regardless of the reception on DVD.

Preparation

- Select the unit viewing channel (e.g. AV input) on the TV.
- Press [VHS].
- Press [⏻, DVD/VHS] to turn the unit on.

1 Press [ENTER] for about 5 seconds or more.

- Tuning screen appears.

Tuning			
Pos	Name	Pos	Name
1	***01	6	----
2	***02	7	----
3	***03	8	----
4	***04	9	----
5	***05	10	----

◀▶ : select [ENTER] : access
[RETURN] : return

2 Press [▲, ▼, ◀, ▶] to select the desired channel name, and then press [ENTER].

- Fine Tuning screen appears.

Pos	: 1
Name	: ***01
Channel	: 4
Fine tuning	: AUTO
Mono	: OFF

◀▶ : select [ENTER] : auto
[RETURN] : return

3 Press [◀, ▶] to obtain the best tuning condition.

- Press [ENTER] to select "AUTO".

4 Press [RETURN] to start the new condition.

- To continue Fine Tuning:
Repeat steps 2–4.

■ To exit the tuning screen

Press [RETURN].

Note

- When you wish to set the item other than Fine Tuning, set it on DVD. (→ 44)
- When you set or change the Tuning menu in SETUP menu on DVD, the settings on the Fine Tuning is restored to the default.

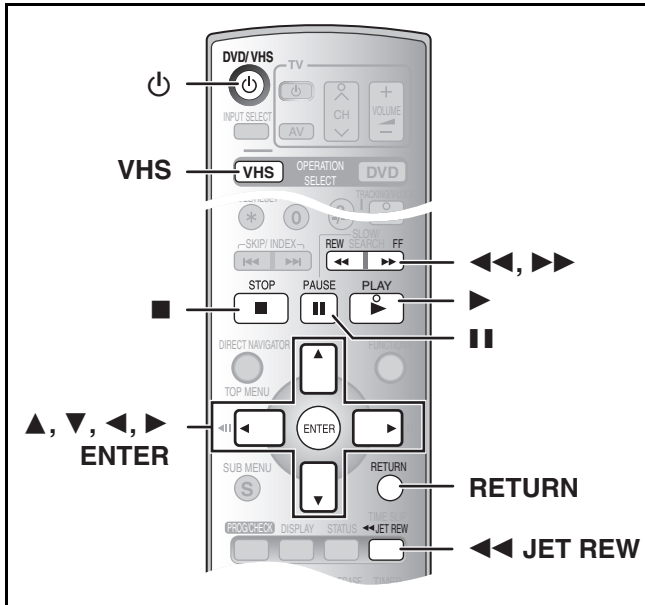

Preparation

- Select the unit viewing channel (e.g. AV input) on the TV.
- Press [VHS].

Playing a video cassette

- 1 Press [⏻, DVD/VHS] to turn the unit on.
 - 2 Insert a recorded video cassette. (→ 48)
 - 3 Press [▶, PLAY].
 - Play starts automatically if you insert a video cassette with the tab removed.
- **To pause play**
Press [⏸, PAUSE]. (Press again to restart play.)
- **To stop play**
Press [■, STOP].
- Note**
- When the unit is standby with the VHS mode, an inserted video cassette can be played back by pressing [▶, PLAY].
 - When the tape reaches its end, the unit automatically rewinds it to the beginning. This function does not work during timer recording, fast-forwarding and specified stop recording.
 - When playing back a tape which was recorded on another VCR, it may be necessary to adjust the tracking (→ 50). In some cases the picture quality may still be inferior. This is due to format constraints.

Fast-forward/Rewind

While stopped

- Press [◀◀, REW] (backward)/[▶▶, FF] (forward).
- Press [■, STOP] to stop fast-forward/Rewind.

Cue/Review

During play

- Tap or keep pressing [◀◀, REW] (backward)/[▶▶, FF] (forward).
- If you keep pressing these buttons, normal playback restarts by releasing them.
 - Tap [▶, PLAY] to restart normal playback.

Jet Search

During play

- Tap [◀◀, REW] (backward)/[▶▶, FF] (forward) twice. You can increase Cue/Review search speed.
- Press [▶, PLAY] to restart normal playback.

Slow-motion play

During play

- Press and hold [⏸, PAUSE] for about 2 seconds or more.
- Press [▶, PLAY] to restart normal playback.

Jet Rewind

To perform a higher speed rewind

Press [◀◀JET REW].

The “◀◀JET REW” indication appears on the TV screen.

- Depending on the tape or an operating condition, the rewind speed may change somewhat.
- The tape counter is reset to “0:00.00” when the tape is rewound to the beginning.
- Depending on the tape, this function may not work.

Note

- Jet Search, Cue, review or slow-motion play will be automatically cancelled after 10 minutes, and for pause play, it will be cancelled after 5 minutes.
- During playback function other than normal playback, horizontal noise bars may appear in the picture, the colour of the picture may be unstable, or the picture may be otherwise distorted.

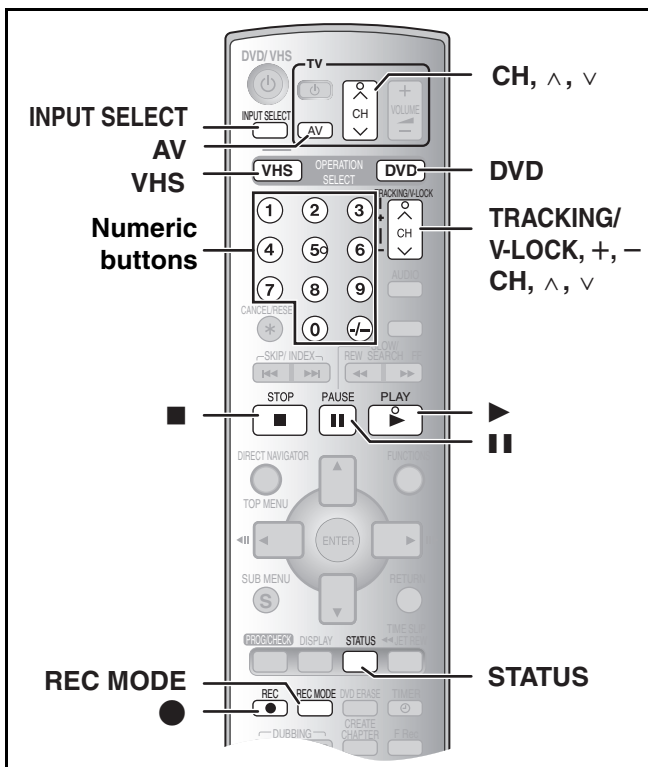

Preparation

- Press [VHS].

S-VHS Quasi Playback (SQPB)

It is also possible to play back tapes recorded in the S-VHS system.

- Some picture noise may occur depending on the type of tape used.
- It is not possible to fully obtain the high resolution that S-VHS is capable of.
- It is not possible to record in the S-VHS system with the unit.

Repeat Playback

During play or while stopped

Keep pressing [▶, PLAY] for about 5 or more seconds.

- The "RP" indication appears on the unit's display.
- At the end of the programme, the tape rewinds to the beginning of the programme and plays it again (it only works if there is at least 5 seconds blank space at the end of the programme). This repeats until you cancel it.
- Depending on tape, this function may not work.



■ To restart normal playback

Press [▶, PLAY].

■ To stop play

Press [■, STOP].

Playing a tape with high image quality

With the TP channel, you can play a tape with high image quality on a TV compatible with progressive output.

Preparation

- Connect to the TV's component video input terminals (→ 15).
- Set the output (→ 18).

- 1 Press [DVD].
- 2 Press [INPUT SELECT] or [CH, ^, v] to select the "TP" channel.
 - About TP channel (→ 59)
- 3 Press [VHS] and press [▶, PLAY].
 - Playing the tape with high image quality is initiated.

Note

- The picture may not be displayed correctly when playing NTSC tapes.

Adjusting the playback picture

■ Manual tracking

The unit usually makes tracking adjustments, but you may need to do it manually if noise appears on a tape recorded on other equipment.

During play

Keep pressing [TRACKING/V-LOCK, +] or [TRACKING/V-LOCK, -] until the noise bars disappear.

- If the noise bars appear during still playback, switch the VHS over to the slow playback mode and then adjust the tracking.

■ Vertical locking adjustment

If the still picture shakes, perform the following operation.

While paused

Keep pressing [TRACKING/V-LOCK, +] or [TRACKING/V-LOCK, -] until the picture stops shaking.

■ To return to auto tracking

Press both [TRACKING/V-LOCK, +] and [TRACKING/V-LOCK, -] simultaneously.

■ To remove the noise from a paused picture

Start slow play, then adjust the tracking.

Note

- This function may not work with some TV models and tapes.
- You can also adjust the tracking and vertical synchronization with [CH, ^, v] on the VHS side of the main unit.

Recording TV programmes

Recording procedures

Preparation

- Select the unit viewing channel (e.g. AV input) on the TV.
- Press [VHS].

1 Insert a video cassette with an intact accidental erasure prevention tab. (→ 48)

2 Press [CH, ^, v] to select a TV channel.

- If you keep pressing these buttons, the channels change quickly.

To select channels with the numeric buttons:

e.g., 5: [5]
15: [-/-] → [1] → [5]

3 Press [REC MODE] to select a recording mode.

Each time you press the button:

SP → LP → EP
↑ ↓

4 Press [●, REC] to start recording.

To pause recording

Press [II, PAUSE]. (Press again to restart recording.)

To stop recording

Press [■, STOP].

Recording mode

SP: When recording or playing in the Normal mode.

LP: When recording or playing in the Long play mode.

EP: When recording or playing in the Extra long play mode.

- To have a longer recording capacity, select "LP" or "EP".
- If the image quality is important to you or if you wish to store the tape for a long period, select "SP".

Note

- **Even if the video cassette you use is labelled "S-VHS", it is not possible to record in the S-VHS system with the unit. It records in the normal VHS system.**
- You cannot change channels while recording. You can change channels while in pause mode.
- When recording is paused for 5 or more minutes, the unit returns to stop mode.

To display the approximate remaining tape time

Select "Tape length" from the VHS FUNCTIONS menu and select the corresponding tape length. (→ 54)

Press [STATUS] several times.

The display changes as follows each time [STATUS] is pressed.

Current time → Operation status and tape counter

↑ Remaining tape time ↓

- The remaining tape time may not be displayed correctly depending on the tape used.

Specifying the time when recording will stop

While recording

Press [●, REC] on the VHS main unit to select recording time.

The unit's display

Each time you press the button:

Counter (Cancel) → OFF 30 (min.) → OFF 60 (min.) → OFF 90 (min.)
↑ OFF 240 (min.) ← OFF 180 (min.) ← OFF 120 (min.) ← ↓

For your reference

- This does not work during timer recording.
- Recording stops and the set time is cleared if you press [■, STOP].
- The unit is not turned off automatically when you set the time to stop recording by the procedure above and then the recording is stopped.

Watching the TV while recording

1 Press [AV] to change the input mode to "TV".

2 Press TV's [CH, ^, v] to select a desired TV channel.

For your reference

- You can also do this if the unit is making a timer recording.
- The recording is not affected.

Playing/Recording DVD while VHS recording

You can play or record discs while recording. The recording will not be affected.

- DVD playback (→ 19)
- DVD recording (→ 23)
 - When a tuner channel is recorded on VHS, you can record the other channel on DVD.

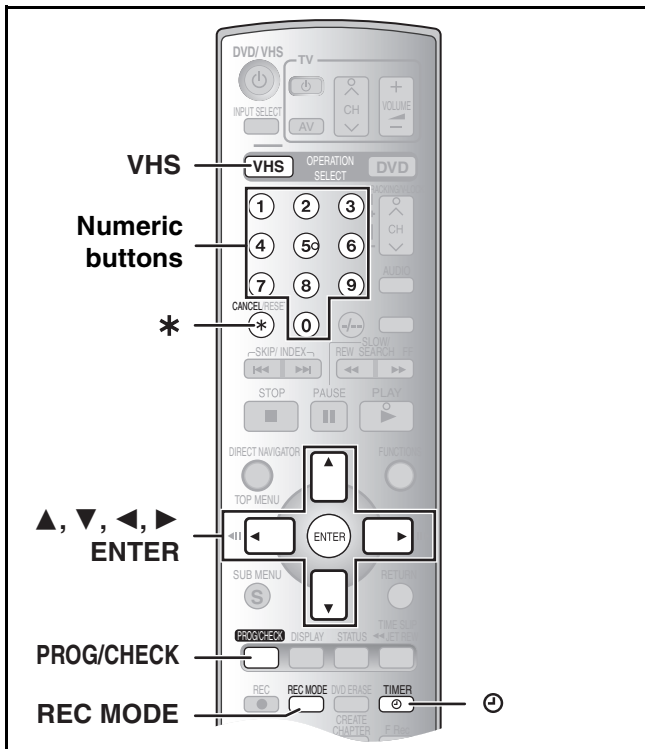

Timer Recording

You can enter up to 16 programmes a month in advance.

Preparation

- Select the unit viewing channel (e.g. AV input) on the TV.
- Check that the clock is set to the correct time. If it has not been set, set it (→ 46).
- Insert a video cassette with an intact accidental erasure prevention tab. (→ 48)
- Press [VHS].

Manual programming

1 Press [PROG/CHECK].

Highlighted line is ready for programming.

Timer recording				1/3
Name	Date	Start	Stop	SP
.....
.....
.....

2 Press [ENTER].

Timer recording				1/3
Name	Date	Start	Stop	SP
.....	SP
.....
.....
.....

3 Press [◀, ▶] to move and change the items with [▲, ▼].

- You may also use the numeric buttons to enter “Name”, “Date”, “Start”, “Stop”.
- **Name** (Programme Position/TV Station Name)
- **Date**
You can also make a daily or weekly programme.
- **Start** (start time)/**Stop** (finish time)
The time increases or decreases in 30-minute increments if you hold the button.
- **SP** (Recording mode) (→ 51)
SP ↔ LP ↔ EP ↔ A*
↑ ↑

* Recording mode Auto Change Function (→ 53)

You can also press [REC MODE] to change the recording mode.

4 Press [ENTER] when you have finished making changes.

- “Invalid entry” is displayed when you enter the wrong item. Re-enter the item.
- Repeat steps 2–4 to programme other recordings.

5 Press [⊖, TIMER].

- “⊖” lights on the VHS unit’s display.

The timer recording standby mode is activated on VHS. However, the unit may not be turned off automatically.

- You can play or record any media on DVD even if the timer recording standby mode is activated on VHS.
- Timer recording can be started whether the unit is turned on or off.

6 Turn the unit off when you do not play or record on DVD.

- If the timer recording is started with keeping the unit turned on, the unit is not turned off automatically even after the timer recording is completed. You can turn the unit off during timer recording.

To release the unit from recording standby

Press [⊖, TIMER].

“⊖” goes out.

- Be sure to press [⊖, TIMER] before the programme start time to put the unit on recording standby. Timer recording will work only if “⊖” is displayed.

To cancel recording when recording has already begun

Press [⊖, TIMER].

- You can also press and hold [■] on the VHS main unit for more than 3 seconds to stop recording.

Note

- “⊖” flashes for about 5 seconds when the unit cannot go to timer recording standby (e.g., video cassette with no accidental erasure prevention tab or no video cassette in the cassette compartment).
- If the unit is not put in the timer recording standby mode at the latest 10 minutes before the programmed timer recording starting time, the “⊖” flashes on the unit display. In this case, press [⊖, TIMER] to put the unit in the timer recording standby mode.

Recording mode Auto Change Function

During a timer recording performed in SP mode, this function automatically changes the recording mode if the unit determines that the remaining tape is insufficient to record the entire programme. If the remaining tape time is still not sufficient even in LP mode, the programme cannot be recorded to the end.

- This function cannot change the recording mode to the EP mode for PAL system.
- This function may not work correctly when you record programmes in NTSC system.
- The tape length must be set correctly. (→ 54)
- Some tapes may not work correctly.
- If the recording mode changes during a timer recording, some picture distortion occurs at the point.

Check, change or delete programmes

- Even when the unit is turned off, you can display the timer recording list by pressing [PROG/CHECK].

Preparation

- Press [VHS].

1 Press [PROG/CHECK].

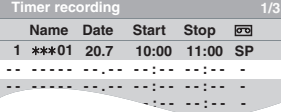

Timer recording					1/3	
Name	Date	Start	Stop	Icon		
1	***01	20.7	10:00	11:00	SP	
.....	
.....	

2 Press [▲, ▼] to select a programme.

3 Press [* , CANCEL] to delete, or press [ENTER] to change.

You cannot delete or change programmes that are currently recording.

4 If you press [ENTER] in step 3 Use [▲, ▼, ◀, ▶] to change and press [ENTER].

- To continue changing programmes steps 2–4.

5 Press [⊖, TIMER].

- “⊖” lights on the VHS unit’s display.

The timer recording standby mode is activated on VHS. However, the unit may not be turned off automatically.

- You can play or record any media on DVD even if the timer recording standby mode is activated on VHS.
- Timer recording can be started whether the unit is turned on or off.

6 Turn the unit off when you do not play or record on DVD.

- If the timer recording is started with keeping the unit turned on, the unit is not turned off automatically even after the timer recording is completed. You can turn the unit off during timer recording.

For your reference

- Programmes that failed to record are deleted from the timer recording list at 4 a.m. 2 days later.

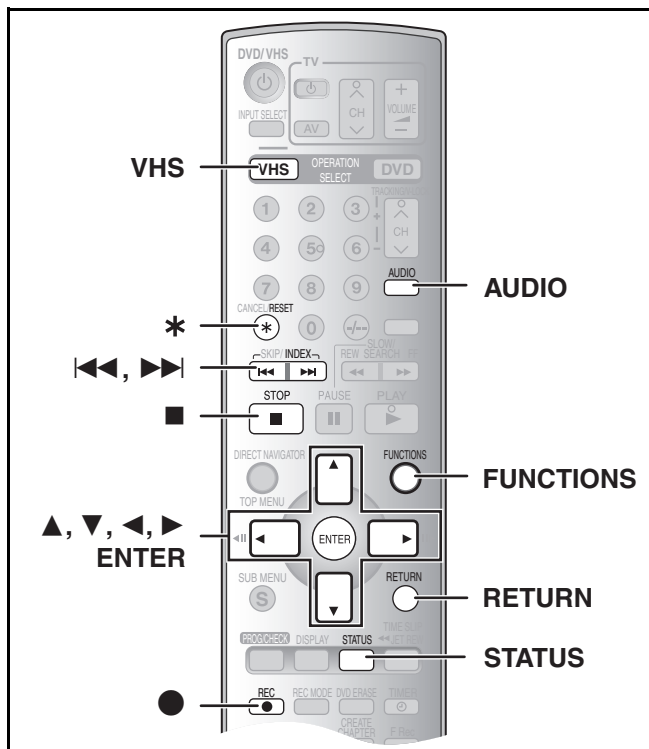

Preparation

- Press [VHS].

VHS Index Search System (VISS)

The unit automatically records special index signals on the tape every time a recording is started. The index search function makes use of these index signals to let you find the beginning of a desired programme quickly and easily.

Index signals are recorded in the following cases.

- When a recording is started by pressing [●, REC].
- When timer recording is started.

While stopped or during normal play

Press [**◀◀**, INDEX] or [**▶▶**, INDEX].

- The unit automatically starts playback after the index signal is found.
- Each press increases the number of skips.



To cancel the index search

Press [■, STOP].

Note

- Up to 20 index signals can be searched for in both directions.
- When you press either one of the buttons too much, you can control the number of skips by pressing the opposite button.
- The figure on the display decreases by 1 each time an index signal is located.
- This feature may not work correctly if the index signals are too close together. Make recordings of at least 5 minutes.

Changing the unit's settings

Common procedures

- 1 While stopped
Press [FUNCTIONS].

VHS FUNCTIONS	
Timer recording	
QUICK ERASE	
Tape length	: AUTO (◀E - 240)
SQP/B	: AUTO
OSD	: 4 : 3
▲ : select ENTER : access	
RETURN : return	

- 2 Use [▲, ▼] to select a desired item.
- 3 Press [ENTER] or [◀, ▶] to change the setting.

To exit the settings screen

Press [RETURN].

Summary of settings

This description shows the initial settings for the unit. For details on menu operation (→ above).

- Underlined items are the factory default settings.

VHS FUNCTIONS

Timer recording (→ 52)

QUICK ERASE (→ 55)

You can delete a cassette contents all at once.

Tape length

Set the length of tape you are using so the unit can show the correct remaining time.

[AUTO] [◀E-240] [E-195] [E-260] [E-300]

[AUTO] [◀E-240]: The VHS automatically distinguishes E30, -60, -90, -120, -180 and -240 tapes.

[E-195]: For E195 tape

[E-260]: For E260 tape

[E-300]: For E300 tape

SQP/B

To play back tapes recorded in the S-VHS format (SQPB; S-VHS Quasi Playback)

[AUTO] [ON] [OFF]

[AUTO]: This unit automatically detects the format in which the recording was made and selects the same format for playback. However, picture distortion may appear. Therefore, set to [ON] or [OFF].

[ON]: Use this setting when playing back a cassette tape recorded in the S-VHS format.

[OFF]: Use this setting when playing back a cassette tape recorded in the VHS format only.

OSD (→ 55)

For automatic display on the TV screen of the TV station information, type of sound system of the programme being watched and the sound playback mode.

[4:3] [WIDE] [OFF]

[4:3]: Indications can be displayed on the TV screen.

[WIDE]: Indications can be displayed on the TV screen when using wide type of TV screen and selecting the wide screen mode on the TV setting.

[OFF]: No indications appears.

QUICK ERASE

You can delete a cassette contents all at once.

- 1 Insert a cassette that you want to delete the cassette's contents.
- 2 While stopped
Press [FUNCTIONS].
- 3 Press [▲, ▼] to select "QUICK ERASE", and press [ENTER].

VHS FUNCTIONS	
Timer recording	
QUICK ERASE	
Tape length	: AUTO (◀E - 240)
SQPB	: AUTO
OSD	: 4 : 3
▲ : select [ENTER] : access	
▼ : select [RETURN] : return	

- 4 Press [ENTER] for 5 seconds or more to start the QUICK ERASE function.

- QUICK ERASE function takes approximately 30 minutes. (with E-180 cassette)

[ENTER] : press for 5 seconds
[STOP] : cancel

■ To stop in the middle

Press [■, STOP].

The tape is rewound to the beginning, and it is fast-forwarded with erasing the tape.

When the tape reaches the end, the unit automatically rewinds it to the beginning.

Note

- When a video cassette without the accidental erasure prevention tab is inserted, this function is not activated.

Various indications in on-screen display

To see these displays, set the "OSD" item in the VHS FUNCTIONS to "4:3" or "WIDE" (→ 54).

Press [STATUS].

The following screen appears.

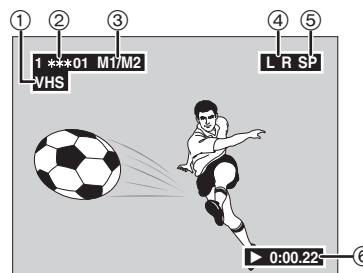

①	VHS Indication
②	Input channel
③	Audio type Show the selected audio type
④	Audio indicators The Left (L) and Right (R) indicators show which sound mode is selected as follows: L R (Stereo): Both the L and R indicators appear. L -: The L indicator appears. - R: The R indicator appears. -- (Normal): Neither the L nor R indicator appears.
⑤	Recording mode
⑥	Tape running display Pressing [STATUS] once makes the on-screen display appears. After that, press the button repeatedly to change the display as follows: Current time → Operation status and Tape counter ↑ Remaining tape time ← During Index search: "01" to "20" is displayed. (→ 54) During Jet Rewind: "◀◀ JET REW" is displayed. (→ 49) • Press [*, RESET] to reset the tape counter (elapsed time) to "0:00.00". The tape counter is automatically reset to "0:00.00" when inserting a video cassette. • The remaining time is approximate. It will be incorrect if you set the wrong tape time in the "Tape length" item in the VHS FUNCTIONS menu and if the tape is of poor quality.

Note

- These displays do not appear during special playback.
- The on-screen display may be distorted depending on the playback tape or the input signal.

Changing audio

Press [AUDIO] to select the audio type.

The audio changes as follows:

L R (Stereo) → L - → - R → - - (Normal audio track)



Before transferring (dubbing)

You can select from a variety of methods to transfer (dub) on the unit.
You cannot transfer (dub) titles which have been treated to prevent copying.

Direction		Type of transfer (dubbing) you want	Suitable methods
From	To		
VHS	DVD-RAM, DVD-R, DVD-RW, or +R	Easy transferring (dubbing) with one button ● When you want to transfer (dub) from the selected start point to the end of the tape	One Touch Transfer (→ 57)
		Transferring (dubbing) with detailed settings ● When you want to transfer (dub) from the selected start point to the end of the tape ● When you want to transfer (dub) to fit in the remaining capacity of the disc	GUI Transfer (→ 58)
		● When you want to transfer (dub) while checking the video and the audio to select the desired part	Manual Transfer (→ 59)
DVD-RAM or DVD-RW (DVD Video Recording format)	VHS	Easy transferring (dubbing) with one button ● When you want to transfer (dub) a whole disc ● When you want to transfer (dub) from the beginning of the selected title to the end of the disc	One Touch Transfer (→ 60)
		Transferring (dubbing) with detailed settings ● When you want to transfer (dub) multiple titles or playlists in combination	GUI Transfer (→ 61)
		● When you want to transfer (dub) while checking the video and the audio to select the desired part	Manual Transfer (→ 64)
DVD-R, DVD-RW (DVD-Video format) or +R	VHS	Easy transferring (dubbing) with one button ● When you want to transfer (dub) a whole disc ● When you want to transfer (dub) from the beginning of the selected title to the end of the disc	One Touch Transfer (→ 60)
		Transferring (dubbing) with detailed settings ● When you want to transfer (dub) while checking the video and the audio to select the desired part	Manual Transfer (→ 64)
Finalized disc (DVD-R, DVD-RW, +R, +RW) or DVD-Video on sale that are not copy-protected, etc.	VHS	Easy transferring (dubbing) with one button	Cannot transfer
		Transferring (dubbing) with detailed settings ● When you want to transfer (dub) whole of a disc ● When you want to transfer only for the specified time	DVD-Video Transfer (→ 62)
		● When you want to transfer (dub) while checking the video and the audio to select the desired part	Manual Transfer (→ 64)

■ Caution for transfer (dubbing) from VHS to DVD

- Copy-protected video tapes cannot be transferred (dubbed). Most of commercially sold/purchased video tapes are copy-protected to prevent illegal reproduction and they cannot be recorded.
- When a copy-protected tape is inserted, a message appears on the display and the recording stops on the spot.

Only the following operations are allowed while transferring (dubbing):

- Stopping transfer (dub) (One Touch or GUI Transfer) by pressing and holding [RETURN] for about 3 seconds or more.
- Stopping transfer (dub) (One Touch or Manual Transfer) by pressing [■, STOP].
- Switching the audio mode on VHS by pressing [AUDIO]. The audio which you are hearing is recorded.

When transfer (dubbing) is started, the following operations also start automatically

- "OSD" in VHS FUNCTIONS → "OFF" (→ 54) (One Touch, GUI or Manual Transfer)
- Recording channel indication on DVD → "TP" (One Touch or GUI Transfer)

In order to play a DVD-R, DVD-RW (DVD-Video format) or +R recorded using this unit on another playback source, the disc must first be finalized (→ 29).

■ Caution for transfer (dubbing) from DVD to VHS

- Copy-protected discs cannot be transferred (dubbed). Most of DVD-Videos are copy-protected to prevent illegal reproduction and they cannot be recorded.

Only the following operations are allowed while transferring (dubbing):

- Stopping transfer (dub) (One Touch or GUI Transfer) by pressing and holding [RETURN] for about 3 seconds or more.
- Stopping transfer (dub) (One Touch or Manual Transfer) by pressing [■, STOP].
- Switching the audio mode on DVD by pressing [AUDIO]. The audio which you are hearing is recorded. **RAM -RW(VR)**

When transfer (dubbing) is started, the following operations also start automatically

- "On-Screen Messages" in Display → "Off" (→ 42) (One Touch, GUI or Manual Transfer)
- Recording channel indication on VHS → "DC" (One Touch or GUI Transfer)

When the indicator on the right appears on the DVD side of the unit's display, the playback location of the disc is memorized by the Resume Function (→ 19). If you start transferring (dubbing) at this time, the transfer (dubbing) is executed from the top of the title which contains the starting position of playback to the end of the disc.



Transfer (Dubbing) from VHS

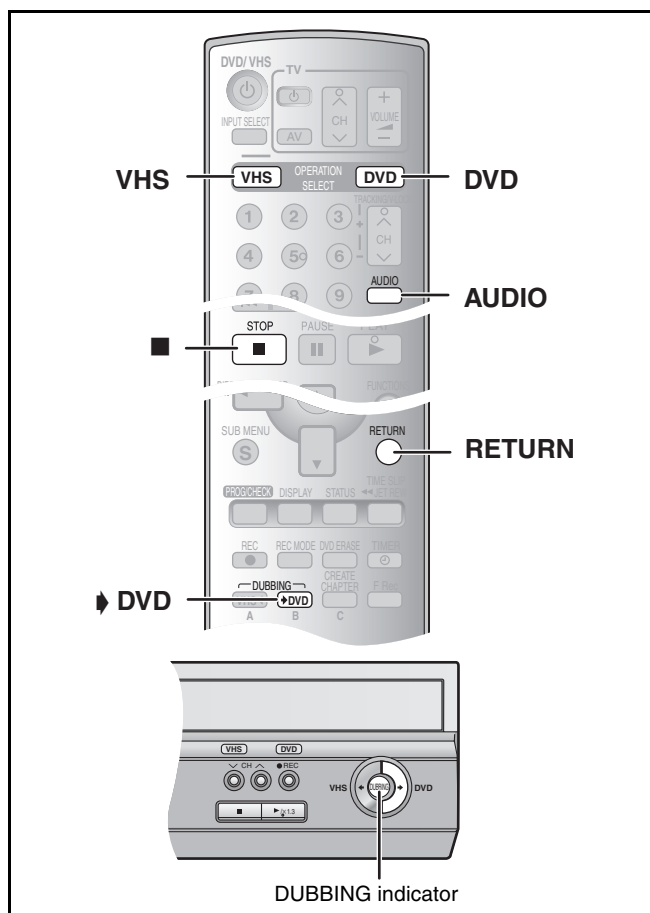

- 1 While both DVD and VHS are stopped
Press and hold [▶ DVD, DUBBING] for about 3 seconds or more (until "START" on the unit's display terminates flashing).

- On the main unit, press [▶ DVD].
- Check if transferring (dubbing) starts properly.
 - The "DUBBING" indicator on the main unit lights.
 - Transferring (Dubbing) is automatically completed when the tape reaches its end or the disc becomes full.

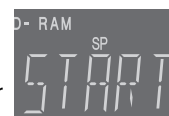

■ To stop transfer (dubbing) in the middle

Press [■, STOP] or press and hold [RETURN] for about 3 seconds or more.

Note

- You cannot operate for transferring (dubbing) while timer recording standby on both DVD and VHS. Cancel the timer recording standby.
- When the transfer (dubbing) is not started or not executed, the "DUBBING" indicator blinks for about 7 seconds. Check if the unit is properly prepared.

■ One Touch Transfer (Dubbing) (VHS → DVD)

You can transfer (dub) programmes recorded on a tape onto a disc* with one stroke of the button.

In One Touch Transfer (Dubbing), programmes are automatically transferred (dubbed) onto the disc from the location of playback at the time when the transfer (dubbing) of the tape starts.

* Available discs for transfer (dubbing) from tape are **RAM -R** **-RW(V)** **+R**.

Preparation

- Select the unit viewing channel (e.g. AV input) on the TV.

VHS (Recording source)

- Press [VHS].
- Insert the video cassette containing the programme to be copied. (→ 48)
- Press [AUDIO] to select the audio you wish to record.
- Stop the tape at the position where you wish to start recording.

DVD (Recording target)

- Press [DVD].
- Release protection. (disc → 28, cartridge → 28) **RAM**
- Insert a disc and confirm there is sufficient empty space for recording on it. (→ 8, 47)
- Select the recording mode. (→ 23)

Settings (→ 42, TV System)

- When transferring (dubbing) an NTSC tape to a DVD
 - Set "TV System" on "Connection" in SETUP to "NTSC".
- When transferring (dubbing) a PAL tape to a DVD
 - Set "TV System" on "Connection" in SETUP to "PAL".

■ Dividing a title to be transferred (dubbed)

When transferring (dubbing) from VHS to DVD, the title is divided by index signal (→ 54) detected and then recorded. You can search desired titles with Direct Navigator (→ 31) after transfer (dub) to DVD.

- Titles recorded within 15 minutes of each other may not be divided properly.
- The recording time may become longer than the original title depending on the number of index signals.

If you want to transfer (dub) without dividing the contents into titles, follow the methods below.

- Set "Time Setting" to "On" on the GUI Transfer (→ 58).
- Manual Transfer (→ 59).

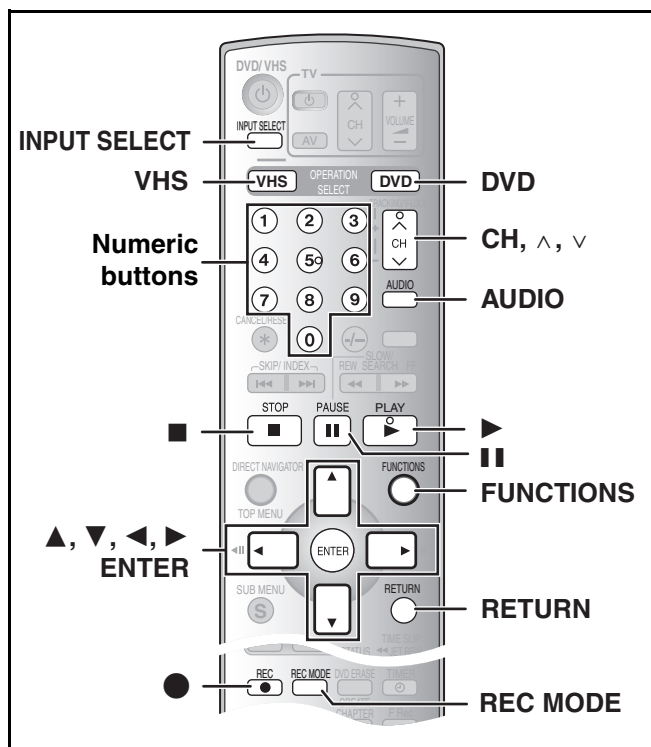

GUI (Graphical User Interface) Transfer (Dubbing) (VHS → DVD)

You can transfer (dub) programmes recorded on a tape onto a disc* from the location** of playback as of the transfer (dubbing) start of the tape.

* Available discs for transfer (dubbing) from tape are **RAM -R** **-RW(V) +R**.

** When you set the recording mode to “FR” and “Time Setting” to “Off”, you can transfer (dub) the whole tape from the beginning to the end. (→ 59)

Preparation

- Select the unit viewing channel (e.g. AV input) on the TV.

VHS (Recording source)

- Press [VHS].
- Insert the video cassette containing the programme to be copied. (→ 48)
- Press [AUDIO] to select the audio you wish to record.
- Stop the tape at the position where you wish to start recording.

DVD (Recording target)

- Press [DVD].
- Release protection. (disc → 28, cartridge → 28) **RAM**
- Insert a disc and confirm there is sufficient empty space for recording on it. (→ 8, 47)

Settings (→ 42, TV System)

- When transferring (dubbing) an NTSC tape to a DVD
 - Set “TV System” on “Connection” in SETUP to “NTSC”.
- When transferring (dubbing) a PAL tape to a DVD
 - Set “TV System” on “Connection” in SETUP to “PAL”.

- 1 Press [DVD].
- 2 While both DVD and VHS are stopped Press [FUNCTIONS].
- 3 Select “DUBBING” with [▲, ▼] and press [ENTER].

4 Set the transfer (dubbing) direction.

- Set “Source” to “VHS”.
- If you are not going to change the transfer (dub) direction, press [▼], then skip to step 5.

■ To change the setting

- (1) Make sure “Dubbing Direction” is selected and press [▶].
- (2) Make sure “Source” is selected and press [ENTER].
- (3) Press [▲, ▼] to select “VHS” and press [ENTER].
 - When you set “Source” to “VHS”, “DVD” is automatically selected on “Destination”.
- (4) Press [◀].
- (5) Press [▼].

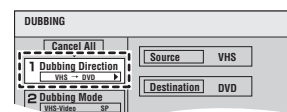

5 Set the recording mode.

- If you are not going to change the recording mode, press [▼], then skip to step 6.

■ To change the setting

- (1) Make sure “Dubbing Mode” is selected and press [▶].
- (2) Make sure “Recording Mode” is selected and press [ENTER].
- (3) Select recording mode (XP, SP, LP, EP or FR) with [▲, ▼] and press [ENTER].
 - About FR mode (→ 59)
- (4) Press [◀].
- (5) Press [▼].

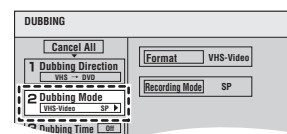

6 Set the time limit.

- If you are not going to change the recording time, press [▼], then skip to step 7.

■ To change the setting

- (1) Make sure “Dubbing Time” is selected and press [▶].
- (2) Make sure “Time Setting” is selected and press [ENTER].
- (3) Select time setting (“On” or “Off”) with [▲, ▼] and press [ENTER].
 - When you select “Off”, proceed to Step (6) below.
- (4) Press [▲, ▼] to select “Dubbing Time” and press [ENTER].
- (5) Press [◀, ▶] to select “Hour” and “Min.” and press [▲, ▼] to set the recording time, and then press [ENTER].
 - You can also set the time with the numeric buttons.
 - Maximum recording time is 8 hours.
- (6) Press [◀].
- (7) Press [▼].

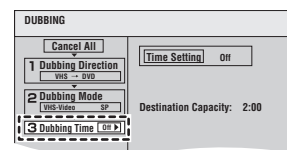

7 Make sure “Start Dubbing” is selected and press [ENTER].

- The confirmation screen appears.

8 Select “Yes” with [◀] and press [ENTER].

- Transfer (dubbing) is started.
- Transfer (dubbing) is automatically stopped when the tape reaches the end or the remaining capacity of the disc is filled. (A message appears on the TV screen and then disappears a few seconds later.)

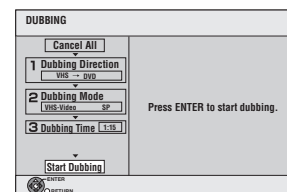

■ To stop transfer (dubbing) in the middle

Press and hold [RETURN] for about 3 seconds or more.

■ About FR mode

When “Time Setting” is set to “Off” in step 6 on page 58:

- The recording mode is automatically selected by estimating the remaining capacity of the disc for transfer (dubbing) of only the recorded parts in the video cassette (unrecorded parts will not be recorded).
- When you press [ENTER] to start transfer (dub), the tape is automatically fast-forwarded to the end and then fast-rewind to the beginning before the transfer (dubbing) is actually started. It may take time to start transfer (dub). If the remaining capacity of the disc is insufficient, the transfer (dubbing) will be stopped in the middle.
- The recording is divided into titles every time the tape index signals are detected.

When “Time Setting” is set to “On” in step 6 on page 58:

- The recording mode is automatically determined by estimating the remaining capacity of the disc for transfer (dubbing) of the contents equivalent to the recording time set from the start point of the transfer (dubbing) on the video cassette (unrecorded parts will also be recorded).
- The recording is not divided into titles.

■ Manual Transfer (Dubbing) (VHS → DVD)

You can transfer (dub) programmes recorded on a tape onto a disc* by specifying the recording parts while watching them.

* Available discs for transfer (dubbing) from tape are **RAM** **-R** **-RW(V)** **+R**.

Preparation

- Select the unit viewing channel (e.g. AV input) on the TV.

VHS (Recording source)

- Insert the video cassette containing the programme to be copied. (→ 48)

DVD (Recording target)

- Release protection. (disc → 28, cartridge → 28) **RAM**
- Insert a disc and confirm there is sufficient empty space for recording on it. (→ 8, 47)

Settings (→ 42, TV System)

- When transferring (dubbing) an NTSC tape to a DVD
 - Set “TV System” on “Connection” in SETUP to “NTSC”.
- When transferring (dubbing) a PAL tape to a DVD
 - Set “TV System” on “Connection” in SETUP to “PAL”.

1 Press [VHS] and press [▶, PLAY].

- Start playing the video cassette and find the start point of the recording.
- Press [AUDIO] to select the audio to be played (the audio to be recorded) beforehand.

2 Press [II, PAUSE] at the start point of the recording.

3 Press [DVD].

4 Select “TP” channel with [INPUT SELECT] or [CH, ▲, ▼].

- The VHS picture is displayed on the TV.
- When the DC channel is selected on VHS, you cannot select the TP channel.

5 Press [REC MODE] to select the recording mode. (→ 23)

6 Press [●, REC].

- Disc recording and VHS play start at the same time.

To pause or stop Manual Transfer (Dubbing)

You cannot stop or pause DVD and VHS at the same time.

■ To pause or stop recording

Press [DVD] and then press [II, PAUSE] or [■, STOP].

■ To pause or stop play

Press [VHS] and then press [II, PAUSE] or [■, STOP].

■ About TP channel

(TP: Dubbing input channel)

When the TP channel is selected, it becomes possible for DVD to receive audio and video signals from VHS. This enables you to transfer (dub) the video played back on VHS to DVD.

- The TP channel can be selected by pressing [DVD] and pressing [INPUT SELECT] or [CH, ▲, ▼] several times.
- When you play back a tape after turning the channel to TP, the picture on VHS is displayed on the TV screen. Utilizing this feature, you can enjoy the picture on the tape in progressive output. (→ 50)
- Contrary to the TP channel, the DC channel enables VHS to receive audio and video signals from DVD.
- When the DC channel is selected on VHS, you cannot select the TP channel on DVD.

Transfer (Dubbing) from DVD

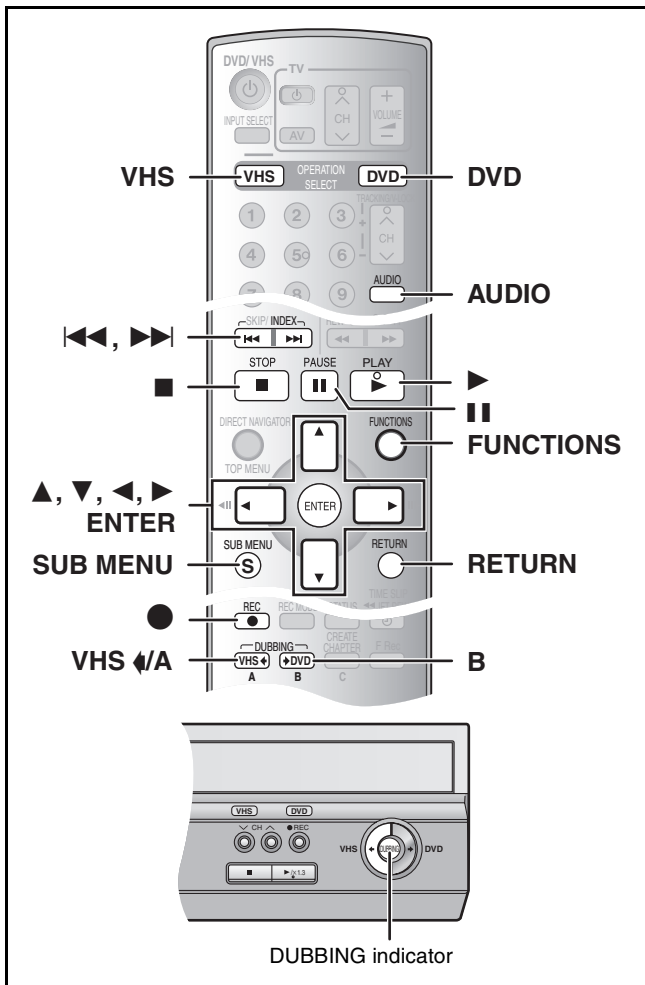

- **When you transfer (dub) a whole disc**
Make sure that the DVD is stopped.
 - When the resume function is activated (→ 19), press [■, STOP] to deactivate it.
- **When you transfer (dub) a title from the beginning of the selected title to the end of the disc**
- **When you transfer (dub) a playlist from the beginning of the selected playlist to the last playlist**
Press [▶, PLAY] to play back the desired title or playlist (→ 35).
 - You can transfer (dub) (a title or playlist) while playback is paused by pressing [||, PAUSE].
 - You cannot transfer (dub) the playlist which is longer than 8 hours. (When you transfer (dub) multiple playlists, the playlist which is longer than 8 hours is omitted.)

1 Press and hold [VHS ↓, DUBBING] for about 3 seconds or more (until "START" on the unit's display terminates flashing).

On the main unit, press [VHS ↓].

- Check if transfer (dubbing) starts properly.
- The "DUBBING" indicator on the main unit lights.
- Transferring (Dubbing) is automatically completed when playback of the disc is finished or the tape reaches its end.

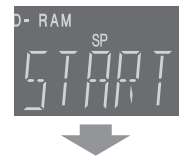

■ To stop transfer (dubbing) in the middle

Press [■, STOP] or press and hold [RETURN] for about 3 seconds or more.

Note

- You cannot operate for transferring (dubbing) while timer recording standby on both DVD and VHS. Cancel the timer recording standby.
- When the transfer (dubbing) is not started or not executed, the "DUBBING" indicator blinks for about 7 seconds. Check if the unit is properly prepared.
- If you start transfer (dubbing) when the resume function (→ 19) is activated, the DVD is transferred (dubbed) from the beginning of the title which you stopped.

■ One Touch Transfer (dubbing) (DVD → VHS)

You can transfer (dub) titles recorded on a disc* onto a tape with one stroke of the button.

In One Touch Transfer (dubbing), all contents on the disc are automatically transferred (dubbed) onto the tape.

* Available discs for transfer (dubbing) onto tape are **RAM -R**, **-RW(V)**, **+R**, **-RW(VR)**.

Preparation

- Select the unit viewing channel (e.g. AV input) on the TV.

DVD (Recording source)

- Press [DVD].
- Insert the disc containing the title to be copied. (→ 8)
- Playing back DVD.
- Press [AUDIO] to select the audio you wish to record.

RAM -RW(VR)

- Stop the disc. (→ right)

VHS (Recording target)

- Press [VHS].
- Insert a video cassette with an intact accidental erasure prevention tab. (→ 48)
- Confirm that the remaining tape time is sufficient for recording. (→ 55)
- Select the recording mode. (→ 51)

Settings (→ 42, TV System)

- When transferring (dubbing) an NTSC disc to a tape
 - Set "TV System" on "Connection" in SETUP to "NTSC".
- When transferring (dubbing) a PAL disc to a tape
 - Set "TV System" on "Connection" in SETUP to "PAL".

■ About Recording VISS (→ 54)

When transferring (dubbing) from DVD to VHS, the index signal is automatically recorded for each title. You can search desired titles with [◀◀, INDEX] or [▶▶, INDEX].

- Index signals will not be recorded automatically in the manual transfer (dubbing) function (→ 64). If you want to record index signals, press [●, REC] on the remote controller at the position you want while transferring (dubbing) in VHS mode (→ 11).

GUI (Graphical User Interface) Transfer (Dubbing) (DVD → VHS)

You can transfer (dub) multiple titles or playlists recorded on a disc* onto a tape in combination.

* Available discs for transfer (dub) onto tape are **RAM -RW(VR)**.

Preparation

• Select the unit viewing channel (e.g. AV input) on the TV.

DVD (Recording source)

- Insert the disc containing the programme to be copied. (→ 48)
- Select the audio to be played (the audio to be recorded) beforehand. **RAM -RW(VR)**

VHS (Recording target)

- Insert a video cassette with an accidental intact erasure prevention tab. (→ 48)
- Confirm that the remaining tape time is sufficient for recording. (→ 55)

Settings (→ 42, TV System)

- When transferring (dubbing) an NTSC disc to a tape
 - Set "TV System" on "Connection" in SETUP to "NTSC".
- When transferring (dubbing) a PAL disc to a tape
 - Set "TV System" on "Connection" in SETUP to "PAL".

1 Press [DVD].

2 While both DVD and VHS are stopped Press [FUNCTIONS].

3 Select "DUBBING" with [▲, ▼] and press [ENTER].

4 Set "Dubbing Direction".

- Set "Source" to "DVD".
- If you are not going to change the transfer (dub) direction, press [▼], then skip to step 5.

■ To change the setting

- (1) Make sure "Dubbing Direction" is selected and press [▶].
- (2) Make sure "Source" is selected and press [ENTER].

- (3) Press [▲, ▼] to select "DVD" and press [ENTER].

- When you set "Source" to "DVD", "VHS" is automatically selected on "Destination".

- (4) Press [◀].

- (5) Press [▼].

5 Set the recording mode.

- If you are not going to change the recording mode, press [▼], then skip to step 6.

■ To Change the setting

- (1) Make sure "Dubbing Mode" is selected and press [▶].
- (2) Make sure "Recording Mode" is selected and press [ENTER].
- (3) Select recording mode (SP, LP* or EP) with [▲, ▼] and press [ENTER].

*Only when transferring (dubbing) in PAL

- (4) Press [◀].

- (5) Press [▼].

6 Register titles and playlists for transfer (dubbing).

- If you are going to transfer (dub) a registered list without making any changes to it, press [▼], then skip to step 7.

■ To set for the registration

- (1) Make sure "Create List" is selected and press [▶].

- (2) Make sure "New item (Total = 0)" is selected and press [ENTER].

- (3) Press [VHS ◀/A] to select "VIDEO" or press [▶ DVD/B] to select "PLAYLISTS".

- You can also select the view by selecting "Other View" from the SUB MENU.

- (1) Press [SUB MENU].

- (2) Make sure "Other View" is selected and press [ENTER] twice.

- (4) Press [▲, ▼, ◀, ▶] to select the title or playlist and press [ENTER].

- You can register multiple titles or playlists to the transferring (dubbing) list by repeating the above steps (2)–(4).

- To show other pages → 62

- Multiple editing → 62

- Transferring (Dubbing) list display and convenient functions → 62

- (5) Press [◀].

- Before pressing [◀], make sure that the value on "Size" is smaller than the value on "Destination Remaining".

- (6) Press [▼].

7 When you finish creating the transferring (dubbing) list, Make sure to select "Start Dubbing" and press [ENTER].

- The confirmation screen appears.

8 Select "Yes" with [◀] and press [ENTER].

- Transfer (dubbing) is started.

■ To stop transfer (dubbing) in the middle

Press and hold [RETURN] for about 3 seconds or more.

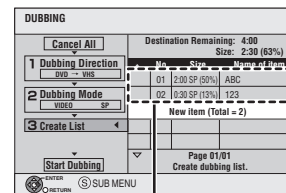
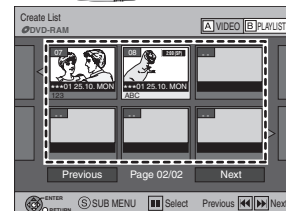
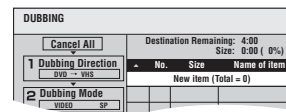
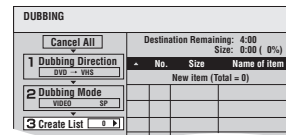

Registered titles

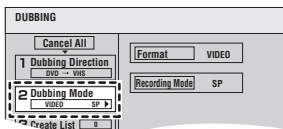
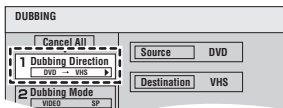
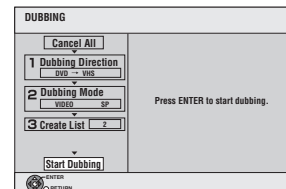

Various operations

■ To show other pages

Press [**◀◀**, SKIP] or [**▶▶**, SKIP].

- Press [**▲**, **▼**, **◀**, **▶**] to select “Previous” or “Next” and press [ENTER] to show other pages.

■ Multiple editing

Select with [**▲**, **▼**, **◀**, **▶**] and press [**■**, PAUSE]. (Repeat this to select multiple items.)

Press [ENTER] to register to the list.

- A check mark appears. Press [**■**, PAUSE] again to cancel.
- When you switch between the “VIDEO” and “PLAYLISTS” tab, the check mark is canceled.
- Titles or playlists are registered to the transferring (dubbing) list in ascending order of title number.

Transferring (Dubbing) list display and convenient functions

■ Transferring (Dubbing) list icons

: Title with “One time only recording” restriction (→ 66, CPRM)

: Title or playlist contains still picture(s)

- Titles and playlists that contain only still pictures cannot be transferred (dubbed).

- Titles and playlists displaying these marks cannot be selected.

x: Unable to play

: NTSC/: PAL

- Title or playlist recorded using a different encoding system from that of the TV system currently selected on the unit.

■ To edit the transferring (dubbing) list

In step 6 (→ 61)

1 Select a desired item in the transferring (dubbing) list with [**▲**, **▼**] and press [SUB MENU].

2 Press [**▲**, **▼**] to select the operation and press [ENTER].

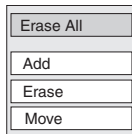

Erase All:

Erase all items registered on the transferring (dubbing) list.

- Press [**◀**] to select “Yes” and press [ENTER].

Add:

Add new items to the transferring (dubbing) list.

- Press [**▲**, **▼**, **◀**, **▶**] to select the titles and playlists to be added and press [ENTER].

Erase:

Erase the selected item.

- Press [**◀**] to select “Yes” and press [ENTER].
- Multiple editing (→ above)

Move:

Move selected items or change the order of items on the transferring (dubbing) list.

- Press [**▲**, **▼**] to select the destination and press [ENTER].

To cancel all registered transferring (dubbing) settings and lists

After performing steps 1–3 (→ 61)

1 Press [**▲**] to select “Cancel All” and press [ENTER].

2 Press [**◀**] to select “Yes” and press [ENTER].

- The settings and lists may be canceled in the following situations.

- When a title or a playlist has been recorded or erased at the transferring (dubbing) source.
- When steps have been taken, for instance, to turn off the unit or open the tray.

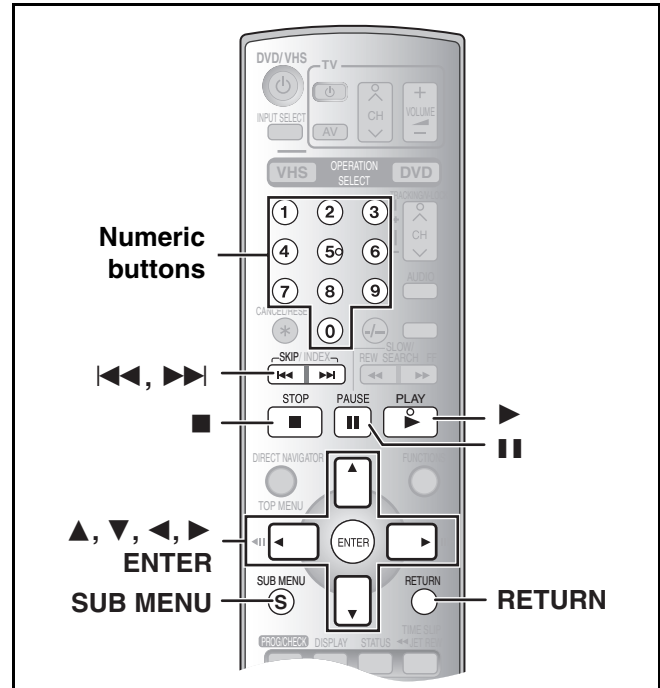
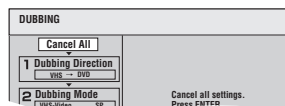

Transfer (Dubbing) a finalized disc (DVD-R, DVD-RW, +R, +RW) or DVD-Video

You can transfer (dub) the contents of a disc being played onto a tape for the set time while playing the disc.

● Operations and on screen displays during transfer (dubbing) are also recorded.

- Almost all DVD-Video on sale have been treated to prevent illegal copying, and cannot be transferred (dubbed).
- The following cannot be transferred (dubbed): DVD-Audio, Video CD, Audio CD and so on.

After performing steps 1–5 of “GUI (Graphical User Interface) Transfer (Dubbing)” (→ 61),

6 Set “Dubbing Time”.

- If you are not going to change the setting, press [**▼**], then skip to step 7.

■ Setting the unit to transfer (dub) according to the set time

- (1) Make sure “Dubbing Time” is selected and press [**▶**].
- (2) Make sure “Time Setting” is selected and press [ENTER].
- Setting the unit to transfer (dub) all the content on the disc
- (3) Press [**▲**, **▼**] to select “Off” and press [ENTER].
- (4) Press [**◀**].
- (5) Press [**▼**].
- Setting the transfer (dubbing) time
- (3) Press [**▲**, **▼**] to select “On” and press [ENTER].
- (4) Press [**▲**, **▼**] to select “Dubbing Time” and press [ENTER].
- (5) Press [**◀**, **▶**] to select “Hour” and “Min.” and press [**▲**, **▼**] to set the recording time, and then press [ENTER].
 - You can also set the time with the numeric buttons.
 - Maximum recording time is 8 hours.
- (6) Press [**◀**].
- (7) Press [**▼**].

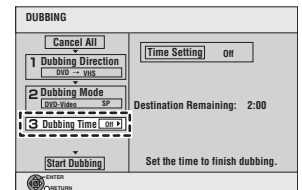

7 Make sure “Start Dubbing” is selected and press [ENTER].

Press [◀] to select “Yes” and press [ENTER] to start transfer (dub).

The disc top menu is displayed.

- Disc play automatically begins from title 1 when “Title 1” is selected from the “Auto-Play Select” menu when finalizing the disc (→ 29).

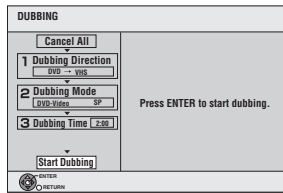

8 When the top menu is displayed Press [▲, ▼, ◀, ▶] to select the title you want to start transferring (dubbing), and press [ENTER].

- While playing in order, all the titles after the selected title are recorded until the set time.
- After the last title on the disc has finished playing the top menu is recorded until the set time is reached.

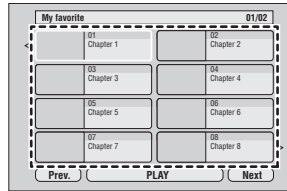

■ To stop transfer (dubbing) in the middle

Press [■, STOP] or press and hold [RETURN] for about 3 seconds or more.

Note

- The screen on the right (screen saver) is recorded at the beginning.
- If play does not begin automatically or if the top menu does not display automatically, press [▶, PLAY] to start.
- You can select the desired part of the video and then transfer (dub) it while watching the video. (→ 64)



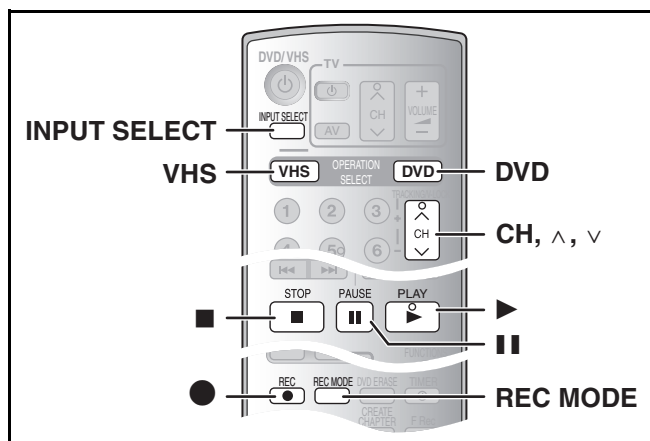

■ About DC channel

(DC: Dubbing input channel)

When the DC channel is selected, it becomes possible for VHS to receive audio and video signals from DVD. This enables you to transfer (dub) the video played back on DVD to VHS.

- The DC channel can be selected by pressing [VHS] and pressing [INPUT SELECT] or [CH, ^, v] several times.
- When you play back a disc after turning the channel to DC, the picture on DVD is displayed on the TV screen.
- Contrary to the DC channel, the TP channel enables DVD to receive audio and video signals from VHS.
- When the TP channel is selected on DVD, you cannot select the DC channel on VHS.

■ Manual Transfer (Dubbing) (DVD → VHS)

You can transfer (dub) titles recorded on a disc onto a tape by specifying the recording parts while watching them.

Preparation

- Select the unit viewing channel (e.g. AV input) on the TV.

DVD (Recording source)

- Insert the disc containing the title to be copied. (→ 8)

VHS (Recording target)

- Insert a video cassette with an intact accidental erasure prevention tab. (→ 48)
- Confirm that the remaining tape time is sufficient for recording. (→ 55)

Settings (→ 42, TV System)

- When transferring (dubbing) an NTSC disc to a tape
 - Set "TV System" on "Connection" in SETUP to "NTSC".
- When transferring (dubbing) a PAL disc to a tape
 - Set "TV System" on "Connection" in SETUP to "PAL".

1 Press [DVD] and press [▶, PLAY].

- Start playing the disc and find the start point of the recording.
- Select the audio to be played (the audio to be recorded) beforehand. **RAM** **RW(VR)**

2 Press [||, PAUSE] at the start point of the recording.

3 Press [VHS].

4 Select "DC" channel with [INPUT SELECT] or [CH, ^, v].

- The DVD picture is displayed on the TV.
- When the TP channel is selected on DVD, you cannot select the DC channel.

5 Press [▶, PLAY].

- Start playing the video cassette and find the start point of the recording.

6 Press [||, PAUSE] at the start point of the recording, then press [●, REC].

- Put the unit in the recording standby mode.

7 Press [REC MODE] to select the recording mode. (→ 51)

8 Press [||, PAUSE].

- VHS recording and disc play start at the same time.

To pause or stop Manual Transfer (Dubbing)

You cannot stop or pause DVD and VHS at the same time.

■ To pause or stop recording

Press [VHS] and then press [||, PAUSE] or [■, STOP].

■ To pause or stop play

Press [DVD] and then press [||, PAUSE] or [■, STOP].

Recording from an external device

When connecting to the AV3 input terminals on the front of the unit

- You can also connect to the AV1 or AV2 input terminals on the rear of the unit.

Before connecting any cables, first make sure that the power for the unit and the external device are off. Then, after connecting cables, turn on both.

Note

- If the audio output of the other equipment is monaural, connect to L/ MONO. (Both left and right channels are recorded when connected through L/MONO.)
- The S VIDEO IN terminal achieves a more vivid picture than the VIDEO IN terminal.

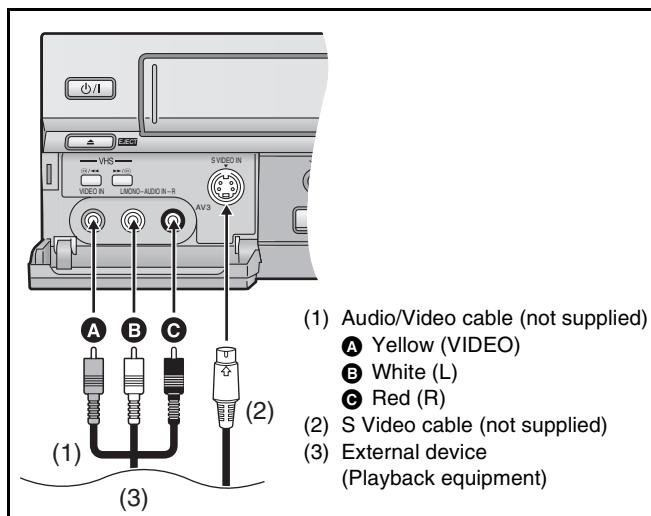

Preparation

- Select the unit viewing channel (e.g. AV input) on the TV.

DVD **RAM** **-R** **-RW(V)** **+R**

- Release protection (disc → 28, cartridge → 28). **RAM**
- Press [DVD].
- When recording bilingual programmes

RAM

When both M 1 and M 2 is selected on the connected equipment, you can select the audio type in playback.

-R **-RW(V)** **+R**

Select either M 1 or M 2 on the connected equipment. (You cannot switch between audio types during playback.)

- When the output signal from the external equipment is NTSC, change the "TV System" to "NTSC" in the SETUP menu (→ 42).
- This unit cannot record to discs containing both PAL and NTSC signals.

VHS

- Insert a video cassette with an accidental erasure prevention tab. (→ 48)
- Press [VHS].

1 Press [REC MODE] to select the recording mode. (DVD → 23, VHS → 51)

• DVD **RAM** **-R** **-RW(V)** **+R**

- It is also possible to perform Flexible Recording (FR). (→ 24)

2 While stopped

Press [CH, ^, v] or [INPUT SELECT] to select the input channel for the equipment you have connected.

- Select AV1, AV2 or AV3.

▶ DVD

Follow the above steps 1 to 2.

3 Start play on the external device.

4 Press [●, REC] at the point where you want to start recording.

▶ VHS

Follow the above steps 1 to 2.

3 Press [▶, PLAY].

- Start playing the video cassette and find the recording start point.

4 Press [||, PAUSE], then press [●, REC].

- Put the unit in recording standby mode.

5 Start play on the external device.

6 Press [||, PAUSE] at the point where you want to start recording.

■ To skip unwanted parts

Press [||, PAUSE] to pause recording. (Press again to restart recording.)

■ To stop recording

Press [■, STOP].

For your reference

- Almost all videos and DVD software on sale have been treated to prevent illegal copying. Such software cannot be recorded.

Glossary

Bitstream

This is a signal compressed and converted into digital form. It is converted back to a multi-channel audio signal, e.g., 5.1-channel, by a decoder.

CPRM (Content Protection for Recordable Media)

CPRM is technology used to protect broadcasts that are allowed to be recorded only once. Such broadcasts can be recorded only with CPRM compatible recorders and discs.

Decoder

A decoder restores the coded audio signals on DVDs to normal. This is called decoding.

Down-mixing

This is the process of remixing the multi-channel audio found on some discs into two channels. It is useful when you want to listen to the 5.1-channel audio recorded on DVDs through your TV's speakers. Some discs prohibit down-mixing. If this is the case, this unit can only output the front two channels.

Dynamic range

Dynamic range is the difference between the lowest level of sound that can be heard above the noise of the equipment and the highest level of sound before distortion occurs. Dynamic range compression means reducing the gap between the loudest and softest sounds. This means you can hear dialog clearly at low volume.

Film and Video

DVD-Videos are recorded using either film or video. The unit can determine which type has been used, then uses the most suitable method of progressive output.

For PAL

- Film is 25 frames per second.
- Video is 50 fields per second (2 fields making up 1 frame).

For NTSC

- Film is 24 or 30 frames per second, with motion picture film generally being 24 frames per second.
- Video is 60 fields per second (2 fields making up 1 frame).

Finalize

A process that makes play of a recorded CD-R, CD-RW, DVD-R, etc. possible on equipment that can play such media. You can finalize DVD-R, DVD-RW (DVD-Video format) and +R on the unit. After finalizing, the disc becomes play-only and you can no longer record or edit. However, finalized DVD-RW can be formatted to become recordable.

Formatting

Formatting is the process of making media such as DVD-RAM recordable on recording equipment. You can format DVD-RAM and DVD-RW (only as DVD-Video format) on the unit. Formatting irrevocably erases all contents on the disc.

Frame and field

Frame refers to the single images that constitute the video you see on your TV. Each frame consists of 2 fields.

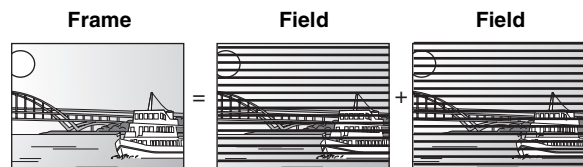

- A frame still shows 2 fields, so there may be some blurring between them, but picture quality is generally better.
- A field still shows less picture information so it may be rougher, but there is no blurring.

JPEG (Joint Photographic Experts Group)

This is a system used for compressing/decoding colour still pictures. If you select JPEG as the storage system on digital cameras, etc., the data will be compressed to 1/10–1/100 of its original size. The benefit of JPEG is less deterioration in picture quality considering the degree of compression.

MP3 (MPEG Audio Layer 3)

An audio compression method that compresses audio to approximately one-tenth of its size without any considerable loss of audio quality. You can play MP3s you have recorded onto CD-R and CD-RW.

Pan & Scan/Letterbox

In general, DVD-Video are produced with the intention that they will be viewed on a widescreen TV (16:9 aspect ratio), so images often don't fit regular TVs (4:3 aspect ratio). 2 styles of picture, "Pan & Scan" and "Letterbox", deal with this problem.

Pan & Scan: The sides are cut off so the picture fills the screen.



Letterbox: Black bands appear at the top and bottom of the picture so the picture itself appears in an aspect ratio of 16:9.



Playback control (PBC)

If a Video CD has playback control, you can select scenes and information with menus displayed on the screen. (The unit is compatible with version 2.0 and 1.1.)

Progressive/Interlace

The PAL video signal standard has 576 (or 625) interlaced (i) scan lines, whereas progressive scanning, called 576p (or 625p), uses twice the number of scan lines. For the NTSC standard, these are called 480i (or 525i) and 480p (or 525p) respectively. Using progressive output, you can enjoy the high-resolution video recorded on media such as DVD-Video.

Your television must be compatible to enjoy progressive video. Panasonic televisions with 576 (625)/50i · 50p, 480 (525)/60i · 60p input terminals are progressive compatible.

Protection

You can prevent accidental erasure by setting writing protection or erasure protection.

Sampling frequency

Sampling is the process of converting the heights of sound wave (analog signal) samples taken at set periods into digits (digital encoding). Sampling frequency is the number of samples taken per second, so larger numbers mean more faithful reproduction of the original sound.

Thumbnail

This refers to a miniature representation of a picture used to display multiple pictures in the form of a list.

TIFF (Tag Image File Format)

This is a still picture data standard. A common format for storing high quality images on digital cameras and other devices.

Frequently asked questions

Set up		Page
What equipment is necessary to play multi channel surround sound?	<ul style="list-style-type: none"> • DVD-Video: You can play DVD-Video multi channel surround by digitally connecting an amplifier equipped with a Dolby Digital or DTS decoder. • DVD-Audio: This unit plays DVD-Audio in 2 channels. You cannot play multi channel surround sound. 	15 –
Can the headphones and speakers be directly connected to the unit?	<ul style="list-style-type: none"> • You cannot directly connect to the unit. Connect through the amplifier etc. 	15
The TV has both S Video input terminal and component video input terminals. Which terminal should I connect with?	<ul style="list-style-type: none"> • Connecting with the component video terminal provides a more vivid picture compared to connecting with the S Video terminal. If you have an LCD/plasma television or LCD projector compatible with progressive scan, connect through the component video terminals for high-quality progressive video. If you have a CRT television or a multi system television using PAL mode that is compatible with progressive scan, we cannot recommend progressive output as some flickering can occur. 	15
Is my TV progressive output compatible?	<ul style="list-style-type: none"> • All Panasonic television that have 576 (625)/50i · 50p, 480 (525)/60i · 60p input terminals are compatible. Consult the manufacturer if you have another brand of television. 	–

Disc		Page
Can I play DVD-Video, DVD-Audio and Video CDs bought in another country?	<ul style="list-style-type: none"> • You cannot play DVD-Video if its region number does not include “2” or “ALL”. 	7
Can a DVD-Video that does not have a region number be played?	<ul style="list-style-type: none"> • The DVD-Video region number indicates the disc conforms to a standard. You cannot play discs that do not have a region number. 	–
Please tell me about DVD-R, DVD-RW, +R and +RW compatibility with the unit.	<ul style="list-style-type: none"> • The unit records and plays DVD-R, DVD-RW (DVD-Video format) and +R, and plays DVD-RW (DVD Video Recording format) and +RW. • The unit also records and plays high speed recording compatible DVD-R, DVD-RW, +R discs. 	6, 7 6
Please tell me about CD-R and CD-RW compatibility with the unit.	<ul style="list-style-type: none"> • This unit plays CD-R/CD-RW discs which have been recorded in one of the following standards: CD-DA, Video CD, MP3 and still pictures (JPEG/TIFF). Close the session or finalize the disc after recording. This unit can recognize up to 99 folders (groups) and 999 files (tracks) on a disc with MP3 or still pictures (JPEG/TIFF). • You cannot write to a CD-R or CD-RW with the unit. 	7, 21, 22 7

Recording		Page
Can I record from a commercially purchased video cassette or DVD?	<ul style="list-style-type: none"> • Most commercially sold video cassettes and DVD are copy protected; therefore, recording is usually not possible. 	–
Can DVD-R, DVD-RW (DVD-Video format) and +R recorded on the unit be played on other equipment?	<ul style="list-style-type: none"> • You can play on compatible equipment such as DVD players after finalizing the disc on this unit. However, depending on the condition of the recording, the quality of the disc and capabilities of the DVD player, play may not be possible. 	29
Can I record digital audio signals using the unit?	<ul style="list-style-type: none"> • You cannot record digital signals. The digital audio terminals on the unit are for output only. 	–
Can a digital audio signal from the unit be recorded to other equipment?	<ul style="list-style-type: none"> • You can record if using the PCM signal. When recording DVD, change the “Digital Audio Output” settings to the following from the SETUP menu. <ul style="list-style-type: none"> - “PCM Down Conversion”: “On” - “Dolby Digital”/“DTS”/“MPEG”: “PCM” However, only <ul style="list-style-type: none"> - As long as digital recording from the disc is permitted. - As long as the recording equipment is compatible with 48 kHz of sampling frequency. • You cannot record MP3 signals. 	42 –
Can I switch to bilingual broadcast during recording?	<ul style="list-style-type: none"> • With DVD-RAM/cassette tape, you can. Just press [AUDIO]. • With DVD-R, DVD-RW (DVD-Video format), +R you cannot. Change before recording with “Bilingual Audio Selection” in the SETUP menu. 	– 42

Error messages

Common

On the unit's display		Page
H□□, F□□ (“□□” stands for a number.)	<ul style="list-style-type: none"> An error has occurred. The number following “H” or “F” depends on the status of the unit. Reset procedure: (“The unit is on but cannot be operated.” → 70) If the service numbers fail to clear, note the service numbers and contact a qualified service person. 	–
X HOLD	<ul style="list-style-type: none"> The Child Lock function is activated. Press and hold [ENTER] and [RETURN] simultaneously until “X HOLD” disappears. 	46

DVD

On the TV		Page
Cannot finish recording completely.	<ul style="list-style-type: none"> The programme was copy-protected. The disc may be full. There are already 99 recorded titles (+R 49 recorded titles). 	–
Cannot playback. TV system is different from the setting. To playback, please change the TV System in SETUP.	<ul style="list-style-type: none"> You tried to play a title recorded using a different encoding system from that of the TV system currently selected on the unit. Alter the “TV System” setting on this unit to suit. 	42
Cannot record on the disc.	<ul style="list-style-type: none"> The disc may be dirty or scratched. 	9
Unable to format.		
Please check the disc.		
Cannot record. Disc is full.	<ul style="list-style-type: none"> Create space by erasing any unnecessary titles. RAM -RW(V) [Even if you erase recorded content from the DVD-R or +R, there is no increase in disc space. Available disc space on DVD-RW (DVD-Video format) increases only when the last recorded title is erased.] Use a new disc. 	20, 28, 31
Cannot record. Maximum number of titles exceeded.	–	–
Error has occurred. Please press ENTER.	<ul style="list-style-type: none"> Press [ENTER] to start recovery process. You cannot operate the unit while it is recovering (“SLF CHECK” appears on the unit's display). 	–
No Disc	<ul style="list-style-type: none"> The disc is upside down. 	8
Please change the disc.	<ul style="list-style-type: none"> There may be a problem with the disc. Press [▲, OPEN/CLOSE] on the main unit to remove it and check it for scratches or dirt. (The unit turns off automatically after you open the tray.) 	9
This is a non-recordable disc.	<ul style="list-style-type: none"> The unit cannot record on the disc you inserted. Insert a DVD-RAM or unfinalized DVD-R, DVD-RW (DVD-Video format) or +R. 	–
This disc is not formatted properly.	<ul style="list-style-type: none"> You inserted an unformatted DVD-RAM or DVD-RW. Format the disc with the unit. 	29
⊘	<ul style="list-style-type: none"> The operation is prohibited by the unit or disc. 	–

On the unit's display		Page
HARD ERR	<ul style="list-style-type: none"> If there is no change after turning the unit on and off, consult the dealer where the unit was purchased. 	–
NO READ	<ul style="list-style-type: none"> The disc is dirty or badly scratched. The unit cannot record, play, or edit. You have used a lens cleaner and it has finished. Press [▲, OPEN/CLOSE] on the main unit to eject the disc. 	9
		9
PROG FULL	<ul style="list-style-type: none"> There are already 16 timer programmes. Delete unnecessary timer programmes. 	27, 53
REMOTE MODE □ (“□” stands for a number.)	<ul style="list-style-type: none"> The remote control and main unit are using different codes. Change the code on the remote control.  <ul style="list-style-type: none"> Press and hold [ENTER] and the indicated number button at the same time for more than 2 seconds. 	17
SLF CHECK	<ul style="list-style-type: none"> There was a power failure or the AC plug was disconnected while the unit was on. The unit is carrying out its recovery process. Wait until the message disappears. If “Quick Start” is set to “On”, “PLEASE WAIT” is displayed while the unit is carrying out its recovery process. You cannot operate the unit while this is displayed. 	–
		–
UNFORMAT	<ul style="list-style-type: none"> You have inserted a DVD-RAM or a DVD-RW that is unformatted or a DVD-RW recorded on other equipment. 	29
UNSUPPORT	<ul style="list-style-type: none"> You have inserted a disc the unit cannot play or record on. 	6, 7
U59	<ul style="list-style-type: none"> The unit is very warm. The unit switches to standby for safety reasons. Wait for about 30 minutes until the message disappears. Select a position with good ventilation when installing the unit. Do not block the cooling fan on the rear of the unit. 	–
U99	<ul style="list-style-type: none"> The unit fails to operate properly. Press [⏻/I] on the main unit to switch the unit to standby. Now press [⏻/I] on the main unit again to turn the unit on. 	–

Troubleshooting guide

Before requesting service, make the following checks. If you are in doubt about some of the check points, or if the remedies indicated in the chart do not solve the problem, consult your dealer.

The following do not indicate a problem with the unit:

- Regular disc/tape rotating sound. The sound of the disc rotating may become louder especially when finalizing a DVD-R, DVD-RW (DVD-Video format) or +R.
- Poor reception due to atmospheric condition.
- Image disturbance during search.
- Operations do not work due to a poor-quality disc. (Try again using a Panasonic disc.)
- The unit freezes due to the activation of one of its safety devices. (Press and hold [⏻/⏹] on the main unit for 10 seconds.)

Common

Power		Page
No power	• Insert the AC mains lead securely into a known active household mains socket.	14
The unit switches to the standby mode.	• One of the unit's safety devices is activated. Press [⏻/⏹] on the main unit to turn the unit on.	–
Displays		Page
The display is dim.	• Change "FL Display" in the SETUP menu.	42
"0:00" is flashing on the unit's display.	• Set the clock.	46
The recording time display, the transfer (dubbing) process display and the displayed recording time of MP3 are different from the actual time.	<ul style="list-style-type: none"> • The time on the unit's display and the remaining recording time on the screen may be indicated less or more than the actual value. • The available recording space on DVD-R or +R does not increase when you erase titles. • Available recording space on a DVD-RW (DVD-Video format) increases only when the last recorded title is erased. It does not increase if other titles are erased. • If you repeat recording or editing about 200 times or more, the remaining capacity of the DVD-R or the +R is reduced and then recording or editing may be disabled. • The time during fast forward and rewind, or the process during transfer (dub) may not be displayed accurately. 	–
Compared to the actual recorded time, the elapsed time displayed is less (only when recording in NTSC).	• The displayed recording/play time is converted from the number of frames at 29.97 frames (equal to 0.999 seconds) to one second. There will be a slight difference between the time displayed and the actual elapsed time (e.g., actual one-hour elapsed time may display as approximately 59 minutes 56 seconds). This does not affect the recording.	–
The tape counter isn't changing.	<ul style="list-style-type: none"> • The tape counter does not change while playing unrecorded parts. The "second" display changes as follows:  <ul style="list-style-type: none"> • The unit's display also appears like this if the tape is dirty or damaged. Consult your dealer if this is the case. 	–

Operation		Page
Cannot operate the TV.	<ul style="list-style-type: none"> ● Change manufacturer code. Some TVs cannot be operated even if you change the code. ● Press [AV] to change the input mode to "TV". 	17 24, 51
Cannot operate the DVD.	<ul style="list-style-type: none"> ● Press [DVD] when operating DVD. 	11
Cannot operate the VHS.	<ul style="list-style-type: none"> ● Press [VHS] when operating VHS. 	11
The remote control doesn't work.	<ul style="list-style-type: none"> ● The remote control and main unit are using different codes. Change the code on the remote control.  <p>Press and hold [ENTER] and the indicated number button at the same time for more than 2 seconds.</p> <ul style="list-style-type: none"> ● The batteries are depleted. Replace them with new ones. ● Point the remote control at the remote control sensor on the main unit. ● Remove obstacles between the remote control and main unit. ● Don't place the signal sensor in direct sunlight or in areas that may be subject to sunlight exposure. ● The child lock function is activated. 	17 12 12 — — 46
The unit is on but cannot be operated.	<ul style="list-style-type: none"> ● Some operations are prohibited by the disc. ● The unit is warm ("U59" appears on the unit's display). Wait until "U59" disappears. ● One of the unit's safety devices may have been activated. <p>Reset the unit as follows:</p> <p>(1) Press [⏻/I] on the main unit to switch to standby. If the unit doesn't switch to standby, press and hold [⏻/I] on the main unit for about 10 seconds. The unit is forcibly switched to standby. Alternatively, disconnect the AC mains lead, wait for about 1 minute, then reconnect it.</p> <p>(2) Press [⏻/I] on the main unit to turn the unit on.</p> <ul style="list-style-type: none"> ● The child lock function is activated. 	— 68 — 46
Cannot eject a disc.	<ul style="list-style-type: none"> ● The unit is recording. ● The unit may have a problem. While the unit is off, hold down [■] and [CH, ^] on the DVD main unit simultaneously for about 5 seconds. Remove the disc and consult the dealer. ● The child lock function is activated. 	— — 46
Cannot tune channels.	<ul style="list-style-type: none"> ● Check the connections. 	14
Startup is slow.	<ul style="list-style-type: none"> ● Make sure that "Quick Start" is set to "On". Even if "Quick Start" is set to "On", startup is slow if the clock is not set, there was a power failure or the AC plug has just been connected. ● A few dozen seconds after turning on the unit, you can play a disc or start recording to discs other than DVD-RAM. ● Startup takes time for a few minutes after 5:15 a.m. due to system maintenance of this unit. 	43 — —
Takes time to read DVD-RAM.	<ul style="list-style-type: none"> ● It may take time to read a disc if it is being used for the first time in this unit or it has not been used for a long time. 	—

Picture		Page
TV reception worsens after connecting the unit.	<ul style="list-style-type: none"> ● This can occur because the signals are being divided between the unit and other equipment. It can be solved by using a signal booster, available from audio-visual suppliers. 	—
The images from the unit do not appear on the TV.	<ul style="list-style-type: none"> ● Make sure that the TV is connected to the VIDEO OUT terminal, S VIDEO OUT terminal or COMPONENT VIDEO OUT terminals on the unit. 	14, 15
Picture is distorted.	<ul style="list-style-type: none"> ● Make sure that the TV's input setting (e.g., AV 1) is correct. ● The TV isn't compatible with progressive signals. Press and hold [■] and [▶ DVD, DUBBING] on the DVD main unit at the same time for about 5 seconds. The setting will change to interlace. 	— —
The TV screen is distorted when switching the DVD/VHS.	<ul style="list-style-type: none"> ● The colour of the screen may turn to monochrome or the screen may be distorted depending on the TV used when you switch the DVD/VHS. However, this is not a malfunction. 	—

Recording, Timer recording, Transfer (dubbing), External input		Page
Timer recording does not work properly.	<ul style="list-style-type: none"> The timer programme is incorrect or different timer programme times overlap. Correct the programme. The clock is not correct. Set the clock. The unit is not on timer recording standby. ("⊖" on the unit's display is not on.) Press [⊖, TIMER]. 	27, 53 46 26, 52
Timer recording does not stop even when [■, STOP] is pressed.	<ul style="list-style-type: none"> Press [⊖, TIMER] to turn "⊖" off. Recording stops. If you start recording immediately after turning on the unit while "Quick Start" is set to "On", you cannot then stop recording for a few seconds. 	26, 52 43
The timer programme remains even after recording finishes.	<ul style="list-style-type: none"> The timer programme remains if set to daily or weekly. 	26, 52
Cannot transfer (dub) VHS to DVD.	<ul style="list-style-type: none"> The write-protect tab on the cartridge is set to "PROTECT" or the disc is protected with "DISC MANAGEMENT". TP channel is not selected on DVD when recording from a video tape to a disc. Select TP channel. Some video tapes on the market (including rental videos) are copy-protected to prevent illegal reproductions. Copy-protected video tapes cannot be properly recorded. You cannot use the transfer (dubbing) function when the FUNCTIONS window, the timer recording list screen, the VHS FUNCTIONS menu screen, etc. are displayed. 	28 59 – –
Cannot transfer (dub) DVD to VHS.	<ul style="list-style-type: none"> A video cassette without the accidental erasure prevention tab is inserted. Use a video cassette with an accidental erasure prevention tab. DC channel is not selected on VHS when recording from a disc to a video tape. Select DC channel. Some DVDs on the market (including rental DVD) are copy-protected to prevent illegal reproductions. Copy-protected DVDs cannot be properly recorded. You cannot use the transfer (dubbing) function when the FUNCTIONS window, the timer recording list screen, the VHS FUNCTIONS menu screen, etc. are displayed. 	48 64 – –
The sound level after transferring (dubbing) is not equal on DVD and on VHS.	<ul style="list-style-type: none"> The sound level on DVD and VHS may not match depending on the disc. When the sound level in a particular part of the sound source is soft or loud, the sound may be recorded softly or loudly on a video tape. 	–
Stripe-shaped black noise is recorded.	<ul style="list-style-type: none"> The device in playback is interfering with the TV because the device is too close to the TV. Move the device away from the TV. 	–
Cannot record video or sound from the external device.	<ul style="list-style-type: none"> The external device is not correctly connected. The proper external input channel (AV1, AV2 or AV3) is not selected. 	65 65

■ DVD

DVD Picture		Page
On-screen messages do not appear.	<ul style="list-style-type: none"> Select "Automatic" in "On-Screen Messages" in the SETUP menu. 	42
The grey background does not appear.	<ul style="list-style-type: none"> Select "On" in "Grey Background" in the SETUP menu. 	42
The 4:3 aspect ratio picture expands left and right.	<ul style="list-style-type: none"> Use the TV to change the aspect. If your TV does not have that function, set "Progressive" in the Picture menu to "Off". 	39
Screen size is wrong.	<ul style="list-style-type: none"> Check the settings for "TV Aspect" in the SETUP menu. 	42
There is a lot of after-image when playing video.	<ul style="list-style-type: none"> Set "Playback NR" in the Picture menu to "Off". 	39
When playing DVD-Video using progressive output, one part of the picture momentarily appears to be doubled up.	<ul style="list-style-type: none"> Set "Progressive" in the Picture menu to "Off". This problem is caused by the editing method or material used on DVD-Video, but should be corrected if you use interlace output. 	39
There is no apparent change in picture quality when adjusted with the Picture menu in the on-screen menus.	<ul style="list-style-type: none"> The effect cannot be seen with certain types of video. 	–

DVD Sound

		Page
No sound. Low volume. Distorted sound. Cannot hear the desired audio type.	<ul style="list-style-type: none"> • Check the connections and “Digital Audio Output” settings. Check the input mode on the amplifier if you have connected one. • Press [AUDIO] to select the audio. 	14, 15, 42
	<ul style="list-style-type: none"> • Set “V.S.S.” in the Sound menu to “Off” in the following cases. <ul style="list-style-type: none"> - When using discs that do not have surround sound effects such as Karaoke discs. - When playing bilingual broadcast titles. • The disc may have a restriction on the method of audio output. Some multi-channel DVD-Audio discs prohibit down-mixing. If this is the case, this unit can only output the front two channels. Refer to the disc’s jacket. DVD-A 	21 39 –
	<ul style="list-style-type: none"> • You cannot change the audio type when a DVD-R, a DVD-RW (DVD-Video format) or a +R is in the disc tray. • You cannot change the audio type when playing a DVD-R, a DVD-RW (DVD-Video format) or a +R. (You can select “M 1” or “M 2” in “Bilingual Audio Selection” in the SETUP menu before recording.) 	– 42
	<ul style="list-style-type: none"> • You have used a digital connection. Set “Dolby Digital” to “PCM” or connect using audio cables (analog connection). • There are discs whose audio cannot be changed because of how the disc was created. • You cannot change the audio while you use the TP channel. 	15, 42 – 59

DVD Play

		Page
Play fails to start even when [▶, PLAY] is pressed. Play starts but then stops immediately.	<ul style="list-style-type: none"> • Insert the disc correctly with the label facing up. • The disc is dirty. 	8 9
	<ul style="list-style-type: none"> • You tried to play a blank disc or a disc that is unplayable on the unit. • You tried to play a +RW that needs to be finalized on the equipment used for recording. • When recording to DVD-RAM using “EP (8Hours)” mode, play may not be possible on DVD players that are compatible with DVD-RAM. In this case use “EP (6Hours)” mode. 	6, 7 – 41
	<ul style="list-style-type: none"> • This occurs between playlist chapters. • This occurs as scenes change during Quick View. 	– 19
	<ul style="list-style-type: none"> • Some DVD-Video cannot be played when you change the ratings level. 	41
Audio and video momentarily pause.	<ul style="list-style-type: none"> • Multiple languages are not recorded on the disc. • You may have to use the disc’s own menus to select languages. 	– –
DVD-Video is not played.	<ul style="list-style-type: none"> • Subtitles are not recorded on the disc. • Set “Subtitle” in the Disc menu to “On”. 	– 38
Alternative soundtrack and subtitles cannot be selected.	<ul style="list-style-type: none"> • This function depends on software availability. Angles can only be changed during scenes where different angles are recorded. 	–
No subtitles.	<ul style="list-style-type: none"> • With the tray open, keep pressing [●, REC] and [▶/×1.3] on DVD side of the main unit simultaneously for about 5 or more seconds. 	–
Angle cannot be changed.	<ul style="list-style-type: none"> • This does not work when audio is other than Dolby Digital. • This does not work when recording is in XP or FR mode. 	– –
You have forgotten your ratings password.	<ul style="list-style-type: none"> • This function only works when the indicator on the right appears in the unit display. • Memorized positions are canceled when the unit is turned off or when the tray is opened. The memorized position on the playlist is also canceled when the playlist and title are edited. 	– –
Quick View does not work.		–
		–
The resume play function does not work.	<ul style="list-style-type: none"> • When connecting to Multi-system TV, select “NTSC” in “TV System” in the SETUP menu. • When connecting to PAL TV, the lower part of the picture cannot be displayed correctly during search. 	42 –
The Video CD picture does not display properly.	<ul style="list-style-type: none"> • Time Slip does not work when the unit’s “TV System” settings are different from the title recorded on the disc. 	42
Time Slip does not work.		

DVD recording, timer recording

		Page
Cannot record.	● You haven't inserted a disc or the disc you inserted cannot be recorded on. Insert a disc the unit can record onto.	6
	● The disc is unformatted. Format the disc. (RAM -RW(V))	29
	● The write-protect tab on the cartridge is set to "PROTECT" or the disc is protected with "DISC MANAGEMENT".	28
	● Some programmes have limitations on the number of times they can be recorded (CPRM).	6, 66
	● The disc is full or nearly full. Erase unneeded titles or use another disc.	20, 28, 31
	● You cannot record on finalized DVD-R, DVD-RW (DVD-Video format), +R or DVD-RW (DVD Video Recording format) discs.	29
	● If you repeatedly insert discs or turn the unit on and off about 50 times or more, the recording or editing of DVD-R, DVD-RW (DVD-Video format), +R may be disabled.	-
	● A DVD-R, DVD-RW (DVD-Video format), +R recorded on the unit may not be recordable on other Panasonic DVD recorders.	-
	● The material you are trying to record is copy-protected.	-
	● This unit cannot record to discs containing both PAL and NTSC signals.	-
A part or whole of a recorded title has been lost.	● If the power shuts down or the plug is disconnected from the household mains socket while recording or editing, the title may be lost or the disc may become unusable. We cannot offer any guarantee regarding lost titles or discs. You will have to format the disc (RAM -RW(V)) or use a new disc.	-

DVD Edit

		Page
Cannot format.	● The disc is dirty. Wipe with a damp cloth and then wipe dry.	9
	● You tried formatting a disc that is not compatible with the unit.	6
Cannot create chapters.	● The unit writes the chapter division information to the disc when you turn it off or remove the disc. The information is not written if there is an interruption in the power before this.	-
Cannot mark the start point or the end point during "Partial Erase" operation.	● These operations are not possible with still pictures.	-
	● You cannot set points if they are too close to each other. You cannot set an end point before a start point.	-
Cannot erase chapters.	● When the chapter is too short to erase, use "Combine Chapters" to make the chapter longer.	33
The available recording time doesn't increase even after erasing recordings on the disc.	● Available recording space on the DVD-R or the +R does not increase even after erasing previously recorded titles.	-
	● Available recording space on a DVD-RW (DVD-Video format) increases only when the last recorded title is erased. It does not increase if other titles are erased.	-
Cannot create a playlist.	● You cannot select all the chapters in a title at once as the source of playlist edition if the title also includes still pictures. Select them individually.	-

■ VHS

VHS Picture

		Page
Video output on VHS does not look natural.	● Use the Fine Tuning function on VHS.	48
OSD messages do not appear.	● Go to VHS FUNCTIONS menu and select "4:3" or "WIDE" in "OSD". Press [STATUS] to show the on-screen messages constantly.	54, 55

VHS Sound

		Page
Cannot hear the desired audio type.	● Press [AUDIO] to select the audio.	55
	● You cannot change the audio while you use the DC channel.	64
There is noise when playing a video tape.	● Adjust the tracking.	50
	● The tape is old or damaged.	-

VHS Play

		Page
Playback does not work properly.	● The video head is dirty.	48
	● The tape is too old or damaged.	-
	● Check the SQPB setting.	54
	● The video heads are clogged or worn: consult your dealer.	-

Specifications

Power Supply:	AC 220×(1±10%) V to 240 ×(1±10%) V, 50×(1±10%)/60×(1±10%) Hz
Power Consumption:	36 W (Approx. 7 W in Normal standby mode/ Approx. 15 W in Quick start standby mode/Approx. 4 W in power save mode)

■ DVD

Recording format	DVD-RAM: DVD Video Recording format DVD-R, DVD-RW: DVD-Video format Video: MPEG2 Audio: Dolby Digital 2 CH
Optical pickup	System with 1 lens, 2 integration units (wavelength: 662 nm for DVD, 795 nm for CD)
Recording disc	DVD-RAM: Ver. 2.0 Ver. 2.1/3×-SPEED DVD-RAM Revision 1.0 Ver. 2.2/5×-SPEED DVD-RAM Revision 2.0 DVD-R: for General Ver. 2.0 for General Ver. 2.0/4×-SPEED DVD-R Revision 1.0 for General Ver. 2.x/8×-SPEED DVD-R Revision 3.0 DVD-RW: Ver. 1.1 Ver. 1.1/2×-SPEED DVD-RW Revision 1.0 Ver. 1.2/4×-SPEED DVD-RW Revision 2.0 +R: Ver. 1.0 Ver. 1.1 Ver. 1.2
Recording mode/recording time (with 4.7 GB disc)	XP: approx. 10 Mbps/approx. 60 min SP: approx. 5 Mbps/approx. 120 min LP: approx. 2.5 Mbps/approx. 240 min EP: approx. 1.7/1.2 Mbps/approx. 360/480 min
Playable discs	DVD-RAM, DVD-R, DVD-RW, +R, +RW, DVD-Video, DVD-Audio, Video CD, CD-Audio (CD-DA), CD-R/CD-RW (MP3, JPEG, CD-DA, Video CD formatted discs)
Region code	2
Video interface	
Input ^{*1}	AV1 Pin jack: Video: 1 Vp-p AV2 Pin jack: Video: 1 Vp-p S Video: Y: 1 Vp-p, C: 0.286 Vp-p AV3 Pin jack: Video: 1 Vp-p S Video: Y: 1 Vp-p, C: 0.286 Vp-p
Output ^{*2}	DVD/VHS COMMON Pin jack: Video: 1 Vp-p DVD Pin jack: Video: 1 Vp-p S Video: Y: 1 Vp-p, C: 0.286 Vp-p Component Video (Pin jack): Y: 1 Vp-p, Pb: 0.7 Vp-p, Pr: 0.7 Vp-p
Audio interface	
Input ^{*3}	AV1 Pin jack: Standard: 0.5 Vrms, Full scale: 2 Vrms at 1 kHz AV2 Pin jack: Standard: 0.5 Vrms, Full scale: 2 Vrms at 1 kHz AV3 Pin jack: Standard: 0.5 Vrms, Full scale: 2 Vrms at 1 kHz
Output	DVD/VHS COMMON Pin jack ^{*4}: Standard: 0.5 Vrms, Full scale: 2 Vrms at 1 kHz DVD Pin jack ^{*4}: Standard: 0.5 Vrms, Full scale: 2 Vrms at 1 kHz Digital Audio (Optical terminal): PCM, Dolby Digital, DTS
Video data	
Horizontal resolution:	More than XP: 500 lines SP: 500 lines LP: 500 lines EP: 250 lines
Signal to Noise Ratio:	More than 45 dB
Frequency Response:	XP, SP: -1.5 dB ±2 dB at 3 MHz (0 dB at 0.1 MHz) LP, EP: -0.5 dB ±3 dB at 2 MHz (0 dB at 0.1 MHz)

Audio data

Dynamic Range:	Rec/PB: more than 90 dB DVD-Video PB (with LPCM): more than 96 dB CD PB: more than 96 dB
Frequency Response:	XP, SP, LP, EP (6H mode): 20 Hz to 20 kHz (0 dB ±3 dB) EP (8H mode): 20 Hz to 12 kHz (0 dB ±3 dB)
Cross Talk:	More than 60 dB at 1 kHz

LASER Specification

Class 1 LASER Product (Pickup)

Wave Length:	795 nm, 662 nm
Laser Power:	No hazardous radiation is emitted with the safety protection

■ VHS

Recording format	VHS Video Cassette System Standard with FM audio (PAL, NTSC*) *NTSC recording from external source or DVD disc, not from TV tuner.
Heads	4 helical scan heads for video 2 helical scan heads for FM audio 1 fixed head for Normal audio
Recording mode/recording time (with E-240 cassette)	PAL: SP: 23.39 mm/s 240 min LP: 11.7 mm/s 480 min EP: 7.8 mm/s 720 min NTSC: SP: 33.35 mm/s 168 min EP: 11.12 mm/s 505 min
Others	FF/REW: approx. 60 s, JET REW: approx. 43 s (with E-180 cassette)
Video interface	
Input ^{*1}	AV1 Pin jack: Video: 1 Vp-p AV2 Pin jack: Video: 1 Vp-p S Video: Y: 1 Vp-p, C: 0.286 Vp-p AV3 Pin jack: Video: 1 Vp-p S Video: Y: 1 Vp-p, C: 0.286 Vp-p
Output ^{*2}	DVD/VHS COMMON Pin jack: Video: 1 Vp-p
Audio interface	
Input ^{*3}	AV1 Pin jack: -6 dBV AV2 Pin jack: -6 dBV AV3 Pin jack: -6 dBV
Output ^{*4}	DVD/VHS COMMON Pin jack: -6 dBV
Video data	
Horizontal resolution:	More than 240 lines
Signal to Noise Ratio:	More than SP: 40 dB LP: 40 dB EP: 38 dB
Frequency Response:	SP, LP: 0 dB ±2 dB at 2 MHz (0 dB at 0.1 MHz) EP: 0 dB ±3 dB at 2 MHz (0 dB at 0.1 MHz)
Audio data	
Dynamic Range:	Hi-Fi: more than 90 dB
Frequency Response:	Hi-Fi: 20 Hz to 20 kHz (0 dB ±3 dB) Normal SP: 80 Hz to 8 kHz (-1 dB ±5 dB) Normal LP: 80 Hz to 5 kHz (0 dB ±5 dB) Normal EP: 80 Hz to 3 kHz (0 dB ±5 dB)
Signal to Noise Ratio:	Hi-Fi: more than 65 dB Normal SP: more than 43 dB Normal EP: more than 41 dB
Cross Talk:	More than 50 dB at 1 kHz (Hi-Fi)
Wow and Flutter:	Hi-Fi: less than 0.005 Wrms Normal SP: 0.2% max. Normal EP: 0.4% max.

■ DVD/VHS Common

Video interface

TV system: 625/50: PAL
525/60: NTSC

Tuner Two built-in tuners (one for DVD and another for VCR)

Tuner system: PAL-BGH

Channel coverage: VHF: CH E2 to E12, 75 ohm
UHF: CH E21 to E69, 75 ohm
CATV: CH S1 to S41, 75 ohm

RF converter Not provided

Dimensions Approx. 430 mm (W)×89 mm (H)×352 mm (D)

Mass Approx. 5.8 kg

Operating Temperature 5 °C to 40 °C

Operating Humidity 35% to 80% RH (no condensation)

*1 Input impedance of each input terminal is 75 ohm.

*2 Output impedance of each output terminal is 75 ohm.

*3 Input impedance of each input terminal is more than 47 kohm.

*4 Output impedance of each output terminal is less than 1 kohm.

Note

Mass and dimensions shown are approximate.
Specifications are subject to change without notice.

Manufactured under license from Dolby Laboratories.
“Dolby” and the double-D symbol are trademarks of Dolby Laboratories.

“DTS” and “DTS 2.0+ Digital Out” are trademarks of Digital Theater Systems, Inc.

This product incorporates copyright protection technology that is protected by method claims of certain U.S. patents and other intellectual property rights owned by Macrovision Corporation and other rights owners. Use of this copyright protection technology must be authorized by Macrovision Corporation, and is intended for home and other limited viewing uses only unless otherwise authorized by Macrovision Corporation. Reverse engineering or disassembly is prohibited.

MPEG Layer-3 audio decoding technology licensed from Fraunhofer IIS and Thomson multimedia.