

# Panasonic®

## Owner's Manual Blu-ray Disc™ Player

Model No. DMP-BDT210  
DMP-BDT110



The illustration shows the image of DMP-BDT210.

### Dear customer

Thank you for purchasing this product.

For optimum performance and safety, please read these instructions carefully.

Before connecting, operating or adjusting this product, please read the instructions completely.

Please keep this manual for future reference.

If you have any questions contact  
U.S.A. and Puerto Rico : 1-800-211-PANA(7262)  
Canada : 1-800-561-5505

# IMPORTANT SAFETY INSTRUCTIONS

Read these operating instructions carefully before using the unit. Follow the safety instructions on the unit and the applicable safety instructions listed below. Keep these operating instructions handy for future reference.

- 1 Read these instructions.
- 2 Keep these instructions.
- 3 Heed all warnings.
- 4 Follow all instructions.
- 5 Do not use this apparatus near water.
- 6 Clean only with dry cloth.
- 7 Do not block any ventilation openings. Install in accordance with the manufacturer's instructions.
- 8 Do not install near any heat sources such as radiators, heat registers, stoves, or other apparatus (including amplifiers) that produce heat.
- 9 Do not defeat the safety purpose of the polarized or grounding-type plug. A polarized plug has two blades with one wider than the other. A grounding-type plug has two blades and a third grounding prong. The wide blade or the third prong are provided for your safety. If the provided plug does not fit into your outlet, consult an electrician for replacement of the obsolete outlet.
- 10 Protect the power cord from being walked on or pinched particularly at plugs, convenience receptacles, and the point where they exit from the apparatus.
- 11 Only use attachments/accessories specified by the manufacturer.
- 12 Use only with the cart, stand, tripod, bracket, or table specified by the manufacturer, or sold with the apparatus. When a cart is used, use caution when moving the cart/apparatus combination to avoid injury from tip-over.
- 13 Unplug this apparatus during lightning storms or when unused for long periods of time.
- 14 Refer all servicing to qualified service personnel. Servicing is required when the apparatus has been damaged in any way, such as power-supply cord or plug is damaged, liquid has been spilled or objects have fallen into the apparatus, the apparatus has been exposed to rain or moisture, does not operate normally, or has been dropped.



## CAUTION

RISK OF ELECTRIC SHOCK  
DO NOT OPEN

CAUTION: TO REDUCE THE RISK OF ELECTRIC SHOCK, DO NOT REMOVE SCREWS. NO USER-SERVICEABLE PARTS INSIDE. REFER SERVICING TO QUALIFIED SERVICE PERSONNEL.



The lightning flash with arrowhead symbol, within an equilateral triangle, is intended to alert the user to the presence of uninsulated "dangerous voltage" within the product's enclosure that may be of sufficient magnitude to constitute a risk of electric shock to persons.



The exclamation point within an equilateral triangle is intended to alert the user to the presence of important operating and maintenance (servicing) instructions in the literature accompanying the appliance.

### THE FOLLOWING APPLIES ONLY IN THE U.S.A.

#### FCC Note:

This equipment has been tested and found to comply with the limits for a Class B digital device, pursuant to Part 15 of the FCC Rules. These limits are designed to provide reasonable protection against harmful interference in a residential installation. This equipment generates, uses, and can radiate radio frequency energy and, if not installed and used in accordance with the instructions, may cause harmful interference to radio communications. However, there is no guarantee that interference will not occur in a particular installation. If this equipment does cause harmful interference to radio or television reception, which can be determined by turning the equipment off and on, the user is encouraged to try to correct the interference by one or more of the following measures:

- Reorient or relocate the receiving antenna.
- Increase the separation between the equipment and receiver.
- Connect the equipment into an outlet on a circuit different from that to which the receiver is connected.
- Consult the dealer or an experienced radio/TV technician for help.

FCC Caution: To assure continued compliance, follow the attached installation instructions and use only shielded interface cables when connecting to peripheral devices.

Any changes or modifications not expressly approved by the party responsible for compliance could void the user's authority to operate this equipment.

This device complies with Part 15 of the FCC Rules. Operation is subject to the following two conditions: (1) This device may not cause harmful interference, and (2) this device must accept any interference received, including interference that may cause undesired operation.

#### Responsible Party:

Panasonic Corporation of North America  
One Panasonic Way, Secaucus, NJ 07094

#### Support Contact:

Panasonic Consumer Electronics Company  
Telephone No.: 1-800-211-PANA (7262)

## WARNING

### Unit

- To reduce the risk of fire, electric shock or product damage,
- Do not expose this unit to rain, moisture, dripping or splashing.
  - Do not place objects filled with liquids, such as vases, on this unit.
  - Use only the recommended accessories.
  - Do not remove covers.
  - Do not repair this unit by yourself. Refer servicing to qualified service personnel.

## CAUTION

### Unit

- This unit utilizes a laser. Use of controls or adjustments or performance of procedures other than those specified herein may result in hazardous radiation exposure.
- Do not place sources of naked flames, such as lighted candles, on this unit.

### Placement

- To reduce the risk of fire, electric shock or product damage,
- Do not install or place this unit in a bookcase, built-in cabinet or in another confined space. Ensure this unit is well ventilated.
  - Do not obstruct this unit's ventilation openings with newspapers, tablecloths, curtains, and similar items.

<b>CAUTION</b>	VISIBLE AND INVISIBLE LASER RADIATION WHEN OPEN, DO NOT STARE INTO BEAM. FDA 21 CFR/Class II (IIR)
<b>CAUTION</b>	CLASS IIa VISIBLE AND INVISIBLE LASER RADIATION WHEN OPEN. DO NOT VIEW DIRECTLY WITH OPTICAL INSTRUMENTS. FCC/CE/CSA II
<b>ATTENTION</b>	RAYONNEMENT LASER VISIBLE ET INVISIBLE. CLASSE IIa, EN CAS D'OUVERTURE, NE PAS REGARDER DIRECTEMENT À L'ŒIL DES INSTRUMENTS OPTIQUES.
<b>FORSIGTIG</b>	AVATTAAESSA OLET ALTTIINA LUOKAN IIN NÄKYVÄÄ JA NÄKYMÄTÖNTÄ LASERSÄTELYÄ.
<b>VARO</b>	ÄLÄ KATSO OPTISELLÄ LAITTEELLA SUORAAN SÄTEESEEN.
<b>WARNING</b>	KLASS IIa SYNLIQ OCH OSYNLIQ LASERSTRÅLNING NÄR DENNA DEL ÄR ÖPPNAD, BETRÄKTA EJ STRÅLEN DIREKT GENOM OPTISKT INSTRUMENT.
<b>VORSICHT</b>	SICHTBARE UND UNSICHTBARE LASERSTRÄHLUNG KLASSE IIa, WENN ABDECKUNG GEÖFFNET, NICHT DIREKT MIT OPTISCHEN INSTRUMENTEN BETRACHTEN.
<b>注意</b>	— 打开时有可见及不可见激光辐射。避免光束照射。
<b>注意</b>	— このを開くと可視及び不可視レーザー光が出ます。ビームを見たり、触れたりしないでください。

(Inside of product)

# Table of contents

## Getting started

IMPORTANT SAFETY	
INSTRUCTIONS . . . . .	2
Accessories . . . . .	4
Unit and media care . . . . .	4
Control reference guide . . . . .	5
Playable discs/Cards/USB devices . .	6

## Connections & Settings

STEP 1 : Connecting to a TV . . . . .	8
STEP 2 : Connecting to an amplifier/ receiver . . . . .	9
STEP 3 : Connecting to a broadband network . . . . .	10
STEP 4 : Connecting to an AC power source . . . . .	12
STEP 5 : Settings . . . . .	12

## Playback

Inserting or removing media . . . . .	16
HOME menu . . . . .	16
Playing video contents . . . . .	17
Enjoying 3D video . . . . .	20
Playing still pictures . . . . .	21
Playing music . . . . .	22
Enjoying VIERA CAST™ . . . . .	23
Playing contents saved on other equipment . . . . .	24
Linked operations with the TV (VIERA Link™ “HDAVI Control™”) . . . . .	26

## Settings

Playback menu . . . . .	27
Setup menu . . . . .	29

## Reference

Troubleshooting guide . . . . .	34
Messages . . . . .	37
Supplemental information . . . . .	38
Specifications . . . . .	39
Limited Warranty (ONLY FOR U.S.A. AND PUERTO RICO) . . . . .	41
Limited Warranty (Only for CANADA) . . . . .	42
Referencia rápida en español (Spanish Quick Reference) . . . . .	43
Index . . . . .	Back cover

### About descriptions in this Owner's Manual

- Instructions for operations are generally described using the remote control.
- This Owner's Manual is applicable to models DMP-BDT210 and DMP-BDT110. Unless otherwise indicated, illustrations in this Owner's Manual are of DMP-BDT210.  
[BDT210] [BDT110] : indicates features applicable to DMP-BDT210 and DMP-BDT110, respectively.

### About Firmware updates (⇒ 15)

# Accessories

Check the supplied accessories before using this unit.

- 1 **Remote control**  
(N2QAYB000574)
- 2 **Batteries for remote control**
  - 1 **AC power supply cord**  
(K2CB2CB00022)

## For Canada

The enclosed Canadian French label sheet corresponds to the English display on the front and back side of the unit.



- Product numbers provided in this Owner's Manual correct as of December 2010. These may be subject to change.
- Do not use AC power supply cord with other equipment.
- **For U.S.A. and Puerto Rico** : To order accessories, refer to "Accessory Purchases (United States and Puerto Rico)" on page 41.
- **For Canada** : To order accessories, call the dealer from whom you have made your purchase.

## Using the remote control

Insert so the poles (+ and -) match those in the remote control.

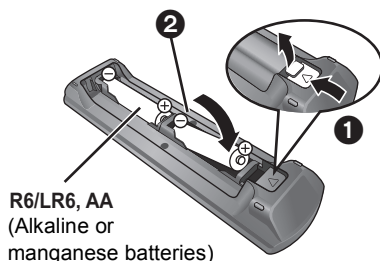

Point it at remote control signal sensor on this unit. (⇒ 5)



Mishandling of batteries can cause electrolyte leakage which can damage items the fluid contacts and may cause a fire.

- Do not mix old and new batteries or different types at the same time.
- Do not heat or expose to flame.
- Do not leave the battery(ies) in a car exposed to direct sunlight for a long period of time with doors and windows closed.
- Do not take apart or short circuit.
- Do not attempt to recharge alkaline or manganese batteries.
- Do not use batteries if the covering has been peeled off.

Remove batteries if the remote control is not going to be used for a long period of time. Store in a cool, dark place.

## CAUTION

- Danger of explosion if battery is incorrectly replaced. Replace only with the type recommended by the manufacturer.
- When disposing the batteries, please contact your local authorities or dealer and ask for the correct method of disposal.

# Unit and media care

## ■ Clean this unit with a soft, dry cloth

- Never use alcohol, paint thinner or benzene to clean this unit.
- Before using chemically treated cloth, carefully read the instructions that came with the cloth.

## ■ Clean the lens

- Use the lens cleaner (not supplied) to clean the unit's lens.

## ■ Clean discs



Wipe with a damp cloth and then wipe dry.

## ■ Disc and card handling precautions

- Handle discs by the edges to avoid inadvertent scratches or fingerprints on the disc.
- Do not attach labels or stickers to discs.
- Do not use record cleaning sprays, benzene, thinner, static electricity prevention liquids or any other solvent.
- Clean any dust, water, or foreign matter from the terminals on the rear side of the card.
- Do not use the following discs:
  - Discs with exposed adhesive from removed stickers or labels (rented discs etc).
  - Discs that are badly warped or cracked.
  - Irregularly shaped discs, such as heart shapes.

## ■ To dispose or transfer this unit

The unit may keep the user settings information in the unit. If you discard this unit either by disposal or transfer, then follow the procedure to return all the settings to the factory presets to delete the user settings. (⇒ 34, "To return all settings to the factory preset.")

- The operation history may be recorded in the memory of this unit.

# Control reference guide

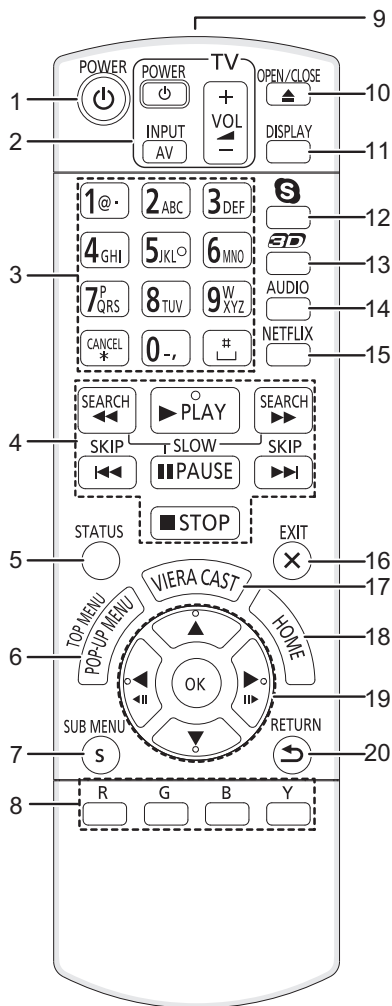



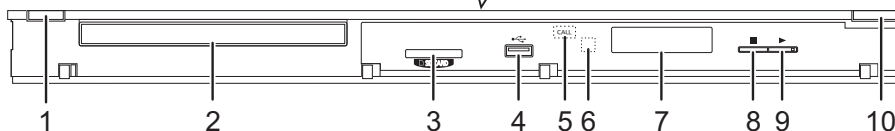
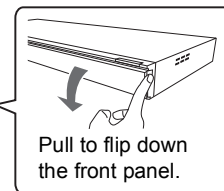
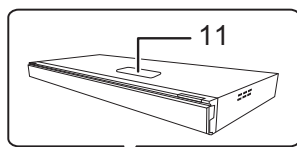



- 1 Turn the unit on and off
- 2 TV operation buttons  
You can operate the Panasonic TV through the unit's remote control. (Depending on the TV these buttons may not work.)  
[TV POWER] : Turn the television on and off  
[AV] : Switch the input select  
[+ - VOL] : Adjust the volume
- 3 Select title numbers, etc./Enter numbers or characters (⇒ 23)  
[CANCEL] : Cancel
- 4 Basic playback control buttons (⇒ 17)
- 5 Show status messages (⇒ 17)
- 6 Show Pop-up menu/Top menu/Direct Navigator (⇒ 17)
- 7 Show sub menu (⇒ 18)
- 8 These buttons are used when;
  - Operating a BD-Video disc that includes Java™ applications (BD-J).
  - Operating contents of VIERA CAST. (⇒ 23)
- 9 Transmit the remote control signal
- 10 Open or close the disc tray (⇒ 16)  
**CAUTION**  
Do not place objects in front of the unit. The disc tray may collide with objects when it is opened, and this may cause malfunction.
- 11 Show Playback menu (⇒ 27)
- 12 Start up a video communication (⇒ 23)
- 13 Setup 3D effects (⇒ 20)
- 14 Select audio (⇒ 17)
- 15 Show NETFLIX screen
- 16 Exit the menu screen
- 17 Displays the Home screen of the VIERA CAST (⇒ 23)
- 18 Show HOME menu (⇒ 16)
- 19 Selection/OK, Frame-by-frame (⇒ 17)
- 20 Return to previous screen



- 1 **POWER button (POWER ⏻/⏻)** (⇒ 12)  
Press to switch the unit from on to standby mode or vice versa. In standby mode, the unit is still consuming a small amount of power.
- 2 Disc tray (⇒ 16)
- 3 SD card slot (⇒ 16)
- 4 USB port (⇒ 16)
- 5 **CALL LED** (⇒ 23)  
The LED will light up when this unit receives incoming call etc. of the video communication.
- 6 Remote control signal sensor  
Distance: Within approx. 7 m (23 feet)  
Angle: Approx. 20° up and down, 30° left and right
- 7 Display
- 8 Stop (⇒ 17)
- 9 Start play (⇒ 17)
- 10 Open or close the disc tray (⇒ 16)
- 11 **BDT210** : Touch Free Sensor (⇒ 33)  
The LED will light up when TOUCH-FREE SENSOR is activated.

Rear panel terminals (⇒ 8–10, 12)

# Playable discs/Cards/USB devices

Type	Logo examples	Type detail	Playable contents (⇒ 39)
<b>BD</b>		<b>BD-Video</b>	Video
		<b>BD-RE</b>	Video JPEG/ MPO (3D still picture)
		<b>BD-R</b>	Video DivX® <small>BDT210 for Canada</small> MKV
<b>DVD</b>		<b>DVD-Video</b>	Video
		<b>DVD-R</b>	Video AVCHD DivX® <small>BDT210 for Canada</small> MKV
		<b>DVD-R DL</b>	MP3 JPEG/ MPO (3D still picture)
		<b>DVD-RW</b>	Video AVCHD
	—	<b>+R/+RW/+R DL</b>	
<b>CD</b>		<b>Music CD</b>	Music [CD-DA]
	—	<b>CD-R CD-RW</b>	DivX® <small>BDT210 for Canada</small> MKV Music [CD-DA] MP3 JPEG/ MPO (3D still picture)
<b>SD</b>		<b>SD Memory Card (from 8 MB to 2 GB) SDHC Memory Card (from 4 GB to 32 GB) SDXC Memory Card (48 GB, 64 GB)</b> (Compatible with both mini and micro types)	MPEG2 AVCHD JPEG/ MPO (3D still picture)
<b>USB</b>	—	<b>USB devices (up to 2 TB)</b>	DivX® <small>BDT210 for Canada</small> MKV MP3 JPEG/ MPO (3D still picture)

## ■ Discs that cannot be played in this unit

Any other disc that is not specifically supported or previously described.

- DVD-RAM
- Super Audio CD
- Photo CD
- DVD-Audio
- Video CD and Super Video CD
- WMA discs
- **BDT210 for U.S.A.** **BDT110** : All types of DivX discs
- **BDT210 for Canada** : DivX Plus HD discs
- PAL discs
- HD DVD
- BD-Video discs recorded at a rate of 50 fields/sec

## ■ Region management information

### BD-Video

This unit plays BD-Video marked with labels containing the region code "A".

Example:



### DVD-Video

This unit plays DVD-Video marked with labels containing the region number "1" or "ALL".

Example:



## ■ Finalize

DVD-R/RW/R DL, +R/+RW/+R DL and CD-R/RW recorded by a recorder, etc. needs to be finalized by the recorder to play on this unit. Please refer to the recorder's instructions.

## ■ BD-Video

- This unit supports high bit rate audio (Dolby Digital Plus, Dolby TrueHD, DTS-HD High Resolution Audio and DTS-HD Master Audio) adopted in BD-Video.
  - **BDT110** : If "Dolby D/Dolby D +/Dolby TrueHD" is set to "PCM", the maximum possible number of Dolby sound is 5.1ch PCM. (⇒ 30)

## ■ 3D

- 3D videos and 3D still pictures can be played back when this unit is connected to a 3D compatible TV using a High Speed HDMI Cable.
- 2D video can be enjoyed as 3D virtually. (⇒ 20)

## ■ Music CD

- Operation and sound quality of CDs that do not conform to CD-DA specifications (copy control CDs, etc.) cannot be guaranteed.
- The digital audio content side of a DualDisc does not meet the technical specifications of the Compact Disc Digital Audio (CD-DA) format so playback may not be possible.

## ■ SD card

- miniSD Cards, microSD Cards, microSDHC Cards and microSDXC Cards can be used, but must be used with an adaptor card. These are usually supplied with such cards, or otherwise customer provided.
- Keep the Memory Card out of reach of children to prevent swallowing.
- To protect the card's contents, move the record prevention tab (on the SD card) to "LOCK".
- This unit is compatible with SD Memory Cards that meet SD Card Specifications FAT12 and FAT16 formats, as well as SDHC Memory Cards in FAT32 format (Does not support long file name.) and SDXC Memory Cards in exFAT.
- If the SD card is used with incompatible computers or devices, recorded contents may be erased due to the card being formatted etc.
- Useable memory may be slightly less than the card capacity.



## ■ USB device

- This unit does not guarantee connection with all USB devices.
- This unit does not support USB device charging.
- When using Communication Camera TY-CC10W or Wireless LAN Adaptor DY-WL10, connect it to the rear terminal of this unit. (⇒ 10, 23)
- FAT12, FAT16 and FAT32 file systems are supported.
- This unit supports USB 2.0 High Speed.
- This unit supports an HDD formatted in FAT32. If the HDD is not recognized the power to the HDD may not be supplied. Supply power from an external source.



- It may not be possible to play the above media in some cases due to the type of media, the condition of the recording, the recording method and how the files were created.
- The producers of the disc can control how discs are played, so you may not always be able to control play as described in this Owner's Manual. Read the disc's instructions carefully.

# STEP 1 : Connecting to a TV

- Do not place the unit on amplifiers/receivers or equipment that may become hot. The heat can damage the unit.
- Before making any connections we suggest you temporarily disconnect all the units from AC power.
- Do not connect video signals through a video recorder. Due to copy guard protection the picture may not be displayed properly.

- Please use High Speed HDMI Cables that have the HDMI logo (as shown on the back cover). It is recommended that you use Panasonic's HDMI cable. When outputting 1080p signal, please use HDMI cables 5.0 meters (16.4 ft.) or less.

Recommended part number (High Speed HDMI Cable):  
 RP-CDHS15 (1.5 m/4.9 ft.), RP-CDHS30 (3.0 m/9.8 ft.),  
 RP-CDHS50 (5.0 m/16.4 ft.), etc.

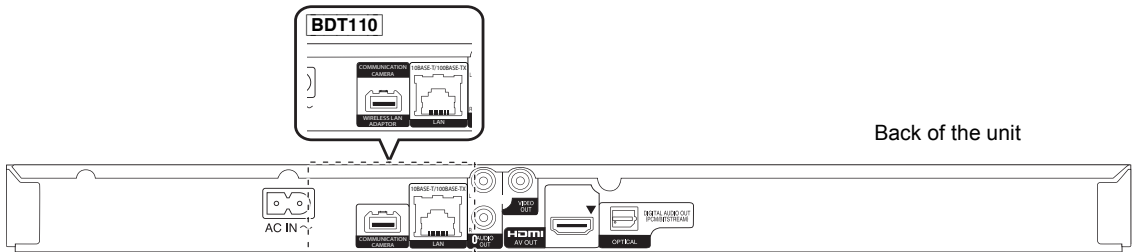

## ■ Via an HDMI AV OUT terminal (High quality)

- It is possible to play back 3D videos and 3D still pictures by connecting this unit with a 3D compatible TV.

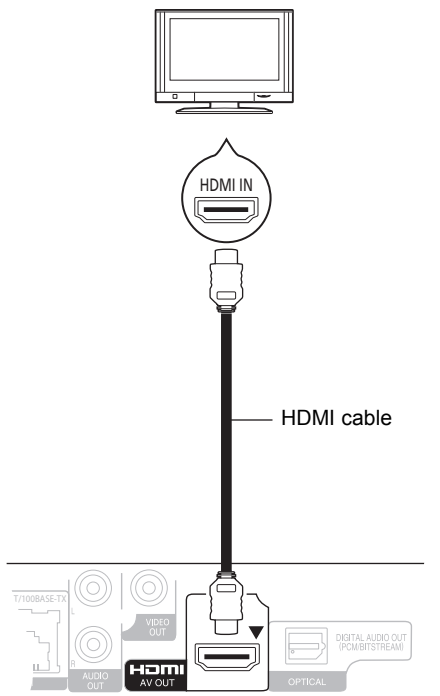

- Set "HDMI Audio Output" to "On" (⇒ 32).
- The HDMI connection supports VIERA Link "HDAVI Control" (⇒ 26).

## ■ Via a VIDEO OUT terminal (Standard quality)

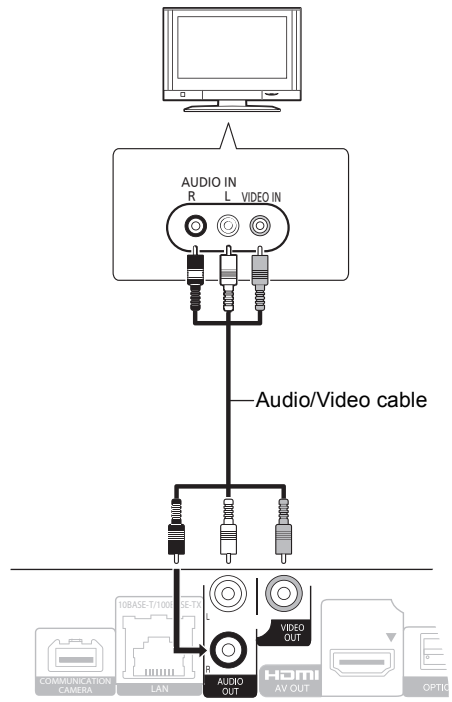

- Connect terminals of the same color.



# STEP 2 : Connecting to an amplifier/receiver

## ■ Via an HDMI AV OUT terminal

- It is possible to play back 3D videos and 3D still pictures when the connected TV and amplifier/receiver are 3D compatible.

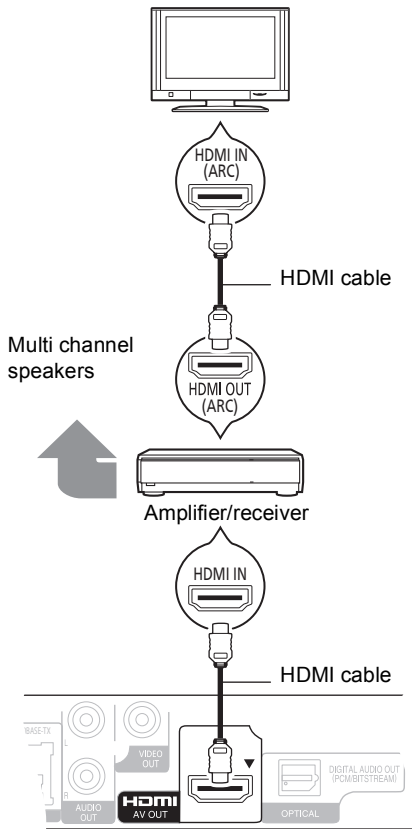

- Set "HDMI Audio Output" to "On" (⇒ 32).
- Set "Digital Audio Output" depending on the connected amplifier/receiver (⇒ 30).
- The HDMI connection supports VIERA Link "HDAVI Control" (⇒ 26).
- When connecting to a non-3D compatible amplifier/receiver, connect this unit to a TV via HDMI AV OUT, then connect the TV and the amplifier/receiver, using HDMI cables for the respective connections.
  - Please note, however, that the audio can only be up to 5.1ch.
- When using the TV or amplifier/receiver that does not have the indication of "(ARC)" (non-ARC-compatible) on the HDMI terminal, in order to enjoy TV's sound by amplifier it is also required to connect the amplifier/receiver and TV using an optical digital cable.

## ■ Via an OPTICAL terminal

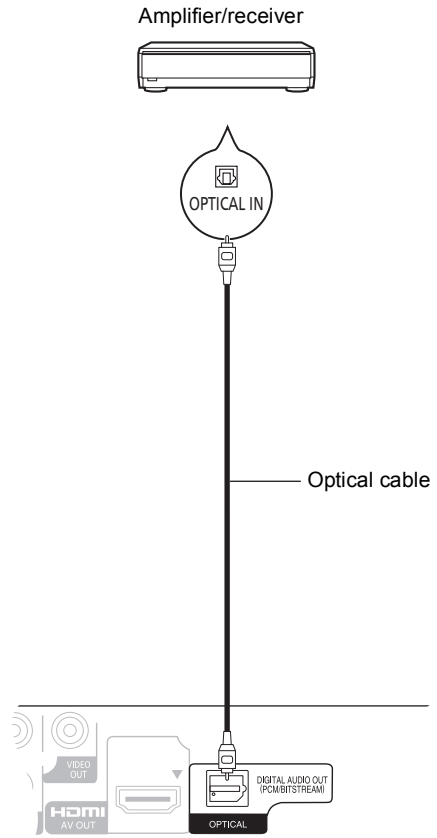

- When connecting a TV (⇒ 8) with HDMI AV OUT terminal, set "HDMI Audio Output" to "Off" (⇒ 32).
- Set "Digital Audio Output" depending on the used terminal and connected amplifier/receiver (⇒ 30).

# STEP 3 : Connecting to a broadband network

The following services can be used when this unit is connected to broadband.

- Firmware can be updated (⇒ 15)
- You can enjoy BD-Live (⇒ 19)
- You can enjoy VIERA CAST (⇒ 23)
- You can access other devices (Home Network) (⇒ 24)

## ■ LAN cable connection

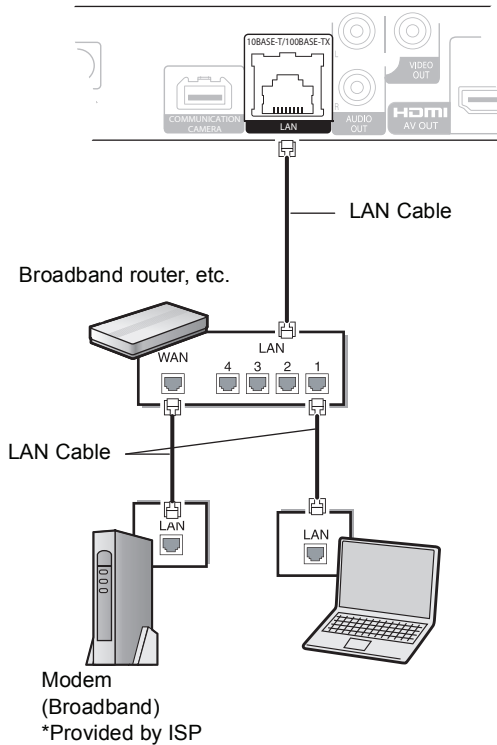

- Use category 5 or above straight LAN cables (STP) when connecting to peripheral devices.
- Inserting any cable other than a LAN cable in the LAN terminal can damage the unit.

For details about connection method, refer to the instructions supplied with the connected equipment.

## ■ Wireless LAN connection

- **BDT210** : Wireless LAN is built in. (There is no need to connect a Wireless LAN Adaptor.)
- **BDT110** : Connect the Wireless LAN Adaptor DY-WL10 (optional).

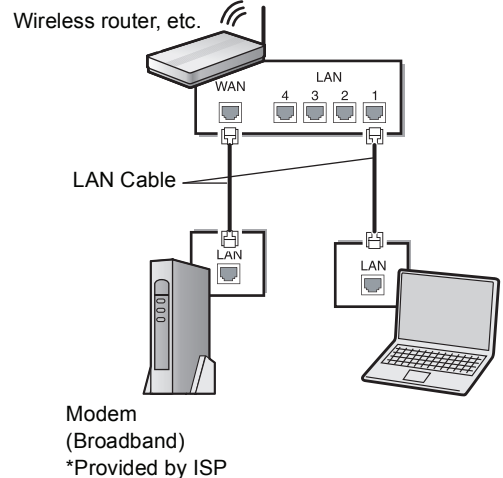
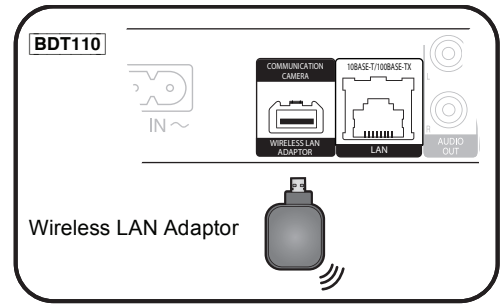

- **BDT110** : Only the Wireless LAN Adaptor DY-WL10 (optional) can be used.
- **BDT110** : Read the operating instructions for the Wireless LAN Adaptor DY-WL10 (optional) thoroughly when using it.
- For up to date compatibility information on your Wireless router refer to <http://panasonic.jp/support/global/cs/> (This site is in English only.)  
For additional information about this unit refer to <http://www.panasonic.com/consumer/support> (For U.S.A.)
- The unit is not compatible with public wireless LAN services provided in airports, stations, cafes etc.
- **BDT110** : To simultaneously connect the Wireless LAN Adaptor DY-WL10 (optional) and a LAN cable, use the extension cable supplied with the DY-WL10.

## Precautions of Wireless LAN connection

The following limits are in place regarding the usage of this unit or Wireless LAN adaptor. You must be aware of these limits before using these devices.

Panasonic will in no way be responsible for any incidental damage which may arise due to a failure to obey these limits, or to any condition of use or disuse of these devices.

- **Data transmitted and received over radio waves may be intercepted and monitored.**
- **This unit or Wireless LAN adaptor contain delicate electronic components.**

Please use these devices in the manner in which it was intended and follow the following points:

- Do not expose these devices to high temperatures or direct sunlight.
- Do not bend, or subject these devices to strong impacts.
- Keep these devices away from moisture.
- Do not disassemble or alter the device in any way.

### BDT210

#### THE FOLLOWING APPLIES IN THE U.S.A. AND CANADA

This device complies with Part 15 of FCC Rules and RSS-Gen of IC Rules.

Operation is subject to the following two conditions:

- (1) This device may not cause interference, and (2) this device must accept any interference, including interference that may cause undesired operation of this device.

Contains FCC ID: VPY-LBSJ

Contains IC:772C-LBSJ

This transmitter must not be co-located or operated in conjunction with any other antenna or transmitter.

This product is restricted to indoor use due to its operation in the 5.15 to 5.25 GHz frequency range.

FCC and IC require this product to be used indoors for the frequency range 5.15 to 5.25 GHz to reduce the potential for harmful interference to co-channel Mobile Satellite systems. High power radars are allocated as primary users of the 5.25 to 5.35 GHz and 5.65 to 5.85 GHz bands. These radar stations can cause interference with and/or damage this product.

This equipment complies with FCC/IC radiation exposure limits set forth for an uncontrolled environment and meets the FCC radio frequency (RF) Exposure Guidelines in Supplement C to OET65 and RSS-102 of the IC radio frequency (RF) Exposure rules. This equipment has very low levels of RF energy that it deemed to comply without maximum permissive exposure evaluation (MPE). But it is desirable that it should be installed and operated keeping the radiator at least 20cm or more away from person's body (excluding extremities: hands, wrists, feet and ankles).

#### THE FOLLOWING APPLIES ONLY IN THE U.S.A.

##### FCC Note:

This equipment has been tested and found to comply with the limits for a Class B digital device, pursuant to Part 15 of the FCC Rules. These limits are designed to provide reasonable protection against harmful interference in a residential installation. This equipment generates, uses and can radiate radio frequency energy and, if not installed and used in accordance with the instructions, may cause harmful interference to radio communications.

However, there is no guarantee that interference will not occur in a particular installation. If this equipment does cause harmful interference to radio or television reception, which can be determined by turning the equipment off and on, the user is encouraged to try to correct the interference by one or more of the following measures:

- Reorient or relocate the receiving antenna.
- Increase the separation between the equipment and receiver.
- Connect the equipment into an outlet on a circuit different from that to which the receiver is connected.
- Consult the dealer or an experienced radio/TV technician for help.

FCC caution: To maintain compliance with FCC regulations, shielded interface cables must be used with this equipment. Operation with non-approved equipment or unshielded cables may result in interference to radio and TV reception. Any changes or modifications not approved by the party responsible for compliance could void the user's authority to operate this equipment.

This device complies with Part 15 of the FCC Rules. Operation is subject to the following two conditions:

- (1) This device may not cause harmful interference, and
- (2) this device must accept any interference received, including interference that may cause undesired operation.

Responsible Party:

Panasonic Corporation of North America  
One Panasonic Way  
Secaucus, NJ 07094

Support Contact:

Panasonic Consumer Electronics Company  
Telephone No.: 1-800-211-PANA (7262)

#### THE FOLLOWING APPLIES ONLY IN CANADA.

This Class B digital apparatus complies with Canadian ICES-003.

## STEP 4 : Connecting to an AC power source

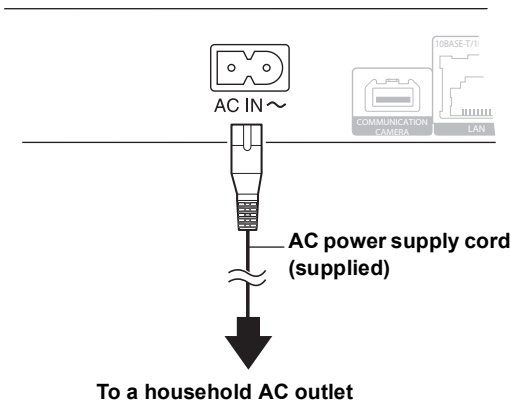

- This unit consumes a small amount of AC power (“Quick Start”: “Off”, approx. 0.1 W) even when turned off. In the interest of power conservation, if you will not be using this unit for an extended period of time, it can be disconnected.

Install this unit so that the power cord can be unplugged from the socket outlet immediately if any problem occurs.

## STEP 5 : Settings

### Easy Setting

After connecting your new player for the 1st time and pressing the power button, a screen for the basic settings will appear.

#### Preparation

Turn on the television and select the appropriate video input on the television.

#### 1 Press [POWER].

Setup screen appears.

If this unit is connected to a Panasonic TV (VIERA) supporting HDAVI Control 2 or later via an HDMI cable, then setting information on the TV such as “On-screen Language” is acquired by this unit.

#### 2 Follow the on-screen instructions and make the settings with [▲, ▼] and press [OK].

After completing “Easy Setting”, you can perform “Network Easy Setting”.



- You can perform this setup anytime by selecting “Easy Setting” in the Setup menu. (⇒ 33)

#### Touch Free Sensor **BDT210**

By setting “Sensor” in “Touch Free Sensor” to “On”, you can open or close the tray just by waving your hand over the TOUCH-FREE SENSOR on the upper side of the unit. (This will also work when in stand-by.)

- Be aware that the TOUCH-FREE SENSOR may function unintentionally in the following cases:
  - When your hand or arm, an object, a small child, or a small animal comes close to the upper part of the unit
  - When an object is placed on top of the unit and vibration is applied
  - When connecting a cable etc. to the rear of the unit
- Reactive distance of the sensor is automatically set in accordance with the installation conditions at the time of power supply connection and when the open/close button is pressed. To prevent an incorrect setting, do not place your hands or objects above the unit at these times.
- Depending on the usage conditions, the TOUCH-FREE SENSOR may stop working or the reactive distance may become shorter. In such cases, press the tray open/close button once.

# Network Easy Setting

The configuration of your network is about to begin. If you failed to make the settings, refer to page 14.

## Wired connection

Select "Wired" and press [OK].

**BDT210**

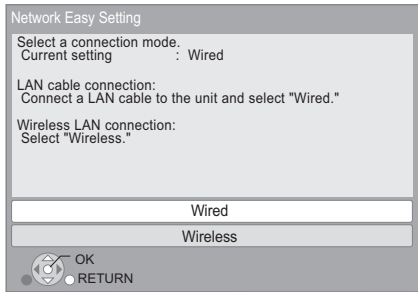

Follow the on-screen instructions to make your connection settings.

## Wireless connection

### Preparation

- Obtain your network name (⇒ 15, SSID).
- If your wireless connection is encrypted please be sure that you know your encryption key.
- **BDT110** : If "Wireless LAN Adaptor is not connected." is displayed, check that the Wireless LAN Adaptor is fully inserted. Alternatively, disconnect and reconnect it. If there is still no change in the display, consult your dealer for advice.

- 1 Select "Wireless" and press [OK].
- 2 Select "Search for wireless network" or "WPS (PUSH button method)" and press [OK] then follow the on-screen instructions and make the settings.

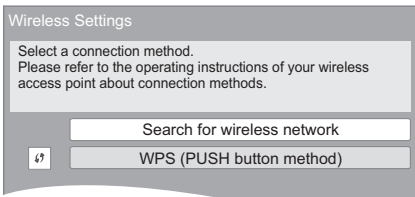

### "WPS (PUSH button method)"

If you are using a Wireless router that supports WPS (Wi-Fi Protected Setup), you can easily perform the settings.

### "Search for wireless network"

The available wireless networks will be displayed.

- ① Select your network name and press [OK].
  - If your network name is not displayed search again by pressing the [R] button on the remote control. Stealth SSID will not be displayed, in this case enter manually.

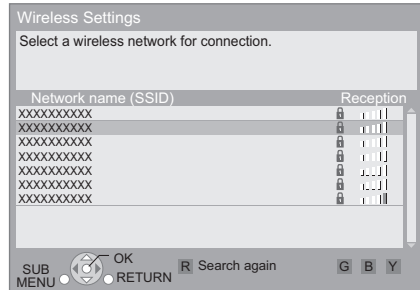

### When your wireless network is encrypted

- ② Press [OK] to select "Encryption Key".

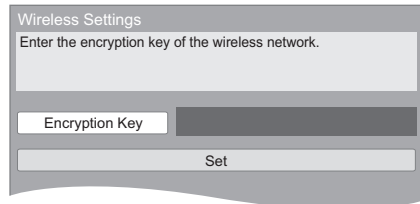

- ③ Enter your encryption key.

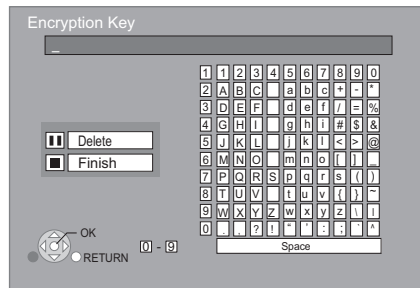

### To enter SSID manually

If your SSID is not displayed in step ①, follow these steps.

- 1 To display SSID input screen :  
Press [HOME] ⇒ select "Setup" ⇒ select "Player Settings" ⇒ select "Network" ⇒ [OK] ⇒ select "Network Settings" ⇒ [OK] ⇒ select "Wireless Settings" ⇒ [OK] ⇒ select "Connection Setting" ⇒ [OK] ⇒ select "Manual setting" ⇒ [OK]
- 2 Press [OK] to select "SSID" and enter your SSID.

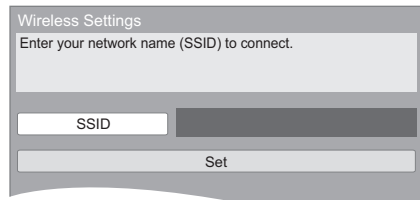

- If your wireless network is encrypted, go to step ②.





- Refer to the operating instructions of the hub or router.
- WPS (Wi-Fi Protected Setup) is a standard that facilitates settings relating to the connection and security of wireless LAN devices. To see whether your Wireless router supports WPS, check the Wireless router operating instructions.
- You can perform this setup anytime by selecting "Network Easy Setting" in the Setup menu. (⇒ 32)
- You can redo these settings individually using "Network Settings". (⇒ 32)
- Do not use this unit or Wireless LAN adaptor to connect to any wireless network for which you do not have usage rights. During automatic searches in a wireless network environment, wireless networks (SSID\*) for which you do not have usage rights may be displayed; however, using these networks may be regarded as illegal access.
- After performing network settings on this unit, the settings (encryption level, etc.) of the Wireless router might change. When you have trouble getting online on your PC, perform the network settings on your PC in accordance with the settings of Wireless router.
- Please be aware that connecting to a network without encryption may result in the content of the communication being illegitimately viewed by a third party, or the leaking of data such as personal or secret information.

\* An SSID (Service Set Identification) is a name used by wireless LAN to identify a particular network. Transmission is possible if the SSID matches for both devices.

## Reprogramming the remote control

If you have more than one Panasonic player/recorder and the remote control operates both products at once, you will need to change the remote control code on one product to prevent this occurrence. (⇒ 33, "Remote Control Code")

## Firmware updates

Occasionally, Panasonic may release updated firmware for this unit that may add or improve the way a feature operates. These updates are available free of charge.

This unit is capable of checking the firmware automatically when connected to the Internet via a broadband connection. When a new firmware version is available, the following message is displayed.

New firmware is available.  
Please update firmware in Setup.

To update the firmware

Press [HOME] ⇒ select "Setup" ⇒ select "Player Settings" ⇒ select "Others" ⇒ [OK] ⇒ select "Firmware Update" ⇒ [OK] ⇒ select "Update Now"

DO NOT DISCONNECT the unit from the AC power or perform any operation while the update takes place. After the firmware is installed, "FINISH" will be displayed on the unit's display. Unit will restart and the following screen will be displayed.

The firmware was updated.  
Current Version: x.xx



- If downloading on this unit fails or this unit is not connected to the Internet, then you can download the latest firmware from the following website and burn it to a CD-R to update the firmware. <http://panasonic.jp/support/global/cs/> (This site is in English only.) To show the firmware version on this unit. (⇒ 33, "System Information")
- Downloading will require several minutes. It may take longer or may not work properly depending on the connection environment.
- If you do not want to check for the latest firmware version, set "Automatic Update Check" to "Off". (⇒ 33)

# Inserting or removing media

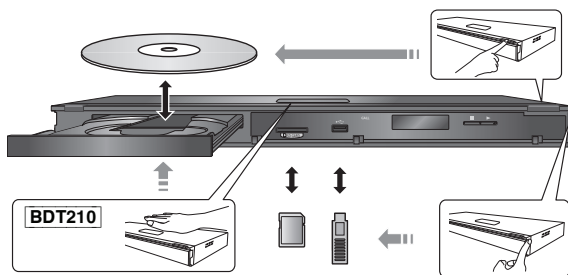

- When inserting a media item, ensure that it is facing the right way up.
- When removing the SD card, press on the center of the card and pull it straight out.
- If you connect a Panasonic product with a USB connection cable, the setup screen may be displayed on the connected equipment. For details, refer to the instructions for the connected equipment.

# HOME menu

Major functions of this unit can be operated from the HOME menu.

## Preparation

Turn on the television and select the appropriate video input on the television.

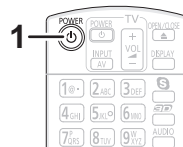

- 1 Press [POWER] to turn on the unit.
- 2 Press [OK] or [▲, ▼, ◀, ▶] to select the item.

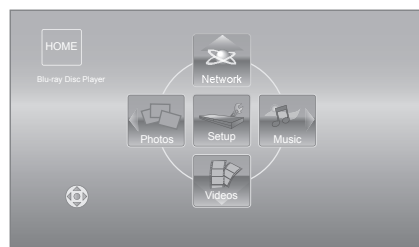

- When a media is inserted, contents selection screen for that media is displayed.
- If there are any other items, repeat this step.
- To return to HOME menu, select "HOME" or press [RETURN] several times.

<b>Videos/ Photos/ Music</b>	<b>Disc</b>	Play back the contents. (⇒ 17, 21, 22)
	<b>SD card</b>	• When multiple contents are recorded, select the types of contents or the title.
	<b>USB</b>	
<b>Network</b>	<b>Internet Content</b>	Displays the Home screen of VIERA CAST. (⇒ 23)
	<b>Home Network</b>	<b>DLNA Client</b> (⇒ 24) <b>Media Renderer</b> (⇒ 25)
<b>Setup</b>	<b>Player Settings</b>	(⇒ 29)
	<b>SD Card Management</b>	(⇒ 19)
	<b>Wallpaper</b>	Changes the screen background of HOME menu.

## To show the HOME menu

Press [HOME].



- Items to be displayed may vary with the media.



# Playing video contents

BD DVD CD SD USB

## 1 Insert the media.

If the menu is displayed, press [▲], [▼], [◀], [▶] to select the item. (⇒ 16)

## 2 Press [▲], [▼] to select the title and press [OK].

When a message screen is displayed while playing back 3D compatible video software, play back in accordance with the instructions.

### ■ To show menus

You can show Top Menu, Direct Navigator or Pop-up Menu. Press [POP-UP MENU/TOP MENU].

- Press [▲], [▼], [◀], [▶] to select the item and press [OK].

### ■ To show the status messages

While playing, press [STATUS].

The status messages give you information about what is currently being played. Each time you press [STATUS], the display information may change or will disappear from the screen.

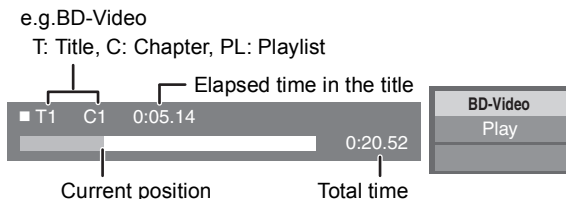

- DISCS CONTINUE TO ROTATE WHILE MENUS ARE DISPLAYED. Press [■STOP] when you have finished playback to protect the unit's motor, your television screen and so on.
- Depending on media and contents, the display may change or may not appear.
- DivX [BDT210 for Canada] and MKV: Successive play is not possible.
- It is not possible to playback AVCHD and MPEG2 video which have been dragged and dropped, copied and pasted to the media.
- To save on electricity, the power is turned off automatically if there is no button operation for about 30 minutes when not playing back (such as when paused, displaying the menu, displaying still pictures, etc.). (Compatible with ENERGY STAR)

## Other operations during play

These functions may not work depending on the media and contents.

### Stop

Press [■STOP].

The stopped position is memorized.

**Resume play function**

Press [▶PLAY] to restart from this position.

- The position is cleared if the tray is opened or you press [■STOP] several times to display "STOP" on the unit's display.
- On BD-Video discs including BD-J, the resume play function does not work.

### Pause

Press [||PAUSE].

- Press [||PAUSE] again or [▶PLAY] to restart play.

### Search/Slow-motion

**Search**

While playing, press [SEARCH◀◀] or [SEARCH▶▶].

- Music and MP3: The speed is fixed to a single step.

**Slow-motion**

While paused, press [SEARCH◀◀] or [SEARCH▶▶].

- BD-Video and AVCHD: Forward direction [SEARCH▶▶] only.

The speed increases up to 5 steps.

- Press [▶PLAY] to revert to normal playback speed.

### Skip

While playing or paused, press [◀◀] or [▶▶].

Skip to the title, chapter or track you want to play.

- Each press increases the number of skips.

### Frame-by-frame

While paused, press [◀] (◀||) or [▶] (||▶).

- Press and hold to change in succession forward or backward.
- Press [▶PLAY] to revert to normal playback speed.
- BD-Video and AVCHD: Forward direction [▶] (||▶) only.

### Changing audio

Press [AUDIO].

You can change the audio channel number or soundtrack language, etc.

## Useful functions

**1** Press [SUB MENU].

**2** Select an item, then press [OK].

While Direct Navigator screen is displayed

<b>Properties</b>	To display the titles properties (recording date, etc.).
<b>View Chapters</b>	To select the chapter.
<b>View Playlists</b>	To play playlists.
<b>View Titles</b>	To select the title.
<b>Select Folder</b>	To switch to another folder.

While playing

<b>Screen Aspect</b>	When black bars are shown at the top, bottom, left, and right sides of the screen, you can enlarge the image to fill the screen.
<b>Top Menu</b>	To display Top Menu.
<b>Pop-up Menu</b>	To display Pop-up Menu.
<b>Menu</b>	To display Menu.
<b>3D Settings</b>	2D video can be virtually output as 3D, or output effect of the 3D video can be setup. (⇒ 20)

- Depending on the played contents if you perform “Screen Aspect”, there may be no effect.
- When “TV Aspect” (⇒ 31) is set to “4:3 Pan & Scan” or “4:3 Letterbox”, the “Zoom” effect in “Screen Aspect” is disabled.



- Depending on the media and contents, displayed items are different.

## ■ Displaying subtitle text

You can display subtitle text on the DivX **BDT210 for Canada** and MKV video disc with this unit. The operation might be different or it may not operate properly depending on the way the file was made or the state of this unit (playing, stopped, etc.).

**Set “Subtitle” in “Disc” (⇒ 27)**



- DivX and MKV video files that do not display “Text” do not contain subtitle text.
- If the subtitle text is not displayed correctly, try changing the language settings. (⇒ 29)
- This function has no relation to the subtitles specified in DivX standard specifications and has no clear standard.

## Regarding DivX **BDT210 for Canada**

### ABOUT DIVX VIDEO:

DivX® is a digital video format created by DivX, Inc. This is an official DivX Certified® device that plays DivX video. Visit [divx.com](http://divx.com) for more information and software tools to convert your files into DivX video.

### ABOUT DIVX VIDEO-ON-DEMAND:

This DivX Certified® device must be registered in order to play purchased DivX Video-on-Demand (VOD) movies. To obtain your registration code, locate the DivX VOD section in your device setup menu. Go to [vod.divx.com](http://vod.divx.com) for more information on how to complete your registration.

- Video images of the copyright-protected DivX contents stored on USB device can be output only through the HDMI output terminal.

### Display the unit’s registration code.

(⇒ 33, “DivX Registration” in “Others”)

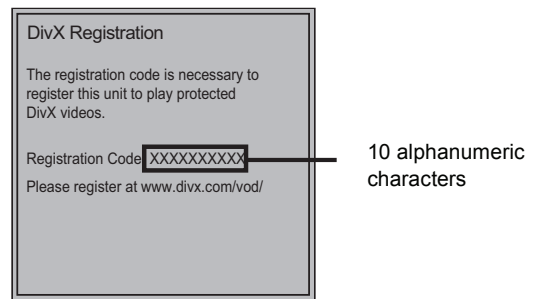

- After playing DivX VOD content for the first time, the registration code is not displayed.
- If you purchase DivX VOD content using a registration code different from this unit’s code, you will not be able to play this content.

### Cancel the unit’s registration.

(⇒ 33, “DivX Registration” in “Others”)

Press [◀, ▶] to select “Yes” in “DivX Registration”.

Use the deregistration code to cancel the registration in [www.divx.com](http://www.divx.com).

### Regarding DivX VOD content that can only be played a set number of times

Some DivX VOD contents can only be played a set number of times. When you play this content, the number of times already played and initially playable number of times is displayed.

- The remaining number of plays decreases each time a program is played. However, when playing from the point where play was previously stopped, the remaining number of plays does not decrease due to the resume play function.

# Enjoying BD-Live or picture-in-picture in BD-Video

## Enjoying BD-Live discs with Internet

BD-Live allows you to enjoy more functions such as subtitles, exclusive images and online games by connecting this unit to the Internet. Since most of the BD-Live compatible discs are played back using the BD-Live function, additional contents are required to be downloaded into the external memory (local storage).

- This unit is using an SD card as a local storage device.  
BD-Live function cannot be used when there is no SD card inserted.

- 1 Perform network connection and settings. (⇒ 10, 13)**
- 2 Insert an SD card with 1 GB or more free space.**
- 3 Insert the disc.**

### ■ Deleting data/Formatting SD cards

If you no longer need data recorded on the SD card, you can delete data with the following operation.

- ① Insert an SD card.
- ② Press [HOME].
- ③ Press [OK] to select "Setup".
- ④ Press [▶] to select "SD Card Management".
- ⑤ Press [▲, ▼] to select "BD-Video Data Erase" or "Format SD Card" and press [OK].

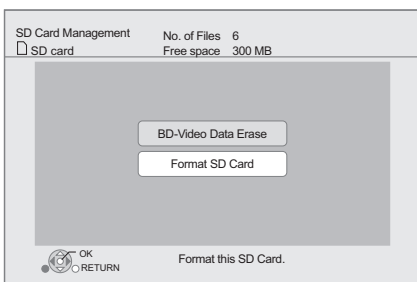

- ⑥ Press [◀, ▶] to select "Yes" and press [OK].
- ⑦ Press [◀, ▶] to select "Start" and press [OK].

## Playing picture-in-picture

To turn on/off secondary video and audio  
[DISPLAY] ⇒ select "Disc" ⇒ [▶] ⇒ select "Signal Type" ⇒ [OK] ⇒ set "Video" and "Soundtrack" in "Secondary Video" to "On" or "Off"

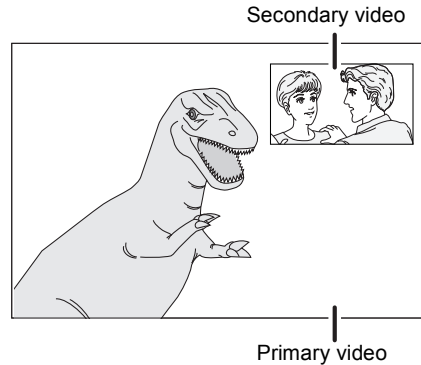

- The usable functions and the operating method may vary with each disc, please refer to the instructions on the disc and/or visit their website.
- Some BD-Live content available on the Blu-ray discs may require an Internet account to be created in order to access the BD-Live content. Follow the screen display or instruction manual of the disc for information on acquiring an account.
- To use BD-Live function, it is recommended that you format the card on this unit. If the SD card you use is formatted, all data on the card will be erased. It cannot be recovered.
- "BD-Live Internet Access" may need to be changed for certain discs (⇒ 29).
- When discs supporting BD-Live are played back, the player or disc IDs may be sent to the content provider via the Internet.
- During search/slow-motion or frame-by-frame, only the primary video is displayed.
- When "BD-Video Secondary Audio" in "Digital Audio Output" is set to "Off", secondary audio will not be played (⇒ 30).

# Enjoying 3D video

You can enjoy powerful 3D videos with realistic sensations by connecting this unit with a High Speed HDMI Cable to a 3D compatible TV.

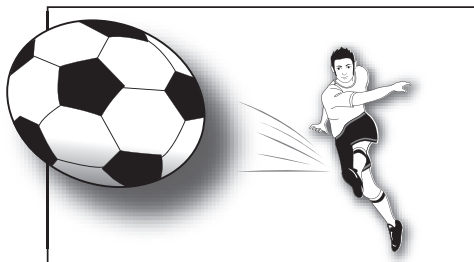

The image is an illustration.

## Preparation

Connect 3D compatible TV to an HDMI AV OUT terminal of this unit using a High Speed HDMI Cable. (⇒ 8, 9)

- Perform the necessary preparations for the TV.

Method of playback is the same as normal disc playback.

(⇒ 17)

- Playback following the instructions displayed on the screen.

## 3D settings

Perform the following settings as necessary.

<b>3D BD-Video Playback</b>	It is also possible to play back 3D discs in 2D (conventional video). (⇒ 29)
<b>3D Type</b>	If 3D video cannot be played back in 3D, change the settings as required by the connected TV format. (⇒ 31) <ul style="list-style-type: none"> <li>• Change the settings for 3D on the TV also when "Checker board" or "Side by side" is selected.</li> </ul>
<b>3D Playback Precautions</b>	Hide the 3D viewing warning screen. (⇒ 31)
<b>Pop-Out Level</b>	Adjust the pop-up position for the Playback menu or message screen etc. (⇒ 28)

## Useful functions

**1** While playing

Press [**ED**].

**2** Select an item, then press [**OK**].

<b>Signal Format</b>	<b>Original</b>	Keep original picture format.
	<b>Side by side</b>	3D picture format comprising of left and right screens.
	<b>2D to 3D</b>	Converts 2D pictures to 3D effect.
<b>3D Picture Mode</b>	<b>Normal</b>	Playback pictures with normal 3D effects.
	<b>Soft</b>	You can enjoy 3D pictures with a feeling of broadness, holding back the depth perception.
	<b>Manual Settings</b>	Set 3D effect manually. <p><b>Distance</b> Set the amount of depth perception.</p> <p><b>Screen Type</b> Selects how the screen appears during 3D playback (flat or round).</p> <p><b>Frame Width</b> Set the amount of feathering at the edge of screen.</p> <p><b>Frame Color</b> Set the color of feathering at the edge of screen.</p>

It appears also by pressing [SUB MENU] and selecting "3D Settings".



- Depending on the contents, displayed items are different.
- Please refrain from viewing 3D images if you do not feel well or are experiencing visual fatigue.  
In the event that you experience dizziness, nausea, or other discomfort while viewing 3D images, discontinue use and rest your eyes.
- Depending on the connected TV, the video being played back might switch to 2D video due to changes in resolution etc. Check the 3D setting on the TV.
- 3D images may not output as settings of "HDMI Resolution" and "24p Output". (⇒ 31)

# Playing still pictures

**BD DVD CD SD USB**

(BD-RE, DVD-R/-R DL, CD-R/RW, SD Card, USB device)

In order to play back 3D still pictures (MPO), this unit should be connected to a Full HD 3D compatible TV via an HDMI terminal.

## 1 Insert the media.

If the menu is displayed, press [**▲**, **▼**, **◀**, **▶**] to select the item. (⇒ 16)

## 2 Press [**▲**, **▼**] to select the folder and press [**OK**].

“3D View” : 3D still pictures (MPO) are sorted here. To play back in 3D, select from “3D View”. (Still pictures in “2D View” are played back in 2D)

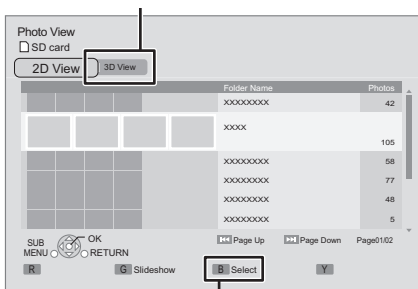

To select folders or still pictures that are played on slideshow.

## 3 Press [**▲**, **▼**, **◀**, **▶**] to select the still picture and press [**OK**].

Press [**◀**, **▶**] to display the previous or next still picture.

### To exit the screen

Press [**POP-UP MENU/TOP MENU**].

## ■ To show the still picture properties

While playing, press [**STATUS**] once or twice.

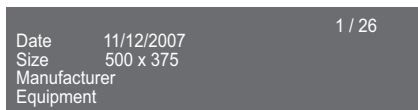

### To exit the screen

Press [**STATUS**].

## Useful functions

### 1 Press [**SUB MENU**].

### 2 Select an item, then press [**OK**].

While Photo View screen is displayed

Slideshow	Start Slideshow
	You can display still pictures one by one at a constant interval.
	<b>Display Interval</b> Change the display interval.
	<b>Transition Effect</b> Set display method.
	<b>Repeat Play</b> Repeat slideshow.
	<b>Random Soundtrack</b> Background music is played in random order.
	<b>Soundtrack</b> An MP3 on the USB device can be played back during the slideshow of JPEG on the USB device or the SD card. (A music CD also can be played back during the slideshow of JPEG on the SD card.)

While playing

<b>Start Slideshow</b>	Start the slideshow.
<b>Screen Aspect</b>	Switch the screen mode.
<b>Status</b>	Show the still picture properties.
<b>Rotate Right</b>	Rotate the still picture.
<b>Rotate Left</b>	
<b>Wallpaper</b>	Set the still picture to the wallpaper of HOME screen. (⇒ 16)
<b>Pop-Out Level</b>	Pop-up position for the Playback menu or message screen etc. can be adjusted during 3D playback.



- Depending on the condition of the unit and media contents, displayed items are different.
- When a still picture with large number of pixels is played, the display interval may become longer. Even if the setting is changed, the display interval may not become shorter.
- When both the music CD and the USB device with recorded MP3 is inserted into this unit, the music CD has priority to be played back as background music.
- Still pictures displayed as “” cannot be played back with this unit.

# Playing music

**DVD CD USB**

(DVD-R/-R DL, music CD, CD-R/RW, USB device)

## 1 Insert the media.

If the menu is displayed, press [**▲**, **▼**, **◀**, **▶**] to select the item. (⇒ 16)

## 2 Press [**▲**, **▼**] to select the track and press [**OK**].

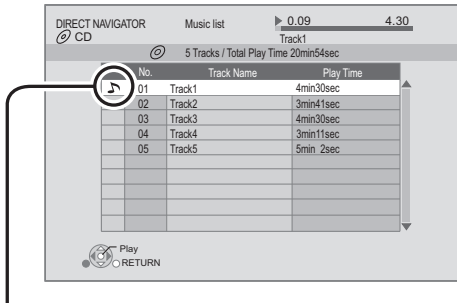

“” indicates the track currently playing.

## Playing a track in another folder

### 1 While the Direct Navigator screen is displayed Press [**SUB MENU**].

### 2 Press [**▲**, **▼**] to select “Select Folder” and press [**OK**].



- You cannot select folders that contain no compatible tracks.

# Enjoying VIERA CAST™

You can access a selection of Internet services from the Home screen with VIERA CAST, for example YouTube, Picasa Web Albums. (Current as of December 2010)

## Preparation

- Network connection (⇒ 10)
- Network setting (⇒ 13)

### To enjoy video communication (ex. Skype™) :

- Connect this unit with optional Communication Camera (TY-CC10W or compatible equipment). Depending on the area, this optional camera may not be available. Please consult your local Panasonic dealer for advice.

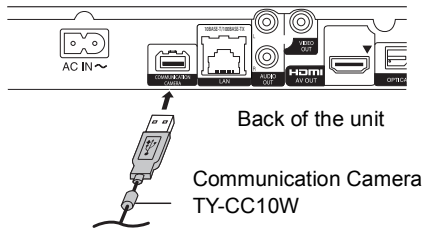

- **BDT110** : When this unit is connected by wireless LAN connection, connect the Communication Camera via the USB port on the front of this unit.
- For operating method refer to the following website.  
<http://panasonic.jp/support/global/cs/>  
(This site is in English only.)

## 1 Press [VIERA CAST].

- The video communication service can be accessed directly by pressing [S] button, and NETFLIX can be accessed directly by [NETFLIX] button.
- Message is displayed. Please read these instructions carefully and then press [OK].

## 2 Press [▲, ▼, ◀, ▶] to select the item and press [OK].

- Operable buttons:  
[▲, ▼, ◀, ▶], [OK], [RETURN], colored buttons, number buttons

### VIERA CAST Home screen;



Images are for illustration purposes, contents may change without notice.

### To exit from VIERA CAST

Press [EXIT], [HOME] or [POP-UP MENU/TOP MENU].



- When playing content from a disc/SD card and/or USB device VIERA CAST cannot be accessed by pressing [VIERA CAST].
- In the following cases, settings are possible using "Internet Content Settings" (⇒ 32)
  - When restricting the use of VIERA CAST.
  - When the audio is distorted.
  - When wrong time is displayed
- If using slow Internet connection, the video may not be displayed correctly. A high-speed Internet service with a speed of at least 6 Mbps is recommended.
- Be sure to update the firmware when a firmware update notice is displayed on the screen. If the firmware is not updated, you will not be able to use the VIERA CAST function. (⇒ 15)
- VIERA CAST™ home screen is subject to change without notice.
- The services through VIERA CAST™ are operated by their respective service providers, and service may be discontinued either temporarily or permanently without notice. Therefore, Panasonic will make no warranty for the content or the continuity of the services.
- All features of websites or content of the service may not be available.
- Some content may be inappropriate for some viewers.
- Some content may only be available for specific countries and may be presented in specific languages.

# Playing contents saved on other equipment

You can enjoy viewing a content saved on other equipment (Windows 7 operating system, smartphone, etc.) connected to the home network with this unit.

## Preparation

- ① Perform network connection and network settings of this unit. (⇒ 10, 13)
- ② Perform Home Network settings of the connected equipment.

For details about the setting and operation method of connected equipment, and compatible equipment, refer to the following Website and the operating instructions for each item of equipment.

<http://panasonic.jp/support/global/cs/>  
(This site is in English only.)

## Playing back contents on the DLNA server (DLNA)

It is possible to play back the video, still pictures, and music in the shared folder of the Windows 7 operating system.

## Preparation

Perform steps ① and ②.

- ③ Add the contents and folder to the Windows Media® Player library.
  - Playlist of Windows Media® Player can play back only the contents that are stored in the libraries.

**1 Press [HOME].**

**2 Press [▲] to select “Network”.**

**3 Press [▲] to select “Home Network”.**

**4 Press [▲] to select “DLNA Client”.**

- A list of equipment connected via the network is displayed.
- This list can be updated by pressing [R] on the remote control.

e.g.

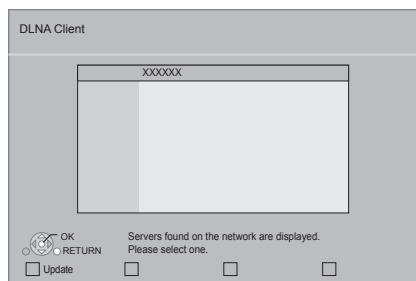

**5 Press [▲, ▼] to select the equipment to playback the contents, and press [OK].**

**6 Press [▲, ▼, ◀, ▶] to select the item to playback (folder), and press [OK].**

- You may be able to use convenient functions depending on the disc or content by pressing [SUB MENU] or [DISPLAY].
- Control Panel is displayed once the playback starts. Operation can be performed with [▲, ▼, ◀, ▶], [OK] and [EXIT].
- Press [OK] if the Control Panel is not displayed.
- Press [RETURN] to hide the Control Panel.

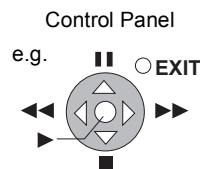

## To exit from Home Network

Press [EXIT], [HOME] or [POP-UP MENU/TOP MENU].



## Play back the contents in the DLNA server using DMC

It is possible to play back the video or still pictures in the shared folder of the DLNA server by controlling with DLNA DMC (Digital Media Controller) compatible equipment.

- Windows Media® Player and a smartphone that has the compatible application serve as the DLNA server and the DMC.

### Preparation

Perform steps ① and ②. (⇒ 24)

- ③ Add the contents and folder to the libraries of the Windows Media® Player or the smartphone, etc.
  - Playlist of Windows Media® Player can play back only the contents that are stored in the libraries.
- ④ Perform the “Remote Device Settings”. (⇒ 33)
  - The maximum number of equipment that can be registered is 16.

- 1 Press [HOME].**
- 2 Press [▲] to select “Network”.**
- 3 Press [▲] to select “Home Network”.**
- 4 Press [▶] to select “Media Renderer”.**
- 5 Operate the DMC compatible equipment.**

**To exit from Media Renderer screen**

Press [HOME].



- Ensure that the router for your home network has adequate security system to prevent unauthorized access.
- Menu structure will be different depending on the equipment connected to this unit. Select the contents by repeating the operation.
- Depending on the contents and the connected equipment, playback may not be possible.
- Items displayed in gray on the display cannot be played back by this unit.
- This unit can be played back via connected equipment only when controlled using DMC.
- Depending on the performance of the connected PC, video frames may be dropped during playback, or video may not playback at all.

# Linked operations with the TV (VIERA Link™ “HDAVI Control™”)

## What is VIERA Link “HDAVI Control”?

VIERA Link™ is a new name for EZ Sync™. VIERA Link “HDAVI Control” is a convenient function that offers linked operations of this unit, and a Panasonic TV (VIERA) or amplifier/receiver under “HDAVI Control”. You can use this function by connecting the equipment with an HDMI cable. See the operating instructions for connected equipment for operational details.

## Preparation

- ① Set “VIERA Link” to “On” (⇒ 32). (The default setting is “On”.)
- ② Set the “HDAVI Control” operations on the connected equipment (e.g., TV).
- ③ Turn on all “HDAVI Control” compatible equipment and select this unit’s input channel on the connected TV so that the “HDAVI Control” function works properly. **Also when the connection or settings are changed, repeat this procedure.**

## Automatic input switching Power on link

When the following operations are performed, the television will automatically switch the input channel and display the corresponding action. When the television is off, the television will automatically turn on.

- When play starts on the unit
- When an action that uses the display screen is performed (e.g., Direct Navigator screen)

## Power off link

All connected equipment compatible with “HDAVI Control”, including this unit, automatically turns off when you switch the television off.

### Playing music continuously even after turning off power to the television

When the unit is connected to a Panasonic TV (VIERA) that supports HDAVI Control 2 or later and an amplifier/receiver supports VIERA Link.

- ① While playing music  
Press [SUB MENU].
- ② Press [▲, ▼] to select “TV Power” and press [OK].

## Easy control only with VIERA remote control

### Only TV supports “HDAVI Control 2” or later

By using the TV remote control, you can play discs using the “Control Panel” and display the Top Menu or Pop-up Menu, etc.

- 1 Press [SUB MENU].
- 2 Select an item, then press [OK].

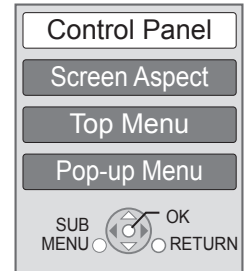

- The sub menu may not appear while the Top Menu for BD-Video or DVD-Video is displayed.



- The buttons that you can use for this unit vary depending on the TV. For details, refer to the operating instructions of the TV.
- The operation of this unit may be interrupted when you press incompatible buttons on the TV remote control.
- This unit supports “HDAVI Control 5” function. “HDAVI Control 5” is the newest standard (current as of December, 2010) for Panasonic’s HDAVI Control compatible equipment. This standard is compatible with Panasonic’s conventional HDAVI equipment.
- VIERA Link “HDAVI Control”, based on the control functions provided by HDMI which is an industry standard known as HDMI CEC (Consumer Electronics Control), is a unique function that we have developed and added. As such, its operation with other manufacturers’ equipment that supports HDMI CEC cannot be guaranteed.
- Please refer to individual manuals for other manufacturers’ equipment supporting VIERA Link function.

# Playback menu

## 1 Press [DISPLAY].

e.g., BD-Video



## 2 Press [▲, ▼] to select the menu and press [▶].

## 3 Press [▲, ▼, ◀, ▶] to select the item and press [▶].

## 4 Press [▲, ▼] to select the setting.

Some items can be changed by pressing [OK].

### To exit the screen

Press [DISPLAY].

Depending on the condition of the unit (playing, stopped, etc.) and media contents, there may be some items that you cannot select or change.

Regarding Language : (⇒ 38)

## Disc

### Signal Type

Primary Video	Video	The recording method of original video appears.
	Soundtrack	Select the type of audio or language.
Secondary Video	Video	Select on/off of images. The recording method of original video appears.
	Soundtrack	Select on/off of audio and the language.

### Video

The recording method of original video appears.

### Soundtrack

Show or change the soundtrack.

### Subtitle

Turn the subtitle on/off, and change the language depending on the media.

### Subtitle Style

Select the subtitle style.

### Audio channel

Select the audio channel number.  
(⇒ 17, "Changing audio")

### Angle

Select the number of the angle.



- Some items may be changed only on the disc specific menu. (⇒ 17)

## Play

### Repeat Play

(Only when the elapsed time is being displayed on the unit's display.)

Select the item which you want to repeat. The items displayed differ depending on the type of media.



Select "Off" to cancel.

### Random

Select whether or not to play random.

### Playback Information Window [BDT210]

Displays the following.

	Audio/video attribute information of disc.
	Settings status of "Digital Audio Output" (⇒ 30).
	HDMI output information.

Press [RETURN] to exit.

### Pop-Out Level

(Only when "Full HD" is selected in "3D Type" (⇒ 31).)

Pop-up position for the Playback menu or message screen etc. can be adjusted during 3D playback.

## Video

### Picture

Select the picture quality mode during play.

- If you select "User", you can make further adjustments. Press [▶] to select "Picture Adjustment" and press [OK].
- 3D NR:  
Reduces the rough noise in the background to give a greater feeling of depth.  
When "24p Output" is set to "On", this function may not operate. (⇒ 31)
- Integrated NR:  
Smooths block noise and reduces the smudging that appears around contrasting sections of the picture.

### Advanced Settings

#### Chroma Process

The high-resolution processing of HDMI chroma signals produces a high-resolution picture with rich picture quality.

#### Detail Clarity

The picture is sharp and detailed.

#### Super Resolution

Pictures of normal image quality are corrected to sharp and detailed images when output as 1080i/1080p from HDMI AV OUT.

## Progressive

Select the method of conversion for progressive output to suit the type of material being played.

- When the content is distorted change the settings from "Auto" to "Video".

## 24p

Movies and other material recorded on DVD-Video at 24p are output at 24p.

- Only when you have selected "On" in "24p Output" (⇒ 31).

## Audio

### Sound Effects\*<sup>1</sup>, \*<sup>2</sup>

Select the sound effect.

- Digital Tube Sound [BDT210] :

This feature gives you warm sound, like that produced by a vacuum tube amplifier.

- Re-master :

This feature gives you brighter sound by increasing the high frequency portion of the audio. (Discs recorded at 48 kHz or less)

Recommended setting

<b>Re-master 1</b>	Pop and rock
<b>Re-master 2</b>	Jazz
<b>Re-master 3</b>	Classical

- Night Surround :

Enjoy a movie with powerful sound even when the volume is kept low at night. The audio is set in such a way that it can be heard easily.

### Dialog Enhancer\*<sup>2</sup>

The volume of the center channel is raised to make dialog easier to hear.

### High Clarity Sound [BDT210]

When connected to TV via the HDMI terminal for outputting image, it produces clearer sound.

- Only when you have selected "Enable" in "High Clarity Sound" (⇒ 30).

<sup>1</sup> Not every function can be set individually.

<sup>2</sup> This function is effective for audio from the HDMI terminal or the OPTICAL terminal only when "Digital Audio Output" is set to "PCM" (⇒ 30). (However, in this case, audio is output as 2ch from the OPTICAL terminal.)

# Setup menu

Change the unit's settings if necessary. The settings remain intact even if you switch the unit to standby.

- 1 Press [HOME].
- 2 Press [OK] to select "Setup".
- 3 Press [▼] to select "Player Settings".

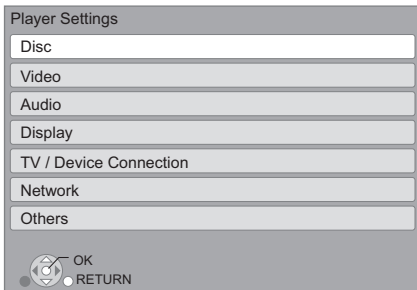

- 4 Press [▲, ▼] to select the menu and press [OK].
- 5 Press [▲, ▼] to select the item and press [OK].  
If there are any other items, repeat these steps.
- 6 Press [▲, ▼, ◀, ▶] to select the option and press [OK].



- There may be differences in operation methods. If this happens, follow the on-screen instructions for the operation.

## About the password

The following items use the same password.  
Don't forget your password.

- "DVD-Video Ratings"
- "BD-Video Ratings"
- "Lock" (⇒ 32)

## Disc

### DVD-Video Ratings

Set a ratings level to limit DVD-Video play.

- Follow the on-screen instructions. Enter a 4-digit password with the number buttons when the password screen is shown.

### BD-Video Ratings

Set an age limit of BD-Video play.

- Follow the on-screen instructions. Enter a 4-digit password with the number buttons when the password screen is shown.

### 3D BD-Video Playback

Select the playback method of 3D compatible video software.

### Audio Language

Choose the language for audio.

- If "Original" is selected, the original language of each disc will be selected.
- Enter a code (⇒ 38) with the number buttons when you select "Other \*\*\*\*".

### Subtitle Language

Choose the language for the subtitle.

- If "Automatic" is selected and the language selected for "Audio Language" is not available, subtitles of that language will automatically appear if available on that disc.
- Enter a code (⇒ 38) with the number buttons when you select "Other \*\*\*\*".

### Menu Language

Choose the language for the disc menus.

- Enter a code (⇒ 38) with the number buttons when you select "Other \*\*\*\*".

### BD-Live Internet Access (⇒ 19)

You can restrict Internet access when BD-Live functions are used.

- If "Allow (Limited)" is selected, Internet access is permitted only for BD-Live contents which have content owner certificates.

### Subtitle Text

Select a suitable item according to the language used for DivX [BDT210 for Canada] or MKV subtitles text (⇒ 18).

- This item is displayed only after playing back a file.

## Video

### Still Mode (paused video)

Select the type of picture shown when you pause playback.

<b>Auto</b>	Automatically selects the type of picture shown.
<b>Field</b>	Select if jittering occurs when "Auto" is selected.
<b>Frame</b>	Select if small text or fine patterns cannot be seen clearly when "Auto" is selected.

### Seamless Play

The chapter segments in playlists are played seamlessly.

- Select "On", when the picture freezes for a moment at the chapters segment in playlists.

### Black Level Control

Select lighter or darker for adjusting the black level control to the desired setting for picture enhancement.

## Audio

### Dynamic Range Compression

You can listen at low volumes but still hear dialog clearly. (Dolby Digital, Dolby Digital Plus and Dolby TrueHD only)

- "Auto" is effective only when playing Dolby TrueHD.

### Digital Audio Output

Press [OK] to show the following settings:

#### Dolby D/Dolby D +/Dolby TrueHD DTS/DTS-HD

Select the audio signal to output.

- Select "PCM", when the connected equipment cannot decode the respective audio format. This unit decodes the audio format and transmits to the connected equipment.
- Not making the proper settings may result in noise.

#### BD-Video Secondary Audio

Select whether to mix or not mix the primary audio and secondary audio (including the button click sound). (⇒ 19)

- If "Off" is selected, the unit outputs the primary audio only.

### PCM Down Conversion

Select how to output audio with a sampling frequency of 96 kHz for the PCM output from the DIGITAL AUDIO OUT.

- If "On" is selected, the signals that are converted to 48 kHz are output.
- If "Off" is selected, and the connected equipment does not support 96 kHz, the sound will not be output normally.
- Signals are converted to 48 kHz despite the settings in the following cases:
  - when the signals have a sampling frequency of 192 kHz
  - when the disc has copy protection
  - when "BD-Video Secondary Audio" is set to "On"

### Downmix

Select the downmix system of multi-channel to 2-channel sound.

- Select "Surround encoded", when the connected equipment supports the virtual surround function.
- There is no effect on "Bitstream" via HDMI AV OUT and DIGITAL AUDIO OUT.
- The audio will be output in "Stereo" in the following cases:
  - AVCHD playback
  - Playback of secondary audio (including the button click sound).

### 7.1ch Audio Reformatting BDT210

Surround sound with 6.1ch or less is automatically expanded and played back at 7.1ch.

- If "Off" is selected, sound is played over the original number of channels. (Note that in the case of 6.1ch audio, playback will be at 5.1ch.)
- Audio reformatting is enabled in the following cases:
  - When you have selected "PCM" in "Digital Audio Output".
  - When the audio is Dolby Digital, Dolby Digital Plus, Dolby TrueHD or LPCM.
  - BD-Video playback

### High Clarity Sound BDT210

When connected to TV via the HDMI terminal for outputting image, it produces clearer sound.

- Set to "Enable" and then set "High Clarity Sound" on the Playback menu to "On". (⇒ 28)

### Audio Delay

Synchronization between picture and sound is corrected by adjusting the delay time of the audio output.

## Display

### Status Messages

Choose whether to show status messages automatically.

### On-screen Language

Choose the language for menus and on-screen messages.

### Screen Saver Function

This is to prevent burn-in on the screen.

- When this is set to "On":  
If there is no operation for 10 minutes or more, Direct Navigator screen switches to HOME menu automatically.
- While playing and pausing, etc., this function is not available.
- As for Music [CD-DA] or MP3, regardless of the setting, if there is no operation for a while, Direct Navigator screen switches to the other states automatically.

### Front Panel Display

Changes the brightness of the unit's display.

- If "Auto" is selected the display is dimmed during playback and bright not during playback.

### License

Information about the software used by this unit is displayed.

## TV / Device Connection

### 3D Settings

Press [OK] to show the following settings:

#### 3D Type

Select the format of the connected TV.

- Change the settings for 3D on the TV also when "Checker board" or "Side by side" is selected.



#### 3D Playback Precautions

Set to display or hide the 3D viewing warning screen when playing back the 3D compatible video software.

### TV Aspect

Set to match the type of television connected.

When connected to a 4:3 aspect television and playing 16:9 ratio image:

<b>4:3 Pan &amp; Scan</b>	The sides are cut off so the picture fills the screen. When playing BD-Video, video is output as "4:3 Letterbox".	
<b>4:3 Letterbox</b>	Black bands appear at the top and bottom of the picture.	

When connected to a 16:9 widescreen television and playing 4:3 ratio image:

<b>16:9</b>	Video is displayed as a 4:3 ratio image in the center of the screen.
<b>16:9 Full</b>	Video is displayed as a horizontally stretched 16:9 image.

### HDMI Connection

Press [OK] to show the following settings:

#### HDMI Resolution

The items supported by the connected devices are indicated on the screen as "\*". When any item without "\*" is selected, the images may be distorted.

- If "Auto" is selected, automatically selects the output resolution best suited to the connected television.
- To enjoy high-definition video up-converted to 1080p, you need to connect the unit directly to 1080p compatible HDTV (High Definition Television). If this unit is connected to an HDTV through other equipment, it must also be 1080p compatible.

#### 24p Output

When this unit is connected to a TV supporting 1080/24p output using an HDMI cable, movies and other material recorded at 24p are output at 24p.

- When playing DVD-Video, set to "On" and then set "24p" in "Video" (⇒ 28) to "On".
- When BD-Video images other than 24p are played, images are output at 60p.
- 24p :  
A progressive image recorded at a rate of 24 frames per second (motion-picture film). Many BD-Video movie contents are recorded in 24 frames/second in accordance with the film materials.

#### HDMI Color Mode

This setting is for selecting color-space conversion of the image signal when the unit is connected using an HDMI cable.

## HDMI Audio Output

This setting selects whether or not to output audio from HDMI.

- Select "Off" when the TV is connected to this unit via an HDMI terminal, and this unit is also connected to other devices, such as an amplifier/receiver via an OPTICAL terminal.

## VIERA Link

Set to use "HDAVI Control" function when connected with an HDMI cable to a device that supports "HDAVI Control".

- Select "Off" when you do not want to use "HDAVI Control".

## Deep Color Output

This setting is for selecting whether to use Deep Color output when a television that supports Deep Color is connected.

## Contents Type Flag

Depending on the playback content, the TV will output adjusting to the optimal method when a TV that supports this function is connected.

# Network

## Network Easy Setting (⇒ 13)

### Network Settings

Perform network-related settings individually.  
Press [OK] to show the following settings:

#### LAN Connection Mode

Select connection method.

#### Wireless Settings

This allows the Wireless router and connection settings to be set and the current connection settings and connection state to be checked when a wireless connection is used.

##### Connection Setting

The Wireless router connection wizard will be displayed.

##### Double Speed Mode Setting (2.4GHz)

When a 2.4 GHz wireless format is used, this setting sets the connection speed.

- If you connect using the "Double Speed Mode (40MHz)", 2 channels use the same frequency band, and there is consequently a greater risk of reception interference. This can cause the connection speed to drop or the connection to become unstable.

#### IP Address/DNS Settings

This is for checking the state of the network connection and setting the IP address and DNS-related.

Press [OK] to show the respective setting.

- "Connection Speed Setting" is enabled only when "Auto Detect Connection Speed" is turned "Off".

## Proxy Server Settings

This is for checking the state of connection with the Proxy server and performing settings.

Press [OK] to show the respective setting.

## Internet Content Settings (⇒ 23) (VIERA CAST)

Press [OK] to show the following settings:

### Lock

You can restrict the usage of VIERA CAST.

- Follow the on-screen instructions. Enter a 4-digit password with the number buttons when the password screen is shown.

### Audio Auto Gain Control

Volume that is different depending on the contents is adjusted automatically to the standard volume while using the VIERA CAST.

- Depending on contents, this function effect will not work.
- Select "Off" when the audio is warped.

### Time Zone

By selecting the time zone, it is possible to set the unit's time to match your location.

- Some VIERA CAST contents require the time zone to be set. Set the time zone if necessary.

### DST

Select "On" when using Daylight Saving time.

## Network Drive Connection

It is possible to access the shared folder of equipment not compatible with DLNA, such as the Windows XP operating system, and play back video, still pictures, and music on this unit.

For the setting and operation method of connected equipment, refer to the following Website.

<http://panasonic.jp/support/global/cs/>  
(This site is in English only.)



## Remote Device Settings (⇒ 25)

Press [OK] to show the following settings:

### Remote Device Operation

Enable to operate by DMC.

- If “On” is selected, “Quick Start” is fixed to “On”.

### Setting Unit Name

Set the name of this unit to be displayed on the connected equipment.

### Registration Type

<b>Automatic</b>	Allow connection to all the equipment that is accessing this unit.
<b>Manual</b>	Set the permission of the connection individually for the equipment that is accessing this unit.

### Remote Device List

Registering/deregistering of the displayed equipment can be performed when “Manual” in “Registration Type” is selected.

## MAC Address

Displays the MAC address of this unit.

## Others

### Remote Control Code

Change the remote control code if other Panasonic products react to this remote control.

### Quick Start

Speed of startup from power off is increased.

- Internal control unit will be powered when it is set to “On” so compared to when the setting is “Off” the following will occur.
  - Idle power consumption will increase. (about the power consumption ⇒ 39)

### Easy Setting

You can execute basic settings. (“On-screen Language”, “TV Aspect”, “Quick Start”, “Touch Free Sensor” **BDT210**)

### Restore Default Settings

This returns all values in the Setup menu and the Playback menu, except for “Remote Control Code”, “On-screen Language”, “LAN Connection Mode”, “Wireless Settings”, “IP Address/DNS Settings”, “Proxy Server Settings”, “Lock”, “DVD-Video Ratings” and “BD-Video Ratings” etc. to the default settings.

## Touch Free Sensor **BDT210**

Press [OK] to show the following settings:

### Sensor (⇒ 5)

Tray is opened and closed by waving your hands above the top part of this unit.

### Sound Level

Adjust the volume of the sensor.

## DivX Registration (⇒ 18) **BDT210 for Canada**

You need this registration code to purchase and play DivX Video-on-Demand (VOD) content.

### System Information

Display firmware version of this unit and wireless LAN module.

### Firmware Update (⇒ 15)

Press [OK] to show the following settings:

#### Automatic Update Check

When this equipment remains connected to the Internet, it will check for the latest firmware version when it is turned on and you can update it if necessary.

#### Update Now

You can update the firmware manually if a firmware update is available.

# Troubleshooting guide

Before requesting service, please perform the following steps.

## Do you have the latest firmware installed?

Firmware updates may be released to correct operating irregularities that are discovered with certain movies.  
(⇒ 15)



**Make the following checks and visit our website for more information.**

**For USA :**

[www.panasonic.com/help](http://www.panasonic.com/help)

Enter the model number.

**For Canada :**

<http://www.panasonic.ca>



**Or visit our website to find a service center.**

You can find a service center near you easily on our website.

**Other support information:**

"Customer Services Directory (United States and Puerto Rico)" (⇒ 41) or "Limited Warranty (Only for CANADA)" (⇒ 42).

**The following do not indicate a problem with this unit:**

- Regular disc rotating sounds.
- Image disturbance during search.
- Image disturbance when replacing 3D discs.

## ■ Unit doesn't respond to remote control or front panel buttons.

Press and hold [POWER ⏻/⏻] on the main unit for 3 seconds.

- If still unable to power the unit off, disconnect the power cord, wait 1 minute, then reconnect the power cord.

## ■ Cannot eject disc.

The unit may have a problem.

- ① While the unit is off, press and hold [OK], [B] and [Y] on the remote control at the same time for more than 5 seconds.
  - "00 RET" is displayed on the unit's display.
- ② Repeatedly press [▶] (right) on the remote control or [POWER ⏻/⏻] on the unit until "06 FTO" is displayed on the unit's display.
- ③ Press [OK] on the remote control or [▲ OPEN/CLOSE] on the unit.

## General operation

**To return to the factory preset.**

- Select "Yes" in "Restore Default Settings" in the Setup menu. (⇒ 33)

**To return all settings to the factory preset.**

- Reset the unit as follows:
  - ① While the unit is off, press and hold [OK], [B] and [Y] on the remote control at the same time for more than 5 seconds.
    - "00 RET" is displayed on the unit's display.
  - ② Repeatedly press [▶] (right) on the remote control or [POWER ⏻/⏻] on the unit until "08 FIN" is displayed on the unit's display.
  - ③ Press and hold [OK] on the remote control or [▲ OPEN/CLOSE] on the unit for at least 3 seconds.

**This unit is turned off when the input for the TV is switched.**

- This is a normal phenomenon when using VIERA Link (HDAVI Control 4 or later). For details please read the operating instructions for the TV.

**The remote control doesn't work properly.**

- Change the batteries in the remote control. (⇒ 4)
- The remote control and main unit are using different codes. If "SET □" is displayed on the unit's display when a button is pressed on the remote control, change the code on the remote control. (⇒ 33)

**The TV tuner mode is not displayed when the TV is switched on.**

- This phenomenon may occur, depending on the TV setting, when "Quick Start" is set to "On".
- Depending on the TV, this phenomenon may be prevented by reconnecting the HDMI cable to a different HDMI input terminal or by changing the HDMI auto connection setting.

**You have forgotten your ratings password. You want to cancel the ratings level.**

- The ratings level returns to the factory preset.
  - ① While the unit is on, press and hold [OK], [B] and [Y] on the remote control at the same time for more than 5 seconds.
    - "00 RET" is displayed on the unit's display.
  - ② Repeatedly press [▶] (right) on the remote control or [POWER ⏻/⏻] on the unit until "03 VL" is displayed on the unit's display.
  - ③ Press [OK] on the remote control or [▲ OPEN/CLOSE] on the unit.

## This unit does not recognize the USB connection correctly.

- If USB device is connected to this unit while playing a disc or in a video communication the connection will not be recognized. Press [HOME] and reconnect USB device.
- **BDT210** : USB memory and USB HDD are not recognized via the rear USB port of this unit.
- Disconnect and reconnect the USB cable. If it still does not recognize the connection, turn the power of this unit off and on again.
- USB devices connected using a USB extension cable other than the supplied with the Wireless LAN Adaptor DY-WL10 (optional) **BDT110** or a USB hub may not be recognized by this unit.
- If you connect USB HDD to this unit, use USB extension cable that is supplied with the HDD.
- If two USB memory and USB HDD are connected simultaneously, they will not be recognized by this unit.

## Picture

### The images from this unit do not appear on the television.

#### Picture is distorted.

- An incorrect resolution is selected in "HDMI Resolution". Reset the setting as follows:
  - ① While the unit is on, press and hold [OK], [B] and [Y] on the remote control at the same time for more than 5 seconds.
    - "00 RET" is displayed on the unit's display.
  - ② Repeatedly press [▶] (right) on the remote control or [POWER ⏻/⏹] on the unit until "04 PRG" is displayed on the unit's display.
  - ③ Press and hold [OK] on the remote control or [▲ OPEN/CLOSE] on the unit for at least 3 seconds.  
Set the item again. (⇒ 31)
- When Dolby Digital Plus, Dolby TrueHD, and DTS-HD audio are not output in bitstream, select "Yes" in "Restore Default Settings" and make proper settings. (⇒ 33)
- When "3D BD-Video Playback" in the Setup menu is set to "Automatic", images may not be output depending on the connection method. After removing the disc from this unit, select "Set before play" in the Setup menu, and select "2D Playback" in the setup screen displayed when playing 3D discs. (⇒ 29)

### Video is not output. **BDT210**

- Set "High Clarity Sound" in the Playback menu to "Off" to use the VIDEO OUT terminal. (⇒ 28)

### Video is not output in high-definition.

- Confirm that "HDMI Resolution" in the Setup menu is set properly. (⇒ 31)

### 3D video is not output.

- Is there a non-3D compatible amplifier/receiver connected between this unit and a TV? (⇒ 9)
- Are the settings on this unit and the TV correct? (⇒ 20)
- Is the amplifier/receiver that is connected between this unit and TV on?

### 3D video is not output correctly as 2D.

- Select "Set before play" in the Setup menu, and select "2D Playback" in the setup screen displayed when playing 3D discs. (⇒ 29)
- Discs that have recorded titles with Side by side (2 screen structure) and that can be enjoyed in 3D are played back in accordance with the settings of the TV.

### No subtitles.

- When progressive output is on, closed captions/subtitles cannot be displayed.

### The subtitles overlap closed captions recorded on discs.

- Turn off the subtitles or turn off the closed caption setting on the TV. (⇒ 27)

### A black band is displayed around the edge of the screen.

#### The aspect ratio of the screen is abnormal.

- Confirm the "TV Aspect" is set properly. (⇒ 31)
- Adjust the aspect setting on the television.

## Audio

### Cannot switch audio.

- When connecting an amplifier/receiver using an OPTICAL terminal or an HDMI terminal, you cannot switch the audio if "Digital Audio Output" is set to "Bitstream". Set "Digital Audio Output" to "PCM". (⇒ 30)

### Cannot hear the desired audio type.

- Check the connections and the "Digital Audio Output" settings. (⇒ 9, 30)
- To output audio from a device connected with an HDMI cable, set "HDMI Audio Output" to "On" in the Setup menu. (⇒ 32)

## Playback

### **Disc cannot be played.**

- The disc is dirty. (⇒ 4)
- 

### **Still pictures (JPEG) do not play back normally.**

- The images that were edited on the PC, such as Progressive JPEG, etc., may not play back.
- 

### **I can't play back BD-Live.**

- The SD card is write-protected. (⇒ 7)
  - Confirm that this unit is connected to the broadband Internet. (⇒ 10)
  - Confirm the "BD-Live Internet Access" settings. (⇒ 29)
  - Confirm an SD Card is inserted into the SD Card slot. (⇒ 16)
- 

## Network

### **I can't connect to the network.**

- Confirm the network connection and settings. (⇒ 10, 13, 32)
  - Check the operating instructions for each device and connect accordingly.
- 

### **When using Wireless LAN connection, video from the DLNA Certified media server is not played back or video frames are dropped during playback.**

- Higher transfer rate router such as 802.11n (2.4 GHz or 5 GHz) Wireless router may solve the problem. If you use 802.11n (2.4 GHz or 5 GHz) Wireless router, it is necessary to set the encryption type to "AES". Simultaneous use with a microwave, cordless telephone etc. at 2.4 GHz may result in connection interruptions or other problems.
  - On the "Wireless Settings" screen (⇒ 32), the continuous lighting of at least 4 "Reception" indicators is the target for a stable connection. If 3 or fewer indicators are lit or the connection is being interrupted, change the position or angle of your Wireless router and see if the connection state improves. If there is no improvement, connect to a wired network and perform the "Network Easy Setting" (⇒ 13) again.
-

# Messages

The following messages or service numbers appear on the television or unit's display when something unusual is detected during startup and use.

## On the television

### Cannot play.

- You inserted an incompatible disc (Discs recorded in PAL video, etc.).

### Cannot display on this unit.

- You tried to play a non-compatible image.
- Confirm "SD" on the unit's display is not displayed and re-insert the card.

### No disc is inserted.

- The disc may be upside down.

### ⊘ This operation is not available.

- Some operations are unsupported by the unit. For example;
  - BD-Video: During playback, reverse slow-motion or reverse frame-by-frame is not possible.

### IP address is not set.

- The "IP Address" in "IP Address/DNS Settings" is "---. ---. ---. ---". Set the "IP Address", "Subnet Mask", and "Default Gateway". (Select the automatic address acquisition if necessary.)

### The current settings only offer minimal wireless access point security and low performance. It is recommended to change it for better security.

- Authentication type for the Wireless LAN is set to "Open system", or the encryption type is set to "No encryption". It is recommended to encrypt for safety reasons. For details, refer to the instructions of the Wireless router being used. Encryption is required when playing back video, etc., from DLNA compatible devices.

## On the unit's display

### F99

- The unit fails to operate properly. Press [POWER ⏻/⏹] on the main unit for 3 seconds to switch the unit to standby, then switch back on.

### HDMI ONLY

- Some BD-Video discs can only be output with HDMI.

### NET

- While connecting to a network.

### No PLAY

- There is a viewing restriction on a BD-Video or DVD-Video. (⇒ 29)

### No READ

- The media is dirty or badly scratched. The unit cannot play.

### PLEASE WAIT

- The unit is carrying out an internal process. This is not a malfunction. You cannot operate the unit while "PLEASE WAIT" is displayed.

### REMOVE

- The USB device is drawing too much power. Remove the USB device.

### SET □

("□" stands for a number.)

- The remote control and main unit are using different codes. Change the code on the remote control.

Press and hold [OK] and the indicated number button at the same time for more than 5 seconds.



### U59

- The unit is hot. The unit switches to standby for safety reasons. Wait for about 30 minutes until the message disappears. Select a position with good ventilation when installing the unit. Do not block the ventilation hole on the side of the unit.

### U72

### U73

- The HDMI connection is not working properly.
  - Turn the unit and TV off.
  - Disconnect the HDMI cable between the player and the TV.

### H□□ or F□□

("□" stands for a number.)

- There is something unusual.
- Check the unit using the troubleshooting guide. If the service number does not disappear, do the following.
  - ① Disconnect the plug from the AC outlet, wait a few seconds, then reconnect it.
  - ② Press [POWER ⏻/⏹] to turn the power on.If the service number does not disappear despite doing the above, request service from the dealer. Inform the dealer of the service number when requesting service.

### START

- The system is being restarted during the firmware update. Please do not turn off the unit.

### UPD□/□

("□" stands for a number.)

- The firmware is being updated. Please do not turn off the unit.

### FINISH

- The firmware update is complete.

# Supplemental information

## ■ Display languages list

Display Language	Display Language	Display Language
ENG English	JPN Japanese	ARA Arabic
FRA French	CHI Chinese	HIN Hindi
DEU German	KOR Korean	PER Persian
ITA Italian	MAL Malay	IND Indonesian
ESP Spanish	VIE Vietnamese	MRI Maori
NLD Dutch	THA Thai	BUL Bulgarian
SVE Swedish	POL Polish	RUM Romanian
NOR Norwegian	CES Czech	GRE Greek
DAN Danish	SLK Slovak	TUR Turkish
POR Portuguese	HUN Hungarian	* Others
RUS Russian	FIN Finnish	

## ■ Language code list

Language Code	Language Code	Language Code
Abkhazian: 6566	Gujarati: 7185	Rhaeto-Romance: 8277
Afar: 6565	Hausa: 7265	Romanian: 8279
Afrikaans: 6570	Hebrew: 7387	Russian: 8285
Albanian: 8381	Hindi: 7273	Samoan: 8377
Amharic: 6577	Hungarian: 7285	Sanskrit: 8365
Arabic: 6582	Icelandic: 7383	Scots Gaelic: 7168
Armenian: 7289	Indonesian: 7378	Serbian: 8382
Assamese: 6583	Interlingua: 7365	Serbo-Croatian: 8372
Aymara: 6589	Irish: 7165	Shona: 8378
Azerbaijani: 6590	Italian: 7384	Sindhi: 8368
Bashkir: 6665	Japanese: 7465	Singhalese: 8373
Basque: 6985	Javanese: 7487	Slovak: 8375
Bengali; Bangla: 6678	Kannada: 7578	Slovenian: 8376
Bhutani: 6890	Kashmiri: 7583	Somali: 8379
Bihari: 6672	Kazakh: 7575	Spanish: 6983
Breton: 6682	Kirghiz: 7589	Sundanese: 8385
Bulgarian: 6671	Korean: 7579	Swahili: 8387
Burmese: 7789	Kurdish: 7585	Swedish: 8386
Byelorussian: 6669	Laotian: 7679	Tagalog: 8476
Cambodian: 7577	Latin: 7665	Tajik: 8471
Catalan: 6765	Latvian, Lettish: 7686	Tamil: 8465
Chinese: 9072	Lingala: 7678	Tatar: 8484
Corsican: 6779	Lithuanian: 7684	Telugu: 8469
Croatian: 7282	Macedonian: 7775	Thai: 8472
Czech: 6783	Malagasy: 7771	Tibetan: 6679
Danish: 6865	Malay: 7783	Tigrinya: 8473
Dutch: 7876	Malayalam: 7776	Tonga: 8479
English: 6978	Maltese: 7784	Turkish: 8482
Esperanto: 6979	Maori: 7773	Turkmen: 8475
Estonian: 6984	Marathi: 7782	Twi: 8487
Faroese: 7079	Moldavian: 7779	Ukrainian: 8575
Fiji: 7074	Mongolian: 7778	Urdu: 8582
Finnish: 7073	Nauru: 7865	Uzbek: 8590
French: 7082	Nepali: 7869	Vietnamese: 8673
Frisian: 7089	Norwegian: 7879	Volapük: 8679
Galician: 7176	Oriya: 7982	Welsh: 6789
Georgian: 7565	Pashto, Pushto: 8083	Wolof: 8779
German: 6869	Persian: 7065	Xhosa: 8872
Greek: 6976	Polish: 8076	Yiddish: 7473
Greenlandic: 7576	Portuguese: 8084	Yoruba: 8979
Guarani: 7178	Punjabi: 8065	Zulu: 9085
	Quechua: 8185	

# Specifications

**Signal system:** NTSC  
**Operating temperature range:** +5 °C to +35 °C (+41 °F to +95 °F)  
**Operating humidity range:** 10 % to 80 % RH (no condensation)  
**Video output:** 1.0 Vp-p (75 Ω)/Pin jack:1 system  
**Audio output:** 2 Vrms (1 kHz, 0 dB)/Pin jack  
**Number of connectors :** 2 channel:1 system  
**Digital audio output:** Optical digital output (Optical terminal)  
**HDMI AV output:** Type A (19 pin) : 1 system  
 This unit supports "HDAVI Control 5" function.  
**SD card slot:** Connector : 1 system  
**USB slot:** USB2.0 : 2 system  
**Ethernet:** 10BASE-T/100BASE-TX : 1 system  
**WLAN** **BDT210**  
**Antenna:** Tx 1, Rx 2  
**Standard Compliance:** IEEE802.11n / IEEE802.11a / IEEE802.11g / IEEE802.11b  
**Transmission system:** MISO-OFDM system, OFDM system, DSSS system  
**Transfer rate (standard)\*:** IEEE802.11n: Tx Max. 150 Mbps, Rx Max. 300 Mbps  
 IEEE802.11g / IEEE802.11a: Max. 54 Mbps  
 IEEE802.11b: Max. 11 Mbps  
**Access Mode:** Infrastructure mode  
**Security:** WPA2-PSK (TKIP/AES)  
 WPA-PSK (TKIP/AES)  
 WEP (64 bit / 128 bit)  
 (This unit supports WPA and WPA2 encryption.)

## LASER Specification

### Class I LASER Product:

Wave length: 790 nm (CDs)/655 nm (DVDs)/405 nm (BDs)  
 Laser power: No hazardous radiation is emitted with the safety protection

**Power supply:** AC 120 V, 60 Hz  
**Power consumption:** Approx. 9.9 W  
**Power consumption in standby mode:** **Approx. 0.1 W**  
**Power consumption in quick start standby mode:** **Approx. 3.2 W**

**Dimensions (W×D×H) Including the projecting parts:** 430 mm×185 mm×35 mm  
 (Approx. 16 15/16"×7 5/16"×1 7/16")

**Mass (Weight):** Approx. 1.6 kg (3.52 lbs)

Specifications are subject to change without notice.

\* Transfer rates are theoretical values; however, actual communication rate will vary according to communication environment or connected equipment.

## File format

File format	Extension	Reference
<b>MP3</b>	“.MP3”, “.mp3”	ID3 tags (Only titles and the names of artists)
<b>JPEG</b>	“.JPG”, “.jpg”	<ul style="list-style-type: none"> <li>MOTION JPEG and Progressive JPEG is not supported</li> <li>You may not be able to play back the file if you have edited the folder structure or the file name on a PC or other device.</li> </ul>
<b>DivX</b> <small>BDT210 for Canada</small>	“.DIVX”, “.divx”, “.AVI”, “.avi” <b>Subtitles text file</b> “.SRT”, “.srt”, “.SUB”, “.sub”, “.TXT”, “.txt”	<ul style="list-style-type: none"> <li>The video file and subtitles text file are inside the same folder, and the file names are the same except for the file extensions.</li> <li>Some DivX and MKV file may not be played back, depending on the video resolution and frame rate condition.</li> </ul>
<b>MKV</b>	“.MKV”, “.mkv” <b>Subtitles text file</b> “.SRT”, “.srt”, “.SSA”, “.ssa”, “.ASS”, “.ass”	

- With certain recording states and folder structures, the play order may differ or playback may not be possible.

## Audio information

The audio output differs depending on which terminals are connected to the amplifier/receiver, and the settings on the unit. (⇒ 30, Digital Audio Output)

- The number of channels listed is the maximum possible number of output channels when connected to amplifier/receiver compatible with the respective audio format.

Terminal	“Digital Audio Output”	
	“Bitstream”	“PCM”
<b>HDMI AV OUT</b>	Outputs using original audio <sup>1</sup>	BD-Video : 7.1ch PCM <sup>1*2*3</sup> DVD-Video : 5.1ch PCM
<b>OPTICAL</b>	Dolby Digital/ DTS Digital Surround	Down-mixed 2ch PCM

<sup>1</sup> When “BD-Video Secondary Audio” is set to “On”, the audio will be output as Dolby Digital, DTS Digital Surround or 5.1ch PCM.

<sup>2</sup> **BDT110** : The maximum possible number of Dolby sound is 5.1ch PCM.

<sup>3</sup> The audio output is amplified from 5.1ch or 6.1ch to 7.1ch depending on the DTS, Inc. specifications.

Java and all Java-based trademarks and logos are trademarks or registered trademarks of Sun Microsystems, Inc. in the United States and other countries.

Manufactured under license from Dolby Laboratories. Dolby and the double-D symbol are trademarks of Dolby Laboratories.

Manufactured under license under U.S. Patent #'s: 5,451,942; 5,956,674; 5,974,380; 5,978,762; 6,226,616; 6,487,535; 7,392,195; 7,272,567; 7,333,929; 7,212,872 & other U.S. and worldwide patents issued & pending.  
DTS and the Symbol are registered trademarks, & DTS-HD, DTS-HD Master Audio | Essential and the DTS logos are trademarks of DTS, Inc. Product includes software.  
© DTS, Inc. All Rights Reserved.

This item incorporates copy protection technology that is protected by U.S. patents and other intellectual property rights of Rovi Corporation. Reverse engineering and disassembly are prohibited.

HDMI, the HDMI Logo, and High-Definition Multimedia Interface are trademarks or registered trademarks of HDMI Licensing LLC in the United States and other countries.

This product is licensed under the AVC patent portfolio license and VC-1 patent portfolio license for the personal and non-commercial use of a consumer to (i) encode video in compliance with the AVC Standard and VC-1 Standard ("AVC/VC-1 Video") and/or (ii) decode AVC/VC-1 Video that was encoded by a consumer engaged in a personal and non-commercial activity and/or was obtained from a video provider licensed to provide AVC/VC-1 Video. No license is granted or shall be implied for any other use. Additional information may be obtained from MPEG LA, LLC.  
See <http://www.mpegla.com>.

HDAVI Control™ is a trademark of Panasonic Corporation.

VIERA Link™ is a trademark of Panasonic Corporation.

VIERA CAST™ is a trademark of Panasonic Corporation.

EZ Sync™ is a trademark of Panasonic Corporation.

MPEG Layer-3 audio coding technology licensed from Fraunhofer IIS and Thomson.

"AVCHD" and the "AVCHD" logo are trademarks of Panasonic Corporation and Sony Corporation.

SDXC Logo is a trademark of SD-3C, LLC.

"DVD Logo" is a trademark of DVD Format/Logo Licensing Corporation.

The Wi-Fi CERTIFIED Logo is a certification mark of the Wi-Fi Alliance.

DivX®, DivX Certified® and associated logos are trademarks of DivX, Inc. and are used under license.

DLNA, the DLNA Logo and DLNA CERTIFIED are trademarks, service marks, or certification marks of the Digital Living Network Alliance.

Windows is a trademark or a registered trademark of Microsoft Corporation in the United States and other countries.

YouTube and Picasa are trademarks of Google, Inc.

Skype, associated trade marks and logos and the "S" logo are trademarks of Skype Limited.

This product incorporates the following software:

- (1) the software developed independently by or for Panasonic Corporation,
- (2) the software owned by third party and licensed to Panasonic Corporation,
- (3) the software licensed under the GNU General Public License, Version 2 (GPL v2),
- (4) the software licensed under the GNU LESSER General Public License, Version 2.1 (LGPL v2.1) and/or,
- (5) open sourced software other than the software licensed under the GPL v2 and/or LGPL v2.1

For the software categorized as (3) and (4), please refer to the terms and conditions of GPL v2 and LGPL v2.1, as the case may be at <http://www.gnu.org/licenses/old-licenses/gpl-2.0.html> and <http://www.gnu.org/licenses/old-licenses/lgpl-2.1.html>. In addition, the software categorized as (3) and (4) are copyrighted by several individuals. Please refer to the copyright notice of those individuals at <http://www.am-linux.jp/dl/AWBPP11>

The GPL/LGPL software is distributed in the hope that it will be useful, but WITHOUT ANY WARRANTY, without even the implied warranty of MERCHANTABILITY or FITNESS FOR A PARTICULAR PURPOSE.

At least three (3) years from delivery of products, Panasonic will give to any third party who contacts us at the contact information provided below, for a charge no more than our cost of physically performing source code distribution, a complete machine-readable copy of the corresponding source code covered under GPL v2/LGPL v2.1.

Contact Information  
[cdrequest@am-linux.jp](mailto:cdrequest@am-linux.jp)

Source code is also freely available to you and any other member of the public via our website below.  
<http://www.am-linux.jp/dl/AWBPP11>

For the software categorized as (5) includes as follows.

1. This product includes software developed by the OpenSSL Project for use in the OpenSSL Toolkit. (<http://www.openssl.org/>)
2. This product includes software developed by the University of California, Berkeley and its contributors.
3. FreeType code.
4. The Independent JPEG Group's JPEG software.

gSOAP Public License 1.3

Part of the software embedded in this product is gSOAP software. Portions created by gSOAP are Copyright (C) 2001-2009 Robert A. van Engelen, Genivia inc. All Rights Reserved.

THE SOFTWARE IN THIS PRODUCT WAS IN PART PROVIDED BY GENIVIA INC AND ANY EXPRESS OR IMPLIED WARRANTIES, INCLUDING, BUT NOT LIMITED TO, THE IMPLIED WARRANTIES OF MERCHANTABILITY AND FITNESS FOR A PARTICULAR PURPOSE ARE DISCLAIMED. IN NO EVENT SHALL THE AUTHOR BE LIABLE FOR ANY DIRECT, INDIRECT, INCIDENTAL, SPECIAL, EXEMPLARY, OR CONSEQUENTIAL DAMAGES (INCLUDING, BUT NOT LIMITED TO, PROCUREMENT OF SUBSTITUTE GOODS OR SERVICES; LOSS OF USE, DATA, OR PROFITS; OR BUSINESS INTERRUPTION) HOWEVER CAUSED AND ON ANY THEORY OF LIABILITY, WHETHER IN CONTRACT, STRICT LIABILITY, OR TORT (INCLUDING NEGLIGENCE OR OTHERWISE) ARISING IN ANY WAY OUT OF THE USE OF THIS SOFTWARE, EVEN IF ADVISED OF THE POSSIBILITY OF SUCH DAMAGE.



# Limited Warranty (ONLY FOR U.S.A. AND PUERTO RICO)

Panasonic Consumer Electronics Company,  
 Division of Panasonic Corporation of North America  
 One Panasonic Way, Secaucus, New Jersey 07094

## Panasonic Blu-ray and DVD Products Limited Warranty

### Limited Warranty Coverage (For USA and Puerto Rico Only)

If your product does not work properly because of a defect in materials or workmanship, Panasonic Consumer Electronics Company (referred to as "the warrantor") will, for the length of the period indicated on the chart below, which starts with the date of original purchase ("warranty period"), at its option either (a) repair your product with new or refurbished parts, (b) replace it with a new or a refurbished equivalent value product, or (c) refund your purchase price. The decision to repair, replace or refund will be made by the warrantor.

Product or Part Name	Parts	Labor
Blu-ray Disc Player, Portable Blu-ray Disc Player	1 year	90 days
Blu-ray Home Theater System	1 year	1 year
DVD Player, Portable DVD Player	1 year	90 days
DVD Recorder	1 year	90 days
Rechargeable Batteries (pack), DVD-RAM Disc (defective exchange)	10 days	Not Applicable

During the "Labor" warranty period there will be no charge for labor. During the "Parts" warranty period, there will be no charge for parts. This Limited Warranty excludes both parts and labor for non-rechargeable batteries, antennas, and cosmetic parts (cabinet). This warranty only applies to products purchased and serviced in the United States or Puerto Rico. This warranty is extended only to the original purchaser of a new product which was not sold "as is".

### Mail-In Service

For assistance in the U.S.A. and Puerto Rico in obtaining repairs, please ship the product prepaid to:

**Panasonic Exchange Center**  
**4900 George McVay Drive**  
**Suite B**  
**McAllen, TX 78503**  
**[panacare@us.panasonic.com](mailto:panacare@us.panasonic.com)**

When shipping the unit, carefully pack, include all accessories, and send it prepaid, adequately insured and preferably in the original carton. If Lithium Ion batteries are shipped by air the package must be labeled "Contains Lithium Ion Battery (No lithium metal)". Damaged batteries are prohibited from shipment by US Mail. Batteries must be securely packed in a manner to prevent short-circuiting and a package cannot contain more than 3 Lithium Ion batteries. Include a letter detailing the complaint, a return address and provide a daytime phone number where you can be reached. A valid registered receipt is required under the Limited Warranty.

**IF REPAIR IS NEEDED DURING THE WARRANTY PERIOD, THE PURCHASER WILL BE REQUIRED TO FURNISH A SALES RECEIPT/PROOF OF PURCHASE INDICATING DATE OF PURCHASE, AMOUNT PAID AND PLACE OF PURCHASE. CUSTOMER WILL BE CHARGED FOR THE REPAIR OF ANY UNIT RECEIVED WITHOUT SUCH PROOF OF PURCHASE.**

### Limited Warranty Limits And Exclusions

This warranty ONLY COVERS failures due to defects in materials or workmanship, and DOES NOT COVER normal wear and tear or cosmetic damage. The warranty ALSO DOES NOT COVER damages which occurred in shipment, or failures which are caused by products not supplied by the warrantor, or failures which result from accidents, misuse, abuse, neglect, mishandling, misapplication, alteration, faulty installation, set-up adjustments, misadjustment of consumer controls, improper maintenance, power line surge, lightning damage,

modification, introduction of sand, humidity or liquids, commercial use such as hotel, office, restaurant, or other business or rental use of the product, or service by anyone other than a Factory Service Center or other Authorized Servicer, or damage that is attributable to acts of God.

**THERE ARE NO EXPRESS WARRANTIES EXCEPT AS LISTED UNDER "LIMITED WARRANTY COVERAGE".**

**THE WARRANTOR IS NOT LIABLE FOR INCIDENTAL OR CONSEQUENTIAL DAMAGES RESULTING FROM THE USE OF THIS PRODUCT, OR ARISING OUT OF ANY BREACH OF THIS WARRANTY.**

(As examples, this excludes damages for lost time, travel to and from the servicer, loss of or damage to media or images, data or other memory or recorded content. The items listed are not exclusive, but for illustration only.)

**ALL EXPRESS AND IMPLIED WARRANTIES, INCLUDING THE WARRANTY OF MERCHANTABILITY, ARE LIMITED TO THE PERIOD OF THE LIMITED WARRANTY.**

Some states do not allow the exclusion or limitation of incidental or consequential damages, or limitations on how long an implied warranty lasts, so the exclusions may not apply to you.

This warranty gives you specific legal rights and you may also have other rights which vary from state to state. If a problem with this product develops during or after the warranty period, you may contact your dealer or Service Center. If the problem is not handled to your satisfaction, then write to the warrantor's Consumer Affairs Department at the addresses listed for the warrantor.

**PARTS AND SERVICE, WHICH ARE NOT COVERED BY THIS LIMITED WARRANTY, ARE YOUR RESPONSIBILITY.**

### Customer Services Directory (United States and Puerto Rico)

Obtain Product Information and Operating Assistance; locate your nearest Dealer or Service Center; purchase Parts and Accessories; or make Customer Service and Literature requests by visiting our Web Site at:

<http://www.panasonic.com/help>

or, contact us via the web at:

<http://www.panasonic.com/contactinfo>

You may also contact us directly at:

1-800-211-PANA (7262)

Monday-Friday 9am-9pm,

Saturday-Sunday 10am-7pm EST

**For hearing or speech impaired TTY users, TTY:  
 1-877-833-8855**

### Accessory Purchases (United States and Puerto Rico)

Purchase Parts, Accessories and Instruction Books online for all Panasonic Products by visiting our Web Site at:

<http://www.pstc.panasonic.com>

Or, send your request by E-mail to:

[npcparts@us.panasonic.com](mailto:npcparts@us.panasonic.com)

You may also contact us directly at:

1-800-332-5368 (Phone) 1-800-237-9080 (Fax Only)

(Monday-Friday 9am-9pm EST)

Panasonic Service and Technology Company

20421 84th Avenue South, Kent, WA 98032

(We accept Visa, MasterCard, Discover Card, American Express, and Personal Checks)

**For hearing or speech impaired TTY users, TTY:  
 1-866-605-1277**

As of November 2009

### User memo:

DATE OF PURCHASE \_\_\_\_\_  
 DEALER NAME \_\_\_\_\_  
 DEALER ADDRESS \_\_\_\_\_  
 TELEPHONE NUMBER \_\_\_\_\_

The model number and serial number of this product can be found on either the back or the bottom of the unit. Please note them in the space provided below and keep for future reference.

MODEL NUMBER \_\_\_\_\_  
 SERIAL NUMBER \_\_\_\_\_

# Limited Warranty (Only for CANADA)

**Panasonic Canada Inc.**  
5770 Ambler Drive, Mississauga, Ontario L4W 2T3

## PANASONIC PRODUCT - LIMITED WARRANTY

Panasonic Canada Inc. warrants this product to be free from defects in material and workmanship under normal use and for a period as stated below from the date of original purchase agrees to, at its option either (a) repair your product with new or refurbished parts, (b) replace it with a new or a refurbished equivalent value product, or (c) refund your purchase price. The decision to repair, replace or refund will be made by Panasonic Canada Inc.

**Technics Audio Product - One (1) year, parts and labour**  
**Panasonic BD/DVD Product - One (1) year, parts and labour**  
**Panasonic Audio Receivers - One (1) year, parts and labour**  
**Home Theater Systems Product - One (1) year, parts and labour**

This warranty is given only to the original purchaser, or the person for whom it was purchased as a gift, of a Panasonic brand product mentioned above sold by an authorized Panasonic dealer in Canada and purchased and used in Canada, which product was not sold "as is", and which product was delivered to you in new condition in the original packaging.

**IN ORDER TO BE ELIGIBLE TO RECEIVE WARRANTY SERVICE HEREUNDER, A PURCHASE RECEIPT OR OTHER PROOF OF DATE OF ORIGINAL PURCHASE, SHOWING AMOUNT PAID AND PLACE OF PURCHASE IS REQUIRED**

### LIMITATIONS AND EXCLUSIONS

This warranty ONLY COVERS failures due to defects in materials or workmanship, and DOES NOT COVER normal wear and tear or cosmetic damage. The warranty ALSO DOES NOT COVER damages which occurred in shipment, or failures which are caused by products not supplied by Panasonic Canada Inc., or failures which result from accidents, misuse, abuse, neglect, mishandling, misapplication, alteration, faulty installation, set-up adjustments, misadjustment of consumer controls, improper maintenance, power line surge, lightning damage, modification, introduction of sand, humidity or liquids, commercial use such as hotel, office, restaurant, or other business or rental use of the product, or service by anyone other than an Authorized Servicer, or damage that is attributable to acts of God.

Dry cell batteries are also excluded from coverage under this warranty.

THIS EXPRESS, LIMITED WARRANTY IS IN LIEU OF ALL OTHER WARRANTIES, EXPRESS OR IMPLIED, INCLUDING ANY IMPLIED WARRANTIES OF MERCHANTABILITY AND FITNESS FOR A PARTICULAR PURPOSE. IN NO EVENT WILL PANASONIC CANADA INC. BE LIABLE FOR ANY SPECIAL, INDIRECT OR CONSEQUENTIAL DAMAGES RESULTING FROM THE USE OF THIS PRODUCT OR ARISING OUT OF ANY BREACH OF ANY EXPRESS OR IMPLIED WARRANTY. (As examples, this warranty excludes damages for lost time, travel to and from the Authorized Servicer, loss of or damage to media or images, data or other memory or recorded content. This list of items is not exhaustive, but for illustration only.)

In certain instances, some jurisdictions do not allow the exclusion or limitation of incidental or consequential damages, or the exclusion of implied warranties, so the above limitations and exclusions may not be applicable. This warranty gives you specific legal rights and you may have other rights which vary depending on your province or territory.

### WARRANTY SERVICE

For product operation and information assistance, please contact:

#### **PRODUCT OPERATION ASSISTANCE**

Customer Care Centre: Telephone #: 1-800-561-5505  
Fax #: (905) 238-2360  
Email link: "Support → contact us → email" on [www.panasonic.ca](http://www.panasonic.ca)

#### **PRODUCT REPAIRS**

Please locate your nearest Authorized Servicentre.

Link: "Support → Panasonic Servicentre® locator" on [www.panasonic.ca](http://www.panasonic.ca)

#### **IF YOU SHIP THE PRODUCT TO A SERVICENTRE**

Carefully pack and send prepaid, adequately insured and preferably in the original carton.  
Include details of the defect claimed, and proof of date of original purchase.

# Referencia rápida en español

(Spanish Quick Reference)

## Conexiones básicas

### Conexión a un televisor compatible con HDMI

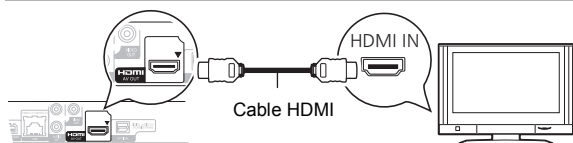

### Conexión a un televisor con un cable para audio/vídeo

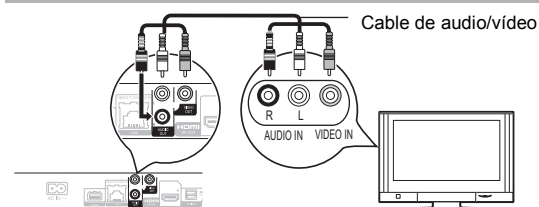

### Conexión a un televisor compatible con HDMI y a un amplificador/receptor compatible con HDMI

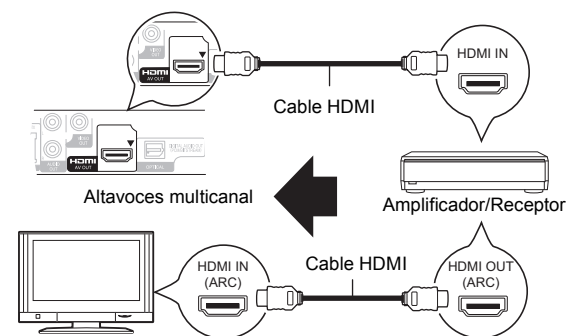

### Conecte el cable de alimentación de CA por último

A una toma de corriente doméstica



- Conéctelo cuando haya realizado el resto de conexiones.

#### Ahorro de energía

Esta unidad consume una pequeña cantidad de energía aunque esté ajustada en el modo de espera (Accionamiento rápido : Desactivado, aprox. 0,1 W). Para ahorrar energía cuando no vaya a utilizar la unidad durante mucho tiempo, desenchúfela de la toma de corriente.

## Reproducción básica

### Preparación

Encienda el televisor y seleccione la entrada de vídeo adecuada en el televisor.

- 1 Pulse [**POWER**] para encender la unidad.

Después de conectar su nuevo reproductor y pulsar el botón de encendido, aparecerá la pantalla de la configuración básica.

- 2 Inserte el medio.

### Inicia la reproducción

Pulse [**PLAY**].

### Parada

Pulse [**STOP**].

La posición de detención se memoriza.

#### Función de reanudación de la reproducción

Pulse [**PLAY**] para reiniciar la reproducción desde esta posición.

- La posición se borra si se abre la bandeja o se pulsa [**STOP**] varias veces para visualizar "STOP" en el visor de la unidad.
- En los discos BD-Video incluidos los BD-J, la función de reanudación de la reproducción no funciona.

### Pausa

Pulse [**PAUSE**].

- Pulse [**PAUSE**] otra vez o [**PLAY**] para reiniciar la reproducción.

### Búsqueda/Cámara lenta

#### Búsqueda

Durante la reproducción, pulse [**SEARCH**] o [**SEARCH**].

- Música y MP3: La velocidad está fija en un paso.

#### Cámara lenta

Durante la pausa, pulse [**SEARCH**] o [**SEARCH**].

- BD-Video y AVCHD: Sólo dirección en avance [**SEARCH**].

La velocidad aumenta hasta 5 pasos.

- Pulse [**PLAY**] para recuperar la velocidad de reproducción normal.

### Salto

Durante la reproducción o la pausa, pulse [**SKIP**] o [**SKIP**].

Salta hasta el título, capítulo o pista que desee reproducir.

- Cada pulsación aumenta el número de saltos.

# Index

<b>A</b> Audio		<b>M</b> Media Renderer	25	<b>24p</b>	28, 31
Changing audio	17	<b>N</b> Network		<b>3D</b>	20
Language	27, 29	Connection	10		
<b>B</b> BD-Live	19	Setting	13, 32		
<b>C</b> Chapter	18	<b>P</b> Playlists	18		
<b>D</b> DivX	18, 39	Pop-up menu	17		
DLNA	24	<b>Q</b> Quick Start	33		
<b>F</b> File format	39	<b>R</b> Re-master	28		
Firmware update	15	Restore Default Settings	33		
<b>L</b> LAN	10	Resume play function	17		
Language		<b>S</b> Subtitle	27		
Audio	27, 29	<b>U</b> USB device	7		
Menu	29	<b>V</b> VIERA CAST™	23		
On-screen	31	VIERA Link™			
Soundtrack	27	“HDAVI Control™”	26		
Subtitle	27, 29	<b>W</b> Wireless LAN	10		



As an ENERGY STAR® Partner,\* Panasonic has determined that this product meets the ENERGY STAR® guidelines for energy efficiency.

\* For Canada only: The word “Participant” is used in place of the word “Partner”.

### Information on Disposal in other Countries outside the European Union



This symbol is only valid in the European Union. If you wish to discard this product, please contact your local authorities or dealer and ask for the correct method of disposal.

Panasonic Consumer Electronics Company, Division of Panasonic Corporation of North America  
One Panasonic Way, Secaucus,  
New Jersey 07094  
<http://www.panasonic.com>

Panasonic Canada Inc.  
5770 Ambler Drive  
Mississauga, Ontario  
L4W 2T3  
[www.panasonic.ca](http://www.panasonic.ca)

