

Panasonic®

Operating Instructions Blu-ray Disc Player Model No. **DMP-BD85**



Dear customer

Thank you for purchasing this product.

For optimum performance and safety, please read these instructions carefully.

Before connecting, operating or adjusting this product, please read the instructions completely. Please keep this manual for future reference.



As an ENERGY STAR® Partner,*
Panasonic has determined that
this product meets the ENERGY STAR®
guidelines for energy efficiency.

* For Canada only: The word "Participant" is used in place of the word "Partner".

If you have any questions contact
U.S.A. and Puerto Rico : 1-800-211-PANA(7262)
Canada : 1-800-561-5505

U.S.A. and Puerto Rico : The warranty can be found on
page 40.
Canada : The warranty can be found on page 41.

La referencia rápida en español se puede encontrar en la página 42.

IMPORTANT SAFETY INSTRUCTIONS

Read these operating instructions carefully before using the unit. Follow the safety instructions on the unit and the applicable safety instructions listed below. Keep these operating instructions handy for future reference.

- 1 Read these instructions.
- 2 Keep these instructions.
- 3 Heed all warnings.
- 4 Follow all instructions.
- 5 Do not use this apparatus near water.
- 6 Clean only with dry cloth.
- 7 Do not block any ventilation openings. Install in accordance with the manufacturer's instructions.
- 8 Do not install near any heat sources such as radiators, heat registers, stoves, or other apparatus (including amplifiers) that produce heat.
- 9 Do not defeat the safety purpose of the polarized or grounding-type plug. A polarized plug has two blades with one wider than the other. A grounding-type plug has two blades and a third grounding prong. The wide blade or the third prong are provided for your safety. If the provided plug does not fit into your outlet, consult an electrician for replacement of the obsolete outlet.
- 10 Protect the power cord from being walked on or pinched particularly at plugs, convenience receptacles, and the point where they exit from the apparatus.
- 11 Only use attachments/accessories specified by the manufacturer.
- 12 Use only with the cart, stand, tripod, bracket, or table specified by the manufacturer, or sold with the apparatus. When a cart is used, use caution when moving the cart/apparatus combination to avoid injury from tip-over.
- 13 Unplug this apparatus during lightning storms or when unused for long periods of time.
- 14 Refer all servicing to qualified service personnel. Servicing is required when the apparatus has been damaged in any way, such as power-supply cord or plug is damaged, liquid has been spilled or objects have fallen into the apparatus, the apparatus has been exposed to rain or moisture, does not operate normally, or has been dropped.

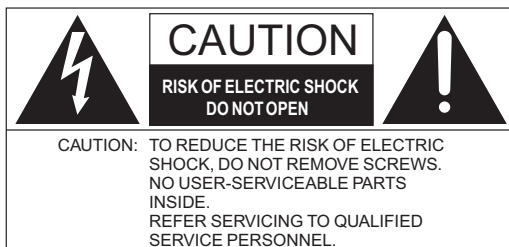

The lightning flash with arrowhead symbol, within an equilateral triangle, is intended to alert the user to the presence of uninsulated "dangerous voltage" within the product's enclosure that may be of sufficient magnitude to constitute a risk of electric shock to persons.



The exclamation point within an equilateral triangle is intended to alert the user to the presence of important operating and maintenance (servicing) instructions in the literature accompanying the appliance.

THE FOLLOWING APPLIES ONLY IN THE U.S.A.

FCC Note:

This equipment has been tested and found to comply with the limits for a Class B digital device, pursuant to Part 15 of the FCC Rules. These limits are designed to provide reasonable protection against harmful interference in a residential installation. This equipment generates, uses, and can radiate radio frequency energy and, if not installed and used in accordance with the instructions, may cause harmful interference to radio communications. However, there is no guarantee that interference will not occur in a particular installation. If this equipment does cause harmful interference to radio or television reception, which can be determined by turning the equipment off and on, the user is encouraged to try to correct the interference by one or more of the following measures:

- Reorient or relocate the receiving antenna.
- Increase the separation between the equipment and receiver.
- Connect the equipment into an outlet on a circuit different from that to which the receiver is connected.
- Consult the dealer or an experienced radio/TV technician for help.

FCC Caution: To assure continued compliance, follow the attached installation instructions and use only shielded interface cables when connecting to peripheral devices.

Any changes or modifications not expressly approved by the party responsible for compliance could void the user's authority to operate this equipment.

This device complies with Part 15 of the FCC Rules. Operation is subject to the following two conditions: (1) This device may not cause harmful interference, and (2) this device must accept any interference received, including interference that may cause undesired operation.

Responsible Party:

Panasonic Corporation of North America
One Panasonic Way
Secaucus, NJ 07094

Support Contact:

Panasonic Consumer Electronics Company
Telephone No.: 1-800-211-PANA (7262)

WARNING:

TO REDUCE THE RISK OF FIRE, ELECTRIC SHOCK OR PRODUCT DAMAGE,

● **DO NOT EXPOSE THIS APPARATUS TO RAIN, MOISTURE, DRIPPING OR SPLASHING AND THAT NO OBJECTS FILLED WITH LIQUIDS, SUCH AS VASES, SHALL BE PLACED ON THE APPARATUS.**

● **USE ONLY THE RECOMMENDED ACCESSORIES.**

● **DO NOT REMOVE THE COVER (OR BACK); THERE ARE NO USER SERVICEABLE PARTS INSIDE. REFER SERVICING TO QUALIFIED SERVICE PERSONNEL.**

CAUTION!

DO NOT INSTALL OR PLACE THIS UNIT IN A BOOKCASE, BUILT-IN CABINET OR IN ANOTHER CONFINED SPACE. ENSURE THE UNIT IS WELL VENTILATED. TO PREVENT RISK OF ELECTRIC SHOCK OR FIRE HAZARD DUE TO OVERHEATING, ENSURE THAT CURTAINS AND ANY OTHER MATERIALS DO NOT OBSTRUCT THE VENTILATION VENTS.

CAUTION!

THIS PRODUCT UTILIZES A LASER. USE OF CONTROLS OR ADJUSTMENTS OR PERFORMANCE OF PROCEDURES OTHER THAN THOSE SPECIFIED HEREIN MAY RESULT IN HAZARDOUS RADIATION EXPOSURE. DO NOT OPEN COVERS AND DO NOT REPAIR YOURSELF. REFER SERVICING TO QUALIFIED PERSONNEL.

Table of contents

Getting started

IMPORTANT SAFETY	
INSTRUCTIONS	2
Accessory	4
Unit and media care	4
Control reference guide	5
Playable discs/Cards/ USB devices	6

Connections & Settings

STEP 1 : Connecting to a TV	8
STEP 2 : Connecting to an amplifier/receiver	9
STEP 3 : Connecting to a broadband network	10
STEP 4 : Connecting to an AC power	11
STEP 5 : Setting	12
STEP 6 : Reprogramming the remote control	14

Playback

Inserting or removing a media	15
FUNCTIONS menu	15
Playing video contents	16
Playing still pictures	20
Playing music	21
Linked operations with the TV (VIERA Link™ "HDAVI Control™")	22
Enjoying VIERA CAST™	23

Settings

Playback menu	24
Setup menu	26

Reference

Troubleshooting guide	30
Messages	32
Audio Information	33
About MP3/JPEG/DivX/ AVCHD/MPEG2 files	35
Specifications	37
Supplemental information	38
Glossary	39
Limited Warranty (ONLY FOR U.S.A. AND PUERTO RICO)	40
Limited Warranty (Only for CANADA)	41
Referencia rápida en español (Spanish Quick Reference)	42
Index	Back cover

About descriptions in these operating instructions

- Instructions for operations are generally described using the remote control.

About Firmware updates (⇒ 14)

Accessory

Check the supplied accessories before using this unit.

- 1 **Remote control**
(N2QAQB000076)
- 1 **Audio/Video cable**
(K2KA6BA00004)
- 2 **Batteries for remote control**
- 1 **AC power supply cord**
(K2CB2CB00022)
- 1 **Wireless LAN Adaptor (DY-WL10)**
(C5ZZZ0000048)
- 1 **USB extension cable**
(K2KYYYY00064)

(ONLY FOR CANADA)

The enclosed Canadian French label sheet corresponds to the English display on the front and back side of the unit.



- Product numbers correct as of December 2009. These may be subject to change.
- Do not use AC power supply cord and Wireless LAN Adaptor with other equipment.
- Only for U.S.A. and Puerto Rico: To order accessories, refer to "Accessory Purchases (United States and Puerto Rico)" on page 40. For other areas: To order accessories, call the dealer from whom you have made your purchase.

Using the remote control

Insert so the poles (+ and -) match those in the remote control.

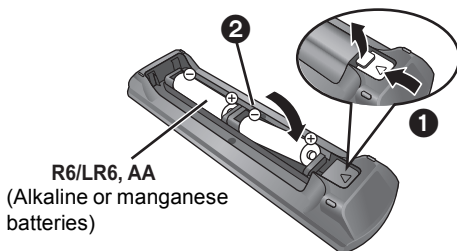

Point it at remote control signal sensor on this unit. (⇒ 5)



Mishandling of batteries can cause electrolyte leakage which can damage items the fluid contacts and may cause a fire.

- Do not mix old and new batteries or different types at the same time.
- Do not heat or expose to flame.
- Do not leave the battery(ies) in an automobile exposed to direct sunlight for a long period of time with doors and windows closed.
- Do not take apart or short circuit.
- Do not attempt to recharge alkaline or manganese batteries.
- Do not use batteries if the covering has been peeled off.

Remove batteries if the remote control is not going to be used for a long period of time. Store in a cool, dark place

CAUTION

Danger of explosion if battery is incorrectly replaced. Replace only with the same or equivalent type recommended by the manufacturer. Dispose of used batteries according to the manufacturer's instructions.

Unit and media care

■ Clean this unit with a soft, dry cloth

- Never use alcohol, paint thinner or benzine to clean this unit.
- Before using chemically treated cloth, carefully read the instructions that came with the cloth.

■ Clean the lens with the lens cleaner disc

Lens cleaner disc: RP-CL720PP (not included)

- This lens cleaner is sold as specific for DIGA, but can be used on this unit as well.

■ Clean discs

DO



DO NOT



Wipe with a damp cloth and then wipe dry.

■ Disc and card handling precautions

- Handle discs by the edges to avoid inadvertent scratches or fingerprints on the disc.
- Do not attach labels or stickers to discs.
- Do not use record cleaning sprays, benzene, thinner, static electricity prevention liquids or any other solvent.
- Clean any dust, water, or foreign matter from the terminals on the rear side of the card.
- Do not use the following discs:
 - Discs with exposed adhesive from removed stickers or labels (rented discs etc).
 - Discs that are badly warped or cracked.
 - Irregularly shaped discs, such as heart shapes.

■ To dispose or transfer this unit

The unit may keep the user settings information in the unit. If you discard this unit either by disposal or transfer, then follow the procedure to return all the settings to the factory presets to delete the user settings. (⇒30, "To return all settings to the factory preset.")

- The operation history may be recorded in the memory of this unit.

Control reference guide

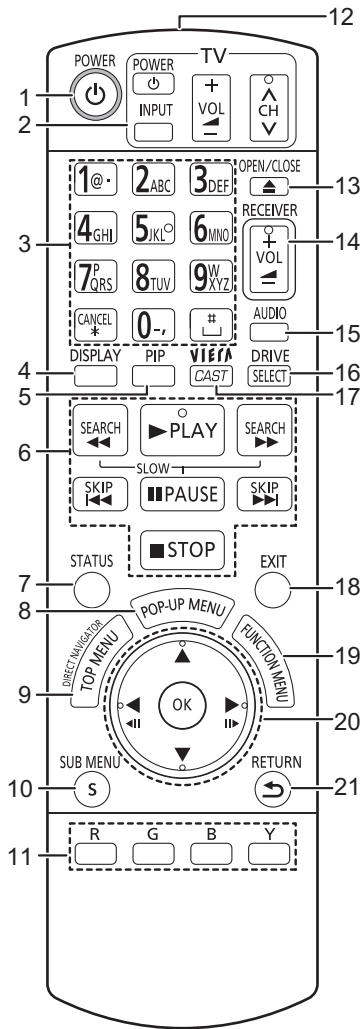

- 1 Turn the unit on and off (⇒ 12)
- 2 TV operation buttons (⇒ 14)
You can operate the TV through the unit's remote control.
[TV POWER] : Turn the television on and off
[INPUT] : Input select
[+ - VOL] : Adjust the volume
[^ v CH] : Channel select
- 3 Select title numbers, etc./Enter numbers or characters (⇒ 23)
[CANCEL] : Cancel
- 4 Show playback menu (⇒ 24)
- 5 Switch on/off Secondary Video (Picture-in-picture) (⇒ 18)
- 6 Basic playback control buttons (⇒ 16)
- 7 Show status messages (⇒ 16)
- 8 Show Pop-up menu (⇒ 16)
- 9 Show Top menu/Direct Navigator (⇒ 16)
- 10 Show sub menu (⇒ 17)
- 11 These buttons are used when;
 - Operating a BD-Video disc that includes Java™ applications (BD-J).
 - Displaying "Title View" and "Album View" screens. (⇒ 20)
 - Operating contents of VIERA CAST. (⇒ 23)
- 12 Transmit the remote control signal
- 13 Open or close the disc tray (⇒ 15)
CAUTION
Do not place objects in front of the unit. The disc tray may collide with objects when it is opened, and this may cause injury.
- 14 Adjust the volume of an amplifier/receiver.
- 15 Select audio (⇒ 16)
- 16 Select drive (BD/DVD/CD, SD card or USB device) (⇒ 15)
- 17 Displays the Home screen of the VIERA CAST (⇒ 23)
- 18 Exit the menu screen
- 19 Show FUNCTIONS menu (⇒ 15)
- 20 Selection/OK, Frame-by-frame (⇒ 16)
- 21 Return to previous screen

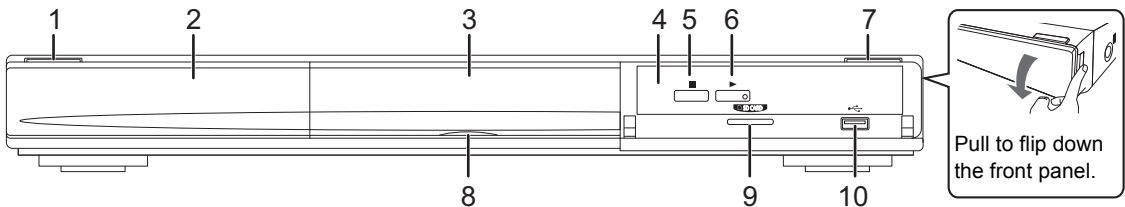









- 1 **POWER button** (POWER /I) (⇒ 23)
Press to switch the unit from on to standby mode or vice versa. In standby mode, the unit is still consuming a small amount of power.
 - 2 **Display**
- | | | |
|----------------|-------------------|----------------------|
| | SD | USB |
| Disc indicator | SD card indicator | USB device indicator |
- The indicator blinks when reading data from a disc, a card or a USB device, or writing data to a card.
- 3 **Disc tray** (⇒ 15)

- 4 **Remote control signal sensor**
Distance: Within approx. 7 m (23 feet)
Angle: Approx. 20° up and down, 30° left and right
- 5 **Stop** (⇒ 16)
- 6 **Start play** (⇒ 16)
- 7 **Open or close the disc tray** (⇒ 15)
- 8 **SD Card LED**
 - It is possible to set the LED to turn on/off. (⇒ 28)
- 9 **SD card slot** (⇒ 15)
- 10 **USB port** (⇒ 15)

Rear panel terminals (⇒ 8–11)

Playable discs/Cards/USB devices

Type	Logo examples	Type detail	Playable contents
BD		BD-Video	Video
		BD-RE	Video JPEG
		BD-R	Video DivX®
DVD		DVD-Video	Video
		DVD-RAM	Video AVCHD JPEG
		DVD-R	Video AVCHD DivX MP3 JPEG
		DVD-R DL	
		DVD-RW	Video AVCHD
	—	+R/+RW/+R DL	
CD		Music CD	Music [CD-DA]
	—	CD-R CD-RW	DivX Music [CD-DA] MP3 JPEG
SD		SD Memory Card (8 MB to 2 GB) (Includes miniSD Card and microSD Card) SDHC Memory Card (4 GB to 32 GB) (Includes microSDHC Card) SDXC Memory Card (48 GB, 64 GB) (Includes microSDXC Card)	MPEG2 AVCHD JPEG
USB	—	USB devices (up to 128 GB)	DivX MP3 JPEG

■ Discs that cannot be played in this unit

Any other disc that is not specifically supported or previously described.

- 2.6 GB and 5.2 GB DVD-RAM
- DVD-RAM that cannot be removed from cartridge
- Super Audio CD
- Photo CD
- DVD-Audio
- Video CD and Super Video CD
- WMA discs
- PAL discs
- HD DVD
- BD-Video discs recorded at a rate of 50 fields/sec

■ Region management information

BD-Video

This unit plays BD-Video marked with labels containing the region code A.

Example:



DVD-Video

This unit plays DVD-Video marked with labels containing the region number "1" or "ALL".

Example:



■ Finalize

DVD-R/RW/R DL, +R/+RW/+R DL and CD-R/RW recorded by a recorder, etc. needs to be finalized by the recorder to play on this unit. Please refer to the recorder's instructions.

■ BD-Video

This unit supports high bit rate audio (Dolby Digital Plus, Dolby TrueHD, DTS-HD High Resolution Audio and DTS-HD Master Audio) adopted in BD-Video. In order to enjoy these audio formats, refer to page 33.

■ Music CD

- Operation and sound quality of CDs that do not conform to CD-DA specifications (copy control CDs, etc.) cannot be guaranteed.
- The digital audio content side of a DualDisc does not meet the technical specifications of the Compact Disc Digital Audio (CD-DA) format so playback may not be possible.

■ SD card

- MiniSD Cards, microSD Cards, microSDHC Cards and microSDXC Cards can be used, but must be used with an adaptor card. These are usually supplied with such cards, or otherwise customer provided.
- Keep the Memory Card out of reach of children to prevent swallowing.
- To protect the card's contents, move the record prevention tab (on the SD card) to "LOCK".
- This unit is compatible with SD Memory Cards that meet SD Card Specifications FAT12 and FAT16 formats, as well as SDHC Memory Cards in FAT32 format (Does not support long file name.) and SDXC Memory Cards in exFAT.
- If the SD card is used with incompatible computers or devices, recorded contents may be erased due to the card being formatted etc.
- Useable memory may be slightly less than the card capacity.



■ USB device

- This unit supports connecting a USB memory, digital camera and video camera produced by Panasonic, etc. It is not warranted that all USB devices will work with this unit.
- This unit does not support USB device charging.
- FAT12, FAT16 and FAT32 file systems are supported.
- This unit supports USB 2.0 High Speed.



- It may not be possible to play the above media in some cases due to the type of media, the condition of the recording, the recording method and how the files were created.
- The producers of the disc can control how discs are played, so you may not always be able to control play as described in these operating instructions. Read the disc's instructions carefully.

STEP 1 : Connecting to a TV

- Do not place the unit on amplifiers/receivers or equipment that may become hot. The heat can damage the unit.
- Before making any connections we suggest you temporarily disconnect all the units from AC power.
- Do not connect video signals through a video recorder. Due to copy guard protection the picture may not be displayed properly.
- Refer to page 34, about recommended settings for each piece of connected equipment.
- Please use High Speed HDMI Cables that have the HDMI logo (as shown on the cover). It is recommended that you use Panasonic's HDMI cable. When outputting 1080p signal, please use HDMI cables 5.0 meters (16.4 ft) or less. Recommended part number: RP-CDHS15 (1.5 m/4.9 ft.), RP-CDHS30 (3.0 m/9.8 ft.), RP-CDHS50 (5.0 m/16.4 ft.), etc.

Highest Quality
(VIDEO)

Standard Quality
(VIDEO)

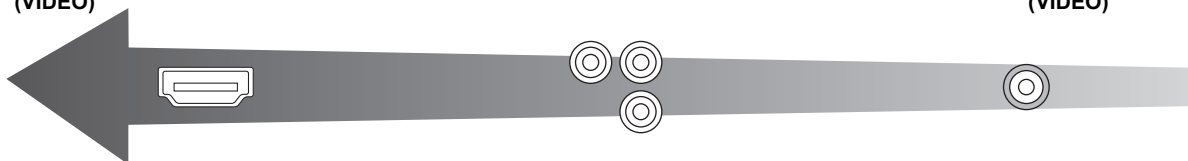

■ Via an HDMI AV OUT terminal

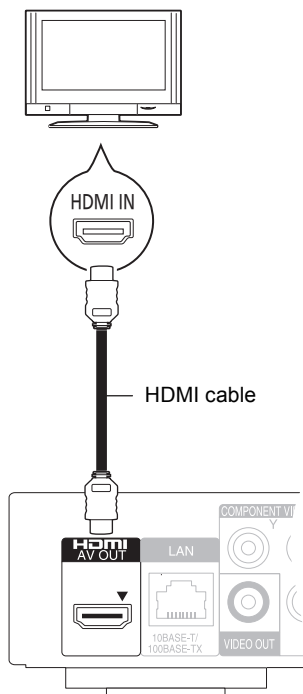

- The HDMI connection supports VIERA Link "HDAVI Control" (⇒ 22) when used with a compatible Panasonic TV.
- Set "HDMI Video Mode" and "HDMI Audio Output" to "On" (⇒ 28).

■ Via a COMPONENT VIDEO OUT terminal

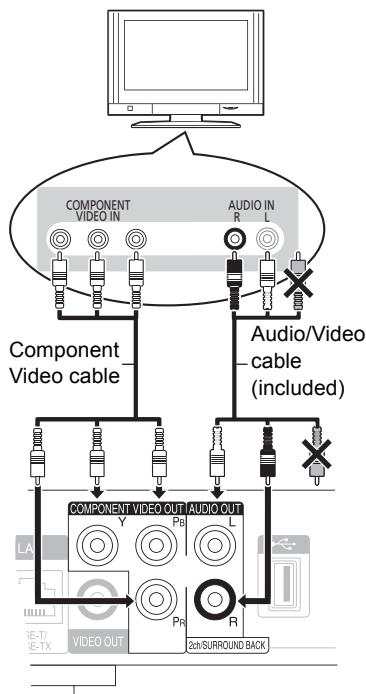

- Connect terminals of the same color.
- Set "Component Video Resolution" to "480p", "720p" or "1080i" (⇒ 28).
- Set "HDMI Video Mode" to "Off" (⇒ 28).

■ Via a VIDEO OUT terminal

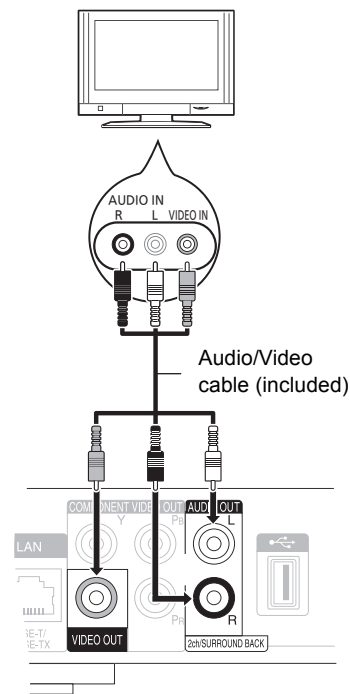

- Connect terminals of the same color.

STEP 2 : Connecting to an amplifier/receiver

Digital Audio

■ Via an HDMI AV OUT terminal

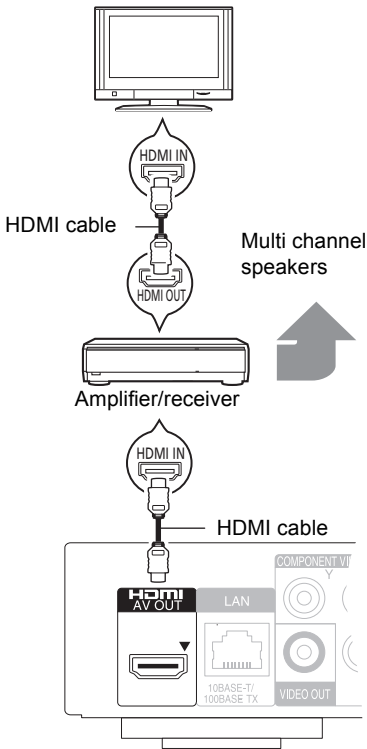

- The HDMI connection supports VIERA Link “HDAVI Control” (⇒ 22) when used with a compatible Panasonic TV.
- Set “HDMI Video Mode” and “HDMI Audio Output” to “On” (⇒ 28).
- Set “Digital Audio Output” depending on the used terminal and connected amplifier/receiver (⇒ 27).

■ Via a COAXIAL or OPTICAL terminal

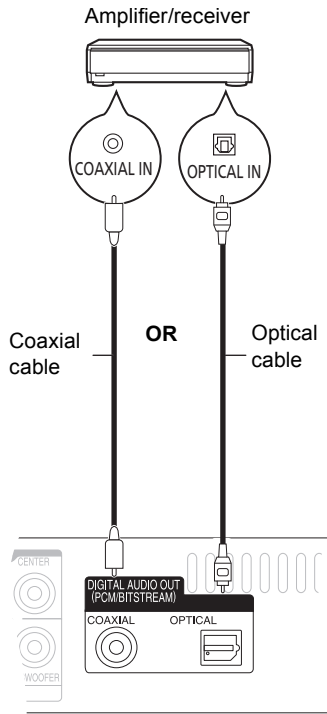

- When connecting a TV (⇒ 8) with HDMI AV OUT terminal, set “HDMI Audio Output” to “Off” (⇒ 28).
- Set “Digital Audio Output” depending on the used terminal and connected amplifier/receiver (⇒ 27).

Analog Audio

■ Via a 5.1/7.1ch AUDIO OUT terminal

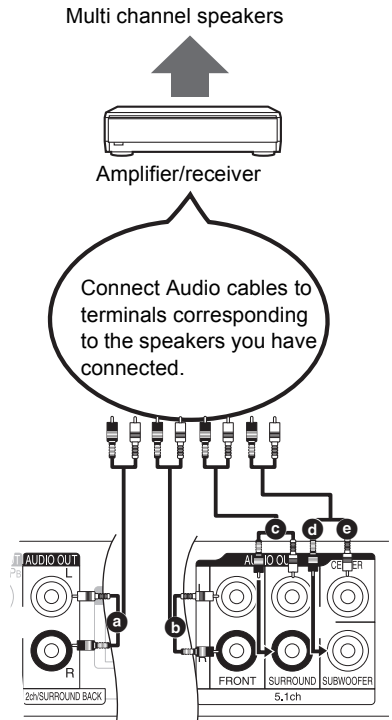

Cable connections

- a** Surround back speaker (L/R) (Only for 7.1ch AUDIO OUT)
 - b** Front speaker (L/R)
 - c** Surround speaker (L/R)
 - d** Subwoofer
 - e** Center speaker
- Set the “Analog Audio Output” to “7.1ch” or “2ch (Downmix) + 5.1ch”, depending on the used terminal (⇒ 28).
 - You can set the “Analog Audio Output” from the easy setting (⇒ 12).
 - When connecting equipment with HDMI AV OUT terminal, set “HDMI Audio Output” to “Off” (⇒ 28).

STEP 3 : Connecting to a broadband network

The following services can be used when this unit is connected to broadband.

- Firmware can be updated (⇒ 14)
- You can enjoy BD-Live (⇒ 18)
- You can enjoy VIERA CAST (⇒ 23)

■ Using LAN (ethernet) cable

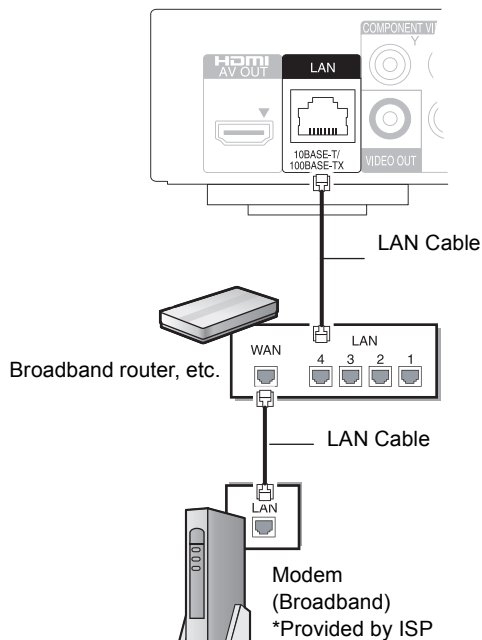

- Use shielded LAN cables when connecting to peripheral devices.
- Inserting any cable other than a LAN cable in the LAN terminal can damage the unit.

For details about connection method, refer to the instructions supplied with the connected equipment.

- It may not work properly depending on the equipment or environment used.

■ Using Wireless LAN Adaptor (DY-WL10)

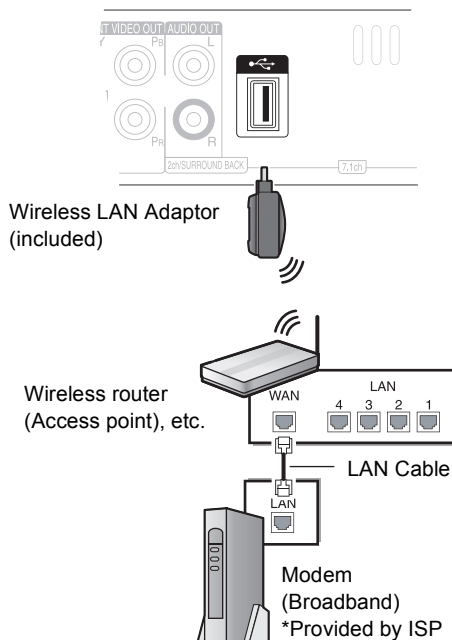

- Wireless LAN Adaptors other than the included Wireless LAN Adaptor cannot be used.
- When connection conditions are poor, use the included USB extension cable to connect the Wireless LAN Adaptor provided with this unit.
- Do not use any other USB extension cables except the supplied one.
- For up to date compatibility information on your Wireless router (Access Point) refer to <http://panasonic.co.jp/pavc/global/cs>
For additional information about this unit refer to <http://www.panasonic.com/consumer/support>

Precautions of Wireless LAN Adaptor

The following limits are in place regarding the usage of this device. You must be aware of these limits before using this device.

Panasonic will in no way be responsible for any incidental damage which may arise due to a failure to obey these limits, or to any condition of use or disuse of this device.

- **This device is to be used as a wireless LAN device.**
- **Do not use this device to connect to any wireless network for which you do not have usage rights.**

During automatic searches in a wireless network environment, wireless networks (SSID*) for which you do not have usage rights may be displayed; however, using these networks may be regarded as illegal access.

* An SSID (Service Set IDentification) is a name used by wireless LAN to identify a particular network. Transmission is possible if the SSID matches for both devices.

- **Data transmitted and received over radio waves may be intercepted and monitored.**
- **This wireless LAN adaptor contains delicate electronic components.** Please use this adaptor in the manner in which it was intended and follow the following points:
 - Do not expose the adaptor to high temperatures or direct sunlight.
 - Do not bend, or subject the adaptor to strong impacts.
 - Keep the adaptor away from moisture.
 - Do not disassemble or alter the adaptor in any way.
 - Do not attempt to install the adaptor in any incompatible device.

STEP 4 : Connecting to an AC power

THE FOLLOWING APPLIES IN THE U.S.A. AND CANADA.

This device complies with Part 15 of FCC Rules and RSS-Gen of IC Rules. Operation is subject to the following two conditions:
 (1) This device may not cause interference, and (2) this device must accept any interference, including interference that may cause undesired operation of this device.

This transmitter must not be co-located or operated in conjunction with any other antenna or transmitter.

This product is restricted to indoor use due to its operation in the 5.15 to 5.25 GHz frequency range.

FCC and IC require this product to be used indoors for the frequency range 5.15 to 5.25 GHz to reduce the potential for harmful interference to co-channel Mobile Satellite systems. High power radars are allocated as primary users of the 5.25 to 5.35 GHz and 5.65 to 5.85 GHz bands. These radar stations can cause interference with and/or damage this product.

The available scientific evidence does not show that any health problems are associated with using low power wireless devices.

There is no proof, however, that these low power wireless devices are absolutely safe.

Low power Wireless devices emit low levels of radio frequency energy (RF) in the microwave range while being used. Whereas high levels of RF can produce health effects (by heating tissue), exposure to low-level RF that does not produce heating effects causes no known adverse health effects.

Many studies of low-level RF exposures have not found any biological effects. Some studies have suggested that some biological effects might occur, but such findings have not been confirmed by additional research. Wireless LAN adaptor (DY-WL10) has been tested and found to comply with FCC/IC radiation exposure limits set forth for an uncontrolled equipment and meets the FCC radio frequency (RF) Exposure Guidelines in Supplement C to OET65 and RSS-102 of the IC radio frequency (RF) Exposure rules.

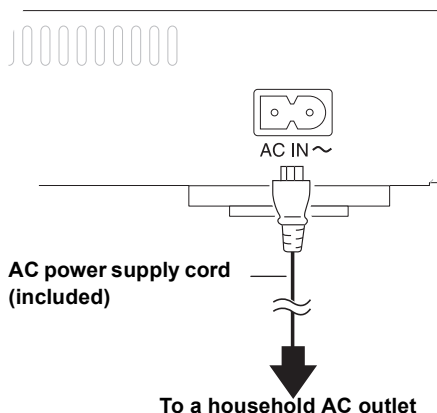

- This unit consumes a small amount of AC power ("Quick Start": "Off", less than 0.1 W) even when turned off. In the interest of power conservation, if you will not be using this unit for an extended period of time, it can be disconnected.

The socket outlet shall be installed near the equipment and easily accessible. The mains plug of the power supply cord shall remain readily operable.
 To completely disconnect this apparatus from the AC Mains, disconnect the power supply cord plug from AC receptacle.

THE FOLLOWING APPLIES ONLY IN THE U.S.A.

FCC Note:

This equipment has been tested and found to comply with the limits for a Class B digital device, pursuant to Part 15 of the FCC Rules. These limits are designed to provide reasonable protection against harmful interference in a residential installation. This equipment generates, uses and can radiate radio frequency energy and, if not installed and used in accordance with the instructions, may cause harmful interference to radio communications.

However, there is no guarantee that interference will not occur in a particular installation. If this equipment does cause harmful interference to radio or television reception, which can be determined by turning the equipment off and on, the user is encouraged to try to correct the interference by one or more of the following measures:

- Reorient or relocate the receiving antenna.
- Increase the separation between the equipment and receiver.
- Connect the equipment into an outlet on a circuit different from that to which the receiver is connected.
- Consult the dealer or an experienced radio/TV technician for help.

FCC caution: To maintain compliance with FCC regulations, shielded interface cables must be used with this equipment. Operation with non-approved equipment or unshielded cables may result in interference to radio and TV reception. Any changes or modifications not approved by the party responsible for compliance could void the user's authority to operate this equipment.

This device complies with Part 15 of the FCC Rules. Operation is subject to the following two conditions:

- (1) This device may not cause harmful interference, and
- (2) this device must accept any interference received, including interference that may cause undesired operation.

Responsible Party:

Panasonic Corporation of North America
 One Panasonic Way
 Secaucus, NJ 07094

Support Contact:

Panasonic Consumer Electronics Company
 Telephone No.: 1-800-211-PANA (7262)

THE FOLLOWING APPLIES ONLY IN CANADA.

This Class B digital apparatus complies with Canadian ICES-003.

Product Identification Marking is located on the bottom of unit.

STEP 5 : Setting

Easy Setting

After connecting your new player for the 1st time and pressing the power button, a screen for the basic settings will appear.

Preparation

Turn on the television and select the appropriate video input on the television.

1 Press [POWER].

Setup screen appears.

If this unit is connected to a Panasonic TV (VIERA) supporting HDAVI Control 2 or later via an HDMI cable, then the setting information on the TV is acquired by this TV.

2 Follow the on-screen instructions and make the settings with [▲, ▼] and press [OK].

After completing "Easy Setting", you can perform "Network Easy Setting".



- You can perform this setup anytime by selecting "Easy Setting" in the Setup menu. (⇒ 29)
- Initial setting is set to "2ch (Downmix) + 5.1ch", so you will need to select "7.1ch" if using the 7.1ch output.

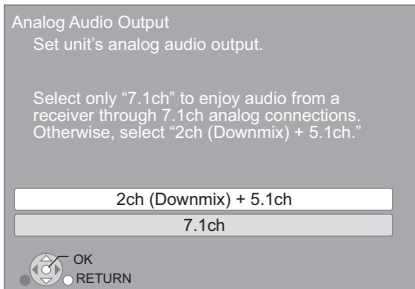

Network Easy Setting

After completing "Easy Setting", you can continuously perform "Network Easy Setting".

- Before you perform the wireless network settings on this unit, confirm the set up of your Wireless router (Access point) is done correctly on your PC.

1 Select "Wired" or "Wireless" and press [OK].

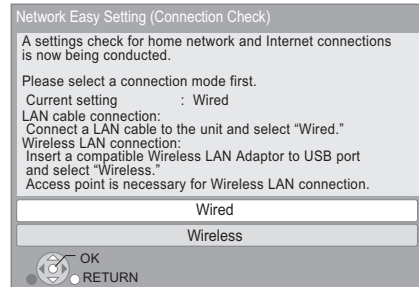

2 Follow the on-screen instructions and make the settings with [▲, ▼, ◀, ▶] and press [OK].

For wireless LAN connection:

If you are using a Wireless router (Access point) that supports WPS, you can easily perform the settings by selecting "WPS (PUSH button method)".

Otherwise, perform the settings by selecting "Search for access point" or "Manual setting" in "Other methods".

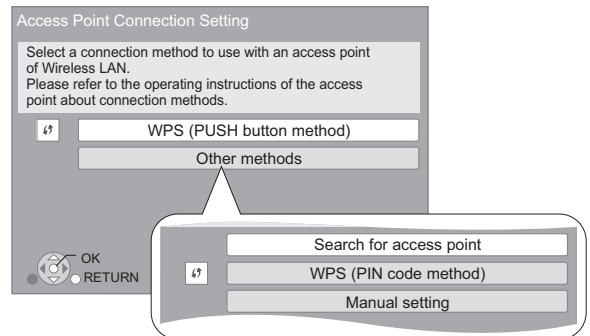

- WPS (Wi-Fi Protected Setup) is a function that facilitates settings relating to the connection and security of wireless LAN devices. To see whether your Wireless router (Access point) supports WPS, check the Wireless router operating instructions.

When you experience problems with settings

Access Point Connection Setting

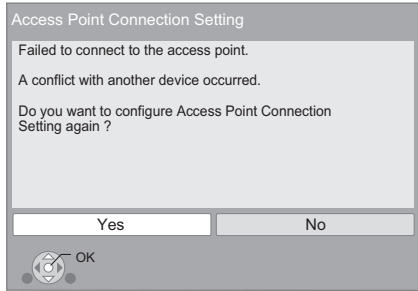

Display	Check the following
A conflict with another device occurred.	<ul style="list-style-type: none"> Please wait a few moments, and then try again.
A time out error occurred.	<ul style="list-style-type: none"> Setting of the Wireless router (Access point) for MAC Address etc. The signal may be weak. Using the included USB extension cable, adjust the position of the Wireless LAN Adaptor. The SSID and the encryption key of the Wireless router (Access point). Please wait a few moments, and then try again.
An authentication error or a time out error occurred.	
A device error occurred.	<ul style="list-style-type: none"> Connection of Wireless LAN Adaptor If there is no improvement in symptom, contact our Customer Service Center.

Network Easy Setting (Connection Check)

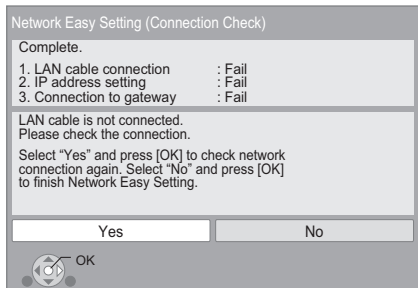

Display	Check the following
1. LAN cable connection or Connection to access point : Fail	<ul style="list-style-type: none"> Connection of the LAN cables (⇒ 10)
2. IP address setting : Fail	
3. Connection to gateway : Fail	

1. LAN cable connection or Connection to access point : Pass	<ul style="list-style-type: none"> Connection and settings of the hub and router Settings of "IP Address/DNS Settings" (⇒ 29)
2. IP address setting : Fail	
3. Connection to gateway : Fail	
1. LAN cable connection or Connection to access point : Pass	
2. IP address setting : Pass	
3. Connection to gateway : Fail	

Network Easy Setting (Internet Connection Check)

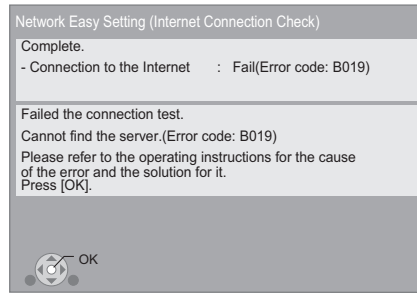

Display	Check the following
Cannot find the server. (Error code: B019)	<ul style="list-style-type: none"> Settings of "IP Address/DNS Settings" (⇒ 29)
Failed to connect to the server. (Error code: B020)	<ul style="list-style-type: none"> The server may be busy or the service may have been suspended. Please wait a few moments, and then try again. Settings of "Proxy Server Settings" (⇒ 29) and the router



- Refer to the operating instructions of the hub or router.
- You can perform this setup anytime by selecting "Network Easy Setting" in the Setup menu. (⇒ 29)
- You can redo these settings individually using "Network Settings". (⇒ 29)
- If you experience problems after selecting "Wireless", you should first confirm the setting of your Wireless router (Access point) connected to your home network using your PC.**
- After performing network settings on this unit, the settings (encryption level, etc.) of the Wireless router (Access point) might change. When you have trouble getting online on your PC, perform the network settings on your PC in accordance with the settings of Wireless router (Access point).

Firmware updates

Occasionally, Panasonic may release updated firmware for this unit that may add or improve the way a feature operates. These updates are available free of charge.

This unit is capable of checking the firmware automatically when connected to the Internet via a broadband connection. When a new firmware version is available, the following screen is displayed.



DO NOT DISCONNECT the unit from the AC power or perform any operation while the update takes place. After the firmware is installed, "FINISH" will be displayed on the unit's display. Unit will restart and the following screen will be displayed.

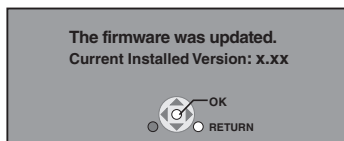

- You can perform update anytime by selecting "Firmware Update" in the Setup menu. (⇒ 29)
- **If downloading on this unit fails or this unit is not connected to the Internet, then you can download the latest firmware from the following website and burn it to a CD-R to update the firmware.**
<http://panasonic.co.jp/pavc/global/cs>
(This site is in English only.)
To show the firmware version on this unit. (⇒29, "System Information")
- Downloading will require several minutes. It may take longer or the Internet may not be connected depending on the connection environment.
- If you do not want to check for the latest firmware version, set "Automatic Update Check" to "Off". (⇒ 29)

STEP 6 : Reprogramming the remote control

For other Panasonic products

Change "Remote Control Code" (⇒ 29) on the main unit and the remote control (the two must match) if you place other Panasonic products close together and it responds to this remote control.

For TV or amplifier/receiver

You can operate the TV or amplifier/receiver using the unit's remote control.

1 For televisions

Input the code (⇒ 38) with the numbered buttons while pressing [TV POWER].

For amplifiers/receivers

Input the code (⇒ 38) with the numbered buttons while pressing [RECEIVER – VOL].

e.g., 0001: [0] ⇒ [0] ⇒ [0] ⇒ [1]

2 Test by turning on the television or adjusting the volume of the amplifier/receiver.



- If your television or amplifier/receiver brand has more than one code listed, select the one that allows correct operation.

Inserting or removing a media

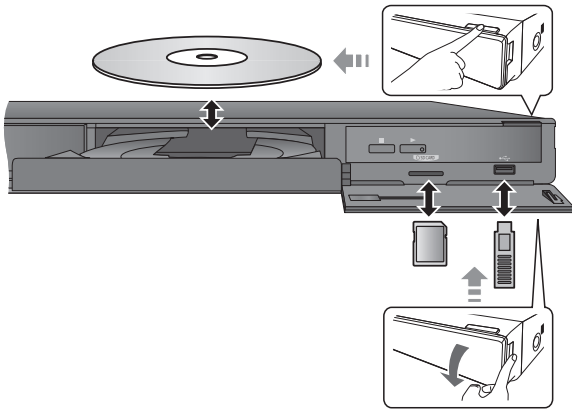

- When inserting a media, ensure that it is facing the right way up.
- When indicator on this unit's display blinks, do not turn off the unit or remove the media. Such action may result in loss of the media's contents.
- When removing the SD card, press on the center of the card and pull it straight out.
- If you connect a Panasonic product with a USB connection cable, setup screen may be displayed on connected equipment. For details, refer to the instructions for the connected equipment.

■ To switch drives

Press [DRIVE SELECT] to select "BD/DVD/CD", "SD card" or "USB device".

- If a media is inserted while the unit is stopped, the drive switches automatically depending on the inserted media.

FUNCTIONS menu

Major functions of this unit can be operated from the FUNCTIONS menu.

Press [**▲**, **▼**] to select the item and press [OK].



Playback	Play back the contents.	
Top Menu	(⇒ 16)	
Menu	(⇒ 16)	
Viewing Picture	(⇒ 20)	
Viewing Video	(⇒ 16)	
Listening Music	(⇒ 21)	
Network	Displays the Home screen of the VIERA CAST (⇒ 23)	
BD/DVD/CD	Switches to each drive.	
SD Card		
USB device		
Other Functions	Playlists	You can play playlists created on DVD-VR.
	Setup	(⇒ 26)
	Card Management	(⇒ 18)

To exit the screen

Press [FUNCTION MENU].



- Items to be displayed may vary with the media.
- If FUNCTIONS screen is not displayed, press [FUNCTION MENU].

Playing video contents

BD DVD CD SD USB

Preparation

Turn on the television and select the appropriate video input on the television.

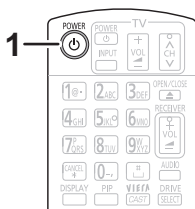

1 Press [POWER] to turn on the unit.

2 Insert the media.

Play starts.

- If the menu is displayed, press [▲], [▼], [◀], [▶] to select the item and press [OK].
- If play does not start, press [▶] (PLAY).

■ To show menus

You can show Top Menu, Direct Navigator or Pop-up Menu. Press [TOP MENU/DIRECT NAVIGATOR] or [POP-UP MENU].

- Press [▲], [▼], [◀], [▶] to select the item and press [OK].
- Pop-up menu also appears by pressing [SUB MENU] and selecting "Pop-up Menu".

■ To show the status messages

While playing, press [STATUS].

The status messages give you information about what is currently being played. Each time you press [STATUS], the information displayed will change.

e.g. BD-Video

T: Title, C: Chapter, PL: Playlist

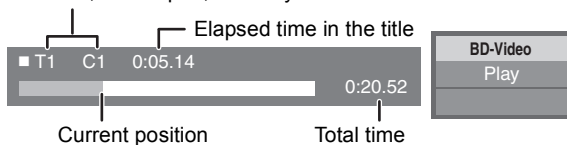

- DISCS CONTINUE TO ROTATE WHILE MENUS ARE DISPLAYED. Press [■] when you finish to preserve the unit's motor and your television screen.
- Depending on media and contents, the display may change or may not appear.
- DivX: Successive play is not possible.
- It is not possible to playback AVCHD and MPEG2 video which have been dragged and dropped, copied and pasted to the media.

Other operations during play

These functions may not work depending on the media and contents.

Stop

Press [■].

The stopped position is memorized.

Resume play function

Press [▶] (PLAY) to restart from this position.

- The position is cleared if the tray is opened or you press [■] several times to display "STOP" on unit's display.
- On BD-Video discs including BD-J (⇒ 39), the resume play function does not work.

Pause

Press [⏸].

- Press [⏸] again or [▶] (PLAY) to restart play.

Search/Slow-motion

Search

While playing, press [◀◀] or [▶▶].

- Music and MP3: The speed is fixed to a single step.

Slow-motion

While paused, press [◀◀] or [▶▶].

- BD-Video and AVCHD: Forward direction [▶▶] only.

The speed increases up to 5 steps.

- Press [▶] (PLAY) to revert to normal playback speed.

Skip

While playing or paused, press [◀◀] or [▶▶].

Skip to the title, chapter or track you want to play.

- Each press increases the number of skips.

Frame-by-frame

While paused, press [◀] (◀◀) or [▶] (▶▶).

- Press and hold to change in succession forward or backward.
- Press [▶] (PLAY) to revert to normal playback speed.
- BD-Video and AVCHD: Forward direction [▶] (▶▶) only.

Changing audio

Press [AUDIO].

You can change the audio channel number or soundtrack language (⇒ 24), etc.

Useful functions

- 1 Press [SUB MENU].
- 2 Select an item, then press [OK].

While Direct Navigator screen is displayed

Properties	To display the titles properties (recording date, etc.)
View Chapters	To select the chapter
To picture	Playing still pictures (⇒ 20)
Select Folder	To switch to another folder

While playing

Screen Aspect	When black bars are shown at the top, bottom, left, and right sides of the screen, you can enlarge the image to fill the screen.
Top Menu	To display Top Menu.
Pop-up Menu	To display Pop-up Menu.
Menu	To display Menu.

- Depending on the played contents if you perform “Screen Aspect”, there may be not effect.
- When “TV Aspect” (⇒ 28) is set to “4:3 Pan & Scan” or “4:3 Letterbox”, the “Zoom” effect in “Screen Aspect” is disabled.



- Depending on the media and contents, displayed items are different.

Enjoying BD-Live or BONUSVIEW in BD-Video

What is BONUSVIEW?

BONUSVIEW allows you to enjoy functions such as picture-in-picture or secondary audio etc.

What is BD-Live?

In addition to the BONUSVIEW function, BD-Live allows you to enjoy more functions such as subtitles, exclusive images and online games by connecting this unit to the Internet.

- The usable functions and the operating method may vary with each disc, please refer to the instructions on the disc and/or visit their website.

Playing picture-in-picture

To turn on/off secondary video

Press [PIP].

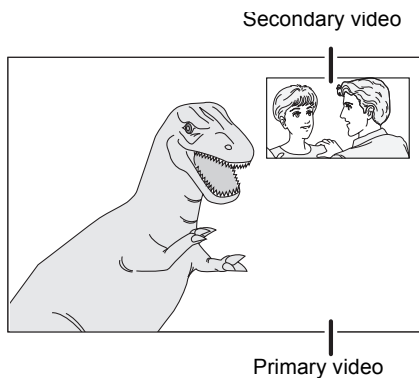

To turn on/off secondary audio

[DISPLAY] ⇒ select "Disc" ⇒ [▶] ⇒ select "Signal Type" ⇒ [OK] ⇒ set "Soundtrack" in "Secondary Video" to "On" or "Off"



- During search/slow-motion or frame-by-frame, only the primary video is displayed.
- When "BD-Video Secondary Audio" in "Digital Audio Output" is set to "Off", secondary audio will not be played (⇒ 27).

Enjoying BD-Live discs with Internet

Some BD-Live content available on the Blu-ray discs may require an Internet account to be created in order to access the BD-Live content. Follow the screen display or instruction manual of the disc for information on acquiring an account.

1 Connect to the network. (⇒ 10)

2 Insert an SD card (with 1 GB or more free space).

SD card is used as the local storage (⇒ 39).

3 Insert the disc.

■ Deleting data/Formatting SD cards

- ① Insert an SD card.
- ② Press [FUNCTION MENU].
- ③ Press [▲, ▼] to select "Other Functions" and press [OK].
- ④ Press [▲, ▼] to select "Card Management" and press [OK].
- ⑤ Press [▲, ▼] to select "BD-Video Data Erase" or "Format SD Card" and press [OK].

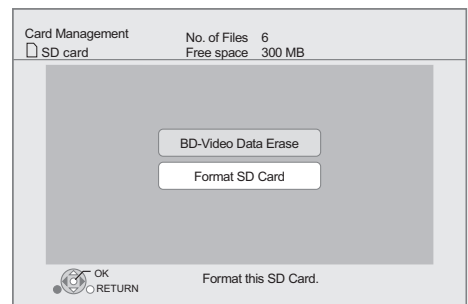

- ⑥ Press [◀, ▶] to select "Yes" and press [OK].
- ⑦ Press [◀, ▶] to select "Start" and press [OK].



- To use the above functions, it is recommended that you format the card on this unit. If the SD card you use is formatted, all data on the card will be erased. It cannot be recovered.
- "BD-Live Internet Access" may need to be changed for certain discs (⇒ 26).
- When discs supporting BD-Live are played back, the player or disc IDs may be sent to the content provider via the Internet.

Regarding DivX

ABOUT DIVX VIDEO:

DivX® is a digital video format created by DivX, Inc. This is an official DivX Certified device that plays DivX video. Visit www.divx.com for more information and software tools to convert your files into DivX video.

ABOUT DIVX VIDEO-ON-DEMAND:

This DivX Certified® device must be registered in order to play DivX Video-on-Demand (VOD) content.

To generate the registration code, locate the DivX VOD section in the device setup menu.

Go to vod.divx.com with this code to complete the registration process and learn more about DivX VOD.

- It is not possible to playback DivX VOD content recorded on the USB device.

Display the unit's registration code.

(⇒ 29, "DivX Registration" in "Others")

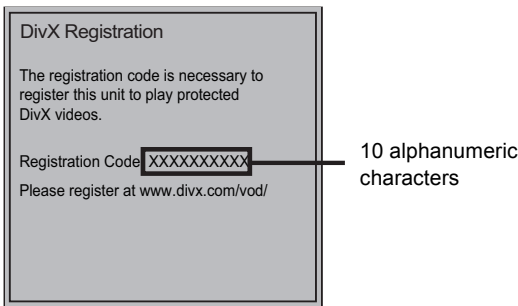

- After playing DivX VOD content for first time, the registration code is not displayed.
- If you purchase DivX VOD content using a registration code different from this unit's code, you will not be able to play this content. ("Authorization Error" is displayed.)

Cancel the unit's registration.

(⇒ 29, "DivX Registration" in "Others")

Press [◀, ▶] to select "Yes" in "DivX Registration".

Use the deregistration code to cancel the registration in www.divx.com.

Regarding DivX VOD content that can only be played a set number of times

Some DivX VOD content can only be played a set number of times. When you play this content, the remaining number of plays is displayed. You cannot play this content when the number of remaining plays is zero. ("Rental Expired." is displayed.)

- The remaining number of plays decreases each time a program is played. However, when playing from the point where play was previously stopped, the remaining number of plays does not decrease due to the resume play function.

■ Displaying subtitles text

You can display subtitles text on the DivX video disc with this unit. This function has no relation to the subtitles specified in DivX standard specifications and has no clear standard. The operation might be different or it may not operate properly depending on the way the file was made or the state of this unit (playing, stopped, etc.).

Set "Subtitle" in "Disc" (⇒ 24)



- DivX video files that do not display "Text" do not contain subtitles text.
- If the subtitles text are not displayed correctly, try changing the language settings. (⇒ 26)

Playing still pictures

BD DVD CD SD USB

(BD-RE, DVD-RAM/-R/-R DL, CD-R/RW, SD Card, USB device)

1 Insert a disc, SD card or USB device.

If the menu is displayed, press [▲, ▼] to select the item and press [OK].

2 BD-RE, DVD-RAM

Press [▲, ▼, ◀, ▶] to select the album and press [OK].

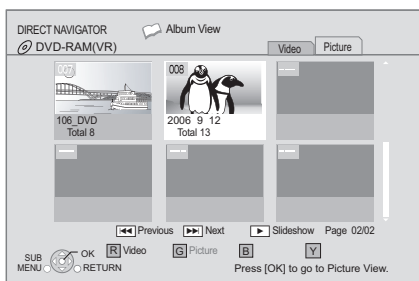

3 Press [▲, ▼, ◀, ▶] to select the still picture and press [OK].

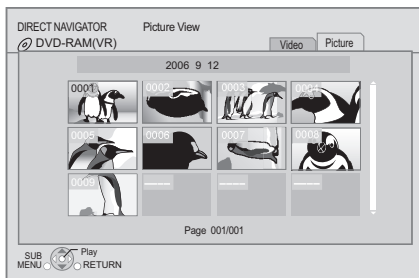

Press [◀, ▶] to display the previous or next still picture.

To exit the screen

Press [TOP MENU/DIRECT NAVIGATOR].

■ To show the picture properties

While playing, press [STATUS] twice.

e.g. JPEG on DVD-RAM
Shooting date



To exit the screen

Press [STATUS].

Useful functions

1 Press [SUB MENU].

2 Select an item, then press [OK].

While "Album View" or "Picture View" screen is displayed

Start Slideshow	You can display still pictures one by one at a constant interval.
Slideshow Settings	<p>Display Interval Change the display interval.</p> <p>Transition Effect Set display method.</p> <p>Repeat Play Repeat slideshow.</p> <p>Soundtrack The MP3 that is recorded on the USB device or the music CD can be played back as Background Music during the slideshow.</p> <p>Soundtrack Folder A folder to playback can be selected when a USB device with MP3 recorded is connected to this unit.</p> <p>Press [▲, ▼, ◀, ▶] to select "Set" and press [OK].</p>
Select Root folder	To switch to another higher folder <ul style="list-style-type: none"> Only if there is a multiple number of higher folders recognizable
Select Folder	To select the still pictures in another folder
To Video	Playing video contents (⇒ 16)
To album view	To display album view.

While playing (except for slideshow)

Rotate Right	Rotate the still picture.
Rotate Left	Rotate the still picture.
Zoom out	Reduce the still picture <ul style="list-style-type: none"> This function is only available for small-sized still pictures.
Zoom in	Cancel "Zoom out"



- Depending on the media and contents, displayed items are different.
- When a still picture with large number of pixels is played, the display interval may become longer. Even if the setting is changed, the display interval may not become shorter.
- When both the music CD and the USB device with MP3 recorded is inserted to this unit, the music CD has a priority to be played back as Background Music.

Playing music

DVD CD USB

(DVD-R/-R DL, music CD, CD-R/RW, USB device)

1 Insert a disc or USB device.

If the menu is displayed, press [**▲**, **▼**] to select the item and press [**OK**].

2 Press [**▲**, **▼**] to select the track and press [**OK**].

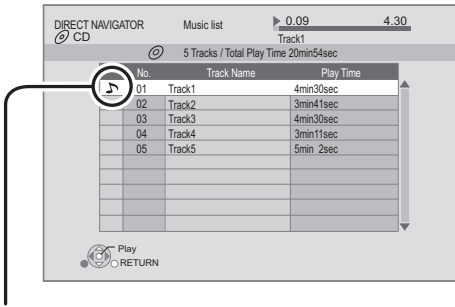

“” indicates the track currently playing.

■ Playing a track in another folder

1 While the “Music list” is displayed
Press [**SUB MENU**].

2 Press [**▲**, **▼**] to select “Select Folder” and press [**OK**].



- You cannot select folders that contain no compatible tracks.

Linked operations with the TV (VIERA Link™ “HDAVI Control™”)

What is VIERA Link “HDAVI Control”?

VIERA Link™ is a new name for EZ Sync™. VIERA Link “HDAVI Control” is a convenient function that offers linked operations of this unit, and a Panasonic TV (VIERA) or amplifier/receiver under “HDAVI Control”.

You can use this function by connecting the equipment with an HDMI cable. See the operating instructions for connected equipment for operational details.

Preparation

- ① Set “VIERA Link” to “On” (⇒ 28). (The default setting is “On”.)
- ② Set the “HDAVI Control” operations on the connected equipment (e.g., TV).
- ③ Turn on all “HDAVI Control” compatible equipment and select this unit’s input channel on the connected TV so that the “HDAVI Control” function works properly.

Also when the connection or settings are changed, repeat this procedure.

Automatic input switching Power on link

When the following operations are performed, the television will automatically switch the input channel and display the corresponding action. When the television is off, the television will automatically turn on.

- When play starts on the unit
- When an action that uses the display screen is performed (e.g., Direct Navigator screen)

Power off link

All connected equipment compatible with “HDAVI Control”, including this unit, automatically turns off when you switch the television off.

Playing music continuously even after turning off power to the television

When the unit is connected to a Panasonic TV (VIERA) that supports HDAVI Control 2 or later and an amplifier/receiver supports VIERA Link.

- ① While playing music
Press [SUB MENU].
- ② Press [▲, ▼] to select “TV Power” and press [OK].

Easy control only with VIERA remote control

Only TV supports “HDAVI Control 2” or later

By using the TV remote control, you can play discs using the “Control Panel” and display the Top Menu or Pop-up Menu, etc.

- 1 Press [SUB MENU].
- 2 Select an item, then press [OK].

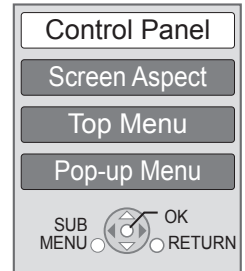

- You cannot use the sub menu while the Top Menu for BD-Video or DVD-Video is displayed.



- The buttons that you can use for this unit vary depending on the TV. For details, refer to the operating instructions of the TV.
- The operation of this unit may be interrupted when you press incompatible buttons on the TV remote control.
- This unit supports “HDAVI Control 5” function. “HDAVI Control 5” is the newest standard (current as of December, 2009) for Panasonic’s HDAVI Control compatible equipment. This standard is compatible with Panasonic’s conventional HDAVI equipment.
- VIERA Link “HDAVI Control”, based on the control functions provided by HDMI which is an industry standard known as HDMI CEC (Consumer Electronics Control), is a unique function that we have developed and added. As such, its operation with other manufacturers’ equipment that supports HDMI CEC cannot be guaranteed.
- Please refer to individual manuals for other manufacturers’ equipment supporting VIERA Link function.

Enjoying VIERA CAST™

You can access a selection of Internet services from the Home screen with VIERA CAST, for example YouTube, Picasa Web Albums. (Current as of December 2009)

Preparation

- Network connection (⇒ 10)
- Network setting (⇒ 12)

1 Press [VIERA CAST].

Message is displayed. Please read these instructions carefully and then press [OK].

2 Press [▲, ▼, ◀, ▶] to select the item and press [OK].

Operable buttons:

[▲, ▼, ◀, ▶], [OK], [RETURN], colored buttons, numbered buttons

VIERA CAST Home screen;

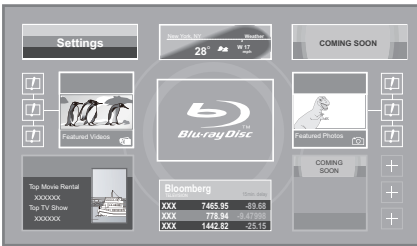

Images are for illustration purposes, contents may change without notice.

To return to VIERA CAST Home screen

Press [VIERA CAST].

To exit from VIERA CAST

Press [EXIT], [FUNCTION MENU] or [TOP MENU/DIRECT NAVIGATOR].



- In the following cases, settings are possible using "Internet Content Settings" (⇒ 29)
 - When restricting the use of VIERA CAST.
 - When the audio is distorted.
 - When wrong time is displayed
- If using slow Internet connection, the video may not be displayed correctly. A high-speed Internet service with a speed of at least 6 Mbps is recommended.
- Be sure to update the firmware when a firmware update notice is displayed on the screen. If the firmware is not updated, you will not be able to use the VIERA CAST™ function. (⇒ 14)
- VIERA CAST™ home screen is subject to change without notice.
- The services through VIERA CAST™ are operated by their respective service providers, and service may be discontinued either temporarily or permanently without notice. Therefore, Panasonic will make no warranty for the content or the continuity of the services.
- All features of websites or content of the service may not be available.
- Some content may be inappropriate for some viewers.
- Some content may only be available for specific countries and may be presented in specific languages.

Playback menu

1 Press [DISPLAY].

e.g., BD-Video

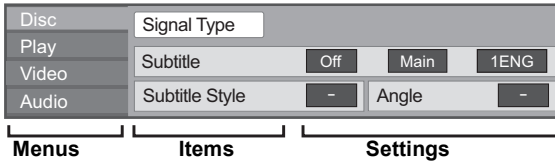

2 Press [▲, ▼] to select the menu and press [▶].

3 Press [▲, ▼, ◀, ▶] to select the item and press [▶].

4 Press [▲, ▼] to select the setting.

Some items can be changed by pressing [OK].

To exit the screen

Press [DISPLAY].

Depending on the condition of the unit (playing, stopped, etc.) and media contents, there may be some items that you cannot select or change.

Regarding Language, Audio attribute and video attribute :
(⇒ 38)

Disc

Signal Type

Primary Video

Video	The recording method of original video appears.
Soundtrack	Select the type of audio or language.

Secondary Video

Video	Select on/off of images. The recording method of original video appears.
Soundtrack	Select on/off of audio and the language.

Video

The recording method of original video appears.

Soundtrack

Show or change the soundtrack.

Subtitle

Turn the subtitle on/off, and change the language depending on the media.

Subtitle Style

Select the subtitle style.

Audio channel

Select the audio channel number.
(⇒ 16, "Changing audio")

Angle

Select the number of the angle.

Some items may be changed only on the disc specific menu.
(⇒ 16)

Play

Repeat Play

(Only when the elapsed time is being displayed on the unit's display.)

Select the item which you want to repeat. The items displayed differ depending on the type of media.



Select "Off" to cancel.

Random

Select whether or not to play random.

Playback Information Window

Displays the following.

	Audio/video attribute information of disc.
	Settings status of "Digital Audio Output" (⇒ 27).
	HDMI output information.

Press [RETURN] to exit.

Video

Picture

Select the picture quality mode during play.

- If you select "User", you can make further adjustments.
Press [▶] to select "Picture Adjustment" and press [OK].



- 3D NR:
Reduces the rough noise in the background to give a greater feeling of depth.
When "24p Output" is set to "On", this function may not operate. (⇒ 28)
- Integrated NR:
Smooths block noise and reduces the smudging that appears around contrasting sections of the picture.

Advanced Settings

Chroma Process

The high-resolution processing of HDMI chroma signals produces a high-resolution picture with rich picture quality

Detail Clarity

The picture is sharp and detailed.

Progressive

Select the method of conversion for progressive output to suit the type of material being played.

- When the content is distorted change the settings from "Auto" to "Video".

24p

Movies and other material recorded on DVD-Video at 24p are output at 24p.

- Only when you have selected "On" in "24p Output" (⇒ 28)

Audio

Sound Effects*¹

Select the sound effect.

- Digital Tube Sound*² :
This feature gives you warm sound, like that produced by a vacuum tube amplifier.
- Re-master*² :
This feature gives you brighter sound by increasing the high frequency portion of the audio. (Discs recorded at 48 kHz or less)
Recommended setting

Re-master 1	Pop and rock
Re-master 2	Jazz
Re-master 3	Classical

- Night Surround :
Enjoy a movie with powerful sound even when the volume is kept low at night. The audio is set in such a way that it can be heard easily.

Dialog Enhancer*²

The volume of the center channel is raised to make dialog easier to hear.

High Clarity Sound

When connected to TV via HDMI terminal for outputting image, it produces clearer sound.

- Only when you have selected "Enable" in "High Clarity Sound" (⇒ 27).

*¹ Not every function can be set individually.

*² This function is effective for audio from the HDMI terminal or the COAXIAL /OPTICAL terminal only when "Digital Audio Output" is set to "PCM" (⇒ 27). (However, in this case, audio is output as 2ch from the COAXIAL /OPTICAL terminal.)

Setup menu

Change the unit's settings if necessary. The settings remain intact even if you switch the unit to standby.

- 1 Press [FUNCTION MENU] and press [▲, ▼] to select "Other Functions" and press [OK].
- 2 Press [▲, ▼] to select "Setup" and press [OK].

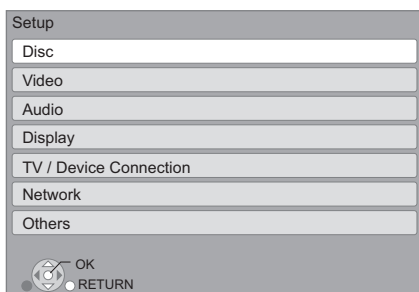

- 3 Press [▲, ▼] to select the menu and press [OK].
- 4 Press [▲, ▼] to select the item and press [OK].
If there are any other items, repeat these steps.
- 5 Press [▲, ▼, ◀, ▶] to select the option and press [OK].

- There may be differences in operation methods. If this happens, follow the on-screen instructions for the operation.

About the password

The password of the following items are common. Don't forget your password.

- "DVD-Video Ratings"
- "BD-Video Ratings"
- "Lock" (⇒ 29)

Disc

DVD-Video Ratings

Set a ratings level to limit DVD-Video play.

- Follow the on-screen instructions. Enter a 4-digit password with the numbered buttons when the password screen is shown.

BD-Video Ratings

Set an age limit of BD-Video play.

- Follow the on-screen instructions. Enter a 4-digit password with the numbered buttons when the password screen is shown.

Audio Language

Choose the language for audio.

- If "Original" is selected, the original language of each disc will be selected.
- Enter a code (⇒ 38) with the numbered buttons when you select "Other ****".

Subtitle Language

Choose the language for subtitle.

- If "Automatic" is selected and the language selected for "Audio Language" is not available, subtitles of that language will automatically appear if available on that disc.
- Enter a code (⇒ 38) with the numbered buttons when you select "Other ****".

Menu Language

Choose the language for disc menus.

- Enter a code (⇒ 38) with the numbered buttons when you select "Other ****".

BD-Live Internet Access (⇒ 18)

You can restrict Internet access when BD-Live functions are used.

- If "Allow (Limited)" is selected, Internet access is permitted only for BD-Live contents which have content owner certificates.

DivX Subtitle Text

Select a suitable item according to the language used for DivX subtitles text (⇒ 19).

- This item is displayed only after playing back a file.

Video

Still Mode (paused video)

Select the type of picture shown when you pause playback.

Auto	Automatically selects the type of picture shown.
Field	Select if jittering occurs when "Auto" is selected.
Frame	Select if small text or fine patterns cannot be seen clearly when "Auto" is selected.

Seamless Play

The chapters segment in playlists are played seamlessly.

- Select "On", when the picture freezes for a moment at the chapters segment in playlists.

Black Level Control

Select lighter or darker for adjusting the black level control to the desired setting for picture enhancement.

Audio

Dynamic Range Compression

You can listen at low volumes but still hear dialog clearly. (Dolby Digital, Dolby Digital Plus and Dolby TrueHD only)

- "Auto" is effective only when playing Dolby TrueHD.

Digital Audio Output (⇒ 33)

Press [OK] to show the following settings.

Dolby D/Dolby D +/Dolby TrueHD DTS/DTS-HD

Select the audio signal to output.

- Select "PCM", when the connected equipment cannot decode the respective audio format.
- Not making the proper settings may result in noise.

BD-Video Secondary Audio

Select whether to mix or not mix the primary audio and secondary audio (including the button click sound). (⇒ 18)

- If "Off" is selected, the unit outputs the primary audio only.

PCM Down Conversion

Select how to output audio with a sampling frequency of 96 kHz for the PCM output from the DIGITAL AUDIO OUT.

- If "On" is selected, the signals that are converted to 48 kHz are output.
- If "Off" is selected, and the connected equipment does not support 96 kHz, the sound will not be output normally.
- Signals are converted to 48 kHz despite the settings across in the following cases:
 - when the signals have a sampling frequency of 192 kHz
 - when the disc has copy protection
 - when "BD-Video Secondary Audio" is set to "On"

Downmix

Select the downmix system of multi-channel to 2 channel sound.

- Select "Surround encoded", when the connected equipment supports the virtual surround function.
- There is no effect on "Bitstream" via HDMI AV OUT and DIGITAL AUDIO OUT.
- The audio will be output in "Stereo" in the following cases.
 - AVCHD playback
 - Playback of secondary audio (including the button click sound).

7.1ch Audio Reformatting

Surround sound with 6.1ch or less is automatically expanded and played back at 7.1ch.

- If "Off" is selected, sound is played over the original number of channels. (Note that in the case of 6.1ch audio, playback will be at 5.1ch.)

Audio reformatting is enabled in the following cases:

- When you have selected "PCM" in "Digital Audio Output".
- When the audio is Dolby Digital, Dolby Digital Plus, Dolby TrueHD or LPCM.

High Clarity Sound

When connected to TV via HDMI terminal for outputting image, it produces clearer sound.

- Set to "Enable" and then set "High Clarity Sound" on the playback menu to "On". (⇒ 25)

Audio Delay

Mis-sync between the video and audio is corrected by delaying the audio output.

Display

Status Messages

Choose whether to show status messages automatically.

On-screen Language

Choose the language for these menus and on-screen messages.

Screen Saver Function

This is to prevent burn-in on the screen.

- When this is set to "On":
 - If there is no operation for 10 minutes or more, Direct Navigator screen switches to FUNCTIONS screen automatically.
 - While playing and pausing, etc., this function is not available.
 - As for Music [CD-DA] or MP3, regardless of the setting, if there is no operation for a while, Direct Navigator screen switches to the other states automatically.

FL Display

Changes the brightness of the unit's display.

- If "Auto" is selected the display is dimmed during playback and bright except during playback.

SD Card LED Control

Set the lighting method for the lamp on the SD card slot.

- If "SD inserted" is selected, and this unit is turned on and SD card is inserted, the lamp is lighted.

License



Information about the software used by this unit is displayed.

TV / Device Connection

TV Aspect

Set to match the type of television connected.

When connected to a 4:3 aspect television and playing 16:9 ratio image:

4:3 Pan & Scan	The sides are cut off so the picture fills the screen. When playing BD-Video, video is output as "4:3 Letterbox".	
4:3 Letterbox	Black bands appear at the top and bottom of the picture.	

When connected to a 16:9 widescreen television and playing 4:3 ratio image:

16:9	Video is displayed as a 4:3 ratio image in the center of the screen.
16:9 Full	Video is displayed as a horizontally stretched 16:9 image.

HDMI Connection

Press [OK] to show the following settings.

HDMI Video Mode

Select "On" when video is output from HDMI AV OUT terminal.

On	Images are output from the HDMI terminal in the resolution set in "HDMI Resolution".
Off	Images are output in the resolution set in "Component Video Resolution".

HDMI Resolution

The items supported by the connected devices are indicated on the screen as "*". When any item without "*" is selected, the images may be distorted.

- If "Auto" is selected, automatically selects the output resolution best suited to the connected television.
- To enjoy high definition video up-converted to 1080p, you need to connect the unit directly to 1080p compatible HDTV (High Definition Television). If this unit is connected to an HDTV through other equipment, it must also be 1080p compatible.

24p Output

When this unit is connected to a TV supporting 1080/24p output using an HDMI cable, movies and other material recorded at 24p are output at 24p.

- When playing DVD-Video, set to "On" and then also set "24p" in "Video" (⇒ 25) to "On".
- When BD-Video images other than 24p are played, images are output at 60p.

HDMI Color Mode

This setting is for selecting color-space conversion of the image signal when the unit is connected using an HDMI cable.

HDMI Audio Output

This setting selects whether or not to output audio from HDMI.

- Select "Off" when the TV is connected to this unit via an HDMI terminal, and this unit is also connected to other devices, such as an amplifier/receiver via a COAXIAL or an OPTICAL terminal.

VIERA Link

Set to use "HDAVI Control" function when connected with an HDMI cable to a device that supports "HDAVI Control".

- Select "Off" when you do not want to use "HDAVI Control".

Deep Color Output

This setting is for selecting whether to use Deep Color output when a television that supports Deep Color is connected.

Contents Type Flag

Depending on the playback content, the TV will output adjusting to the optimal method when a TV that supports this function is connected.

Component Video Resolution



This sets the video output resolution when connected via the COMPONENT VIDEO OUT terminal.

- Even if you select "720p" or "1080i", the video output resolution is restricted to "480p" when images of DVD-Video discs are output from the COMPONENT VIDEO OUT terminals.

Analog Audio Output

You can set the optimum multi-channel surround sound for your speakers from this unit when the settings cannot be adjusted from a connected amplifier/receiver with AUDIO OUT terminals.

Select "2ch (Downmix) + 5.1ch" or "7.1ch" and press [OK], and then set the following options.

- Speaker presence and size ()
- Delay time ()
- Channel balance ()

To finish the speaker setting

Press [▲, ▼, ◀, ▶] to select "Complete" and press [OK].

Network

Network Easy Setting (⇒ 12)

Network Settings

Perform network-related settings individually.
Press [OK] to show the following settings.

LAN Connection Mode

Select connection method.

Access Point Connection Setting

This allows the Wireless router (Access point) and connection settings to be set and the current connection settings and connection state to be checked when a wireless connection is used.

Connection Setting

The Wireless router (Access point) connection wizard will be displayed.

IP Address/DNS Settings

This is for checking the state of the network connection and setting the IP address and DNS-related.

Press [OK] to show the respective setting.

- “Connection Speed Setting” is enabled only when “Auto Detect Connection Speed” is turned “Off”.

Proxy Server Settings

This is for checking the state of connection with the Proxy server and performing settings.

Press [OK] to show the respective setting.

Internet Content Settings (⇒ 23) (VIERA CAST)

Press [OK] to show the following settings.

Lock

You can restrict the usage of VIERA CAST.

- Follow the on-screen instructions. Enter a 4-digit password with the numbered buttons when the password screen is shown.

Audio Auto Gain Control

Volume that is different depending on the contents is adjusted automatically to the standard volume while using the VIERA CAST.

- Depending on contents, this function effect will not work.
- Select “Off” when the audio is warped.

Time Zone

By selecting the time zone, it is possible to set the unit's time to match your location.

- Some VIERA CAST contents require the time zone to be set. Set the time zone if necessary.

DST

Select “On” when using Daylight Saving time.

MAC Address

Displays the MAC address of this unit.

Others

Off Timer

Select how long the unit remains on when it is not being used.

Remote Control Code

Change the remote control code, when other Panasonic products react to this remote control.

Quick Start

Speed of startup from power off is increased.

- Internal control unit will be powered when it is set to “On”, so contents of the following will be different from the time it is set to “Off”.
 - Idle power consumption will increase. (about the power consumption ⇒ 37)

Easy Setting

You can execute basic settings (“On-screen Language”, “TV Aspect”, “Analog Audio Output”, “Quick Start”)

Restore Default Settings

This returns all values in the Setup menu and the playback menu, except for “Remote Control Code”, “On-screen Language”, “IP Address/DNS Settings”, “Proxy Server Settings”, “Lock”, “DVD-Video Ratings” and “BD-Video Ratings” to the default settings.

DivX Registration (⇒ 19)

You need this registration code to purchase and play DivX Video-on-Demand (VOD) content.

System Information

Display firmware version of this unit, wireless LAN module of your Wireless LAN Adaptor.

Firmware Update (⇒ 14)

Press [OK] to show the following settings.

Automatic Update Check

When this equipment remains connected to the Internet, it will check for the latest firmware version when it is turned on and you can update it if necessary.

Update Now

You can update the firmware manually.

Troubleshooting guide

Before requesting service, please perform the following steps.

Do you have the latest firmware installed?

Firmware updates may be released to correct operating irregularities that are discovered with certain movies.

(⇒ 14)



Make the following checks and visit our website for more information.

For USA :

<http://www2.panasonic.com/consumer-electronics/support/>
Enter the model number.

For Canada :

<http://www.panasonic.ca>



Even so, you still have trouble,

Visit our website to find a service center.

You can find a service center near you easily on our website.

Other support information:

“Customer Services Directory (United States and Puerto Rico)” (⇒ 40) or “Limited Warranty (Only for CANADA)” (⇒ 41).

The following do not indicate a problem with this unit:

- Regular disc rotating sounds.
- Image disturbance during search.

■ Unit doesn't respond to remote control or front panel buttons.

Press and hold [POWER ⏻/⏻] on the main unit for 3 seconds.

– If still unable to power the unit off, disconnect the power cord, wait 1 minute, then reconnect the power cord.

■ Cannot eject disc.

The unit may have a problem.

- ① While the unit is off, press and hold [OK], [B] and [Y] on the remote control at the same time for more than 5 seconds.
– “00 RET” is displayed on the unit's display.
- ② Repeatedly press [▶] (right) on the remote control or [POWER ⏻/⏻] on the unit until “06 FTO” is displayed on the unit's display.
- ③ Press [OK] on the remote control or [▲ OPEN/CLOSE] on the unit.

General operation

To return to the factory preset.

- Select “Yes” in “Restore Default Settings” in the Setup menu. (⇒ 29)

To return all settings to the factory preset.

- Reset the unit as follows:
 - ① While the unit is off, press and hold [OK], [B] and [Y] on the remote control at the same time for more than 5 seconds.
– “00 RET” is displayed on the unit's display.
 - ② Repeatedly press [▶] (right) on the remote control or [POWER ⏻/⏻] on the unit until “08 FIN” is displayed on the unit's display.
 - ③ Press and hold [OK] on the remote control or [▲ OPEN/CLOSE] on the unit for at least 3 seconds.

Power of this unit is turned off when the input for the TV is switched.

- This is a normal phenomenon when using VIERA Link (HDAVI Control 4 or later). For details please read the operating instructions for the TV.

The remote control doesn't work properly.

- The remote control and main unit are using different codes. Change the code on the remote control. (⇒ 29)
- It may be necessary to set the manufacturer code or the remote control code again after changing the batteries for remote control. (⇒ 14)

The TV tuner mode is not displayed when the TV is switched on.

- This phenomenon may occur, depending on the TV setting, when “Quick Start” is set to “On”.
– Depending on the TV, this phenomenon may be prevented by reconnecting the HDMI cable to a different HDMI input terminal or by changing the HDMI auto connection setting.

You have forgotten your ratings password. You want to cancel the ratings level.

- The ratings level returns to the factory preset.
 - ① While the unit is on, press and hold [OK], [B] and [Y] on the remote control at the same time for more than 5 seconds.
– “00 RET” is displayed on the unit's display.
 - ② Repeatedly press [▶] (right) on the remote control or [POWER ⏻/⏻] on the unit until “03 VL” is displayed on the unit's display.
 - ③ Press [OK] on the remote control or [▲ OPEN/CLOSE] on the unit.

Picture

The images from this unit do not appear on the television.

Picture is distorted.

- An incorrect resolution is selected in “Component Video Resolution” or “HDMI Resolution”. Reset the setting as follows:
 - ① While the unit is on, press and hold [OK], [B] and [Y] on the remote control at the same time for more than 5 seconds.
 - “00 RET” is displayed on the unit’s display.
 - ② Repeatedly press [▶] (right) on the remote control or [POWER ⏻/I] on the unit until “04 PRG” is displayed on the unit’s display.
 - ③ Press and hold [OK] on the remote control or [▲ OPEN/CLOSE] on the unit for at least 3 seconds.
 - Set the item again. (⇒ 28)
- When Dolby Digital Plus, Dolby TrueHD, and DTS-HD audio are not output in bitstream, select “Yes” in “Restore Default Settings” and make proper settings. (⇒ 29)

Video is not output.

- Set the “High Clarity Sound” in the playback menu to “Off” to use the COMPONENT VIDEO OUT terminal or the VIDEO OUT terminal. (⇒ 25)

Video is not output in high definition.

- Confirm that the “HDMI Video Mode”, “HDMI Resolution”, and “Component Video Resolution” in the Setup menu are set properly. (⇒ 28)

No subtitles.

- When progressive output is on, closed captions cannot be displayed.

The subtitles overlap closed captions recorded on discs.

- Turn off the subtitles or turn off the closed caption setting on the TV. (⇒ 24)

A black band is displayed around the edge of the screen.

The aspect ratio of the screen is abnormal.

- Confirm the “TV Aspect” is set properly. (⇒ 28)
- Adjust the aspect setting on the television. (Adjustment using “Screen Aspect” (⇒ 17) on the unit is also possible)

Audio

Cannot switch audio.

- When connecting an amplifier/receiver using a COAXIAL/OPTICAL terminal or an HDMI terminal, you cannot switch the audio if “Digital Audio Output” is set to “Bitstream”. Set “Digital Audio Output” to “PCM” or connect using AUDIO OUT terminal. (⇒ 9, 27)

Cannot hear the desired audio type.

- Check the connections and the “Digital Audio Output” settings. (⇒ 27)
- When the unit is connected to an amplifier/receiver with the AUDIO OUT terminal, set “Analog Audio Output”. (⇒ 28)
- To output audio from a device connected with an HDMI cable, set “HDMI Audio Output” to “On” in the Setup menu. (⇒ 28)

Playback

Disc cannot be played.

- The disc is dirty. (⇒ 4)

The contents of the USB device cannot be read.

- USB devices connected using USB extension cable other than the included or a USB hub may not be recognized by this unit.
- If inserted during playback the USB device may not be recognized by this unit.
- If two USB devices other than Wireless LAN adaptor are connected simultaneously, they will not be recognized by this unit.

Still pictures (JPEG) do not play back normally.

- The images that were edited on the PC, such as Progressive JPEG, etc., may not play back.

I can't play back BD-Live.

- The SD card is write-protected. (⇒ 7)
- Confirm that this unit is connected to the broadband Internet. (⇒ 10)
- Confirm the “BD-Live Internet Access” settings. (⇒ 26)
- Confirm an SD Card is inserted into the SD Card slot. (⇒ 15)

Network & VIERA CAST

I can't connect to the network.

- Confirm the network connection and settings. (⇒ 10, 29)
- Check the operating instructions for each device and connect accordingly.

Messages

The following messages or service numbers appear on the television or unit's display when something unusual is detected during startup and use.

On the television

Cannot play.

- You inserted an incompatible disc (Discs recorded in PAL video, etc.).

Cannot display on this unit.

- You tried to play a non-compatible image.
- Confirm "SD" on the unit's display is not blinking and re-insert the card.

No disc is inserted.

- The disc may be upside down.

⊘ This operation is not available.

- Some operations are unsupported by the unit. For example;
 - BD-Video: During playback, reverse slow-motion or reverse frame-by-frame is not possible.

IP address is not set.

- The "IP Address" in "IP Address/DNS Settings" is "----. ---. ---. ---". Set the "IP Address", "Subnet Mask", and "Default Gateway". (Select the automatic address acquisition if necessary.)

On the unit's display

F99

- The unit fails to operate properly. Press [POWER ⏻/I] on the main unit to switch the unit to standby for 3 seconds. Now press [POWER ⏻/I] on the main unit again to turn the unit on.

HDMI ONLY

- Some BD-Video discs can only be output with HDMI.

NET

- Displays while VIERA CAST is starting up.

No PLAY

- There is a viewing restriction on a BD-Video or DVD-Video. (⇒ 26)

No READ

- The media is dirty or badly scratched. The unit cannot play.

PLEASE WAIT

- The unit is carrying out an internal process. This is not a malfunction. You cannot operate the unit while "PLEASE WAIT" is displayed.

REMOVE

- The USB device is drawing too much power. Remove the USB device.

SET □

("□" stands for a number.)

- The remote control and main unit are using different codes. Change the code on the remote control.

Press and hold [OK] and the indicated number button at the same time for more than 5 seconds.



U59

- The unit is hot. The unit switches to standby for safety reasons. Wait for about 30 minutes until the message disappears. Select a position with good ventilation when installing the unit. Do not block the ventilation hole on the rear and side of the unit.

U72

U73

- The HDMI connection acts unusually.
 - Turn the unit and TV off.
 - Disconnect the HDMI cable between the player and the TV.

H□□ or F□□

("□" stands for a number.)

- There is something unusual.
- Check the unit using the troubleshooting guide. If the service number does not disappear, do the following.
 - ① Disconnect the plug from the AC outlet, wait a few seconds, then reconnect it.
 - ② Press [POWER ⏻/I] to turn the power on.

If the service number does not disappear despite doing the above, request service from the dealer. Inform the dealer of the service number when requesting service.

START

- The system is being restarted during the firmware update. Please do not turn off power.

UPD□/□

("□" stands for a number.)

- The firmware is being updated. Please do not turn off power.

FINISH

- The firmware update is complete.

Audio Information

About audio from audio output terminals

The audio output differs depending on which terminals are connected to the amplifier/receiver, and the settings on the unit. (⇒ 27, Digital Audio Output)

- The number of channels listed is the maximum possible number of output channels.

HDMI AV OUT/DIGITAL AUDIO OUT (Coaxial/Optical)

Terminal	HDMI AV OUT				DIGITAL AUDIO OUT	
	"Bitstream" ^{*1}		"PCM" ^{*2}		"Bitstream"	"PCM"
"BD-Video Secondary Audio"	"On" ^{*3}	"Off"	"On" ^{*4}	"Off"	"On"/"Off"	"On"/"Off"
Dolby Digital/ Dolby Digital EX ^{*5}	Dolby Digital	Outputs using original audio	DVD-Video : 5.1ch PCM		Dolby Digital/ Dolby Digital EX ^{*6}	Down-mixed 2ch PCM
Dolby Digital Plus/ Dolby TrueHD			BD-Video : 7.1ch PCM ^{*7}			
DTS Digital Surround/ DTS-ES ^{*5}	DTS Digital Surround		7.1ch PCM		Dolby Digital	
DTS-HD High Resolution Audio/ DTS-HD Master Audio			DVD-Video : 5.1ch PCM		DTS Digital Surround/ DTS-ES ^{*6}	
			BD-Video : 7.1ch PCM ^{*8}		DTS Digital Surround	
			7.1ch PCM ^{*8}			
7.1ch LPCM	7.1ch PCM				Down-mixed 2ch PCM	

AUDIO OUT

Terminal	7.1ch AUDIO OUT	5.1ch AUDIO OUT	2ch AUDIO OUT
"BD-Video Secondary Audio"	"On" ^{*4} /"Off"	"On"/"Off"	"On"/"Off"
Dolby Digital/ Dolby Digital EX	DVD-Video : 5.1ch BD-Video : 7.1ch ^{*7}	5.1ch	2ch
Dolby Digital Plus/ Dolby TrueHD	7.1ch		
DTS Digital Surround/ DTS-ES	DVD-Video : 5.1ch BD-Video : 7.1ch ^{*8}		
DTS-HD High Resolution Audio/ DTS-HD Master Audio	7.1ch ^{*8}		
7.1ch LPCM	7.1ch		

^{*1} When the connected equipment is not supported with these audio formats, the audio is output as Dolby Digital bitstream, DTS Digital Surround bitstream or down-mixed 2ch PCM (e.g., TV).

^{*2} When the connected equipment is not supported with multi channel surround, the audio is output as down-mixed 2ch PCM.

^{*3} When playing BD-Video without secondary audio or button click sound, the audio is output as the same format as if "BD-Video Secondary Audio" was set to "Off".

^{*4} When playing BD-Video with secondary audio or button click sound, the audio is output as 5.1ch.

^{*5} With PCM output, Dolby Digital EX becomes PCM audio decoded as Dolby Digital, DTS-ES recorded to DVD-Video becomes PCM audio decoded as DTS Digital Surround, and DTS-ES recorded to BD-Video becomes PCM audio decoded as DTS-ES.

^{*6} When "BD-Video Secondary Audio" is set to "On", Dolby Digital EX is output as Dolby Digital and DTS-ES is output as DTS Digital Surround, however if playing BD-Video without secondary audio or button click sound, the audio is output as the original format.

^{*7} When BD-Video is played and "7.1ch Audio Reformatting" is set to "Off", the audio is output as 5.1ch.

^{*8} The audio output is amplified from 5.1ch or 6.1ch to 7.1ch depending on the DTS, Inc. specifications.

Recommended audio output setting

The settings of the audio output vary depending on the connected equipment. Refer to the table below and set each of items.

Press [FUNCTION MENU] ⇒ select “Other Functions” ⇒ “[OK]” ⇒ select “Setup” ⇒ “[OK]” ⇒ “Audio” ⇒ Set each item

For details of the each item, refer to page 27.

Setup menu		Example of connected equipment				
		TV via HDMI ¹	Receiver with HD audio ² decoder via HDMI	Receiver without HD audio ² decoder via HDMI	Receiver via COAXIAL or OPTICAL	Receiver via analog output ³
“Digital Audio Output”	“Dolby D/Dolby D +/Dolby TrueHD”	“PCM”	“ <u>Bitstream</u> ”	“PCM”	“PCM”	No effect
	“DTS/DTS-HD”	“PCM”	“ <u>Bitstream</u> ”	“PCM”	“PCM”	No effect
	“BD-Video Secondary Audio”	“Off”	“Off”	“Off”	“Off”	“Off”
“PCM Down Conversion”		No effect	No effect	No effect	“ <u>Off</u> ” ⁴	No effect
“Downmix”		“ <u>Stereo</u> ”	No effect	No effect	“ <u>Stereo</u> ” ⁵	No effect
“High Clarity Sound”		“Enable”	“ <u>Disable</u> ” ⁶	“ <u>Disable</u> ” ⁶	“ <u>Disable</u> ” ⁶	“ <u>Disable</u> ” ⁶

- Because underlined items are the factory presets, it is not necessary to change these settings.

¹ If connected to TV via except HDMI, these settings have no effect.

² HD audio: Dolby Digital Plus, Dolby TrueHD, DTS-HD High Resolution Audio and DTS-HD Master Audio

³ Set “Analog Audio Output” to “7.1ch” or “2ch (Downmix) + 5.1ch”. (Press [FUNCTION MENU] ⇒ “Other Functions” ⇒ “Setup”)

⁴ If the connected equipment that does not support 96 kHz, set to “On”.

⁵ If the connected equipment that supports the virtual surround function, set to “Surround encoded”.

⁶ When connected to TV via HDMI terminal for outputting image, set to “Enable”.

About MP3/JPEG/DivX/AVCHD/MPEG2 files

MP3

File format	MP3
Extension	Files must have the extension “.mp3” or “.MP3”.
Compression rate	32 kbps to 320 kbps
Sampling rate	44.1 kHz/48 kHz
Reference	ID3 tags: version 1, 2.2, 2.3, 2.4 (Only titles and the names of artists)

JPEG

File format	JPEG
Extension	Files must have the extension “.jpg” or “.JPG”.
Picture resolution	between 34×34 and 8192×8192 pixels (sub sampling is 4:2:2 or 4:2:0)
Reference	JPEG conforming DCF* is supported. ● MOTION JPEG and Progressive JPEG is not supported

* Design rule for Camera File system: unified standard established by Japan Electronics and Information Technology Industries Association (JEITA).

- DVD-RAM must conform to UDF 2.0.
- BD-RE must conform to UDF 2.5.

DivX

File format	DivX
Extension	Files must have the extension “.DIVX”, “.divx”, “.AVI” or “.avi”.
Picture resolution	Up to 1920×1080 pixels
Reference	<ul style="list-style-type: none"> ● DivX certified to play DivX video up to HD 1080p, including premium content. <p>Video</p> <ul style="list-style-type: none"> – Number of stream: Up to 1 – Codec: DIV3, DIV4, DIVX, DX50, DIV6 – FPS (Frame Per Second): Up to 60 fps <p>Audio</p> <ul style="list-style-type: none"> – Number of stream: Up to 8 – Format: MP3, MPEG, Dolby Digital – Multi channel: Dolby Digital is possible. MPEG multi is 2 ch conversion. ● GMC (Global Motion Compensation) is not supported.

- DVD-R and DVD-R DL must conform to UDF 1.02 without ISO9660 and UDF 1.5 with ISO9660.
- BD-R must conform to UDF 2.5.

Subtitles text file of DivX

File format	Subtitles text file of DivX
File format	MicroDVD, SubRip, or TMLayer
Extension	Files must have the extension “.SRT”, “.srt”, “.SUB”, “.sub”, “.TXT”, or “.txt”
Reference	<ul style="list-style-type: none"> ● The DivX video file and subtitles text file are inside the same folder, and the file names are the same except for the file extensions. ● Depending on the methods used to create the file or the state of the recording, only parts of the subtitles may be displayed, or the subtitles may not be displayed at all.

AVCHD

File format	AVCHD format (V1.0) used on High Definition Video Camera (Panasonic and some other's)
Codec	MPEG-4 AVC/H.264
Reference	● Discs must conform to UDF 2.5.

MPEG2

File format	SD-Video format* used on Standard Definition Video Camera (Panasonic and some other's)
Codec	MPEG2

* SD-Video Entertainment Video Profile



- With certain recording states and folder structures, the play order may differ or playback may not be possible.
- CD-R, CD-RW : ISO9660 level 1 or 2 (except for extended formats), Joliet
This unit is compatible with multi-session.
This unit is not compatible with packet writing.
- DVD-R, DVD-R DL (except for AVCHD) : ISO9660 level 1 or 2 (except for extended formats), Joliet, UDF bridge (UDF 1.02/ISO9660)
This unit is not compatible with multi-session.
This unit is not compatible with packet writing.

Structure of folders that can be played in this unit

You can play files on this unit by structure of folders as shown below. However depending on the method of writing data (writing software), play may not be in the order you numbered the folders.

 Folder which can be displayed with this unit

***: Numbers

XXX: Letters

¹ ***: from 001 to 999

² **: from 100 to 999

XXXXX: 5 figures

³ **: from 0001 to 9999

Structures of still picture (JPEG) folders

in DVD-R⁴/DVD-R DL⁴/CD-R⁵/CD-RW⁵

Files inside a folder are displayed in the order they were updated or taken.

Root e.g.,

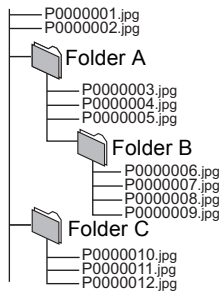

in BD-RE⁶/DVD-RAM⁴

• Folder structure is not displayed.

Root e.g.,

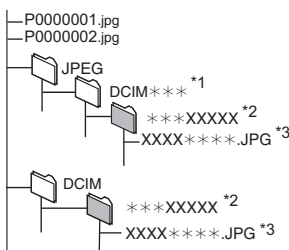

in SD card⁴/USB device⁴

Displays JPEG files in all folders.

• Folder structure is not displayed.

Root e.g.,

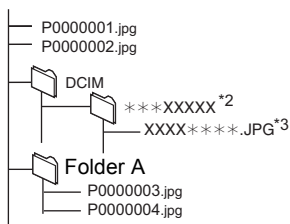

Structure of MP3 folders

in DVD-R/DVD-R DL/CD-R/CD-RW/USB device

Prefix the file names with 3-digit numbers in the order you want to play them.

Root e.g.,

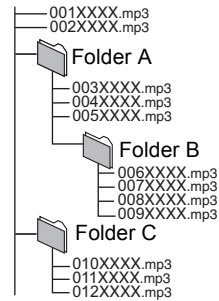

Structure of DivX folders

in BD-R⁷/DVD-R⁷/DVD-R DL⁷/CD-R⁷/CD-RW⁷/USB device⁷

Files inside a folder are displayed in the order they were updated or taken.

Root e.g.,

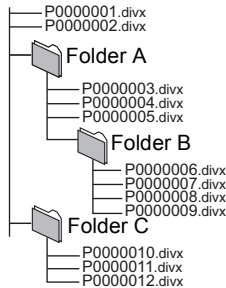

⁴ The total combined maximum number of recognizable picture contents and folders: 3000 picture contents and 300 folders.

⁵ The total combined maximum number of recognizable picture contents and folders: 999 picture contents and 99 folders.

⁶ The total combined maximum number of recognizable picture contents and folders: 9999 picture contents and 300 folders.

⁷ The total combined maximum number of recognizable file contents and folders: 200 file contents and 300 folders.

Specifications

Signal system: NTSC

Operating temperature range: +5 °C to +35 °C (+41 °F to +95 °F)

Operating humidity range: 10 % to 80 % RH (no condensation)

Video output: 1.0 Vp-p (75 Ω)/Pin jack:1 system

Component video output (Y:green, Pb:blue, Pr:red):
Y:1.0 Vp-p (75 Ω)/Pb, Pr:0.7 Vp-p (75 Ω)/Pin jack:1 system

Audio output: 2 Vrms (1 kHz, 0 dB)/Pin jack
Number of connectors :

7.1 channel discrete output:1 system
(2 channel + 5.1 channel discrete output)

Digital audio output: Optical digital output : Optical terminal
Coaxial digital output : Pin jack

HDMI AV output: Type A (19 pin)
HDMI (Deep Color, x.v.Color™, High Bit rate Audio)
This unit supports "HDAVI Control 5" function.

SD card slot: Connector : 1 system

USB slot: USB2.0 : 2 system

Ethernet: 10BASE-T/100BASE-TX : 1 system

LASER Specification

Class I LASER Product:

Wave length:790 nm (CDs)/655 nm (DVDs)/405 nm (BDs)

Laser power: No hazardous radiation is emitted with the safety protection

Power supply: AC 120 V, 60 Hz

Power consumption: Approx. 26 W

Power consumption in standby mode: Approx. 0.1 W

Power consumption in quick start standby mode: Approx. 8.4 W

Dimensions (W×D×H) Including the projecting parts:
430 mm×249 mm×55 mm

(Approx. 16 15/16"×9 13/16"×2 3/16")

Mass (Weight): Approx. 2.6 kg (5.7 lbs)

Wireless LAN Adaptor (DY-WL10)

Dimensions (W×D×H) 44 mm×27 mm×72 mm
(1 3/4"×1 1/8"×2 7/8")

Mass (Weight): Approx. 29 g (1.02 oz)

Antenna: Tx 1, Rx 2

Interface: USB2.0

Standard Compliance:

IEEE802.11n / IEEE802.11a / IEEE802.11g / IEEE802.11b,

FCC part 15.407 (5 GHz) RSS-210,

FCC part 15.247 (2.4 GHz) RSS-210

Transmission system:

MISO-OFDM system, OFDM system, DSSS system

Frequency Range:

IEEE802.11n / IEEE802.11a:

5.15 GHz - 5.35 GHz/5.725 GHz - 5.825 GHz

IEEE802.11g / IEEE802.11b / IEEE802.11n:

2.4 GHz - 2.4835 GHz

Transfer rate (standard):

IEEE802.11n: Tx Max. 150 Mbps, Rx Max. 300 Mbps

IEEE802.11g / IEEE802.11a: Max. 54 Mbps

IEEE802.11b: Max. 11 Mbps

Access Mode:

Infrastructure mode

Security: WPA2-PSK (TKIP/AES)

WPA-PSK (TKIP/AES)

WEP (64 bit / 128 bit)

(This unit supports WPA and WPA2 encryption.)

Specifications are subject to change without notice.

Supplemental information

■ TV/Amplifier/Receiver code list

Brand	TV Code
Panasonic	0051 / 0055 / 0250 / 0650
FUNAI	0180 / 0171 / 0179
HITACHI	0016 / 0032 / 0038 / 0056 / 0095 / 0097 / 0145 / 0151 / 0173 / 0227 / 0279 / 0409 / 0413 / 1145
INSIGNIA	1564 / 0171 / 1204 / 1326 / 1517 / 1660 / 2002 / 2003 / 2004
JVC	0036 / 0053 / 0069 / 0160 / 0169 / 0182 / 0731 / 1253
LG	0019 / 0030 / 0032 / 0106 / 0178 / 0317 / 0409 / 0442 / 0457 / 0700 / 0856 / 1178 / 1265
MITSUBISHI	0014 / 0019 / 0093 / 0098 / 0150 / 0155 / 0178 / 0331 / 0358 / 0836 / 0868 / 1250
PHILIPS	0054 / 0690 / 1154 / 1454
PIONEER	0038 / 0166 / 0172 / 0679 / 0866
POLAROID	0765 / 0865 / 1262 / 1276 / 1314 / 1316 / 1326 / 1327 / 1328 / 1341 / 1498 / 1523 / 2002
SAMSUNG	0019 / 0030 / 0032 / 0056 / 0060 / 0178 / 0329 / 0408 / 0427 / 0587 / 0702 / 0766 / 0812 / 0814 / 1060
SANYO	0088 / 0107 / 0146 / 0154 / 0159 / 0232 / 0484 / 0799 / 0893
SHARP	0039 / 0093 / 0153 / 0157 / 0165 / 0220 / 0281 / 0386 / 0398 / 0491 / 0688 / 0818 / 0851
SONY	0000 / 0011 / 0080 / 0111 / 0273 / 0353 / 0810 / 0834 / 0867 / 1100
TOSHIBA	0036 / 0060 / 0149 / 0154 / 0156 / 0650 / 0832 / 0845 / 1156 / 1164 / 1256 / 1265 / 1356 / 1656 / 1704
VIZIO	1758 / 0864 / 0885 / 1756
WESTINGHOUSE	0885 / 0889 / 0890 / 1282 / 1577

Brand	Amplifier Code	Receiver Code
Panasonic	0308	1308 / 0039 / 0367 / 1641 / 2001 / 2002
COBY		1513 / 2003
DENON		1360 / 0004 / 0273 / 1142 / 1311
EMERSON		1340 / 2005
HARMAN / KARDON		0110 / 0189 / 1306
INSIGNIA		1030 / 1077 / 1751 / 2004
JVC		0074 / 1374 / 1495 / 1855 / 1871
LG		1293 / 2006
MARANTZ		1189 / 1269 / 0039 / 0189 / 1289
ONKYO		0135 / 0380 / 1298 / 1320
PHILIPS		1189 / 1269 / 0189 / 0391 / 1120 / 1266 / 1368
PIONEER	0823	1023 / 0150 / 0244 / 0531 / 0630 / 1343 / 1384
RCA	0823	1023 / 1609 / 1254 / 0054 / 0530 / 0531 / 1074 / 1390 / 1511
SAMSUNG		1295
SONY	0815 / 1126	1622 / 0158 / 0168 / 0474 / 1367 / 1529 / 1658 / 1758
YAMAHA	0354	0176 / 0186 / 1331

■ Video attribute

Display	Meaning
MPEG-2/MPEG-4 AVC/VC-1	Video recording method
480/576/720/1080	Video Format
24p/50i/60i/50p/60p	Video Frame rate
YCbCr4:2:2/YCbCr4:4:4/RGB	Color Space
bps (bit per second)	Transfer rate of bit

■ Audio attribute

Display	Meaning
LPCM/ Digital/ Digital+/ TrueHD/DTS/DTS 96/DTS-HD HI RES/ DTS-HD MSTR/MPEG	Signal type
ch (channel)	Number of channels
k (kHz)	Sampling frequency
b (bit)	Number of bits
bps (bit per second)	Transfer rate of bit

■ Display languages list

Display Language	Display Language	Display Language
ENG English	JPN Japanese	ARA Arabic
FRA French	CHI Chinese	HIN Hindi
DEU German	KOR Korean	PER Persian
ITA Italian	MAL Malay	IND Indonesian
ESP Spanish	VIE Vietnamese	MRI Maori
NLD Dutch	THA Thai	BUL Bulgarian
SVE Swedish	POL Polish	RUM Romanian
NOR Norwegian	CES Czech	GRE Greek
DAN Danish	SLK Slovak	TUR Turkish
POR Portuguese	HUN Hungarian	* Others
RUS Russian	FIN Finnish	

■ Language code list

Language Code	Language Code	Language Code
Abkhazian: 6566	Gujarati: 7185	Rhaeto-Romance: 8277
Afar: 6565	Hausa: 7265	Romanian: 8279
Afrikaans: 6570	Hebrew: 7387	Russian: 8285
Albanian: 8381	Hindi: 7273	Samoan: 8377
Amharic: 6577	Hungarian: 7285	Sanskrit: 8365
Arabic: 6582	Icelandic: 7383	Scots Gaelic: 7168
Armenian: 7289	Indonesian: 7378	Serbian: 8382
Assamese: 6583	Interlingua: 7365	Serbo-Croatian: 8372
Aymara: 6589	Irish: 7165	Shona: 8378
Azerbaijani: 6590	Italian: 7384	Sindhi: 8368
Bashkir: 6665	Japanese: 7465	Singhalese: 8373
Basque: 6985	Javanese: 7487	Slovak: 8375
Bengali; Bangla: 6678	Kannada: 7578	Slovenian: 8376
Bhutanian: 6890	Kashmiri: 7583	Somali: 8379
Bihari: 6672	Kazakh: 7575	Spanish: 6983
Breton: 6682	Kirghiz: 7589	Sundanese: 8385
Bulgarian: 6671	Korean: 7579	Swahili: 8387
Burmese: 7789	Kurdish: 7585	Swedish: 8386
Byelorussian: 6669	Laotian: 7679	Tagalog: 8476
Cambodian: 7577	Latin: 7665	Tajik: 8471
Catalan: 6765	Latvian, Lettish: 7686	Tamil: 8465
Chinese: 9072	Lingala: 7678	Tatar: 8484
Corsican: 6779	Lithuanian: 7684	Telugu: 8469
Croatian: 7282	Macedonian: 7775	Thai: 8472
Czech: 6783	Malagasy: 7771	Tibetan: 6679
Danish: 6865	Malay: 7783	Tigrinya: 8473
Dutch: 7876	Malayalam: 7776	Tonga: 8479
English: 6978	Maltese: 7784	Turkish: 8482
Esperanto: 6979	Maori: 7773	Turkmen: 8475
Estonian: 6984	Marathi: 7782	Twi: 8487
Faroese: 7079	Moldavian: 7779	Ukrainian: 8575
Fiji: 7074	Mongolian: 7778	Urdu: 8582
Finnish: 7073	Nauru: 7865	Uzbek: 8590
French: 7082	Nepali: 7869	Vietnamese: 8673
Frisian: 7089	Norwegian: 7879	Volapük: 8679
Galician: 7176	Oriya: 7982	Welsh: 6789
Georgian: 7565	Pashto, Pushto: 8083	Wolof: 8779
German: 6869	Persian: 7065	Xhosa: 8872
Greek: 6976	Polish: 8076	Yiddish: 7473
Greenlandic: 7576	Portuguese: 8084	Yoruba: 8979
Guarani: 7178	Punjabi: 8065	Zulu: 9085
	Quechua: 8185	

Glossary

AVCHD

AVCHD is a new format (standard) for high definition video cameras that can be used to record and play high-resolution HD images.

BD-J

Some BD-Video discs contain Java applications, and these applications are called BD-J. You can enjoy various interactive features in addition to playing normal video.

Deep Color

Deep Color is a name for device that can reproduce greater color gradation (4096 steps) when connected to a TV that supports the Deep Color with HDMI cable. You can enjoy exceptionally rich, natural-looking colors, with smooth, detailed gradation and minimal color banding. [A lower color gradation (256 steps), without Deep Color, will be reproduced if connected to a TV which does not support Deep Color. The unit will automatically set appropriate output to suit the connected TV.]

Dolby Digital

This is a method of coding digital signals developed by Dolby Laboratories. Apart from stereo (2-channel) audio, these signals can also be multi-channel audio.

Dolby Digital Plus

Multi-channel audio and higher audio quality is made possible using Dolby Digital Plus. BD-Video supports up to 7.1 channel output.

Dolby TrueHD

Dolby TrueHD is a very high quality audio format that reproduces the studio master audio. BD-Video supports up to 7.1 channel output.

DTS (Digital Theater Systems)

This surround system is used in many movie theaters. There is good separation between the channels, so realistic sound effects are possible.

DTS-HD

DTS-HD is a high-quality, sophisticated audio format used in movie theaters. Previous DTS Digital Surround-compatible equipment can play DTS-HD as DTS Digital Surround audio. BD-Video supports up to 7.1 channel output.

DTS-HD High Resolution Audio

This is a signal format achieved by improving the previous DTS, DTS-ES and DTS96/24 formats. It is compatible with sampling frequency 96 kHz/48 kHz. BD-Video supports up to 7.1 channel output.

DTS-HD Master Audio

This is a lossless audio format and compatible with 96 kHz/7.1ch or less. In addition, faithful reproduction of the master audio is enabled using lossless audio encoding technology. BD-Video supports up to 7.1 channel output.

HDMI (High-Definition Multimedia Interface)

HDMI is a digital interface for consumer electronic products. Unlike conventional connections, it transmits uncompressed digital video and audio signals on a single cable.

Local storage

This storage area is used as a destination for sub contents for playing BD-Live on BD-Video.

LPCM (Linear PCM)

These are a kind of PCM format.

These are uncompressed digital signals, similar to those found on CDs.

P4HD (Pixel Precision Progressive Processing for HD)

This is a processor which makes use of an exclusive Panasonic algorithm. Various processing is supported, including a high-level conversion of the TV scanning format from interlace to progressive and a high-level conversion of standard resolution (480i or 576i) video signal to a 1080 High Definition video signal.

Consequently, this unit is able to provide video of optimal resolution to the connected TV.

PCM (Pulse Code Modulation)

This is one format for converting analog audio into digital audio, enabling you to enjoy digital audio with no hassle.

x.v.Color™

x.v.Color™ is a name for devices that are compatible with the xvYCC format, an international standard for expanded color in motion pictures, and that follow the rules for signal transmission.

You can enjoy vivid colors of wider color ranges for a more realistic picture when connected to a TV that supports the x.v.Color™ with HDMI cable.

24p

This is a progressive image recorded at a rate of 24 frames per second (motion-picture film). Many BD-Video movie contents are recorded in 24 frames/second in accordance with the film materials.

Limited Warranty (ONLY FOR U.S.A. AND PUERTO RICO)

Panasonic Consumer Electronics Company,
Division of Panasonic Corporation of North America
One Panasonic Way, Secaucus, New Jersey 07094

Panasonic Blu-ray and DVD Products Limited Warranty

Limited Warranty Coverage (For USA and Puerto Rico Only)

If your product does not work properly because of a defect in materials or workmanship, Panasonic Consumer Electronics Company (referred to as "the warrantor") will, for the length of the period indicated on the chart below, which starts with the date of original purchase ("warranty period"), at its option either (a) repair your product with new or refurbished parts, (b) replace it with a new or a refurbished equivalent value product, or (c) refund your purchase price. The decision to repair, replace or refund will be made by the warrantor.

Product or Part Name	Parts	Labor
Blu-ray Disc Player, Portable Blu-ray Disc Player	1 year	90 days
Blu-ray Home Theater System	1 year	1 year
DVD Player, Portable DVD Player	1 year	90 days
DVD Recorder	1 year	90 days
Rechargeable Batteries (pack), DVD-RAM Disc (defective exchange)	10 days	Not Applicable
Wireless LAN adaptor	90 days	Not Applicable

During the "Labor" warranty period there will be no charge for labor. During the "Parts" warranty period, there will be no charge for parts. This Limited Warranty excludes both parts and labor for non-rechargeable batteries, antennas, and cosmetic parts (cabinet). This warranty only applies to products purchased and serviced in the United States or Puerto Rico. This warranty is extended only to the original purchaser of a new product which was not sold "as is".

Mail-In Service

For assistance in the U.S.A. and Puerto Rico in obtaining repairs, please ship the product prepaid to:

Panasonic Exchange Center
4900 George McVay Drive
Suite B
McAllen, TX 78503
panacare@us.panasonic.com

When shipping the unit, carefully pack, include all accessories, and send it prepaid, adequately insured and preferably in the original carton. If Lithium Ion batteries are shipped by air the package must be labeled "Contains Lithium Ion Battery (No lithium metal)". Damaged batteries are prohibited from shipment by US Mail. Batteries must be securely packed in a manner to prevent short-circuiting and a package cannot contain more than 3 Lithium Ion batteries. Include a letter detailing the complaint, a return address and provide a daytime phone number where you can be reached. A valid registered receipt is required under the Limited Warranty.

IF REPAIR IS NEEDED DURING THE WARRANTY PERIOD, THE PURCHASER WILL BE REQUIRED TO FURNISH A SALES RECEIPT/PROOF OF PURCHASE INDICATING DATE OF PURCHASE, AMOUNT PAID AND PLACE OF PURCHASE. CUSTOMER WILL BE CHARGED FOR THE REPAIR OF ANY UNIT RECEIVED WITHOUT SUCH PROOF OF PURCHASE.

Limited Warranty Limits And Exclusions

This warranty ONLY COVERS failures due to defects in materials or workmanship, and DOES NOT COVER normal wear and tear or cosmetic damage. The warranty ALSO DOES NOT COVER damages which occurred in shipment, or failures which are caused by products not supplied by the warrantor, or failures which result from accidents, misuse, abuse, neglect, mishandling, misapplication, alteration, faulty installation, set-up adjustments, misadjustment of consumer controls,

improper maintenance, power line surge, lightning damage, modification, introduction of sand, humidity or liquids, commercial use such as hotel, office, restaurant, or other business or rental use of the product, or service by anyone other than a Factory Service Center or other Authorized Servicer, or damage that is attributable to acts of God. **THERE ARE NO EXPRESS WARRANTIES EXCEPT AS LISTED UNDER "LIMITED WARRANTY COVERAGE".**

THE WARRANTOR IS NOT LIABLE FOR INCIDENTAL OR CONSEQUENTIAL DAMAGES RESULTING FROM THE USE OF THIS PRODUCT, OR ARISING OUT OF ANY BREACH OF THIS WARRANTY.

(As examples, this excludes damages for lost time, travel to and from the servicer, loss of or damage to media or images, data or other memory or recorded content. The items listed are not exclusive, but for illustration only.)

ALL EXPRESS AND IMPLIED WARRANTIES, INCLUDING THE WARRANTY OF MERCHANTABILITY, ARE LIMITED TO THE PERIOD OF THE LIMITED WARRANTY.

Some states do not allow the exclusion or limitation of incidental or consequential damages, or limitations on how long an implied warranty lasts, so the exclusions may not apply to you.

This warranty gives you specific legal rights and you may also have other rights which vary from state to state. If a problem with this product develops during or after the warranty period, you may contact your dealer or Service Center. If the problem is not handled to your satisfaction, then write to the warrantor's Consumer Affairs Department at the addresses listed for the warrantor.

PARTS AND SERVICE, WHICH ARE NOT COVERED BY THIS LIMITED WARRANTY, ARE YOUR RESPONSIBILITY.

Customer Services Directory (United States and Puerto Rico)

Obtain Product Information and Operating Assistance; locate your nearest Dealer or Service Center; purchase Parts and Accessories; or make Customer Service and Literature requests by visiting our Web Site at:

<http://www.panasonic.com/help>

or, contact us via the web at:

<http://www.panasonic.com/contactinfo>

You may also contact us directly at:

1-800-211-PANA (7262)

Monday-Friday 9am-9pm, Saturday-Sunday 10am-7pm EST

For hearing or speech impaired TTY users, TTY: 1-877-833-8855

Accessory Purchases (United States and Puerto Rico)

Purchase Parts, Accessories and Instruction Books online for all Panasonic Products by visiting our Web Site at:

<http://www.pstc.panasonic.com>

Or, send your request by E-mail to:

npcparts@us.panasonic.com

You may also contact us directly at:

1-800-332-5368 (Phone) 1-800-237-9080 (Fax Only)

(Monday-Friday 9am-9pm EST)

Panasonic Service and Technology Company

20421 84th Avenue South, Kent, WA 98032

(We accept Visa, MasterCard, Discover Card, American Express, and Personal Checks)

For hearing or speech impaired TTY users, TTY: 1-866-605-1277

As of November 2009

User memo:

DATE OF PURCHASE _____

DEALER NAME _____

DEALER ADDRESS _____

TELEPHONE NUMBER _____

The model number and serial number of this product can be found on either the back or the bottom of the unit.

Please note them in the space provided below and keep for future reference.

MODEL NUMBER _____ DMP-BD85 _____

SERIAL NUMBER _____

Limited Warranty (Only for CANADA)

Panasonic Canada Inc.

PANASONIC PRODUCT—LIMITED WARRANTY

Panasonic Canada Inc. warrants this product to be free from defects in material and workmanship and agrees to remedy any such defect for a period as stated below from the date of original purchase.

Technics Audio Product	One (1) year, parts and labour
Panasonic Portable/Clock Radio (without Tape, CD, MD)	One (1) year, parts and labour
Panasonic Audio/SD Audio Product	One (1) year, parts and labour
Panasonic BD/DVD Product	One (1) year, parts and labour
Panasonic Combination DVD Player/VCR	One (1) year, parts and labour
Panasonic Combination DVD Recorder/VCR	One (1) year, parts and labour
Accessories including rechargeable batteries	Ninety (90) days

LIMITATIONS AND EXCLUSIONS

This warranty does not apply to products purchased outside Canada or to any product which has been improperly installed, subjected to usage for which the product was not designed, misused or abused, damaged during shipping, or which has been altered or repaired in any way that affects the reliability or detracts from the performance, nor does it cover any product which is used commercially. Dry cell batteries are also excluded from coverage under this warranty.

This warranty is extended to the original end user purchaser only. A purchase receipt or other proof of date of original purchase is required before warranty service is performed.

THIS EXPRESS, LIMITED WARRANTY IS IN LIEU OF ALL OTHER WARRANTIES, EXPRESS OR IMPLIED, INCLUDING ANY IMPLIED WARRANTIES OF MERCHANTABILITY AND FITNESS FOR A PARTICULAR PURPOSE. IN NO EVENT WILL PANASONIC CANADA INC. BE LIABLE FOR ANY SPECIAL, INDIRECT OR CONSEQUENTIAL DAMAGES.

In certain instances, some jurisdictions do not allow the exclusion or limitation of incidental or consequential damages, or the exclusion of implied warranties, so the above limitations and exclusions may not be applicable.

WARRANTY SERVICE

FOR PRODUCT OPERATION ASSISTANCE, please contact:

Our Customer Care Centre:	Telephone #:	(905) 624-5505
	1-800 #:	1-800-561-5505
	Fax #:	(905) 238-2360
	Email link:	"Customer support" on www.panasonic.ca

FOR PRODUCT REPAIRS, please locate your nearest Authorized Servicentre at www.panasonic.ca :

Link : "Servicentres™ locator" under "Customer support"

IF YOU SHIP THE PRODUCT TO A SERVICENTRE

Carefully pack and send prepaid, adequately insured and preferably in the original carton.
Include details of the defect claimed, and proof of date of original purchase.

Referencia rápida en español

(Spanish Quick Reference)

Conexiones básicas

Conexión a un televisor compatible con HDMI

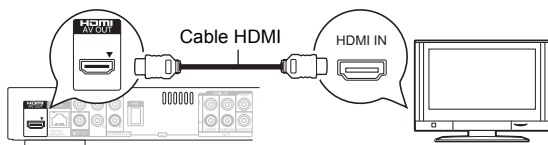

Conexión a un televisor con un cable para audio/vídeo

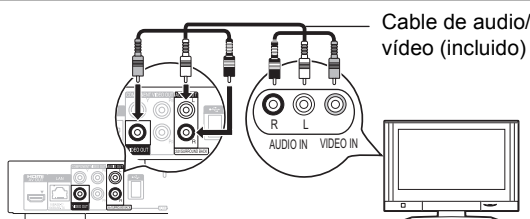

Conexión a un televisor compatible con HDMI y a un amplificador/receptor compatible con HDMI

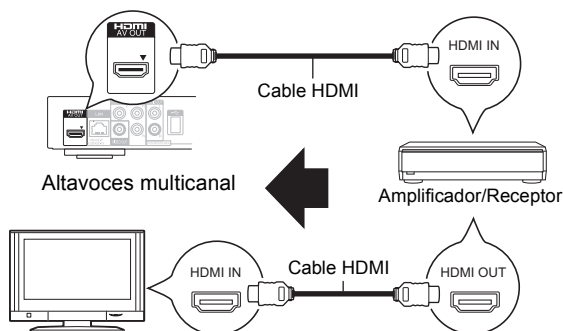

Conecte el cable de alimentación de CA por último

A una toma de corriente doméstica

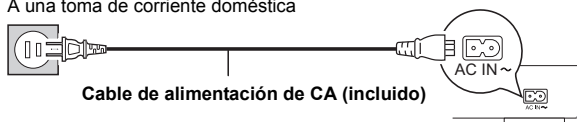

- Conéctelo cuando haya realizado el resto de conexiones.

Ahorro de energía

Esta unidad consume una pequeña cantidad de energía aunque esté ajustada en el modo de espera (Accionamiento rápido : Desactivado, aprox. 0,1 W). Para ahorrar energía cuando no vaya a utilizar la unidad durante mucho tiempo, desenchúfela de la toma de corriente.

Reproducción básica

Preparación

Encienda el televisor y seleccione la entrada de vídeo adecuada en el televisor.

- 1 Pulse [POWER] para encender la unidad.

Después de conectar su nuevo reproductor y pulsar el botón de encendido, aparecerá la pantalla de la configuración básica.

- 2 Inserte el medio.

Inicia la reproducción

Pulse [▶] (PLAY).

Parada

Pulse [■].

La posición de detención se memoriza.

Función de reanudación de la reproducción

Pulse [▶] (PLAY) para reiniciar la reproducción desde esta posición.

- La posición se borra si se abre la bandeja o se pulsa [■] varias veces para visualizar "STOP" en el visor de la unidad.
- En los discos BD-Vídeo incluidos los BD-J, la función de reanudación de la reproducción no funciona.

Pausa

Pulse [⏸].

- Pulse [⏸] otra vez o [▶] (PLAY) para reiniciar la reproducción.

Búsqueda/Cámara lenta

Búsqueda

Durante la reproducción, pulse [◀◀] o [▶▶].

- Música y MP3: La velocidad está fija en un paso.

Cámara lenta

Durante la pausa, pulse [◀◀] o [▶▶].

- BD-Vídeo y AVCHD: Sólo dirección en avance [▶▶].

La velocidad aumenta hasta 5 pasos.

- Pulse [▶] (PLAY) para recuperar la velocidad de reproducción normal.

Salto

Durante la reproducción o la pausa, pulse [◀◀◀] o [▶▶▶].

Salta hasta el título, capítulo o pista que desee reproducir.

- Cada pulsación aumenta el número de saltos.

Java and all Java-based trademarks and logos are trademarks or registered trademarks of Sun Microsystems, Inc. in the United States and other countries.
Manufactured under license from Dolby Laboratories. Dolby and the double-D symbol are trademarks of Dolby Laboratories.
Manufactured under license under U.S. Patent #'s: 5,451,942; 5,956,674; 5,974,380; 5,978,762; 6,226,616; 6,487,535; 7,392,195; 7,272,567; 7,333,929; 7,212,872 & other U.S. and worldwide patents issued & pending. DTS and the Symbol are registered trademarks, & DTS-HD, DTS-HD Master Audio Essential and the DTS logos are trademarks of DTS, Inc. Product includes software. © DTS, Inc. All Rights Reserved.
This product incorporates copyright protection technology that is protected by U.S. patents and other intellectual property rights. Use of this copyright protection technology must be authorized by Macrovision, and is intended for home and other limited viewing uses only unless otherwise authorized by Macrovision. Reverse engineering or disassembly is prohibited.
HDMI, the HDMI Logo, and High-Definition Multimedia Interface are trademarks or registered trademarks of HDMI Licensing LLC in the United States and other countries.
This product is licensed under the AVC patent portfolio license and VC-1 patent portfolio license for the personal and non-commercial use of a consumer to (i) encode video in compliance with the AVC Standard and VC-1 Standard ("AVC/VC-1 Video") and/or (ii) decode AVC/VC-1 Video that was encoded by a consumer engaged in a personal and non-commercial activity and/or was obtained from a video provider licensed to provide AVC/VC-1 Video. No license is granted or shall be implied for any other use. Additional information may be obtained from MPEG LA, LLC. See http://www.mpegla.com .
HDAVI Control™ is a trademark of Panasonic Corporation.
x.v.Color™ is a trademark.
VIERA Link™ is a trademark of Panasonic Corporation.
VIERA CAST™ is a trademark of Panasonic Corporation.
EZ Sync™ is a trademark of Panasonic Corporation.
"AVCHD" and the "AVCHD" logo are trademarks of Panasonic Corporation and Sony Corporation.
SDXC Logo is a trademark of SD-3C, LLC.
DivX® is a registered trademark of DivX, Inc., and is used under license.
"Blu-ray Disc" is trademark.
"BD-LIVE" logo is trademark of Blu-ray Disc Association.
"BONUSVIEW" is trademark of Blu-ray Disc Association.
YouTube and Picasa are trademarks of Google, Inc.
The Wi-Fi CERTIFIED Logo is a certification mark of the Wi-Fi Alliance.

This product incorporates the following software:

- (1) the software developed independently by or for Panasonic Corporation,
- (2) the software owned by third party and licensed to Panasonic Corporation,
- (3) the software licensed under the GNU General Public License, Version 2 (GPL v2),
- (4) the software licensed under the GNU LESSER General Public License, Version 2.1 (LGPL v2.1) and/or,
- (5) open sourced software other than the software licensed under the GPL v2 and/or LGPL v2.1

For the software categorized as (3) and (4), please refer to the terms and conditions of GPL v2 and LGPL v2.1, as the case may be at <http://www.gnu.org/licenses/old-licenses/gpl-2.0.html> and <http://www.gnu.org/licenses/old-licenses/lgpl-2.1.html>. In addition, the software categorized as (3) and (4) are copyrighted by several individuals. Please refer to the copyright notice of those individuals at <http://www.am-linux.jp/dl/JPRCBW98>

The GPL/LGPL software is distributed in the hope that it will be useful, but WITHOUT ANY WARRANTY, without even the implied warranty of MERCHANTABILITY or FITNESS FOR A PARTICULAR PURPOSE.

At least three (3) years from delivery of products, Panasonic will give to any third party who contact us at the contact information provided below, for a charge no more than our cost of physically performing source code distribution, a complete machine-readable copy of the corresponding source code covered under GPL v2/LGPL v2.1.

Contact Information
cdrequest@am-linux.jp

Source code is also freely available to you and any other member of the public via our website below.
<http://www.am-linux.jp/dl/JPRCBW98>

Index

A AC Power Connection	11	I IP address	29	Q Quick Start	29
Angle	24	J JPEG	20, 35	R Random play	25
Audio		L LAN	10	Re-master	25
Changing audio	16	Language		Remote control	4, 5, 14
Channel	24	Audio	24, 26	Repeat play	25
Language	24, 26	Menu	26	Restore Default Settings	29
AVCHD	35	On-screen	27	Resume play function	16
B BD-Live	18	Soundtrack	24	S SD card	7, 18
BD-Video Ratings	26	Subtitle	24, 26	Setup menu	26
BONUSVIEW	18	Local storage	39	Slideshow	20
C Chapter	17	M MPEG2	35	Slow-motion	16
Cleaning	4	MP3	21, 35	Soundtrack	24
Connection	8, 9, 10, 11	N Network		Status Message	16
D Deep Color	39	Connection	10	Still picture	20
Direct Navigator	16	Setting	12, 29	Subtitle	24
DivX	19, 35	O Off Timer	29	U USB device	7
DNS Server	29	On-screen Language	27	V VIERA CAST™	23
Dolby Digital	27, 33	P Picture-in-picture	18	VIERA Link™	
Dolby Digital Plus	27, 33	Playback		“HDAVI Control™”	22
Dolby TrueHD	27, 33	AVCHD	16	W Wireless LAN	10
DTS	27, 33	DivX	16	X x.v.Color™	39
DTS-HD	27, 33	JPEG	20		
DVD-Video Ratings	26	MPEG2	16		
F Finalize	7	MP3	21		
Firmware update	14	Playlists	15		
Frame-by-frame	16	Pop-up menu	16		
H HDMI	8, 9	Proxy Server	29		
		P4HD	39		

24p 25, 28

Information on Disposal in other Countries outside the European Union



This symbol is only valid in the European Union. If you wish to discard this product, please contact your local authorities or dealer and ask for the correct method of disposal.

CAUTION	VISIBLE AND INVISIBLE LASER RADIATION WHEN OPEN. DO NOT STARE INTO BEAM. FDA 21 CFR/Class II (IIa)
CAUTION	CLASS 1M VISIBLE AND INVISIBLE LASER RADIATION WHEN OPEN. DO NOT VIEW DIRECTLY WITH OPTICAL INSTRUMENTS. IEC60825-1, -2/CLASS 1M
ATTENTION	RAYONNEMENT LASER VISIBLE ET INVISIBLE, CLASSE 1M. EN CAS D'OUVERTURE, NE PAS REGARDER DIRECTEMENT À L'AIDE D'INSTRUMENTS D'OPTIQUE.
FORSIGTIG	SYNLIG OG USYNLIG LASERSTRÅLING KLASSE 1M. NÅR LAGET ER ÅBENT, UNDGÅ AT SE LIGE PÅ MED OPTISKE INSTRUMENTER.
VARO	AVATTAESSA OLET ALTTIINA LUOKAN 1M NÄKYYVÄÄ JA NÄKYMÄTÖNTÄ LASERSÄTELYÄ. ÄLÄ KATSO OPTISELLA LAITTEELLA SUORAAN SÄTEESEEN.
WARNING	KLASS 1M SYNLIG OCH OSYNLIG LASERSTRÅLNING NÅR DENNA DEL ÄR ÖPPNAD. BETRÄKTA EJ STRÅLEN DIREKT GENOM OPTISKT INSTRUMENT.
VORSICHT	SICHTBARE UND UNSICHTBARE LASERSTRALHUNG KLASSE 1M. WENN ABDECKUNG GEÖFFNET, NICHT DIREKT MIT OPTISCHEN INSTRUMENTEN BETRACHTEN.
注意	— 打开时有可见及不可见激光辐射。避免光束照射。
注意	— ここを開くと可視及び不可視レーザー光が出ます。ビームを見たり、触れたりしないでください。 VQL1V70

(Inside of product)

Panasonic Consumer Electronics Company, Division of Panasonic Corporation of North America
One Panasonic Way, Secaucus, New Jersey 07094
<http://www.panasonic.com>

Panasonic Canada Inc.
5770 Ambler Drive
Mississauga, Ontario
L4W 2T3
www.panasonic.ca

