

Panasonic®

Owner's Manual for advanced features

Digital Camera

Model No. **DMC-ZS30**
DMC-ZS27

LUMIX

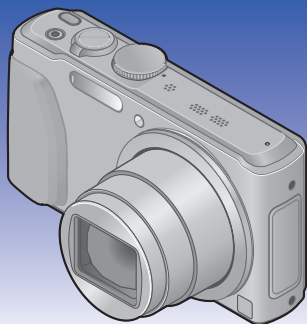

Please read these instructions carefully before using this product, and save this manual for future use.



Register online at
www.panasonic.com/register
(U.S. customers only)

VQT4T08-1
M0113KZ1013

Contents

Before use

| | |
|--|----|
| Before use | 8 |
| About GPS DMC-ZS30 | 10 |
| About the compass DMC-ZS30 | 11 |
| Standard Accessories | 12 |
| Names and Functions of Main Parts ... | 13 |
| Cursor button | 14 |
| Touch operations | 15 |

Preparations

| | |
|--|----|
| Charging battery | 16 |
| Inserting the battery | 17 |
| Charging the battery..... | 18 |
| Remaining battery..... | 20 |
| Guidelines for number of recordable pictures and operating time..... | 20 |
| Inserting and removing the card (optional) | 22 |
| Saving your pictures (cards and built-in memory) | 23 |
| Recording capacity guidelines (pictures/recording time) | 24 |
| Setting the clock | 26 |
| To change time setting | 27 |

Basics

| | |
|--|----|
| Sequence of operations | 28 |
| Taking pictures with your own settings [Program AE] Mode | 30 |
| How to adjust focus | 31 |
| Touching the screen and recording (Touch Shutter function) | 32 |
| Touching the screen and adjusting the focus and exposure (Touch AF/AE function) | 33 |
| Taking pictures with automatic settings [Intelligent Auto] Mode | 34 |
| About flash | 34 |
| Automatic Scene Detection | 35 |
| About the Happy color setting | 35 |
| [Motion Deblur]..... | 36 |
| [iHandheld Nite Shot] | 36 |
| [iHDR]..... | 37 |
| AF Tracking..... | 38 |
| [Intelligent Auto] Mode restrictions | 39 |
| Recording motion pictures | 40 |
| About recording modes | 41 |
| Recording still pictures while a motion picture is being recorded..... | 44 |
| Viewing your pictures | 45 |
| Zooming in and viewing "Playback Zoom" | 46 |
| Viewing a list of pictures "Multi Playback" | 47 |
| Viewing pictures by their recording date [Calendar]..... | 48 |
| Viewing motion pictures | 49 |
| Capturing still pictures from motion pictures..... | 51 |
| Deleting pictures | 52 |
| To delete multiple (up to 100)/ To delete all pictures | 53 |
| Setting the menu | 54 |
| Menu type | 55 |
| Using Quick menu..... | 56 |

| | |
|---|-----------|
| Using the [Setup] menu | 57 |
| [Clock Set]..... | 57 |
| [Auto Clock Set] DMC-ZS30 | 57 |
| [World Time]..... | 57 |
| [Travel Date]..... | 57 |
| [Airplane Mode]..... | 57 |
| [Beep]..... | 58 |
| [Speaker Volume]..... | 58 |
| [Cust.Set Mem.]..... | 58 |
| [Monitor Display]..... | 59 |
| [Calibrate compass] DMC-ZS30 | 59 |
| [Monitor Luminance]..... | 59 |
| [Guide Line]..... | 60 |
| [Histogram]..... | 60 |
| [Video Rec Area]..... | 61 |
| [Remaining Disp.]..... | 61 |
| [Zoom Resume]..... | 61 |
| [Economy]..... | 62 |
| [Auto Review]..... | 62 |
| [No.Reset]..... | 63 |
| [Reset]..... | 63 |
| [Reset Wi-Fi Settings]..... | 63 |
| [USB Mode]..... | 64 |
| [Output]..... | 64 |
| [VIERA Link]..... | 64 |
| [3D Playback]..... | 65 |
| [Rotate Disp.]..... | 65 |
| [Version Disp.]..... | 65 |
| [Format]..... | 66 |
| [Language]..... | 66 |
| [Demo Mode]..... | 67 |

Application (Record)

| | |
|---|-----------|
| Switching the display of recording information, etc..... | 68 |
| Using the level gauge DMC-ZS30 | 69 |
| Using Zoom..... | 70 |
| Using the zoom by performing touch operations | 71 |
| Zoom types and use..... | 72 |
| Taking pictures with flash..... | 74 |
| Taking close-up pictures | 76 |
| [Macro Zoom]..... | 77 |
| Focus range | 78 |
| Taking pictures with self-timer..... | 79 |
| Taking pictures with Exposure Compensation..... | 80 |
| Recording while exposure is changed automatically ([Auto Bracket]) | 81 |
| Determine aperture and shutter speed and record | 82 |
| [Aperture-Priority] Mode..... | 82 |
| [Shutter-Priority] Mode | 83 |
| [Manual Exposure] Mode | 84 |
| Taking Pictures with different picture effects [Creative Control] mode | 85 |
| [Expressive]..... | 86 |
| [Retro] | 86 |
| [High Key]..... | 86 |
| [Low Key] | 87 |
| [Sepia]..... | 87 |
| [Dynamic Monochrome] | 87 |
| [Impressive Art] | 88 |
| [High Dynamic]..... | 88 |
| [Cross Process]..... | 88 |
| [Toy Effect] | 89 |
| [Miniature Effect] | 89 |
| [Soft Focus]..... | 90 |
| [Star Filter]..... | 90 |
| [One Point Color]..... | 91 |
| Recording panorama pictures [Panorama Shot] Mode | 92 |

Taking pictures according to the scene

| | |
|----------------------------|-----------|
| [Scene Mode] | 95 |
| [Portrait]..... | 96 |
| [Soft Skin]..... | 96 |
| [Scenery]..... | 96 |
| [Sports]..... | 97 |
| [Night Portrait]..... | 97 |
| [Night Scenery]..... | 97 |
| [Handheld Night Shot]..... | 98 |
| [HDR] | 98 |
| [Food]..... | 98 |
| [Baby]..... | 99 |
| [Pet]..... | 99 |
| [Sunset]..... | 99 |
| [High Sens.]..... | 100 |
| [Starry Sky]..... | 100 |
| [Glass Through]..... | 100 |
| [Underwater]..... | 101 |
| [High Speed Video] | 102 |
| [3D Photo Mode]..... | 103 |

Register your own settings and record

| | |
|----------------------------|------------|
| [Custom] Mode | 104 |
| [Cust.Set Mem.] | 104 |
| [Custom]..... | 105 |

Burst function 106**Recording with the Face Recognition**

| | |
|---|------------|
| function [Face Recog.]..... | 108 |
| Registering face pictures | 110 |
| Editing or deleting information about registered persons | 111 |

Useful features for travel 112

| | |
|--------------------|-----|
| [Travel Date]..... | 112 |
| [World Time] | 113 |

Entering Text..... 114**Using the [Rec] menu.....** 115

| | |
|-----------------------------|-----|
| [Aspect Ratio]..... | 115 |
| [Picture Size] | 115 |
| [Quality]..... | 116 |
| [Sensitivity]..... | 116 |
| [Extended ISO]..... | 117 |
| [White Balance]..... | 117 |
| [AF Mode]..... | 119 |
| [Quick AF]..... | 120 |
| [Face Recog.]..... | 121 |
| [Metering Mode] | 121 |
| [i.Exposure]..... | 121 |
| [Min. Shtr Speed] | 122 |
| [i.Resolution] | 122 |
| [Digital Zoom]..... | 122 |
| [Burst]..... | 123 |
| [Color Mode]..... | 123 |
| [AF Assist Lamp] | 123 |
| [Red-Eye Removal]..... | 124 |
| [Motion Deblur]..... | 124 |
| [iHandheld Nite Shot] | 124 |
| [iHDR]..... | 124 |
| [Stabilizer] | 125 |
| [Date Stamp] | 125 |
| [Clock Set]..... | 125 |

Using the [Motion Picture] menu 126

| | |
|---|-----|
| [Rec Format] | 126 |
| [Rec Quality]..... | 126 |
| [Still Picture Size]..... | 127 |
| [Continuous AF]..... | 127 |
| Level Shot function DMC-ZS30 | 128 |
| [Wind Cut] | 128 |

Application (View)

| | |
|---|-----|
| Changing the picture information display, etc. | 129 |
| Playing back still pictures recorded using the burst function | 130 |
| Different playback methods | |
| [Playback Mode] | 132 |
| [2D/3D Settings] | 132 |
| Selecting pictures to play back | |
| [Filtering Play] | 133 |
| Narrowing down by selecting picture type | 134 |
| Narrowing down by selecting place name or landmark name of the location where the pictures were taken DMC-ZS30 | 134 |
| Narrowing down by selecting the location where the pictures were taken DMC-ZS30 | 135 |
| Narrowing down by selecting pictures recorded at a destination | 136 |
| Narrowing down by selecting picture category or a person in the picture | 136 |
| Narrowing down by selecting recording date | 137 |
| Narrowing down by selecting favorite pictures | 137 |
| Playing back pictures in order automatically [Slide Show] | 138 |
| Searching by recording date | |
| [Calendar] | 140 |
| Retouching pictures | 141 |
| [Auto Retouch] | 141 |
| [Creative Retouch] | 142 |

| | |
|---------------------------------------|-----|
| Using the [Playback] menu | 144 |
| [Location Logging] | 144 |
| [Title Edit] | 146 |
| [Edit GPS Data] DMC-ZS30 | 146 |
| [Text Stamp] | 147 |
| [Retouch] | 149 |
| [Video Divide] | 149 |
| [Resize] | 150 |
| [Cropping] | 152 |
| [Favorite] | 153 |
| [Print Set] | 154 |
| [Protect] | 155 |
| [Face Rec Edit] | 156 |
| [Copy] | 157 |

GPS and map functions

DMC-ZS30

| | |
|--|-----|
| Using the GPS function to record the location of a picture | 158 |
| [GPS Setting] | 159 |
| Executing the positioning function right away to update the current location | 162 |
| [Area Info. Set] | 164 |
| [Airplane Mode] | 164 |
| Changing the place name information to be recorded | 165 |
| Changing the recorded GPS information | 166 |
| [Edit Location] | 166 |
| [Edit Place Name] | 167 |
| Adjusting the time using GPS | 168 |
| Reducing the time required for positioning | 169 |
| Using the "GPS Assist Tool" | 169 |
| Using the Wi-Fi function to update | 173 |
| Checking the expiration date of the GPS assist data | 174 |

| | | | |
|--|------------|---|------------|
| Using the map function..... | 175 | Remote Shooting..... | 197 |
| Confirming the place where you took a picture using a map..... | 175 | Installing the smartphone/tablet app "Panasonic Image App"..... | 197 |
| Displaying your current location on a map..... | 176 | Connecting to a smartphone/tablet..... | 198 |
| Displaying only pictures taken in the same area..... | 177 | Taking pictures via a smartphone/tablet (remote recording)..... | 200 |
| Displaying a map by selecting a country or region..... | 178 | Playing back pictures in the camera..... | 200 |
| Using the map data on the disc (supplied)..... | 179 | Sending location information to the camera from a smartphone/tablet..... | 201 |
| Installing "LUMIX Map Tool"..... | 179 | Easily connect to a smartphone (NFC)..... | 202 |
| Copying the map data to a memory card..... | 180 | Connecting easily to a smartphone for remote control..... | 203 |
| Registering my landmark..... | 182 | Transferring a still picture easily to your smartphone..... | 204 |
| Registering my landmark from a map..... | 182 | Connecting via a wireless access point..... | 205 |
| Registering the recording location as my landmark..... | 183 | When connecting with [WPS (Push-Button)]..... | 205 |
| Selecting My landmark and displaying it on a map..... | 184 | When connecting with [WPS (PIN code)]..... | 206 |
| Editing or deleting my registered landmark..... | 184 | If you are not sure about the WPS compatibility (connecting by [Manual Connection])..... | 206 |
| Using the compass..... | 185 | Connecting directly..... | 208 |
| Adjusting the compass..... | 186 | Playback on TV..... | 209 |
| Using the GPS log..... | 187 | Displaying the picture on TV right after taking it/Displaying the picture on TV by playing it back on the camera..... | 209 |
| Recording the GPS log..... | 187 | Send Images While Recording..... | 211 |
| Displaying the GPS log on the map..... | 188 | When sending images to smartphone/tablet..... | 211 |
| Outputting the GPS log file..... | 189 | Changing the settings for sending images..... | 214 |
| Deleting the GPS log..... | 190 | When sending images to PC..... | 215 |
| | | To create a folder that receives images..... | 217 |
| | | When sending images to [Cloud Sync. Service]..... | 218 |
| | | When sending images to WEB Service..... | 220 |
| | | When sending images to AV device..... | 222 |
| Wi-Fi | | | |
| Wi-Fi® function..... | 191 | | |
| [Airplane Mode]..... | 193 | | |
| What you can do with the Wi-Fi function..... | 194 | | |
| Sequence of connecting operation... .. | 195 | | |
| What you can do with the [Wi-Fi] button when connected to Wi-Fi..... | 196 | | |

| | |
|---|------------|
| Send Images Stored in the Camera | 224 |
| When sending images to smartphone/tablet | 224 |
| When sending images to PC..... | 227 |
| When sending images to [Cloud Sync. Service]..... | 229 |
| When sending images to WEB Service | 231 |
| When sending images to AV device..... | 233 |
| When sending images to Printer..... | 235 |
| Connecting with a setting you used before (Connect from History) | 236 |
| Connect from Favorites | 237 |
| Transferring pictures automatically [Smart Transfer] | 238 |
| Setting [Smart Transfer]..... | 239 |
| [Smart Transfer] | 240 |
| Changing transfer destination and settings of pictures | 241 |
| Using “LUMIX CLUB” | 243 |
| About the [LUMIX CLUB] | 243 |
| Check or change the acquired login ID/password | 245 |
| To set the same login ID for the camera and the smartphone/tablet | 246 |
| Check the “LUMIX CLUB” terms of use | 246 |
| Delete your login ID and account from the “LUMIX CLUB” | 247 |
| Using WEB services..... | 248 |
| Configuring the external AV device settings..... | 249 |
| How to Use the [Wi-Fi Setup] Menu | 251 |
| Connecting with other devices | |
| Viewing on TV screen | 253 |
| VIERA Link (HDMI) (HDAVI Control™) | 255 |
| Viewing 3D still pictures | 257 |
| Keeping the still pictures and motion pictures in the recorder | 259 |
| Copy by inserting the SD card into the recorder..... | 259 |
| Dubbing playback pictures via AV cables (optional) | 259 |
| Keeping the still pictures and motion pictures on your PC | 260 |
| About supplied softwares | 261 |
| Installing supplied software | 263 |
| Copying still pictures and motion pictures..... | 264 |
| Printing | 267 |
| Printing multiple pictures | 269 |
| Print with date and text..... | 269 |
| Making print settings on the camera | 270 |
| Others | |
| Using the AC adaptor (optional) and DC coupler (optional) instead of the battery | 271 |
| List of LCD monitor displays | 272 |
| In recording | 272 |
| In playback | 275 |
| Message displays | 277 |
| Q&A Troubleshooting | 281 |
| Usage cautions and notes | 292 |
| License Agreement for Place Name and Map Data DMC-ZS30 | 296 |

Before use

■ Camera handling



Keep the camera away from excessive vibration, force, or pressure.

- Avoid using the camera under the following conditions, which may damage the lens, LCD monitor, or camera body. This may also cause the camera to malfunction or prevent recording.
 - Dropping or hitting the camera against a hard surface
 - Sitting down with the camera in your pants pocket or forcing it into a full bag
 - Adding accessories to the camera strap
 - Pushing with excessive force on the lens or LCD monitor

The camera is not dust resistant, splash resistant, or waterproof.

Avoid using the camera in places with excessive dust or sand, or where water can come into contact with the camera.

- Avoid using the camera under the following conditions, which present a risk that sand, water, or foreign material may enter the camera through the lens or openings around buttons. Be especially careful because these conditions may damage the camera, and such damage may not be repairable.
 - In extremely dusty or sandy places
 - In the rain or by the shore, where the camera may be exposed to water

■ Condensation (When the lens or the LCD monitor is fogged up)

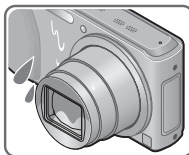

- Condensation may occur when the camera is exposed to sudden changes of temperature or humidity. Avoid these conditions, which may make the lens or LCD monitor dirty, cause mold, or damage the camera.
- If condensation does occur, turn off the camera and wait about two hours before using it. Once the camera adjusts to the surrounding temperature, the fogging will clear naturally.

■ Always take a test shot first

Before important events when you will use the camera (at weddings, for example), always take a test shot to make sure that pictures and sound record correctly.

■ No compensation for missed shots

We cannot compensate for missed shots if technical problems with the camera or card prevent recording.

■ Carefully observe copyright laws

Unauthorized use of recordings which contain works with copyright for purposes other than personal use is prohibited under copyright law. Recording of certain material may be restricted even for the purpose of personal use.

■ Also refer to “Usage cautions and notes” (→292)

● Please note that the actual controls and components, menu items, and other information for your digital camera may differ from those in the illustrations and screens provided in this manual. When operation or other information is more or less the same between models, DMC-ZS30 is used as examples for the instructions provided in this manual.

● The operations, procedures, or functions that differ among models are indicated separately, together with the relevant model number.

(Example) **DMC-ZS30**

DMC-ZS27

● Recording mode icons

You can select and execute indicated menus and functions for the recording modes displayed in blue on mode dial illustrations next to section titles.



In the example shown on the left, the following recording modes are available: **iA**, **P**, **A**, **S** and **M**.

* C1 and C2 will differ depending on the recording modes registered under custom settings.

About GPS DMC-ZS30

Your Panasonic Lumix digital still camera is GPS-equipped which can automatically record the precise location coordinates of where the photo was taken. The specific physical address of this location can easily be derived from this information.

If you upload such "geotagged" photos to the Internet, a social networking site or any other electronic media, the precise location of where the photo was taken will remain embedded in the photo and can be viewed by others.

Therefore, when taking digital still photos, care should be taken in determining whether you wish to have the GPS feature enabled or disabled.

■ About the camera's location name information

Before using the camera, be sure to read "License Agreement for Place Name and Map Data". (→296)

■ When [GPS Setting] is [ON], the GPS function works even if the camera is turned off.

- Electromagnetic waves from the camera can affect instruments and meters. In airplane cabins (during takeoff and landing) or in other restricted areas, set [Airplane Mode] to [ON], and then turn off the camera. (→57)
- When [GPS Setting] is [ON] and [Airplane Mode] is [OFF], power will drain from the battery even if the camera is turned off.

■ Recording location information

- The names of recording locations and landmarks (such as buildings) are current as of October 2012. These will not be updated.
- Depending on the country or area, limited location name and landmark information may be available.

■ Positioning

- Positioning will take time in environments where it is difficult to receive the signals from the GPS satellites. (→158)
- **Even if GPS reception is good, it will take approx. 2 to 3 minutes to successfully execute positioning under the following conditions: when positioning is executed for the first time, or when positioning is executed after the camera is turned off with the [GPS Setting] set to [OFF] or [Airplane Mode] set to [ON], and then turned on again.**
Positioning can be executed faster using GPS assist data. (→169)
- Because the positions of the GPS satellites are constantly changing, depending on the recording location and conditions, it may not be possible to position such satellites accurately, or positioning discrepancy may occur.

■ When using in another country

- The GPS function may not work in China or in the border regions of countries neighboring China. (Current as of January 2013)
- Some countries or regions may regulate the use of GPS or related technology. Because this camera has a GPS function, before taking it into another country, check with the embassy or your travel agency whether there are any restrictions on bringing cameras with a GPS function.

About the compass **DMC-ZS30**

■ Information measured with this unit is simply a rough estimate.

- Please do not use for professional applications.
- When using this unit for mountain climbing, trekking, or underwater, in addition to using the measured direction as a rough estimate, please make sure to bring along a map and a dedicated measuring instrument.

Standard Accessories

Check that all the accessories are supplied before using the camera.

- The accessories and their shape will differ depending on the country or area where the camera was purchased.
For details on the accessories, refer to Basic Owner's Manual.
- Battery Pack is indicated as battery pack or battery in the text.
- SD Memory Card, SDHC Memory Card and SDXC Memory Card are indicated as card in the text.
- Please dispose of all packaging appropriately.
- Keep small parts in a safe place out of the reach of children.

■ Optional accessories

- **Cards are optional.** You can record or play back pictures on the built-in memory when you are not using a card. (→23)
- If any accessories are lost, customers in the USA and Puerto Rico should contact Panasonic's parts department at 1-800-833-9626 and customers in Canada should contact 1-800-99-LUMIX (1-800-995-8649) for further information about obtaining replacement parts.

Names and Functions of Main Parts

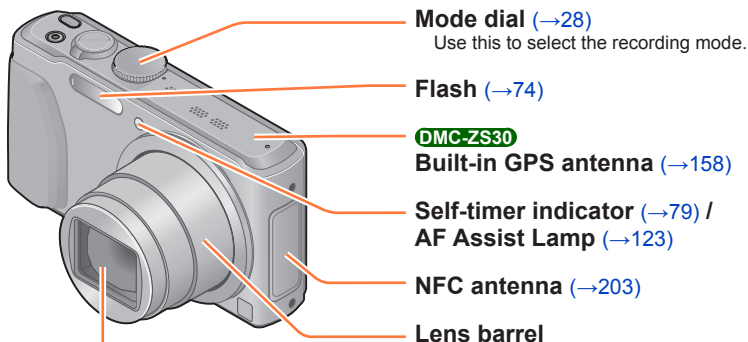

Lens (→8, 294)

Do not touch the lens barrier.

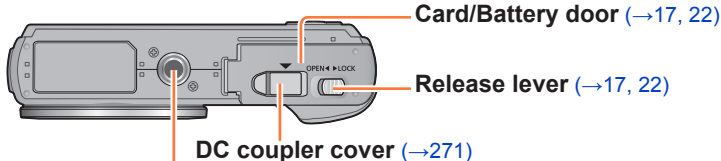
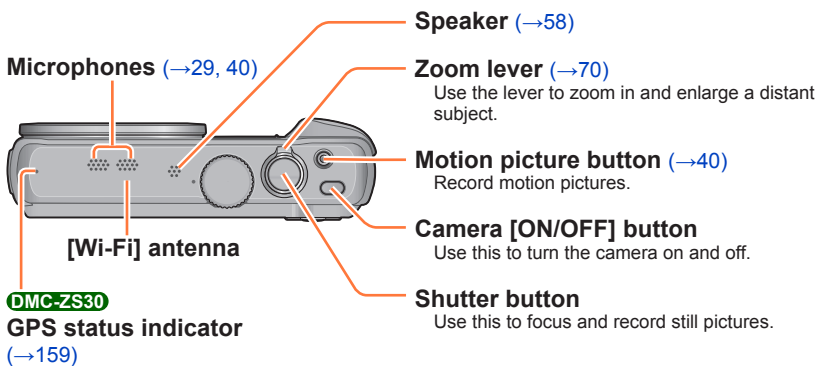

Tripod mount (→294)

Do not attach to a tripod with a 5.5 mm (0.22 inch) or longer screw.
Doing so may damage this unit.

● The illustrations and screens in this manual may differ from the actual product.

[EXPOSURE] button (→82)

In the recording mode: Use this button when setting the shutter speed or aperture value.

DMC-ZS30 [MAP] button (→175)

In the playback mode: Map is displayed.

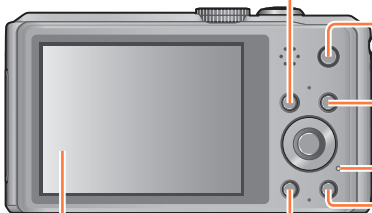

LCD monitor (→59, 272)

[Wi-Fi] button

Playback button

Use this to select the recording mode or playback mode.

Charging lamp (→18) / Wi-Fi connection lamp (→192)

[Q.MENU] button / [] / [] button

You can display the Quick Menu (→56) and erase pictures (→52).

[DISP.] button (→68, 129)

Use this to change display.

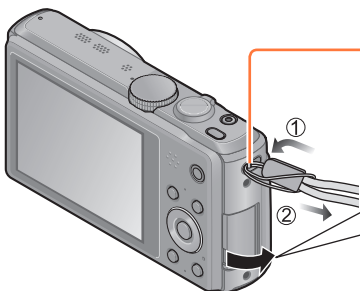

We recommend using the supplied hand strap to avoid dropping the camera.



[HDMI] socket (→253, 255)

Do not connect any other cables except the HDMI micro cable (optional). Doing so may cause malfunction.

[AV OUT/DIGITAL] socket (→253, 264, 267)

This socket is also used when charging the battery. (→18)

Cursor button

[MENU/SET]

• Use this button to display the menus, enter the settings, etc. (→54)

Left cursor button (◀)

• Self-timer (→79)

Down cursor button (▼)

• Macro Mode etc. (→76)

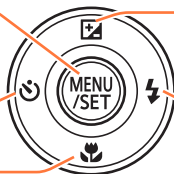

Up cursor button (▲)

• Exposure Compensation (→80), Auto Bracket etc. (→81)

Right cursor button (▶)

• Flash (→74)

● In this manual, the button that is to be used is indicated by ▲ ▼ ◀ ▶.

● The illustrations and screens in this manual may differ from the actual product.

Touch operations

This camera's touch screen senses pressure that is applied to the screen.

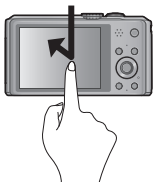

Touch

To "touch" is to press the touch screen and then pull the finger back again. Touching is used to select icons or pictures, among other actions.

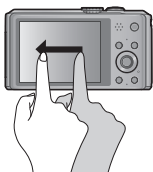

Drag

To "drag" is to touch and slide your finger across the touch screen surface. Dragging (sliding your finger across the screen) is used to scroll the pictures or change the range of the pictures displayed.

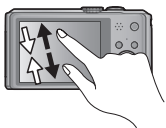

Pinch (spread/pinch)

On the touch screen, spread (pinch out) your 2 fingers to zoom in, and pinch (pinch in) your 2 fingers to zoom out. You use it when zooming in/out of playback pictures etc.

- You can also zoom in by quickly touching the touch screen twice. (If the display was enlarged, it returns to the same magnification ratio.)

- If the type of sheet made to protect LCD screens that are available in the market is to be used, observe the precautions that are contained with the sheet. (Some types of protective sheets may impair the screen's appearance and ease of operation.)
- If the camera is used with a protective sheet available on the market attached to its screen or if the screen is not very responsive, touch the screen with a little more pressure.
- If your hand is pressed against the touch screen when holding the camera, the touch screen will not work properly.
- Do not press on the LCD monitor with hard pointed tips, such as ballpoint pens.
- Do not press the touch screen with your fingernails.
- Clean the LCD monitor with a soft, dry cloth if there are fingerprints or other kinds of dirt on it.

Charging battery

Always use the dedicated AC adaptor (supplied), USB connection cable (supplied), and battery for this camera.

- **Always charge before first use!** (battery shipped uncharged)
- Charge the battery while it is in the camera.

| Camera status | Charge |
|---------------|--------|
| Turn off | Yes |
| Turn on | No* |

* During playback only, the camera operates using power supplied from the electrical outlet via the USB connection cable (supplied). (The battery is not charged.)

- If the battery is not inserted, neither charging nor power supplying is made.

■ About batteries that you can use with this unit

It has been found that counterfeit battery packs which look very similar to the genuine products are made available to purchase in some markets. Some of these battery packs are not adequately provided with internal protection to meet the requirements of appropriate safety standards. There is a possibility that these battery packs may lead to fire or explosion. Please be advised that we are not liable for any accident or failure occurring as a result of use of a counterfeit battery pack. To ensure that safe products are used we recommend that a genuine Panasonic battery pack is used.

Inserting the battery

To charge the battery, insert it into the camera.

- 1 Slide the release lever to the [OPEN] position and open the card/battery door**

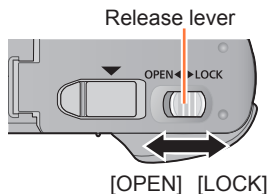

- 2 Insert the battery all the way**
 - Make sure to insert the battery in the correct orientation.
 - Insert the battery all the way firmly until a locking sound is heard, and check that the lever is hooked over the battery.

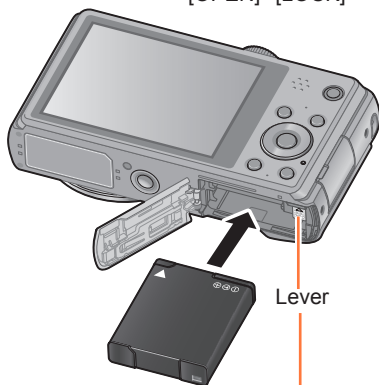

- 3 Close the card/battery door**
 - Slide the release lever to the [LOCK] position.

■ To remove battery

Move the lever in the card/battery compartment in the direction of the arrow.

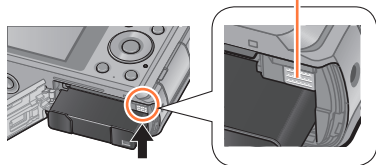

- Always use genuine Panasonic batteries.
- If you use other batteries, we cannot guarantee the quality of this product.
- **Remove battery from camera after use.**
 - Keep the battery in a plastic bag, making sure that it is kept away from metallic objects (such as clips) when carrying or storing the battery.
- To remove the battery, turn the camera off and wait until the LUMIX indicator on the LCD monitor goes off. (Failure to wait may cause the camera to malfunction and may damage the card or recorded data.)
- The unusable battery should be discarded in accordance with battery recycling laws. Call the RBRC hotline at 1-800-822-8837 for information.

Charging the battery

We recommend charging in a location where the ambient temperature is between 10 °C and 30 °C (50 °F to 86 °F) (same for the battery temperature).

Make sure that the camera is turned off.

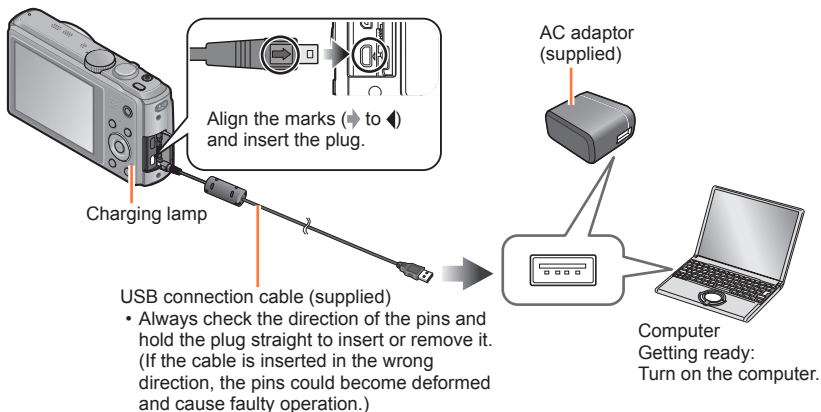

■ Charging the battery by connecting the camera to the electrical outlet

Connect the AC adaptor (supplied) and the camera using the USB connection cable (supplied), and plug the AC adaptor (supplied) into the electrical outlet.

- Be sure to only use the AC adaptor (supplied) indoors.

■ Charging the battery through the computer

Connect the camera to a computer using the USB connection cable (supplied).

- It may not be possible to charge the battery from some computers depending on the computer specifications.
- If the computer enters sleep mode during charging, charging may be stopped.
- If a notebook computer that is not connected to an electrical outlet is connected to the camera, the battery of the notebook computer will be depleted. Do not leave the camera and notebook connected for a long period of time.
- Always connect the USB connection cable to the USB connector on your computer. Do not connect the USB connection cable to the USB connector of the monitor, keyboard, printer, or USB hub.

■ Charging lamp indications

On: Charging in progress

Off: Charging stops (After charging stops, disconnect the camera from the electrical outlet or your computer.)

■ Notes on charging time

When using the AC adaptor (supplied)

| | |
|---------------|-----------------|
| Charging time | Approx. 210 min |
|---------------|-----------------|

- The charging time indicated above is the time required for charging in case when the battery is completely used up. The time required for charging differs depending on conditions of battery usage. Charging takes longer in cases when temperatures are either high or low and when the battery has not been used for a long period of time.
- The time required for charging through the computer varies depending on the specifications of the computer.

- Do not use any other USB connection cables except the supplied one or a genuine Panasonic USB connection cable (optional). Doing so may cause malfunction of the camera.
- Do not use any other AC adaptors except the supplied one.
- Do not use a USB extension cable.
- The AC adaptor (supplied) and the USB connection cable (supplied) are dedicated accessories of this camera. Do not use them for other devices.
- If there is any trouble related to the electrical outlet (i.e. power failure), charging may not complete properly. Disconnect the USB connection cable (supplied) and reconnect it to the camera.
- If the charging lamp does not light or flashes even when the camera is properly connected to the AC adaptor (supplied) or your computer, charging has been put in pause status because the temperature is not in the appropriate range for charging. This is not a malfunction. Reconnect the USB connection cable (supplied) and retry charging in a place where ambient temperature is 10 °C to 30 °C (50 °F to 86 °F) (temperature conditions also apply to the battery itself).

Remaining battery

When using the camera, the remaining battery capacity is displayed.



Remaining battery (only when using battery)



If the battery mark flashes red, recharge or replace battery.

Guidelines for number of recordable pictures and operating time

The number of recordable pictures or available operating time may vary according to surrounding environment and usage conditions. Figures may be reduced if flash, zoom, or other functions are used frequently, or in colder climates.

■ Recording still pictures

| | | |
|-------------------------------|----------------------|------------------|
| Number of recordable pictures | Approx. 300 pictures | By CIPA standard |
| Recording time | Approx. 150 min | |

● Recording conditions by CIPA standard

CIPA is an abbreviation of "Camera & Imaging Products Association".

- [Program AE] Mode
- [GPS Setting] is set to [OFF] **DMC-ZS30**
- Temperature: 23 °C (73.4 °F)/Humidity: 50%RH when LCD monitor is on.
- Using a Panasonic SD Memory Card (32 MB).
- Using the supplied battery.
- Starting recording 30 seconds after the camera is turned on. (When [Stabilizer] is set to [ON])
- Recording once every 30 seconds with full flash every second recording.
- Rotating the zoom lever from Tele to Wide or vice versa in every recording.
- Turning the camera off every 10 recordings and leaving it until the temperature of the battery decreases.

Number reduced if intervals are longer (e.g. to approx. one quarter for 2-minute intervals under the above conditions).

■ Recording motion pictures

| [Rec Format] | [AVCHD] | | [MP4] |
|----------------------------------|----------------|----------------|----------------|
| [Rec Quality] | [FHD/60p] | [FHD/60i] | [FHD/30p] |
| Available recording time | Approx. 75 min | Approx. 80 min | Approx. 90 min |
| Actual available recording time* | Approx. 30 min | Approx. 35 min | Approx. 40 min |

* The time you can actually record when repeatedly turning the camera on and off, starting and stopping recording and using zoom.

● Recording conditions

- Temperature 23 °C (73.4 °F), humidity 50%RH
- [GPS Setting] is set to [OFF] **DMC-ZS30**

● Remaining time for continuous recording is displayed on the screen

- You can continuously record a motion picture in [MP4] for up to 29 minutes 59 seconds or approx. 4 GB. (Since recording in [MP4] with [FHD/30p] creates larger files, the recording time for such motion pictures will be shorter than 29 minutes 59 seconds.)
- If [Rec Quality] of [AVCHD] motion pictures is set to [FHD], you can continuously record a motion picture for up to 29 minutes 59 seconds.

■ Viewing pictures

| | |
|---------------|-----------------|
| Playback time | Approx. 210 min |
|---------------|-----------------|

- The number of recordable pictures or available operating time may vary according to surrounding environment and usage conditions.
- If available battery power is significantly reduced, battery is reaching end of lifespan. Please purchase a new battery.

Inserting and removing the card (optional)

- Make sure that the camera is turned off.

- 1** Slide to the release lever to the [OPEN] position and open the card/battery door

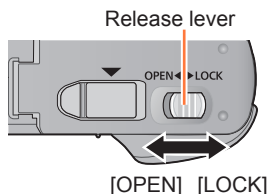

- 2** Insert the card all the way

- Push in until it clicks.

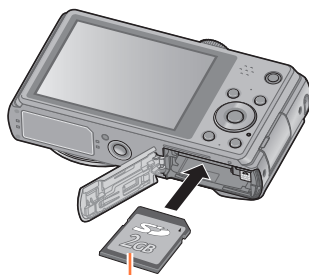

Card (Check orientation)

- 3** Close the card/battery door

- Slide the release lever to the [LOCK] position.

■ To remove card

Press the center of the card

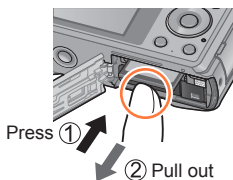

Do not touch the terminals on the back of the card.

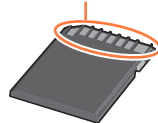

- Keep the Memory Card out of reach of children to prevent swallowing.
- To remove the card, turn the camera off and wait until the LUMIX indicator on the LCD monitor goes off. (Failure to wait may cause the camera to malfunction and may damage the card or recorded data.)

Saving your pictures (cards and built-in memory)

Pictures will be saved to a card if one is inserted, or to the built-in memory  if not.

■ Built-in memory

(approx. 12 MB) **DMC-ZS30**

(approx. 70 MB) **DMC-ZS27**

● You can store only still pictures. **DMC-ZS30**

● **Pictures may be copied between cards and the built-in memory.** (→157)

● The access time for the built-in memory may be longer than the access time for a card.

■ Compatible memory cards (optional)

The following SD standard-based cards (Panasonic brand recommended)

| Type of Card | Capacity | Notes |
|-------------------|--------------|--|
| SD Memory Cards | 8 MB – 2 GB | <ul style="list-style-type: none"> • Can be used with devices compatible with the respective formats. • Before using SDXC Memory Cards, check that your computer and other devices support this type of card. http://panasonic.net/avc/sdcard/information/SDXC.html • Use a card of SD Speed "Class 4"* or higher for recording motion pictures. • Only the cards listed on the left with the given capacities are supported. |
| SDHC Memory Cards | 4 GB – 32 GB | |
| SDXC Memory Cards | 48 GB, 64 GB | |

* SD speed class refers to a specification for sustained write speeds. Confirm the SD speed by checking the card label or other card related materials.

(Example)

CLASS 



● Latest information:

<http://panasonic.jp/support/global/cs/dsc/>

(This site is available in English only.)

- While the camera is accessing the card or built-in memory (for an operation such as picture writing, reading, deleting, or formatting), do not turn off the camera or remove the battery, card, AC adaptor (supplied), AC adaptor (optional), or DC coupler (optional). Do not subject the camera to vibrations, impact, or static electricity. The card or the data on the card may be damaged, and this unit may no longer operate normally. If operation fails due to vibration, impact or static electricity, perform the operation again.
- Please reformat the card with this camera if it has already been formatted with a computer or another device. (→66)
- If the write-protect switch is set to "LOCK", the card cannot be used to record or delete pictures, and it cannot be formatted.
- It is recommended that you copy important pictures to your computer (as electromagnetic waves, static electricity, or faults may cause data to be damaged).



Recording capacity guidelines (pictures/recording time)

The number of pictures you can take and the recording time vary in proportion to card capacity (and depending on recording conditions and type of card).



Estimated remaining pictures or recording time capacity (switch with [Remaining Disp.] (->61))

Displayed when no card is inserted (pictures will be saved to built-in memory)

■ Recording picture capacity (still pictures)

| [Picture Size] | Built-in memory | | 2 GB | 32 GB | 64 GB |
|----------------|-----------------|----------|-------|--------|--------|
| | DMC-ZS30 | DMC-ZS27 | | | |
| 4:3 18M | 1 | 12 | 270 | 4420 | 8820 |
| 4:3 5M | 3 | 29 | 650 | 10620 | 21490 |
| 4:3 0.3M | 67 | 460 | 10050 | 162960 | 247150 |

- When the number of recordable pictures exceeds 99,999, "+99999" is displayed.

■ Recording time capacity (motion pictures)

([h], [m] and [s] indicate “hour”, “minute” and “second”.)

When [Rec Format] is [AVCHD]

| [Rec Quality] | 2 GB | 32 GB | 64 GB |
|-----------------------|--------|----------|----------|
| [FHD/60p] | 8m00s | 2h31m00s | 5h07m00s |
| [FHD/60i] [HD/60p] | 14m00s | 4h10m00s | 8h26m00s |

When [Rec Format] is [MP4]

| [Rec Quality] | Built-in memory | 2 GB | 32 GB | 64 GB |
|---------------|--|--------|-----------|-----------|
| [FHD/30p] | – | 12m01s | 3h22m56s | 6h50m54s |
| [HD/30p] | – | 22m56s | 6h27m26s | 13h04m28s |
| [VGA/30p] | – DMC-ZS30 2m09s DMC-ZS27 | 50m30s | 14h12m41s | 28h46m30s |

- The time displayed in the table is the total time.

● Remaining time for continuous recording is displayed on the screen

- You can continuously record a motion picture in [MP4] for up to 29 minutes 59 seconds or approx. 4 GB. (Since recording in [MP4] with [FHD/30p] creates larger files, the recording time for such motion pictures will be shorter than 29 minutes 59 seconds.)
- If [Rec Quality] of [AVCHD] motion pictures is set to [FHD], you can continuously record a motion picture for up to 29 minutes 59 seconds.

- When map data is copied to a memory card, the number of recordable pictures and recording time will decrease. **DMC-ZS30** (→180)

Setting the clock

The clock is not set when the camera is shipped.

- Disconnect the unit from the AC adaptor (supplied).

1 Press the Camera [ON/OFF] button

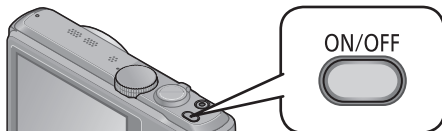

The camera is turned on.

If the language select screen is not displayed, proceed to step 4.

2 Press [MENU/SET] while the message is displayed

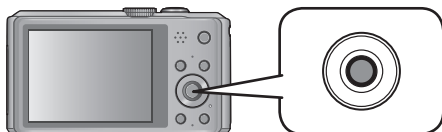

3 Press ▲ ▼ to select the language, and press [MENU/SET]

- The [Please set the clock] message appears.

4 Press [MENU/SET]

5 Press ◀ ▶ to select the items (year, month, day, hour, minute, display order or time display format), and press ▲ ▼ to set

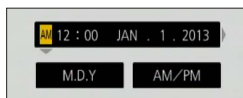

- To cancel → Press [\square / \rightarrow] button.

6 Press [MENU/SET] to set

7 Press [MENU/SET]

- To return to the previous screen, press [\square / \rightarrow] button.

DMC-ZS30

Go to step 8.

DMC-ZS27

The clock setting procedure is completed with step 7.

(Continued on the next page)

8 Press ◀ to select [Yes] and press [MENU/SET] if automatically correcting time of day using the GPS function

- To manually set date and time → select [No].
- When you select automatic time adjustment using the GPS function, [GPS Setting] is set to [ON].
- For details about [Auto Clock Set] (→168)

9 When [Please set the home area] is displayed, press [MENU/SET]

10 Press ◀▶ to set your home area and press [MENU/SET]

City or area name Current time



Difference from GMT (Greenwich Mean Time)

- If the clock is not set, the correct date cannot be printed when you order a photo studio to print the picture, or when you stamp the date on the pictures with [Date Stamp] or [Text Stamp].
- If the clock is set, the correct date can be printed even if the date is not displayed on the screen of the camera.

To change time setting

When resetting date and time, select [Clock Set] from the [Setup] menu or [Rec] menu.

- Clock settings will be saved for approx. 3 months even after the battery is removed, provided a fully charged battery was installed in the camera for 24 hours beforehand.

1 Select [Clock Set] from the [Setup] menu or [Rec] menu

- For details about how to set the menu (→54)

2 Set the date and time (Perform steps 5 - 6. (→26))

Sequence of operations

1

Press the Camera [ON/OFF] button to turn on the camera

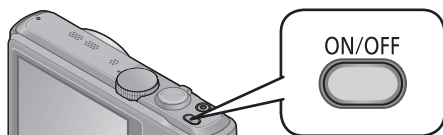

Set to the desired recording mode

Align the mode dial correctly to the mode that you want to use. →

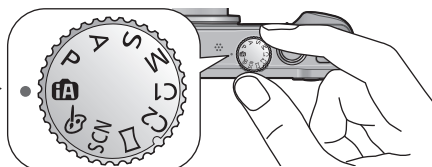

2

| | | |
|------------------------|---------------------------------|---|
| iA | [Intelligent Auto] Mode | Take pictures with automatic settings. (→34) |
| P | [Program AE] Mode | Take pictures with automatic shutter speed and aperture value settings. (→30) |
| A | [Aperture-Priority] Mode | Determine aperture, then record pictures. (→82) |
| S | [Shutter-Priority] Mode | Determine shutter speed, then record pictures. (→83) |
| M | [Manual Exposure] Mode | Determine aperture and shutter speed, then record pictures. (→84) |
| C1 C2 | [Custom] Mode | Record pictures using pre-registered settings. (→104) |
| | [Panorama Shot] Mode | Record panorama pictures. (→92) |
| SCN | [Scene Mode] | Take pictures using Scene modes. (→95) |
| | [Creative Control] Mode | Take pictures by selecting your preferred picture effect. (→85) |

(Continued on the next page)

Aim the camera and shoot

■ Taking still pictures

- ① Press the shutter button halfway to focus
- ② Press and hold the shutter button to take the picture

■ Recording motion pictures

- ① Press the motion picture button to start recording
- ② Press the motion picture button again to finish recording

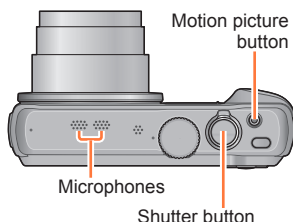

3

■ Holding the camera

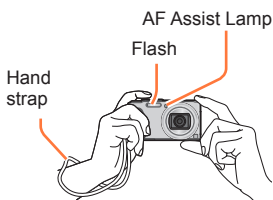

- To avoid camera shake, hold it with both hands keeping your arms close to your body while standing with your feet slightly apart.
- Do not touch the lens.
- Do not block the microphone when recording motion pictures.
- Do not block the flash or the lamp. Do not look at it from close range.
- Make sure that the camera does not move at the moment the shutter button is pressed.

● We recommend using the supplied hand strap to avoid dropping the camera.

Play back pictures

- ① Press the Playback button

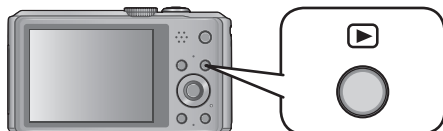

4

- ② View pictures (→45)
Drag the screen to select picture
 - Touch  to play back motion pictures, panorama pictures etc.

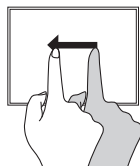

5

Press the Camera [ON/OFF] button to turn off the camera



Taking pictures with your own settings

[Program AE] Mode



Take pictures with automatic shutter speed and aperture value settings. Using the [Rec] menu to change settings and set up your own recording environment.

1 Set to P ([Program AE] Mode)

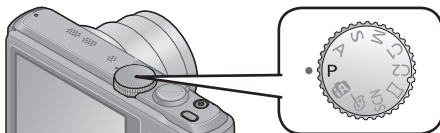

2 Take a picture

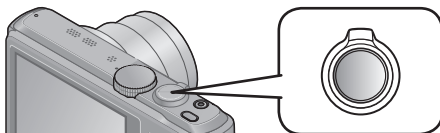

- If a warning is displayed about jitter, use [Stabilizer], a tripod, or [Self Timer].
- If aperture and shutter speed are shown in red, you do not have appropriate exposure. You should either use the flash, change [Sensitivity] settings or set [Min. Shtr Speed] to a slower speed.

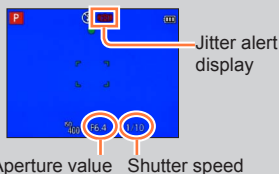

How to adjust focus

When [AF Mode] is set to  (1-area-focusing), focus on the AF area in the center of the picture. If a subject you want to record is not in the center, follow the steps below.

1 First adjust focus according to subject

Align the AF area with the subject



Hold down halfway

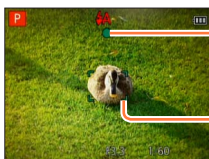

Focus display

(When focus is aligned: illuminated
When focus is not aligned: flashing)

AF area

(When focus is aligned: green
When focus is not aligned: red)

2 Return to desired composition



Press fully

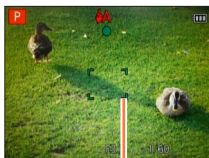

AF area

- Subjects/environments which may make focusing difficult:
 - Fast-moving or extremely bright objects, or objects with no color contrast.
 - Taking pictures through glass or near objects emitting light.
 - In the dark, or with significant jitter.
 - When too close to object or when taking pictures of both distant and close objects together in the same picture.
- The focus display flashes and beep sounds when focus is not aligned.
Use the focus range displayed in red as a reference.
Even if the focus display is lit, the camera may be unable to bring the subject into focus if it is out of range.
- The AF area display may be larger depending on recording conditions such as dark locations or zoom ratio.

Focus display

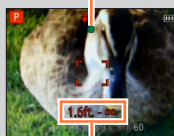

Focus range

Touching the screen and recording

(Touch Shutter function)

This function enables you to focus and record still pictures simply by touching the subjects that appear on the screen.

1 Touch on the screen



- The icon changes to , and you can now proceed with touch shutter recording.

2 Touch the subject you want to record



- The subject is recorded by setting the focus on the place that you touched.
- To release the touch shutter function → Touch .

- Motion pictures cannot be recorded.
- The touch shutter function will not work along the edges of the screen.
- Please note that the touch shutter will function even if you inadvertently touch the touch screen.
- The setting of the touch shutter function will be stored even if the camera is turned off.



Touching the screen and adjusting the focus and exposure (Touch AF/AE function)

This function enables the focus and exposure to be set when you touch the subject displayed on the screen.

- Perform these operations with the touch shutter function (→32) released.

1 Touch the place where you want to set the focus and exposure



- When [AF Mode] is set to  (Face Detection), the Face Detection function continues to operate, but the focus is adjusted to the place where you touched.
- When [AF Mode] is set to , the camera locks onto the subject, and it automatically continues to focus on the subject and adjusts the exposure of the subject as the subject moves.

2 Press the shutter button halfway to bring the subject into focus, and then press the button fully to record the subject

- To release the touch AF/AE function → Touch .

- The touch AF/AE function may fail to work under some recording conditions such as when the subject is too small or the recording location is too dark.
- The touch AF/AE function will not work along the edges of the screen.
- During [Intelligent Auto] Mode, the camera will determine the optimal scene for the touched subject.

Taking pictures with automatic settings

[Intelligent Auto] Mode



This mode is recommended for those who want to point and shoot or beginners as the camera optimizes settings to match the subject and recording environment.

1 Set to iA ([Intelligent Auto] Mode)

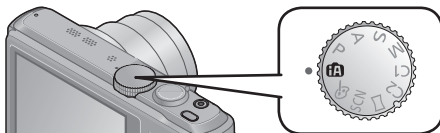

2 Take a picture

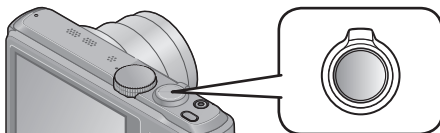

Focus display

(When focus is aligned:
illuminated
When focus is not aligned:
flashing)



Press halfway
(press lightly to focus)



Press fully
(press the button all the way to record)

About flash

Press **▶** to select **iA** or **iS**.

- When **iA** is selected, the optimum flash (**iA**, **iA**, **iS**, **iS**) is selected automatically depending on conditions.
- When **iA** or **iS** is selected, the red-eye reduction function is activated.
- When **iS** or **iS** is selected, the shutter speed is reduced.

Automatic Scene Detection

Camera reads scene when pointed at subject, and makes optimum settings automatically.

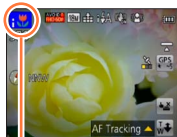

The icon of scene detected

| | |
|--|--|
| | Recognizes people |
| | Recognizes babies* ¹ |
| | Recognizes landscapes |
| | Recognizes night scenes and people in them* ² (Only when is selected) |
| | Recognizes night scenes* ² |
| | Recognizes night scenes without a tripod.* ³ |
| | Recognizes close-ups |
| | Recognizes sunsets |
| | Reads subject movement to avoid blurring when scene does not correspond to any of the above. |

*¹ When children (that are registered in the camera with Face Recognition) under 3 years old are recognized.

*² We recommend using a tripod and the self-timer.

*³ When [iHandheld Nite Shot] is [ON].

- Depending on recording conditions, different scene types may be determined for the same subject.
- If desired scene type is not selected, we recommend manually selecting the appropriate scene mode.
- When , , or is detected, Face Detection is activated, and the focus and exposure are adjusted for the recognized faces.

About Backlight Compensation

Backlight compensation is automatically activated in [Intelligent Auto] mode. Backlight is a condition where a light shines from behind a subject. When there is a backlight, the subject appears darker and the camera will automatically attempt to correct it by increasing the brightness of the picture. When the camera detects backlight, is displayed on the LCD monitor. (Depending on the backlighting conditions, backlighting may not be detected correctly.)

About the Happy color setting

When [Color Mode] is set to [Happy], pictures are recorded with vivid coloring.

Settings

- ① Press [MENU/SET]
- ② Use cursor button to select [Rec] menu and press [MENU/SET]
- ③ Use cursor button to select [Color Mode] and press [MENU/SET]
- ④ Use cursor button to select [Happy] and press [MENU/SET]

[Motion Deblur]

[Motion Deblur] automatically sets the optimum shutter speed in accordance with the movements of the subject to minimize the blur of the subject.

It is preset to [ON] with this unit.

■ Settings

- ① Press [MENU/SET]
- ② Use cursor button to select [Rec] menu and press [MENU/SET]
- ③ Press ▲ ▼ to select [Motion Deblur] and press [MENU/SET]
- ④ Press ▲ ▼ to select either [ON] or [OFF] and press [MENU/SET]

- When [Motion Deblur] is set to [ON], (👤) appears on the screen.
- The subject may be recorded in a picture size smaller than the number of pixels that has been set.

[iHandheld Nite Shot]

If a night scene is detected automatically while the camera is handheld, [iHandheld Nite Shot] can record a still picture with less jitter and less noise by combining a burst of pictures.

It is preset to [ON] with this unit.

■ Settings

- ① Press [MENU/SET]
- ② Use cursor button to select [Rec] menu and press [MENU/SET]
- ③ Press ▲ ▼ to select [iHandheld Nite Shot] and press [MENU/SET]
- ④ Press ▲ ▼ to select either [ON] or [OFF] and press [MENU/SET]

- When the camera is fixed in place on a tripod or by other means, [iHandheld Nite Shot] will not be identified.

[iHDR]

When there is, for example, strong contrast between the background and the subject, [iHDR] records multiple still pictures with differing exposures and combines them to create a single still picture rich in gradation.

It is preset to [ON] with this unit.

■ Settings

- ① Press [MENU/SET]
- ② Use cursor button to select [Rec] menu and press [MENU/SET]
- ③ Press ▲ ▼ to select [iHDR] and press [MENU/SET]
- ④ Press ▲ ▼ to select either [ON] or [OFF] and press [MENU/SET]

- This function is automatically activated only when  is displayed on the LCD monitor.
- In the case that a single picture is going to be composed from a burst, a message indicating that multiple pictures are to be recorded appears on the screen and burst recording is carried out. Note that burst recording will not take place if the camera determines that it can compensate for the difference in contrast without composing the picture from a burst.
- The camera does not combine pictures in the following cases:
 - When the zoom ratio exceeds 20x
 - [Burst] mode
 - When the flash fires
- In the case of composition from a burst, afterimages may appear if the subject was moving.

AF Tracking

This function enables the camera to continue to focus on the subject and adjust the exposure of the subject even when the subject is moving.

■ With touch screen operations

Perform these operations with the touch shutter function (→32) released.

1 Touch the subject

- When switching to lock on to another subject → Touch the other subject.
- To release AF Tracking → Touch .

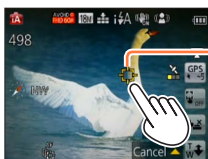

AF Tracking frame
 AF Lock successful: Yellow
 AF Lock failed: Red

■ With cursor button operations

1 Press ▲ to set [AF Mode] to AF Tracking

- To cancel AF Tracking → Press ▲.

2 Align the AF Tracking frame with the subject, and then press ▼ to lock

- To cancel AF Lock → Press ▼.



AF Tracking frame
 AF Lock successful: Yellow
 AF Lock failed: Red

- The optimal scene for the AF locked subject is automatically identified.
- Face Recognition will be inactive while using AF Tracking.
- Under certain recording conditions, such as when the subject is small or when it is dark, [AF Tracking] may not operate correctly.

[Intelligent Auto] Mode restrictions

Only the menu items which are displayed in the [Intelligent Auto] Mode can be set. The settings selected in the [Program AE] or other modes will reflect on the menu items in the [Setup] menu that are not displayed.





- The settings for the following items are different from other recording modes: [Picture Size], [Burst] and [Color Mode] on the [Rec] menu, and [Beep] on the [Setup] menu

- The settings for the following functions are fixed:

[Setup] menu

- [Auto Review]: [2SEC]
- [Auto Power Off]: [5MIN.]

[Rec] menu

- [Quality]:  [Fine]
- [White Balance]: [AWB]
- [Quick AF]: [ON]
- [i.Exposure]: [ON]
- [AF Assist Lamp]: [ON]
- [Stabilizer]: [ON]
- [Sensitivity]:  ISO
- [AF Mode]:  [Face Detection]*
- [Metering Mode]:  [Multi Metering]
- [i.Resolution]: [i.ZOOM]
- [Red-Eye Removal]: [ON]

*  (23-area-focusing) when face cannot be recognized

[Motion Picture] menu

- [Continuous AF]: [ON]
- [Wind Cut]: [AUTO]

- The following functions cannot be used:

[Histogram], [Exposure], [Auto Bracket], [WB Adjust.], [Min. Shtr Speed], [Digital Zoom]

Recording motion pictures



You can record motion pictures with audio (stereo).

- Motion pictures cannot be recorded in the built-in memory. **DMC-ZS30**

1 Press the motion picture button to start recording

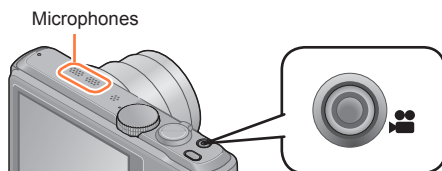

- Do not block the microphones when recording motion pictures.
- Immediately release the motion picture button after pressing it.
- You can also use zoom while recording motion pictures.
 - The zoom speed will be slower than normal.
 - The operating sounds of the zoom lever may be recorded in some cases.
- Still pictures can be taken during motion picture recording. (→44)

[Rec Format] (→126)
[Rec Quality] (→126)

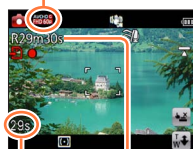

Elapsed recording time

Remaining recording time (approx.)

2 Press the motion picture button again to end recording

About recording modes





■ Recording motion pictures in P



Records a motion picture at your preferred settings.

- Aperture and shutter speed are automatically set.

■ Recording motion pictures in iA

The camera automatically detects the scene to record motion pictures with optimal settings.

| | | |
|--|---|---|
| iA When scene does not correspond to any on the right. |  |  |
| |  |  |

- In  mode, focus and exposure will be set according to the face detected.
-  will be selected for nightscapes and other dark scenes.
- If the camera does not select your desired Scene Mode, choosing an appropriate mode manually is recommended.
- The following menu options in the [Motion Picture] menu can be set:
 - [Rec Format] • [Rec Quality] • [Still Picture Size]

■ Motion picture recording in other recording modes

For details, refer to the pages relating to the respective recording modes.

■ About the recording format for recording motion pictures

This unit can record motion pictures in either AVCHD or MP4 formats.

AVCHD:

You can record high definition quality images with this format. It is suitable for viewing motion pictures on a high-resolution TV or for saving them to a disc.

AVCHD Progressive:

The [60p] in [FHD] is a mode that allows motion pictures to be recorded at 1920 x 1080/60p, the highest quality* that complies with the AVCHD standard.

Recorded motion pictures can be saved and played back using this unit or "PHOTOfunSTUDIO".

* This means the highest quality for this unit.

MP4:

This is a simpler video format best used when extensive editing is needed, or when uploading videos to WEB services.

- You can record a motion picture to the built-in memory only in [MP4] using the [VGA/30p] setting. **DMC-ZS27**

■ About the compatibility of the recorded motion pictures

Motion pictures recorded in [AVCHD] or [MP4] may be played back with poor picture or sound quality or playback may not be possible even when played back with equipment compatible with these formats. Also, the recording information may not be displayed properly. In this case, use this unit.

- Motion pictures recorded with [60p] in [FHD] can be played back on equipment that is compatible with AVCHD Progressive.
- AVCHD motion pictures recorded with the picture quality that has the **[G]** icon may not play back even on compatible equipment. Record without the **[G]** motion picture quality setting to prioritize playback on other equipment. **DMC-ZS30**
- For details on AVCHD Progressive and MP4 compatible devices, refer to the support site below.
<http://panasonic.jp/support/global/cs/dsc/>
(This site is available in English only.)

- **If the surrounding temperature is high, or a motion picture is recorded continuously,  is displayed and recording may be stopped halfway through to protect the camera.**
- The available recording time displayed on the screen may not decrease regularly.
- If data is repeatedly recorded and deleted, the total available recording time on the SD card may be reduced. To restore the original capacity, use the camera to format the SD card. Be sure to save all important data to your computer or other media before formatting, as all data saved to the card will be erased.
- [Stabilizer] functions regardless of the settings before a motion picture is recorded.
- When using zoom while recording motion pictures, it may take some time to focus.
- The following functions are not available:
Extended optical zoom, flash, [Face Recog.], [Rotate Disp.] for pictures taken vertically.
- For certain memory cards, recording may end while in progress.
- The recording range may become narrower in motion pictures compared to still pictures. Also, if the aspect ratio is different for still pictures and motion pictures, the angle of view will change when starting to record a motion picture. The recordable area is displayed by setting [Video Rec Area] ([→61](#)) to [ON].
- If Extended optical zoom is used before pressing the motion picture button, these settings will be cleared, and the recordable area will be changed significantly.
- Depending on the environment when recording motion pictures, the screen may turn black for an instant or noise may be recorded because of static electricity, electromagnetic waves, etc.

Recording still pictures while a motion picture is being recorded

Still pictures can be recorded even while a motion picture is being recorded.

1 Press the shutter button fully during the motion picture recording







Still pictures can be taken while a motion picture is being recorded.

| [Still Picture Size] (→127) | Maximum number of pictures |
|-----------------------------|----------------------------|
| 13.5M | 10 pictures |
| 6M | |
| 2M | |

- The clicking sound made when the shutter button is operated may be recorded. If the noise of the camera operation is disturbing, use the touch shutter.
- When still pictures are recorded during zooming, the zooming may stop.
- Using [Miniature Effect] in [Creative Control] Mode, a still picture may be taken with a slight delay from the time when the shutter button is pressed fully.

■ Burst function

When the burst function has been set in advance, a burst of still pictures can be recorded during motion picture recording.

- When the burst setting is set to , , or , still pictures are automatically recorded using the  setting.
- Even at the  or  setting, the focus is fixed at the first picture.

- If the touch shutter function has been set, still pictures will be recorded if the touch screen has been touched inadvertently during motion picture recording.
- The camera will refocus if the shutter button is pressed halfway during motion picture recording or if still pictures are recorded using the touch shutter function. This refocus movement is recorded even during motion picture recording. When priority is to be given to the motion picture videos, press the shutter button fully, and record the still pictures. Still pictures can also be created after motion picture recording. (→51)
- When the shutter button is pressed halfway, the picture size and the number of recordable pictures are displayed.
- Still pictures cannot be recorded in the following cases:
 - When [Rec Quality] is set to [VGA/30p]
 - When recording [High Speed Video]
- The flash is set to  [Forced Flash Off].
- Since the electronic shutter is used for recording, the pictures recorded may be distorted.
- Compared to normal still picture recording, the picture quality may be coarser.

Viewing your pictures

When a card is in the camera, pictures are played back from the card, and without a card, pictures are played back from the built-in memory.

1 Press the Playback button

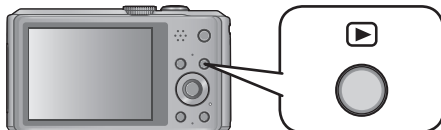

- By holding down the Playback button while the camera is off, you can turn the camera on in Playback Mode.

2 Drag your finger across the screen, and select the picture to be played back

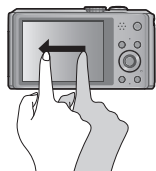

Scrolling to the next picture:

Drag your finger across the screen from right to left.

Returning to the previous picture:

Drag your finger across the screen from left to right.

- If you keep your finger touching the left or right edge of the screen after scrolling the pictures, the pictures will continue to be scrolled. (The pictures are displayed in a reduced size.)

- The pictures can also be scrolled by pressing the ◀▶ cursor button. When the buttons are held down, the pictures can be scrolled quickly forward or backward.

3 View pictures



Picture number/Total pictures

Location name information and latitude & longitude information are provided (→144, 161)

Folder/File number

- To switch to Recording Mode, press the playback button again or press the shutter button halfway during playback.

- It may not be possible to view pictures on this camera that were previously edited on a computer.
- When the camera is switched to playback mode, the lens barrel will be retracted after approx. 15 seconds.
- This camera is compliant with the unified DCF (Design rule for Camera File system) standard formulated by the Japan Electronics and Information Technology Industries Association (JEITA), and with Exif (Exchangeable image file format). Files that are not DCF-compliant cannot be played back.

Zooming in and viewing “Playback Zoom”

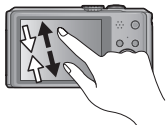
1 Spread (pinch out) your 2 fingers where you want to zoom in

On the touch screen, spread (pinch out) your 2 fingers to zoom in, and pinch (pinch in) your 2 fingers to zoom out.

- You can also zoom in by quickly touching the touch screen twice. (If the display was enlarged, it returns to the same magnification ratio.)

- Each time you move the zoom lever toward the T side, the camera magnifies the selected area by 2x, 4x, 8x, and 16x in succession. (Move towards the W to zoom out)

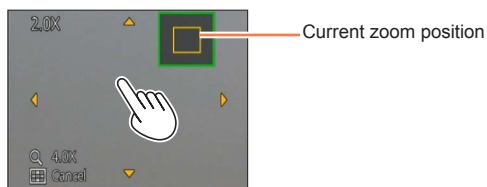
2 Drag your finger over the screen to move the position of the area magnified

- The position of the area magnified can also be moved by operating the cursor button.

- Playback zoom cannot be used during motion picture playback.

Viewing a list of pictures “Multi Playback”

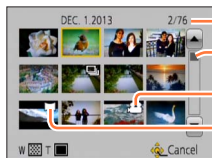
1 Move the zoom lever toward W side

Picture no./Total no.

Slide bar (drag this to change display)

Motion pictures

Panorama pictures

- Move the zoom lever toward the W side and you can switch the display methods in the following order: 1-picture screen (full-screen) → 12-picture screen → 30-picture screen → Calendar screen. (Move the lever to the T side to return.)
- When a picture is touched on the 12-picture or 30-picture screen, the picture touched is displayed on the 1-picture screen (full-screen).

● Pictures displayed with [!] cannot be played back.

Viewing pictures by their recording date [Calendar]

1 Move the zoom lever toward W side several times

2 Touch the recording date to be displayed, and touch [Set] to enter the date

Select the month

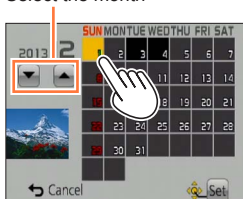

- Pictures recorded on the selected date will appear on the 30-picture screen.
- The recording date can also be selected by using the cursor button, and press [MENU/SET].

- Only months when pictures were taken are shown on the calendar screen. Pictures taken without clock settings are displayed with the date January 1st, 2013.
- Pictures taken with destination settings made in [World Time] are displayed in the calendar screen using the appropriate date for the destination's time zone.

Viewing motion pictures

This unit was designed to play motion pictures using the AVCHD, MP4 and QuickTime Motion JPEG formats.

1 Select a picture with the motion picture icon, and touch

Playback now starts.

- You can also press  to play back motion pictures.



Motion picture recording time





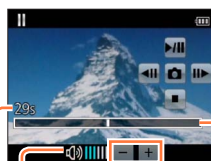

Motion picture icon (differs depending on the recording mode and picture quality setting)

■ Operations during motion picture playback

- Touch the screen to display the control panel.
- Touch the control panel to perform playback operations.
 - If there is no operation for about 2 seconds, the control panel disappears.



Control Panel

- : Pause/Play
- : Stop
- : Capturing still pictures from motion pictures (→51)
- : Fast rewind (2 steps)
- : Single-frame rewind (while paused)
- : Fast forward (2 steps)
- : Single-frame forward (while paused)

Volume adjustment

Volume level

Elapsed playback time

Playback bar

(The playback position can be moved by touch operation.)

- You can also use the cursor button to perform playback operations.
 - ▲: Pause/play
 - ▼: Stop
 - ◀: Fast rewind (2 steps)/Single-frame rewind (while paused)
 - ▶: Fast forward (2 steps)/Single-frame forward (while paused)
 - [MENU/SET]: Capturing still pictures from motion pictures (→51)
 - Volume can be adjusted with the zoom lever.
-
- It may not be possible to properly play back the motion pictures recorded using other cameras.
 - Some information will not be displayed for motion pictures recorded in [AVCHD].
 - Motion pictures can be viewed on your computer using "PHOTOfunSTUDIO" on the supplied disc.
 - Motion pictures recorded with [Miniature Effect] in [Creative Control] Mode play back at approximately 10 times speed.

Capturing still pictures from motion pictures

Save a scene from a motion picture as a still picture.

1 Display the picture that you want to capture as a still picture by pausing a motion picture during playback

2 Touch 



- A confirmation screen is displayed. Select [Yes] with cursor button and then press [MENU/SET].
- You can also capture still pictures from motion pictures by pressing [MENU/SET].

- Still pictures are saved with [Aspect Ratio] setting of 16:9 and [Picture Size] at 2M*.

* In the following cases, saved pictures become 4:3, 0.3M.

- MP4 motion pictures with [Rec Quality] of [VGA/30p]
- High-speed motion pictures with [Recording Speed] of [240fps]

- The picture quality becomes slightly lower depending on the [Rec Quality] setting of the original motion picture.
- It may not be possible to capture still pictures from motion pictures that were recorded with a different camera.

Deleting pictures

Pictures will be deleted from the card if the card is inserted, or from the built-in memory if the card is not inserted. (Deleted pictures cannot be recovered.)

1 Press [🗑️/↶] button to delete displayed picture

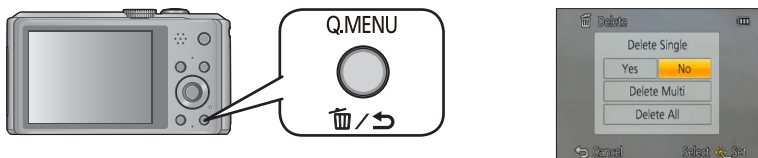

- A confirmation screen is displayed. Select [Yes] with cursor button and then press [MENU/SET].

- Do not turn off the camera during deletion.
- Pictures cannot be deleted in the following cases:
 - Protected pictures
 - Card switch is in "LOCK" position.
 - Pictures not of DCF standard (→45)

To delete multiple (up to 100)/To delete all pictures

A picture group (→130) is handled as 1 picture. (All the pictures in the selected picture group are deleted)

1 Press [🗑️/↩️] button while viewing a picture

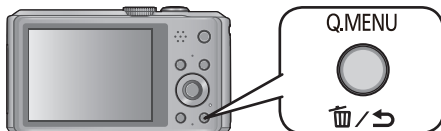

2 Use ▲▼ to select [Delete Multi]/[Delete All] and press [MENU/SET]



● [Delete Multi]

Use cursor button to select picture and press [DISP.] button



- To cancel → Press [DISP.] button again.
- To execute → Press [MENU/SET].
- You can select [All Delete Except Favorite] in [Delete All] if there are pictures that have been set as [Favorite] (→153).
- A confirmation screen is displayed. Select [Yes] with cursor button and then press [MENU/SET].
- May take time depending on number of pictures deleted.

Setting the menu

Refer to the procedure below for an example on how to operate the menus.

Example: Changing [AF Mode] in the [Rec] menu in [Program AE] Mode

1 Press [MENU/SET]

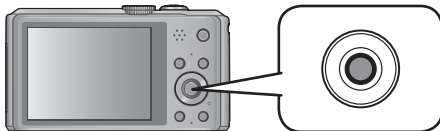

2 Use cursor button to select [Rec] menu and press [MENU/SET]



- The menu type can also be selected by touch operations.

3 Press ▲ ▼ to select [AF Mode] and then press [MENU/SET]

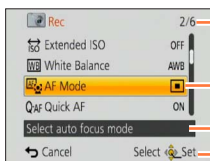

2/6 — Pages (The pages can also be selected with the zoom lever.)

AF Mode — Menu items

Select auto focus mode — Menu description

Select Set — Operation guide

4 Press ▲ ▼ to select a setting, and then press [MENU/SET]

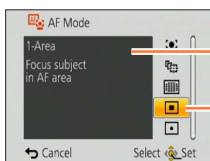

1-Area — Setting description

1-Area — Selected setting

5 Press [⏏/⏏] button several times

The menu closes and the monitor returns to the previous screen.

- In recording mode, the menu screen can also be exited by pressing the shutter button halfway.

Menu type

● In recording mode

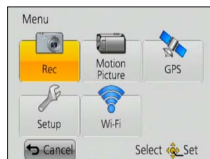

● In playback mode



| | |
|------------------------------|--|
| [Rec] | You can perform settings such as tones, Sensitivity, Aspect Ratio, and Picture Size. |
| [Motion Picture] | You can select the recording format and picture quality and other settings. |
| [GPS] DMC-ZS30 | You can select the GPS setting, location name display and other settings. |
| [Setup] | You can perform settings for convenience of use such as the clock setting and changing of the beep sounds. |
| [Wi-Fi] | You can perform settings required to use a Wi-Fi connection and Wi-Fi functions. |
| [Playback Mode] | You can choose the playback method to see [Slide Show] or to narrow down the pictures for display, etc. |
| [Playback] | You can specify picture protection, resizing, print settings, and other settings for pictures you have taken. |
| [Map] DMC-ZS30 | You can display the current location on a map or edit the location information of a place where a picture was taken. |

- The operation screen examples in this manual may differ from the actual screen display or some parts of the screen display are omitted.
- The menu types and items that are displayed vary according to the mode.
- The setting methods vary depending on the menu item.
- The following menus are also displayed depending on the recording mode.
 - In the [Creative Control] mode: [Creative Control] menu (→85)
 - In the [Scene Mode] mode: [Scene Mode] menu (→95)
 - In the [Custom] mode: [Custom] menu (→105)

Using Quick menu

During recording, you can easily call some of the menu items and set them.

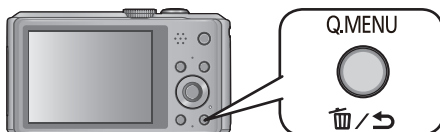
1 Press [Q.MENU] button**2** Press ◀▶ to select a menu item

- The menu items and setting items that are displayed differ depending on the recording mode.

3 Press ▲▼ to select the settings**4** Press [MENU/SET]

Using the [Setup] menu

[Clock Set], [Economy] and [Auto Review] are important for clock setting and battery life. Please check these before use.

- For the setting procedures of the menu. ([→54](#))

- In [Intelligent Auto] Mode, only [Clock Set], [World Time], [Airplane Mode], [Beep] and [Stabilizer Demo.] are set.

[Clock Set]

Set time, date, and display format. ([→26](#))

[Auto Clock Set] **DMC-ZS30**

Setting the clock automatically using GPS. ([→168](#))

[World Time]

Set the local time at travel destination. ([→113](#))

[Travel Date]

Record the number of days elapsed in your travels. ([→112](#))

[Airplane Mode]

Disable the Wi-Fi function. ([→193](#))

Disable the GPS function. ([→164](#)) **DMC-ZS30**

- For the setting procedures of the menu. (→54)

[Beep]

Change or mute the beep/shutter sounds.

■ Settings

[Beep Level]

/ / : Low / High / Mute

[Beep Tone]

/ / : Change beep tone.

[Shutter Vol.]

/ / : Low / High / Mute

[Shutter Tone]

/ / : Change shutter tone.

[Speaker Volume]

Adjust volume of sound from speakers (7 levels).

■ Settings: [0] / [1] / [2] / [3] / [4] / [5] / [6]

- Cannot be used to adjust TV speaker volume when connected to TV.

[Cust.Set Mem.]

Register the current camera settings. (→104)

- For the setting procedures of the menu. (→54)

[Monitor Display]

Adjust brightness and color of the LCD monitor. It is suggested to use the default settings. These are intended to provide a preview of the actual picture, as accurately as possible.

- ① Press ▲ ▼ to select the setting item and press ◀ ▶ to make adjustments
- ② Press [MENU/SET]

- Some subjects may look different from their actual appearance, but the recorded picture will not be affected.

[Calibrate compass] **DMC-ZS30**

Adjust the built-in compass. (→186)

[Monitor Luminance]

Make LCD monitor easier to see.

■ Settings



[Auto Power Monitor]:

The brightness is adjusted automatically depending on how bright it is around the camera.



[Power Monitor]:

Makes screen brighter than normal. (for outdoor use)

[OFF]

- Cannot select [Auto Power Monitor] in playback mode.
- [Power Monitor] returns to ordinary brightness if there is no operation for 30 seconds when recording. (Press any button to make the screen brighter again.)
- Because the picture shown on the LCD monitor screen emphasizes brightness, some subjects may look different than their actual appearance, but this will not affect the recorded picture.
- Setting [Monitor Luminance] reduces the operating time.

- For the setting procedures of the menu. (→54)

[Guide Line]

Select types of guidelines.

■ Settings: / / [OFF]

- In [Panorama Shot] Mode, a dedicated guideline will display to match the recording direction.
This setting can be set to [ON] or [OFF].

[Histogram]

Displays distribution of brightness in picture – e.g. if the graph peaks at the right, this means there are several bright areas in the picture. A peak in the center represents correct brightness (correct exposure). This can be used as a reference for exposure correction, etc.

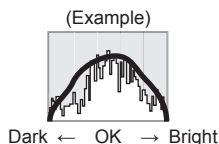

■ Settings: [ON] / [OFF]

- When the histogram is not the same as that of the recorded picture under the following conditions, histogram will be displayed in orange.
 - In dark places.
 - When manual exposure assist indicates settings other than 0 EV in [Manual Exposure] mode or during Exposure Compensation.
 - When the flash fires.
- The histogram displayed during recording is only a reference.
- The histogram displayed during recording and that displayed during playback may be different.
- The histogram is different from those displayed using the image editing software of a computer.
- The histogram will not be displayed in the following cases.
 - [Intelligent Auto] Mode
 - Playback Zoom
 - During motion picture recording
 - Multi Playback
 - When the HDMI micro cable is connected

- For the setting procedures of the menu. (→54)

[Video Rec Area]

Enables verification of the recordable area for a motion picture before recording.

■ Settings: [ON] / [OFF]

- Recordable area displayed for motion pictures should be interpreted as a guideline.
- When using Extended optical zoom, the recordable area may not always be displayed for certain zoom ratios.
- For [Intelligent Auto] Mode, the setting is fixed to [OFF].

[Remaining Disp.]

Switch the display between the remaining number of still pictures you can take or the remaining recording time of a motion picture that you can record for the available card or built-in memory.

■ Settings

- 📷 (Displays the number of pictures that can be recorded)
- 🕒 (Displays the remaining recording time)

[Zoom Resume]

Remember the zoom position when turning the camera off.

■ Settings: [ON] / [OFF]

- For the setting procedures of the menu. (→54)

[Economy]

Turn off the camera or make the LCD monitor go dark while not using the camera to minimize battery consumption.

[Auto Power Off]

Automatically shut off the camera while not in use.

■ **Settings:** [2MIN.] / [5MIN.] / [10MIN.] / [OFF]

- To restore → Turn on the camera again.
- Cannot be used in the following cases:
When connected to AC adaptor (supplied), when connected to computer/printer, during motion picture recording/playback, during Slide Shows
- Settings fixed to [5MIN.] in [Intelligent Auto] Mode.

[Monitor Power Save]

The LCD monitor goes dark to minimize power consumption.

■ **Settings:** [ON] / [OFF]

- Reduces the picture quality of the LCD monitor display during recording to minimize battery consumption (except for the Digital Zoom area). Note, however, that there is no effect on the recorded picture.
- The setting in [Monitor Luminance] is prioritized over the setting in [Monitor Power Save] for the brightness of the LCD monitor.

[Auto Review]

Automatically display still pictures immediately after taking them.

■ Settings

[1SEC] / [2SEC]: The playback screen is displayed for the set time, then automatically returns to the recording screen.

[HOLD]: Auto review screen remains until a button (other than the [DISP.] button) is pressed

[OFF]

- Automatically displays still pictures immediately after they are taken during [Auto Bracket] and burst recording, regardless of the [Auto Review] setting.
- For [Intelligent Auto] Mode, the setting is fixed to [2SEC].
- Motion pictures cannot be automatically reviewed. (also applies to high-speed motion pictures)

- For the setting procedures of the menu. (→54)

[No.Reset]

Reset picture file numbers.

- The folder number is updated and the file number starts from 0001.
- A folder number between 100 and 999 can be assigned.
Numbers cannot be reset once folder number reaches 999. In this case, save all necessary pictures to your computer, and format the built-in memory/card (→66).
- To reset folder number to 100:
First, format the built-in memory or card, and reset the file numbers using [No.Reset]. Then, select [Yes] on the folder number reset screen.

[Reset]

Reset to the default settings.

[Reset Rec. settings?]**[Reset setup parameters?]**

- Information registered in [Face Recog.] is reset if recording settings are reset.
- Resetting the setup parameters will also reset the following:
 - Age in years/months and names in [Baby] and [Pet] Scene Modes
 - [GPS] menu **DMC-ZS30**
 - [Map] menu **DMC-ZS30**
- Folder numbers and clock settings will not be reset.
- Camera movement may be audible as the lens function is reset. This is not a fault.

[Reset Wi-Fi Settings]

Returns all [Wi-Fi] menu settings to default settings.

- If you want to dispose or give away your camera, always reset it to prevent your personal information from being mistakenly used.
- When you request your camera to be fixed, backup your personal information and always reset it as well.

- For the setting procedures of the menu. (→54)

[USB Mode]

Select communication method for when connecting camera to a computer or printer with USB connection cable (supplied).

Update the GPS assist data. **DMC-ZS30**

■ Settings



[Select on connection]:

Select communication method each time you connect to a computer or PictBridge-compatible printer.



[PictBridge(PTP)]:

Select when connecting to a PictBridge-compatible printer.



[PC]:

Select when connecting to a computer.

DMC-ZS30



[GPS assist data]:

Select when using this unit to update GPS assist data. (→169)

[Output]

Change the settings to be used when the camera is connected to a TV or other device.



[TV Aspect] (This setting performs when an AV cable (optional) is connected.)

■ Settings: **16:9** / **4:3**

[VIERA Link]

Enable automatic linking with other VIERA Link-compatible devices, and operability with a VIERA remote control when connecting via an HDMI micro cable (optional) (→255).

■ Settings

[ON]: Operations may be performed via the remote control of the VIERA Link-compatible device. (Not all operations will be available.)

Operability of the camera's own buttons will be limited.

[OFF]: Operations must be performed via the camera's own buttons.

- For the setting procedures of the menu. (→54)

[3D Playback]

Set how 3D still picture is output.



■ Settings: [3D] / [2D]

- If you want to play back a picture in 2D (conventional picture) on a 3D television, set to [2D].
- This item of the menu functions when an HDMI micro cable (optional) is connected.
- For the procedure for playing back a 3D still picture. (→257)

[Rotate Disp.]

Automatically rotate portrait still pictures.

■ Settings

- : Rotate and display pictures displayed on a TV screen as well as those displayed on the LCD monitor of the camera in portrait orientation.
 - : Rotate and display only pictures displayed on a TV screen in portrait orientation.
- [OFF]

- [Rotate Disp.] cannot be used with motion pictures.
- Still pictures taken with the lens surface facing up or down, or still pictures taken on other cameras may not rotate.
- Pictures cannot be rotated during Multi Playback.
- Will only be displayed rotated on computer if in Exif-compatible (→45) environment (OS, software).

[Version Disp.]

Check the camera firmware version or display software information.

- When you press [MENU/SET] while the version is displayed, software information such as the license is displayed.

- For the setting procedures of the menu. (→54)

[Format]

Use when [Built-In Memory Error] or [Memory Card Error] appears, or when formatting the built-in memory or card.

When a card/built-in memory is formatted, the data cannot be restored. Check the content of the card/built-in memory carefully before formatting.

- When formatting the built-in memory, remove the cards.
(Only inserted card will be formatted if present; built-in memory will be formatted if no card is inserted.)
- Always format cards with this camera.
- **All data including protected pictures and copied map data will be deleted.**
DMC-ZS30
- **All protected pictures and other picture data will be deleted.** **DMC-ZS27**
- Do not turn off the camera or perform other operations during formatting.
- Formatting the built-in memory may take several minutes.
- If the card cannot be formatted, please try another card before contacting your nearest Service Center.

For USA and Puerto Rico assistance, please call: 1-800-211-PANA(7262) or, contact us via the web at: <http://www.panasonic.com/contactinfo>

For Canadian assistance, please call: 1-800-99-LUMIX (1-800-995-8649).

[Language]

Change display language.
Set the language displayed on the screen.

- For the setting procedures of the menu. (→54)

[Demo Mode]

View demonstration of functions.

[Stabilizer Demo.]: Extent of jitter is shown on graph (estimate)

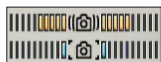

Extent of jitter

Extent of jitter after correction

- During demo screen display, the Optical Image Stabilizer switches ON and OFF every time [MENU/SET] is pressed.

DMC-ZS30**[Map Demo]:**

Display the map for the city of Paris, France. Please use it as a reference for map functions.

Switching the display of recording information, etc.

You can also turn off the recording information (such as icons for various settings).

1 Press [DISP.] button to change display

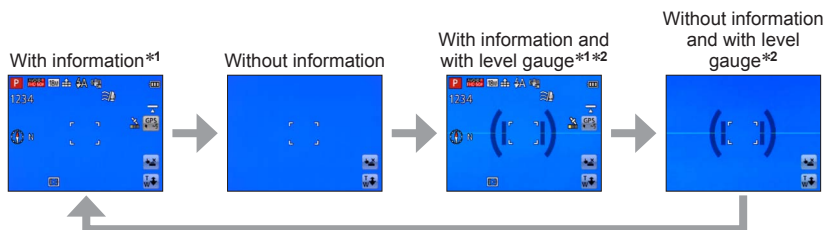
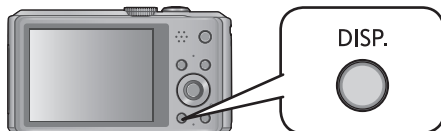

*1 Set [Histogram] to display a histogram. (→60)

*2 **DMC-ZS30**

● Change guideline settings in [Guide Line] from the [Setup] menu. (→60)

Using the level gauge DMC-ZS30



If you want to make sure that the camera is not slanted or tilted, for example, when you take a picture of a landscape, use the level gauge indication as a reference.

1 Press [DISP.] button to switch the display

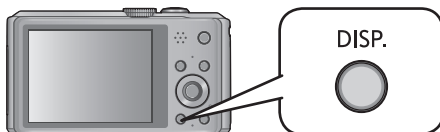

Press the button to switch the display. Press the button until the level gauge is displayed.

2 Correct camera angle

■ Using the level gauge

The yellow line indicates the current angle (horizontal line). Correct the angle of the camera so that it matches the white line.

Tilting up or down

- In this case, it is facing upward.

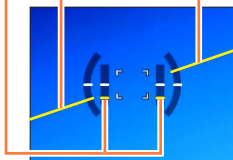
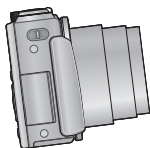

Tilting left or right

- In this case, the right side has dropped.



- When the camera's angle is minimal, the level gauge will turn green.
- When pictures are taken in portrait orientation, the level gauge is automatically switched to one for portrait orientation.

- Even when angle is more or less corrected, there may be an error of about ± 1 degree.
- When the camera is being moved, the level gauge may not be displayed correctly.
- The level gauge may not be displayed correctly or the direction detect function may not operate correctly if the pictures are taken with the camera pointing sharply up or down.

Using Zoom



You can adjust the area of a picture to be taken using zoom.

1 Zoom In/Out

Capture a wider area (wide-angle)



Enlarge the subject (telephoto)

- The zoom speed can be set to one of 2 levels using the angle at which the zoom lever is moved.

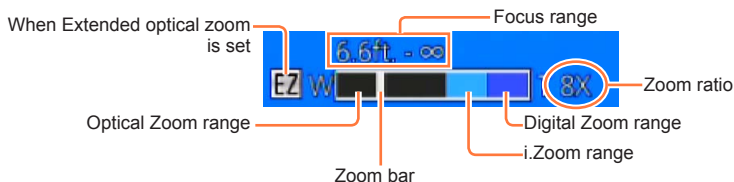



- Adjust the focus after adjusting the zoom.
- Do not touch the lens barrel during zooming.
- The zoom ratio and the zoom bar displayed on the screen are estimates.
- The camera may make a rattling noise and vibrate when the zoom lever is operated - this is not a malfunction.

Using the zoom by performing touch operations

1 Touch 

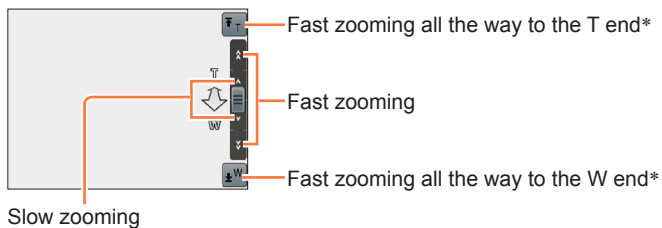
The zoom bar appears on the screen.

2 Touch the T or W edge of the zoom bar on the screen

* When  or  is touched again while zooming, zooming will stop.

Zoom types and use

The zoom ratio changes when the number of recording pixels is changed.

■ Optical Zoom

Zooming in up to 20x is possible if pictures without **EZ** have been selected by [Picture Size] on the [Rec] menu. (→115)

- Optical Zoom cannot be used in the following cases:
 - [Macro Zoom]
 - Scene Mode ([3D Photo Mode])

■ Extended optical zoom



Zooming in up to 47.8x is possible when pictures with **EZ** have been selected by [Picture Size] on the [Rec] menu (→115). EZ is short for “Extended optical zoom”.

- Extended optical zoom cannot be used in the following cases:
 - [Macro Zoom]
 - Motion picture
 - When the [Burst] setting is set to **40**, **60**, or **↓**
 - Scene Modes ([HDR], [High Sens.], [High Speed Video], [3D Photo Mode])
 - [Creative Control] Mode ([Toy Effect])

To increase the zoom ratio further, the following zoom can be used in combination.



■ [i.ZOOM]

You can use the camera's Intelligent Resolution technology to increase the zoom ratio up to 2x higher than the original zoom ratio with limited deterioration of picture quality. Set [i.Resolution] to [i.ZOOM] on the [Rec] menu. (→122)

- When [i.Resolution] is set to [i.ZOOM], Intelligent Resolution technology is applied to the picture.
- [i.ZOOM] does not function in the following cases.
 - [Macro Zoom]
 - When the [Burst] setting is set to , , or 
 - Scene Modes ([Handheld Night Shot], [HDR], [High Sens.], [3D Photo Mode])
 - [Creative Control] Mode ([Toy Effect])

■ [Digital Zoom]

Zoom 4x further than Optical/Extended optical zoom. Note that, with Digital Zoom, enlarging will decrease picture quality. Set the [Digital Zoom] in the [Rec] menu to [ON]. (→122)

- Digital Zoom cannot be used in the following modes:
 - [Intelligent Auto] Mode
 - When the [Burst] setting is set to , , or 
 - Scene Modes ([Handheld Night Shot], [HDR], [High Sens.], [High Speed Video], [3D Photo Mode])
 - [Creative Control] Mode ([Toy Effect], [Miniature Effect])
- This is fixed to [ON] when [Macro Zoom] is set.
- When [Digital Zoom] is used simultaneously with [i.ZOOM], you can only increase the zoom ratio up to 2x.

Taking pictures with flash



1 Press ► to display [Flash]

2 Use cursor button to select the desired type and press [MENU/SET]

| Type, operations | Uses |
|--|--|
| [Auto] • Automatically judges whether or not to flash | Normal use |
| [Auto/Red-Eye]*2 • Automatically judges whether or not to flash (reduce red-eye) | Taking pictures of subjects in dark places |
| [Forced Flash On] • Always flash | Taking pictures with backlight or under bright lighting (e.g. fluorescent) |
| [Slow Sync./Red-Eye]*2 • Automatically judges whether or not to flash (reduce red-eye; slow shutter speed to take brighter pictures) | Taking pictures of subjects against a nightscape (tripod recommended) |
| [Forced Flash Off] • Never flash | Places where flash use is prohibited |

*1 Only in the mode

*2 Two flashes will be emitted. Do not move until after the second flash. Interval between flashes varies according to brightness of subject.

When [Red-Eye Removal] in the [Rec] menu is set to [ON], the icon changes to /, red-eye is automatically detected and the picture data is corrected. (Only when [AF Mode] is (Face Detection))

- The effect of red-eye reduction varies depending on the subject and is affected by factors such as distance to the subject, whether the subject is looking at the camera during preliminary flash, and so on. In some cases, the effect of red-eye reduction may be negligible.
- **Do not put your hands over the light-emitting area of the flash (→13) or look at it from close range.**
Do not use the flash at close distances to other subjects (heat/light may damage subject).
- Flash settings may be changed when changing recording mode.
- Scene Mode flash settings are restored to default when Scene Mode is changed.
- Edges of picture may become slightly dark if using flash at short distances without using zoom (close to max. W). This may be remedied by using a little zoom.
- No pictures may be taken if these marks (e.g.) are flashing (flash is charging).
- If light from the flash on a subject is insufficient, neither the proper exposure nor White Balance is achieved.
- The flash effect may not be sufficient in the following cases:
 - Slow shutter speed
 - When [Burst] is set to
- Flash charging may take time if battery is low, or if using flash repeatedly.

Available types in each mode (○: Available, —: Not available, □: Default setting)

| | IA | P A | S M | [Scene Mode] | | | | | | | | | |
|--|-----|--------|--------|--------------|---|---|---|---|---|---|---|---|--|
| | | | | | | | | | | | | | |
| | ○*1 | ○ | ○ | ○ | ○ | ○ | — | ○ | ○ | ○ | ○ | ○ | |
| | — | ○ | ○ | ○ | ○ | — | — | — | ○ | — | — | — | |
| | — | ○ | ○ | ○ | ○ | ○ | — | ○ | ○ | ○ | ○ | ○ | |
| | — | ○ | — | — | — | — | ○ | — | — | — | — | — | |
| | ○ | ○ | ○ | ○ | ○ | ○ | ○ | ○ | ○ | ○ | ○ | ○ | |

*1 Set to , , or depending on the subject and brightness.

- The flash cannot be used when recording motion pictures or in the , , , , , and 3D Scene Modes.

The available flash range when [Sensitivity] setting is [AUTO]

| | |
|-----------|--|
| Max. Wide | Approx. 0.6 m-6.4 m (2.0 feet - 21 feet) |
| Max. Tele | Approx. 1.0 m-3.3 m (3.3 feet - 11 feet) |

Shutter speeds for each flash mode

| | |
|--|--------------------|
| | 1/60s*2 - 1/2000th |
| | 1s*2*3 - 1/2000th |

*2 Varies according to [Min. Shtr Speed] setting.

*3 When [Min. Shtr Speed] is set to [AUTO], and a jitter is detected when [Stabilizer] is turned to [ON], the maximum speed is 1/4 second. Also varies according to [Intelligent Auto] Mode and Scene Modes, etc.

Taking close-up pictures



When you want to enlarge the subject, setting to [AF Macro] (AF) enables you to take pictures at an even closer distance than the normal focus range (up to 3 cm (0.098 feet) for max. Wide).

1 Press **▼** to display [Macro Mode]

2 Use cursor button to select [AF Macro] (AF) and press [MENU/SET]

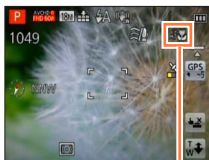

AF display

■ Taking close-up pictures without standing close to subject (TELE “Tele macro” function)

“Tele macro” operates automatically when you increase the zoom ratio to 12 times or higher while [AF Macro] (AF) is set, enabling the camera to focus on a subject as close as 1 m (3.3 feet).
(AF changes to TELE)

- It is not possible to set AF Macro Mode in the following cases.
 - In all Scene Modes except [3D Photo Mode]

[Macro Zoom]

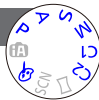

To take even larger images of the subject, setting to [Macro Zoom] (🔍) enables the subject to appear even larger than when using [AF Macro] (AF👉).

1 Press ▼ to display [Macro Mode]

2 Use cursor button to select [Macro Zoom] (🔍) and press [MENU/SET]

3 Adjust the magnification with the zoom lever



The zoom position is fixed at the Wide end.

Focus range is 3 cm (0.098 feet) - ∞.

Magnification (1 x to 3 x)

- You can also perform [Macro Zoom] by touch operations. (→71)

- In [Macro Zoom], higher magnification results in lower picture quality.
- When [Macro Zoom] is set, Extended optical zoom or [i.ZOOM] does not work.
- When [AF Tracking] is set, zoom macro is canceled.
- The [Macro Zoom] cannot be set in the following cases:
 - [Creative Control] Mode ([Toy Effect], [Miniature Effect])
 - When the [Burst] setting is set to or

Focus range

When a subject is too close to the camera, the picture may not be properly focused. The shortest recording distance differs depending on the zoom ratio and the setting in macro recording mode.

■ Shortest recording distance

The shortest recording distance is the distance from the lens front to the subject. This distance changes gradually depending on the zoom position. At the time of zooming, even if [Macro Mode] is set to [AF Macro] (AF \updownarrow), the shortest recording distance is the same as when the mode is set to OFF (2 m (6.6 feet) when the optical zoom magnification of 5x to 7x is used).

| Zoom | [Macro Mode] | |
|--------|-------------------|------------------|
| | AF \updownarrow | OFF |
| Max. W | 3 cm (0.098 feet) | 50 cm (1.6 feet) |
| Max. T | 1 m (3.3 feet) | 2 m (6.6 feet) |

- Focus range is displayed when operating the zoom, etc.

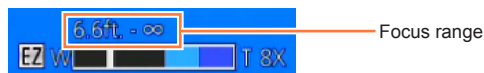

- It may take some time until distant subjects come into focus.
- Using a tripod and [Self Timer] is recommended. Also, when recording a subject that is close to the camera, setting [Flash] to \downarrow [Forced Flash Off] is recommended.
- Moving the camera after aligning the focus is likely to result in poorly focused pictures if subject is close to the camera, due to the margin for focus alignment being severely reduced.
- Resolution may be reduced around the edges of the picture.

Taking pictures with self-timer



We recommend using a tripod. This is also effective for correcting jitter when pressing the shutter button, by setting the self-timer to 2 seconds.

1 Press ◀ to display [Self Timer]

2 Use cursor button to select time duration and press [MENU/SET]

3 Take a picture

Press the shutter button fully to start recording after the preset time.

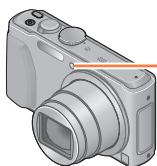

Self-timer indicator
(Flashes for set duration)

- To cancel while in operation → Press [MENU/SET]

- Focus will be automatically adjusted immediately before recording if the shutter button is pressed fully.
- After Self-timer indicator stops flashing, it may then be lit for AF Assist Lamp.
- This function cannot be used in the following cases:
 - [Underwater] and [High Speed Video] scene modes
 - Recording motion pictures

Taking pictures with Exposure Compensation



Corrects the exposure when there is a backlight or when the subject is too dark or too bright.

1 Press **▲** to display [Exposure]

2 Use cursor button to select a value and press [MENU/SET]

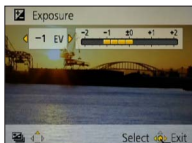

- If the picture is too dark, adjust the exposure to the “+” direction.
- If the picture is too bright, adjust the exposure to the “-” direction.
- After exposure adjustment, the adjustment value (e.g. +1/3 for example) is displayed in the bottom-left corner of the screen.

- Depending on the brightness, this may not be possible in some cases.
- The Exposure Compensation value you set is retained even after the camera is turned off.
- Exposure Compensation cannot be used with the [Starry Sky] Scene Mode.

Recording while exposure is changed automatically ([Auto Bracket])

Records 3 pictures in continuous succession while exposure is changed automatically. After exposure adjustment, the adjustment value is set as the standard.

1 Press ▲ several times to display [Auto Bracket]

2 Use cursor button to select a value and press [MENU/SET]

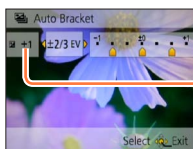

Value displayed after Exposure Compensation set

- The first picture is recorded without compensation, the second still picture is recorded with exposure adjusted in the “-” direction, and the third still picture is recorded with exposure adjusted in the “+” direction.

- Cannot be used with flash.
- When [Auto Bracket] is set, [Burst] is canceled.
- Canceled when the camera is turned off.
- [Auto Bracket] cannot be used in the following cases:
 - [Creative Control] Mode ([Toy Effect], [Miniature Effect], [Soft Focus], [Star Filter])
 - Scene Modes ([Handheld Night Shot], [HDR], [Starry Sky], [High Speed Video], [3D Photo Mode])
 - Recording motion pictures

Determine aperture and shutter speed and record

[Aperture-Priority] Mode



When recording, you can control the aperture value to meet your recording purposes.

Shutter speed is automatically adjusted to be appropriate for the set aperture value.

1 Set mode dial to **A** ([Aperture-Priority] Mode)

2 Press **[EXPOSURE]** button and use cursor button to determine aperture value

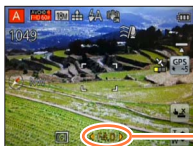

Aperture value

- When the aperture value is increased, the range of depth in focus expands, and the picture shows up clearly from the position of the camera to the background.
- When the aperture value is reduced, the range of depth in focus shrinks, and the background can get blurry.

3 Press **[EXPOSURE]** button

■ Recording motion pictures in **A**

- Aperture and shutter speed are automatically set.

- When the picture is too bright or too dark or there is incorrect exposure, the numbers for the aperture value and shutter speed are shown in red.
- LCD monitor brightness may vary from the actual still picture recorded.
- The lower limit of shutter speed differs depending on ISO Sensitivity.

[Shutter-Priority] Mode

When recording, you can control the shutter speed to meet your recording purposes.

Aperture is automatically adjusted to be appropriate for the set shutter speed.

1 Set mode dial to **S** ([Shutter-Priority] Mode)

2 Press **[EXPOSURE]** button and use cursor button to determine shutter speed



Shutter speed

- At faster shutter speeds, movements by the subject show as if they are still.
- At slower shutter speeds, subjects that are moving show as jittery.

3 Press **[EXPOSURE]** button

■ Recording motion pictures in **S**

- Aperture and shutter speed are automatically set.

- When the picture is too bright or too dark or there is incorrect exposure, the numbers for the aperture value and shutter speed are shown in red.
- LCD monitor brightness may vary from the actual still picture recorded.
- The lower limit of shutter speed differs depending on ISO Sensitivity.

[Manual Exposure] Mode

This mode of recording lets you set any aperture value and shutter speed when exposure adjustment prevents you from recording at the desired exposure (brightness/darkness).

- 1 Set mode dial to M** ([Manual Exposure] Mode)
 - Manual exposure assist is displayed.
- 2 Press [EXPOSURE] button and use cursor button to determine aperture value and shutter speed**

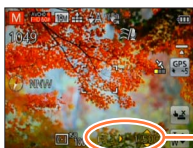

Aperture value/shutter speed

- 3 Press [EXPOSURE] button**

■ Recording motion pictures in M

- Aperture and shutter speed are automatically set.

■ Manual exposure assist (estimate)

If the shutter button is pressed halfway, manual exposure assist is displayed.

| | |
|--|---|
| | Shows pictures with standard brightness. |
| | Shows brighter pictures. For standard brightness, either use a faster shutter speed or increase aperture value. |
| | Shows darker pictures. For standard brightness, either use a slower shutter speed or reduce aperture value. |

- When the picture is too bright or too dark or there is incorrect exposure, the numbers for the aperture value and shutter speed are shown in red.
- LCD monitor brightness may vary from the actual still picture recorded.
- The lower limit of shutter speed differs depending on ISO Sensitivity.

Taking Pictures with different picture effects

[Creative Control] mode



You can select your own settings from various effects and take pictures while confirming these effects on the LCD monitor.

1 Set mode dial to 

2 Press **▲▼** to select an effect, and then press **[MENU/SET]**

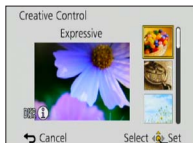

• If you press the [DISP.] button, an explanation of the effect appears.

■ Changing the selected picture effects ([Creative Control] menu)

- ① Press [MENU/SET]
- ② Use cursor button to select [Creative Control] menu and press [MENU/SET]
- ③ Press **▲▼** to select a setting, and then press [MENU/SET]

■ Recording motion pictures in

Records a motion picture at the optimum settings for the selected effects.

- You cannot record motion pictures with [Soft Focus] or [Star Filter].

- The flash is set to  ([Forced Flash Off]).
- The display of a picture reflecting a selected effect in the preview screen or recording screen may differ from the actual recorded pictures.
- A setting that was selected in [Creative Control] mode is retained even after the camera is turned off.
- Following [Rec] menu settings will be automatically adjusted and cannot be selected manually.
[Sensitivity], [White Balance], [i.Exposure], [Min. Shtr Speed], [Color Mode]

For the [Creative Control] menu setting procedures. (→85)

[Expressive]

This picture effect creates a pop art style picture that enhances the color.

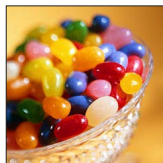

[Retro]

This picture effect creates the soft appearance of a tarnished picture.

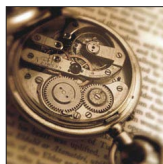

[High Key]

This picture effect creates a brighter and lighter toned appearance for the entire picture.

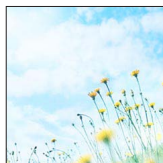

For the [Creative Control] menu setting procedures. (→85)

[Low Key]

This picture effect creates a darker somber appearance for the entire picture to emphasize the bright portions.



[Sepia]

This picture effect creates a picture with sepia tone.



[Dynamic Monochrome]

This picture effect creates a monochromatic picture with a higher contrast and more dramatic atmosphere.



For the [Creative Control] menu setting procedures. (→85)

[Impressive Art]

A picture effect with strong contrast that illustrates a surreal and dramatic atmosphere.



[High Dynamic]

This picture effect creates a picture with a well-balanced brightness for the entire picture (from dark areas to bright areas).



[Cross Process]

This picture effect creates a unique atmosphere with surprising colors.

■ Adjusting color

Use cursor button to adjust coloring, then press [MENU/SET]

- Settings: Greenish coloring / Bluish coloring /
Yellowish coloring / Reddish coloring

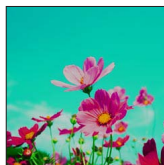

For the [Creative Control] menu setting procedures. (→85)

[Toy Effect]

This picture effect creates a picture that resembles pictures taken by a toy camera with a reduced amount of peripheral light.

■ Adjusting color

Use cursor button to adjust coloring, then press [MENU/SET]

- Settings: Orangish coloring ←→ Bluish coloring



[Miniature Effect]

This effect blurs peripheral areas to give the impression of a diorama.



- The recording screen is displayed like a frame dropping with a slight delay compared to normal recording.
- Portrait orientation recording does not affect the blurred part. (The left and right edges will be blurred.)
- No audio is recorded for motion pictures.
- When a motion picture is recorded, the finished recording will be approximately 1/10th of the actual recorded time period. (If you record a motion picture for 10 minutes, the resulting motion picture recording time will be approximately 1 minute.) The recordable time displayed on the camera is approx. 10x longer than actual time needed for recording. When the recording mode is changed, be sure to check the recordable time.
- If you stop recording motion pictures too soon, the camera may continue recording until a certain time. Hold the camera until the camera stops recording.
- When you take a picture using a large picture size setting, the screen will become dark for a certain period of time after the picture is taken. However, this occurs due to signal processing and is not a defect.

For the [Creative Control] menu setting procedures. (→85)

[Soft Focus]

This picture effect creates a soft appearance by intentionally blurring the entire picture.

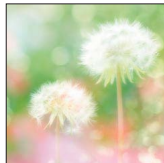

- The recording screen is displayed like a frame dropping with a slight delay compared to normal recording.
- When you take a picture using a large picture size setting, the screen will become dark for a certain period of time after the picture is taken. However, this occurs due to signal processing and is not a defect.
- Motion pictures cannot be recorded.

[Star Filter]

This picture effect creates a picture with the light from the light source that shines in the shape of a cross, creating a gorgeous atmosphere.



- The recording screen is displayed like a frame dropping with a slight delay compared to normal recording.
- When you take a picture using a large picture size setting, the screen will become dark for a certain period of time after the picture is taken. However, this occurs due to signal processing and is not a defect.
- Motion pictures cannot be recorded.

For the [Creative Control] menu setting procedures. (→85)

[One Point Color]

This picture effect creates a monochromatic picture by retaining the color you selected only, and adds memorable emphasis to it.

■ Selecting color

- ① Select the color to be retained using the frame in the center of the screen and press [MENU/SET]
- ② Check the effect in the preview screen and press [MENU/SET]
 - The next time this effect is used, the preview screen will display a picture with the settings of the color selected previously.
To reselect a color: Press the [DISP.] button
To record with current settings: Press [MENU/SET]



- The selected color may not be retained for some subjects.

Recording panorama pictures [Panorama Shot] Mode



You can easily record a panorama picture by panning the camera towards the direction you want to record, and automatically combining the burst of pictures taken during that time.

1 Set mode dial to []

2 Use cursor button to select the recording direction, and press [MENU/SET] to set

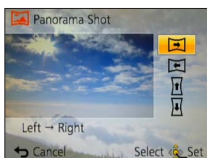

3 Use cursor button to select the picture effect and press [MENU/SET]

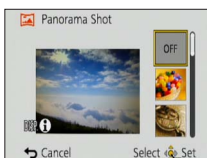

- Use the same operations as in [Creative Control] Mode to add picture effects. (you cannot select [Toy Effect] or [Miniature Effect]) For details on effects (→86 - 91)
- If you do not want to add picture effects, please select [OFF].

4 Check the recording direction and press [MENU/SET]

A horizontal or vertical guide appears.

- If you press ►, you will return to step 2.

5 Press the shutter button halfway to focus

(Continued on the next page)

6 Press the shutter button fully and pan the camera in a small circular motion in the selected direction to start recording

- Taking pictures from left to right

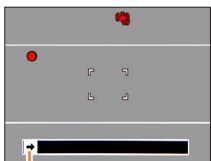

Recording direction and progress status (approximate)

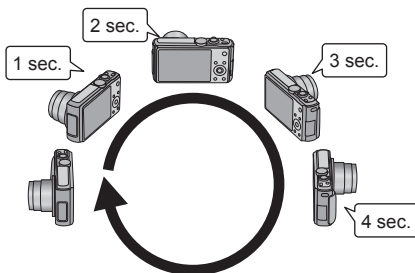

- Pan the camera so that you make a complete circuit in approx. 8 seconds
 - Pan the camera at a constant speed.
 - You may not be able to take pictures successfully if you move the camera too quickly or too slowly.
 - Pan the camera in a small circular motion.

7 Press the shutter button fully again to end recording

- You can also end recording if you stop panning the camera while taking pictures.

■ Tips

- Pan the camera in the recording direction as steadily as possible.

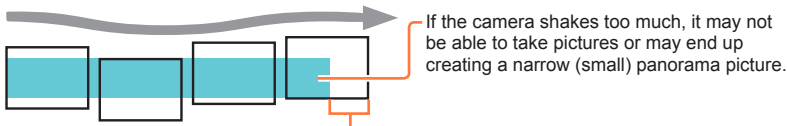

Pan the camera to a point slightly ahead of the point that you want to take. (However, the last frame is not recorded to the end.)

- The zoom position is fixed to the W end.
- The focus, exposure and White Balance are all fixed to optimal values for the first picture.
If the focusing or brightness of pictures recorded as part of a Panorama picture after the first picture are significantly different from those of the first picture, the Panorama picture as a whole (when all pictures are stitched together) may not have consistent focus and brightness.
- The following functions are fixed to the settings indicated below.
[Stabilizer]: [OFF] [Date Stamp]: [OFF]
- [White Balance] cannot be set when applying picture effects (if anything else but [OFF] is selected in Step 3).
- Since several pictures are stitched together to create a Panorama picture, some subjects may be distorted or the joining portions of successively taken pictures that are stitched may be noticeable.
- The number of recording pixels per horizontal line and vertical line of a Panorama picture varies depending on the recording direction and number of stitched pictures. The maximum number of recording pixels is as follows:
 - Taking pictures in landscape orientation: Approx. 8000 x 1080
 - Taking pictures in portrait orientation: Approx. 1440 x 8000
- Panorama pictures may not be created or pictures may not be recorded properly when taking pictures of the following subjects or when taking pictures in the following recording conditions:
 - Subjects that have a continuous monotone or pattern (sky, beach, etc.)
 - Moving subjects (person, pet, vehicle, waves, or flowers swaying in the wind, etc.)
 - Subjects whose colors or patterns change quickly (such as an image appearing on a display)
 - Dark locations
 - Locations with a flickering light source (fluorescent lamp, candle light, etc.)
- When set to [High Key], the effect may be difficult to see, depending on the brightness of the subject.
- When set to [Impressive Art], stitches may stand out.
- While recording with [Soft Focus] [Star Filter], you cannot see the effects on the LCD monitor.

■ About panorama playback

You can operate the zoom lever or perform touch operations to enlarge still pictures taken in [Panorama Shot] mode in the same way as with other still pictures. If you play back panorama pictures in the same way as playing back a motion picture, the panorama pictures are scrolled automatically. (→49)

- Unlike motion picture playback, you cannot perform fast forward or fast rewind while the panorama pictures are scrolling automatically. (You can perform single-frame forward or rewind while the automatic scrolling operation is paused.)

Taking pictures according to the scene

[Scene Mode]



Using [Scene Mode] enables you to take pictures with optimum settings (exposure, coloring, etc.) for given scenes.

1 Set mode dial to SCN

2 Use cursor button to select the scene and press [MENU/SET]



■ Changing the selected scene mode ([Scene Mode] menu)

- ① Press [MENU/SET]
- ② Use cursor button to select [Scene Mode] menu and press [MENU/SET]
- ③ Use cursor button to select the scene and press [MENU/SET]

■ Recording motion pictures in SCN

Records a motion picture at the optimum settings for the selected scene.

- You cannot record motion pictures in [3D Photo Mode].
- Some scenes are switched to the following scenes:

| Selected scene | Scenes for motion picture |
|--|---------------------------|
| [Baby] | Portrait motion picture |
| [Night Portrait], [Night Scenery], [Handheld Night Shot], [Starry Sky] | Low light motion picture |
| [Sports], [HDR], [Pet] | Normal motion picture |

- Selecting a Scene Mode inappropriate for the actual scene may affect the coloring of your picture.
- Following [Rec] menu settings will be automatically adjusted and cannot be selected manually.
[Sensitivity], [Metering Mode], [i.Exposure], [Min. Shtr Speed], [i.Resolution], [Color Mode]

- How to select a scene (→95)

[Portrait]

Improves the skin tone of subjects for a healthier appearance in bright daylight conditions.

■ Tips

- The more the zoom is drawn towards T side and the closer the camera is brought to the subject, the greater the effect will be.

[Soft Skin]

Smooths skin colors in bright, outdoor daylight conditions (portraits from chest upwards).

■ Tips

- The more the zoom is drawn towards T side and the closer the camera is brought to the subject, the greater the effect will be.

[Scenery]

Takes clear pictures of wide, distant subjects.

- How to select a scene (→95)

[Sports]

Takes pictures of scenes with fast movement, e.g. sports.

■ Tips

- Stand at least 5 m (16 feet) away.
- Shutter speed may slow down up to 1 second.

[Night Portrait]

Takes pictures of people and nightscapes with close to actual brightness.

■ Tips

- Use flash.
- Subject should not move.
- Tripod, self-timer recommended.
- Shutter speed may slow down up to 4 seconds.
- After recording, the shutter may stay closed (up to 4 seconds) to process the signal. This is not a malfunction.

[Night Scenery]

Takes clear pictures of night scenes.

■ Tips

- Tripod, self-timer recommended.
- Shutter speed may slow down up to 4 seconds.
- After recording, the shutter may stay closed (up to 4 seconds) to process the signal. This is not a malfunction.

- How to select a scene (→95)

[Handheld Night Shot]

Takes clear still pictures of night scenes with less jitter and less noise by combining a burst of still pictures.

■ Tips

- Stand at least 5 m (16 feet) away.
 - After the shutter button has been pressed, do not move the camera during the burst operation.
- Since a burst of still pictures are combined after they have been recorded, it will be a few moments before you will be able to record another picture.

[HDR]

The camera can combine several still pictures taken with different exposures into a single properly exposed picture with rich gradation. The individual pictures used to create the HDR picture are not saved. You can minimize the loss of gradations in bright areas and dark areas when, for example, the contrast between the background and the subject is large.

■ What is HDR?

HDR stands for High Dynamic Range and refers to a technique for expressing a wide contrast range.

■ Tips

- After the shutter button has been pressed, do not move the camera during the burst operation.
- Since a burst of still pictures are combined after they have been recorded, it will be a few moments before you will be able to record another picture.
- A subject that was in motion when it was recorded may be recorded as an afterimage.
 - The camera may take a single still picture instead of several pictures under certain recording conditions.

[Food]

Takes natural-looking pictures of food.

- How to select a scene (→95)

[Baby]

This takes pictures of a baby with a healthy complexion. When you use the flash, the light from it is weaker than usual.

■ To record age and name

[Baby1] and [Baby2] can be set separately.

1 Use cursor button to select [Age] or [Name] and press [MENU/SET]

2 Select [SET] with cursor button and then press [MENU/SET]

3 Set the birthday and name

Age: Set birthday with cursor button, and press [MENU/SET].

Name: (See "Entering Text": (→114))

4 Use cursor button to select [Exit] and press [MENU/SET]

■ Tips

- Make sure [Age] and [Name] are [ON] before taking a picture.

- Age display format depends on [Language] setting.
- Shutter speed may slow down up to 1 second.
- [Age] and [Name] print setting can be made on your computer using "PHOTOfunSTUDIO" on the supplied disc. Text may also be stamped onto the still picture using [Text Stamp].

[Pet]

Records pet's age and name when taking pictures.

- Refer to [Baby] for other tips etc.

[Sunset]

Takes clear pictures of scenes such as sunsets.

- How to select a scene (→95)

[High Sens.]

Prevents blurring of subject in dark, indoor conditions.

1 Select the aspect ratio and the picture size with cursor button and press [MENU/SET]

- Settings: **4:3** [3M] / **3:2** [2.5M] / **16:9** [2M] / **1:1** [2.5M]

[Starry Sky]

Gives starry skies and dark subjects a clear appearance.

1 Use cursor button to select shutter speed, and then press [MENU/SET]

- Settings: [15 sec.] / [30 sec.]

■ Tips

- Tripod, self-timer recommended.
- Do not move the camera until the countdown is finished. After taking the picture, the countdown is displayed again while the signal is processed.
- [Stabilizer] does not work.

[Glass Through]

The camera prioritizes focusing on distant subjects. Most suitable for taking pictures such as a landscapes through the transparent glass of a train/vehicle or building.

- If there are stains such as dust or a reflection on the glass, the camera may focus on the glass instead of a subject.
- The color of pictures may appear unnatural due to the color of the glass. (You may be able to reproduce the appropriate color by adjusting the White Balance.)

- How to select a scene (→95)

[Underwater]

Adjusts the color characteristics of the camera to improve the pictures in an underwater environment.

■ About [White Balance]

You can adjust colors according to your preference by using the “White Balance fine adjustment” (→117).

■ Tips

- For fast moving subjects, align with the AF area and press ◀ (AF Lock).
(Press ◀ again to release.)



- If the zoom is operated after AF Lock is set, the AF Lock setting will be canceled and must be set again.
- AF Lock cannot be set if [AF Mode] is set to .

- Always use marine case (DMW-MCTZ40: optional).
- Positioning is not possible underwater, because the GPS signals cannot reach the camera. **DMC-ZS30**
- NFC functions cannot be used while using a marine case.
- Cannot connect to Wi-Fi underwater because wireless LAN signals cannot reach the camera.
- When there are many underwater objects, set the flash to .

- How to select a scene (→95)

[High Speed Video]

Motion pictures are recorded by greatly increasing frames per second, so movement can be displayed in slow motion during playback.

1 Use cursor button to select motion picture quality (frame rate), then press [MENU/SET]

| fps | Picture size |
|--------|--------------|
| 240fps | VGA 640×480 |
| 120fps | HD 1280×720 |

2 Press the motion picture button to start recording

3 Press the motion picture button again to finish recording

- Motion picture recording can also be started or finished by pressing the shutter button. (The touch shutter function will be disabled.)
- During playback, the movements of a subject that cannot be seen by the naked eye can be made recognizable by playing back the motion pictures using slow motion.

- High-speed motion pictures cannot be recorded in the built-in memory.
- No sound is recorded.
- Still pictures cannot be recorded while high-speed motion pictures are being recorded.
- The settings for the focus, zoom, exposure and White Balance are fixed to the settings specified when recording was started.
- [Stabilizer] does not work.
- The [AF Mode] is set to  (1-area-focusing).
- Flickering or horizontal stripes may appear while recording under fluorescent lighting.

- How to select a scene (→95)

[3D Photo Mode]

Pictures are recorded continuously while moving the camera horizontally, and two pictures selected automatically are combined to make a single 3D picture.

To view 3D pictures, a television that supports 3D is required (This unit will play back in 2D). (→257)

1 Start the recording and then pan the camera horizontally straight from left to right

- A guide is displayed while recording.
- Move the camera approximately 10 cm (0.33 feet) within approximately 4 seconds using the guide.

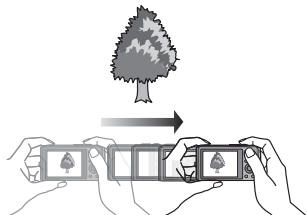

Tips for recording pictures

- Record a stationary subject.
- Record a picture outdoors or in other bright locations.
- Press the shutter button halfway to fix the focus and the exposure, press the shutter button fully, and then pan the camera.
- Hold the camera so that the subject is slightly to the right of the center on the display at the start of the recording. This makes it easier to position the subject in the center of the recorded picture.

● 3D still pictures cannot be recorded by holding this camera vertically.

- 3D still pictures are recorded in MPO format (3D).
- The zoom position is fixed to the W end.
- The picture size is fixed to 2M **16:9**.
- ISO Sensitivity is automatically adjusted. However, ISO Sensitivity is increased to make the shutter speed faster.
- Motion pictures cannot be recorded.
- [Stabilizer] does not work.
- When any of the recording conditions listed below exists, it may be impossible to record any images at all. Or there may be no 3D effect, or the image may be distorted even if a picture is recorded.
 - When the subject is too dark or too bright
 - When the subject's brightness changes
 - When the subject is moving
 - When pictures are recorded underwater
 - When the subject lacks contrast

Register your own settings and record

[Custom] Mode

Registering your preferred recording mode, [Rec] menu settings, etc. to [Cust.Set Mem.] and setting the mode dial to C1/ C2 allows you to switch quickly to those settings.

[Cust.Set Mem.]

Up to 4 current camera settings can be registered.



1 Select the recording mode you wish to register and set the [Rec] menu, [Motion Picture] menu, [Setup] menu, etc.

2 Select [Cust.Set Mem.] from the [Setup] menu

- For the setting procedures of the menu. (→54)

3 Use cursor button to select custom set for registration and press [MENU/SET]

- A confirmation screen is displayed. Select [Yes] with cursor button and then press [MENU/SET].
- The custom settings registered in [C1] can be used with the C1 of the mode dial. It will be convenient if the custom setting used often is registered, since it can be used by just setting the mode dial.
- The custom settings registered in [C2-1], [C2-2] or [C2-3] can be selected in the C2 of the mode dial. Up to 3 custom settings can be registered, so select the one matching the needs.

- Self-timer is not stored in custom set.
- Some menu items are not saved, such as [Clock Set] and [Beep].

[Custom]

Settings registered in [Cust.Set Mem.] can be quickly called up by setting the mode dial to C1 / C2.

**1 Set mode dial to C1 / C2 ([Custom] mode)**

- When set to C1
→ The camera switches to the recording mode and settings registered in C1.
- When set to C2
→ Perform steps **2** - **3**

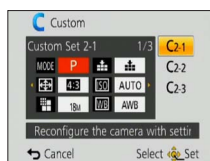
2 Use cursor button to select custom set

- Use ◀ and ▶ to confirm the registered settings.
- Only the main menu items are displayed.

3 Press [MENU/SET] to enter the settings

The camera switches to the recording mode and settings of the selected custom set.

■ When changing the menu settings

Even if the menu settings are changed temporarily when [C1], [C2-1], [C2-2] or [C2-3] is selected for using the custom set, the currently registered settings will remain unchanged.

To change the currently registered settings, overwrite the registered data using [Cust. Set Mem.] (→104) on the [Setup] menu.

■ Changing from one C2 custom setting to another C2 custom setting [Custom] menu)

- ① Press [MENU/SET]
- ② Select [Custom] menu and press [MENU/SET]
- ③ Use ▲ ▼ to select custom set and press [MENU/SET]

■ Recording motion pictures in C1 / C2

Records motion pictures in registered recording mode.







Burst function



A burst of still pictures can be recorded while the shutter button is pressed fully.

1 Select [Burst] from the [Rec] menu (→54)

2 Use cursor button to select the burst setting, and press [MENU/SET]



| Setting | Speed | Description | No. of pictures |
|--|------------------------------------|---|-----------------|
|  *1 | Approx. 2 - 10 pictures/sec. | <ul style="list-style-type: none"> The burst speed is adjusted automatically in accordance with the movements of people, pets or other subjects. ([Intelligent Burst mode]) When a fast-moving subject is recorded, the frame rate becomes faster and the number of pictures that can be recorded in a series is restricted to about 10. | 100*2 |
|  | Approx. 2 pictures/sec. | <ul style="list-style-type: none"> The subject is brought into focus as far as this is allowed by the burst speed. The pictures are taken with the burst function while the exposure and White Balance are being adjusted. (However, when the burst function is operating during motion picture recording, the focus is fixed to the first picture.) The burst speed may be reduced under certain recording conditions. | 100*2 |
|  | Approx. 5 pictures/sec. | | |
|  | Approx. 10 pictures/sec. | <ul style="list-style-type: none"> Focus, exposure and White Balance are fixed in the first picture. | 6 |
|  | 40 pictures/sec. | <ul style="list-style-type: none"> Focus, exposure and White Balance are fixed in the first picture. Note on the picture size setting (→107) | 30 |
|  | 60 pictures/sec. | <ul style="list-style-type: none"> Focus, exposure and White Balance are fixed in the first picture. The recordable range is reduced. Note on the picture size setting (→107) | 60 |
|  *3 | Complies with recording conditions | <ul style="list-style-type: none"> The burst of still pictures can be recorded even in low light conditions as the flash is used. ([Flash Burst]) The focus, exposure, and flash level are all fixed to the settings for the first picture. Note on the picture size setting (→107) | 5 |
| [OFF] | — | The burst function is released. | — |













*1 [Intelligent Auto] Mode only

*2 The number of burst pictures is limited by the picture-taking conditions and the type and/or status of the card used.

*3 Only in [Program AE], [Aperture-Priority] and [Shutter-Priority] modes

■ Note on the picture size setting

| [Aspect Ratio] |  |  |  |
|----------------|---|---|---|
| 4:3 | 5M, 3M, 0.3M | 2.5M, 0.3M | 3M |
| 3:2 | 4.5M, 2.5M, 0.3M | 3M, 0.3M | 2.5M |
| 16:9 | 3.5M, 2M, 0.2M | 3.5M, 0.2M | 2M |
| 1:1 | 3.5M, 2.5M, 0.2M | 2M, 0.2M | 2.5M |

- Pictures taken with the  or  setting are recorded together as a group (picture group). (→130)
- Depending on changes in the brightness of the subject, the second and subsequent pictures may be recorded brighter or darker when using the burst function at the , ,  or  setting.
- Burst speed may be reduced if shutter speed is reduced in darker locations.
- The pictures taken using the burst function at the  or  setting may be distorted if the subjects were moving or the camera was moved.
- [Auto Bracket] is released.
- The flash is set to  [Forced Flash Off]. (Excluding  [Flash Burst])
- Settings will be stored even if the camera is turned off.
- The burst function cannot be used in the following cases:
 - Scene Modes ([Handheld Night Shot], [HDR], [Starry Sky], [High Speed Video], [3D Photo Mode])
 - [Creative Control] Mode ([Toy Effect], [Miniature Effect], [Soft Focus], [Star Filter])
- When the scene mode is set to [Night Portrait], [Night Scenery] or [High Sens.],  or  cannot be selected.
- When [Self Timer] is set, 3 pictures are taken. (When  [Flash Burst] is set, 5 pictures are taken.)
- It may take a while to store still pictures that were taken using the burst function. If you continue to record while storing, the number of burst pictures that can be taken will be reduced. A high-speed card is recommended when recording using the burst function.
- You cannot use zoom during burst recording.

Recording with the Face Recognition function

[Face Recog.]



- Default [Face Recog.] setting is [OFF].
- When the face pictures are registered, the setting will be [ON] automatically.

■ How the Face Recognition function works

During recording

(When [AF Mode] is  (Face Detection))

- The camera recognizes a registered face and adjusts focus and exposure.
- When registered faces that have set names are recognized, the names are displayed (up to 3 people).



During playback

- The name and age are displayed (if information is registered).
- The names that have been set for the recognized faces are displayed (up to 3 people).
- Only pictures of the selected registered people are played back ([Category Selection]).

■ Recording tips when registering face pictures

- Make sure the subject's eyes are open and mouth closed; have the subject face the camera directly, and make sure the outline of the face, the eyes and eyebrows are not hidden by hair.
- Make sure there are no heavy shadows on the face. (During registration, the flash is not used.)

■ If the camera seems to have difficulty recognizing faces when recording

- Register additional pictures of the same person's face, indoors and outdoors or with different expressions or angles.
- Register additional pictures at the place you are recording.
- If a registered person is no longer recognized, re-register that person.

- When Burst is performed, recording information relating to Face Recognition is only added to the first picture.
- If you press the shutter button halfway, then point the camera at a different subject and record, recording information for a different person may be added to the picture.
- Face Recognition does not work in the following cases:
 - [Creative Control] Mode ([Miniature Effect], [Soft Focus])
 - Scene Modes ([Night Scenery], [Handheld Night Shot], [Food], [Starry Sky], [Underwater], [High Speed Video], [3D Photo Mode])
 - Motion picture
- Face Recognition searches for faces similar to those registered, but there is no guarantee it will always recognize these faces. In some cases, the camera cannot recognize or incorrectly recognizes even registered people depending on their expression or the environment.
- Even if Face Recognition information is registered, pictures recorded when the name is [OFF] are not categorized for Face Recognition in [Category Selection].
- **Even if Face Recognition information is changed, Face Recognition information for previously recorded pictures is not changed.**
For example, if a name is changed, pictures recorded before the change are not categorized for Face Recognition in [Category Selection].
- To change name information for pictures already recorded, perform a [REPLACE] (→156) in [Face Rec Edit].

Registering face pictures

Up to 6 people's face pictures can be registered along with such information as name and birthdate.

You can facilitate Face Recognition by the way you register faces: for example, register multiple face pictures of the same person (up to 3 pictures in one registration).

1 Select [Face Recog.] from the [Rec] menu (→54)

2 Select [MEMORY] with cursor button and then press [MENU/SET]

3 Select [New] with cursor button and then press [MENU/SET]
 • If 6 people are already registered, first delete a registered person. (→111)

4 Record the face picture

① Align the face with the guide and record.

② Select [Yes] with cursor button and then press [MENU/SET].

• If re-recording, select [No]

• Faces of subjects other than people (e.g. pets) cannot be registered.

• When [DISP.] button is pressed, an explanation is displayed.



5 Press ▲ ▼ to select the item for editing and press [MENU/SET]

| | |
|--------------|--|
| [Name] | ① Select [SET] with cursor button and then press [MENU/SET] ② Enter the name (See "Entering Text": (→114)) |
| [Age] | Set the birthdate. ① Select [SET] with cursor button and then press [MENU/SET] ② Use ◀ ▶ to select year, month and day, set with ▲ ▼, and press [MENU/SET] |
| [Focus Icon] | Change the icon that is displayed when the subject is in focus. ① Select the focus icon with cursor button and then press [MENU/SET] |
| [Add Images] | Up to 3 face pictures of the person can be registered. ① Use cursor button to select [Add Images] and press [MENU/SET] • When a registered face picture is selected with cursor button, a screen to confirm deletion is displayed. Select [Yes] to delete the face picture. (If only one picture is registered, it cannot be deleted.) ② Record the picture (Step 4 above.) ③ Press [] / [] button |

Editing or deleting information about registered persons

Information about registered people can be edited or deleted.

- 1** Select [Face Recog.] from the [Rec] menu (→54)
- 2** Select [MEMORY] with cursor button and then press [MENU/SET]
- 3** Use cursor button to select the picture of the person to be edited or deleted and press [MENU/SET]
- 4** Use cursor button to select the item and press [MENU/SET]

| | |
|-------------|--|
| [Info Edit] | Edit name or other registered information. (→110) |
| [Priority] | Set priority order for focus and exposure. ① Select the registration order with cursor button and then press [MENU/SET] |
| [Delete] | Delete information and face pictures of registered persons. |

Useful features for travel

[Travel Date]



- For [Setup] menu setting procedures (→54)

If you set your travel schedule and record pictures, the day of your trip on which the picture was taken will be recorded.

- 1** Select [Travel Date] from the [Setup] menu (→54)
- 2** Use cursor button to select [Travel Setup] and press [MENU/SET]
- 3** Use cursor button to select [SET] and press [MENU/SET]
- 4** Use cursor button to select the departure date and press [MENU/SET]
- 5** Use cursor button to select the return date and press [MENU/SET]

■ To record [Location]

Once the [Travel Setup] is set, you can set the location.

- ① Select [Location] in step **2** above
- ② Use cursor button to select [SET] and press [MENU/SET]
- ③ Enter your location (Entering text (→114))

- The travel date is calculated from the set departure date and the date set in the camera's clock. When destination is set in [World Time], days elapsed are calculated based on local destination time.
- When [Travel Setup] is set to [OFF], the number of days elapsed is not recorded. It is not displayed even if [Travel Setup] is set to [SET] after recording.
- If settings are made before departure date, number of days to departure are not recorded.
- [Location] is recorded separately from the location name information which is recorded on the pictures by the GPS function. **DMC-ZS30**
- To print [Location] or the number of days that have passed, either use [Text Stamp] or print using the "PHOTOfunSTUDIO" software on the supplied disc.
- [Travel Date] cannot be recorded for AVCHD motion pictures. (Except [G]) **DMC-ZS30**
- [Travel Date] cannot be recorded for AVCHD motion pictures. **DMC-ZS27**
- Cannot be set when using [Intelligent Auto] Mode. The settings in other Recording Mode are applied.

[World Time]



- For [Setup] menu setting procedures (→54)

Set the recording date and time with the local time at your destination.

Preparation: Set [Auto Clock Set] to [OFF]. (→168)

1 Select [World Time] from the [Setup] menu (→54)

- Message will be displayed when setting for the first time. In this case, press [MENU/SET] and skip to step 3.

2 Use cursor button to select [Destination] and press [MENU/SET]

3 Use cursor button to select area and press [MENU/SET]

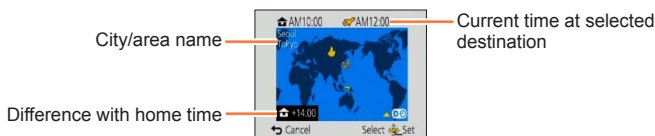

When [Destination] has been selected

■ To set summer time

Press ▲ in step 3. (Press again to release the setting)

- When summer time is set, the current time is advanced by 1 hour. If the setting is canceled, the time automatically returns to the current time.

■ When you come back from your travel destination

Select [Home] in step 2 and press [MENU/SET].

- If you cannot find your destination in the area displayed on the screen, set based on difference with home time.
- 📷 is displayed on the screen for pictures recorded at the destination when they are played back.
- When [Auto Clock Set] is set to [ON], you cannot change the area of [Destination]. (You can only change the summer time setting of [Destination].) **DMC-ZS30**

Entering Text

Use the cursor button to enter names with the Face Recognition function and in Scene Modes [Baby] and [Pet], or to register locations in [Travel Date] etc.

1 Use cursor button to select characters

2 Press [MENU/SET] several times until the desired character is displayed





Text is inserted at the cursor position.

- To change the character type
→ Select , and press [MENU/SET].

Cursor position

■ Editing text

- Use cursor button to select   and press [MENU/SET]. Then, move the cursor to the text to edit
 - You can also use the zoom lever to reposition the cursor.
- Use cursor button to select [Delete], and then press [MENU/SET]
- Use cursor button to select the correct text, and then press [MENU/SET]

3 When you are finished entering text, use cursor button to select [Set] and press [MENU/SET]

- A maximum of 30 characters can be entered. (Maximum of 9 characters for [Face Recog.] names)
- Up to 15 characters can be entered for \backslash , [], [], [], [•] and [-]. (Maximum of 6 characters for [Face Recog.] names)

Using the [Rec] menu

You can perform settings such as tones, Sensitivity, Aspect Ratio, and Picture Size.

- For the setting procedures of the menu. (→54)

[Aspect Ratio]

Set the aspect ratio of still pictures.

- Settings: **4:3** / **3:2** / **16:9** / **1:1**

- Edges may be cut off when printing – be sure to check in advance.
- This setting is not available in [3D Photo Mode] Scene Mode.



[Picture Size]

Set the size (number of pixels) of still pictures. Number of pictures which can be recorded depends on this setting and on [Quality].

- Settings

| Picture Size ([Aspect Ratio]: 4:3) | | | | | |
|---|-----------------------------|--------------------------|----------------------------|----------------------------|--------------------------|
| 18M 4896×3672 | 12M * 4000×3000 | 8M * 3264×2448 | 5M 2560×1920 | 3M * 2048×1536 | 0.3M 640×480 |
| Picture Size ([Aspect Ratio]: 3:2) | | | | | |
| 16M 4896×3264 | 10.5M * 4000×2672 | 7M * 3264×2176 | 4.5M * 2560×1712 | 2.5M * 2048×1360 | 0.3M * 640×424 |
| Picture Size ([Aspect Ratio]: 16:9) | | | | | |
| 13.5M 4896×2754 | 9M * 4000×2248 | 6M * 3264×1840 | 3.5M * 2560×1440 | 2M * 1920×1080 | 0.2M * 640×360 |
| Picture Size ([Aspect Ratio]: 1:1) | | | | | |
| 13.5M 3672×3672 | 9M * 2992×2992 | 6M * 2448×2448 | 3.5M * 1920×1920 | 2.5M * 1536×1536 | 0.2M * 480×480 |

* This setting is not available in ([Intelligent Auto] Mode).

- Mosaic effect may appear depending on subject and recording conditions.
- This setting is not available in [High Sens.] and [3D Photo Mode] Scene Modes.

Setting guide

| Larger picture size | ←→ | Smaller picture size |
|--------------------------|----|---------------------------|
| Sharper | | Less detailed |
| Lower recording capacity | | Higher recording capacity |

- For the setting procedures of the menu. (→54)

[Quality]



Set quality of picture.

- **Settings:** ([Fine]) High quality, priority to picture quality
 ([Standard]) Standard quality, priority to the number of pictures

- The setting is fixed to in [High Sens.] Scene Mode.
- When [3D Photo Mode] Scene Mode is selected, the displayed icons are different:
 ([3D+Fine]): An MPO picture and a high quality JPEG picture are recorded simultaneously.
 ([3D+Standard]): An MPO picture and a standard quality JPEG picture are recorded simultaneously.

[Sensitivity]



Set ISO Sensitivity (sensitivity to lighting) manually.

We recommend higher settings to take clear pictures in darker locations.

- **Settings:** [AUTO] / [100] / [200] / [400] / [800] / [1600] / [3200] / [H.6400]*

Setting guide

| [Sensitivity] | [100] ← → [H.6400]* |
|------------------------|------------------------|
| Location (recommended) | Bright (outdoors) Dark |
| Shutter speed | Slow Fast |
| Interference | Low High |
| Subject blur | High Low |

- [AUTO] is automatically set in a range up to 1600 based on subject brightness.
- is automatically set in a range up to 1600 based on subject movement and brightness.
- The [Sensitivity] is automatically set in the following cases:
 - When recording motion pictures
 - When [Burst] is set to
- The shutter speed is restricted as follows based on the [Sensitivity] setting.

| [Sensitivity] | Shutter speed |
|-----------------|---|
| AUTO / | Automatically changes depending on the [Sensitivity] setting. |
| 100 / 200 / 400 | 4 - 1/2000th |
| 800 / 1600 | 1 - 1/2000th |
| 3200 / H.6400* | 1/4 - 1/2000th |

- Cannot select in [Shutter-Priority] Mode.
- Cannot select [AUTO] or in [Manual Exposure] Mode.

* Only when [Extended ISO] is [ON].

- For the setting procedures of the menu. (→54)

[Extended ISO]

The [Sensitivity] setting will become configurable up to [H.6400].

- Settings: [ON] / [OFF]



[White Balance]

Adjust the color depending on the light source to ensure natural color.

- Settings: [AWB] (automatic) / ☀ (outdoor, clear sky) / ☁ (outdoor, cloudy sky) / 🏠 (outdoor, shade) / 🔦 (Incandescent lighting) / 📷 (uses value set in [SET]) / [SET] (set manually)



- When [AWB] (Automatic White Balance) is set, the coloring is adjusted in accordance with the light source. However, if the scene is too bright or too dark or if other extreme conditions apply, the pictures may appear reddish or bluish. The White Balance may not operate correctly if there is a multiple number of light sources.
- Under fluorescent lighting, LED lighting fixture etc., the appropriate White Balance will vary depending on the lighting type, so use [AWB] or [SET].
- [White Balance] setting is fixed to [AWB] in the following cases:
Scene Modes ([Scenery], [Night Portrait], [Night Scenery], [Handheld Night Shot], [Food], [Sunset], [Starry Sky], [Underwater])
- Even if the camera is turned off, the set White Balance is remembered. (If the Scene Mode is changed, the white balance setting returns automatically to [AWB].)

■ White Balance fine adjustment (excluding [AWB])

White Balance settings can be individually fine-tuned if colors still do not appear as anticipated.

- ① Select the white balance to be fine-tuned, and press the [DISP.] button to display the [WB Adjust.] screen
- ② Adjust with ► if red is strong, adjust with ◀ if blue is strong
- ③ Press [MENU/SET]
 - Settings are remembered even if the camera is turned off.
 - Settings remain applied when using flash.
 - Even though the [AWB] setting is fixed in [Underwater] Scene Mode, fine adjustments may still be made.
 - Fine adjustments cannot be made when [Color Mode] (→123) is set to [B&W] or [SEPIA].

■ Setting White Balance manually (SET)

Take a picture of a white object under the target light source to adjust colors.

① Select  SET and press [MENU/SET]

② Point the camera towards a white object (e.g. paper) and press [MENU/SET]

White Balance is set to .

- Even if the camera is turned off, the set White Balance is remembered.
- It may not be possible to set the correct White Balance if subjects are too bright or too dark. In this case, adjust the brightness and try to set the White Balance again.

■ [AWB] operational range:

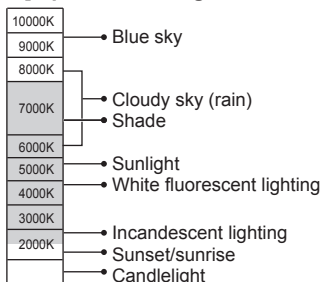

K=Kelvin Color Temperature

- For the setting procedures of the menu. (→54)









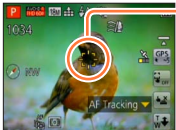



[AF Mode]

Method of aligning focus can be changed according to position and number of subjects.



- Settings: / / / /

| | |
|---|--|
| <p>Taking front-on pictures of people</p> <p> (Face Detection)</p> | <p>Recognizes faces (up to 15 people) and adjusts exposure and focus accordingly.</p>  <p>AF area Yellow: When the shutter button is pressed halfway, the frame turns green when the camera is focused. White: Displayed when more than one face is detected. Other faces that are the same distance away as faces within the yellow AF area are also focused.</p> |
| <p>Automatically locking the focus on a moving subject</p> <p> (AF Tracking)</p> | <p>Touch the subject</p>  <p>AF Tracking frame When the subject is recognized, the AF Tracking frame changes from white to yellow, and the subject is automatically kept in focus. If AF Lock fails, a red frame flashes.</p> <ul style="list-style-type: none"> • Perform these operations with the touch shutter function (→32) released. • To release AF Tracking → Touch . • Focus range (same as macro recording) (→78) • You can also use ▼ to perform this function. |
| <p>Subject not centered in picture</p> <p> (23-area-focusing)</p> | <p>Focus on the subject in the forefront of a wide range area (up to 23-area-focusing) on the recording screen.</p> |
| <p>Determined position for focus</p> <p> (1-area-focusing) (Spot-focusing)</p> | <p>1-area-focusing: Focuses on AF area in center of picture. (Recommended when focus is difficult to align) Spot-focusing: Focuses on smaller, limited area.</p> |

- Focus is fixed to  (1-area-focusing) in the following cases:
 - Scene Modes ([Starry Sky], [High Speed Video])
 - [Creative Control] Mode ([Miniature Effect])
- Use  (1-area-focusing) if focus is difficult to align with  (Spot-focusing).
- Cannot set to  (Face Detection) in the following cases:
 - Scene Modes ([Night Scenery], [Handheld Night Shot], [Food], [Underwater])
 - [Creative Control] Mode ([Soft Focus])
 - [Panorama Shot] Mode
- If the camera misinterprets a non-human subject as a face in  (Face Detection) setting, switch to another setting.
- If conditions prevent the face from being recognized, such as when the movement of the subject is too rapid, the [AF Mode] setting switches to  (23-area-focusing).
- Under certain recording conditions, such as when the subject is small or dark,  (AF Tracking) may not operate correctly.
- When  (AF Tracking) does not work, focus will be on  (23-area-focusing).
- Cannot set to  (AF Tracking) in the following cases.
 - [Creative Control] Mode ([Sepia], [Dynamic Monochrome], [High Dynamic], [Toy Effect], [Soft Focus])
 - [Panorama Shot] Mode
 - [B&W] and [SEPIA] in [Color Mode]
- When  (23-area-focusing) or  (Spot-focusing) is set, the [AF Mode] setting at the time of motion picture recording switches to  (1-area-focusing).

- For the setting procedures of the menu. (→54)

[Quick AF]

The focus is automatically adjusted when camera blurring is small even when the shutter button is not pressed. (Increases battery consumption)



■ Settings: [ON] / [OFF]

- Focus alignment may take time if zoom is suddenly changed from max. W to max. T, or if suddenly moving closer to subject.
- Press shutter button halfway if focus is difficult to align.
- The function will turn [OFF] in the following cases.
 - [Night Portrait], [Night Scenery], [Handheld Night Shot], [Starry Sky] and [High Speed Video] Scene Modes
- [Quick AF] will not work while AF Tracking is operating.

- For the setting procedures of the menu. (→54)

[Face Recog.]

For details (→108).



[Metering Mode]

You can change the position for measuring brightness when correcting exposure.



■ Settings

| [Metering Mode] | Brightness measurement position | Conditions |
|--|-----------------------------------|---|
| <input checked="" type="checkbox"/> [Multi Metering] | Whole screen | Normal usage (produces balanced pictures) |
| <input type="checkbox"/> [Center Weighted] | Center and surrounding area | Subject in center |
| <input type="checkbox"/> [Spot] | Center and close surrounding area | Great difference between brightness of subject and background (e.g. person in spotlight on stage, backlighting) |

[i.Exposure]

Automatically adjusts contrast and exposure to give more lifelike colors when there is significant contrast between background and subject.



■ Settings: [ON] / [OFF]

- When [i.Exposure] works, the color of **i** changes.
- Even if [Sensitivity] is set to [100], when [i.Exposure] is activated, pictures may be taken at a higher ISO Sensitivity than the setting.

- For the setting procedures of the menu. (→54)

[Min. Shtr Speed]



Sets the minimum value for the shutter speed. We recommend using slower shutter speeds to take brighter pictures in dark locations.

■ **Settings:** [AUTO] [1/250] [1/125] [1/60] [1/30] [1/15] [1/8] [1/4] [1/2]*1 [1]*1

*1 If the ISO Sensitivity setting is [3200] or [H.6400]*2, the shutter speed becomes [1/4].

*2 Only when [Extended ISO] is [ON]. (→117)

- Slower shutter speeds allow for brighter pictures but increase risk of jitter, so we recommend using a tripod and the self-timer.
- As still pictures may become dark when using faster values such as [1/250], we recommend that still pictures are taken in bright locations (MIN flashes red when shutter button is pressed halfway if still picture will be dark).
- MIN displayed on screen for settings other than [AUTO].

[i.Resolution]



You can use the camera's Intelligent Resolution technology to record still pictures with sharper outlines and clearer resolution. Also, when [i.ZOOM] is set, the zoom ratio can be increased two times higher than the original zoom ratio with limited deterioration of picture quality.

■ **Settings:** [ON] / [i.ZOOM] / [OFF]

- About [i.ZOOM] (→73)

[Digital Zoom]



Zoom 4 times further than Optical/Extended optical zoom. Note that enlarging will decrease picture quality with Digital Zoom.
For details (→73).

■ **Settings:** [ON] / [OFF]

- For the setting procedures of the menu. (→54)

[Burst]

For details (→106).

**[Color Mode]**

Set color effects.

- **Settings:** [STANDARD] / [VIVID]*1 (sharper) / [Happy]*2 / [B&W] / [SEPIA]

*1 Except [Intelligent Auto] Mode

*2 [Intelligent Auto] Mode only

**[AF Assist Lamp]**

Illuminates lamp when dark to facilitate focus alignment.

- **Settings**

[ON] : Lamp illuminated with halfway press of shutter button
(AF* appears)

[OFF] : Lamp off (taking pictures of animals in the dark, etc.)

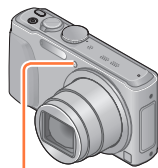

AF Assist Lamp

- The AF Assist Lamp has an effective distance of 1.5 m (4.9 feet).
- Do not block the lamp with your fingers or look at it from close range.
- The setting is fixed to [OFF] in the following Scene Modes:
[Scenery], [Night Scenery], [Handheld Night Shot], [Sunset], [Glass Through],
[Underwater], [High Speed Video]



- For the setting procedures of the menu. (→54)

[Red-Eye Removal]

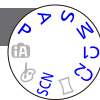
Automatically detects red-eye and corrects still picture data when recording with flash red-eye reduction (⚡A[Ⓞ] ⚡S[Ⓞ]).



■ Settings: [ON] / [OFF]

- This setting will work only when [AF Mode] is  (Face Detection).
- Depending on the circumstance, it may not be possible to correct red-eye.
- When this function is set to [ON], the flash icon changes to / .
- The setting is set to [OFF] except in the following Scene Modes: [Portrait], [Soft Skin], [Night Portrait], [Baby]

[Motion Deblur]

For details (→36).



[iHandheld Nite Shot]

For details (→36).



[iHDR]

For details (→37).



- For the setting procedures of the menu. (→54)

[Stabilizer]

Automatically detects and prevents jitter.



■ Settings: [ON] / [OFF]

- The setting is fixed to [ON] in [Handheld Night Shot] Scene Mode.
- The setting is fixed to [OFF] in the following Scene Modes: [Starry Sky], [High Speed Video], [3D Photo Mode]
- Cases where the stabilizer function may be ineffective: Heavy jitter, high zoom ratio (also in the Digital Zoom range), fast-moving objects, indoors or in dark locations (due to low shutter speed)

DMC-ZS30

- The 5-axis Hybrid Image Stabilizer function automatically functions while recording motion pictures. This decreases the jitter of the image when recording motion pictures while zooming or walking, etc.
 - The recording range may become narrower.
 - If you record an [MP4] motion picture with the [Rec Quality] set to [VGA/30p], the stabilizer function may be weaker compared to other picture quality settings.

[Date Stamp]

Still pictures can be taken with the recording date and time stamped on the still picture.



■ Settings: [W/O TIME] / [WITH TIME] / [OFF]

- Date stamps on still pictures cannot be erased.
- The date cannot be stamped when [Auto Bracket] or [Burst] is set, when recording a motion picture, or when the [High Speed Video] or [3D Photo Mode] Scene Modes are set.
- Do not request date printing in store or make date printing on printer for still pictures with date stamps. (Date printing may be overlapped.)
- Cannot change the setting in [Intelligent Auto] Mode. The setting in other Recording Mode is applied.

[Clock Set]

Set the clock. Same function as that in [Setup] menu. (→26)



Using the [Motion Picture] menu

You can select the recording mode and picture quality and other settings.

- For the setting procedures of the menu. (→54)

[Rec Format]

Sets the data format of the motion picture that is recorded.



■ Settings

| | |
|---------|---|
| [AVCHD] | This is a data format suitable for playback on high-definition TVs. |
| [MP4] | This data format is suited for playing back motion pictures on a computer and other such devices. |

- For details (→42)

[Rec Quality]

Sets the picture quality of the motion picture that is recorded.



■ Settings

[AVCHD] in [Rec Format]

* AVCHD Progressive

| Item | Picture size | fps | Bit rate |
|-----------------------|--------------|-----|-----------------|
| [FHD/60p]/ G * | 1920×1080 | 60p | Approx. 28 Mbps |
| [FHD/60p]* | | | |
| [FHD/60i]/ G | 1920×1080 | 60i | Approx. 17 Mbps |
| [FHD/60i] | | | |
| [HD/60p]/ G | 1280×720 | 60p | Approx. 17 Mbps |
| [HD/60p] | | | |

- Select picture quality settings with the [**G**] to record location information and place name information. **DMC-ZS30**

[MP4] in [Rec Format]

| Item | Picture size | fps | Bit rate |
|-----------|--------------|-----|-----------------|
| [FHD/30p] | 1920×1080 | 30p | Approx. 20 Mbps |
| [HD/30p] | 1280×720 | 30p | Approx. 10 Mbps |
| [VGA/30p] | 640×480 | 30p | Approx. 4 Mbps |

■ About motion picture icon

[Rec Format] — **AVCHD **G**** — Location information/Place name log **DMC-ZS30**
 Picture size — **FHD/60p** — fps

- What is bit rate

This is the volume of data for a definite period of time, and the quality becomes higher when the number gets bigger. This unit is using the “VBR” recording method. “VBR” is an abbreviation of “Variable Bit Rate”, and the bit rate (volume of data for definite period of time) is changed automatically depending on the subject to record. Therefore, the recording time is shortened when a subject with fast movement is recorded.

- For the setting procedures of the menu. (→54)

[Still Picture Size]

Set [Still Picture Size] for when you take still pictures while recording motion pictures.



- Settings: [13.5M] / [6M] / [2M]

- The aspect ratio becomes [16:9].

[Continuous AF]

Either allow the focus to be constantly adjusted during motion picture recording, or fix the focus position at the start of recording.



- Settings

[ON]

[OFF]: Fix focus position at the start of motion picture recording.

- The setting is fixed to [OFF] in the following case:
 - [Starry Sky] Scene Mode

- For the setting procedures of the menu. (→54)

Level Shot function **DMC-ZS30**



Level Shot function automatically detects the camera's tilt while recording motion pictures, and horizontally corrects the recording motion picture so it will not be tilted.

■ Settings: [ON] / [OFF]

- If you record while walking, or if the camera's tilt is large, it may not be possible to horizontally correct the motion pictures.
- When [Level Shot] is [ON], the recording range will become a little narrower when starting to record motion pictures.
- Still pictures taken while recording motion pictures will not be horizontally corrected.
- The setting is fixed to [OFF] in the following case:
 - [High Speed Video] Scene Mode

[Wind Cut]



Automatically detects wind sounds (wind noise) captured by the microphones and suppresses the sound if the wind is blowing too strongly.

■ Settings: [AUTO] / [OFF]

- When [Wind Cut] is set to [AUTO], the sound quality may differ from that of normal recordings.

Changing the picture information display, etc.

You can disable the display of picture information (file number, etc.) and recording information (settings used for recording, etc.) when a picture is played back.

1 Press [DISP.] button to change display

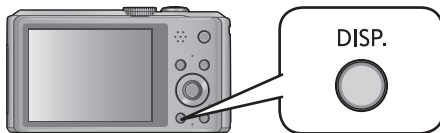

Has picture information
(recording date and time, etc.)

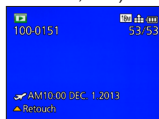

Has recording information
([Flash], [Sensitivity] etc.)

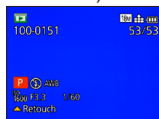

Has location/
direction information*

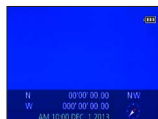

No display



* **DMC-ZS30**

- During Playback Zoom, Motion Picture Playback, Slide Show: You can only turn the display on or off.
- During Multi Playback or calendar screen: Display cannot be changed.

Playing back still pictures recorded using the burst function

Pictures taken with the or setting are recorded together as a group (picture group).

■ Representative picture display

A representative picture (first burst picture) is displayed when it is displayed together with other still pictures or with motion pictures.

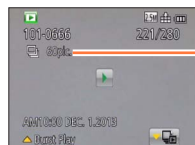

- All the still pictures in a picture group can be deleted or edited together.
- Continuous playback can be performed using the same operations as for motion pictures. (→49)

Number of burst pictures

■ Display within each picture group ()

Still pictures recorded by a single burst can be displayed separately or as a list.

1 Touch while the representative first burst picture is being displayed

The display within each picture group appears on the screen.



- You can also display still pictures within each picture group using .

On the display within each picture group, only the series of burst still pictures are displayed.

- To return to the representative screen display
→ Touch (or press .

■ Re-acquiring the picture group information

When the camera is turned on, the (acquiring information icon) may appear. While is displayed, pictures cannot be deleted and the [Playback] menu cannot be used. Only [All] or [Calendar] is available as the [Playback Mode].

Playing back still pictures recorded using the burst function

- Burst pictures cannot be displayed as a picture group during [GPS Area Play] **DMC-ZS30** or [Favorite] playback with [Slide Show] or [Filtering Play].
- The following operation cannot be performed while a representative first burst picture is being displayed.
 - [Auto Retouch] • [Creative Retouch]
 - [Cropping] of [Playback] menu
- Burst pictures recorded after the total number of still pictures has exceeded 50,000 will not be grouped.
If only one still picture is left over in a picture group after deletion or other operations, it will not be formed into a group, either.
- The burst pictures recorded by another device may not be recognized as picture group pictures.
- Burst pictures will not be grouped if recorded without setting the clock.

Different playback methods [Playback Mode]

Recorded pictures can be played back in a variety of ways.
To change the Playback Mode, refer to and perform the following steps.

1 Press [MENU/SET] in playback mode

The menu selection screen is displayed.

2 Use cursor button to select [Playback Mode] menu and press [MENU/SET]

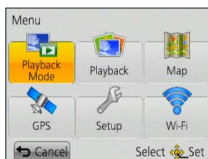

• The menu type can also be selected by touch operations.

3 Press ▲ ▼ to select the Playback Mode and press [MENU/SET]

| | |
|------------------|--|
| [2D/3D Settings] | Switches the output format between 2D and 3D pictures. (Only available during HDMI output.) (→257) |
| [All] | Plays back all pictures. (→45) |
| [Slide Show] | Automatically plays back recorded pictures, one after another. (→138) |
| [Filtering Play] | Plays back the pictures after narrowing them down according to various conditions. (→133) |
| [Calendar] | Displays the pictures according to the date on which they were taken. (→140) |

- If the pictures displayed with [Slide Show] or [Filtering Play] are narrowed down, selecting [All] will cancel the filtering.
- The playback method automatically becomes [All] when the camera is turned on, or when switching from [Rec] mode to [Playback Mode].

[2D/3D Settings]

- For switching [Playback Mode] (above)

The playback method for the 3D pictures can be switched. This menu is only displayed during HDMI output. For the procedure for playing back a 3D still picture (→257).

Selecting pictures to play back [Filtering Play]

You can narrow down the pictures to be displayed with set filters, such as recording dates, categories, or favorite pictures.

- 1 Select **[Filtering Play]** from the **[Playback Mode]** menu (→132)
- 2 Select the filtering method using cursor button, and press **[MENU/SET]**

| | |
|-----------------------------|--|
| [Picture Only] | Play back still pictures (→134) |
| [Video Only] | Play back motion pictures (→134) |
| [3D Play] | Play back only 3D still pictures. (→134) |
| [GPS Area Play]* | Select the location name of the place where the pictures were taken or the landmark name, and play the pictures back. (→134) |
| [Map]* | Select the place where the pictures were taken on the map, and play the pictures back. (→135) |
| [Travel] | Play back pictures with [Travel Date] that have been set at the time of their recording. (→136) |
| [Category Selection] | Play back pictures that have been narrowed down by category, such as Scene Mode. (→136) |
| [Select Date] | Select the date when the pictures were taken, and play the pictures back. (→137) |
| [Favorite] | Play back pictures set as [Favorite]. (→137) |

* **DMC-ZS30**

■ About operations during [Filtering Play]

During [Filtering Play], the operation when ▲ is pressed in the 1-picture Playback screen is different. Select the operation you want to perform and press [MENU/SET].

- [Retouch]: Retouching pictures (→141)
- [Burst Play]: Play back continuously recorded still pictures, one after another (→130)
- [Play Video]: Play back motion pictures (→49)
- [Play Panorama]: Play back panorama pictures (→94)
- [Filtering Off]: Switch Playback Mode to [All] (→132)
- [Change Date]: Change recording date to display (→137)

■ Cancel filtering

During [Filtering Play], only pictures under the set filters are displayed. In the following cases, filtering will be canceled.

- When the camera is turned off
- When switching to Recording Mode
- When [All] is selected from the [Playback Mode] menu
- When ▲ is pressed in the 1-picture Playback screen and [Filtering Off] is selected.

Narrowing down by selecting picture type

Select picture type, such as still pictures only or motion pictures only, then play them back.

1 Select **[Picture Only]** / **[Video Only]** / **[3D Play]** in **[Filtering Play]** and press **[MENU/SET]** (→133)

| | |
|-----------------------|---|
| [Picture Only] | Play back still pictures (Also applies to panorama pictures and continuously recorded pictures) |
| [Video Only] | Play back AVCHD motion pictures, MP4 motion pictures, and high-speed motion pictures |
| [3D Play] | Plays back 3D still pictures recorded using [3D Photo Mode] Scene Mode |

Narrowing down by selecting place name or landmark name of the location where the pictures were taken DMC-ZS30

Select place name or landmark name from pictures which have recorded place name information, then play back the pictures.

1 Select **[GPS Area Play]** in **[Filtering Play]** and press **[MENU/SET]** (→133)

2 Use cursor button to select region and press **[MENU/SET]**

3 Use cursor button to select place name or landmark and press **[MENU/SET]**

- Place name information (place name and landmark name) may be different from the official names in some cases.
- The place name information may be different from the recorded location depending on the status of positioning.

Narrowing down by selecting the location where the pictures were taken **DMC-ZS30**

Specify place on the map, then select from pictures with nearby location information recorded and play back.

Preparation:

To use a detailed map to specify a place, copy the map data recorded on the disc (supplied) to your card in advance. (→180)

1 Select [Map] in [Filtering Play] and press [MENU/SET] (→133)**2** Operate map display so the recording location is in the selection

Selection

Map scale level

On the touch screen, spread (pinch out) your 2 fingers to zoom in, and pinch (pinch in) your 2 fingers to zoom out.

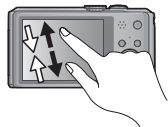

- You can also zoom in/out with the zoom lever.

- You can drag the screen or press the cursor button to operate the display location of a map.

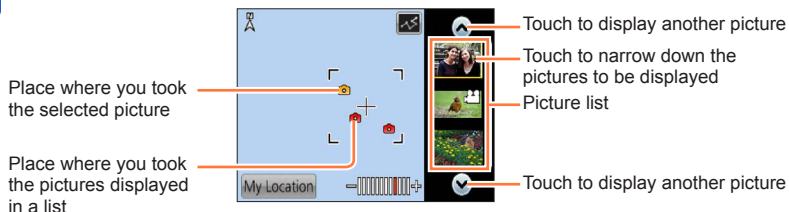
3 Press [DISP.] button

Place where you took the selected picture

Place where you took the pictures displayed in a list

Touch to display another picture

Touch to narrow down the pictures to be displayed

Picture list

Touch to display another picture

4 Press [MENU/SET]

- When the map is at its maximum size, you cannot narrow down pictures.
- The place where the picture was taken and recorded location information may differ, depending on the status of positioning.

Narrowing down by selecting pictures recorded at a destination

Play back pictures with [Travel Date] (→112) that have been set at the time of their recording.



- 1** Select [Travel] in [Filtering Play] and press [MENU/SET] (→133)
- 2** Use cursor button to select the setting and press [MENU/SET]

| | |
|---------------|--|
| [All] | Display all pictures that were recorded while [Travel Date] was set |
| [Travel Date] | Display only the pictures recorded on the selected travel date ① Use cursor button to select travel date and press [MENU/SET] |
| [Location] | Display only the pictures recorded at the selected travel destination ① Use cursor button to select travel destination and press [MENU/SET] |

Narrowing down by selecting picture category or a person in the picture

Play back pictures that have been narrowed down by category, such as Scene Mode. Also, from among the pictures recorded using the Face Recognition function (→108), select a person in the picture and play back.

- 1** Select [Category Selection] in [Filtering Play] and press [MENU/SET] (→133)
- 2** Use cursor button to select the setting and press [MENU/SET]

| | |
|----------------------|--|
| [Face Recog.] | Select a person registered to Face Recognition and display the pictures ① Use cursor button to select a person and press [MENU/SET] |
| [Portrait etc.] | Only display pictures recorded with [Portrait], [Soft Skin], [Night Portrait], [Baby] from Scene Mode* |
| [Scenery etc.] | Only display pictures recorded with Panorama Mode, and [Scenery], [Sunset], [Glass Through] from Scene Mode* |
| [Night Scenery etc.] | Only display pictures recorded with [Night Portrait], [Night Scenery], [Handheld Night Shot], [Starry Sky] from Scene Mode* |
| [Events] | Only display pictures recorded with [Sports] from Scene Mode |
| [Baby] | Only display pictures recorded with [Baby] from Scene Mode* |
| [Pet] | Only display pictures recorded with [Pet] from Scene Mode |
| [Food] | Only display pictures recorded with [Food] from Scene Mode |
| [Underwater] | Only display pictures recorded with [Underwater] from Scene Mode |
| [Burst] | Only display pictures recorded with  ,  in Burst |

* Even if the scene is auto-detected with [Intelligent Auto] Mode, it will be categorized in the same way.

Selecting pictures to play back [Filtering Play]

Narrowing down by selecting recording date

Select the recorded date, and play the pictures back.

1 Select [Select Date] in [Filtering Play] and press [MENU/SET]
(→133)

2 Use cursor button to select recording date and press [MENU/SET]

■ To change the date to display

- ① Press ▲ in the 1-picture Playback screen
- ② Use cursor button to select [Change Date] and press [MENU/SET]

- Only months when pictures were taken are shown on the calendar screen. If the clock was not set, pictures will be displayed as January 1st, 2013.
- Pictures taken with destination settings made in [World Time] are displayed in the calendar screen using the appropriate date for the destination's time zone.

Narrowing down by selecting favorite pictures

Select pictures that were set in [Favorite] from the [Playback] menu, and play the pictures back.

1 Select [Favorite] in [Filtering Play] and press [MENU/SET] (→133)

Playing back pictures in order automatically

[Slide Show]

Automatically play pictures in order and to music. Recommended when viewing on TV screen.

1 Select [Slide Show] from the [Playback Mode] menu (→132)

2 Use cursor button to select [Start] and press [MENU/SET]

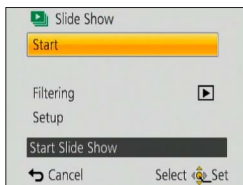

■ To select pictures for automatic play back

If you have previously selected the pictures to display for [Filtering Play] from the [Playback Mode] menu, the Slide Show will play back with the same criteria.

If you want to reselect pictures to play back, use cursor button to select [Filtering], then press [MENU/SET].

- For details on how to narrow down (→133)
- The filtering will not be canceled, even after the Slide Show finishes.
- If you select [All], the filtering will be canceled.

■ To change settings such as music or display time

Use cursor button to select [Setup] and press [MENU/SET]

| | |
|-------------|--|
| [Effect] | [NATURAL] / [SLOW] / [SWING] / [URBAN] / [OFF]* |
| [Duration]* | [1SEC] / [2SEC] / [3SEC] / [5SEC] |
| [Repeat] | [ON] / [OFF] |
| [Sound] | [OFF]: Music and audio will not play back. [AUTO]: With still pictures, music will play back, and with motion pictures, audio will play back. [Music]: Music effect will play back. [Audio]: Audio is played back from motion pictures. |

- * In the following case, [Effect] is fixed to [OFF]. The [Duration] setting is also disabled.
- [Motion Pic. Only]

■ Operations during Slide Show

The operation guide appears on the bottom right of the LCD monitor.

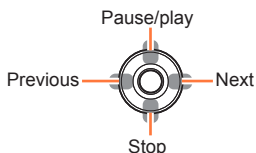

- If you do not perform any operation for approx. 2 seconds, the operation guide is turned off. To display the guide again, press the [DISP.] button.

- When [URBAN] has been selected, the picture may appear in black and white as a screen effect.
- When panorama pictures are played back, the [Duration] setting is disabled.
- Part of [Effect] cannot be used when displaying pictures on television using an HDMI micro cable (optional) or when displaying pictures recorded in portrait position.
- Screen effects do not operate during a [3D Play] slide show.
- Music effects cannot be added.

Searching by recording date [Calendar]

You can search for pictures by the date they were recorded.

1 Select [Calendar] from the [Playback Mode] menu (→132)

2 Touch the recording date to be displayed

Select the month

- Only months when pictures were taken are shown on the calendar screen.

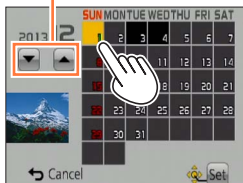

3 Touch [Set] to display a list of pictures from the selected date

4 Use cursor button to select picture and press [MENU/SET]



- If there is more than one picture recorded on the same date, the first picture taken on that date will be selected.
- You can display the calendar between January 2000 to December 2099.
- Pictures recorded without configuring [Clock Set] will show the date January 1st, 2013.
- Pictures taken with destination settings made in [World Time] are displayed in the calendar screen using the appropriate date for the destination's time zone.

Retouching pictures

[Auto Retouch]

You can adjust the color and brightness of a still picture to bring them into balance.

- New pictures are created after editing pictures with [Auto Retouch]. Before starting to edit, make sure that there is enough free space in the built-in memory or memory card.



• Example picture

1 Select a still picture to retouch during playback and press **▲**

2 Use cursor button to select [Auto Retouch] and press [MENU/SET]

3 Use cursor button to select [ON] and press [MENU/SET]

- A confirmation screen is displayed. If you select [Yes], the new retouched still picture is saved.
- When [OFF] is selected, you can restore a picture to its original condition (before retouching).

■ Operation from the [Playback] menu

- ① Select [Retouch] in the [Playback] menu, and then press [MENU/SET]
- ② Use cursor button to select [Auto Retouch] and press [MENU/SET]
- ③ Use cursor button to select picture and press [MENU/SET]
Read Step **3** above to perform further steps.

- The retouch effect may be less apparent in some still pictures.
- Some still pictures may have higher noise levels after retouching.
- It may not be possible to use [Auto Retouch] with still pictures that have already been retouched.
- It may not be possible to retouch still pictures recorded with other cameras.
- You cannot retouch the pictures in a picture group as a group. Retouch each picture in a picture group after displaying it.
- [Auto Retouch] is unable to perform in the following cases:
 - Motion pictures
 - Panorama pictures
 - 3D still pictures

[Creative Retouch]

You can retouch recorded still pictures by selecting the effect that you want to apply.

- New pictures are created after editing pictures with [Creative Retouch]. Before starting to edit, make sure that there is enough free space in the built-in memory or memory card.

1 Select a still picture to retouch during playback and press **▲**

2 Use cursor button to select [Creative Retouch] and press [MENU/SET]

3 Press **▲ ▼** to select effect

- The picture retouched with the selected effect is displayed.
- When [OFF] is selected, you can restore a picture to its original condition (before retouching).

| Setting | Effect |
|----------------------|--|
| [Expressive] | This picture effect creates a pop art style picture that enhances the color. |
| [Retro] | This picture effect creates the soft appearance of a tarnished picture. |
| [High Key] | This picture effect creates a brighter and lighter toned appearance for the entire picture. |
| [Low Key] | This picture effect creates a darker somber appearance for the entire picture to emphasize the bright portions. |
| [Sepia] | This picture effect creates a picture with sepia tone. |
| [Dynamic Monochrome] | This picture effect creates a monochromatic picture with a higher contrast and more dramatic atmosphere. |
| [Impressive Art] | A picture effect with strong contrast that illustrates a surreal and dramatic atmosphere. |
| [High Dynamic] | This picture effect creates a picture with a well-balanced brightness for the entire picture (from dark areas to bright areas). |
| [Cross Process] | This picture effect creates a unique atmosphere with surprising colors. • Use cursor button to adjust coloring, then press [MENU/SET]. |
| [Toy Effect] | This picture effect creates a picture that resembles pictures taken by a toy camera with a reduced amount of peripheral light. • Use cursor button to adjust coloring, then press [MENU/SET]. |

(Continued on the next page)

| Setting | Effect |
|--------------------|--|
| [Miniature Effect] | This effect blurs peripheral areas to give the impression of a diorama. |
| [Soft Focus] | This picture effect creates a soft appearance by intentionally blurring the entire picture. |
| [Star Filter] | This picture effect creates a picture with the light from the light source that shines in the shape of a cross, creating a gorgeous atmosphere. |
| [One Point Color] | This picture effect creates a monochromatic picture by retaining the color you selected only, and adds memorable emphasis to it. <ul style="list-style-type: none"> • Use cursor button to move the frame in the center of the screen, select the color to retain, and then press [MENU/SET]. |

- For more information about picture effects (→86 - 91)
- When you press [DISP.] button, a description of the selected effect is displayed.

4 Press [MENU/SET]

- A confirmation screen is displayed. If you select [Yes], the new retouched still picture is saved.

■ Operation from the [Playback] menu

- ① Select [Retouch] in the [Playback] menu, and then press [MENU/SET]
 - ② Use cursor button to select [Creative Retouch] and press [MENU/SET]
 - ③ Use cursor button to select picture and press [MENU/SET]
- Read Step 3 (→142) to perform further steps.

- The retouch effect may be less apparent in some still pictures.
- The image effect may appear weak compared to the effect given by the [Creative Control] Mode.
- It may not be possible to retouch still pictures recorded with other cameras.
- You cannot retouch the pictures in a picture group as a group. Retouch each picture in a picture group after displaying it.
- [Creative Retouch] is unable to be performed in the following cases:
 - Motion pictures
 - Panorama pictures
 - 3D still pictures

Using the [Playback] menu

You can specify picture protection, resizing, print settings, and other settings for pictures you have taken.

- For the setting procedures of the menu. (→54)
- The setting methods vary depending on the menu item.

- In the following cases, new pictures are created after they have been edited. Before starting to edit, make sure that there is enough free space in the built-in memory or memory card.
 - [Text Stamp]
 - [Retouch]
 - [Resize]
 - [Cropping]
- It may not be possible to set or edit pictures taken with other cameras.

[Location Logging]

You can send location information (latitude and longitude) obtained with your smartphone/tablet to this unit, and write the location information to the pictures.

- Location information cannot be written to still pictures in the built-in memory. If you want to record location information on them, copy the pictures in the built-in memory to a memory card, then perform [Location Logging].

Preparation:

Send location information to this unit from your smartphone/tablet (→201)

1 Use cursor button to select [Add Location Data] and press [MENU/SET]

2 Use cursor button to select a period for writing location information, and then press [MENU/SET]

- Confirmation screen is displayed. If you select [Yes], the operation is executed.
- Location information is written to the picture.
- [GPS] is displayed for pictures that have location information written to it.

■ Abort writing location information

Press [MENU/SET] while location information is being written

- [○] is displayed for the period of the abort operation.

If selected again while [○] is displayed, writing location information will resume where it left off.

■ Delete received location information

① Use cursor button to select [Delete Location Data] and press [MENU/SET]

② Use cursor button to select a period for deleting location information, and then press [MENU/SET]

- Confirmation screen is displayed. If you select [Yes], the operation is executed.

- You can only write location information to pictures recorded with this unit.
- For pictures that already have location information recorded, due to the GPS function, etc., they will not be overwritten with location information obtained from your smartphone/tablet.
- Location information will not be written to pictures that were recorded after you selected [Send location data] (→201).
- Location information will not be written to AVCHD motion pictures.
- Location information may not be written if there is not enough free space on your card.
- If the card is locked, you cannot write location information to pictures or delete received location information.

- For the setting procedures of the menu. (→54)

[Title Edit]

You can give titles, etc. to your favorite still pictures.

1 Use cursor button to select [SINGLE] or [MULTI], and then press [MENU/SET]

2 Select a still picture

- [SINGLE]

Use cursor button to select a still picture and press [MENU/SET]



- [MULTI]

(up to 100 pictures with the same text)

Use cursor button to select a still picture and press [DISP.] button

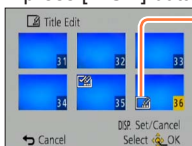

[Title Edit] setting

[Title Edit] already set

- To cancel
→ Press [DISP.] button again.
- To execute
→ Press [MENU/SET].

3 Enter characters (Entering text (→114))

- To delete a title, delete all the characters in the character input screen.

- Cannot be used in the following cases:

- Motion pictures (also applies to high-speed motion pictures)
- 3D still pictures

- To print text, use [Text Stamp] or "PHOTOfunSTUDIO" on the supplied disc.

[Edit GPS Data] **DMC-ZS30**

- For details (→166).

- For the setting procedures of the menu. (→54)

[Text Stamp]

Stamps the recorded pictures with recording date and time, place name information, names, travel destination, [Travel Date], recording direction etc. **DMC-ZS30**

The recording date and time, the text registered by [Baby] or [Pet] Scene Mode, [Travel Date] and [Title Edit] are stamped on the still picture. **DMC-ZS27**

1 Use cursor button to select [SINGLE] or [MULTI], and then press [MENU/SET]

2 Select a still picture

● [SINGLE]

Use cursor button to select a still picture and press [MENU/SET]



● [MULTI] (up to 100 pictures)

Use cursor button to select a still picture and press [DISP.] button

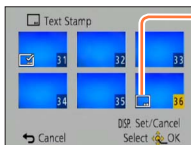

□ [Text Stamp] setting

- To cancel
→ Press [DISP.] button again.
- To execute
→ Press [MENU/SET].

3 Use cursor button to select [Set] and press [MENU/SET]

4 Use cursor button to select items and press [MENU/SET] (→148)



5 Use cursor button to select settings and press [MENU/SET] (→148)

6 Press [⏏/↵] button

7 Use cursor button to select [OK] and press [MENU/SET]

- Confirmation screen is displayed. If you select [Yes], the operation is executed.

■ Items that can be stamped

| | |
|-----------------------|---|
| [Shooting Date] | [W/O TIME]: Stamp recording date [WITH TIME]: Stamp recording date and time |
| [Name] |  : Stamp name registered in Face Recognition  : Stamp name registered in [Baby] or [Pet] |
| [Location] | Stamp location registered in [Setup] menu's [Travel Date] |
| [Travel Date] | Stamp Travel Date set in [Setup] menu's [Travel Date] |
| [Title] | Stamp text registered in [Title Edit] |
| [Country/Region]* | Stamp place name information recorded by GPS function • If text such as the location name or landmark name is long, it may not be possible to stamp all the text. |
| [State/Prov./County]* | |
| [County/Township]* | |
| [City/Town/Village]* | |
| [Landmark]* | |
| [Longitude/Latitude]* | Stamp location information recorded by GPS function |
| [Direction]* | Stamp direction of camera when recording |

* **DMC-ZS30**

- Items set to [OFF] are not stamped.

● Cannot stamp texts on the following pictures.

- Motion pictures
- 3D still pictures
- Panorama pictures
- Still pictures that date or other texts had already been stamped
- Still pictures taken without setting clock
- Characters may be cut off on certain printers.
- Text is difficult to read when stamped on pictures of 0.3M or less.
- **Do not request date printing in store or make date printing on printer for still pictures with date stamps. (Date printing may be overlapping.)**

- For the setting procedures of the menu. (→54)

[Retouch]

[Auto Retouch]: For details (→141)

[Creative Retouch]: For details (→142)

[Video Divide]

A single motion picture can be split into 2 parts. This is convenient when you want to keep just the necessary scenes, or if you wish to delete unnecessary scenes to increase free space on your card, such as when traveling.

1 Select the motion picture to split with cursor button and then press [MENU/SET]

2 Touch [▶/||] and pause at the place to split

- You can also press ▲ to pause.

3 Touch 



- A confirmation screen is displayed. Select [Yes] with cursor button and then press [MENU/SET].
- **The original motion picture that was split does not remain.**
(There will only be the 2 motion pictures that were created after the split.)
- You can also press ▼ to split a motion picture.

- During splitting, do not turn off the camera or remove the card or battery. If you do so, the motion picture may be deleted.
- Splitting a motion picture recorded in [MP4] or [High Speed Video] changes the order of the pictures. It is recommended to display with [Calendar] (Calendar Playback) or [Filtering Play].
- It may not be possible to split motion pictures that were recorded with a different camera.
- Motion pictures with a short recording time cannot be divided.

- For the setting procedures of the menu. (→54)

[Resize]

Picture size can be reduced to facilitate e-mail attachment and use in web pages, etc. (Still pictures recorded at the smallest recording pixel level cannot be further reduced.)

■[SINGLE]

- 1 Use cursor button to select [SINGLE] and press [MENU/SET]**
- 2 Use cursor button to select a still picture and press [MENU/SET]**
- 3 Use cursor button to select size and press [MENU/SET]**

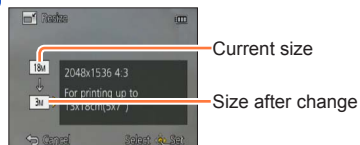

- Confirmation screen is displayed. If you select [Yes], the operation is executed.

(Continued on the next page)

■ [MULTI]

1 Use cursor button to select [MULTI] and press [MENU/SET]

2 Use cursor button to select size and press [MENU/SET]

3 Use cursor button to select a still picture and press [DISP.] button (up to 100 pictures)

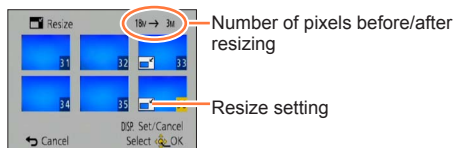

- To cancel
→ Press [DISP.] button again.
- To execute
→ Press [MENU/SET].

- Confirmation screen is displayed. If you select [Yes], the operation is executed.

● Picture quality is reduced after resizing.

● Cannot resize the following pictures.

- Motion pictures
- 3D still pictures
- Panorama pictures
- Still pictures that date or other texts had already been stamped

- For the setting procedures of the menu. (→54)

[Cropping]

Enlarge your still pictures and crop unwanted areas.

1 Use cursor button to select a still picture, and then press [MENU/SET]

2 Select area to crop and press [MENU/SET]



Expand



Change position

- Confirmation screen is displayed. If you select [Yes], the operation is executed.

- Picture quality is reduced after cropping.
- Cannot crop the following pictures.
 - Motion pictures
 - 3D still pictures
 - Panorama pictures
 - Still pictures that date or other texts had already been stamped
- Original Face Recognition information will not be copied when still pictures are cropped.

- For the setting procedures of the menu. (→54)

[Favorite]

By labeling your favorite pictures with a star (★), you can play back your favorite pictures only, or you can delete all pictures except your favorites.

1 Use cursor button to select [SINGLE] or [MULTI] and press [MENU/SET]

2 Use cursor button to select picture and press [MENU/SET]

● [SINGLE]



Favorite picture setting

● [MULTI]

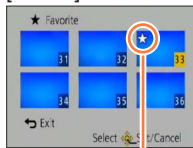

Favorite picture setting

- To cancel → Press [MENU/SET] again.

■ To clear all

Select [CANCEL] in step **1** and select [Yes].

- For the setting procedures of the menu. (→54)

[Print Set]

Picture/picture no./date printing settings can be made for when printing with DPOF print-compatible shops or printers. (Ask at the shop to check for compatibility.)

For more information visit:

http://panasonic.jp/dc/dpof_110/white_e.htm

1 Use cursor button to select [SINGLE] or [MULTI] and press [MENU/SET]

2 Use cursor button to select picture and press [MENU/SET]

3 Use cursor button to set number of pictures and press [MENU/SET]

(repeat steps **2** and **3** when using [MULTI] (up to 999 pictures))

● [SINGLE]

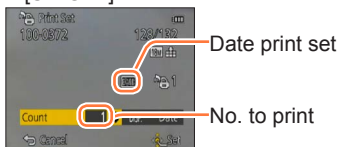

● [MULTI]

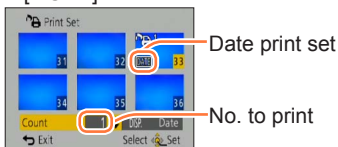

- Date print setting/release → Press [DISP.] button

■ To clear all

Select [CANCEL] in step **1** and select [Yes].

- Depending on the type of printer, the printer settings may take priority over camera settings.
- Cannot be set for files that are not compliant with the DCF standard.
- Some DPOF information set by other equipment cannot be used. In such cases, delete all of the DPOF information and then set it again with this camera.
- Date print setting cannot be made for still pictures that have been taken with [Date Stamp] and pictures with a [Text Stamp] applied.
- Print setting cannot be made for motion pictures.

- For the setting procedures of the menu. (→54)

[Protect]

Set protection to disable picture deletion. Prevents deletion of important pictures.

1 Use cursor button to select [SINGLE] or [MULTI] and press [MENU/SET]

2 Use cursor button to select picture and press [MENU/SET]

● [SINGLE]



Picture protected

● [MULTI]

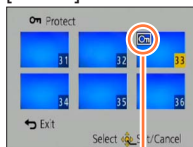

Picture protected

- To cancel → Press [MENU/SET] again.

■ To clear all

Select [CANCEL] in step **1** and select [Yes].

- May not be effective when using other devices.
- The picture is erased when formatting, even if it is protected.
- When you set the write-protect switch on the card to the "LOCK" position, the picture is not erased.

- For the setting procedures of the menu. (→54)

[Face Rec Edit]

Edit or delete the recognition information for pictures with mistaken Face Recognition.

- 1 Use cursor button to select [REPLACE] or [DELETE] and press [MENU/SET]**
- 2 Use cursor button to select the picture and press [MENU/SET]**
- 3 Use cursor button to select a person and press [MENU/SET]**
 - If [DELETE], go to step **5**.
 - People whose Face Recognition information has not been registered cannot be selected.
- 4 Use cursor button to select the person to replace for another and press [MENU/SET]**
- 5 Use cursor button to select [Yes] and press [MENU/SET]**

- When Face Recognition information is deleted, it cannot be restored.
- Pictures for which all Face Recognition information has been deleted are not categorized in Face Recognition during [Category Selection].
- Recognition information cannot be edited in protected pictures.

- For the setting procedures of the menu. (→54)

[Copy]

You can copy pictures between built-in memory and memory card.

1 Use cursor button to select the copy method (direction) and press [MENU/SET]



: Copy all pictures from built-in memory to card (go to step 3).

: Copy 1 picture at a time from card to built-in memory.

2 Use cursor button to select picture and press [MENU/SET]

3 Use cursor button to select [Yes] and press [MENU/SET]

- To cancel → Press [MENU/SET].

- Copying pictures may take several minutes. Do not turn off the camera or perform other operations during copying.
- If identical names (folder/file numbers) are present in the copy destination, a new folder for copying will be created when copying from built-in memory to card (). Identically-named files will not be copied from card to built-in memory (.
- The following settings are not copied. Set them again after copying.
 - [Print Set] - [Protect] - [Favorite]
- Only pictures from Panasonic digital cameras (LUMIX) may be copied.
- Motion pictures recorded in [AVCHD] format cannot be set.

Using the GPS function to record the location of a picture

Before using the GPS function, read "About GPS" (→10) and "License Agreement for Place Name and Map Data" (→296).

GPS stands for Global Positioning System. You can check your current location using GPS satellites. The camera receives radio signals that contain orbital information and time information from multiple GPS satellites, and uses them to calculate its current position. Calculating a position in this manner is known as "positioning". The camera is also compatible with the satellite navigation system GLONASS operated by the Russian government.

This camera can record the location information of a place where a picture was taken on the pictures.

The camera can also automatically adjust the time or display a place where a picture was taken on a map during playback.

Precautions on properly receiving a GPS signal

- It is recommended to hold the camera steady with the built-in GPS antenna pointed at the open sky while updating the GPS.
- The camera cannot properly receive radio signals from the GPS satellites in the following places. As a result, the camera may not be able to execute positioning or a significant error in positioning may occur.
 - Inside buildings
 - Surrounded by trees, such as in a forest
 - Inside a moving train, vehicle, etc.
 - Near high-voltage electrical power lines
 - In building basements or underwater (when using the optional marine case)
 - Between tall buildings or in a valley
 - Inside tunnels
 - Near devices such as a 1.5 GHz band mobile phone lines

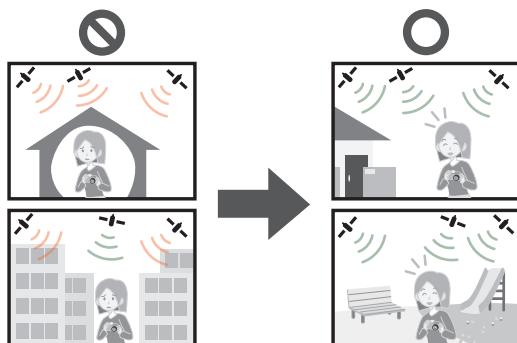

- Do not block the built-in GPS antenna with your hand or other objects.
- If you want to execute positioning while you carry the camera around, do not put it in a metallic bag or case. If the camera is enclosed in something metallic, it cannot execute positioning.

Using the GPS function to record the location of a picture

[GPS Setting]

When [GPS Setting] is [ON], the camera periodically receives radio signals from the GPS satellites and executes positioning. When positioning is executed successfully, the place name and position (latitude and longitude) information are recorded in still pictures and motion pictures (excluding certain picture quality settings (→161)).

- If you select automatic time adjustment using the GPS function when you set the clock of this camera for the first time, [GPS Setting] is set to [ON].

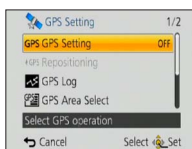
1 Select [GPS Setting] from GPS menu and press [MENU/SET]**2 Use cursor button to select [ON] and press [MENU/SET]**

- A message appears on the screen. After confirming the message, press [MENU/SET].

| [GPS Setting] | Description |
|---------------|--|
| [ON] | The camera periodically executes positioning. Even if the camera is turned off, positioning will be continued. (Positioning will stop after a certain period of time has elapsed.) |
| [OFF] | The GPS function is set to OFF. |
| [INFO] | You can check the current reception status. |

■ About operations during positioning

The GPS status indicator lights up while positioning is being executed and the GPS reception icon appears on the screen. (→160)

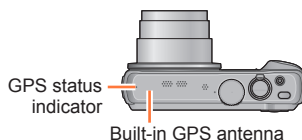

■ Displaying the status and result of positioning

The icons that indicate the status and result of positioning will appear on the LCD monitor. When positioning is successful, camera will search the place name information (name of place and landmark) inside its internal database and display it.

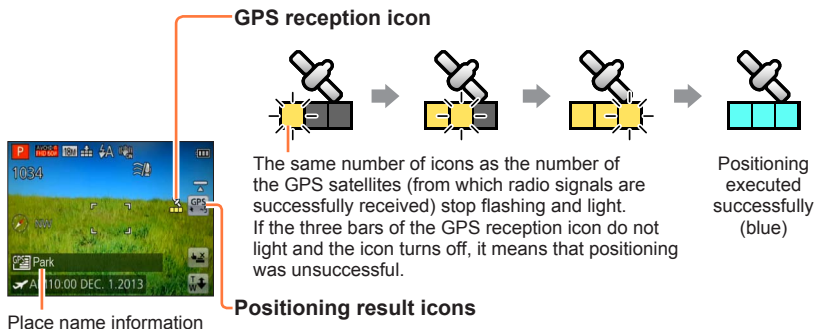

| Icon | Time elapsed after successful positioning |
|----------------|---|
| GPS ↕ ~5 | Less than 5 minutes |
| GPS ↕ ~60 | 5 minutes to 1 hour have elapsed. |
| GPS ↕ ~120 | 1 hour to 2 hours have elapsed. |
| GPS ↕ ~120~ | 2 hours or more have elapsed. |
| GPS ↕ | Positioning failed. No location information/place name information available. |

Even if GPS reception is good, it will take approx. 2 to 3 minutes to successfully execute positioning in the following cases:

- When positioning is executed for the first time
- When [GPS Setting] was set to [OFF]
- When [Airplane Mode] was set to [ON] and the camera was turned off (→164)
- When the battery was removed

Positioning can be executed faster when you download GPS assist data to the camera using the “GPS Assist Tool”. (→169)

■ Information to be recorded on the pictures

When the camera successfully executes positioning, it records the following information in still pictures and motion pictures*.

- Location information (latitude and longitude)
- Place name information (Country/region, province/state, city/borough/county, town/village, landmark)

* Only the information determined at the time when the recording was started is recorded.

Additionally, it will be recorded to AVCHD motion pictures that have motion picture quality settings without the **[G]** in the motion picture icon. (→126)

- GPS (with location information) and/or **[P]** (with place name information) is displayed during playback for pictures that are recorded with location or place name information.
- The location information and place name information are not recorded on pictures that are recorded when the positioning result icon **[P]** is displayed. (Since the pictures have no location information, you cannot perform [Edit GPS Data] (→166, 167))
- Only the location information will be recorded for pictures recorded immediately after positioning was executed successfully (until place name information appears). However, even if positioning failed during recording, location information may be recorded later once the position becomes available.
 - During playback, you can add the place name information to pictures recorded with only the location information.

■ Place name information

The most appropriate place name is displayed for place name information by searching for place names and landmarks from the database of this camera based on the latitude and longitude of positioning. (In some cases, the nearest place name or landmark may not be displayed.)

- If an appropriate place name or landmark is not found in the database of this camera, **[---**] will appear even if positioning is executed successfully. Even if **[---**] is displayed, in some cases you can select the place name information by using [GPS Area Select]. (→165)
- There are also cases where the landmarks you are looking for may not be registered in the camera database. Place name information such as landmarks is current as of October 2012. (Type of landmarks (→302))

- Place name information (place name and landmark name) may be different from the official names in some cases.

Using the GPS function to record the location of a picture

Executing the positioning function right away to update the current location

If the displayed place name is different from the current location or a previous location is displayed, update the positioning information.

If some time has elapsed since the last time positioning was executed successfully (GPS, GPS, GPS, or GR is displayed), we recommend updating the positioning information.

Before starting the procedure, move to a place where positioning can be performed successfully. (→158)

1 (Recording mode only)
Touch the GPS icon

2 **Touch [Repositioning]**

The GPS status indicator lights up and the positioning reception icon appears on the screen while positioning is executed. (→160)



■ Interval between positioning operations

Even if the positioning information is not updated, the camera automatically tries to execute positioning immediately after it is turned on and subsequently at regular intervals when [GPS Setting] is [ON].

Also, when [Airplane Mode] is set to [OFF], the camera automatically tries to execute positioning, even if the camera is turned off.

Note, however, that the positioning operation is interrupted in the following cases.

- When the battery power is low and  is displayed.
- When the battery charging is started.
- When the camera has not been turned on for a certain period of time.

■ Displaying the GPS reception status

- ① Select [GPS Setting] from the [GPS] menu: Perform steps **1** and **2** (→159)
- ② Use cursor button to select [INFO] and press [MENU/SET]
 - Press [MENU/SET] again to update the positioning information.

• Checking GPS reception status

: Time when positioning is executed

: Number of GPS satellites from which the camera has received signals

: Latitude
Longitude

Using the GPS function to record the location of a picture

[Area Info. Set]

You can change the recorded place name information items to be displayed on the screen.

- 1** Select **[Area Info. Set]** from **[GPS]** menu and press **[MENU/SET]**
- 2** Use cursor button to select an item to be changed and press **[MENU/SET]**



- 3** Use cursor button to set items that you want to display to **[ON]** and items that you do not want to display to **[OFF]** and press **[MENU/SET]**

[Airplane Mode]

When **[GPS Setting]** is **[ON]**, the GPS function remains activated even if the camera is turned off.

To disable the positioning function when the camera is turned off, set **[Airplane Mode]** to **[ON]**.

- 1** Select **[Airplane Mode]** from **[Setup]** menu and press **[MENU/SET]**
- 2** Use cursor button to select **[ON]** and press **[MENU/SET]**

- Electromagnetic waves from the camera can affect instruments and meters. In airplane cabins (during takeoff and landing) or in other restricted areas, set **[Airplane Mode]** to **[ON]**, and then turn off the camera.

Changing the place name information to be recorded

When there are other candidate locations as a result of positioning, you can change the location information to another place name or landmark in the neighborhood.

- When there is a choice for differing place name information, **GPS** appears in front of the place name information.
- You can also perform this operation by touching [GPS Area Select] after touching the GPS icon.

1 Select [GPS Area Select] from [GPS] menu and press [MENU/SET]

2 Use cursor button to select an item to be changed and press [MENU/SET]

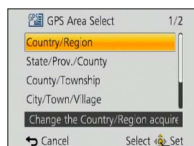

3 Use cursor button to select a place name or landmark from the displayed candidates and press [MENU/SET]

■ If you do not want to record a place name or landmark

When you select [Delete all place-names] in step **2** above, the place names and landmarks are not recorded.

You can also select the level of the place name and landmark information to be excluded in step **3** above. All place names and landmarks that are below the selected level will be deleted from the recording. (For example, if you delete [County/Township], the lower level [City/Town/Village] and [Landmark] data will not be recorded either.)

- Note, however, that the latitude and longitude data are recorded. If you do not want to record the latitude and longitude data, set [GPS Setting] to [OFF].
- To restore the place names and landmarks that you set not to be recorded, perform the [GPS Area Select] procedure again.

- A landmark may not be displayed at all or a different landmark may be displayed in places such as a large park. If the landmark that you want cannot be selected using [GPS Area Select], perform the [My Landmark] procedure (→182) before recording a picture or the [Edit Place Name] procedure after recording a picture. (→167)

Changing the recorded GPS information

[Edit Location]

You can edit the location information (latitude and longitude) recorded on still pictures and motion pictures.

- When you edit the location information, the place name information is deleted.

Preparation:

Before editing the location information using map data, be sure to copy the map data on the supplied disc to a memory card. (→180)

- 1** Select **[Edit GPS Data]** from the **[Playback]** menu or **[Map]** menu and press **[MENU/SET]**
- 2** Use cursor button to select a picture and press **[MENU/SET]**
- 3** Use cursor button to select **[Edit Location]** and press **[MENU/SET]**
- 4** Use cursor button to select an editing method and press **[MENU/SET]**

| | |
|-----------------------|--|
| [Point on map] | Display recording location in the center and press [MENU/SET] |
| [Use another picture] | ① Select a picture and press [MENU/SET] ② Display recording location in the center and press [MENU/SET] |
| [Repeat] | The location information that was edited last will be displayed. |

- About map operation (→175)
- A confirmation screen will appear. Select [Yes] to overwrite the location information.

- The location information of a position specified on a map may deviate from the actual latitude and longitude coordinates.

[Edit Place Name]

You can edit a place name or landmark name recorded in a picture.

- 1** Select **[Edit GPS Data]** from the **[Playback]** menu or **[Map]** menu and press **[MENU/SET]**
- 2** Use cursor button to select a picture and press **[MENU/SET]**
- 3** Use cursor button to select **[Edit Place Name]** and press **[MENU/SET]**
- 4** Use cursor button to select an editing method and press **[MENU/SET]**

| | |
|-------------|--|
| [Candidate] | <ol style="list-style-type: none"> ① Select an item to edit and press [MENU/SET] ② Select a place name or landmark name from the candidates and press [MENU/SET] |
| [Direct] | <ol style="list-style-type: none"> ① Select an item to edit and press [MENU/SET] ② Input characters (Entering Text (→114)) |
| [Repeat] | Location information that was selected or entered last will be displayed. |

- A confirmation screen will appear. Select [Yes] to overwrite the place name information.

- Place names and landmarks subordinate to the edited place name will be deleted (for example, if you edit [County/Township], then [City/Town/Village] and [Landmark] will be deleted).
- If a landmark name is selected from My landmark (→182), the place name information other than landmark names will be deleted.
- You cannot edit pictures taken using a Panasonic digital camera (LUMIX) with GPS recording support released before 2010.

Adjusting the time using GPS

You can automatically update the [Clock Set] of the camera using the date and time information contained in GPS radio signals. When you move to a different time zone from your home area and positioning is executed successfully, the camera automatically adjusts the time to the local time.

- 1** Select [Auto Clock Set] from [Setup] menu and press [MENU/SET]
- 2** Use cursor button to select [ON] and press [MENU/SET]
- 3** (for the first time only)
When [Please set the home area] is displayed, press [MENU/SET]
- 4** Press ◀▶ to set your home area and press [MENU/SET]

City or area
name Current time



Difference from GMT (Greenwich Mean Time)

- When [Auto Clock Set] is set to [ON], the following settings are also changed automatically.
 - [GPS Setting]: [ON]
 - [World Time]: [Destination]
- The date and time adjusted by [Auto Clock Set] are not as accurate as those of clock radios. If the date and time are not adjusted accurately, use [Clock Set] to re-adjust the date and time.

Reducing the time required for positioning

You can reduce the time required for positioning by copying in advance the predicted satellite information (GPS assist data) of GPS satellites required for positioning to the camera.

- For downloading/updating GPS assist data, there is a method to use the “GPS Assist Tool” on a PC, and a method to use the Wi-Fi function.
- If the camera’s clock is not set, the GPS assist data cannot be used.

- The GPS assist data is valid for 30 days.
- The GPS assist data is updated once a day.
- The GPS assist data provider service may be changed or discontinued without prior notice. (The current service is provided as of January 2013.)

Using the “GPS Assist Tool”

You can use the “GPS Assist Tool” to download the GPS assist data from the Internet and update the GPS assist data of the camera.

■ Operating environment

You need a PC that can connect to the Internet.

| | |
|---------------------|---|
| Supported OS | Windows® XP (32-bit) SP3 Windows Vista® (32-bit) SP2 Windows® 7 (32-bit, 64-bit) and SP1 Windows® 8 (32-bit/64-bit) Mac® OS X v10.4, v10.5, v10.6, v10.7, and v10.8 |
|---------------------|---|

- You do not need to install the software on your computer.

- If the “GPS Assist Tool” cannot be used, download the GPS assist data from the support site and copy it to a memory card.
To access the support site, double-click “GPSASIST.HTM”, which is displayed when the camera is connected to a computer or when the “GPS Assist Tool” is copied to a memory card.
For detailed procedures, such as downloading the GPS assist data, read the information displayed on the support site.

■ Using “GPS Assist Tool” by connecting the camera and computer

Preparation:

Turn on the computer and close all other open application programs.

1 Select [Assist Data] from GPS menu and press [MENU/SET]

2 Use cursor button to select [Update] and press [MENU/SET]

3 Use cursor button to select [Connect USB] and press [MENU/SET]

4 Connect the camera to a computer

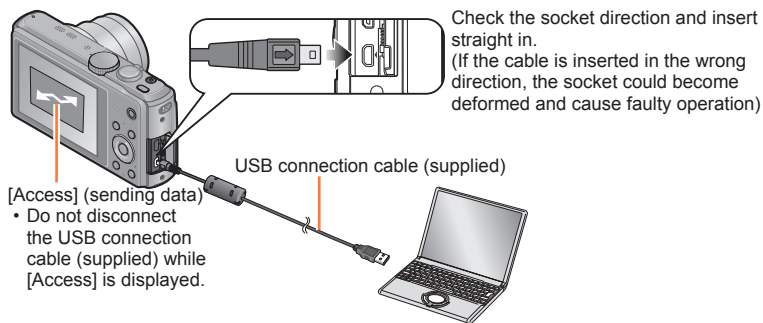

5 Start up the “GPS Assist Tool” on your computer and update the GPS assist data (→172)

The GPS assist data of the camera is updated.

6 Terminate the connection between the camera and computer and disconnect the USB connection cable (supplied)

- You can also update the assist data if you select [GPS assist data] for [USB Mode] (→64) when you connect the camera to a computer.
- Do not use any other USB connection cables except the supplied one or a genuine Panasonic USB connection cable (optional). Using cables other than the above may cause a malfunction.

■ Using a card reader/writer (commercially available)**Preparation:**

- Turn on the computer that is connected to a card reader/writer (commercially available) and close all other open application programs.
- Insert a memory card in the camera before starting the updating procedure.

- 1** Select **[Assist Data]** from **GPS** menu and press **[MENU/SET]**
- 2** Use cursor button to select **[Update]** and press **[MENU/SET]**
- 3** Use cursor button to select **[SD card]** and press **[MENU/SET]**
The “GPS Assist Tool” is copied to a memory card.
- 4** Turn off the camera and remove the memory card
- 5** Insert the memory card into a card reader/writer (commercially available) connected to the computer
- 6** Start up the “GPS Assist Tool” stored in the memory card on the computer and update the GPS assist data (→172)
- 7** Remove the memory card from the computer
- 8** Insert the memory card into the camera and turn on the camera
The GPS assist data of the camera is updated.

■ Operating the “GPS Assist Tool”

1 Start up the “GPS Assist Tool” on the computer

- Windows:
Double-click [GPSASIST.EXE] stored in the connected camera or memory card
- Mac:
① Double-click [GPSASIST.DMG] stored in the connected camera or memory card
② Double-click [GPSASIST]
- When the “GPS Assist Tool” is copied to the memory card, the execution file is stored in the [AD_LUMIX] folder.

2 Operate the “GPS Assist Tool”

- ① Click [Update]
 - ② Click [Yes]
 - ③ Click [OK]
 - ④ Click [Exit]
- Do not terminate the connection between the camera/card and computer until the data is updated.

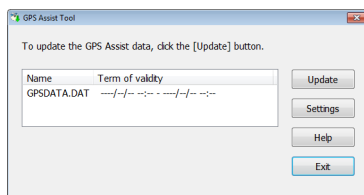

3 Terminate the connection between camera/card and computer

- Windows: Execute “Safely Remove Hardware” on the taskbar
- Mac: Open the Finder and click the eject icon that appears on the sidebar

■ Changing the proxy settings

Perform the proxy settings only if the GPS assist data cannot be updated successfully when the computer is connected to the Internet via proxy.

① Click [Settings]

② Perform the proxy settings

Windows: Enable [Use proxy server.] and change the settings.

Mac: Change the settings using the network settings screen of the displayed system environment settings screen.

Using the Wi-Fi function to update

You can connect to a wireless access point that is hooked up to the Internet and update GPS assist data.

- 1** Select **[Assist Data]** from GPS menu and press **[MENU/SET]**
- 2** Use cursor button to select **[Update]** and press **[MENU/SET]**
- 3** Use cursor button to select **[Wi-Fi]** and press **[MENU/SET]**
- 4** Use cursor button to select setting and press **[MENU/SET]**

| | |
|---------------------|--|
| [Charge and Update] | Update GPS assist data when this unit is charging while connected to a power outlet or PC. |
| [Update Now] | Immediately updates GPS assist data. |

- If Wi-Fi connection is not set, the Wi-Fi connection settings screen is displayed. For information on setting Wi-Fi connection. ([→205](#))

- Connections for GPS assist data update that uses the Wi-Fi function will not remain in [History Connection] in the [Wi-Fi] menu. Also, it cannot be registered to [Favorite Connection].

Reducing the time required for positioning

Checking the expiration date of the GPS assist data

The GPS assist data expires in 30 days. We recommend using new GPS assist data.

- 1** Select **[Assist Data]** from GPS menu and press **[MENU/SET]**
- 2** Use cursor button to select **[Expiry Date]** and press **[MENU/SET]**

- You can also check the expiration date on the screen when the “GPS Assist Tool” is started up on the computer.
- The starting date of the expiration period may be moved to an earlier time than the renewal date due to the update timing of GPS assist data or other factors.

Using the map function

You can display a map showing the location where a picture was taken or your current location.

- If you copy the map data stored on the supplied disc to a memory card, you can display more detailed maps. (→179)
- The place name information recorded on a picture and the place name displayed on a map may not be exactly the same.

Confirming the place where you took a picture using a map

When the location information or place name information is recorded on a picture, you can display a map showing the location where that picture was taken.

1 Display the pictures in playback mode

- GPS (with location information) and/or ► (with place name information) is displayed during playback for pictures that are recorded with location or place name information.

2 Press [MAP] button

A map of the place where you took the picture will appear. (If the picture was not recorded with location information or place name information, a wide area map will appear.)

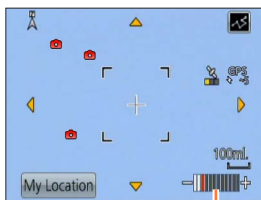

- 📷 : Location where a picture was taken
- : Your current location
- : My Landmark (→182)

On the touch screen, spread (pinch out) your 2 fingers to zoom in, and pinch (pinch in) your 2 fingers to zoom out. (You can also enlarge or reduce the map size using the zoom lever.)

Map scale level (The levels that can be displayed vary depending on the region.)

- You can drag the screen or press the cursor button to operate the display location of a map.
- You cannot change the display direction of the map. The map is oriented so that North is always at the top of the map.
- When you press the [↶/↷] button, it will return to the previous display.

- The actual place where you took the picture and the location displayed on the map may not be exactly the same.
- When you enlarge or reduce the map size, it may take some time before it is displayed.
- You can display the place where you took the pictures on a map only for pictures with location information or place name information recorded using Panasonic digital cameras (LUMIX) equipped with a GPS function.

Displaying your current location on a map

When positioning is executed successfully using GPS, you can display your current location on a map.

- Make sure to set [GPS Setting] to [ON]. (→159)

1 Press [MAP] button in playback mode**2 Touch [My Location]**

Time elapsed after positioning was executed successfully

- You can drag the screen or press the cursor button to operate the display location of a map.
- When you press the [↶/↷] button, it will return to the previous display.
- You can also use [My Location] in the [Map] menu to display the current location on a map.

When a map is being displayed, the camera executes positioning at regular intervals. When positioning is executed successfully, your current location (📍) displayed in the map is updated.

- This camera is not equipped with a navigation function.
- The actual place where you took the pictures and the location displayed on the map may be quite different under the following conditions.
 - When some time has elapsed after positioning was executed successfully.
 - When the camera is moving at high speed.

Displaying only pictures taken in the same area

You can select the area of a picture on a map to narrow down the pictures to be displayed.

1 Press [MAP] button in playback mode**2 Display the map so that the place where you took the pictures is moved within the display range of the frame**

Display range

On the touch screen, spread (pinch out) your 2 fingers to zoom in, and pinch (pinch in) your 2 fingers to zoom out. (You can also enlarge or reduce the map size using the zoom lever.)

Map scale level (The levels that can be displayed vary depending on the region.)

- You can drag the screen or press the cursor button to operate the display location of a map.

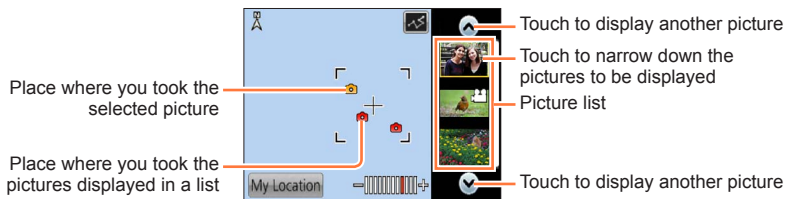
3 Press [DISP.] button

Place where you took the selected picture

Place where you took the pictures displayed in a list

Touch to display another picture

Touch to narrow down the pictures to be displayed
Picture list

Touch to display another picture

4 Touch a picture in the picture list to display it

Only pictures taken at a location within the display range of the frame are displayed. ([Filtering Play])

- You can also display a picture by selecting it using the cursor button and pressing [MENU/SET].
- For information on releasing [Filtering Play], refer to (→133).

● When the map is at its maximum size the location where the picture was taken and the picture list will not be displayed.

Displaying a map by selecting a country or region

You can select a place name and display a map of the area it is located in.

- 1** Press [MENU/SET] in playback mode
- 2** Use cursor button to select [Map] menu and press [MENU/SET]
- 3** Use cursor button to select [Select Area] and press [MENU/SET]
- 4** Use cursor button to select [From Place Name] and press [MENU/SET]
- 5** Use cursor button to select a country/region and press [MENU/SET]

Using the map data on the disc (supplied)

You can use “LUMIX Map Tool” to copy the map data on the disc (supplied) to a memory card. When the map data is copied to the memory card, detailed maps can be displayed on the camera.

The disc supplied with your camera contains more detailed map data and the software to install it. This data that is copied to the card will reduce the storage capacity of your card. To use this feature, it must be copied to each card you use.

- Install “LUMIX Map Tool” on your computer before starting the detailed map display procedure.

Installing “LUMIX Map Tool”

Close all other open application programs before inserting a disc in the computer drive.

■ Operating environment

| | |
|---------------------|---|
| Supported OS | Windows® XP (32-bit) SP3 Windows Vista® (32-bit) SP2 Windows® 7 (32-bit, 64-bit) and SP1 Windows® 8 (32-bit/64-bit) Mac® OS X v10.4, v10.5, v10.6, v10.7, and v10.8 |
|---------------------|---|

■ Windows

- 1 Insert the disc**
- 2 Click [Applications]**
- 3 Click [Recommended Installation] or [LUMIX Map Tool]**
Continue the installation procedure following the instructions displayed on the screen.

■ Mac

- 1 Insert the disc**
- 2 Double-click the recognized disc to open**
- 3 Double-click the [Application] folder to open**
- 4 Double-click the [MAPTOOL] folder to open**
- 5 Double-click [LUMIX Map Tool.pkg]**
Continue the installation procedure following the instructions displayed on the screen.

Using the map data on the disc (supplied)

Copying the map data to a memory card**Preparation:**

- Install “LUMIX Map Tool” on your computer before starting the copying procedure. (→179)
- Turn on the computer and close all other open application programs.
- Insert the supplied disc in your computer drive before starting the copying procedure. (Windows: Close the installation menu that starts automatically.)

1 Insert the memory card into a card reader/writer (commercially available) connected to the computer**2 Start “LUMIX Map Tool” installed in your computer**

- Windows: Click [Start] → [All Programs] → [Panasonic] → [LUMIX Map Tool] → [LUMIX Map Tool]
 - Double click on the shortcut icon on the desktop if you chose to create one at the time of installation.
- Mac: Double-click [LUMIX_Map_Tool] in [Applications] (Applications)

3 Select a card from the pull-down menu (A)**4 Click the checkbox to select a region to be copied (B)****5 Click [Execute] (C)**

- Perform the rest of the steps in accordance with the instructions displayed on the computer screen.

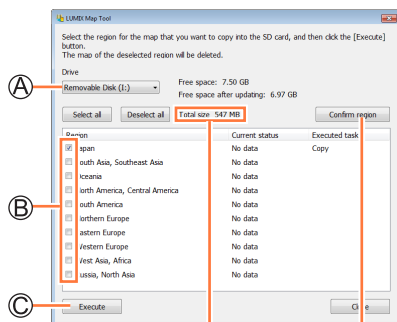

Size of data to be copied

The region confirmation window will appear.

6 After copying is finished, click [Close] and remove the memory card from the computer

- Windows: Execute “Safely Remove Hardware” on the taskbar
- Mac: Open the Finder and click the eject icon that appears on the sidebar

■ Copying map data directly to a memory card in the camera from the computer instead of a card reader/writer (commercially available)

You can copy the map data to a memory card inserted in the camera by connecting the camera to a computer using the USB connection cable (supplied).

- Select the connected camera in step **3** (→180).
- For details on making the connection with a computer (→264).
- Do not use any other USB connection cables except the supplied one or a genuine Panasonic USB connection cable (optional). Using cables other than the above may cause a malfunction.

■ Deleting the map data

You can free up space on the memory card by deleting map data that is no longer required.

- ① Click the already copied region in step **4** (→180)
 - The [Executed task] field will change to [Delete].
- ② Click [Execute]
 - Perform the rest of the steps in accordance with the instructions displayed on the computer screen.

- Since the map data size is large, be sure to check the free space on the memory card before copying the data. (A memory card of at least 8 GB is needed to copy the map data for all the regions.)
- Since the map data size is large, it will take time to copy the map data.
- When map data is copied to a memory card, the number of recordable pictures and recording time will decrease.
- The maps are copied to the memory card. If a different card is inserted in the camera, no maps are displayed.
- When a memory card is formatted (initialized), all data, including the map data, is deleted.
- Use “LUMIX Map Tool” for copying and deleting the map data. When the map data is deleted or moved to another location using the file operation of your computer, the maps may not be displayed correctly.

Registering my landmark

You can register a user-defined location that is not registered in this camera as my landmark in order to display it when positioning is executed or to record it on a picture. (Up to 50 landmarks)

- You can only register the landmark name as My landmark. (You cannot register place names such as city, town, or village names.)
- Unless the map data is copied to a memory card, My landmark cannot be registered. Before registering My landmark, copy the map data on the disc (supplied) to the memory card. (→179)

Registering my landmark from a map

You can register a location specified on a map as My landmark.

- 1** Press [MENU/SET] in playback mode
- 2** Use cursor button to select [Map] menu or [GPS] menu and press [MENU/SET]
- 3** Use cursor button to select [My Landmark] and press [MENU/SET]
- 4** Use cursor button to select [None] and press [MENU/SET]
- 5** Use cursor button to select [Point on map] and press [MENU/SET]
- 6** Display the location that you want to register at the center of the map and press [MENU/SET]
 - Operations available when a map is displayed (→175)
- 7** Press [MENU/SET]
- 8** Enter my landmark name (Entering text: (→114))

- You can use the GPS to register your current location as My landmark. If you have moved to a location where positioning is enabled and when positioning is executed successfully before starting the My landmark registration procedure, the current location will be displayed at the center of the map.

Registering the recording location as my landmark

You can use the location information of a picture to register it as My landmark.

- 1** Press [MENU/SET] in playback mode
- 2** Use cursor button to select [Map] menu or [GPS] menu and press [MENU/SET]
- 3** Use cursor button to select [My Landmark] and press [MENU/SET]
- 4** Use cursor button to select [None] and press [MENU/SET]
- 5** Use cursor button to select [Picture location data] and press [MENU/SET]
- 6** Display a picture that was taken at a location you want to register as a landmark
- 7** Press [MENU/SET]
- 8** Display the location that you want to register at the center of the map and press [MENU/SET]
 - Operations available when a map is displayed (→175)
- 9** Press [MENU/SET]
- 10** Enter my landmark name (Entering text: (→114))

Selecting My landmark and displaying it on a map

You can display a map by moving the registered My landmark to the center.

- 1** Press [MENU/SET] in playback mode
- 2** Use cursor button to select [Map] menu and press [MENU/SET]
- 3** Use cursor button to select [Select Area] and press [MENU/SET]
- 4** Use cursor button to select [From My Landmark] and press [MENU/SET]
- 5** Use cursor button to select My landmark and press [MENU/SET]

Editing or deleting my registered landmark

- 1** Press [MENU/SET] in playback mode
- 2** Use cursor button to select [Map] menu or [GPS] menu and press [MENU/SET]
- 3** Use cursor button to select [My Landmark] and press [MENU/SET]
- 4** Use cursor button to select an already registered landmark and press [MENU/SET]
- 5** Use cursor button to select an item and press [MENU/SET]

| | |
|----------|---------------------------------|
| [Edit] | Edits my landmark name. |
| [Delete] | Deletes my registered landmark. |

Using the compass



Measures the 16 cardinal directions based on the orientation of this unit's lens.

- The colored part of the compass needle points north.
- If [GPS Setting] is set to [OFF], declination correction is not performed.

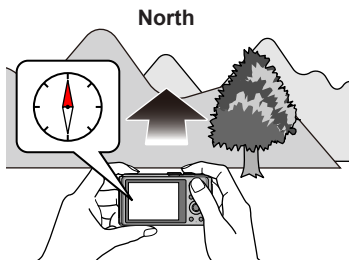

About declination correction

Earth is a large magnet that has the north pole as the S pole, and the south pole as the N pole, and the magnetism that the Earth has is called "geomagnetism". Due to the effects of "geomagnetism", a discrepancy in angle occurs between the north that the magnetic compass points to (magnetic north) and the correct north (true north). This discrepancy in angle is called "declination angle".

The compass that is built-in to this unit corrects the "declination angle" based on the latitude/longitude obtained by GPS positioning, so that it points to "true north".

- **Since moving may change the degree of declination depending on the place, we recommend that you set [GPS Setting] to [ON], and frequently update your current latitude/longitude.**

- If measurements are taken with this unit upside down, it may be unable to take measurements correctly.
- In places with weak geomagnetism, the position measurement may be affected.
- If objects such as the following are nearby, this unit may be unable to take measurements correctly.
 - Permanent magnets (metals like magnetic necklaces)/metals (metal desks, lockers)/ high-voltage lines or wirings/electrical home appliances (such as TVs, PCs, cell phones, speakers)
- In places such as the following, this unit may be unable to take measurements correctly.
 - Automobiles/trains/ships/airplanes/indoors (if the steel frames are magnetized)

Adjusting the compass

When the [×] appears on the compass, please perform [Calibrate compass].

- 1** Select [Calibrate compass] from [Setup] menu and press [MENU/SET]
- 2** Hold this unit vertically, and circle it in a figure 8 a few times by twisting your wrist

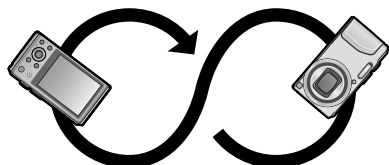

- When adjustment is successful, a message appears indicating the completion of the adjustment.

- **To avoid dropping the camera, always wear the hand strap on your wrist and perform adjustment.**
- If adjustment failed, move to a place nearby that is unaffected by magnetism, then adjust again.
- When you are unable to obtain the direction, such as when there is something that is emitting strong magnetism, a [×] is displayed in the compass.

Using the GPS log

Location information positioned using GPS can be recorded as a “GPS log”. When the GPS log is used, 1 day of traveling can be displayed with this unit’s map. An output of the GPS log file can also be utilized on compatible websites, etc.

Recording the GPS log

You can set the GPS log’s recording interval or recording duration.

- GPS logs cannot be recorded to the built-in memory. Use a card.

1 Select [GPS Log] from GPS menu and press [MENU/SET]

2 Use cursor button to select [Log Record] and press [MENU/SET]

3 Adjust settings

| | |
|----------------------|--|
| [Recording interval] | <p>The GPS log is recorded at the set interval.</p> <p>■ Settings</p> <p>[60SEC.] / [30SEC.] / [15SEC.]: Records a log at the set interval.</p> <ul style="list-style-type: none"> • Depending on the signal reception situation, the log recording intervals may be longer. |
| [Recording duration] | <p>When the set time elapses, the GPS log automatically stops recording.</p> <p>■ Settings</p> <p>[ENDLESS]: Does not set a time to stop logging.</p> <p>[48HRS] / [24HRS] / [12HRS] / [6HRS]:</p> <p>When the set time elapses, the log stops recording.</p> |

4 Use cursor button to select [Start] and press [MENU/SET]
“LOG” is displayed in the icon during positioning while recording logs.

■ Ending logging

Select [End] in step **3** and press [MENU/SET]

- In the following cases, GPS logging automatically ends.
 - When [GPS Setting] is set to [OFF]
 - When remaining battery becomes 
- The recorded GPS log is saved in the NMEA format.
 - You can convert to and output in the KML format. ([→189](#))

Displaying the GPS log on the map

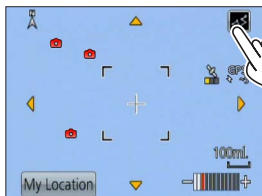
1 Touch  while map is displayed

- You can also perform this operation from [Display GPS Log] in the [Map] menu.

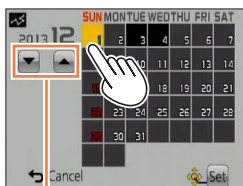
2 Touch the date of the GPS log you want to display, then touch **[Set]**

Select month

- You can also use cursor button to select recording date and press [MENU/SET] to confirm.

■ About the map while GPS log is displayed

While the GPS log is displayed, the pictures recorded on that date are narrowed down and displayed.

Touch and select another date



● [Map Display Style]

- ① Press [DISP.] button
- ② Use cursor button to select an item and press [MENU/SET]

- : Map
- : Map + Picture list
- : [Display GPS Log]
- : [Display GPS Log] + Picture list

- The actual movement and the GPS log's trajectory may not match.

Outputting the GPS log file

Convert GPS log files (NMEA format) to KML format and output to use it on a website, etc., that supports the KML format.

- 1 Select [GPS Log] from [GPS] menu and press [MENU/SET]**
- 2 Use cursor button to select [KML File Output] and press [MENU/SET]**
- 3 Use cursor button to select the GPS log recording date and press [MENU/SET]**
 - Displays up to 1,000 items.
 - The confirmation screen appears. Select [Yes] to perform output.

■ Save destination of the GPS log file

The log/output file is saved in the following folder on your card.

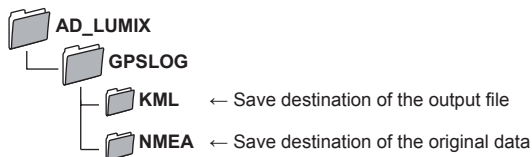

- The GPS log file may contain information that identifies the individual. When uploading data to a Web service, please check carefully before uploading.
- For information on whether the file format this unit can output is compatible with a website, check the website's Q&A section.

Deleting the GPS log

- 1** Select [GPS Log] from [GPS] menu and press [MENU/SET]
- 2** Use cursor button to select [Delete Log] and press [MENU/SET]
- 3** Use cursor button to select [1 DAY] / [ALL] and press [MENU/SET]
 - For [1 DAY]
 - Use cursor button to select the date, and press [MENU/SET]
 - Displays up to 1,000 items.
 - The confirmation screen appears. Select [Yes] to delete.

● If there is an output KML file, it is simultaneously deleted.

Wi-Fi® function

■ Use the camera as a wireless LAN device

When using equipment or computer systems that require more reliable security than wireless LAN devices, ensure that the appropriate measures are taken for safety designs and defects for the systems used. Panasonic will not take any responsibility for any damage that arises when using the camera for any purpose other than as a wireless LAN device.

■ Use of the Wi-Fi function of this camera is presumed to be in countries where this camera is sold

There is the risk that the camera violates the radiowave regulations if used in countries other than those where this camera is sold, and Panasonic takes no responsibility for any violations.

■ There is the risk that data sent and received via radio waves may be intercepted

Please note that there is the risk that data sent and received via radio waves may be intercepted by a third party.

■ Do not use the camera in areas with magnetic fields, static electricity or interference

- Do not use the camera in areas with magnetic fields, static electricity or interference, such as near microwave ovens. Radio waves may not reach the camera.
- Using the camera near devices such as microwave ovens or cordless telephones that use the 2.4 GHz radio wave band may cause a decrease in performance in both devices.

■ Do not connect to the wireless network you are not authorized to use

When the camera utilizes its Wi-Fi function, wireless networks will be searched automatically. When this happens, wireless networks that you are not authorized to use (SSID*) may be displayed, however do not attempt to connect to the network as it may be considered as unauthorized access.

* SSID refers to the name that is used to identify a network over a wireless LAN connection. If the SSID matches for both devices, transmission is possible.

■ Images that can be sent

| Images to send | | JPEG | MP4*1 | AVCHD*1 *2 | 3D | |
|----------------|-----------------------|------------|-------|------------|----|---|
| Destination | [Smartphone] | ○ | ○ | — | — | |
| | [PC] | ○ | ○ | ○ | ○ | |
| | [Cloud Sync. Service] | ○ | ○ | — | ○ | |
| | [Web service] | ○ | ○ | — | ○ | |
| | [AV device] | [Home] | ○ | — | — | ○ |
| | | [External] | ○ | — | — | ○ |
| | [Printer] | ○ | — | — | — | |

*1 Sending by [Send Images While Recording] is not available.

*2 The file size of AVCHD motion pictures that can be sent to a computer has to be 4 GB or under. Files exceeding 4 GB cannot be sent.

- Some images may not be played back or sent depending on the device.
- Refer to the manual of the destination equipment or the WEB service for more information on how to playback pictures.

■ About the Wi-Fi connection lamp

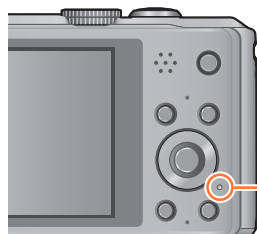

Wi-Fi connection lamp

Lit blue: The Wi-Fi connection is on standby

Blinking blue: Sending/receiving data through the Wi-Fi connection

■ Before Use

- To use the Wi-Fi function on this unit, a wireless access point or a destination device equipped with the wireless LAN function is required.
- Some items in the recording menu and playback menu cannot be used when connected to Wi-Fi. They can be used after the Wi-Fi connection is terminated.
- While connected to Wi-Fi, do not insert or remove the USB connection cable (supplied), AV cable (optional), or the HDMI micro cable (optional). Doing so will terminate your Wi-Fi connection.
- You cannot select items regarding [Remote Shooting] nor [Send Images While Recording] because recording functions are not available while supplying power with the AC adaptor (supplied).

- The camera cannot be used to connect to a public wireless LAN connection.
- Use a IEEE802.11b, IEEE802.11g or IEEE802.11n compatible device when using a wireless access point.
- We strongly recommend that you set an encryption to maintain information security.
- When the battery indicator is flashing red, the connection with other equipment may not start or the connection may be disrupted. (A message such as [Communication error] is displayed.)
- When sending images on a mobile network, high packet communication fees may be incurred depending on the details of your contract.
- Pictures may not be completely sent depending on radio wave conditions. If the connection is terminated while sending pictures, pictures with missing sections may be sent.
- **Do not remove the memory card or battery or move to an area without any reception while sending images.**
- The monitor display may become distorted for an instant while connected to the service, however this will not affect the image being sent.

[Airplane Mode]



To disable Wi-Fi connection, set [Airplane Mode] to [ON].

- 1 Select [Airplane Mode] from [Setup] menu and press [MENU/SET]**
- 2 Use cursor button to select [ON] and press [MENU/SET]**

- Electromagnetic waves from the camera can affect instruments and meters. In airplane cabins or in other restricted areas, set [Airplane Mode] to [ON].

What you can do with the Wi-Fi function

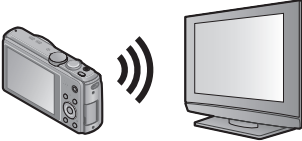
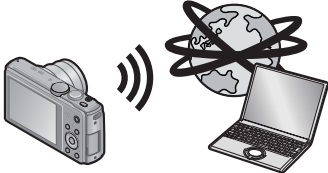
Linking with the Wi-Fi compatible equipment allows you to remotely operate the camera, or share pictures with people in distant places even during recording or playing back.

| [Remote Shooting] (→197) | [Playback on TV] (→209) |
|---|--|
|  <p>Linking with a smartphone/tablet enables the following:</p> <ul style="list-style-type: none"> • Remote recording (→197) • Playing back the pictures in the camera (→200) • Saving the pictures in the camera to the smartphone/tablet, or sending them to WEB services. (→200) • Sending the acquired location information to the camera. (→201) |  <p>By linking with the DLNA compatible TV, you can display pictures on TV right after taking them or display them on TV later by playing them back on the camera.</p> |
| [Send Images While Recording] (→211) | [Send Images Stored in the Camera] (→224) |
|  <p>Every time you take a picture, the picture can be automatically sent to a specified location. You can play back the picture on the smartphone/tablet, or save and edit it on PC.</p> <ul style="list-style-type: none"> • Send to: <ul style="list-style-type: none"> – [Smartphone]/[PC]/[Cloud Sync. Service]/[Web service]/[AV device] |  <p>You can select and send recorded images.</p> <ul style="list-style-type: none"> • Send to: <ul style="list-style-type: none"> – [Smartphone]/[PC]/[Cloud Sync. Service]/[Web service]/[AV device]/[Printer] |

Sequence of connecting operation

The operation to connect this unit to other devices by Wi-Fi differs by function, connection method, etc. Perform operation by following the screen display and refer to the manual, etc. for the connecting device or WEB service.

Preparation: You may be required to configure settings on applicable devices depending on the connecting device or WEB service.

1 Press [Wi-Fi] button

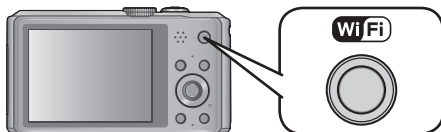

2 Use cursor button to select the item and press [MENU/SET]

- You can also select it by touch operations.



| | |
|-----------------------|---|
| [New Connection] | Configure settings for a new Wi-Fi connection with Wi-Fi compatible devices or WEB services. <ul style="list-style-type: none"> • [Remote Shooting] (→197) • [Playback on TV] (→209) • [Send Images While Recording] (→211) • [Send Images Stored in the Camera] (→224) |
| [History Connection] | Connect to compatible devices or WEB services using the same setting as before when connecting with Wi-Fi. (→236) |
| [Favorite Connection] | You can register frequently used connection settings. (→237) |
| [Wi-Fi Setup] | Configure various Wi-Fi settings. (→251) |

3 Connect to Wi-Fi

- When connecting to a smartphone using NFC (→202)
- When connecting via a wireless access point (→205)
- When connecting directly (→208)

What you can do with the [Wi-Fi] button when connected to Wi-Fi

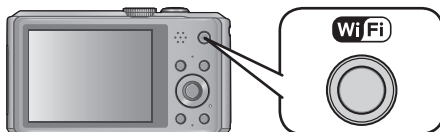
1 Press [Wi-Fi] button when connected to Wi-Fi**2** Use cursor button to select the item, and press [MENU/SET]

| Item | Description |
|--|--|
| [Terminate the Connection] | Terminates the Wi-Fi connection. |
| [Change the Destination] | Terminates the Wi-Fi connection, and allows you to select a different Wi-Fi connection. |
| [Change Settings for Sending Images] | For details (→214). |
| [Register the Current Destination to Favorite] | Registering the current connection destination or the connection method, you can easily connect with the same connection method next time. |
| [Network Address] | Displays the MAC address and IP address of this unit. (→252) |

Remote Shooting

You can remotely operate the camera using a smartphone/tablet. You need to install "Image App" on your smartphone/tablet.

Installing the smartphone/tablet app "Panasonic Image App"



The "Panasonic Image App" is an application provided by Panasonic that allows your smartphone/tablet to perform the following operations of a Wi-Fi-compatible LUMIX. ("Panasonic Image App" is indicated as "Image App" in the text.)

| | For Android™ apps | For iOS apps |
|-------------------------------|--|---|
| Version | 1.2 or above | |
| Supported OS | Android 2.2 - Android 4.2* | iOS 4.3 - iOS 6.0 |
| Installation procedure | ① Connect your Android device to a network ② Select "Google Play™ Store" ③ Enter "Panasonic Image App" into the search box ④ Select "Panasonic Image App" and install it • The icon will be added to the menu. | ① Connect the iOS device to the network ② Select "App Store SM " ③ Enter "Panasonic Image App" into the search box ④ Select "Panasonic Image App" and install it • The icon will be added to the menu. |

- The service may not be able to be used properly depending on the type of smartphone/tablet being used. For compatible devices, see the following support site.
<http://panasonic.jp/support/global/cs/dsc/> (This site is available in English only.)
- When downloading the app on a mobile network, high packet communication fees may be incurred depending on the details of your contract.

* To connect this unit with [Wi-Fi Direct], Android OS 4.0 or above is required and the device must be compatible with Wi-Fi Direct.

Connecting to a smartphone/tablet

You can easily connect using the NFC function. For details (→202).

Preparations: Install the “Image App” in advance. (→197)

1 Press [Wi-Fi] button

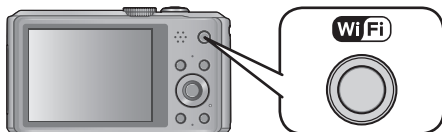

2 Use cursor button to select [New Connection] and press [MENU/SET]

- You can also select it by touch operations.
- When connecting with the setting you used before, you can select the connection destination from [History Connection] (→236) or [Favorite Connection] (→237).

3 Use cursor button to select [Remote Shooting] and press [MENU/SET]

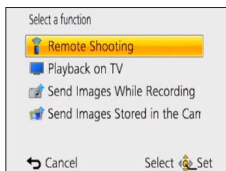

- The information (SSID and password) required for directly connecting your smartphone/tablet to this unit is displayed.
- For changing connection methods (→199).

On your smartphone/tablet

(The default connection method is set to [Manual Connection].)

4 On the setting menu of your smartphone/tablet, turn on the Wi-Fi function

5 Select the SSID that matches the one displayed on the screen of this unit, and then enter the password

6 Start “Image App” on your smartphone/tablet (→197)

- When the connection is complete, live images being captured by the camera are displayed on the smartphone/tablet.

(Continued on the next page)

■ When connecting with [Via Network]

(On the camera)

- ① After performing step ③, press the [DISP.] button (→198)
- ② Use cursor button to select [Via Network], and then press [MENU/SET]
- ③ Select the method for connecting to a wireless access point, and set
 - For details (→205).

(On your smartphone/tablet)

- ④ On the setting menu of your smartphone/tablet, turn on the Wi-Fi function
- ⑤ Select the wireless access point you want to connect to, and set
- ⑥ Start “Image App” on your smartphone/tablet (→197)

■ When connecting with [Wi-Fi Direct] or [WPS Connection]

(On the camera)

- ① After performing step ③, press the [DISP.] button (→198)
- ② Use cursor button to select [Direct], and then press [MENU/SET]
 - For details (→208).

(On your smartphone/tablet)

- ③ Start “Image App” on your smartphone/tablet (→197)

- Read the [Help] in the “Image App” menu for further details on how to operate.
- To quit [Remote Shooting], press [⏏/➡] button.

● Caution:

Be sure to pay special attention to the privacy, the likeness rights, etc. of the subject when you use this function. Use at your own risk.

- If you have changed the clock setting of this unit or the smartphone/tablet after [Time sync], perform [Time sync] again.
- On the smartphone/tablet, you can set the acquisition interval of location information and check the transfer status of location information. Refer to [Help] in the “Image App” menu for details.
- The smartphone/tablet may fail to acquire location information in China and the border area in the neighboring countries of China. (As of January 2013)
- (When using “Image App” for iOS)
If you press the Home or On/Off button of a smartphone/tablet while [Rec. loc. Info] is working, location information recording is stopped.

Taking pictures via a smartphone/tablet (remote recording)

1 Select [] on a smartphone/tablet

- The recorded images are saved in the camera.
- Some settings are not available.
- The screen differs depending on the operating system.

- Cannot be set for recording AVCHD motion pictures at [60p] in [FHD].
- If the internal camera temperature rises because the surrounding temperature is high or a motion picture is recorded continuously, recording may be stopped halfway through to protect the camera. Also, the picture quality setting change message may be displayed when the recording starts.

Playing back pictures in the camera

1 Select [] on a smartphone/tablet

- You can save pictures on the smartphone/tablet.
- You can send pictures to a WEB service, etc.
- The screen differs depending on the operating system.

- You cannot play back motion pictures stored in the camera. Save the motion picture on your smartphone/tablet, and then playback.

Sending location information to the camera from a smartphone/tablet

You can acquire location information from a smartphone/tablet, and write it on images afterwards.

Refer to (→144) for how to write the location information on the images recorded by this unit.

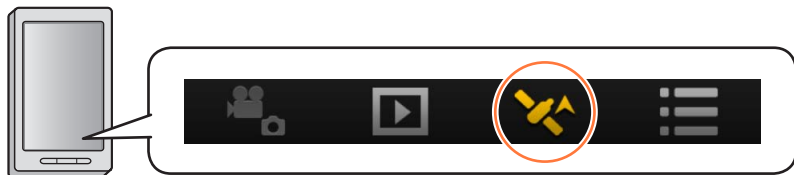
1 Select [📍] on a smartphone/tablet

- The screen differs depending on the operating system.

Easily connect to a smartphone (NFC)

Use the NFC (Near Field Communication) function to easily connect this unit to a smartphone with Wi-Fi, to record remotely, and send pictures to a smartphone.

- This function can be used with NFC compatible devices with Android (2.3.3 or above).
(Not available in certain models)

■ Preparations on the camera

- In [Wi-Fi Setup], set [NFC Operation] to [ON] (→251)

■ Preparation on the smartphone side

- Install “Image App” in advance (→197)
- Set Wi-Fi function to “ON”
(For information on how to adjust settings, please read the manual for your smartphone)

- The NFC function cannot be used in the following cases:
 - When [Airplane Mode] is set to [ON]
 - When connected to a television, computer, or printer
 - When recording motion pictures
 - When enclosed in marine case
- If the communication environment is bad, the touch function may not be usable.
- Metal objects between this unit and the smartphone may interfere with communication. Also, any stickers, etc., near the NFC area may affect communication performance.

Connecting easily to a smartphone for remote control

If you use the NFC function, the operation for “Connecting to smartphone/tablet” becomes quicker (→198)

1 Start “Image App” on the smartphone

2 Place your smartphone to the side of this unit

Place the NFC area of your smartphone over the part of this unit as shown in the figure below.

- This function can be used even when the camera is turned off.
- Do not bump your smartphone strongly against this unit.
(The smartphone or this unit may get scratched)
- For information on how to use NFC compatible devices, please contact the device manufacturer.
- If there is no immediate reaction, slightly move the position where the phone was placed.

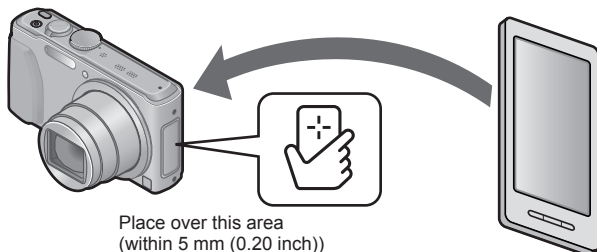

3 Press ◀▶ to select [Yes] and press [MENU/SET]

4 Place your smartphone over this area of the unit again

- When the connection is complete, live images captured by the camera will be displayed on your smartphone.
- Connected smartphones are registered to this unit. From the next time and on, you can connect by performing steps **1** and **2**.

- You can register up to 20 smartphones. If the number of registered smartphones exceeds 20, registrations will be deleted starting from the smartphone touched first.
- Cannot connect while supplying power with the AC adaptor (supplied) connected.
(Pictures can be transferred. (→204))

Transferring a still picture easily to your smartphone

You can use the NFC function to easily transfer a still picture displayed on this unit to a smartphone with "Image App" installed.

- 1 Start "Image App" on the smartphone**
- 2 Display the still picture to be transferred to your smartphone on the 1-picture screen (full screen)**
- 3 Place your smartphone to the side of this unit** ([→203](#))
The still picture displayed on this unit is transferred to your smartphone.

- It may take several minutes to complete the picture transfer depending on the environment used.

Connecting via a wireless access point

This section describes how to use the Wi-Fi connection to connect to compatible devices and other equipment via a wireless access point.

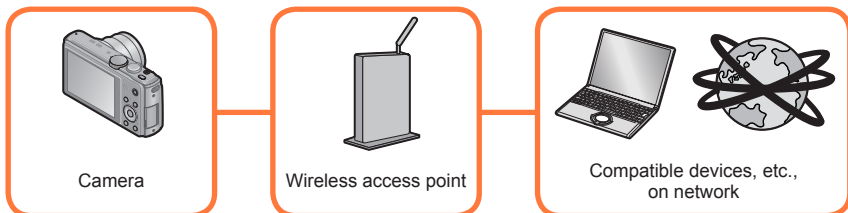

1 Use cursor button to select [Via Network] in the connection method settings screen, and then press [MENU/SET]



2 Use cursor button to select connection method, and then press [MENU/SET]

| Connection method | Description | |
|----------------------|--|--------|
| [WPS (Push-Button)]* | Save push button type wireless access point that is compatible with Wi-Fi Protected Setup™ with a WPS mark. | (→205) |
| [WPS (PIN code)]* | Save PIN code type wireless access point that is compatible with Wi-Fi Protected Setup with a WPS mark. | (→206) |
| [Manual Connection] | Select this option when you are not sure about the WPS compatibility, or when you want to search for and connect to a wireless access point. | (→206) |

* WPS refers to a function that allows you to easily configure the settings related to the connection and security of wireless LAN devices. To check if the wireless access point you are using is compatible with WPS, refer to the manual of the wireless access point.

When connecting with [WPS (Push-Button)]

1 Press the wireless access point WPS button until it switches to WPS Mode

- Refer to the wireless access point instruction manual for details.

When connecting with [WPS (PIN code)]

- 1** Use cursor button to select the wireless access point you are connecting to, and press [MENU/SET]
- 2** Enter the PIN code displayed on the camera screen into the wireless access point
- 3** Press [MENU/SET]
 - Refer to the wireless access point instruction manual for details.

If you are not sure about the WPS compatibility (connecting by [Manual Connection])

Search for available wireless access points.

- Confirm encryption key of the selected wireless access point if the network authentication is encrypted.
- When connecting by [Manual Input], confirm SSID, encryption type, encryption key of the wireless access point you are using.

- 1** Use cursor button to select the wireless access point you are connecting to, and press [MENU/SET]

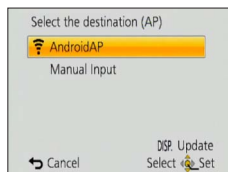

- Touching [DISP.] button will search for a wireless access point again.
- If no wireless access point is found, refer to “When connecting with [Manual Input]” (→207).

- 2** (If network authentication is encrypted) Enter the encryption key

- For details on how to enter characters, refer to “Entering Text” (→114).

■ When connecting with [Manual Input]

If the wireless access point does not appear, you can directly enter the SSID.

1 In step **1** (→206), use cursor button to select [Manual Input], and then press [MENU/SET]

2 Enter the SSID of the wireless access point you are connecting to, then select [Set]

• For details on how to enter characters, refer to “Entering Text” (→114).

3 Use cursor button to select the network authentication type, and press [MENU/SET]

• For information on network authentication, see the manual of the wireless access point.

4 Use cursor button to select the encryption type, and press [MENU/SET]

• The type of settings that can be changed may vary depending on the details of network authentication settings.

| Network authentication type | Encryption types that can be set |
|-----------------------------|----------------------------------|
| [WPA2-PSK]/[WPA-PSK] | [TKIP]/[AES] |
| [Common Key] | [WEP] |
| [Open] | [No Encryption]/[WEP] |

5 (When an option other than [No Encryption] is selected)
Enter the encryption key and select [Set]

- Check the wireless access points instruction manual and settings when a saving wireless access point.
- If no connection can be established, the wireless access point's radio waves may be too weak. Refer to “Message displays” (→277) and “Q&A Troubleshooting” (→281) for details.
- Transmission speed may decrease, or may not be usable depending on the environment it is used in.

Connecting directly

Directly connect this unit to the device you are using as a wireless access point. You can connect this unit and your device in a method supported by your device.



Camera



Wi-Fi compatible devices

1 Use cursor button to select [Direct] in the connection method settings screen, and then press [MENU/SET]



2 Use cursor button to select connection method, and then press [MENU/SET]

| Connection method | Description |
|---------------------|--|
| [Wi-Fi Direct]™ | <ol style="list-style-type: none"> ① Set the device to Wi-Fi Direct mode ② Use cursor button to select [Wi-Fi Direct] and then press [MENU/SET] ③ Use cursor button to select the device to connect to, and then press [MENU/SET] <ul style="list-style-type: none"> • Read the operating instructions of your device for details. |
| [WPS Connection] | [WPS (Push-Button)] <ol style="list-style-type: none"> ① Use cursor button to select [WPS (Push-Button)] and then press [MENU/SET] ② Set the device to WPS mode <ul style="list-style-type: none"> • You can wait longer for a connection by pressing the [DISP.] button on this unit. |
| | [WPS (PIN code)] <ol style="list-style-type: none"> ① Use cursor button to select [WPS (PIN code)] and then press [MENU/SET] ② Enter the PIN code of the device into this unit |
| [Manual Connection] | Enter the SSID and password into the device. The SSID and password are displayed on the connection waiting screen of this unit. |

Playback on TV

You can use the Wi-Fi function [Playback on TV] to display pictures on a television that is compatible with a DLNA certified digital media renderer (DMR).

Displaying the picture on TV right after taking it/ Displaying the picture on TV by playing it back on the camera

- For details about compatible devices, refer to the website below.
<http://panasonic.jp/support/global/cs/dsc/> (This site is available in English only.)
- Preparations:** Set the TV to DLNA waiting Mode.
- Read the operating instructions for your TV.

1 Press [Wi-Fi] button

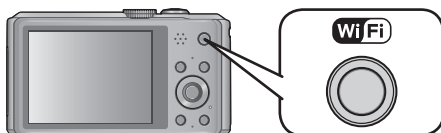

2 Use cursor button to select [New Connection] and press [MENU/SET]

- You can also select it by touch operations.

3 Use cursor button to select [Playback on TV] and press [MENU/SET]

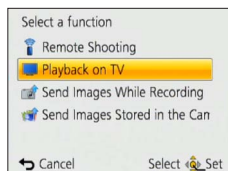

4 Use cursor button to select connection method, and then press [MENU/SET]

| | |
|---------------|--|
| [Via Network] | When you want to connect to your TV via an wireless access point. (→205) |
| [Direct] | When you want to directly connect your TV to this unit with [Wi-Fi Direct], [WPS Connection], or [Manual Connection]. (→208) |

5 Use cursor button to select a device you want to connect, and then press [MENU/SET]

- When the connection is established, the screen is displayed.

(Continued on the next page)

6 Take or play back pictures on this unit

- To change the setting or disconnect, press [Wi-Fi] button. (→196)

- Motion pictures cannot be displayed on a TV.
- During the multi/calendar playback, pictures displayed on the screen of this unit are not displayed on TV.
- When a TV is connected to this unit, the TV screen may temporarily return to the status before the connection. Pictures are displayed again when you take or play back pictures.
- [Effect] and [Sound] of the Slide Show are disabled.

Send Images While Recording

A picture can be automatically sent to a specified device every time you take it. Since the camera gives priority to recording, sending may take longer.

- Motion pictures cannot be sent.
- If you turn off this unit or the Wi-Fi connection before sending is complete, unsent pictures will not be resent.
- You may not be able to delete files or use the playback menu while sending.
- When sending images on a mobile network, high packet communication fees may be incurred depending on the details of your contract.

When sending images to smartphone/tablet

Preparations: Install the "Image App" in advance. (→197)

1 Press [Wi-Fi] button

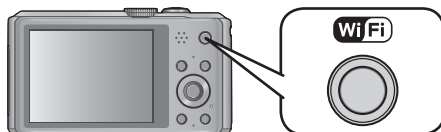

2 Use cursor button to select [New Connection] and press [MENU/SET]

- You can also select it by touch operations.

3 Use cursor button to select [Send Images While Recording] and press [MENU/SET]

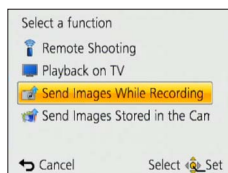

4 Use cursor button to select [Smartphone] and press [MENU/SET]

(Continued on the next page)

5 Select a connection method

■ When you want to connect to the smartphone/tablet via a wireless access point

(On your smartphone/tablet)

- ① On the setting menu of your smartphone/tablet, turn on the Wi-Fi function
- ② Select the wireless access point you want to connect to, and set
- ③ Start "Image App" on your smartphone/tablet* (→197)

(On the camera)

- ④ Use cursor button to select [Via Network], and then press [MENU/SET]
- ⑤ Select the method for connecting to a wireless access point, and set
 - For details (→205).

■ When you want to directly connect a smartphone/tablet to this unit

- When connecting with [Wi-Fi Direct] or [WPS Connection]

(On the camera)

- ① Use cursor button to select [Direct], and then press [MENU/SET]
 - For details (→205).

(On your smartphone/tablet)

- ② Start "Image App" on your smartphone/tablet* (→197)

- When connecting with [Manual Connection]

(On the camera)

- ① Use cursor button to select [Direct], and then press [MENU/SET]
- ② Use buttons to select [Manual Connection], and then press [MENU/SET]

(On your smartphone/tablet)

- ③ On the setting menu of your smartphone/tablet, turn on the Wi-Fi function
- ④ Select the SSID that matches the one displayed on the screen of this unit, and then enter the password
- ⑤ Start "Image App" on your smartphone/tablet* (→197)

* A window indicating that the smartphone/tablet is connecting to the camera is displayed. Press the "Back" button on Android devices. Select "Close" on iOS devices.

(Continued on the next page)

6 Use cursor button to select the device you want to connect to, and then press [MENU/SET]

- When the connection is established, the screen is displayed. To change the send setting, press the [DISP.] button. (→214)

7 Take pictures

- The pictures are sent automatically after taking them.
- To change the setting or disconnect, press [Wi-Fi] button.
You cannot change the settings while sending pictures. Wait until sending is complete.

Changing the settings for sending images

- 1** Press the [DISP.] button on the confirmation screen of destination
- 2** Use cursor button to select the item, and press [MENU/SET]

| Item | Description |
|--------------------------|--|
| [Size] | Resize the image to send. [Original]/[Auto]*1/[Change] <ul style="list-style-type: none"> • If you select [Auto], the image size is determined by the circumstances at the destination. • You can select the image size for [Change] from [M], [S] or [VGA]. The aspect ratio does not change. |
| [Delete Location Data]*2 | Select whether to delete the location information from images before sending them. [ON]: Delete the location information, then send. [OFF]: Keep the location information and send. <ul style="list-style-type: none"> • This operation only deletes the location information from the images that are set to be sent. (The location information will not be deleted from the original images stored in this unit.) |
| [Cloud Limit]*3 | You can select whether to send images when the Cloud Folder runs out of free space. [ON]: Do not send images. [OFF]: Delete images from the oldest ones, then send new images. |

*1 Only available when the destination for [Send Images Stored in the Camera] is set to [Web service].

*2 Only available when [Send Images Stored in the Camera] is selected and the destination is set to [Cloud Sync. Service], [Web service] or [External] of [AV device].

*3 Only available when the destination is set to [Cloud Sync. Service].

When sending images to PC

Preparations:

- Turn the computer on.
- Prepare folders for receiving images on the PC before sending a picture to the PC. (→217)
- If the standard settings are changed for the workgroup on the connected PC, you must change settings in [PC Connection] on this unit. (→251)

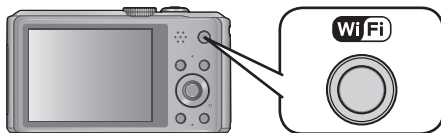
1 Press [Wi-Fi] button**2 Use cursor button to select [New Connection] and press [MENU/SET]**

- You can also select it by touch operations.

3 Use cursor button to select [Send Images While Recording] and press [MENU/SET]**4 Use cursor button to select [PC] and press [MENU/SET]****5 Use cursor button to select connection method, and then press [MENU/SET]**

| | |
|---------------|--|
| [Via Network] | When you want to connect to your PC via a wireless access point. (→205) |
| [Direct] | When you want to directly connect your PC to this unit with [Wi-Fi Direct], [WPS Connection], or [Manual Connection]. (→208) |

6 Use cursor button to select the PC you want to connect to, and then press [MENU/SET]

(Continued on the next page)

7 Use cursor button to select the folder you want to send to, and then press [MENU/SET]

- When the connection is complete, the screen is displayed. To change the send setting, press [DISP.] button. (→214)

8 Take pictures

- To change the setting or disconnect, press [Wi-Fi] button. (→196)
You cannot change the settings while sending pictures. Wait until sending is complete.

- Folders sorted by the sent date are created in the specified folder, and pictures are saved in those folders.
- If the screen for a user account and password entry appears, enter the one you set on your PC.

To create a folder that receives images

- Create a PC user account (account name (up to 254 characters) and password (up to 32 characters)) consisting of alphanumeric characters. An attempt to create a receive folder may fail if the account includes non-alphanumeric characters.

■When using “PHOTOfunSTUDIO”**1 Install “PHOTOfunSTUDIO” to the PC**

- For details on hardware requirements and installation, read “Installing supplied software” (→263).

2 Create a folder that receives images with “PHOTOfunSTUDIO”

- To create the folder automatically, select [Auto-create]. To specify a folder, create a new folder, or set a password to the folder, select [Create manually].
- For details, refer to the operating instructions of “PHOTOfunSTUDIO” (PDF).

■When not using “PHOTOfunSTUDIO”

(For Windows)

Supported OS: Windows 8 / Windows 7 / Windows Vista / Windows XP

Example: Windows 7

1 Select a folder you intend to use for receiving, then right-click**2 Select [Properties], then enable sharing of the folder**

- For details, refer to the operating instructions of your PC or Help on the operating system.

(For Mac)

Supported OS: OS X v10.4 to v10.8

Example: OS X v10.8

1 Select a folder you intend to use for receiving, then click on the items in the following order**[File] → [Get Info]****2 Enable sharing of the folder**

- For details, refer to the operating instructions of your PC or Help on the operating system.

When sending images to [Cloud Sync. Service]

Preparations:

You need to register to “LUMIX CLUB” (→243) and configure the Cloud Sync. setting (→219) to send a picture to a Cloud Folder.

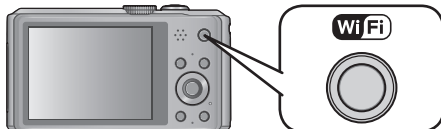
1 Press [Wi-Fi] button**2 Use cursor button to select [New Connection], and then press [MENU/SET]**

- You can also select it by touch operations.

3 Use cursor button to select [Send Images While Recording], and then press [MENU/SET]**4 Use cursor button to select [Cloud Sync. Service], and then press [MENU/SET]****5 Press [MENU/SET]****6 Use cursor button to select connection method, and then press [MENU/SET]**

- [Via Network]: (→205)

7 Check the send setting

- When the connection is complete, the screen is displayed. To change the send setting, press [DISP.] button. (→214)

8 Take pictures

- To change the setting or disconnect, press [Wi-Fi] button. (→196)
You cannot change the settings while sending pictures. Wait until sending is complete.

■ About the images sent to a Cloud Folder by the use of [Cloud Sync. Service] (As of January 2013)

To send images to a PC, Cloud Sync. setting is required. Configure the settings on a PC with "PHOTOfunSTUDIO" or on a smartphone/tablet with "Image App".

- If you set the picture destination to [Cloud Sync. Service], sent pictures are temporarily saved in the cloud folder, and they can be synchronized with the device in use, such as the PC or smartphone/tablet.
- A Cloud Folder stores transferred images for 30 days (up to 1000 pictures). Transferred images are deleted automatically 30 days after the transfer. Furthermore, when the number of stored images exceeds 1000, some images may be deleted depending on the [Cloud Limit] (→214) setting even within 30 days after the transfer.
- When the download of images from a Cloud Folder to all specified devices is complete, images may be deleted from the Cloud Folder even within 30 days after the transfer.

When sending images to WEB Service

Preparations:

You need to register to “LUMIX CLUB” (→243) to send a picture to a WEB service. When sending images to WEB services, such as Facebook or YouTube, the WEB service being used must be registered with the “LUMIX CLUB”. Registering multiple WEB services will send images to all services simultaneously. (→248)

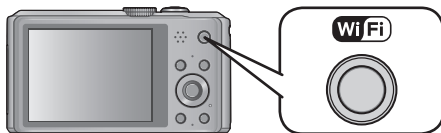
1 Press [Wi-Fi] button**2 Use cursor button to select [New Connection], and then press [MENU/SET]**

- You can also select it by touch operations.

3 Use cursor button to select [Send Images While Recording], and then press [MENU/SET]**4 Use cursor button to select [Web service], and then press [MENU/SET]****5 Use cursor button to select connection method, and then press [MENU/SET]**

- [Via Network]: (→205)

6 Use cursor button to select a WEB service you want to connect, and then press [MENU/SET]

- When the connection is complete, the screen is displayed. To change the send setting, press [DISP.] button. (→214)

7 Take pictures

- To change the setting or disconnect, press [Wi-Fi] button. (→196)
You cannot change the settings while sending pictures. Wait until sending is complete.

- Images uploaded to the WEB Service cannot be displayed or deleted with this camera. Check images by accessing the WEB Service with your smartphone/tablet or computer.
- If sending images fails, a report email outlining the failure will be sent to the email address registered with "LUMIX CLUB".
- **Images may contain personal information that can be used to identify the user, such as a title, the time and date when the images was taken, and the location where the image was taken. Check this information before uploading images to WEB services.**
 - Panasonic assumes no responsibility for the damages resulting from the leakage, loss, etc. of images uploaded on WEB services.
 - When uploading images to the WEB Service, do not delete images from this camera, even after they have finished sending, until you have checked that they have been properly uploaded to the WEB Service. Panasonic assumes no responsibility for the damages resulting from the deletion of images stored in this unit.

When sending images to AV device

Preparations:

When sending a picture to [Home], set your device to DLNA waiting mode.

- Read the operating instructions of your device for details.

When sending images to [External], the following are required:

- Registration to "LUMIX CLUB". (→243)
- Address number and access number acquired by the destination External AV device. (→249)

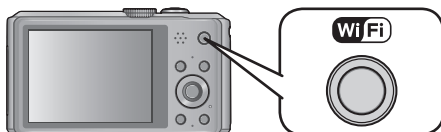
1 Press [Wi-Fi] button**2 Use cursor button to select [New Connection], and then press [MENU/SET]**

- You can also select it by touch operations.

3 Use cursor button to select [Send Images While Recording], and then press [MENU/SET]**4 Use cursor button to select [AV device], and then press [MENU/SET]****5 Use cursor button to select [Home] or [External], and then press [MENU/SET]****6 Use cursor button to select connection method, and then press [MENU/SET]**

| | |
|--|---|
| [Via Network] | When you want to connect to an AV device via a wireless access point. (→205) |
| [Direct] • Only when [Home] is selected | When you want to directly connect an AV device to this unit with [Wi-Fi Direct], [WPS Connection], or [Manual Connection]. (→208) |

(Continued on the next page)

7 Use cursor button to select a device you want to connect, and then press [MENU/SET]

- When the connection is complete, the screen is displayed. To change the send setting, press [DISP.] button. (→214)

8 Take pictures

- To change the setting or disconnect, press [Wi-Fi] button. (→196)
You cannot change the settings while sending pictures. Wait until sending is complete.

Send Images Stored in the Camera

- When sending images on a mobile network, high packet communication fees may be incurred depending on the details of your contract.
- Details of the playback menu [Favorite] or [Print Set] settings will not be sent.
- Some images taken with a different camera may not be able to be sent.
- Images that have been modified or edited with a computer may not be able to be sent.

When sending images to smartphone/tablet

Preparations: Install the "Image App" in advance. (→197)

1 Press [Wi-Fi] button

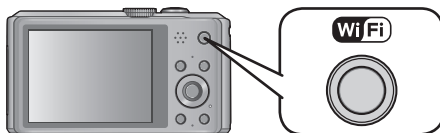

2 Use cursor button to select [New Connection], and then press [MENU/SET]

- You can also select it by touch operations.

3 Use cursor button to select [Send Images Stored in the Camera], and then press [MENU/SET]

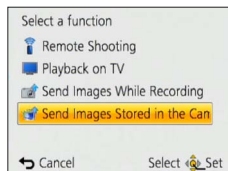

4 Use cursor button to select [Smartphone], and then press [MENU/SET]

(Continued on the next page)

5 Select a connection method

■ When you want to connect to the smartphone/tablet via a wireless access point

(On your smartphone/tablet)

- ① On the setting menu of your smartphone/tablet, turn on the Wi-Fi function
- ② Select the wireless access point you want to connect to, and set
- ③ Start "Image App" on your smartphone/tablet* (→197)

(On the camera)

- ④ Use cursor button to select [Via Network], and then press [MENU/SET]
- ⑤ Select the method for connecting to a wireless access point, and set
 - For details (→205).

■ When you want to directly connect a smartphone/tablet to this unit

- When connecting with [Wi-Fi Direct] or [WPS Connection]

(On the camera)

- ① Use cursor button to select [Direct], and then press [MENU/SET]
 - For details (→208).

(On your smartphone/tablet)

- ② Start "Image App" on your smartphone/tablet* (→197)

- When connecting with [Manual Connection]

(On the camera)

- ① Use cursor button to select [Direct], and then press [MENU/SET]
- ② Use buttons to select [Manual Connection], and then press [MENU/SET]

(On your smartphone/tablet)

- ③ On the setting menu of your smartphone/tablet, turn on the Wi-Fi function
- ④ Select the SSID that matches the one displayed on the screen of this unit, and then enter the password
- ⑤ Start "Image App" on your smartphone/tablet* (→197)

* A window indicating that the smartphone/tablet is connecting to the camera is displayed. Press the "Back" button on Android devices. Select "Close" on iOS devices.

6 Use cursor button to select the device you want to connect to, and then press [MENU/SET]

- When the connection is established, the screen is displayed. To change the send setting, press the [DISP.] button. (→214)

(Continued on the next page)

7 Use cursor button to select [SINGLE] or [MULTI] and then press [MENU/SET]

8 Select and send the images

■ [SINGLE] setting

- ① Use cursor button to select the picture
- ② Press [MENU/SET]
 - Confirmation screen is displayed. If you select [Yes], the operation is executed.

■ [MULTI] setting

- ① Use cursor button to select the picture, and then press [DISP.] button to set (repeat)
 - The setting is canceled when [DISP.] button is pressed again.
- ② Press [MENU/SET]
 - Confirmation screen is displayed. If you select [Yes], the operation is executed.

● The number of pictures that can be sent by [MULTI] is limited.

When sending images to PC

Preparations:

- Turn the computer on.
- Prepare folders for receiving images on the PC before sending a picture to the PC. (→217)
- If the standard settings are changed for the workgroup on the connected PC, you must change settings in [PC Connection] on this unit. (→251)

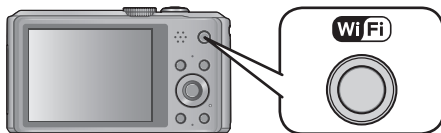
1 Press [Wi-Fi] button**2 Use cursor button to select [New Connection], and then press [MENU/SET]**

- You can also select it by touch operations.

3 Use cursor button to select [Send Images Stored in the Camera], and then press [MENU/SET]**4 Use cursor button to select [PC], and then press [MENU/SET]****5 Use cursor button to select connection method, and then press [MENU/SET]**

| | |
|---------------|--|
| [Via Network] | When you want to connect to your PC via a wireless access point. (→205) |
| [Direct] | When you want to directly connect your PC to this unit with [Wi-Fi Direct], [WPS Connection], or [Manual Connection]. (→208) |

6 Use cursor button to select a PC you want to connect, and then press [MENU/SET]**7 Use cursor button to select the folder you want to send to, and then press [MENU/SET]**

- When the connection is complete, the screen is displayed. To change the send setting, press [DISP.] button. (→214)

(Continued on the next page)

8 Use cursor button to select [SINGLE] or [MULTI] and then press [MENU/SET]

- To change the setting or disconnect, press [Wi-Fi] button. (→196)

9 Select and send the images

■ [SINGLE] setting

- ① Use cursor button to select the picture
- ② Press [MENU/SET]
 - Confirmation screen is displayed. If you select [Yes], the operation is executed.

■ [MULTI] setting

- ① Use cursor button to select the picture, and then press [DISP.] button to set (repeat)
 - The setting is canceled when [DISP.] button is pressed again.
- ② Press [MENU/SET]
 - Confirmation screen is displayed. If you select [Yes], the operation is executed.

- Folders sorted by the sent date are created in the specified folder, and pictures are saved in those folders.
- If the screen for a user account and password entry appears, enter the one you set on your PC.
- The number of pictures that can be sent by [MULTI] is limited.

When sending images to [Cloud Sync. Service]

Preparations:

You need to register to "LUMIX CLUB" (→243) and configure the Cloud Sync. setting (→219) to send a picture to a Cloud Folder.

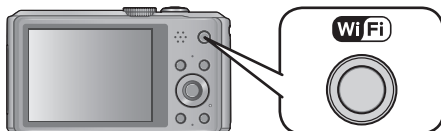
1 Press [Wi-Fi] button**2 Use cursor button to select [New Connection], and then press [MENU/SET]**

- You can also select it by touch operations.

3 Use cursor button to select [Send Images Stored in the Camera], and then press [MENU/SET]**4 Use cursor button to select [Cloud Sync. Service], and then press [MENU/SET]****5 Press [MENU/SET]****6 Use cursor button to select connection method, and then press [MENU/SET]**

- [Via Network]: (→205)

7 Check the send setting

- When the connection is complete, the screen is displayed. To change the send setting, press [DISP.] button. (→214)

8 Use cursor button to select [SINGLE] or [MULTI] and then press [MENU/SET]

- To change the setting or disconnect, press [Wi-Fi] button. (→196)

(Continued on the next page)

9 Select and send the images

■ [SINGLE] setting

- ① Use cursor button to select the picture
- ② Press [MENU/SET]
 - Confirmation screen is displayed. If you select [Yes], the operation is executed.

■ [MULTI] setting

- ① Use cursor button to select the picture, and then press [DISP.] button to set (repeat)
 - The setting is canceled when [DISP.] button is pressed again.
- ② Press [MENU/SET]
 - Confirmation screen is displayed. If you select [Yes], the operation is executed.

● The number of pictures that can be sent by [MULTI] is limited.

When sending images to WEB Service

Preparations:

You need to register to “LUMIX CLUB” (→243) to send a picture to a WEB service. When sending images to WEB services, such as Facebook or YouTube, the WEB service being used must be registered with the “LUMIX CLUB”. Registering multiple WEB services will send images to all services simultaneously. (→248)

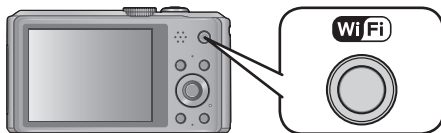
1 Press [Wi-Fi] button**2 Use cursor button to select [New Connection], and then press [MENU/SET]**

- You can also select it by touch operations.

3 Use cursor button to select [Send Images Stored in the Camera], and then press [MENU/SET]**4 Use cursor button to select [Web service], and then press [MENU/SET]****5 Use cursor button to select connection method, and then press [MENU/SET]**

- [Via Network]: (→205)

6 Use cursor button to select a WEB service you want to connect, and then press [MENU/SET]

- When the connection is complete, the screen is displayed. To change the send setting, press [DISP.] button. (→214)

7 Use cursor button to select [SINGLE] or [MULTI] and then press [MENU/SET]

- To change the setting or disconnect, press [Wi-Fi] button. (→196)

(Continued on the next page)

8 Select and send the images

■ [SINGLE] setting

- ① Use cursor button to select the picture
- ② Press [MENU/SET]
 - Confirmation screen is displayed. If you select [Yes], the operation is executed.

■ [MULTI] setting

- ① Use cursor button to select the picture, and then press [DISP.] button to set (repeat)
 - The setting is canceled when [DISP.] button is pressed again.
- ② Press [MENU/SET]
 - Confirmation screen is displayed. If you select [Yes], the operation is executed.

- Images uploaded to the WEB Service cannot be displayed or deleted with this camera. Check images by accessing the WEB Service with your smartphone/tablet or computer.
- If sending images fails, a report email outlining the failure will be sent to the email address registered with "LUMIX CLUB".
- The number of pictures that can be sent by [MULTI] is limited.
- **Images may contain personal information that can be used to identify the user, such as a title, the time and date when the images was taken, and the location where the image was taken. Check this information before uploading images to WEB services.**

- Panasonic assumes no responsibility for the damages resulting from the leakage, loss, etc. of images uploaded on WEB services.
- When uploading images to the WEB Service, do not delete images from this camera, even after they have finished sending, until you have checked that they have been properly uploaded to the WEB Service. Panasonic assumes no responsibility for the damages resulting from the deletion of images stored in this unit.

When sending images to AV device

Preparations:

When sending a picture to [Home], set your device to DLNA waiting mode.

- Read the operating instructions of your device for details.

When sending images to [External], the following are required:

- Registration to "LUMIX CLUB". (→243)
- Address number and access number acquired by the destination External AV device. (→249)

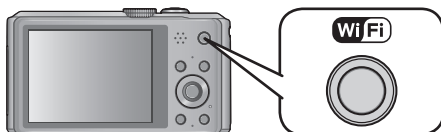
1 Press [Wi-Fi] button**2 Use cursor button to select [New Connection], and then press [MENU/SET]**

- You can also select it by touch operations.

3 Use cursor button to select [Send Images Stored in the Camera], and then press [MENU/SET]**4 Use cursor button to select [AV device], and then press [MENU/SET]****5 Use cursor button to select [Home] or [External], and then press [MENU/SET]****6 Use cursor button to select connection method, and then press [MENU/SET]**

| | |
|--|---|
| [Via Network] | When you want to connect to an AV device via a wireless access point. (→205) |
| [Direct] • Only when [Home] is selected | When you want to directly connect an AV device to this unit with [Wi-Fi Direct], [WPS Connection], or [Manual Connection]. (→208) |

(Continued on the next page)

7 Use cursor button to select a device you want to connect, and then press [MENU/SET]

- When the connection is complete, the screen is displayed. To change the send setting, press [DISP.] button. (→214)

8 Use cursor button to select [SINGLE] or [MULTI] and then press [MENU/SET]

- To change the setting or disconnect, press [Wi-Fi] button. (→196)

9 Select and send the images

■ [SINGLE] setting

- ① Use cursor button to select the picture
- ② Press [MENU/SET]
 - Confirmation screen is displayed. If you select [Yes], the operation is executed.

■ [MULTI] setting

- ① Use cursor button to select the picture, and then press [DISP.] button to set (repeat)
 - The setting is canceled when [DISP.] button is pressed again.
- ② Press [MENU/SET]
 - Confirmation screen is displayed. If you select [Yes], the operation is executed.

● The number of pictures that can be sent by [MULTI] is limited.

When sending images to Printer

You can print out recorded pictures wirelessly from a PictBridge (wireless LAN-compatible)* printer.

* Compliant with the DPS over IP standards. See the following website for information on the PictBridge (wireless LAN-compatible) printer.

<http://panasonic.jp/support/global/cs/dsc/> (This site is available in English only.)

1 Press [Wi-Fi] button

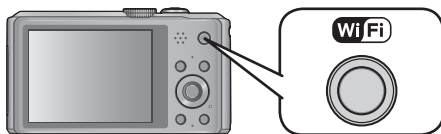

2 Use cursor button to select [New Connection], and then press [MENU/SET]

• You can also select it by touch operations.

3 Use cursor button to select [Send Images Stored in the Camera], and then press [MENU/SET]

4 Use cursor button to select [Printer], and then press [MENU/SET]

5 Use cursor button to select connection method, and then press [MENU/SET]

| | |
|---------------|---|
| [Via Network] | When you want to connect to your Printer via a wireless access point. (→205) |
| [Direct] | When you want to directly connect your printer to this unit with [Wi-Fi Direct], [WPS Connection], or [Manual Connection]. (→208) |

6 Use cursor button to select a printer you want to connect, and then press [MENU/SET]

7 Select the picture and print (→267)

• To change the setting or disconnect, press [Wi-Fi] button. (→196)

● Motion pictures cannot be printed out.

Connecting with a setting you used before

(Connect from History)

If you want to make a Wi-Fi connection with the setting you used before, you can select it from the history, and connect.

- The number of settings that can be saved in the history is limited. It is recommended that you save frequently used Wi-Fi connection settings in [Favorite Connection].

1 Press [Wi-Fi] button

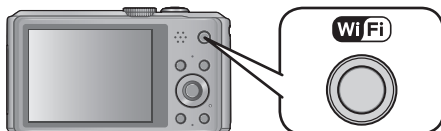

2 Use cursor button to select [History Connection] and press [MENU/SET]



- You can also select it by touch operations.

3 Use cursor button to select the desired connection setting and press [MENU/SET]

- To display the connection detail, press [DISP.] button.

■ Registering to [Favorite Connection]

If you register a frequently used Wi-Fi connection, you can quickly call it and connect.

① Press ►

② Enter a registration name

- For details on how to enter characters, refer to “Entering Text” (→114).

● Performing [Reset Wi-Fi Settings] clears the history and the contents saved in [Favorite Connection].

Connect from Favorites

You can register a frequently used connection method from your History.

- For details on how to register, ([→236](#)).

1 Press [Wi-Fi] button

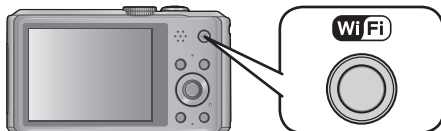

2 Use cursor button to select [Favorite Connection] and press [MENU/SET]



- You can also select it by touch operations.

3 Use cursor button to select the desired connection setting and press [MENU/SET]

- To display the connection detail, press [DISP.] button.

■ Editing registered items

① Press ►

② Use cursor button to select the item and press [MENU/SET]

| Item | Description |
|--------------------------------|--|
| [Remove from Favorite] | A confirmation screen is displayed. Select [Yes] with cursor button and then press [MENU/SET]. |
| [Change the Order in Favorite] | Select the destination with cursor button, and then press [MENU/SET]. |
| [Change the Registered Name] | For details on how to enter characters, refer to "Entering Text" (→114). |

Transferring pictures automatically [Smart Transfer]

Transfer recorded images to a PC, an AV device or a Cloud Folder automatically.

- When [Auto Transfer] is set to [ON], the camera automatically uploads recorded pictures. For this reason pictures may be uploaded unintentionally if, for example, you share this unit with other people. Panasonic assumes no responsibility for any damages caused by uploaded images.
- Panasonic assumes no responsibility for any damages caused by the use of [Smart Transfer].
- Electromagnetic waves from the camera can affect instruments and meters. In airplane cabins, hospitals, etc., set [Airplane Mode] to [ON]. ([→193](#))

■ What you can do with [Smart Transfer]

| | |
|--------------------------|--|
| [Auto Transfer] | Transfers pictures automatically while charging. (→240) |
| [Transfer Now] | Transfers pictures instantly to the specified transfer destination. (→240) |
| [Set Destination] | Changes transfer destination and settings of pictures. (→241) |
| [Charge Priority] | Sets whether charging or transfer is prioritized. (→242) |
| [Display Log] | Displays the date and result of pictures transferred automatically. (→242) |

Setting [Smart Transfer]

- 1** Select **[Wi-Fi Setup]** from the **[Wi-Fi]** menu and press **[MENU/SET]**
- 2** Use cursor button to select **[Smart Transfer]** and press **[MENU/SET]**
- 3** Use cursor button to select transfer destination and press **[MENU/SET]**
- 4** Select the method for connecting to a wireless access point, and set
 - For details ([→205](#)).
- 5** Set the transfer destination
 - When [PC] is selected**
 - For details regarding preparation before transfer, read “When sending images to PC”. ([→215](#))
 - ① Use cursor button to select a PC you want to connect, and then press **[MENU/SET]**
 - ② Use cursor button to select the folder you want to send to, and then press **[MENU/SET]**
 - When [Cloud Sync. Service] is selected**
 - For details regarding preparation before transfer, read “When sending images to [Cloud Sync. Service]”. ([→218](#))
 - When [AV device] is selected**
 - For details, read “When sending images to AV device”. ([→222](#))
 - Select the AV device you want to connect, and then press the **[MENU/SET]** button.
- 6** Use cursor button to select **[Auto Transfer]** and press **[MENU/SET]**
- 7** Use cursor button to select **[ON]** and press **[MENU/SET]**
 - Only the images you recorded when **[Auto Transfer]** is set to **[ON]** is transferred.

[Smart Transfer]

Preparation: Set [Smart Transfer]. (→239)

1 Turn off the camera

(When using a power outlet)

2 Connect the AC adaptor (supplied) and the camera using the USB connection cable (supplied), and plug the AC adaptor (supplied) into the electrical outlet

(When using a PC)

Connect the camera to a computer using the USB connection cable (supplied)

- [Smart Transfer] starts automatically according to the [Charge Priority] (→242) setting.
- [Smart Transfer] is not available when the memory card is locked.
- Depending on the specifications of the PC, [Smart Transfer] may fail.

- Except at the ambient temperature between 0 °C and 40 °C (32 °F to 104 °F), [Smart Transfer] may not work.
- When [Destination] is set to [PC], the pictures are stored in the incoming folder created. (→217)
- If there are pictures that are not transferred when [Auto Transfer] is set to [OFF], the message that confirms whether to transfer these pictures is displayed. Select a desired option.

■ Transferring pictures now

Preparation: Set [Smart Transfer]. (→239)

1 Connect the AC adaptor (supplied) and the camera using the USB connection cable (supplied), and plug the AC adaptor (supplied) into the electrical outlet

- Switch to Playback Mode.

2 Select [Wi-Fi Setup] from the [Wi-Fi] menu and press [MENU/SET]

3 Use cursor button to select [Smart Transfer] and press [MENU/SET]

4 Use cursor button to select [Transfer Now] and press [MENU/SET]

- Confirmation screen is displayed. It is executed when [Yes] is selected. Exit the menu after it is executed.

Changing transfer destination and settings of pictures

- 1** Select **[Wi-Fi Setup]** from the **[Wi-Fi]** menu and press **[MENU/SET]**
- 2** Use cursor button to select **[Smart Transfer]** and press **[MENU/SET]**
- 3** Use cursor button to select **[Set Destination]** and press **[MENU/SET]**
- 4** Use cursor button to select an item and press **[MENU/SET]**

| Item | Description |
|--------------------------------|--|
| [Destination] | Change the transfer destination [PC], [Cloud Sync. Service], [AV device] <ul style="list-style-type: none"> • If you are not changing the wireless access point you want to connect to, press the [⏏/➔] button. <p>■ To change the wireless access point you want to connect to</p> <ol style="list-style-type: none"> ① Select [Change Access Point] and press [MENU/SET] (If you selected [Cloud Sync. Service], select [Yes] at the confirmation screen of the connection destination and press [MENU/SET]) ② Select the method for connecting to a wireless access point, and set <ul style="list-style-type: none"> • For details (→205). |
| [Size] | Change the size of the picture to be transferred [Original], [Change] <ul style="list-style-type: none"> • [Change]: [M] or [S] can be selected for picture size. The aspect ratio of the pictures does not change. |
| [Delete Location Data]* | You can select whether to delete location information from the picture when transferring pictures. [ON]: Erase location information and transfer. [OFF]: Transfer without deleting location information. <ul style="list-style-type: none"> • The location information is only deleted for the transferred pictures. (Location information is not deleted from pictures in this unit) |
| [Cloud Limit]* | You can select whether to perform [Smart Transfer] when the capacity of the Cloud Folder runs out of free space. [ON]: Do not transfer pictures. [OFF]: Delete oldest pictures in order and transfer new pictures. |
| [Exit] | Exit the destination setting menu. |

* Can only be set when **[Cloud Sync. Service]** is the **[Destination]**.

■ To change priority settings for charging and picture transfer [Charge Priority]

- 1 Select [Wi-Fi Setup] from the [Wi-Fi] menu and press [MENU/SET]
- 2 Use cursor button to select [Smart Transfer] and press [MENU/SET]
- 3 Use cursor button to select [Charge Priority] and press [MENU/SET]
- 4 Use cursor button to select an item and press [MENU/SET]

| Item | Description |
|-------|---|
| [ON] | Give priority to charging. Pictures are transferred after charging. |
| [OFF] | Give priority to picture transfers. <ul style="list-style-type: none"> • When remaining battery is low, charging may be prioritized. |

- Exit the menu after it is executed.

■ Checking transfer history of the pictures [Display Log]

You can check the day the picture was sent and its details.

- 1 Select [Wi-Fi Setup] from the [Wi-Fi] menu and press [MENU/SET]
- 2 Use cursor button to select [Smart Transfer] and press [MENU/SET]
- 3 Use cursor button to select [Display Log] and press [MENU/SET]

- Dates and content of transferred images are displayed. Close the menu after checking the terms of use.

Using “LUMIX CLUB”

About the [LUMIX CLUB]

Acquire a “LUMIX CLUB” login ID (free).

If you register this unit to the “LUMIX CLUB”, you can synchronize images between the devices you are using, or transfer these images to WEB services.

Use the “LUMIX CLUB” when uploading pictures to WEB services or external AV device.

- You can set the same “LUMIX CLUB” login ID for this unit and a smartphone/tablet.
(→246)

Refer to the “LUMIX CLUB” site for details.
<http://lumixclub.panasonic.net/eng/c/>

Please note;

- The service may be suspended due to regular maintenance or unexpected problems, and service contents may be changed or added to, without prior notice to the users.
- The service may be stopped in whole or in part with a reasonable period of advance notice.

1 Select [Wi-Fi Setup] in the [Wi-Fi] menu

2 Use cursor button to select [LUMIX CLUB], and press [MENU/SET]

3 Use cursor button to select [Add/Change Account], and press [MENU/SET]



(Continued on the next page)

4 Use cursor button to select [New account], and press [MENU/SET]

- Connect to the network. Proceed to the next page by pressing [MENU/SET].
- A confirmation screen will be displayed if a login ID has already been acquired for the camera. Select [Yes] to acquire a new login ID, or [No] if you do not need to acquire a new login ID.

5 Select the method for connecting to a wireless access point, and set

- For details ([→205](#)).
- The settings screen will only appear during the first connection. Connection methods set on this unit are stored and will be used for subsequent connections. If you want to change the wireless access point to connect to, press the [DISP.] button, then change the connecting destination.

6 Press [MENU/SET]

7 Read through the "LUMIX CLUB" terms of use and press [MENU/SET]

- You can press ▲▼ to switch pages.
- You can enlarge (2x) the display by moving the zoom lever toward T.
- You can reset the enlarged display to its original size (1x) by moving the zoom lever toward W.
- You can move the position of the enlarged display with cursor button.
- Press [⏪/⏩] button to cancel the process without acquiring a login ID.

8 Enter a password and press [MENU/SET]

- Enter any combination of 8 to 16 characters and numbers for the password.
- For details on how to enter characters, refer to "Entering Text" ([→114](#)).

9 Check the login ID and press [MENU/SET]

- The login ID (12-digit number) will be displayed automatically. When logging in to the "LUMIX CLUB" with a computer, you only need to enter the numbers.
- A message is displayed when the connection is complete. Press [MENU/SET].
- Be sure to make a note of the login ID and password.
- Close the menu after changing settings.

Check or change the acquired login ID/password**Preparation:**

To change the "LUMIX CLUB" password on the camera, access the "LUMIX CLUB" website from your smartphone/tablet or PC and change the "LUMIX CLUB" password in advance.

- 1 Select [Wi-Fi Setup] in the [Wi-Fi] menu**
- 2 Use cursor button to select [LUMIX CLUB], and press [MENU/SET]**
- 3 Use cursor button to select [Add/Change Account], and press [MENU/SET]**
- 4 Use cursor button to select [Change Login ID], and press [MENU/SET]**
 - The login ID and password are displayed.
 - The password is displayed as "★".
 - Close the menu if only checking the login ID.
- 5 Use cursor button to select the login ID or password you want to change, and press [MENU/SET]**
 - The confirmation screen is displayed when changing the login ID. Select [Yes].
- 6 Enter the login ID or password, and press [MENU/SET]**
 - Refer to "Entering Text" (→114) for information on how to enter text.
 - Enter the new password you have created on your smartphone/tablet or PC into the camera. If the password differs from the one you created on your smartphone/tablet or PC, you will not be able to upload images.
 - Close the menu after changing settings.

To set the same login ID for the camera and the smartphone/tablet

Setting the same login ID on this unit and your smartphone/tablet is convenient for sending images on this unit to other devices or WEB services.

■ When either this unit or the smartphone/tablet has acquired the login ID

- ① Connect this unit to the smartphone/tablet (→198)
 - ② From the "Image App" menu, set the common login ID
 - The login IDs for this unit and the smartphone/tablet become the same.
- After connecting this unit to the smartphone/tablet, the setup screen for a common login ID may appear when you display the playback screen. You can also set a common login ID by following the on-screen instructions.
 - This operation is not available for [Wi-Fi Direct] connection.

■ When this unit and the smartphone/tablet have acquired different login IDs

- When you want to use the smartphone's/tablet's login ID for this unit
 - ① Change the login ID and password for this unit to those acquired by the smartphone/tablet
- When you want to use this unit's login ID for the smartphone/tablet
 - ① Change the login ID and password for the smartphone/tablet to those acquired by this unit

Check the "LUMIX CLUB" terms of use

Check the details if the terms of use have been updated.

1 Select [Wi-Fi Setup] in the [Wi-Fi] menu

2 Use cursor button to select [LUMIX CLUB], and press [MENU/SET]

3 Use cursor button to select [Terms of use], and press [MENU/SET]

- The camera will connect to the network and the terms of use will be displayed. Close the menu after checking the terms of use.

Delete your login ID and account from the "LUMIX CLUB"

Delete the login ID from the camera when transferring it to another party or disposing of it. You can also delete your "LUMIX CLUB" account.

- 1 Select [Wi-Fi Setup] in the [Wi-Fi] menu**
- 2 Use cursor button to select [LUMIX CLUB], and press [MENU/SET]**
- 3 Use cursor button to select [Delete account], and press [MENU/SET]**
 - The message is displayed. Press [MENU/SET].
- 4 Select [Yes] in the login ID delete confirmation screen**
 - The message is displayed. Press [MENU/SET].
- 5 Select [Yes] on the confirmation screen for deleting the "LUMIX CLUB" account**
 - If you want to continue using the service, selecting [No] will only delete the login ID. Exit the menu after it is executed.
- 6 Press [MENU/SET]**
 - The login ID is deleted, and then the message notifying the deletion of your account is displayed. Press [MENU/SET].
 - Exit the menu after it is executed.

● Changes and other actions to login IDs can only be made to the login ID acquired with the camera.

Using WEB services

When sending images to WEB services, such as Facebook or YouTube, the WEB service being used must be registered with the "LUMIX CLUB". Registering multiple WEB services will send images to all services simultaneously.

- Check the "FAQ/Contact us" on the following site for compatible WEB services.
http://lumixclub.panasonic.net/eng/c/lumix_faqs/

Preparation:

Make sure that you have created an account on the WEB service you want to use, and have the login information available.

1 Connect to the "LUMIX CLUB" site using a smartphone/tablet or computer

<http://lumixclub.panasonic.net/eng/c/>

2 Enter your "LUMIX CLUB" login ID and password and log in to the service (→243)

3 Save your email address

4 Select the WEB service to be used and save it

- Follow the instructions on the screen to save the service.

Configuring the external AV device settings

Images can be sent to the AV device of relatives and acquaintances via "LUMIX CLUB".

- See the following site for AV device that is compatible with "LUMIX CLUB".
<http://panasonic.jp/support/global/cs/dsc/> (This site is available in English only.)

Preparation:

Check the address number (16-digit number) and access number (4-digit number) of the destination AV device issued by "LUMIX CLUB".

(Refer to the AV device instruction manual for details)

- 1** Select **[Wi-Fi Setup]** in the **[Wi-Fi]** menu
- 2** Use cursor button to select **[External AV device]**, and press **[MENU/SET]**
- 3** Use cursor button to select **[Add new device]**, and press **[MENU/SET]**
- 4** Enter the address number and select **[Set]**
 - Refer to "Entering Text" (→114) for information on how to enter text.
- 5** Enter the access number and select **[Set]**
- 6** Enter any name and select **[Set]**
 - A maximum of 28 characters can be entered.
 - Up to 14 characters can be entered for **[\], [[], []], [•]** and **[-]**.
 - Close the menu after changing settings.

■ Change or delete information on registered AV device

Information on AV device that has already been saved can be changed or deleted.

- 1** Select [Wi-Fi Setup] in the [Wi-Fi] menu
- 2** Use cursor button to select [External AV device], and press [MENU/SET]
- 3** Use cursor button to select the AV device you want to change or delete, and press [MENU/SET]
- 4** Select [Edit] or [Delete], and press [MENU/SET]

| Item | Description |
|----------|--|
| [Edit] | Change information on AV device that has already been registered. Perform steps 4 through 6 of "Configuring the external AV device settings". (→249) |
| [Delete] | Delete information on AV device that has already been registered. <ul style="list-style-type: none"> • Confirmation screen is displayed. It is executed when [Yes] is selected. |

- Exit the menu after it is executed.

How to Use the [Wi-Fi Setup] Menu

Configure the settings required for the Wi-Fi function.

[Wi-Fi Setup] cannot be changed when connected to Wi-Fi. (excluding [Network Address])

- For details on how to select the [Setup] menu settings, refer to (→54).

1 Select [Wi-Fi Setup] in the [Wi-Fi] menu

2 Use cursor button to select item, and press [MENU/SET]

| Item | Description |
|---|--|
| [Smart Transfer] | <ul style="list-style-type: none"> • For details (→238). |
| [LUMIX CLUB] Acquires or changes the "LUMIX CLUB" login ID. | <ul style="list-style-type: none"> • For details (→243). |
| [PC Connection] You can set the workgroup. | <p>You must connect to the same workgroup as the destination computer when sending pictures to the computer. (The default is set to "WORKGROUP")</p> <p>[Change Workgroup Name]: Enter the workgroup of the connecting computer.</p> <p>[Restore to Default]: Restore default settings.</p> <ul style="list-style-type: none"> • Refer to "Entering Text" (→114) for information on how to enter text. • To use with a computer of the standard settings, you do not have to change the workgroup. |
| [Device Name] You can change the name of this unit. | <ol style="list-style-type: none"> ① Press [DISP.] button ② Enter the desired device name <ul style="list-style-type: none"> • Refer to "Entering Text" (→114) for information on how to enter text. • Up to 32 characters can be entered for [A], [a], [1], and [&]. |
| [External AV device] Images can be sent to the AV device of relatives and acquaintances via "LUMIX CLUB". | <ul style="list-style-type: none"> • For details (→249). |
| [NFC Operation] Sets whether the NFC function is activated or not. | <p>[ON]</p> <p>[OFF] (The NFC function does not work even if smartphones are placed to the side of the unit)</p> |

- For details on how to select the [Setup] menu settings, refer to (→54).

| Item | Description |
|---|---|
| <p>[Wi-Fi Password] To prevent incorrect operation or use of the Wi-Fi function by a third party and to protect saved personal information, it is recommended that you protect the Wi-Fi function with a password.</p> | <p>Setting a password will automatically display the password input screen when the Wi-Fi function is used.</p> <p>[Setup]: Enter any 4-digit numbers as the password. Close the menu after changing settings.</p> <p>[Delete]: Confirmation screen is displayed. It is executed when [Yes] is selected. Exit the menu after it is executed.</p> <hr/> <ul style="list-style-type: none"> • For details on how to enter characters, refer to “Entering Text” (→114). • Make a copy of password. If you forget the password, you can reset it with [Reset Wi-Fi Settings] in the [Setup] menu, however other settings will also be reset. (excluding [LUMIX CLUB]) |
| <p>[Network Address] Displays the MAC address and IP address of this unit.</p> | <ul style="list-style-type: none"> • A “MAC Address” is a unique address that is used to identify network equipment. • “IP address” refers to a number that identifies a PC connected to a network such as the Internet. Usually, the addresses for homes are automatically assigned by the DHCP function such as a wireless access point. (Example: 192.168.0.87) |
| <p>[Approved Regulations]* The authentication number is displayed.</p> | <p>–</p> |

* [Approved Regulations] is only available on the version DMC-ZS30P

Viewing on TV screen

You can view pictures on a TV screen by connecting your camera to your TV with the HDMI micro cable (optional) or AV cable (optional).

- Also consult TV operating manual.

Preparation:

- Set [TV Aspect] to connect your camera to a TV using the AV cable (optional) (→64).
- Turn off both camera and TV.

1 Connect camera to TV

■ To connect with an HDMI micro cable (optional)

An HDMI micro cable (optional) can be used to enable viewing of still and motion pictures in high resolution.

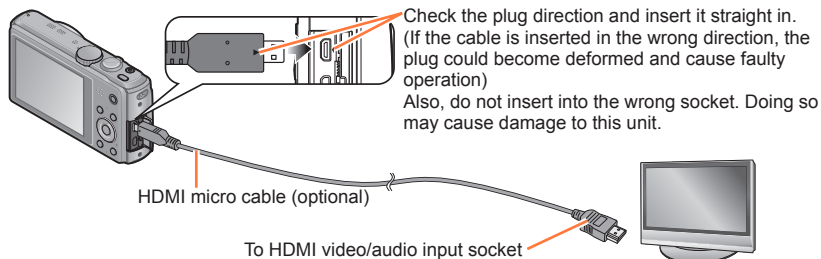

■ To connect with an AV cable (optional)

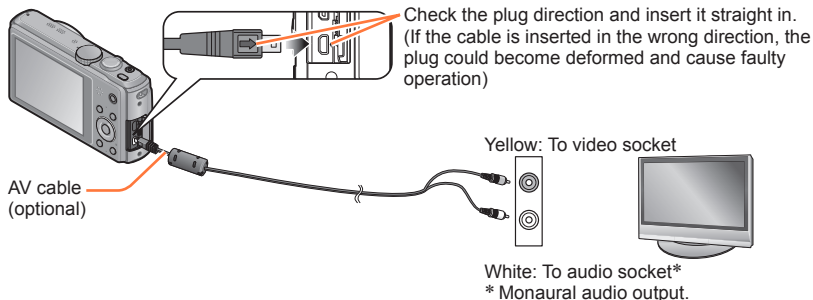

2 Turn on TV

- Set to auxiliary input.

3 Turn on the camera and press the playback button

- By holding down the Playback button while the camera is turned off, you can turn the camera on in Playback Mode.

■ To connect with an HDMI micro cable (optional)

- Always use a genuine Panasonic HDMI micro cable (optional).
- Some of the playback functions cannot be performed.
- The following menus cannot be used: [Setup], [Playback], [GPS] **DMC-ZS30**, [Map] **DMC-ZS30**, and [Wi-Fi].
- Bars may appear at the sides or at the top and bottom of the screen, depending on the aspect ratio setting.
- Cables that do not comply with HDMI standards will not work.
- When an HDMI micro cable is connected, pictures are not displayed on the LCD monitor.
- HDMI output will be canceled if a USB connection cable (supplied) is connected simultaneously.
- When the AV cable (optional) and HDMI micro cable (optional) are connected at the same time, no picture is output from the AV cable.
- Pictures may be momentarily distorted immediately after commencing playback or pausing on certain televisions.
- Audio output is stereo.

■ To connect with an AV cable (optional)

- Always use a genuine Panasonic AV cable (optional).
- Pictures rotated to portrait may be blurred slightly.
- Change picture mode settings on TV if aspect ratios are not displayed correctly on widescreen or high-definition televisions.

When you insert a card into the SD card slot in a television or a DVD recorder, you can play back recorded still pictures.

- AVCHD motion pictures can be played back on Panasonic televisions (VIERA) displaying the AVCHD logo.
- You may not be able to play back panorama pictures. Also you cannot perform automatic scrolling playback of panorama pictures.
- When using both SDHC and SDXC Memory Cards, be sure to play each type of card in equipment compatible with the particular format.

VIERA Link (HDMI) (HDAVI Control™)

What is VIERA Link (HDMI)?

- VIERA Link is a function that automatically links this camera to VIERA Link-compatible devices by connecting HDMI micro cables (optional) for enabling easy operation with the VIERA remote control. (Some operations are not available.)
- VIERA Link (HDMI) is an exclusive Panasonic function added to the industry-standard HDMI control functions known as HDMI CEC (Consumer Electronics Control). Operation is not guaranteed when connecting with non-Panasonic HDMI CEC-compatible devices. Refer to your product manual to verify compatibility with VIERA Link (HDMI).
- This camera supports VIERA Link (HDMI) Version 5. This is the Panasonic standard that also supports previous Panasonic VIERA Link devices.

- Always use a genuine Panasonic HDMI micro cable (optional).
- If you are unsure whether or not the TV you are using is compatible with VIERA Link, read the operating instructions for the TV.
- Cables that do not comply with HDMI standards will not work.
- If the [VIERA Link] setting on the camera is [ON], operations via the camera buttons will be limited.
- Ensure that the television you are connecting to has been set up to enable VIERA Link (HDMI) (consult your television operating instructions for details).

Preparation: Set [VIERA Link] to [ON] (→64).

- 1 Connect the camera to a VIERA Link (HDMI)-compatible Panasonic television (VIERA) with an HDMI micro cable (optional) (→253)**
- 2 Turn on the camera and press the playback button**
 - By holding down the Playback button while the camera is turned off, you can turn the camera on in Playback Mode.
- 3 Proceed with the operation while referring to what is displayed on the TV screen**
 - When operating, refer to the VIERA Link operating panel.

■ Other related operations

- Turning the unit OFF
The camera can also be turned off when the television is turned off with the remote control.
- Automatic input select
 - This function automatically switches the television input to the camera screen whenever the camera is turned on while it is connected via the HDMI micro cable. The television can also be switched on via the camera from Standby Mode (if "Power on link" on the television is set to "on").
 - If VIERA Link (HDMI) does not function correctly (→289)

- To display a map on the TV screen choose [Display map] from the menu by remote control. (Option available only with VIERA Link (HDMI)) **DMC-ZS30**

Viewing 3D still pictures

If you connect this camera to a 3D-capable TV, and play back still pictures that you recorded in 3D, you can enjoy impressive 3D still pictures on the TV. If a 3D-capable TV has an SD card slot, you can play back 3D still pictures that you recorded by inserting the card into the slot.

For the latest information about devices that can play back 3D still pictures recorded with this camera, please refer to the following support website.
<http://panasonic.jp/support/global/cs/dsc/> (This site is available in English only.)

Preparation: Set [3D Playback] to [3D] (→65).

1 **Connect the camera to a 3D-capable TV by use of an HDMI micro cable (optional) to display the playback screen** (→253)

2 **Display still pictures recorded in 3D**

- When the [VIERA Link] setting on the camera is set to [ON] and the camera is connected to a VIERA Link (HDMI)-compatible Panasonic television (VIERA), the television automatically switches its input and the playback screen is displayed.
- [3D] appears on the thumbnail of the 3D still pictures.

■ **To perform Slide Show playback of only still pictures recorded in 3D**

Select [3D Play] in [Slide Show] of the [Playback Mode] menu (→138)

■ **To select and play back only still pictures recorded in 3D**

Select [3D Play] in [Filtering Play] of the [Playback Mode] menu (→133)

■ To switch the playback method for the still pictures recorded in 3D

- ① Select the picture recorded in 3D
 - ② Select [2D/3D Settings] on the [Playback Mode] menu and then press [MENU/SET] (→132)
- Playback method will switch to 3D if it is playing back in 2D (conventional image), or it will switch to 2D if it is playing back in 3D.
 - If you feel tired, uncomfortable or otherwise strange when playing back pictures recorded in 3D, set to 2D.

- On the LCD monitor of this camera, 3D still pictures will be played back in 2D (conventional pictures).
- If you switch between 3D still pictures and normal still pictures while playing back pictures, a black screen will be displayed for a few seconds.
- If you select a thumbnail of 3D still pictures or display a thumbnail after playing back 3D still pictures, it may take a few seconds to start playing back or displaying the pictures.
- Viewing 3D still pictures too close to a TV may cause eyestrain.
- When a TV has not been converted for viewing 3D still pictures, do necessary preparation on the TV. (For details about the necessary preparation of the TV, read the manual for the TV.)
- When an image is not suitable for 3D viewing (due to excessive parallax, etc.)
 - During Slide Show playback: The image is displayed in 2D.
 - During [Filtering Play]: A message appears confirming whether to display the image in 3D or not.
- When a 3D image is played back on a TV that is not 3D-capable, 2 pictures may appear side-by-side on the screen.
- During 3D playback, the [Wi-Fi] menu, [Setup] menu, [Playback] menu, [GPS] menu **DMC-ZS30**, [Map] menu **DMC-ZS30**, Playback Zoom, and delete operation cannot be used.
- You can store 3D still pictures on a computer or Panasonic recorder. (→259)

Keeping the still pictures and motion pictures in the recorder

The methods for copying still and motion pictures recorded with this camera to other devices vary according to the file format (JPEG, MPO, AVCHD, MP4). Follow the correct method for your device.

Copy by inserting the SD card into the recorder

You can copy pictures using Panasonic equipment (such as Blu-ray disc recorders) with support for each file format. Check the latest information about equipment that is compatible with this camera on the following website.

- Note that the equipment described may not be available in certain countries and regions.

<http://panasonic.jp/support/global/cs/dsc/> (This site is available in English only.)

- See the instruction manual for the recorder for details for copying and playing back.

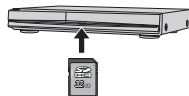

Dubbing playback pictures via AV cables (optional)

Videos that are played on this camera can be dubbed on media such as a disc, hard disk or videotape using a device such as a video recorder. This method is useful as it allows dubbing to be performed even with devices that are not compatible with high definition images. Picture quality will be reduced from high definition to standard definition. Audio will be monaural.

1 Connect camera to recorder

2 Start playback on camera

3 Start recording on recorder

- To stop recording (dubbing), stop the recording on your recorder first before stopping the playback on the camera.

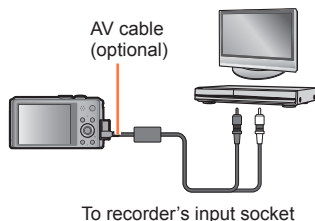

- Always use a genuine Panasonic AV cable (optional).
- When using a TV with a 4:3 aspect ratio, always change the camera's [TV Aspect] setting (→64) to [4:3] before dubbing. Motion pictures copied in the [16:9] setting will appear vertically stretched when viewed on a 4:3 TV screen.
- For details on dubbing and playback methods, refer to your recorder's operating instructions.

Keeping the still pictures and motion pictures on your PC

Still/motion pictures can be copied from the camera to your computer by connecting the two together.

- Some computers can read directly from the camera's memory card.
For details, see the manual for your computer.
- If your computer does not support SDXC Memory Cards a message will be displayed requesting you to format the card. (Do not format the card. This will erase recorded pictures.) If the card is not recognized, refer to the following support website.
<http://panasonic.net/avc/sdcard/information/SDXC.html>

■ Computer specifications

You can connect the camera to a computer that can detect a mass storage device (device that stores a large volume of data).

- Windows: Windows 8 / Windows 7 / Windows Vista / Windows XP
- Mac: OS X v10.1 - v10.8

Some motion pictures recorded in [AVCHD] may not be scanned correctly by copying a file or folder.

- When using Windows, be sure to use the "PHOTOfunSTUDIO" software on the supplied disc to copy motion pictures recorded in [AVCHD].
- When using Mac, you can copy motion pictures recorded in [AVCHD] using "iMovie '11". Note, however, that you cannot copy AVCHD Progressive motion pictures (recorded with [60p] in [FHD]).
(For details about iMovie '11, please contact Apple Inc.)

About supplied softwares

The following softwares are provided on the disc (supplied).
Install the software on your computer before using.

- To read the supplied DVD, use a DVD drive with single-sided dual layer support.

DMC-ZS30

■ PHOTOfunSTUDIO 9.1 PE

You can capture still pictures or motion pictures to your PC, or organize captured pictures by categorizing by recording date, model name of the digital camera used to record, etc. You can also correct still pictures, edit motion pictures, or write to DVD.

• Operating environment

| | | |
|----------------------|---|---|
| Supported OS | Windows® XP (32-bit) SP3 Windows Vista® (32-bit) SP2 Windows® 7 (32-bit/64-bit) and SP1 Windows® 8 (32-bit/64-bit) | |
| CPU | Windows® XP | Pentium® III 500 MHz or higher |
| | Windows Vista® | Pentium® III 800 MHz or higher |
| | Windows® 7 | Pentium® III 1 GHz or higher |
| | Windows® 8 | |
| Display | 1024×768 pixels or more (1920×1080 pixels or more recommended) | |
| RAM | Windows® XP | 512 MB or more |
| | Windows Vista® | |
| | Windows® 7 | 1 GB or more (32-bit) / 2 GB or more (64-bit) |
| | Windows® 8 | |
| Free hard disk space | 450 MB or more for installing software | |

Refer to the Operating Instructions of "PHOTOfunSTUDIO" (PDF) for further information about the operating environment.

■ LUMIX Map Tool 1.1 **DMC-ZS30**

You can copy the map data recorded on the disc (supplied) to your card. If map data is copied to the card, you can display a detailed map with this unit.

- For information about using it (→179)

• Operating environment

| | |
|---------------------|---|
| Supported OS | Windows® XP (32-bit) SP3 Windows Vista® (32-bit) SP2 Windows® 7 (32-bit, 64-bit) and SP1 Windows® 8 (32-bit/64-bit) Mac® OS X v10.4, v10.5, v10.6, v10.7, and v10.8 |
|---------------------|---|

■ LoiLoScope 30 day full trial version (Windows XP / Vista / 7 / 8)

LoiLoScope is a video editing software that draws out the full power of your PC. Creating videos is as easy as organizing cards on top of a desk. Use your music, picture and video files to create videos to share with your friends and family by burning it to a DVD, uploading it to websites, or simply share your videos with your friends via e-mail.

- This will only install a shortcut to the trial version download site.

For more information on how to use LoiLoScope, read the LoiLoScope manual available for download at the link below.
Manual URL: <http://loilo.tv/product/20>

Installing supplied software

The software compatible with your PC will be installed.

Preparation:

- Check your PC's specifications and operating environment for each software.
- Before inserting disc (supplied), please terminate all other application programs that are running.

■Windows:

1 Insert the disc

- The installation menu runs.

2 Click [Applications]

3 Click [Recommended Installation]

- Continue the installation procedure following the instructions displayed on the screen.

DMC-ZS30

■Mac:

1 Insert the disc

2 Double-click the recognized disc to open

3 Double-click the [Application] folder to open

4 Double-click the [MAPTOOL] folder to open

5 Double-click [LUMIX Map Tool.pkg]

- Continue the installation procedure following the instructions displayed on the screen.

Copying still pictures and motion pictures

Preparation:

- When importing pictures from the built-in memory, remove any memory cards.
- Install "PHOTOfunSTUDIO" on your computer before starting the copying procedure. (→263)
- Turn on the camera and computer.

Check socket direction and insert straight in.
(If the cable is inserted in the wrong direction, the socket could become deformed and cause faulty operation)
Also, do not insert into the wrong socket. Doing so may cause damage to this unit.

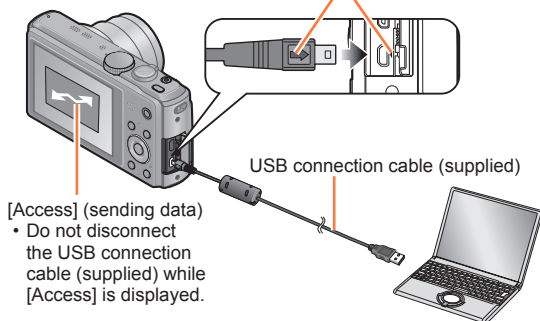
**1 Connect camera to computer**

- Do not use any other USB connection cables except the supplied one or a genuine Panasonic USB connection cable (optional).
Using cables other than the above may cause a malfunction.

2 Use cursor button on the camera to select [PC], and press [MENU/SET]

- When [USB Mode] (→64) is set to [GPS assist data], the folder storing the pictures will not be displayed. Set [USB Mode] to [PC]. **DMC-ZS30**

3 Use "PHOTOfunSTUDIO" to copy pictures to your computer

- For details on how to use "PHOTOfunSTUDIO", see the "PHOTOfunSTUDIO" manual (PDF).

- Files and folders containing copied AVCHD motion pictures cannot be played back or edited if they have been deleted, modified, or moved using Windows Explorer or similar methods. Always use "PHOTOfunSTUDIO" when handling AVCHD motion pictures.

To cancel connection

- Windows: Execute "Safely Remove Hardware" on the taskbar
- Mac: Open the Finder and click the eject icon that appears on the sidebar

■ Copying to your computer without using “PHOTOfunSTUDIO” (except AVCHD motion pictures)

You can save pictures to use on your computer by dragging and dropping folders and files into separate folders on your computer.

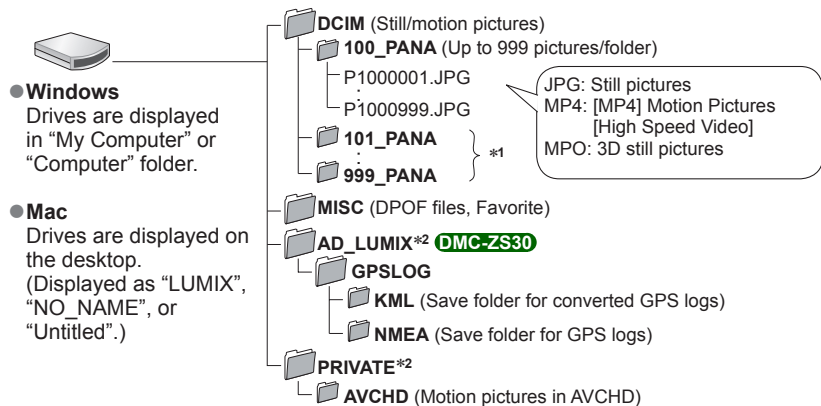

*1 New folders are created in the following cases:

- When the number of files in a folder exceeds 999.
- When using cards already containing the same folder number (for example, pictures taken with other cameras, etc.).
- When recording after performing [No.Reset].

*2 This folder is not created in the built-in memory.

- Turn off the camera before inserting or removing memory cards.
- When the battery begins to run out during communication, a warning beep sounds. Cancel communication via your computer immediately.
- Setting the [USB Mode] to [PC] removes the need to make the setting each time the camera is connected to the computer.
- For more details, consult your computer operating manual.

■ For PTP mode

The camera can be connected to your computer even if [USB Mode] (→64) is set to [PictBridge(PTP)].

- Only picture output can be performed.
- If you cannot connect to your PC in PTP mode, set [USB Mode] to [PC] and reconnect.
- It may not be possible to import if there are 1000 or more pictures on the card.
- Motion pictures or 3D still pictures cannot be read.

Printing

You can connect directly to a PictBridge-compatible printer for printing.

- Some printers can print directly from the camera's memory card.
For details, see the manual for your printer.

Preparation:

- When printing pictures from the built-in memory, remove any memory cards.
- Adjust the print quality or other settings on your printer, as needed.
- Turn on the camera and printer.

Check the plug direction and insert it straight in. (If the cable is inserted in the wrong direction, the plug could become deformed and cause faulty operation)
Also, do not insert into the wrong socket. Doing so may cause damage to this unit.

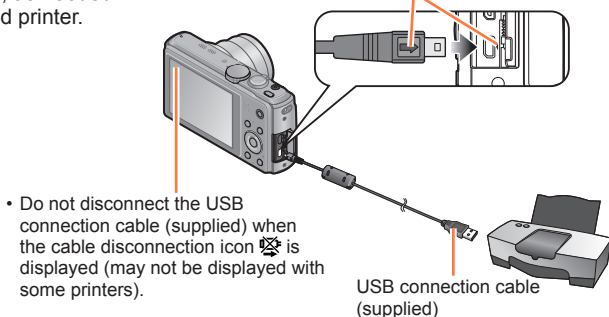

1 Connect camera to printer

- Do not use any other USB connection cables except the supplied one or a genuine Panasonic USB connection cable (optional).
Using cables other than the above may cause a malfunction.

2 Use cursor button on the camera to select [PictBridge(PTP)], and press [MENU/SET]

3 Use cursor button to select a picture to print and press [MENU/SET]

4 Use cursor button to select [Print start] and press [MENU/SET] (Print settings (→270))

■ **To cancel print** Press [MENU/SET].

- Disconnect USB connection cable (supplied) after printing.
- Turn off the camera before inserting or removing memory cards.
- When the battery begins to run out during communication, a warning beep sounds. Cancel printing and disconnect USB connection cable (supplied).
- Motion pictures cannot be printed.

Printing multiple pictures

1 Use cursor button to select **[Multi Print]** in step **3** (→267)**2** Use cursor button to select item and press **[MENU/SET]**

- **[Multi Select]:**
 - ① Scroll between pictures with cursor button, select pictures to print with the [DISP.] button. (Press [DISP.] button again to release selection.)
 - ② Press [MENU/SET] when selection is complete.
- **[Select All]:** Print all pictures.
- **[Print Set (DPOF)]:** Print pictures selected in [Print Set]. (→154)
- **[Favorite]:** Print pictures selected as [Favorite]. (→153)

3 Use cursor button to select **[Print start]** and press **[MENU/SET]**

(Print settings (→270))

- Select [Yes] if print confirmation screen is displayed.

- An orange “●” displayed during printing indicates an error message.
- Print may be divided into several pictures if printing a large amount of pictures. (Remaining sheets display may differ from the number of pictures set for printing.)

Print with date and text







■ Printing date without **[Text Stamp]**

- Printing in store: Only recording date can be printed. Request date printing in store.
 - Making [Print Set] (→154) settings on the camera in advance allows settings for numbers of copies and date printing to be designated before giving the card to the store.
 - When printing still pictures of 16:9 Aspect Ratio, check in advance that the store can accept this size.
 - Using computer: Print settings for recording date and text information can be made using “PHOTOfunSTUDIO” on the supplied disc.
 - Using printer: Recording date can be printed by setting [Print Set] on the camera, or by setting [Print with Date] (→270) to [ON] when connecting to a printer compatible with date printing.
- Time and date can be set to be printed on the picture when taking the picture by activating the [Date Stamp] function in the [Rec] menu. (→125)



Making print settings on the camera

Setting options include the number of printed pictures and their size. Make settings before selecting [Print start].

1 Use cursor button to select the item and press [MENU/SET]

| Item | Settings |
|-------------------|--|
| [Print with Date] | [ON] / [OFF] |
| [Num.of prints] | Set number of pictures (up to 999 pictures) |
| [Paper Size] | When  is selected, the printer settings take priority. |
| [Page Layout] |  (printer takes priority) /  (1 picture, no border) /  (1 picture, with border) /  (2 pictures) /  (4 pictures) |

2 Use cursor button to select setting and press [MENU/SET]

- Items may not be displayed if incompatible with printer.
- To arrange  "2 pictures" or  "4 pictures" in the same still picture, set the number of prints for the still picture to 2 or 4.
- To print to paper sizes/layouts not supported by this camera, set to  and make settings on the printer. (Consult your printer's operating manual.)
- Even with completed [Print Set] settings, dates may not be printed, depending on the shop or printer used.
- When setting [Print with Date] to [ON], check the date printing settings on the printer (printer settings may be prioritized).
- To print a picture on which text or a date has been stamped, set [Print with Date] to [OFF]. (The still picture is printed with the date superimposed on it.)

Using the AC adaptor (optional) and DC coupler (optional) instead of the battery

By using the AC adaptor (optional) and DC coupler (optional), you can record and play back without worrying about the remaining battery charge.

The optional DC coupler can only be used with the designated Panasonic AC adaptor.

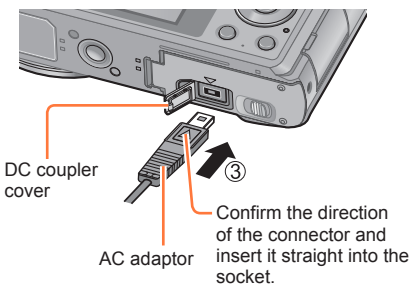
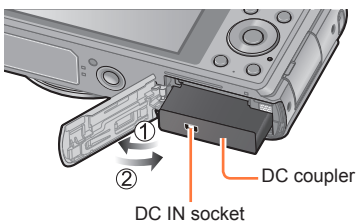

1 Insert DC coupler instead of battery

2 Open DC coupler cover

- If difficult to open, with the card/battery door open, press the DC coupler cover from the inside to open it.

3 Close the door and slide the release lever to the [LOCK] position

4 Plug AC adaptor into power outlet

5 Connect AC adaptor to DC IN socket of DC coupler



- Always use a genuine Panasonic AC adaptor (optional).
- Use the AC adaptor and DC coupler specifically for this camera. Using other adaptors or couplers could cause camera failure.
- It may not be possible to install camera on a tripod or unipod when the DC coupler is connected, depending on the type of tripod or unipod.
- The camera cannot be stood up when the AC adaptor is connected. If you are leaving the camera on a surface as you work, it is recommended to set it on a soft cloth.
- When the AC adaptor is connected, always remove the AC adaptor when opening the card/battery door.
- Remove the AC adaptor and DC coupler when not in use and close the DC coupler cover.
- Also read the AC adaptor and DC coupler operating instructions.





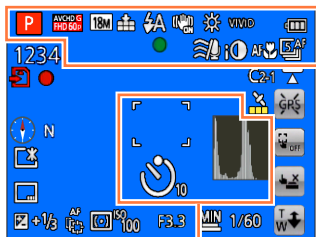













List of LCD monitor displays

Screens shown here are only examples. The actual display may vary.

In recording



| | |
|--|------------------------------------|
|  | AF area (→31) |
|  | Self-timer (→79) |
|  | Histogram (→60) |

| | |
|---|--|
|  | Recording Mode (→28) |
|  | Backlight Compensation (→35, 37) |
|  | Rec Format (→126) |
|  | Rec Quality (→126) |
|  | Picture Size (→115) |
|  | Quality (→116) |
|  | Flash Mode (→74) |
|  | Stabilizer (→125) |
|  | Motion Deblur (→36) |
|  | Jitter alert (→30) |
|  | White Balance (→117) |
| SEPIA | Color Mode (→123) |
|  | Creative control adjustment display |
|  | Battery capacity (→20) |
|  | Focus (→31) |
|  | Wind cut (→128) |
|  | Intelligent exposure (→121) |
|  | Macro recording (→76) |
|  | Burst Mode (→106) |
|  | Auto Bracket (→81) |

List of LCD monitor displays

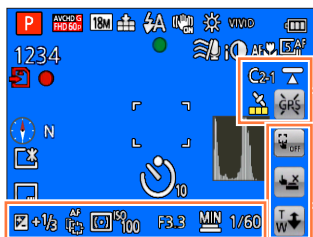

| | |
|--|------------------------------|
| | Exposure Compensation (→80) |
| | AF Tracking (→38, 119) |
| | AF Assist Lamp (→123) |
| | Metering Mode (→121) |
| | ISO Sensitivity (→116) |
| | Aperture value (→30, 82, 84) |
| | Shutter speed (→30, 82, 84) |
| | Minimum shutter speed (→122) |

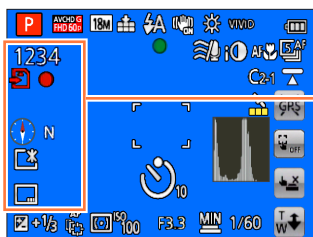

| | |
|--|--|
| | Custom Set (→105) |
| | Level Shot function (→128) DMC-ZS30 |
| | GPS reception icon (→160) DMC-ZS30 |
| | Updating GPS positioning (→160) DMC-ZS30 |

| | |
|--|---|
| | Release the touch AF/AE function (→33) Release AF Tracking (→38) |
| | Switch touch shutter ON/OFF (→32) |
| | Touch zoom (→71) |

| | |
|---------|-------------------------------------|
| 1234 | Number of recordable pictures (→24) |
| R29m59s | Remaining recording time* (→40) |
| | Recording state |
| | Save destination (→23) |
| | Compass (→185) DMC-ZS30 |
| | Monitor Luminance (→59) |
| 1m23s | Elapsed recording time* (→40) |
| | Date Stamp (→125) |
| | Monitor Power Save (→62) |

* XXhXXmXXs, RXXhXXmXXs
[h], [m] and [s] indicate "hour", "minute" and "second".

| |
|---|
| Current date/time World time (→113) |
| Name* (→99) Age in years/months* (→99, 108) |
| Place name information* (→165) DMC-ZS30 |
| Changing the GPS place name (→165)  DMC-ZS30 |
| Destination settings* (→112) Travel elapsed days* (→112) |

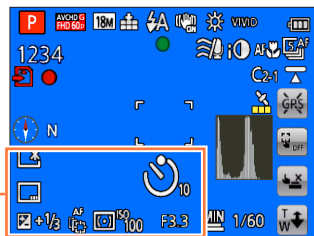

| |
|-------------------|
| Focus range (→78) |
| Zoom (→70) |



- * The displaying is performed in the following priority order: location name information, travel destination, name ([Baby]/[Pet]), and name ([Face Recog.]). When the place name information or the number of days elapsed from day of departure are displayed, age in years/months is not displayed. **DMC-ZS30**
- * The displaying is performed in the following priority order: travel destination, name ([Baby]/[Pet]), and name ([Face Recog.]). When the number of days elapsed from day of departure is displayed, age in years/months is not displayed. **DMC-ZS27**

Screens shown here are only examples. The actual display may vary.

In playback



| | |
|--|---------------------------------------|
| | Playback Mode (→132) |
| | Protected picture (→155) |
| | Favorites (→153) |
| | Date/text stamped display (→125, 147) |
| | Color Mode (→123) |
| | Retouched picture (→141, 142) |
| | Picture Size (→115) |
| | Quality (→116) |
| | Battery capacity (→20) |

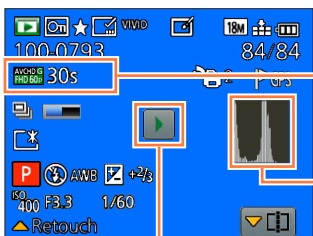

| | |
|--|---|
| | Rec Format (→126) Rec Quality (→126) |
| | 1m23s Motion picture recording time* (→49) |
| | Number of burst pictures (→130) |

| | |
|--|-----------------|
| | Histogram (→60) |
|--|-----------------|

| | |
|--|-------------------------------|
| | Motion picture playback (→49) |
| | Panorama playback (→94) |
| | Burst playback (→130) |

* XXhXXmXXs
[h], [m] and [s] indicate "hour", "minute" and "second".

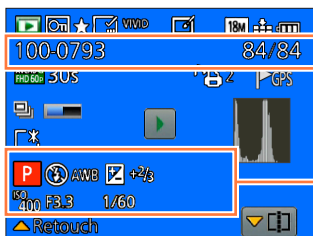

Folder/File number (→45, 265)

Picture number/Total pictures (→45)

Recording date/time

World time (→113)

Name* (→99)

Age in years/months* (→99)

Place name information* (→165) **DMC-ZS30**

Title* (→146)

Destination settings* (→112)

Travel elapsed days* (→112)



Print settings (→154)

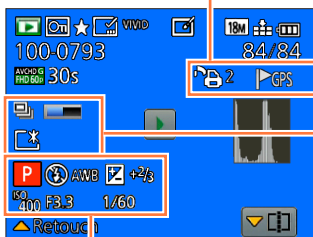

GPS With location information (→161)

With place name information (→161) **DMC-ZS30**

Acquiring information icon (→130)



Monitor Luminance (→59)



Recording Mode (→28)



Flash Mode (→74)



White Balance (→117)



Exposure Compensation (→80)



ISO Sensitivity (→116)



Aperture value (→30, 82, 84)



Shutter speed (→30, 82, 84)



Creative control adjustment display

* The displaying is performed in the following priority order: location name information, title, travel destination, name ([Baby]/[Pet]), and name ([Face Recog.]). When the place name information or the number of days elapsed from day of departure are displayed, age in years/months is not displayed. **DMC-ZS30**

* The displaying is performed in the following priority order: title, travel destination, name ([Baby]/[Pet]), and name ([Face Recog.]). When the number of days elapsed from day of departure is displayed, age in years/months is not displayed. **DMC-ZS27**

Message displays

Meanings of and required responses to major messages displayed on LCD monitor.

[This memory card cannot be used]

- Not compatible with the camera. Use a compatible card.

[Some pictures cannot be deleted] [This picture cannot be deleted]

- Non-DCF pictures (→45) cannot be deleted.
→ Save needed data on a computer or other device, and then use [Format] on the camera. (→66)

[No additional selections can be made]

- The number of pictures that can be deleted at once has been exceeded.
- More than 999 pictures have been set as [Favorite].
- The number of pictures allowing [Title Edit], [Text Stamp] or [Resize] (multiple settings) at once has been exceeded.

[Cannot be set on this picture]

- [Print Set], [Title Edit], or [Text Stamp] cannot be made for non-DCF pictures (→45).

[Please turn camera off and then on again] [System Error]

- The lens is not working correctly.
→ Turn the camera on again.
(Consult the dealer or your nearest Service Center if display still remains)

[Some pictures cannot be copied] [Copy could not be completed]

- Pictures cannot be copied in following cases.
→ Picture of same name already exists in built-in memory when copying from card.
→ File is not of DCF standard (→45).
→ Picture taken or edited on a different device.

[Not enough space on built-in memory] [Not enough memory on the card]

- There is no space left on the built-in memory or the card. When you copy pictures from the built-in memory to the card (batch copy), the pictures are copied until the capacity of the card becomes full.

[Built-In Memory Error] [Format built-in memory?]

- Displayed when formatting built-in memory via computer, etc.
→ Reformat directly using camera. Data will be deleted.

[Memory card error. This card cannot be used in this camera. Format this card?]

- The card format cannot be used with this camera.
→ Save needed data on a computer or other device, and then use [Format] on the camera. (→66)

[Insert SD card again] [Try another card]

- Access to card has failed.
→ Insert card again.
- Try with a different card.

[Memory card parameter error]

- Card is not of SD standard.
- When cards in capacities of 4 GB or more are used, only SDHC or SDXC Memory Cards are supported.

[Read Error] / [Write Error] [Please check the card]

- Data read has failed.
→ Check whether card has been inserted correctly (→22).
- Data write has failed.
→ Turn off the camera and remove the card. Reinsert the card and turn the camera on again.
- Card may possibly be damaged.
- Try with a different card.

[Cannot record due to incompatible format(NTSC/PAL) data on this card.]

- Format the card after saving necessary data on a PC etc. (→66)
- Insert a different card.

[Motion recording was cancelled due to the limitation of the writing speed of the card]

- If recording stops even when using a card of the recommended speed class (→23), the data writing speed has dropped. If this happens, we recommend backing up the data on the memory card and formatting it (→66).
- Motion picture recording may be automatically terminated with certain cards.

[A folder cannot be created]

- Folder numbers in use have reached 999.
→ Save needed data on a computer or other device, and then use [Format] on the camera. (→66)
Folder number is reset to 100 when performing [No.Reset] (→63).

[Picture is displayed for 16:9 TV] [Picture is displayed for 4:3 TV]

- AV cable (optional) is connected to camera.
→ To remove message immediately → Press [MENU/SET].
→ To change aspect ratio → Change [TV Aspect] (→64).
- USB connection cable (supplied) is only connected to camera.
→ Message disappears when cable is also connected to another device.

[This battery cannot be used]

- Use a genuine Panasonic battery.
- Battery cannot be recognized as terminal is dirty.
→ Wipe any dirt away from the battery terminal.

[GPS feature is not available in this region.] **DMC-ZS30**

- GPS may not work in China or in the border regions of countries neighboring China. (Current as of January 2013)

[Recording failed.]

- Recording may be impossible if the recording location for a 3D image is too dark/too bright, or if the subject lacks contrast.

[Failed to connect wireless access point] / [Connection failed] / [No destination found]

- Check following regarding the wireless access point.
 - The wireless access point information set on this unit is wrong. Check the authentication type, encryption type, and encryption key. (→206)
 - Power of the wireless access point is not turned on.
 - Setting of the wireless access point is not supported by this unit.
- Check the network setting of the destination.
- Radio waves from other devices may block the connection to a wireless access point. Check other devices that are connected to the wireless access point and devices that use the 2.4 GHz band.

[No picture to send]

- This is displayed when there is no image to transmit due to the restriction of the destination. Check the file type of the image to transmit. (→192)

[Connection failed. Please retry in a few minutes.] / [Network disconnected. Transfer stopped.]

- Radio waves from the wireless access point are getting weak. Perform the connection closer to the wireless access point.
- There is no reply from the server or it has exceeded the communication processing time. Try again after a while.
- Depending on the wireless access point, connection may be automatically disconnected after specific time has passed. Reconnect the connection again.

[Upload to the Cloud Folder is available after Cloud Sync settings have been set up on downloadable devices such as PCs or smartphones.]

- Devices that download images from a cloud folder are not registered.
- Perform Cloud Sync setting. Configure the settings on a PC with "PHOTOfunSTUDIO" or on a smartphone/tablet with "Image App". For details on [Cloud Sync. Service], refer to (→229).

[Connection failed]

- Check following regarding the smartphones/tablet you intend to connect.
 - The smartphone/tablet does not operate.
 - Change the access point to connect to in the smartphone/tablet Wi-Fi settings to this camera.
 - There is no free storage space on the smartphone/tablet.

[Login failed. Please check Login ID and Password.]

- Login ID or password for the "LUMIX CLUB" is not correct. Please enter it again. If you have forgotten the login ID or the password, there is information in the login screen of the "LUMIX CLUB" website.

[Some files cannot be sent because of destination limit] / [Transfer completed. Some files are left because of destination limit.]

- Check the file format of the image to send.
- Sending motion pictures may fail if the file size is too large. Split the motion picture using [Video Divide]. (→149)

[Unavailable. Please set Login settings on LUMIX CLUB web site.]

- Login to the "LUMIX CLUB" from your smartphone/tablet or PC, and set the login details of the destination WEB service.

[Both picture and video sharing service cannot be selected together]

- WEB services designed only for pictures, and WEB services designed only for motion pictures cannot be selected at the same time. Deselect one of the services.

[Cannot get IP address. Please set wireless AP's IP address setting to DHCP.]

- Turn on DHCP settings of the IP address of the connected wireless access points.

[Cannot connect to server]

- If a message is displaying asking to update the root certificate, agree to update the root certificate.

Q&A Troubleshooting

Try checking these items (→281 - 291) first.

If the problem persists, performing [Reset] in the [Setup] menu may resolve the issue (→63). (Note that except for some items such as [Clock Set], all settings are returned to their values at the time of purchase.)

Battery, power

The charging lamp turns off before the battery is fully charged.

- Charging is being performed in a place with extremely high or low temperature.
 - Reconnect the USB connection cable (supplied) and retry charging in a place where ambient temperature is 10 °C to 30 °C (50 °F to 86 °F) (temperature conditions also apply to the battery itself).
 - (When the USB connection cable is reconnected after the battery is fully charged, the charging lamp will light for approximately 15 seconds.)

The charging lamp turns on again after it had turned off. **DMC-ZS30**

- The battery is being recharged.
 - If the battery charge level is low when the camera is turned off and [GPS Setting] is set to [ON], battery recharging may be started automatically.

Camera does not work even if the camera is turned on.

- Battery is not inserted correctly (→17), or needs recharging.

Camera switches off as soon as the camera is turned on.

- Battery needs recharging.

This unit is turned off automatically.

- If you connect to a TV compatible with VIERA Link (HDMI) with an HDMI micro cable (optional) and turn off the TV with the remote control for the TV, this unit also turns off.
 - If you are not using VIERA Link (HDMI), set [VIERA Link] to [OFF]. (→64)

GPS **DMC-ZS30**

Cannot perform positioning.

- When [GPS Setting] is set to [OFF]. (→159)
- Depending on the recording environment, such as when indoors or near buildings, it may not be possible to correctly receive the signals from the GPS satellites. (→158)
 - When using the GPS, we recommend holding the camera still for a while with the Built-in GPS antenna facing upward in an outdoor location where you can see the entire sky.

The GPS status indicator lights up while the camera is turned off.

- [GPS Setting] is [ON].
 - Electromagnetic waves from the camera can affect instruments and meters. In airplane cabins (during takeoff and landing) or in other restricted areas, set [Airplane Mode] to [ON], and then turn off the camera.

GPS (continued) DMC-ZS30**Positioning takes time.**

- When using the camera for the first time or after not using it for a while, positioning may take several minutes.
- Positioning usually takes less than two minutes, but because the positions of the GPS satellites change, it may take longer depending on the recording location and environment.
→ Positioning can be executed faster when you download GPS assist data to the camera using the "GPS Assist Tool". (→169)
- Positioning will take time in environments where it is difficult to receive the signals from the GPS satellites. (→158)

The location name information is different from the recording location.

- Immediately after the camera is turned on or when the GPS icon is something other than GPS_3 , the location name information that is recorded in the camera may vary significantly from the current position.
- When  is displayed for the location name information, the information can be changed to a different candidate before starting to record. (→165)
You can edit a place name or landmark name recorded in a picture.

The location name information is not displayed.

- "- -" is displayed if there is no nearby landmark or other points, or no information registered in the camera's database. (→161)
→ During playback, a location name or other information can be entered with [Edit Place Name]. (→167)

Map DMC-ZS30**Cannot display detailed maps.**

- Use the "LUMIX Map Tool" software on the disc (supplied) to copy map data from the disc. (→179)

Some place names are not displayed.

- Detailed maps are displayed when you copy map data from the disc (supplied). (→179)
(Note, however, that not all place names are stored in the disc.)
- Place names may not be displayed for some map scale settings.
→ Enlarge the map scale.

It takes time to copy the map data.

- Since the map data size is large, it may take time to copy the map data. We recommend copying the map data of a required area only.
- When you copy map data by connecting the camera to the computer, it may take longer than the time required for copying the data using the commercially available card reader/writer.

Recording

Cannot record pictures.

- Built-in memory/card is full. → Free space by deleting unwanted pictures (→52).

Recorded pictures look white.

- Lens is dirty (fingerprints, etc.).
→ Turn the camera on to extract lens barrel, and clean lens surface with a soft, dry cloth.
- Lens is foggy (→8).

Recorded pictures are too bright/too dark.

- **Adjust the exposure** (→80).
- **[Min. Shtr Speed] is set to fast speed. Check the setting** (→122).

Some pictures are taken when I press the shutter button just once.

- Camera is set to use [Auto Bracket] or [Burst].

Focus not aligned correctly.

- Not set to mode appropriate for distance to subject. (Focus range varies according to recording mode.)
- Subject outside of focus range. (→78)
- Caused by jitter or subject movement. (→30)

Recorded pictures are blurred. The stabilizer function ineffective.

- Shutter speed is slower in dark locations and the stabilizer function is less effective.
→ Hold camera firmly with both hands, keeping arms close to body.
- Use a tripod and the self-timer (→79) when using slower shutter speed with [Min. Shtr Speed].

Cannot use [Auto Bracket].

- Only enough memory for 2 pictures or fewer.

Recorded pictures appear coarse, or there is interference.

- ISO Sensitivity is high, or shutter speed is low.
(Default [Sensitivity] setting is [AUTO] – interference may appear with indoor pictures.)
→ Lower [Sensitivity] (→116).
→ Take pictures in brighter locations.
- Camera set to [High Sens.] Scene mode.
(Picture becomes slightly coarser in response to high sensitivity)

Striping or flicker may appear under lighting such as fluorescent lighting and LED lighting fixture.

- This is characteristic of MOS sensors which serve as the camera's pickup sensors.
This is not a malfunction.

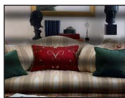

Brightness or coloring of recorded picture different from real life.

- When recording under fluorescent or LED lighting fixture etc., increasing the shutter speed may introduce slight changes to brightness and color. These are a result of the characteristics of the light source and do not indicate a malfunction.
- When recording subjects in extremely bright locations or recording under fluorescent lighting, LED lighting fixture, mercury lamp, sodium lighting etc., the colors and screen brightness may change or horizontal striping may appear on the screen.

Recording (continued)

Reddish horizontal streaks appear on the LCD monitor during recording.

- This is characteristic of MOS sensors which serve as the camera's pickup sensors. It appears when the subject has a bright part. Some unevenness may occur in the surrounding areas, but this is not a malfunction. It is recorded in motion pictures but is not recorded on still pictures.
- It is recommended that you take pictures while taking care not to expose the screen to sunlight or any other source of strong light.

Motion picture recording stops midway.

- If the surrounding temperature is high, or a motion picture is recorded continuously,  is displayed and recording may be stopped halfway through to protect the camera.
- With some cards, access display may appear briefly after recording, and recording may end midway.
- Use a card of SD Speed "Class 4" or higher. If recording stops even when using a card of the recommended speed class, the data writing speed has dropped. If this happens, we recommend backing up the data on the memory card and formatting it (→66).

Panorama picture recording stops before finishing.

- If the pan motion of the camera is too slow, the camera assumes that the operation has been aborted and stops recording.
- If the pan motion of the camera is too shaky when it is moved toward the recording direction, the camera stops recording.
→ To record panorama pictures, pan the camera in a small circular motion parallel to the recording direction at a speed of approx. 8 seconds per revolution (guideline).

The subject cannot be locked. (AF track fails)

- If the color of the subject is similar to that of its background, AF Tracking may not function. Set the AF area to those colors specific to the subject by aligning that area with the AF area.

LCD monitor

Brightness is unstable.

- Aperture value is set while shutter button is pressed halfway. (Does not affect recorded picture.) This symptom may also occur when the brightness changes because the zoom is operated or the camera is moved. This is the automatic aperture operation of the camera and is not a malfunction.

Monitor flickers indoors.

- The LCD monitor may flicker for a few seconds after turning on. This is an operation to correct flicker caused by lighting such as fluorescent lights, LED lights etc. and is not a malfunction.

Monitor is too bright/too dark.



- [Monitor Luminance] is activated (→59)
- Use [Monitor Display] to adjust the brightness of the LCD monitor. (→59)

Black/blue/red/green dots or interference appears. Monitor looks distorted when touched.

- This is not a fault, and will not be recorded on the actual pictures.

Flash

No flash emitted.

- Flash set to  [Forced Flash Off] ([→74](#)).
- The flash becomes unavailable in the following cases :
 - [Auto Bracket]
 - [Burst] (Excluding  [Flash Burst])
 - Scene Modes ([Scenery], [Night Scenery], [Handheld Night Shot], [HDR], [Sunset], [Starry Sky], [Glass Through], [High Speed Video], [3D Photo Mode])
 - [Creative Control] Mode
 - [Panorama Shot] Mode

Multiple flashes are emitted.

- Red-eye reduction is active ([→74](#)). (Flashes twice to prevent eyes appearing red.)
- [Burst] is set to  [Flash Burst] ([→106](#)).

Playback

Pictures have been rotated.

- [Rotate Disp.] is activated ([→65](#))

Cannot view pictures. There are no recorded pictures.

- No pictures in built-in memory or card (pictures played from card if inserted, from built-in memory if not).
- Has the file name of the picture been changed on a computer? If so, it cannot be played back on the camera.
- During [Filtering Play], only pictures under the set filters are displayed.
→ Cancel filtering ([→133](#)).

Folder/file number displayed as [-]. Picture is black.

- Picture edited on computer or taken on different device.
- Battery removed immediately after picture taken, or picture taken with low battery.
→ Use [Format] to delete ([→66](#)).

Incorrect date displayed in Calendar Search.

- Picture edited on computer or taken on different device.
- [Clock Set] is incorrect ([→27](#)).
(Incorrect date may be displayed in Calendar Search on pictures copied to a computer and then back to this unit, if computer and camera dates differ.)

White round spots like soap bubbles appear on the recorded picture.

- If you take a picture with the flash in a dark place or indoors, white round spots may appear on the picture caused by the flash reflecting particles of dust in the air. This is not a fault. A characteristic of this is that the number of round spots and their position differ in every picture.



[Thumbnail is displayed] is shown on the screen.

- The pictures may have been recorded on another device. If so, they may be displayed with poor picture quality.

Playback (continued)

Blacken red areas of recorded pictures.

- When digital red-eye correction (⚡️, ⚡️) is operating, if a subject is recorded that has skin-colored areas with red areas inside, the digital red-eye correction function may blacken the red areas.
→ We recommend setting the flash to ⚡️, ⚡️ or ⚡️, or [Red-Eye Removal] to [OFF] before recording.

Sounds of camera operations such as zoom will be recorded in motion pictures.

- Camera operation sounds may be recorded as camera automatically adjusts lens aperture during motion picture recording; this is not a fault.

Motion pictures taken by this camera cannot be played in other cameras.

- Even if a device is compatible with AVCHD and MP4, the motion pictures that were recorded on this unit may have bad picture quality or sound quality upon playback, or may be unable to be played back. Also, there might be a case that a recording information does not display correctly.

About the Wi-Fi function

It cannot connect to the wireless LAN. Radio waves get disconnected.

- Use within the communication range of the wireless LAN network.
- Connection types and security setting methods are different depending on the wireless access point.
→ Refer to the operating instructions of the wireless access point.
- When the radio waves are interrupted, the condition may improve by moving the location or changing the angle of the wireless access point.
- It may not automatically connect when the network SSID of the wireless access point is set not to broadcast.
→ Set the network SSID of the wireless access point to broadcast.
- Is any device, such as microwave oven, cordless phone, etc., that uses 2.4 GHz frequency operated nearby?
→ Radio waves may get interrupted when used simultaneously. Use them sufficiently away from the device.
- Is the 5 GHz/2.4 GHz switchable wireless access point connected to other equipment using the 5 GHz band?
→ The use of a wireless access point that can use 5 GHz/2.4 GHz simultaneously is recommended. It cannot be used simultaneously with this camera if it is not compatible.
- When the battery indicator is flashing red, the connection with other equipment may not start or the connection may be disrupted. (A message such as [Communication error] is displayed.)

Wireless access point is not displayed. Or it cannot be connected.

- Check if the wireless access point to connect is in operating state.
- The camera may not display or connect to a wireless access point depending on the radio wave condition.
→ Perform the connection closer to the wireless access point.
- It may not display even if the radio waves exist depending on the setting of the wireless access point.
→ Check the settings of the wireless access point.
- The wireless access point may not be found depending on the radio wave condition.
→ Perform the [Manual Connection]. (→206)
- Is the network SSID of the wireless access point set not to broadcast?
→ It may not be detected when it is set not to broadcast. Enter and set the network SSID. (→207)
- Try the following:
 - Move this unit closer to the wireless access point
 - Remove the obstacles between this unit and the wireless access point
 - Change the direction of this unit

About the Wi-Fi function (continued)**It takes long time every time to connect to a smartphone/tablet.**

- It may take longer time to connect depending on the Wi-Fi connection setting of the smartphone/tablet, but it is not a malfunction.

This unit is not displayed in the Wi-Fi setting screen of the smartphone/tablet. It takes time to setup the connection.

- Try switching the ON/OFF of the Wi-Fi function in the Wi-Fi settings of the smartphone/tablet.

I have forgotten the login ID or password for the "LUMIX CLUB".

- Check the information in the login screen of "LUMIX CLUB".
<http://lumixclub.panasonic.net/eng/c/>

I do not have a wireless access point at my home, but I would like to perform service user registration of the "LUMIX CLUB".

- Service user registration for the "LUMIX CLUB" is not possible in the environment without a wireless access point.

Pictures cannot be transmitted to the computer.

- If a firewall is enabled by the OS or security software, this unit may be unable to connect to the computer.

Images cannot be transmitted to the WEB service.

- Confirm that the login information (login ID/user name/email address/password) is correct.
- WEB service server or the network may be busy.
 - Try again after a while.
 - Check the site of the WEB service you are sending the image to.

It takes time to transmit an image to the WEB service.

- Is the size of the image too large?
 - Transmit after dividing the motion picture with [Video Divide] (→149).
 - Reduce the image size at [Size] (→214), and then send.
- It may take longer time to transmit when distance to the wireless access point is far.
 - Transmit closer to the wireless access point.

The image that was supposed to have uploaded to the WEB service is not there.

- Upload may not complete when it is disconnected while transmitting the image.
- It may take some time after uploading the image to be reflected in the WEB service depending on the status of the server.
 - Wait for a while and try again.
- You can check the transmission status on the WEB service link settings by logging into "LUMIX CLUB".

I would like to return the image in the WEB service to the camera.

- The images in the WEB Service cannot be saved (downloaded) to this unit. Do not delete the uploaded images, and make a backup of them.

I cannot display or delete the images uploaded to the WEB service by this unit.

- The images uploaded to the WEB service cannot be displayed or deleted by this unit.
 - Perform the task using a smartphone/tablet or a PC.

About the Wi-Fi function (continued)

Your “LUMIX CLUB” login ID and password were deleted after sending the camera in to be repaired.

- The settings stored in the camera may be deleted depending on the type of repair.
→ Always make a copy of important settings.

There is an image that could not be transmitted.

- Is the size of the image too large?
→ Divide the motion picture using [Video Divide] (→149).
→ Reduce the image size at [Size] (→214), and then send.
- Capacity or number of images in the WEB service is full.
→ Login to “LUMIX CLUB”, and check the status of the destination on the WEB service link settings.

I have forgotten the password for the Wi-Fi.

- Execute the [Reset Wi-Fi Settings] in the [Setup] menu. (→63)
- However, all the information you have set on the [Wi-Fi Setup] menu, which includes the “LUMIX CLUB” login settings, will be reset. (excluding [LUMIX CLUB])

Transmission of the image fails midway.

- Is the size of the image too large?
→ Transmit after dividing the motion picture with [Video Divide] (→149).
→ Reduce the image size at [Size] (→214), and then send.
→ Image cannot be transmitted when the battery indicator is flashing red.

Motion picture cannot be transmitted.

- File format of the motion picture that can be sent differs depending on the destination. (→192)
- Is the size of the image too large?
→ Transmit after dividing the motion picture with [Video Divide] (→149).

I cannot send images to an AV device.

- Sending may fail depending on the operational status of the AV device.
Also, sending may take a while.

I cannot connect using the NFC function.

- The smartphone is not NFC compatible.
This function can be used with NFC compatible devices with Android (2.3.3 or above).
- Is the NFC function on the smartphone turned off?
- The [NFC Operation] on this unit is set to [OFF]. (→202)
- The camera has a hard time recognizing some smartphone models. If it is not recognized, slowly shift the smartphone while it is beside the unit.

TV, computer, printer**No image appears on TV. Image blurred or not colored.**

- Not connected correctly (→253).
- The television has not been switched to auxiliary input.

TV screen display different to LCD monitor.

- Aspect ratio may be incorrect or edges may be cut off with certain televisions.

Cannot play motion pictures on TV.

- Card is inserted into TV.
→ Connect with AV cable (optional) or HDMI micro cable (optional) and play on camera (→253).

Picture is not displayed on full TV screen.

- Check [TV Aspect] settings (→64).

No sound is output from the camera speaker.

- When the AV cable (optional) or HDMI micro cable (optional) is connected to the camera, no sound is output from the camera.

VIERA Link (HDMI) is not working.

- Is the HDMI micro cable (optional) connected correctly? (→253)
→ Check that the HDMI micro cable (optional) is fully inserted.
- Is the camera's [VIERA Link] setting set to [ON]? (→64)
→ The input setting may not be able to be changed automatically with certain television HDMI sockets. In this case, please change the input setting with your television's remote control (consult your television's operating instructions for details).
→ Check the VIERA Link (HDMI) settings on the device you are connecting to.
→ Turn the camera off and on again.
→ Turn the "VIERA Link control (HDMI device control)" setting on your television (VIERA) to off and then to on again. (Consult your VIERA's operating instructions for details.)

Cannot communicate with the computer.

- Not connected correctly (→264).
- Check whether computer has recognized camera.
→ Set [USB Mode] to [PC] (→64).
→ Turn the unit off and then back on again.

TV, computer, printer (continued)**Computer does not recognize card (only reads built-in memory).**

- Disconnect USB connection cable (supplied) and reconnect with card in place.

Computer does not recognize card. (When using an SDXC Memory Cards)

- Check whether your computer is compatible with SDXC Memory Cards.
<http://panasonic.net/avc/sdcard/information/SDXC.html>
- A message prompting you to format the card may appear when you connect it. Do not format the card.
- If the [Access] indicator on the LCD monitor does not go off, turn the camera off before disconnecting the USB connection cable.

Cannot print when connecting to printer.

- Printer not compatible with PictBridge.
- Set [USB Mode] to [PictBridge(PTP)] (→64).

The edges of pictures are cut off when printing.

- Release any trimming or edgeless printing settings on printer before printing.
(Consult printer operating manual.)
- The pictures were recorded in 16:9 aspect ratio.
→ If printing in shop, check if 16:9 sizes can be printed.

Cannot print panorama pictures properly.

- The aspect ratio of panorama pictures is different from that of regular still pictures, and some panorama pictures may not be printed correctly.
→ Use a printer with support for panorama pictures. (Refer to the instruction manual for the printer.)
→ We recommend adjusting the size of a picture in accordance with print paper using the "PHOTOfunSTUDIO" software on the disc (supplied).

Others**Menu not displayed in desired language.**

- Change [Language] setting (→66).

Camera rattles if shaken.

- This sound is made by the lens movement and is not a fault.

Red lamp illuminated when pressing shutter button halfway in dark locations.

- [AF Assist Lamp] is set to [ON] (→123).

AF Assist Lamp is not illuminated.

- [AF Assist Lamp] is set to [OFF] (→123).
- Not illuminated in bright locations.

Camera is hot.

- Camera may become a little warm during use, but this does not affect performance or quality.

Lens makes a clicking noise.

- When brightness changes, the lens may make a clicking noise and the monitor brightness may also change, but this is due to aperture settings being made.
(Does not affect recording.)

Clock is incorrect.

- Camera has been left for a long period.
→ Reset the clock (→27).
- A long time was taken to set the clock (clock will be behind by the same lapse of time).

When using zoom, picture becomes slightly warped and the edges of the subject become colored.

- Pictures may be slightly warped or colored around the edges, depending on the zoom ratio, but this is not a fault.

Zoom does not reach the maximum ratio.

- If the zoom ratio stops at 3 x, [Macro Zoom] has been set. (→77)

File numbers are not recorded in sequence.

- File numbers are reset when new folders are created (→265).

File numbers have jumped backwards.

- Battery was removed/inserted with the camera turned on.
(Numbers may jump backwards if folder/file numbers are not correctly recorded.)

Usage cautions and notes

When in use

- Camera may become warm if used for long periods of time, but this is not a fault.
- **Keep this unit as far away as possible from electromagnetic equipment (such as microwave ovens, TVs, video games etc.).**
 - If you use this unit on top of or near a TV, the pictures and/or sound on this unit may be disrupted by electromagnetic wave radiation.
 - Do not use this unit near cell phones because doing so may result in noise adversely affecting the pictures and/or sound.
 - Recorded data may be damaged, or pictures may be distorted, by strong magnetic fields created by speakers or large motors.
 - Electromagnetic wave radiation generated by microprocessors may adversely affect this unit, disturbing the pictures and/or sound.
 - If this unit is adversely affected by electromagnetic equipment and stops functioning properly, turn this unit off and remove the battery or disconnect AC adaptor (supplied)/AC adaptor (optional). Then reinsert the battery or reconnect AC adaptor and turn this unit on.

Do not use this unit near radio transmitters or high-voltage lines.

- If you record near radio transmitters or high-voltage lines, the recorded pictures and/or sound may be adversely affected.
- Do not extend the supplied cord or cable.
- Do not allow camera to come into contact with pesticides or volatile substances (can cause surface damage or coating to peel).
- Never leave the camera and the battery in a car or on a car hood in the summer. It may cause leakage of the battery electrolyte, a generation of heat, and may cause a fire and the battery to burst due to the high temperature.

Caring for your camera

To clean your camera, remove the battery or disconnect the power plug from the outlet, and wipe with a soft, dry cloth.

- Use a damp cloth to remove stubborn stains, before wiping with a dry cloth.
- Do not use benzine, thinners, alcohol, or kitchen detergent, as these may damage the outer casing and finish of the camera.
- If using a chemically-treated cloth, read the supplied instructions carefully.
- Do not touch the lens barrier.



Lens barrier

When not using for a while

- Turn off the camera before removing battery and card (ensure that battery is removed to prevent damage through over-discharge).
- Do not leave in contact with rubber or plastic bags.
- Store together with a drying agent (silica gel) if leaving in drawer, etc. Store batteries in cool (15 °C to 25 °C (59 °F to 77 °F)) places with low humidity (40%RH to 60%RH) and no major temperature changes.
- Charge battery once per year and use completely before storing again.

Memory cards

- To prevent damage to cards and data
 - Avoid high temperatures, direct sunlight, electromagnetic waves, and static electricity.
 - Do not bend, drop, or expose to strong impacts.
 - Do not touch terminals on reverse of card or allow them to become dirty or wet.
- When disposing of/transferring memory cards
 - If using the "format" or "delete" functions on your camera or computer, this only changes the file management information, and does not completely delete the data from within the memory card. When disposing of or transferring your memory cards, we recommend physically destroying the memory card itself, or using commercially available computer data erasing software to completely delete the data from the card. Data within memory cards should be managed responsibly.

LCD Monitor

- Do not press hard on the LCD monitor. This may cause uneven display and damage the monitor.
- In cold climates or other situations when the camera becomes cold, the LCD monitor may appear slightly darker than normal immediately after the camera is turned on. Normal brightness will return once the internal components have warmed up.

Extremely high precision technology is employed to produce the LCD monitor screen. However there may be some dark or bright spots (red, blue or green) on the screen. This is not a malfunction. The LCD monitor screen has more than 99.99% effective pixels with a mere 0.01% of the pixels inactive or always lit. The spots will not be recorded on pictures on the built-in memory or a card.

About charging the battery

- The time required for charging varies depending on conditions of battery usage. Charging takes longer at high or low temperatures and when the battery has not been used in some time.
- Battery will be warm during charging and for some time thereafter.
- Battery will run out if not used for long periods of time, even after being charged.
- Do not leave any metal items (such as clips) near the contact areas of the power plug. Otherwise, a fire and/or electric shocks may be caused by short-circuiting or the resulting heat generated.
- Frequently charging up battery is not recommended.
(Frequently charging battery reduces maximum usage time and can cause battery to expand.)
- If available battery power is significantly reduced, battery is reaching end of lifespan. Please purchase a new battery.
- When charging:
 - Wipe dirt from the battery terminal with a dry cloth.
 - Keep at least 1 m (3.3 feet) away from AM radio (may cause radio interference).
- Do not use a damaged or dented battery (especially connectors), e.g. by dropping (can cause faults).
- Do not peel off or scratch the covering on the battery.
 - Using a battery with a part of or all of its covering removed or broken may cause malfunction.

About AC adaptor (supplied)

- Keep at least 1 m (3.3 feet) away from AM radio (may cause radio interference).
- The AC adaptor (supplied) may generate whirring sounds when it is being used. This is not a malfunction.
- After use, be sure to disconnect the power supply device from the electrical outlet. (A very small amount of current is consumed if it is left connected.)

Lens

- Images may appear slightly white if lens is dirty (fingerprints, etc.). Turn the camera on, hold the extracted lens barrel with your fingers, and gently wipe the lens surface with a soft, dry cloth.
- Do not leave the lens exposed to direct sunlight.
- Do not touch the lens barrier, as this may damage lens. Be careful when removing camera from bag, etc.

When using a tripod or unipod

- Do not apply excessive force or tighten screws when they are crooked. (This may damage the camera, screw hole, or label.)
- Ensure that the tripod is stable. (Refer to the tripod instructions.)
- You may not be able to remove the card or the battery when using a tripod or unipod.

About 3D viewing

- Anyone who is hypersensitive to light, suffers from heart disease or is otherwise unwell should avoid viewing 3D pictures.
 - Viewing 3D pictures may have an adverse effect to the individual.
- If you feel tired, uncomfortable or otherwise strange when viewing 3D pictures, stop viewing at once.
 - Continuing to view may cause illness.
 - After stopping viewing, please rest appropriately.
- When viewing 3D pictures, we recommend taking a break every 30 to 60 minutes.
 - Viewing for extended periods may cause eye-fatigue.
- Short-sighted or long-sighted persons, those with differences in the sight of their right and left eyes, and those with astigmatism are advised to correct their vision by wearing glasses etc. Stop viewing if you can clearly see a double image while viewing 3D pictures.
 - There are differences in the way that different people experience 3D pictures. Please correct your sight appropriately before viewing 3D pictures.
 - You can change the 3D setting of your television or 3D output setting of the unit to 2D.

Personal Information

To protect personal information, we recommend that you set a Wi-Fi password. (→252)

If names or birthdays are set in [Baby] Mode or in the [Face Recog.] function, keep in mind that the camera and recorded pictures will contain personal information.

- **Disclaimer**
 - Data containing personal information can be altered or lost due to malfunction, static electricity, accidents, breakdowns, repairs, or other operations. Panasonic will not be liable for any damage that occurs, direct or indirect, as a result of the alteration or loss of data containing personal information.
- **When ordering repairs or transferring/disposing of the camera**
 - To protect your personal information, please reset the settings. (→63)
 - If any pictures are contained in the built-in memory, copy (→157) them to a memory card if necessary, and then format (→66) the built-in memory.
 - Remove the memory card from the camera.
 - When ordering repairs, the built-in memory and other settings may be returned to the initial purchase state.
 - If the above operations cannot be performed because of a camera malfunction, consult with the dealer or nearest Service Center.
- **When transferring or disposing of your memory card, see “When disposing of/transferring memory cards” in the previous section (→293).**
- **Uploading pictures to Web services**
 - Pictures may contain personal information that can be used to identify the user, such as titles, recording dates and times, and location information. Before uploading the pictures to Web services, check the pictures carefully for information that should not be disclosed.

Important! Be sure to read the following before using the location names that are stored in this product.

License Agreement for Place Name and Map Data

Personal Use Only.

You agree to use this Data together with this digital camera for the solely personal, non-commercial purposes for which you were licensed, and not for service bureau, time-sharing or other similar purposes. Accordingly, but subject to the restrictions set forth in the following paragraphs, you agree not to otherwise reproduce, copy, modify, decompile, disassemble or reverse engineer any portion of this Data, and may not transfer or distribute it in any form, for any purpose, except to the extent permitted by mandatory laws. Multi-disc sets may only be transferred or sold as a complete set as provided by Panasonic Corporation and not as a subset thereof.

Restrictions.

Except where you have been specifically licensed to do so by Panasonic Corporation, and without limiting the preceding paragraph, you may not (a) use this Data with any products, systems, or applications installed or otherwise connected to or in communication with vehicles, capable of vehicle navigation, positioning, dispatch, real time route guidance, fleet management or similar applications; or (b) with or in communication with any positioning devices or any mobile or wireless-connected electronic or computer devices, including without limitation cellular phones, palmtop and handheld computers, pagers, and personal digital assistants or PDAs.

Warning.

The Data may contain inaccurate or incomplete information due to the passage of time, changing circumstances, sources used and the nature of collecting comprehensive geographic data, any of which may lead to incorrect results.

No Warranty.

This Data is provided to you "as is," and you agree to use it at your own risk. Panasonic Corporation and its licensors (and their licensors and suppliers) make no guarantees, representations or warranties of any kind, express or implied, arising by law or otherwise, including but not limited to, content, quality, accuracy, completeness, effectiveness, reliability, fitness for a particular purpose, usefulness, use or results to be obtained from this Data, or that the Data or server will be uninterrupted or error-free.

Disclaimer of Warranty:

PANASONIC CORPORATION AND ITS LICENSORS (INCLUDING THEIR LICENSORS AND SUPPLIERS) DISCLAIM ANY WARRANTIES, EXPRESS OR IMPLIED, OF QUALITY, PERFORMANCE, MERCHANTABILITY, FITNESS FOR A PARTICULAR PURPOSE OR NON-INFRINGEMENT. Some States, Territories and Countries do not allow certain warranty exclusions, so to that extent the above exclusion may not apply to you.

Disclaimer of Liability:

PANASONIC CORPORATION AND ITS LICENSORS (INCLUDING THEIR LICENSORS AND SUPPLIERS) SHALL NOT BE LIABLE TO YOU: IN RESPECT OF ANY CLAIM, DEMAND OR ACTION, IRRESPECTIVE OF THE NATURE OF THE CAUSE OF THE CLAIM, DEMAND OR ACTION ALLEGING ANY LOSS, INJURY OR DAMAGES, DIRECT OR INDIRECT, WHICH MAY RESULT FROM THE USE OR POSSESSION OF THE INFORMATION; OR FOR ANY LOSS OF PROFIT, REVENUE, CONTRACTS OR SAVINGS, OR ANY OTHER DIRECT, INDIRECT, INCIDENTAL, SPECIAL OR CONSEQUENTIAL DAMAGES ARISING OUT OF YOUR USE OF OR INABILITY TO USE THIS INFORMATION, ANY DEFECT IN THE INFORMATION, OR THE BREACH OF THESE TERMS OR CONDITIONS, WHETHER IN AN ACTION IN CONTRACT OR TORT OR BASED ON A WARRANTY, EVEN IF PANASONIC CORPORATION OR ITS LICENSORS HAVE BEEN ADVISED OF THE POSSIBILITY OF SUCH DAMAGES. Some States, Territories and Countries do not allow certain liability exclusions or damages limitations, so to that extent the above may not apply to you.

Export Control.

Panasonic Corporation shall not export from anywhere any part of the Data or any direct product thereof except in compliance with, and with all licenses and approvals required under, applicable export laws, rules and regulations, including but not limited to the laws, rules and regulations administered by the Office of Foreign Assets Control of the U.S. Department of Commerce and the Bureau of Industry and Security of the U.S. Department of Commerce. To the extent that any such export laws, rules or regulations prohibit NT from complying with any of its obligations hereunder to deliver or distribute Data, such failure shall be excused and shall not constitute a breach of this Agreement.

Entire Agreement.

These terms and conditions constitute the entire agreement between Panasonic Corporation (and its licensors, including their licensors and suppliers) and you pertaining to the subject matter hereof, and supersedes in their entirety any and all written or oral agreements previously existing between us with respect to such subject matter.

About Location Information, Place Name Information, and Maps**About the geographical coordinate system**

The latitude and longitude standard (geographical coordinate system) recorded with this camera is WGS84.

Mapple Digital Map Data

These maps were prepared using the following maps of the Geospatial Information Authority of Japan (GSI), with the approval of the Director General of GSI: 1:10,000 Topographic Map, 1:200,000 Regional Map, 1:1,000,000 Map of Japan, 1:500,000 District Map, and Digital Map 5000000 (Integration).

(Approval nos. for use of 2012 information: nos. 75-, 77-, and 78-M055541)

About copyright

According to copyright law, the map data stored in this camera may not be used for purposes other than personal use without the permission of the copyright holder.

About navigation functions

This camera is not equipped with a navigation function.

Notices related to licensed software copyright holders

© 2012 NAVTEQ. All rights reserved.



"MAPPLE" is a trademark of Shobunsha Publications, Inc.

MAPPLE

This data includes information taken with permission from Canadian authorities, including © Her Majesty the Queen in Right of Canada, © Queen's Printer for Ontario, © Canada Post Corporation, GeoBase®, © Department of Natural Resources Canada. All rights reserved.

© United States Postal Service® 2012, USPS®, ZIP+4®

Fuente: INEGI (Instituto Nacional de Estadística y Geografía)

Traffic Codes for Belgium are provided by the Ministerie van de Vlaamse Gemeenschap and the Ministère de l'Équipement et des Transports.

| Territory | Notice |
|--|--|
| Austria | © Bundesamt für Eich- und Vermessungswesen |
| Croatia | © EuroGeographics |
| Belgium (If using Traffic Codes for Belgium) | Traffic Codes for Belgium are provided by the Ministerie van de Vlaamse Gemeenschap and the Ministère de l'Équipement et des Transports. |
| Cyprus | © EuroGeographics |
| Estonia | © EuroGeographics |
| France | source: © IGN 2009 – BD TOPO ® |
| Germany | “Die Grundlagendaten wurden mit Genehmigung der zuständigen Behörden entnommen” or “Die Grundlagendaten wurden mit Genehmigung der zustaendigen Behoerden entnommen.” |
| Great Britain | Contains Ordnance Survey data © Crown copyright and database right 2010 Contains Royal Mail data © Royal Mail copyright and database right 2010 |
| Greece ** | Copyright Geomatics Ltd. |
| Hungary | Copyright © 2003; Top-Map Ltd. |
| Italy | La Banca Dati Italiana è stata prodotta usando quale riferimento anche cartografia numerica ed al tratto prodotta e fornita dalla Regione Toscana. |
| Latvia | © EuroGeographics |
| Lithuania | © EuroGeographics |
| Moldova | © EuroGeographics |
| Norway | Copyright © 2000; Norwegian Mapping Authority |
| Poland | © EuroGeographics |
| Portugal | Source: IgeoE – Portugal |
| Slovenia | © EuroGeographics |
| Spain | Información geográfica propiedad del CNIG |
| Sweden | Based upon electronic data © National Land Survey Sweden. |
| Switzerland | Topografische Grundlage: © Bundesamt für Landestopographie |
| Ukraine | © EuroGeographics |
| Canada | “ This data includes information taken with permission from Canadian authorities, including © Her Majesty, © Queen’s Printer for Ontario, © Canada Post, GeoBase®, © Department of Natural Resources Canada. All rights reserved. ” |
| United States | ©United States Postal Service® 2012. Prices are not established, controlled or approved by the United States Postal Service®. The following trademarks and registrations are owned by the USPS: United States Postal Service, USPS, and ZIP+4. |
| Australia | Copyright. Based on data provided under license from PSMA Australia Limited (www.psm.com.au). Product incorporates data which is © 2012 Telstra Corporation Limited, GM Holden Limited, Intelomatics Australia Pty Ltd and Continental Pty Ltd. |

| Territory | Notice |
|---|--|
| Australia (If using RDS-TMC Traffic Codes for Australia) | Product incorporates traffic location codes which is © 2012 Telstra Corporation Limited and its licensors. |
| Australia (If using Actual Address Range Content for Australia) | Copyright. Based on data provided under license from PSMA Australia Limited (www.psmalimit.com.au). |
| Nepal | Copyright © Survey Department, Government of Nepal. |
| Sri Lanka | This product incorporates original source digital data obtained from the Survey Department of Sri Lanka © 2009 Survey Department of Sri Lanka The data has been used with the permission of the Survey Department of Sri Lanka |
| Israel | © Survey of Israel data source |
| Jordan | "© Royal Jordanian Geographic Centre". The foregoing notice requirement for Jordan Data is a material term of the Agreement. If Client or any of its permitted sublicensees (if any) fail to meet such requirement, NT shall have the right to terminate Client's license with respect to the Jordan Data. |
| Mozambique | Certain Data for Mozambique provided by Cenacarta © 2012 by Cenacarta |
| Réunion | source: © IGN 2009 - BD TOPO ® |
| Ecuador | INSTITUTO GEOGRAFICO MILITAR DEL ECUADRO AUTORIZACION N° IGM-2011-01- PCO-01 DEL 25 DE ENERO DE 2011 |
| Guadeloupe | source: © IGN 2009 - BD TOPO ® |
| Guatemala | Aprobado por el INSTITUTO GEOGRAFICO NACIONAL – Resolución del IGN N° 186-2011 |
| French Guiana | source: © IGN 2009 - BD TOPO ® |
| Martinique | source: © IGN 2009 - BD TOPO ® |
| Mexico | Fuente: INEGI (Instituto Nacional de Estadística y Geografía) |

■ Landmark types

Although approx. 1,000,000 landmarks are registered in the built-in memory, there are also some unregistered landmarks. (The registered information is current as of October 2012 and will not be updated.)

- It differs from that registered on our GPS-equipped models before 2011.

| | | |
|--|---|--------------------------------------|
| Zoo | Botanical garden | Aquarium |
| Amusement park | Golf course | Camp sites |
| Ski resorts | Skating rinks | Outdoor activity sites |
| Famous site, tourist attraction, beauty spot | Castle, ruins | Shrine |
| Temple | Church | Tomb, monument, mound, historic site |
| Airport | Port | Ferry terminal |
| Baseball park | Athletics ground | Gymnasium |
| Park | Station | Prefectural or state office |
| Lifts, cable cars | Art museum | History museum |
| Theater | Cinemas, performing theaters | Wineries, breweries |
| Mountains, meadows, passes | Canyons, mountain streams, waterfalls, valleys, seashores | Tower, high-rise building |



- HDMI, the HDMI Logo, and High-Definition Multimedia Interface are trademarks or registered trademarks of HDMI Licensing LLC in the United States and other countries.
- HDAVI Control™ is a trademark of Panasonic Corporation.
- “AVCHD”, “AVCHD Progressive” and the “AVCHD Progressive” logo are trademarks of Panasonic Corporation and Sony Corporation.
- Manufactured under license from Dolby Laboratories. Dolby and the double-D symbol are trademarks of Dolby Laboratories.
- SDXC Logo is a trademark of SD-3C, LLC.
- QuickTime and the QuickTime logo are trademarks or registered trademarks of Apple Inc., used under license therefrom.
- Windows and Windows Vista are either registered trademarks or trademarks of Microsoft Corporation in the United States and/or other countries.
- iMovie, Mac and Mac OS are trademarks of Apple Inc., registered in the U.S. and other countries.
- App Store is a service mark of Apple Inc.
- Android and Google Play are trademarks or registered trademarks of Google Inc.

- The Wi-Fi CERTIFIED Logo is a certification mark of the Wi-Fi Alliance.
- The Wi-Fi Protected Setup Mark is a mark of the Wi-Fi Alliance.
- “Wi-Fi”, “Wi-Fi Protected Setup”, “Wi-Fi Direct”, “WPA” and “WPA2” are marks or registered marks of the Wi-Fi Alliance.
- DLNA, the DLNA Logo and DLNA CERTIFIED are trademarks, service marks, or certification marks of the Digital Living Network Alliance.
- This product uses “DynaFont” from DynaComware Corporation. DynaFont is a registered trademark of DynaComware Taiwan Inc.
- Other names, company names, and product names mentioned in these instructions are trademarks or registered trademarks of the companies concerned.

This product is licensed under the AVC patent portfolio license for the personal and non-commercial use of a consumer to (i) encode video in compliance with the AVC Standard (“AVC Video”) and/or (ii) decode AVC Video that was encoded by a consumer engaged in a personal and non-commercial activity and/or was obtained from a video provider licensed to provide AVC Video. No license is granted or shall be implied for any other use. Additional information may be obtained from MPEG LA, LLC.
See <http://www.mpegla.com>.

This product incorporates the following software:

- (1) the software developed independently by or for Panasonic Corporation,
- (2) the software owned by third party and licensed to Panasonic Corporation and/or,
- (3) open sourced software including the software developed by the OpenSSL Project for use in the OpenSSL Toolkit (<http://www.openssl.org/>), and the software written by Eric Young (eay@cryptsoft.com).

This product contains OpenSSL software developed by the OpenSSL Project, and can be used under the following licencing conditions.

LICENSE ISSUES

The OpenSSL toolkit stays under a dual license, i.e. both the conditions of the OpenSSL License and the original SSLeay license apply to the toolkit. See below for the actual license texts. Actually both licenses are BSD-style Open Source licenses. In case of any license issues related to OpenSSL please contact openssl-core@openssl.org.

OpenSSL License

Copyright (c) 1998-2004 The OpenSSL Project. All rights reserved.

Redistribution and use in source and binary forms, with or without modification, are permitted provided that the following conditions are met:

1. Redistributions of source code must retain the above copyright notice, this list of conditions and the following disclaimer.
2. Redistributions in binary form must reproduce the above copyright notice, this list of conditions and the following disclaimer in the documentation and/or other materials provided with the distribution.
3. All advertising materials mentioning features or use of this software must display the following acknowledgment:
"This product includes software developed by the OpenSSL Project for use in the OpenSSL Toolkit. (<http://www.openssl.org/>)"
4. The names "OpenSSL Toolkit" and "OpenSSL Project" must not be used to endorse or promote products derived from this software without prior written permission. For written permission, please contact openssl-core@openssl.org.
5. Products derived from this software may not be called "OpenSSL" nor may "OpenSSL" appear in their names without prior written permission of the OpenSSL Project.
6. Redistributions of any form whatsoever must retain the following acknowledgment:
"This product includes software developed by the OpenSSL Project for use in the OpenSSL Toolkit (<http://www.openssl.org/>)"

THIS SOFTWARE IS PROVIDED BY THE OpenSSL PROJECT "AS IS" AND ANY EXPRESSED OR IMPLIED WARRANTIES, INCLUDING, BUT NOT LIMITED TO, THE IMPLIED WARRANTIES OF MERCHANTABILITY AND FITNESS FOR A PARTICULAR PURPOSE ARE DISCLAIMED. IN NO EVENT SHALL THE OpenSSL PROJECT OR ITS CONTRIBUTORS BE LIABLE FOR ANY DIRECT, INDIRECT, INCIDENTAL, SPECIAL, EXEMPLARY, OR CONSEQUENTIAL DAMAGES (INCLUDING, BUT NOT LIMITED TO, PROCUREMENT OF SUBSTITUTE GOODS OR SERVICES; LOSS OF USE, DATA, OR PROFITS; OR BUSINESS INTERRUPTION) HOWEVER CAUSED AND ON ANY THEORY OF LIABILITY, WHETHER IN CONTRACT, STRICT LIABILITY, OR TORT (INCLUDING NEGLIGENCE OR OTHERWISE) ARISING IN ANY WAY OUT OF THE USE OF THIS SOFTWARE, EVEN IF ADVISED OF THE POSSIBILITY OF SUCH DAMAGE.

This product includes cryptographic software written by Eric Young (eay@cryptsoft.com).

This product includes software written by Tim Hudson (tjh@cryptsoft.com).

Original SSLeay License

Copyright (C) 1995-1998 Eric Young (eay@cryptsoft.com)
All rights reserved.

This package is an SSL implementation written by Eric Young (eay@cryptsoft.com).
The implementation was written so as to conform with Netscapes SSL.

This library is free for commercial and non-commercial use as long as the following conditions are adhered to. The following conditions apply to all code found in this distribution, be it the RC4, RSA, lhash, DES, etc., code; not just the SSL code. The SSL documentation included with this distribution is covered by the same copyright terms except that the holder is Tim Hudson (tjh@cryptsoft.com).

Copyright remains Eric Young's, and as such any Copyright notices in the code are not to be removed. If this package is used in a product, Eric Young should be given attribution as the author of the parts of the library used. This can be in the form of a textual message at program startup or in documentation (online or textual) provided with the package.

Redistribution and use in source and binary forms, with or without modification, are permitted provided that the following conditions are met:

1. Redistributions of source code must retain the copyright notice, this list of conditions and the following disclaimer.
2. Redistributions in binary form must reproduce the above copyright notice, this list of conditions and the following disclaimer in the documentation and/or other materials provided with the distribution.
3. All advertising materials mentioning features or use of this software must display the following acknowledgement:
"This product includes cryptographic software written by Eric Young (eay@cryptsoft.com)"
The word 'cryptographic' can be left out if the routines from the library being used are not cryptographic related :-).
4. If you include any Windows specific code (or a derivative thereof) from the apps directory (application code) you must include an acknowledgement:
"This product includes software written by Tim Hudson (tjh@cryptsoft.com)"

THIS SOFTWARE IS PROVIDED BY ERIC YOUNG "AS IS" AND ANY EXPRESS OR IMPLIED WARRANTIES, INCLUDING, BUT NOT LIMITED TO, THE IMPLIED WARRANTIES OF MERCHANTABILITY AND FITNESS FOR A PARTICULAR PURPOSE ARE DISCLAIMED. IN NO EVENT SHALL THE AUTHOR OR CONTRIBUTORS BE LIABLE FOR ANY DIRECT, INDIRECT, INCIDENTAL, SPECIAL, EXEMPLARY, OR CONSEQUENTIAL DAMAGES (INCLUDING, BUT NOT LIMITED TO, PROCUREMENT OF SUBSTITUTE GOODS OR SERVICES; LOSS OF USE, DATA, OR PROFITS; OR BUSINESS INTERRUPTION) HOWEVER CAUSED AND ON ANY THEORY OF LIABILITY, WHETHER IN CONTRACT, STRICT LIABILITY, OR TORT (INCLUDING NEGLIGENCE OR OTHERWISE) ARISING IN ANY WAY OUT OF THE USE OF THIS SOFTWARE, EVEN IF ADVISED OF THE POSSIBILITY OF SUCH DAMAGE.

The license and distribution terms for any publically available version or derivative of this code cannot be changed. i.e. this code cannot simply be copied and put under another distribution license [including the GNU Public License.]

This product contains encryption software developed by Eric Young, and can be used under the following licencing conditions.

Copyright (C) 1995-1998 Eric Young (eay@cryptsoft.com)
All rights reserved.

This package is an SSL implementation written by Eric Young (eay@cryptsoft.com).
The implementation was written so as to conform with Netscapes SSL.

This library is free for commercial and non-commercial use as long as the following conditions are adhered to. The following conditions apply to all code found in this distribution, be it the RC4, RSA, lhash, DES, etc., code; not just the SSL code. The SSL documentation included with this distribution is covered by the same copyright terms except that the holder is Tim Hudson (tjh@cryptsoft.com).

Copyright remains Eric Young's, and as such any Copyright notices in the code are not to be removed. If this package is used in a product, Eric Young should be given attribution as the author of the parts of the library used. This can be in the form of a textual message at program startup or in documentation (online or textual) provided with the package.

Redistribution and use in source and binary forms, with or without modification, are permitted provided that the following conditions are met:

1. Redistributions of source code must retain the copyright notice, this list of conditions and the following disclaimer.
2. Redistributions in binary form must reproduce the above copyright notice, this list of conditions and the following disclaimer in the documentation and/or other materials provided with the distribution.
3. All advertising materials mentioning features or use of this software must display the following acknowledgement:
"This product includes cryptographic software written by Eric Young (eay@cryptsoft.com)"
The word 'cryptographic' can be left out if the routines from the library being used are not cryptographic related :-).
4. If you include any Windows specific code (or a derivative thereof) from the apps directory (application code) you must include an acknowledgement:
"This product includes software written by Tim Hudson (tjh@cryptsoft.com)"

THIS SOFTWARE IS PROVIDED BY ERIC YOUNG "AS IS" AND ANY EXPRESS OR IMPLIED WARRANTIES, INCLUDING, BUT NOT LIMITED TO, THE IMPLIED WARRANTIES OF MERCHANTABILITY AND FITNESS FOR A PARTICULAR PURPOSE ARE DISCLAIMED. IN NO EVENT SHALL THE AUTHOR OR CONTRIBUTORS BE LIABLE FOR ANY DIRECT, INDIRECT, INCIDENTAL, SPECIAL, EXEMPLARY, OR CONSEQUENTIAL DAMAGES (INCLUDING, BUT NOT LIMITED TO, PROCUREMENT OF SUBSTITUTE GOODS OR SERVICES; LOSS OF USE, DATA, OR PROFITS; OR BUSINESS INTERRUPTION) HOWEVER CAUSED AND ON ANY THEORY OF LIABILITY, WHETHER IN CONTRACT, STRICT LIABILITY, OR TORT (INCLUDING NEGLIGENCE OR OTHERWISE) ARISING IN ANY WAY OUT OF THE USE OF THIS SOFTWARE, EVEN IF ADVISED OF THE POSSIBILITY OF SUCH DAMAGE.

The license and distribution terms for any publically available version or derivative of this code cannot be changed. i.e. this code cannot simply be copied and put under another distribution license [including the GNU Public License.]

This product contains NetBSD software, and can be used under the following licencing conditions.

Copyright (c) 1990 The Regents of the University of California. All rights reserved.

This code is derived from software contributed to Berkeley by Chris Torek.

Redistribution and use in source and binary forms, with or without modification, are permitted provided that the following conditions are met:

1. Redistributions of source code must retain the above copyright notice, this list of conditions and the following disclaimer.
2. Redistributions in binary form must reproduce the above copyright notice, this list of conditions and the following disclaimer in the documentation and/or other materials provided with the distribution.
3. Neither the name of the University nor the names of its contributors may be used to endorse or promote products derived from this software without specific prior written permission.

THIS SOFTWARE IS PROVIDED BY THE REGENTS AND CONTRIBUTORS "AS IS" AND ANY EXPRESS OR IMPLIED WARRANTIES, INCLUDING, BUT NOT LIMITED TO, THE IMPLIED WARRANTIES OF MERCHANTABILITY AND FITNESS FOR A PARTICULAR PURPOSE ARE DISCLAIMED. IN NO EVENT SHALL THE REGENTS OR CONTRIBUTORS BE LIABLE FOR ANY DIRECT, INDIRECT, INCIDENTAL, SPECIAL, EXEMPLARY, OR CONSEQUENTIAL DAMAGES (INCLUDING, BUT NOT LIMITED TO, PROCUREMENT OF SUBSTITUTE GOODS OR SERVICES; LOSS OF USE, DATA, OR PROFITS; OR BUSINESS INTERRUPTION) HOWEVER CAUSED AND ON ANY THEORY OF LIABILITY, WHETHER IN CONTRACT, STRICT LIABILITY, OR TORT (INCLUDING NEGLIGENCE OR OTHERWISE) ARISING IN ANY WAY OUT OF THE USE OF THIS SOFTWARE, EVEN IF ADVISED OF THE POSSIBILITY OF SUCH DAMAGE.

This product contains OpenSSL software developed by the OpenSSL Project, and can be used under the following licencing conditions.

Copyright (c) 1999-2002 The OpenSSL Project. All rights reserved.

Redistribution and use in source and binary forms, with or without modification, are permitted provided that the following conditions are met:

1. Redistributions of source code must retain the above copyright notice, this list of conditions and the following disclaimer.
2. Redistributions in binary form must reproduce the above copyright notice, this list of conditions and the following disclaimer in the documentation and/or other materials provided with the distribution.
3. All advertising materials mentioning features or use of this software must display the following acknowledgment:
"This product includes software developed by the OpenSSL Project for use in the OpenSSL Toolkit. (<http://www.OpenSSL.org/>)"
4. The names "OpenSSL Toolkit" and "OpenSSL Project" must not be used to endorse or promote products derived from this software without prior written permission. For written permission, please contact licensing@OpenSSL.org.
5. Products derived from this software may not be called "OpenSSL" nor may "OpenSSL" appear in their names without prior written permission of the OpenSSL Project.
6. Redistributions of any form whatsoever must retain the following acknowledgment:
"This product includes software developed by the OpenSSL Project for use in the OpenSSL Toolkit (<http://www.OpenSSL.org/>)"

THIS SOFTWARE IS PROVIDED BY THE OpenSSL PROJECT "AS IS" AND ANY EXPRESSED OR IMPLIED WARRANTIES, INCLUDING, BUT NOT LIMITED TO, THE IMPLIED WARRANTIES OF MERCHANTABILITY AND FITNESS FOR A PARTICULAR PURPOSE ARE DISCLAIMED. IN NO EVENT SHALL THE OpenSSL PROJECT OR ITS CONTRIBUTORS BE LIABLE FOR ANY DIRECT, INDIRECT, INCIDENTAL, SPECIAL, EXEMPLARY, OR CONSEQUENTIAL DAMAGES (INCLUDING, BUT NOT LIMITED TO, PROCUREMENT OF SUBSTITUTE GOODS OR SERVICES; LOSS OF USE, DATA, OR PROFITS; OR BUSINESS INTERRUPTION) HOWEVER CAUSED AND ON ANY THEORY OF LIABILITY, WHETHER IN CONTRACT, STRICT LIABILITY, OR TORT (INCLUDING NEGLIGENCE OR OTHERWISE) ARISING IN ANY WAY OUT OF THE USE OF THIS SOFTWARE, EVEN IF ADVISED OF THE POSSIBILITY OF SUCH DAMAGE.

This product includes cryptographic software written by Eric Young (ey@cryptsoft.com).

This product includes software written by Tim Hudson (tjh@cryptsoft.com).

This product contains encryption software developed by Eric Young, and can be used under the following licencing conditions.

Copyright (C) 1995-1998 Eric Young (eay@cryptsoft.com)
All rights reserved.

This package is an SSL implementation written by Eric Young (eay@cryptsoft.com).
The implementation was written so as to conform with Netscapes SSL.

This library is free for commercial and non-commercial use as long as the following conditions are adhered to. The following conditions apply to all code found in this distribution, be it the RC4, RSA, lhash, DES, etc., code; not just the SSL code. The SSL documentation included with this distribution is covered by the same copyright terms except that the holder is Tim Hudson (tjh@cryptsoft.com).

Copyright remains Eric Young's, and as such any Copyright notices in the code are not to be removed. If this package is used in a product, Eric Young should be given attribution as the author of the parts of the library used. This can be in the form of a textual message at program startup or in documentation (online or textual) provided with the package.

Redistribution and use in source and binary forms, with or without modification, are permitted provided that the following conditions are met:

1. Redistributions of source code must retain the copyright notice, this list of conditions and the following disclaimer.
2. Redistributions in binary form must reproduce the above copyright notice, this list of conditions and the following disclaimer in the documentation and/or other materials provided with the distribution.
3. All advertising materials mentioning features or use of this software must display the following acknowledgement:
"This product includes cryptographic software written by Eric Young (eay@cryptsoft.com)"
The word 'cryptographic' can be left out if the routines from the library being used are not cryptographic related :-).
4. If you include any Windows specific code (or a derivative thereof) from the apps directory (application code) you must include an acknowledgement:
"This product includes software written by Tim Hudson (tjh@cryptsoft.com)"

THIS SOFTWARE IS PROVIDED BY ERIC YOUNG "AS IS" AND ANY EXPRESS OR IMPLIED WARRANTIES, INCLUDING, BUT NOT LIMITED TO, THE IMPLIED WARRANTIES OF MERCHANTABILITY AND FITNESS FOR A PARTICULAR PURPOSE ARE DISCLAIMED. IN NO EVENT SHALL THE AUTHOR OR CONTRIBUTORS BE LIABLE FOR ANY DIRECT, INDIRECT, INCIDENTAL, SPECIAL, EXEMPLARY, OR CONSEQUENTIAL DAMAGES (INCLUDING, BUT NOT LIMITED TO, PROCUREMENT OF SUBSTITUTE GOODS OR SERVICES; LOSS OF USE, DATA, OR PROFITS; OR BUSINESS INTERRUPTION) HOWEVER CAUSED AND ON ANY THEORY OF LIABILITY, WHETHER IN CONTRACT, STRICT LIABILITY, OR TORT (INCLUDING NEGLIGENCE OR OTHERWISE) ARISING IN ANY WAY OUT OF THE USE OF THIS SOFTWARE, EVEN IF ADVISED OF THE POSSIBILITY OF SUCH DAMAGE.

The license and distribution terms for any publically available version or derivative of this code cannot be changed. i.e. this code cannot simply be copied and put under another distribution license [including the GNU Public License.]

This product contains NetBSD software, and can be used under the following licencing conditions.

Copyright (c) 1990 The Regents of the University of California.
All rights reserved.

This code is derived from software contributed to Berkeley by Chris Torek.

Redistribution and use in source and binary forms, with or without modification, are permitted provided that the following conditions are met:

1. Redistributions of source code must retain the above copyright notice, this list of conditions and the following disclaimer.
2. Redistributions in binary form must reproduce the above copyright notice, this list of conditions and the following disclaimer in the documentation and/or other materials provided with the distribution.
3. Neither the name of the University nor the names of its contributors may be used to endorse or promote products derived from this software without specific prior written permission.

THIS SOFTWARE IS PROVIDED BY THE REGENTS AND CONTRIBUTORS "AS IS" AND ANY EXPRESS OR IMPLIED WARRANTIES, INCLUDING, BUT NOT LIMITED TO, THE IMPLIED WARRANTIES OF MERCHANTABILITY AND FITNESS FOR A PARTICULAR PURPOSE ARE DISCLAIMED. IN NO EVENT SHALL THE REGENTS OR CONTRIBUTORS BE LIABLE FOR ANY DIRECT, INDIRECT, INCIDENTAL, SPECIAL, EXEMPLARY, OR CONSEQUENTIAL DAMAGES (INCLUDING, BUT NOT LIMITED TO, PROCUREMENT OF SUBSTITUTE GOODS OR SERVICES; LOSS OF USE, DATA, OR PROFITS; OR BUSINESS INTERRUPTION) HOWEVER CAUSED AND ON ANY THEORY OF LIABILITY, WHETHER IN CONTRACT, STRICT LIABILITY, OR TORT (INCLUDING NEGLIGENCE OR OTHERWISE) ARISING IN ANY WAY OUT OF THE USE OF THIS SOFTWARE, EVEN IF ADVISED OF THE POSSIBILITY OF SUCH DAMAGE.

This product contains NetBSD software, and can be used under the following licencing conditions.

Copyright (c) 1989 The Regents of the University of California.
All rights reserved.

This code is derived from software contributed to Berkeley by Tom Truscott.

Redistribution and use in source and binary forms, with or without modification, are permitted provided that the following conditions are met:

1. Redistributions of source code must retain the above copyright notice, this list of conditions and the following disclaimer.
2. Redistributions in binary form must reproduce the above copyright notice, this list of conditions and the following disclaimer in the documentation and/or other materials provided with the distribution.
3. All advertising materials mentioning features or use of this software must display the following acknowledgement:
This product includes software developed by the University of California, Berkeley and its contributors.
4. Neither the name of the University nor the names of its contributors may be used to endorse or promote products derived from this software without specific prior written permission.

THIS SOFTWARE IS PROVIDED BY THE REGENTS AND CONTRIBUTORS "AS IS" AND ANY EXPRESS OR IMPLIED WARRANTIES, INCLUDING, BUT NOT LIMITED TO, THE IMPLIED WARRANTIES OF MERCHANTABILITY AND FITNESS FOR A PARTICULAR PURPOSE ARE DISCLAIMED. IN NO EVENT SHALL THE REGENTS OR CONTRIBUTORS BE LIABLE FOR ANY DIRECT, INDIRECT, INCIDENTAL, SPECIAL, EXEMPLARY, OR CONSEQUENTIAL DAMAGES (INCLUDING, BUT NOT LIMITED TO, PROCUREMENT OF SUBSTITUTE GOODS OR SERVICES; LOSS OF USE, DATA, OR PROFITS; OR BUSINESS INTERRUPTION) HOWEVER CAUSED AND ON ANY THEORY OF LIABILITY, WHETHER IN CONTRACT, STRICT LIABILITY, OR TORT (INCLUDING NEGLIGENCE OR OTHERWISE) ARISING IN ANY WAY OUT OF THE USE OF THIS SOFTWARE, EVEN IF ADVISED OF THE POSSIBILITY OF SUCH DAMAGE.

This product contains NetBSD software, and can be used under the following licencing conditions.

Copyright (c) 1990, 1993

The Regents of the University of California. All rights reserved.

This code is derived from software contributed to Berkeley by Chris Torek.

Redistribution and use in source and binary forms, with or without modification, are permitted provided that the following conditions are met:

1. Redistributions of source code must retain the above copyright notice, this list of conditions and the following disclaimer.
2. Redistributions in binary form must reproduce the above copyright notice, this list of conditions and the following disclaimer in the documentation and/or other materials provided with the distribution.
3. Neither the name of the University nor the names of its contributors may be used to endorse or promote products derived from this software without specific prior written permission.

THIS SOFTWARE IS PROVIDED BY THE REGENTS AND CONTRIBUTORS "AS IS" AND ANY EXPRESS OR IMPLIED WARRANTIES, INCLUDING, BUT NOT LIMITED TO, THE IMPLIED WARRANTIES OF MERCHANTABILITY AND FITNESS FOR A PARTICULAR PURPOSE ARE DISCLAIMED. IN NO EVENT SHALL THE REGENTS OR CONTRIBUTORS BE LIABLE FOR ANY DIRECT, INDIRECT, INCIDENTAL, SPECIAL, EXEMPLARY, OR CONSEQUENTIAL DAMAGES (INCLUDING, BUT NOT LIMITED TO, PROCUREMENT OF SUBSTITUTE GOODS OR SERVICES; LOSS OF USE, DATA, OR PROFITS; OR BUSINESS INTERRUPTION) HOWEVER CAUSED AND ON ANY THEORY OF LIABILITY, WHETHER IN CONTRACT, STRICT LIABILITY, OR TORT (INCLUDING NEGLIGENCE OR OTHERWISE) ARISING IN ANY WAY OUT OF THE USE OF THIS SOFTWARE, EVEN IF ADVISED OF THE POSSIBILITY OF SUCH DAMAGE.

This product contains XML parser library, and can be used under the following licencing conditions.

Copyright (c) 1998, 1999, 2000 Thai Open Source Software Center Ltd

Permission is hereby granted, free of charge, to any person obtaining a copy of this software and associated documentation files (the "Software"), to deal in the Software without restriction, including without limitation the rights to use, copy, modify, merge, publish, distribute, sublicense, and/or sell copies of the Software, and to permit persons to whom the Software is furnished to do so, subject to the following conditions:

The above copyright notice and this permission notice shall be included in all copies or substantial portions of the Software.

THE SOFTWARE IS PROVIDED "AS IS", WITHOUT WARRANTY OF ANY KIND, EXPRESS OR IMPLIED, INCLUDING BUT NOT LIMITED TO THE WARRANTIES OF MERCHANTABILITY, FITNESS FOR A PARTICULAR PURPOSE AND NONINFRINGEMENT. IN NO EVENT SHALL THE AUTHORS OR COPYRIGHT HOLDERS BE LIABLE FOR ANY CLAIM, DAMAGES OR OTHER LIABILITY, WHETHER IN AN ACTION OF CONTRACT, TORT OR OTHERWISE, ARISING FROM, OUT OF OR IN CONNECTION WITH THE SOFTWARE OR THE USE OR OTHER DEALINGS IN THE SOFTWARE.