

Panasonic[®]

Owner's Manual for advanced features Digital Camera

Model No. **DMC-ZS9**
DMC-ZS8/
DMC-TZ18

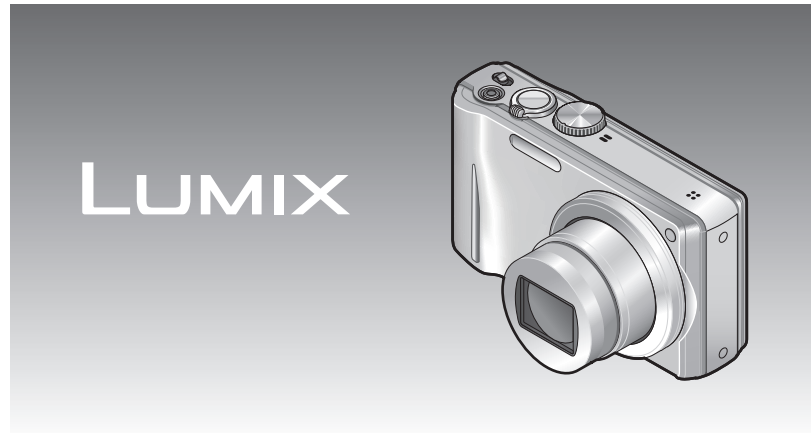

Before connecting, operating or adjusting this product,
please read the instructions completely.



Contents

Before use

Before use	5
Standard Accessories	7
Names of parts	8
Cursor button	8

Preparations

Charging the battery	9
Guidelines for the number of recordable pictures and operating time	10
Inserting and removing the card (optional)/the battery	12
Using the AC adaptor (optional) and DC coupler (optional) instead of the battery	13
Picture save destination (cards and built-in memory)	14
Remaining battery and memory capacity	15
Recording capacity guidelines (pictures/recording time)	15
Setting the clock	16
Setting the menu	17
Menu type	18
Using the [Setup] menu	19
[Clock Set]	19
[World Time]	19
[Travel Date]	19
[Beep]	19
[Volume]	19
[Cust.Set Mem.]	20
[LCD Mode]	20
[Guide Line]	20
[Histogram]	20
[Zoom Resume]	21
[Economy]	21
[Auto Review]	21
[No.Reset]	22
[Reset]	22
[USB Mode]	22
[Output]	23
[Rotate Disp.]	23
[Version Disp.]	23
[Format]	23
[Language]	24
[Demo Mode]	24

Basics

Basic shooting operation	25
Taking still pictures	25
Recording motion pictures	25
Mode dial	26
Taking pictures with automatic settings [Intelligent Auto] Mode	27
About Happy colors	29
Face Detection and Face Recognition	29
AF Tracking	29
Taking pictures with your own settings [Program AE] Mode	30
Aligning the focus	31
Taking pictures with zoom	32
[i.ZOOM]	34
Easy Zoom:	
For zooming rapidly to maximum ratio	35
[Digital Zoom]	36
Viewing your pictures [Normal Play]	37
Deleting pictures	38
To delete multiple (up to 50) or all pictures	38

Application (Record)

Changing recording information display	39
Taking pictures with flash	40
Taking close-up pictures	42
Taking close-up pictures without standing close to subject "Tele macro" function	42
Taking pictures at even closer range [Macro Zoom]	43
Positioning camera and subject within accessible range for focus alignment	44
Focus range	44
Taking pictures with self-timer	45
Taking pictures with Exposure Compensation	46
Recording while exposure is changed automatically ([Auto Bracket])	47
Determine aperture and record [Aperture-Priority] Mode	48
Determine shutter speed and record [Shutter-Priority] Mode	49
Determine aperture and shutter speed and record [Manual Exposure] Mode	50
Register your own settings and record [Custom] Mode	51
[Cust.Set Mem.]	
Registering your own settings	51
[Custom]	
Switch to your own settings and record	52
Taking pictures according to the scene [Scene Mode]	53
[Portrait]	54
[Soft Skin]	54
[Transform]	54
[Self Portrait]	54
[Scenery]	54
[Panorama Assist]	55
[Sports]	55
[Night Portrait]	55
[Night Scenery]	55
[Food]	56
[Party]	56
[Candle Light]	56
[Baby]	56
[Pet]	56

[Sunset]	56
[High Sens.]	56
[Hi-Speed Burst]	57
[Flash Burst]	57
[Starry Sky]	57
[Fireworks]	58
[Beach]	58
[Snow]	58
[Aerial Photo]	58
[Pin Hole]	58
[Film Grain]	58
[High Dynamic]	59
[Photo Frame]	59
[Underwater]	59
Saving commonly used scenes [My Scene Mode]	60
Taking motion pictures [Motion Picture] Mode	61
[Rec Quality]	62
Recording with the Face Recognition function [Face Recog.]	63
Registering face pictures	64
Editing or deleting information about registered persons	66
Useful features for travel	68
[Travel Date]	68
[World Time]	69
Using the [Rec] menu	70
[Aspect Ratio]	70
[Picture Size]	70
[Quality]	71
[Sensitivity]	71
[White Balance]	72
[AF Mode]	74
[Quick AF]	76
[Face Recog.]	76
[Metering Mode]	76
[i.Exposure]	77
[Min. Shtr Speed]	77
[i.Resolution]	77
[Digital Zoom]	78
[Burst]	78
[Color Mode]	79
[AF Assist Lamp]	80
[Red-Eye Removal]	80
[Stabilizer]	80
[Date Stamp]	81
[Clock Set]	81

Contents (Continued)

Using the [Rec] menu for motion pictures.....	82
[Rec Quality]	82
[Continuous AF].....	82
[Wind Cut]	82
Using Quick menu.....	83
Entering Text.....	84
Application (View)	
Viewing as list (Multi Playback/ Calendar Playback)	85
Watching motion pictures	86
Different playback methods [Playback Mode]	87
[Slide Show]	88
[Filtering Play]	90
[Calendar].....	90
Using the [Playback] menu.....	91
[Upload Set]	91
[Title Edit]	92
[Text Stamp]	93
[Resize]	95
[Cropping].....	96
[Favorite]	97
[Print Set]	98
[Protect].....	99
[Face Rec Edit].....	100
[Copy].....	101

Connecting with other devices

Using with your PC.....	102
Copying still pictures and motion pictures ...	103
Using "PHOTOfunSTUDIO" to copy pictures to your computer	105
Uploading pictures to image-sharing websites	105
Printing.....	106
Printing multiple pictures	107
Print with date and text.....	107
Making print settings on the camera	108
Viewing on TV screen	109

Others

List of LCD monitor displays.....	110
In recording	110
In playback	111
Message displays.....	112
Q&A Troubleshooting	114
Usage cautions and notes	120

Before use

■ Camera handling

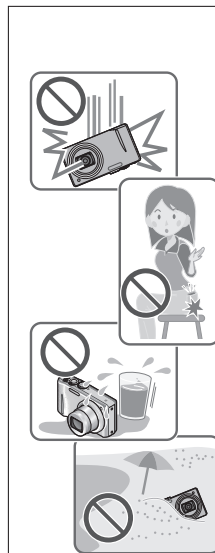

Keep the camera away from excessive vibration, force, or pressure.

- Avoid using the camera under the following conditions, which may damage the lens, LCD monitor, or camera body. This may also cause the camera to malfunction or prevent recording.
 - Dropping or hitting the camera against a hard surface
 - Sitting down with the camera in your pants pocket or forcing it into a full bag
 - Adding accessories to the camera strap
 - Pushing with excessive force on the lens or LCD monitor

The camera is not dust resistant, splash resistant, or waterproof.

Avoid using the camera in places with excessive dust or sand, or where water can come into contact with the camera.

- Avoid using the camera under the following conditions, which present a risk that sand, water, or foreign material may enter the camera through the lens or openings around buttons. Be especially careful, because these conditions may damage the camera and such damage may not be repairable.
 - In extremely dusty or sandy places
 - In the rain or by the shore, where the camera may be exposed to water

■ Condensation (lens clouding)

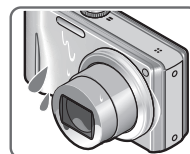

- Condensation may occur when the camera is exposed to sudden changes of temperature or humidity. Avoid these conditions, which may make the lens dirty, cause mold, or damage the camera.
- If condensation does occur, turn off the camera and wait about two hours before using it. Once the camera adjusts to the surrounding temperature, clouded lenses will clear naturally.

Before use (Continued)

■ Always take a test shot first

Before important events when you will use the camera (at weddings, for example), always take a test shot to make sure that pictures and sound record correctly.

■ No compensation for missed shots

We cannot compensate for missed shots if technical problems with the camera or card prevent recording.

■ Carefully observe copyright laws.

Unauthorized use of recordings which contain works with copyright for purposes other than personal use is prohibited under copyright law. Recording of certain material may be restricted even for the purpose of personal use.

■ Also refer to “Usage cautions and notes” (→120)

Standard Accessories

Check that all the accessories are supplied before using the camera.

- The accessories and their shape will differ depending on the country or area where the camera was purchased.

For details on the accessories, refer to Basic Owner's Manual.

- Battery pack is indicated as battery pack or battery in the text.
- Battery charger is indicated as battery charger or charger in the text.
- Please dispose of all packaging appropriately.
- Keep small parts in a safe place out of the reach of children.

■ Optional accessories

- Cards are optional. You can record or play back pictures on the built-in memory when you are not using a card. (→14)
- If any accessories are lost, customers in the USA and Puerto Rico should contact Panasonic's parts department at 1-800-833-9626 and customers in Canada should contact 1-800-99-LUMIX (1-800-995-8649) for further information about obtaining replacement parts.

Names of parts

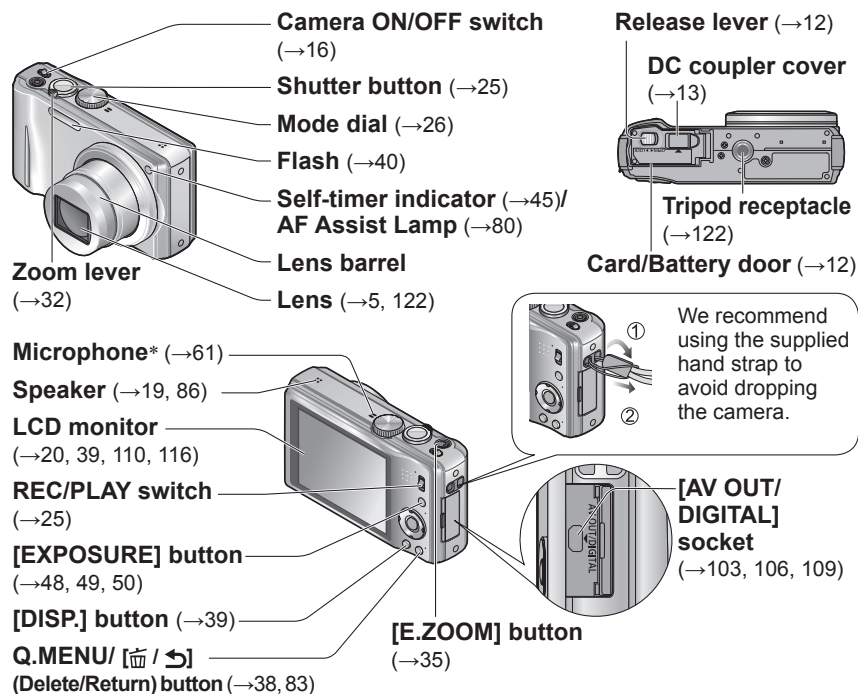

Cursor button

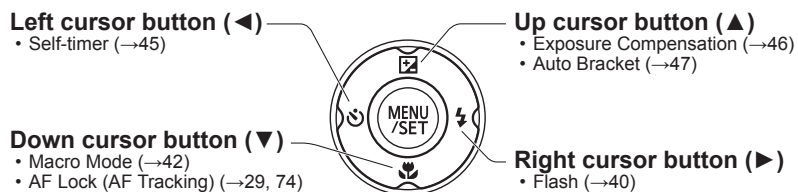

● In this manual, the button that is used is shaded or indicated by ▲ ▼ ▶ ◀.

● The appearance, specifications, and screen display vary depending on the model that is used.

● The above illustration is of the DMC-ZS8/DMC-TZ18.

* The DMC-ZS9 has a stereo microphone.

Charging the battery

Always charge before first use! (battery shipped uncharged)

■ About batteries that you can use with this unit

It has been found that counterfeit battery packs which look very similar to the genuine products are made available to purchase in some markets. Some of these battery packs are not adequately protected with internal protection to meet the requirements of appropriate safety standards. There is a possibility that these battery packs may lead to fire or explosion. Please be advised that we are not liable for any accident or failure occurring as a result of use of a counterfeit battery pack. To ensure that safe products are used we recommend that a genuine Panasonic battery pack is used.

- Use the dedicated charger and battery.
- The camera has a function for distinguishing batteries which can be used safely. The dedicated battery supports this function. The only batteries suitable for use with this unit are genuine Panasonic products and batteries manufactured by other companies and certified by Panasonic. (Batteries which do not support this function cannot be used). Panasonic cannot in any way guarantee the quality, performance or safety of batteries which have been manufactured by other companies and are not genuine Panasonic products.

1 Insert the battery terminals and attach the battery to the charger

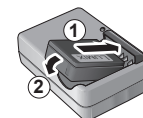

2 Connect the charger to the electrical outlet

- Plug-in type
- Inlet type

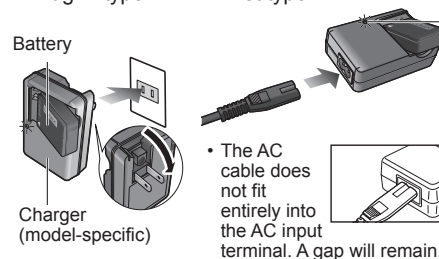

Charging light ([CHARGE])

On: Charging in progress (Approx. 130 min. if fully depleted)

Off: Charging complete

If light is flashing:

- Charging may take longer than normal if battery temperature is too high or too low (charging may be incomplete).
- Battery/charger connector is dirty. Clean with a dry cloth.

3 Detach the battery after charging is completed

Charging the battery (Continued)

Guidelines for the number of recordable pictures and operating time

The number of recordable pictures or available operating time may vary according to surrounding environment and usage conditions. Figures may be reduced if flash, zoom, or other functions are used frequently, or in colder climates.

Number of recordable pictures	Approx. 340 pictures	By CIPA standard
Recording time	Approx. 170 min	

● Recording conditions by CIPA standard

- CIPA is an abbreviation of [Camera & Imaging Products Association].
- [Program AE] Mode
- Temperature: 23 °C (73.4 °F)/Humidity: 50 %RH when LCD monitor is on.*
- Using a Panasonic SD Memory Card (32 MB).
- Using the supplied battery.
- Starting recording 30 seconds after the camera is turned on. (When the Optical Image Stabilizer function is set to [ON].)
- Recording once every 30 seconds with full flash every second recording.
- Rotating the zoom lever from Tele to Wide or vice versa in every recording.
- Turning the camera off every 10 recordings and leaving it until the temperature of the battery decreases.

* The number of recordable pictures decreases when [LCD Mode] is used.

Number reduced if intervals are longer – e.g. to approx. one quarter for 2-minute intervals under the above conditions.

Playback time	Approx. 300 minutes
---------------	---------------------

- The time required for charging varies depending on conditions of battery usage. Charging takes longer at high or low temperatures and when the battery has not been used in some time.
- Battery will be warm during charging and for some time thereafter.
- Battery will run out if not used for long periods of time, even after being charged.
- Charge the battery with the charger indoors (10 °C - 30 °C (50 °F - 86 °F)).
- Keep any metal items (such as clips) away from the contact areas of the power plug. Otherwise, a fire and/or electric shocks may be caused by short-circuiting or the resulting heat generated.
- We do not recommend frequently charging the battery. (Frequently charging battery reduces maximum usage time and can cause battery to expand.)
- Do not disassemble or modify the charger.
- If available battery power is significantly reduced, battery is reaching end of lifespan. Please purchase a new battery.
- The battery charger is in the standby condition when the AC power is supplied. The primary circuit is always “live” as long as the battery charger is connected to an electrical outlet.
- When charging:
 - Remove any dirt on connectors of charger and battery with dry cloth.
 - Keep at least 1 m (3.28 feet) away from AM radio (may cause radio interference).
 - Noises may be emitted from inside of charger, but this is not a fault.
 - After charging, remove the charger from the wall socket, and then remove the battery from the charger (up to 0.1 W consumed if left in place).
- Do not use a damaged or dented battery (especially connectors), e.g. by dropping (can cause faults).

Inserting and removing the card (optional)/ the battery

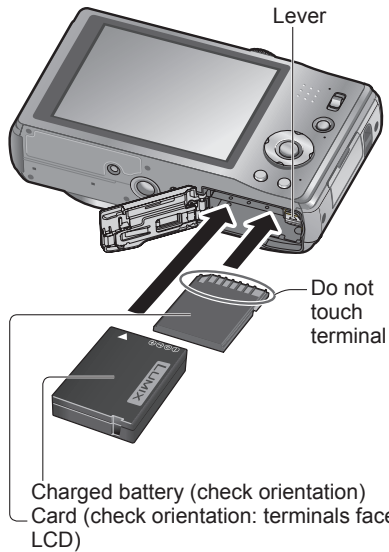

■ To remove

- **To remove battery:**
move lever in direction of arrow.

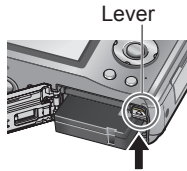

- 1 Set the camera ON/OFF switch to OFF
Slide to the [OPEN] position and open the lid

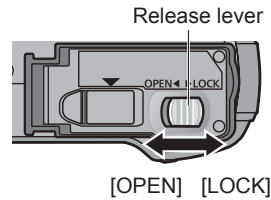

- 2 **Insert the battery and card, making sure that their orientation is correct**

- Battery: Insert all the way firmly until a locking sound is heard, and check that the lever is hooked over the battery.
- Card: Insert all the way firmly until it clicks.

- 3 **Close lid**
Slide to the [LOCK] position.

- **To remove card:**
press down in center.

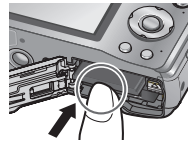

- Always use genuine Panasonic batteries.
- If you use other batteries, we cannot guarantee the quality of this product.
- **Remove battery from camera after use.**
 - Keep the battery in a plastic bag, making sure that it is kept away from metallic objects (such as clips) when carrying or storing the battery.
- To remove the card or battery, turn the camera off and wait until the LUMIX indicator on the LCD monitor goes off. (Failure to wait may cause the camera to malfunction and may damage the card or recorded data.)
- Keep the Memory Card out of reach of children to prevent swallowing.
- The unusable battery should be discarded in accordance with battery recycling laws. Call the RBRC hotline at 1-800-822-8837 for information.

Using the AC adaptor (optional) and DC coupler (optional) instead of the battery

By using the AC adaptor (optional) and DC coupler (optional), you can record and play back without worrying about the remaining battery charge. The optional DC coupler can only be used with the designated Panasonic AC adaptor.

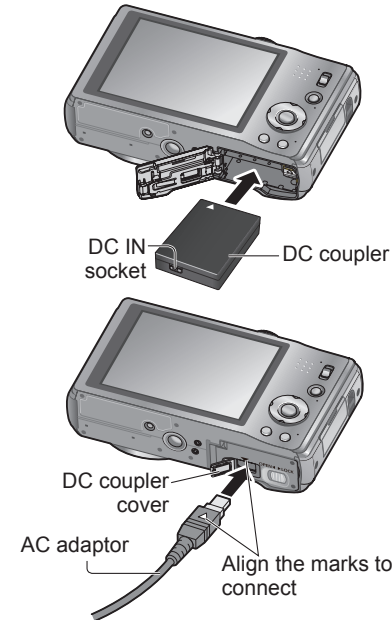

- 1 **Insert DC coupler instead of battery (previous page)**

- 2 **Open DC coupler cover**
 - If difficult to open, with the card/battery door open, press the coupler cover from the inside to open it.

- 3 **Plug AC adaptor into power outlet**

- 4 **Connect AC adaptor to DC IN socket of DC coupler**

- Always use a genuine Panasonic AC adaptor (optional).
- Use the AC adaptor and DC coupler specifically for this camera. Using other adaptors or couplers could cause camera failure.
- The possibility to install the camera on a tripod or unipod when the DC coupler is connected depends on the type of tripod or unipod.
- When the AC adaptor is connected, always remove the AC adaptor when opening the card/battery door.
- Remove the AC adaptor and DC coupler when not in use and close the coupler cover.
- Also read the AC adaptor and DC coupler operating instructions.

Inserting and removing the card (optional)/ the battery (Continued)

Picture save destination (cards and built-in memory)

■ Built-in memory (Approx. 70 MB)

- Pictures may be copied between cards and the built-in memory. (→101)
- The access time for the built-in memory may be longer than the access time for a card.

■ Compatible memory cards (optional)

The following SD standard-based cards (Panasonic brand recommended)

Type of Card	Capacity	Notes
SD Memory Cards	8 MB – 2 GB	<ul style="list-style-type: none"> • Using a card of SD Speed "Class 6"* or above is recommended for recording motion pictures. • Can be used with devices compatible with the respective formats. • Before using SDXC Memory Cards, check that your computer and other devices support this type of card. http://panasonic.net/avc/sdcard/information/SDXC.html • Only the cards listed on the left with the given capacities are supported.
SDHC Memory Cards	4 GB – 32 GB	
SDXC Memory Cards	48 GB, 64 GB	

* SD speed class refers to a specification for sustained write speeds. Confirm the SD speed by checking the card label or other card related materials.

(Example) **CLASS 6**

- Please reformat the card with this camera if it has already been formatted with a computer or another device. (→23)
- If the write-protect switch is set to "LOCK", the card cannot be used to record or delete pictures, and it cannot be formatted.
- It is recommended that you copy important pictures to your computer (as electromagnetic waves, static electricity, or faults may cause data to be damaged).
- Latest information:
<http://panasonic.jp/support/global/cs/dsc/> (This Site is English only.)

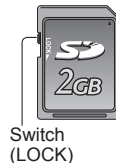

Remaining battery and memory capacity

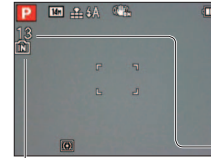

Remaining battery (only when using battery)



If the battery mark flashes red, recharge or replace battery.

Estimated remaining pictures or recording time capacity (press [DISP.] button to switch display)

Displayed when no card is inserted (pictures will be saved to built-in memory)

When in operation

(Card) or (Built-in memory) are illuminated red.

While the light remains lit, an operation is taking place, such as picture writing, reading, deletion or formatting. While the light is lit, do not turn off the power or remove battery, card, AC adaptor (optional) or DC coupler (optional), as this can cause data loss or damage. Keep the camera away from vibrations, impact, or static electricity. Should any of these cause camera operation to be terminated, attempt to perform the operation again.

Recording capacity guidelines (pictures/recording time)

The number of pictures you can take and the recording time varies in proportion to card capacity (and depending on recording conditions and type of card).

- When [Upload Set] is set, the number of pictures that can be recorded or the recording time may decrease.

■ Recording picture capacity (still pictures)

[Picture Size]	Built-in memory	2 GB	4 GB	16 GB
14M	13	330	670	2740
5M	26	650	1300	5300
0.3M	410	10050	19940	81340

- When the number of recordable pictures exceeds 99,999, "+99999" is displayed.

■ Recording time capacity (motion pictures)

[Rec Quality]	Built-in memory		2 GB		4 GB	
	*1	*2	*1	*2	*1	*2
[HD]	—	—	8 min 10 s	8 min 10 s	16 min 20 s	16 min 10 s
[VGA]	—	—	21 min 40 s	21 min 20 s	43 min 10 s	42 min 20 s
[QVGA]	2 min 30 s	2 min 20 s	1 h 2 min	59 min 10 s	2 h 4 min	1 h 57 min

- Motion pictures can be recorded continuously up to 2 GB. To record more than 2 GB, press the shutter button again. (Remaining time for continuous recording is displayed on the screen.) The time displayed in the table is the total time.

*1 DMC-ZS8/DMC-TZ18 *2 DMC-ZS9

Setting the clock

(The clock is not set when the camera is shipped.)

Set REC/PLAY switch to before turning on the power.



REC/PLAY switch

[MENU/SET]

To change time setting

Select [Clock Set] from the [Setup] menu, perform **5** and **6**.

- Clock settings will be saved for approx. 3 months even after battery is removed, provided a fully-charged battery was installed in the camera for 24 hours beforehand.

- 1 Turn on the power**
The power is turned on.
If the language select screen is not displayed, proceed to step **4**.
- 2 Press [MENU/SET] while the message is displayed**
- 3 Press ▲ ▼ to select the language, and press [MENU/SET]**
The [Please set the clock] message appears. (This message does not appear in Playback Mode.)
- 4 Press [MENU/SET]**
- 5 Press ◀ ▶ to select the items (year, month, day, hour, minute, display order or time display format), and press ▲ ▼ to set**

Select either [24hrs] or [AM/PM] for the time display format.

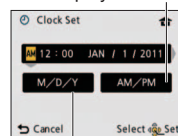

Select the display order for the day, month, and year ([M/D/Y], [D/M/Y], or [Y/M/D]).

- To cancel → Press .

- 6 Press [MENU/SET]**
- 7 Confirm the setting and press [MENU/SET]**

Turn on the power again and check the time display. (Time and date can be displayed by pressing [DISP.] several times.)

- Failure to set the date and time will cause the date/time to be improperly printed when printing pictures at a digital photo center or when using [Date Stamp] or [Text Stamp].
- After the time has been set, the date can be printed correctly even if the date is not displayed on the camera screen.

Setting the menu

Refer to the following procedures to operate the menus.

(Example) While in [Program AE] Mode, change [LCD Mode] on the [Setup] menu.
(REC/PLAY switch: set to ; mode dial: set to P)

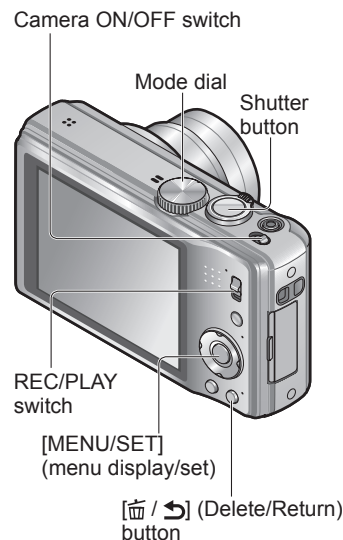

Camera ON/OFF switch

Mode dial

Shutter button

REC/PLAY switch

[MENU/SET] (menu display/set)

(Delete/Return) button

- 1 Bring up the menu**
- 2 Select the [Setup] menu**
- 3 Select the item**
- 4 Select the setting**
- 5 Press several times**

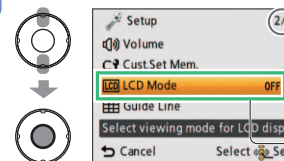
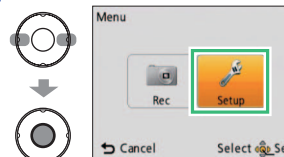

Page (Zoom lever can be used to switch to next screen.)

Item

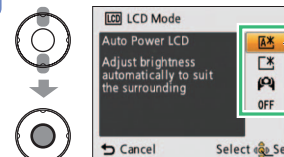

Selected setting

Settings

- The menu closes and the monitor returns to the previous screen.

Setting the menu (Continued)

Menu type

[Rec] menu (REC/PLAY switch: )

[Motion Picture] menu (REC/PLAY switch: )

Changing picture preferences (→70 - 82)

- Displays settings such as White Balance, Sensitivity, Aspect Ratio, and Picture Size.

[Setup] menu (REC/PLAY switch:  )

Making the camera more convenient to use (→19 - 24)

- Displays settings for ease of use such as adjusting the clock and changing the beep sounds.

[Playback Mode] menu (REC/PLAY switch: )

Viewing recorded pictures (→87 - 90)

- Choose a playback mode to see Slide Shows or to narrow down the pictures for display, etc.

[Playback] menu (REC/PLAY switch: )

Using your pictures (→91 - 101)







- Enables you to specify picture protection, cropping, and printing settings for pictures you have taken.









- The operation screen examples in this manual may differ from the actual screen display or some parts of the screen display are omitted.
- The menu types and items that are displayed vary according to the mode.
- The setting methods vary depending on the menu item.
- In Recording Mode, the menu screen can also be exited by pressing the shutter button halfway.





Using the [Setup] menu







For details about the setting procedure in the [Setup] menu (→17)









[Clock Set], [Economy] and [Auto Review] are important for clock setting and battery life. Please check these before use.

Item	Settings, notes
 [Clock Set] (→16)	Set time, date, and display format.
 [World Time] Set the local time at travel destination. (→69)	 [Destination]: Set the local time at travel destination.  [Home]: Set date and time at home area.
 [Travel Date] Record the number of days elapsed in your travels. (→68)	[Travel Setup] [SET] (Register departure and return dates.)/ [OFF]
	[Location] [SET] (Input name of destination.)/ [OFF]
 [Beep] Change or mute the beep/shutter sounds.	[Beep Level] □□ / □□□ / □□□□ : Low/High/Mute
	[Beep Tone] ●● / ●●● / ●●●● : Change beep tone.
	[Shutter Vol.] □□ / □□□ / □□□□ : Low/High/Mute
	[Shutter Tone] ●● / ●●● / ●●●● : Change shutter tone.
 [Volume] Adjust volume of sound from speakers (7 levels).	[0] / [1] / [2] / [3] / [4] / [5] / [6] • Cannot be used to adjust TV speaker volume when connected to TV.

Item	Settings, notes
 [Cust.Set Mem.] Register settings on current camera. (→51)	[C1] / [C2] / [C3]
 [LCD Mode] Make LCD monitor easier to see.	<p> [Auto Power LCD]: The brightness is adjusted automatically depending on how bright it is around the camera.</p> <p> [Power LCD]: Makes screen brighter than normal (for outdoor use).</p> <p> [High Angle]: Makes screen easier to see when taking pictures from high positions. (becomes harder to see from the front)</p> <p>[OFF]</p> <ul style="list-style-type: none"> • [Auto Power LCD] does not work in Playback Mode. • [Power LCD] returns to ordinary brightness if there is no operation for 30 seconds when recording. (Press any button to make brighter again). • [High Angle] will be canceled when power is turned off. • Because the picture shown on the LCD monitor screen emphasizes brightness, some subjects may look different than their actual appearance, but this will not affect the recorded picture. • Setting [LCD Mode] will reduce the number of pictures that can be recorded and recording time.
 [Guide Line] Select recording information display and types of guidelines. (→39)	<p>[Rec. Info.] [ON] (Display recording information with guide lines.) [OFF]</p> <p>[Pattern]  /  : Change the patterns of guide lines.</p>
 [Histogram] Check subject brightness on graph. (→39)	[ON]/[OFF]

Item	Settings, notes
 [Zoom Resume] Remember the zoom position when turning the power off.	[ON]/[OFF] <ul style="list-style-type: none"> • Cannot be set when using [Self Portrait] Scene Mode.
 [Economy] Turn off the power or make the LCD monitor go dark while not using the camera to minimize battery consumption.	<p> [Sleep Mode] [2 MIN.]/[5 MIN.]/[10MIN.]/[OFF]: Automatically shut off power while not in use.</p> <ul style="list-style-type: none"> • To restore → Press the shutter button halfway, or turn on the power again. • Cannot be used in the following cases: When using AC adaptor (optional) and DC coupler (optional), when connected to computer/printer, during motion picture recording/playback, during Slide Shows, during automatic demo playback • Settings fixed to [5 MIN.] in [Intelligent Auto] Mode. <p> [LCD Power Save] [ON]/[OFF]: The LCD monitor goes dark to minimize power consumption.</p> <ul style="list-style-type: none"> • Reduces the picture quality of the LCD monitor display during recording to minimize battery consumption (except for the Digital Zoom area). Note, however, that there is no effect on the recorded picture. • The setting in [LCD Mode] is prioritized over the setting in [LCD Power Save] for the brightness of the LCD monitor.
 [Auto Review] Automatically display still pictures immediately after taking them.	<p>[1 SEC.]/[2 SEC.] [HOLD]: Auto review screen remains until a button (other than the [DISP.] button) is pressed</p> <p>[OFF]</p> <ul style="list-style-type: none"> • Fixed to [2 SEC.] in [Intelligent Auto] Mode. • In [Panorama Assist], [Hi-Speed Burst], [Flash Burst], and [Photo Frame] Scene Modes, or in [Auto Bracket], and [Burst] Modes, Auto Review is performed regardless of setting. • Motion pictures cannot be automatically reviewed.

Item	Settings, notes
 [No.Reset] Reset picture file numbers.	<ul style="list-style-type: none"> The folder number is updated and the file number starts from 0001. A folder number between 100 and 999 can be assigned. Numbers cannot be reset once folder number reaches 999. In this case, save all necessary pictures to your computer, and format the built-in memory/card (→23). To reset folder number to 100: First, format the built-in memory or card, and reset the file numbers using [No.Reset]. Then, select [Yes] on the folder number reset screen.
 [Reset] Reset to the default settings.	<p>[Reset Rec. settings?]</p> <p>[Reset setup parameters?]</p> <ul style="list-style-type: none"> Information registered in [Face Recog.] is reset if recording settings are reset. Resetting the setup parameters will also reset the following. Age in years/months and names in [Baby] and [Pet] Scene Modes. Folder numbers and clock settings will remain unchanged. Camera movement may be audible as the lens function is reset. This is normal.
 [USB Mode] Select communication method for when connecting camera to a computer or printer with USB connection cable.	<p> [Select on connection]: Select [PC] or [PictBridge(PTP)] each time you connect to a computer or PictBridge-compatible printer.</p> <p> [PictBridge(PTP)]: Select when connecting to a PictBridge-compatible printer.</p> <p> [PC]: Select when connecting to a computer.</p>

Item	Settings, notes
 [Output] Operates when AV cable is connected.	<p> [Video Out] (DMC-ZS8PU/DMC-TZ18PR only.)</p> <p>[NTSC]/[PAL]</p> <ul style="list-style-type: none"> Change the video output format when connected to a TV, etc. (Playback Mode only). <p> [TV Aspect]</p> <p>16:9 / 4:3</p>
 [Rotate Disp.] Automatically rotate portrait still pictures.	<p> : Rotate Display is turned on.</p> <p> : Rotate Display is turned on for TV output only.</p> <p>[OFF]</p> <ul style="list-style-type: none"> [Rotate Disp.] cannot be used with motion pictures. Still pictures taken with the lens surface facing up or down, or still pictures taken on other cameras may not rotate. Pictures cannot be rotated during Multi Playback. Will only be displayed rotated on computer if in Exif-compatible (→37) environment (OS, software).
 [Version Disp.] Check the version of the camera firmware.	<p>Current version is displayed.</p>
 [Format] Use when [Built-In Memory Error] or [Memory Card Error] appears, or when formatting the built-in memory or card.	<ul style="list-style-type: none"> This requires a sufficiently charged battery, or an AC adaptor (optional) and DC coupler (optional). When formatting the built-in memory, remove the cards. (Only inserted card will be formatted if present; built-in memory will be formatted if no card is inserted.) Always format cards with this camera. All protected pictures and other picture data will be deleted. Do not turn off power or perform other operations during formatting. Formatting the built-in memory may take several minutes. Consult your nearest Service Center if format cannot be successfully completed. <p>When a card/built-in memory is formatted, the data cannot be restored. Check the content of the card/built-in memory carefully before formatting.</p>

Using the [Setup] menu (Continued)

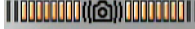
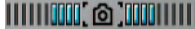

For details about the setting procedure in the [Setup] menu (→17)

Item	Settings, notes
 [Language] Change display language.	Set the language displayed on the screen.
DEMO [Demo Mode] View demonstration of functions.	<p>[Stabilizer Demo.]: Extent of jitter is shown on graph (estimate)</p> <p> Extent of jitter</p> <p> Extent of jitter after correction</p> <ul style="list-style-type: none"> • During demo screen display, the Optical Image Stabilizer switches ON and OFF every time [MENU/SET] is pressed. • Cannot display during Playback Mode.
	<p>[Auto Demo]: View introductory Slide Show [ON]/[OFF]</p> <ul style="list-style-type: none"> • To close → Press [MENU/SET] • [Auto Demo] cannot be displayed on external devices such as TVs.

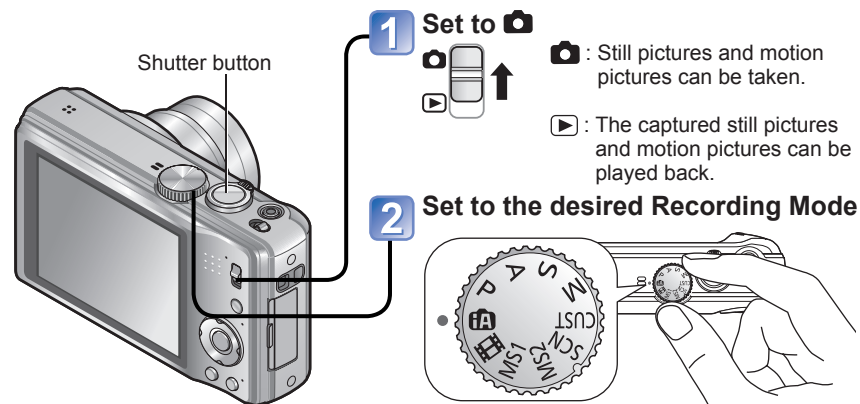
Basic shooting operation

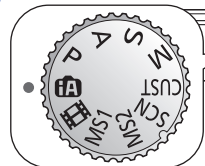

The illustration shows the DMC-ZS8/
DMC-TZ18.

- 1 Set to **
 : Still pictures and motion pictures can be taken.
 : The captured still pictures and motion pictures can be played back.
- 2 Set to the desired Recording Mode**

- 3 Aim the camera and shoot**

Align the mode dial correctly to the mode that you want to use.

Taking still pictures

Press the shutter button

- 1 Gently press the shutter button**



- 2 Press and hold the shutter button to take the picture**



Recording motion pictures

Press the shutter button

- 1 Gently press the shutter button**



- 2 Press and hold the shutter button to begin recording**



- 3 Press the shutter button again to finish recording**



Basic shooting operation (Continued)

■ Holding the camera

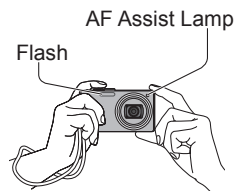

- Stand with your arms close to your body and with your legs apart.
- Do not touch the lens.
- Do not block the microphone when recording motion picture. (→8)
- Do not block the flash or the lamp. Do not look at it from close range.
- Make sure that the camera does not move at the moment the shutter button is pressed.
- We recommend the use of the hand strap to avoid dropping the camera.

Mode dial

iA [Intelligent Auto] Mode	Take pictures with automatic settings. (→27)
P [Program AE] Mode	Record pictures with your own settings. (→30)
A [Aperture-Priority] Mode	Determine aperture, then record pictures. (→48)
S [Shutter-Priority] Mode	Determine shutter speed, then record pictures. (→49)
M [Manual Exposure] Mode	Determine aperture and shutter speed, then record pictures. (→50)
CUST [Custom] Mode	Record pictures using pre-registered settings. (→51)
SCN [Scene Mode]	Take pictures according to scene. (→53)
MS1 MS2 [My Scene Mode]	Take pictures in frequently-used Scene Modes. (→60)
[Motion Picture] Mode	Take motion pictures. (→61)

Taking pictures with automatic settings

[Intelligent Auto] Mode

Recording Mode: **iA**

Optimum settings are made automatically from information such as “face”, “movement”, “brightness”, and “distance” just by pointing the camera at the subject, meaning that clear pictures can be taken without the need to make settings manually.

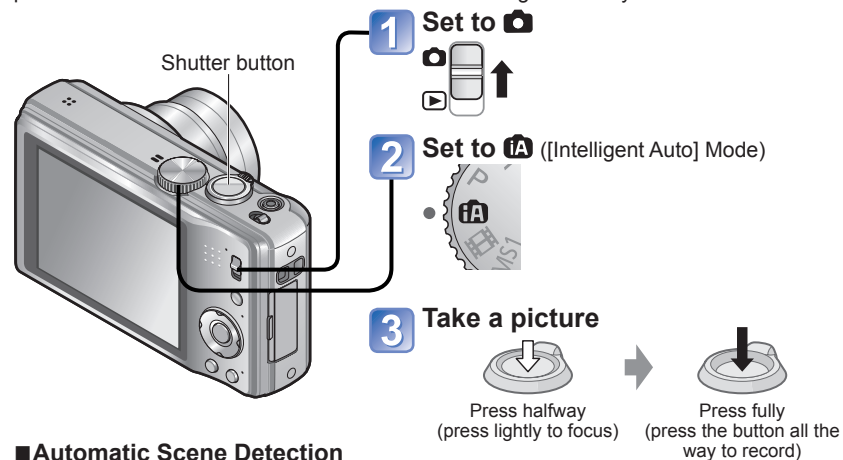

■ Automatic Scene Detection

Camera identifies the scene when pointed at the subject, and makes optimum settings automatically.

People are detected	People and night scenery are detected*2 (Only when iA is selected)
Baby is detected*1	
Scenery is detected	Night scenery is detected
A sunset is detected	A close-up shot is detected
iA Reads subject movement to avoid blurring when the scene does not correspond to any of the above.	

*1 When babies (under 3 years) that are registered with the Face Recognition function are recognized.

*2 We recommend using a tripod and the self-timer.

If the camera automatically identifies the scene and determines that people appear as subjects in the picture (, , , , , , , Face Detection is activated, and the focus and exposure are adjusted for the recognized faces.

● According to the following conditions, different scene types may be determined for the same subject:

Face contrast, conditions of subject (size, distance, coloring, contrast, movement), zoom ratio, sunset, sunrise, low brightness, jitter

● If undesired scene type is selected, we recommend manually selecting the appropriate Recording Mode.

● We recommend using a tripod and the self-timer with and .

Taking pictures with automatic settings

[Intelligent Auto] Mode (Continued)

Recording Mode: **IA**

■ To use flash



Select either **iFA** (Auto) or **iS** (Forced Flash Off).

- When **iFA** is used, **iFA**, **iFA** (Auto/Red-Eye Reduction), **iS** (Slow Sync./Red-Eye Reduction) and **iS** (Slow Sync.) are selected automatically according to the subject type and brightness. For details (→40).
- **iFA** and **iS** indicate that digital red-eye correction is activated.
- The shutter speed is slower in **iS** and **iS**.

- Focus range (→44).
- The following menu items may be set in [Intelligent Auto] Mode:
 - [Rec] menu: [Picture Size]*1, [Burst], [Color Mode]*1, [Face Recog.]
 - [Setup] menu*2: [Clock Set], [World Time], [Beep]*1, [Language], [Stabilizer Demo.]
- *1 Items that may be set differ from other Recording Modes.
- *2 Other items on the [Setup] menu will reflect settings made in [Program AE] Mode, etc.
- Backlight Compensation:
Backlight refers to the light that shines from behind the subject. When this occurs, the subject appears darker, and so backlighting is automatically corrected by increasing the brightness of the entire image.
- The settings for the following functions are fixed:
 - [Auto Review]: [2 SEC.] • [Sleep Mode]: [5 MIN.] • [Guide Line]:
 - [White Balance]: [AWB] • [Quality]: (Fine) • [Sensitivity]: (ISO)
 - [Stabilizer]: [ON] • [AF Mode]: (Face Detection)*3
 - [AF Assist Lamp]: [ON] • [Quick AF]: [ON] • [Metering Mode]: (Multiple)
 - [i.Exposure]: [STANDARD] • [i.Resolution]: [i.ZOOM]
 - [Red-Eye Removal]: [ON] • [Continuous AF]: [ON]
- *3 (23-area-focusing) when face cannot be recognized
- The following functions cannot be used:
[Histogram], [Exposure], [Auto Bracket], [WB Adjust.], [Digital Zoom], [Min. Shtr Speed]

About Happy colors

If [Color Mode] is set to [Happy], still pictures are clearer, with more vivid coloring.

Face Detection and Face Recognition

If the camera automatically identifies the scene and determines that people appear as subjects in the picture (), Face Detection is activated, and the focus and exposure are adjusted for the recognized faces. (→63)

■ Face Recognition

The faces of people who are taken frequently can be registered together with their names, ages, and other information.
If pictures are taken with [Face Recog.] (→63) set to [ON], priority is given to the focus and exposure adjustments of the faces close to those that have been registered. Also, the camera memorizes detected faces during Face Detection, automatically recognizes faces which are taken frequently, and displays them on the face registration screen.

AF Tracking

Even if a subject, where the focus was locked (AF Lock) moves, the camera can continue to keep it in focus.

1 Set [AF Mode] to AF Tracking



- To cancel AF Tracking → Press **▲** again.



AF Tracking frame

2 Align the AF Tracking frame with the subject, and then lock.



- To cancel AF Lock → Press **▼**.
- The optimum scene is detected for the subject where the focus was locked (AF Lock).
- AF Tracking frame
AF Lock successful: Yellow
AF Lock failed: Red (flash)

- Face Recognition will be inactive while using AF Tracking.
- Under certain recording conditions, such as when the subject is small or when it is dark, [AF Tracking] may not operate correctly.

Taking pictures with your own settings

[Program AE] Mode

Recording Mode: **P**

Using the [Rec] menu to change settings and set up your own recording environment.

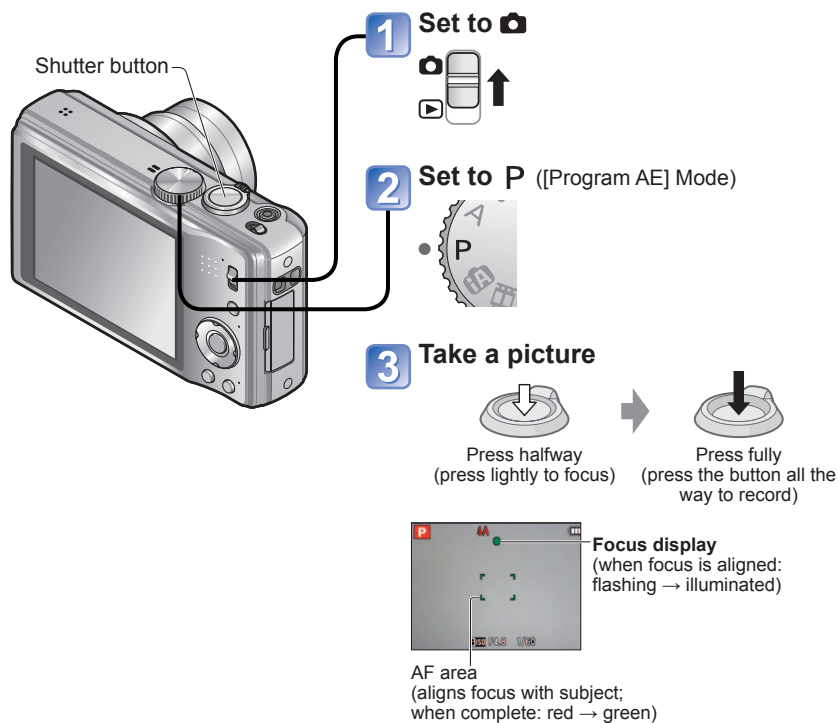

- If a warning is displayed about jitter, use [Stabilizer], a tripod, or [Selftimer].
- If aperture and shutter speed are shown in red, you do not have appropriate exposure. You should either use the flash, change [Sensitivity] settings or set [Min. Shtr Speed] to a slower speed.

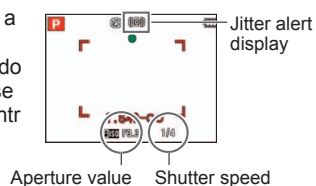

Aligning the focus

Useful when subject is not in the center of picture.

1 First adjust focus according to subject

Align the AF area with the subject

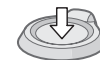

Hold down halfway



AF area

2 Return to desired composition

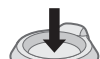

Press fully



AF area

- Subjects/environments which may make focusing difficult:

- Fast-moving or extremely bright objects, or objects with no color contrast.
- Taking pictures through glass or near objects emitting light. In dark, or with significant jitter.
- When too close to object or when taking pictures of both distant and close objects together in the same picture.

- The focus display flashes and beep sounds when focus is not aligned. Use the focus range displayed in red as a reference. Even if the focus display is lit, the camera may be unable to bring the subject into focus if it is out of range.
- AF area is displayed larger in dark conditions or when using Digital Zoom.



Taking pictures with zoom

Recording Mode: **iA P A S M MS1 MS2 SCN**

You can zoom in up to 16 times with “Optical Zoom”, and up to 33.8 times with “Extended Optical Zoom” (pictures only) with lower picture quality. To zoom further, you can use [i.ZOOM] or [Digital Zoom].

Do not block the lens barrel movement while zooming.

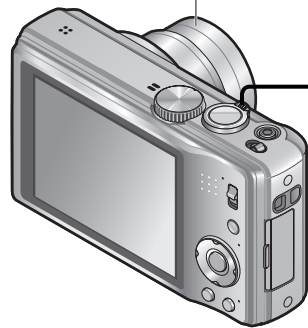



1 Zoom In/Out

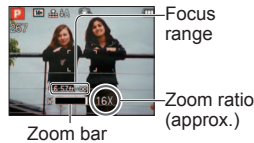

Capture a wider area (wide-angle)  Enlarge the subject (telephoto)



- Zoom speed can be adjusted.
Zoom slowly → turn slightly
Zoom quickly → turn completely

■ Zoom types

Type	Optical Zoom	Extended Optical Zoom
Maximum ratio	16 ×	Up to 33.8 × (Depending on the picture size)
Picture quality deterioration	No	No (However, the picture size is reduced)
Operation conditions	None	Set [Picture Size] in the [Rec] menu to a setting for which EZ is displayed (→70)
Screen display		 EZ is displayed

Type	i.Zoom	Digital Zoom
Maximum ratio	Approx. 1.3 × the Optical Zoom or Extended Optical Zoom	Up to 4 × the original zoom ratio
Picture quality deterioration	Almost none	Yes
Conditions, etc.	i.Zoom functions in the following cases. <ul style="list-style-type: none"> • iA ([Intelligent Auto] Mode) • Scene Mode (except for [High Sens.], [Hi-Speed Burst], [Flash Burst], [Pin Hole]) • When [i.Resolution] in the [Rec] menu is set to [i.ZOOM] (→34) 	When [Digital Zoom] in the [Rec] menu is set to [ON] (→36)
Screen display	 EZOOM is displayed	 Digital Zoom area is displayed

● What is Extended Optical Zoom (EZ)?

If, for example, set to [3M **EZ**] (equivalent to 3 million pixels), a picture will only be taken of a 3M-sized central part of a 14 M (equivalent to 14.1 million pixels) area, meaning that the picture can be enlarged further.

- The zoom ratio and the zoom bar displayed on the screen are estimates.
- In certain Recording Modes, “Tele macro” function (→42) is activated when maximum zoom ratio is reached.
- A greater degree of distortion may be generated by taking wider-angled pictures of close objects, while using more telescopic zoom may result in more coloring appearing around the outlines of objects.
- The camera may make a rattling noise and vibrate when the zoom lever is operated - this is not a fault.
- Extended Optical Zoom cannot be used in the following cases: [Macro Zoom], motion picture, [Transform], [High Sens.], [Hi-Speed Burst], [Flash Burst], [Pin Hole], and [Photo Frame] Scene Modes
- Digital Zoom cannot be used in the following modes:
 - **iA** ([Intelligent Auto] Mode), Scene Modes ([Transform], [High Sens.], [Hi-Speed Burst], [Flash Burst], [Pin Hole], [Film Grain] and [Photo Frame])
- [Zoom Resume] allows zoom ratio to be memorized even if power is turned off.

Taking pictures with zoom (Continued)

Recording Mode: **iA** **P** **A** **S** **M** **MS1** **MS2** **SCN**

[i.ZOOM]

The camera uses super resolution technology to increase the zoom ratio. Using super resolution technology, the zoom ratio can be increased up to about 1.3 times higher than the original zoom ratio with almost no deterioration of picture quality.

1 Display the [Rec] menu



3 Select [i.ZOOM]

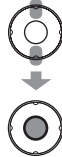

2 Select [i.Resolution]

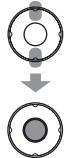

4 Press $\left[\text{OK} / \text{ZOOM} \right]$ several times

- When [i.Resolution] is set to [i.ZOOM], super resolution technology is applied to the picture.
- The i.Zoom functions in the following cases.
 - **iA** ([Intelligent Auto] Mode)
 - Scene Mode (except for [High Sens.], [Hi-Speed Burst], [Flash Burst], [Pin Hole])

Easy Zoom: For zooming rapidly to maximum ratio

Zoom to max. T in one touch.

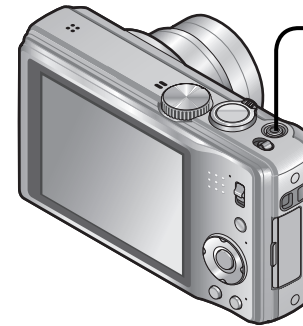

- ### 1 Press to change zoom ratio
- EZOOM** Each time you press, the ratio changes

The illustration shows the DMC-ZS8/DMC-TZ18.

Change of zoom ratio

- When the Picture Size is 10.5 M or more
- When the Picture Size is 10 M **3:2** or less

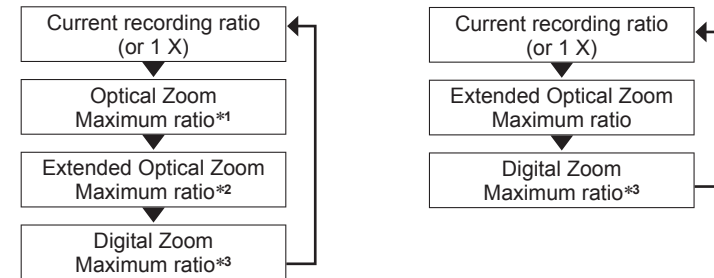

*1 When [i.ZOOM] is working, the maximum ratio depends on the [i.ZOOM] settings.
 *2 The Picture Size temporarily becomes [3M] (**4:3**), [2.5M] (**3:2 / 1:1**) or [2M] (**16:9**).
 *3 When [Digital Zoom] in the [Rec] menu is set to [ON].

- Easy Zoom does not work while recording motion pictures.

Taking pictures with zoom (Continued)

Recording Mode: **[iA] [P] [A] [S] [M] [MS1] [MS2] [SCN]**

[Digital Zoom]

Zoom 4 times further than Optical/Extended Optical Zoom.
(Note that, with Digital Zoom, enlarging will decrease picture quality.)

1 Display the [Rec] menu



3 Select [ON]

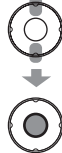

2 Select [Digital Zoom]

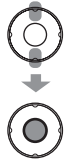

4 Press **[DISP.]** several times

Viewing your pictures [Normal Play]

Playback Mode: **[P]**

When a card is in the camera, pictures are played back from the card, and without a card, pictures are played back from the built-in memory.

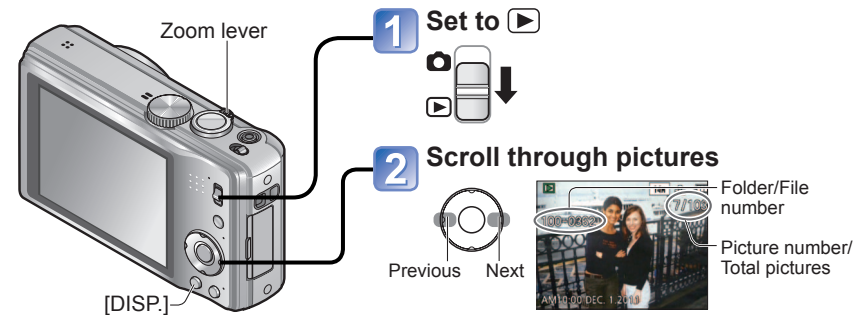

■ To enlarge (Playback Zoom)



Turn to T side



Current zoom position

- Each time you turn the zoom lever toward the T side, the magnification increases through four levels after 1x, 2x, 4x, 8x, and 16x. (The picture quality displayed becomes successively lower.)
- To reduce zoom→ Turn lever towards W side
- Move zoom position→ **▲▼◀▶**

- Hold down to quickly scroll forwards/backwards. Scroll speed increases the longer you press. (Speed may vary according to playback conditions)
- Some pictures edited on a computer may not be viewed on this camera.
- If the REC/PLAY switch is moved from **[P]** to **[P]** while the power is on, the lens barrel will be retracted after approx. 15 seconds.
- This camera is compliant with the unified DCF (Design rule for Camera File system) standard formulated by the Japan Electronics and Information Technology Industries Association (JEITA), and with Exif (Exchangeable image file format). Only files that are DCF-compliant can be played back.

Deleting pictures

Playback Mode:

Pictures will be deleted from the card if the card is inserted, or from the built-in memory if the card is not inserted. (Deleted pictures cannot be recovered.)

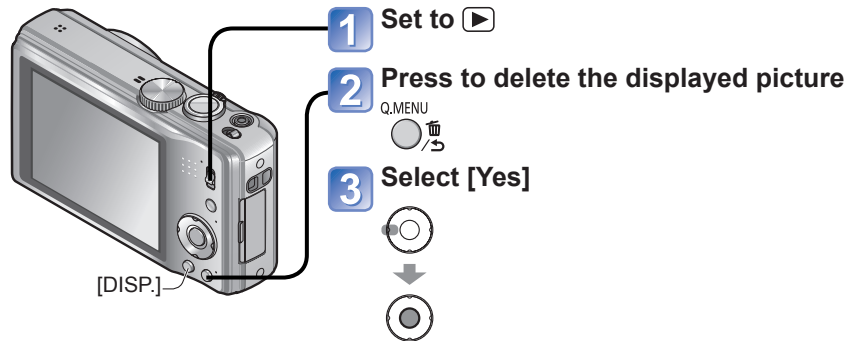

To delete multiple (up to 50) or all pictures

(after step 2)

3 Select type of deletion

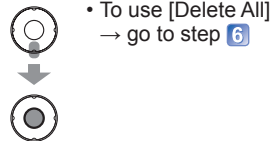

4 Select the pictures to delete

(Repeat)

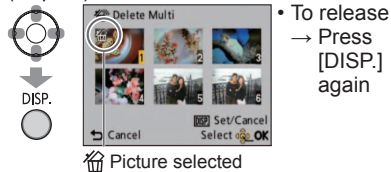

5 Delete



6 Select [Yes]

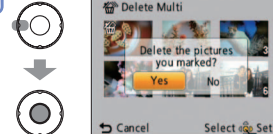

- To cancel → press [MENU/SET].
- May take time depending on number of pictures deleted.
- You can select [All Delete Except ★] in [Delete All] if there are pictures that have been set as [Favorite].

- Do not turn off the power during deletion.
- Use a sufficiently charged battery or an AC adaptor (optional) and DC coupler (optional).
- Pictures cannot be deleted in the following cases:
 - Protected pictures
 - Card switch is in "LOCK" position.
 - Pictures not of DCF standard (→37)

Changing recording information display

Change between different LCD monitor displays, such as Histograms.



■ Histogram

Displays distribution of brightness in picture – e.g. if the graph peaks at the right, this means there are several bright areas in the picture. (Guide) A peak in the center represents correct brightness (correct exposure). This can be used as a reference for exposure correction (→46), etc.

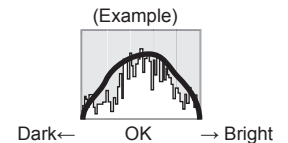

- Histogram from time of recording is different to Histogram in playback and displayed in orange, when recording with flash or in dark locations. Also, Histogram may differ from Histograms made with image editing software.
- Not displayed during ([Intelligent Auto] Mode), [Photo Frame] or Playback Zoom.

■ Guide lines

- Reference for composition (e.g. balance) when recording.
- Only guide line pattern is displayed in [Intelligent Auto] Mode.
- When is in use, recording information and Guide lines cannot be displayed simultaneously.

- For motion picture or Slide Show playback, the operational guidance information is either displayed or not displayed on the LCD.

Taking pictures with flash

Recording Mode: **iA P A S M MS1 MS2 SCN**

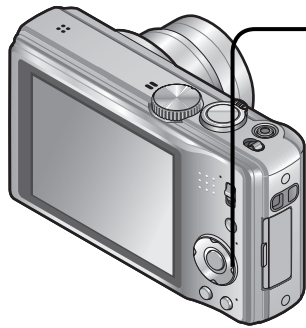

1 Display [Flash]



2 Select the desired type

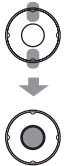

Type, operations	Uses
[Auto] • Automatically judges whether or not to flash	Normal use
[Auto/Red-Eye]*1 • Automatically judges whether or not to flash (reduce red-eye)	Taking pictures of subjects in dark places
[Forced Flash On] • Always flash	Taking pictures with backlight or under bright lighting (e.g. fluorescent)
[Forced On/Red-Eye]*1 • Always flash (reduce red-eye)	
[Slow Sync./Red-Eye]*1 • Automatically judges whether or not to flash (reduce red-eye; slow shutter speed to take brighter pictures)	Taking pictures of subjects against a nightscape (tripod recommended)
[Forced Flash Off] • Never flash	Places where flash use is prohibited

*1 Two flashes will be emitted. Do not move until after the second flash. Interval between flashes varies according to brightness of subject.

If [Red-Eye Removal] on the [Rec] menu is [ON], the appears with the flash icon, red-eye is automatically detected and still picture data is corrected. (Only when [AF Mode] is (Face Detection))

■ Available types in each mode (○: Available, -: Not available, □: Default setting)

	iA	P	A	S	M	MS1	MS2	SCN	Portrait	Macro	Close-up	Self-timer	Scene	Movie	Still
iA	○*2	○	○	○	○	○	○	○	○	○	○	○	○	○	○
iA	-	○	○	○	○	○	○	○	○	○	○	○	○	○	○
⚡	-	○	○	○	○	○	○	○	○	○	○	○	○	○	○
⚡	-	-	-	-	-	-	-	-	-	-	-	○	○	○	○
⚡	-	○	-	-	-	-	-	-	○	-	-	○	○	-	○
⚡	○	○	○	○	○	○	○	○	○	○	○	○	○	○	○

*2 Set to **iA**, **iA**, **⚡** or **⚡** depending on the subject and brightness.

• The flash cannot be used when recording motion pictures, Scene Modes or .

■ The available flash range when [Sensitivity] setting is [AUTO]

W side (Max.)	Approx. 60 cm (1.97 feet) - 5.0 m (16.4 feet)
T side (Max.)	Approx. 1.0 m (3.28 feet) - 2.8 m (9.18 feet)

● Shutter speeds are as follows:

- **iA**, **iA**, **⚡**, **⚡**: 1/60*3 - 1/4000th
- **⚡**, **⚡**: 1*3,*4 - 1/4000th

*3 Varies according to [Min. Shtr Speed] setting.

*4 When [Min. Shtr Speed] is set to [AUTO], and a jitter is detected when [Stabilizer] is turned to [ON], the maximum speed is 1/4 second. Also varies according to [Intelligent Auto] Mode, [Scene Mode], zoom position.

- The effect of Red-Eye Reduction varies depending on the subject and is affected by factors such as distance to the subject, whether the subject is looking at the camera during preliminary flash, and so on. In some cases, the effect of Red-Eye Reduction may be negligible.
- **Do not put your hands over the light-emitting area of the flash (→8) or look at it from close range (a few centimeters away).**
Do not use the flash at close distances to other subjects (heat/light may damage subject).
- Flash settings may be changed when changing Recording Mode.
- Scene Mode flash settings are restored to default when Scene Mode is changed.
- Edges of picture may become slightly dark if using flash at short distances without using zoom (close to max. W). This may be remedied by using a little zoom.
- No pictures may be taken if these marks (e.g. **iA**) are flashing (flash is charging).
- Insufficient light may prevent appropriate exposure or White Balance.
- Flash charging may take time if battery is low, or if using flash repeatedly.

Taking close-up pictures

Recording Mode: **P A S M**

When you want to enlarge the subject, setting to [AF Macro] (AF \downarrow) enables you to take pictures at an even closer distance than the normal focus range (up to 3 cm (0.10 feet) for max. W).

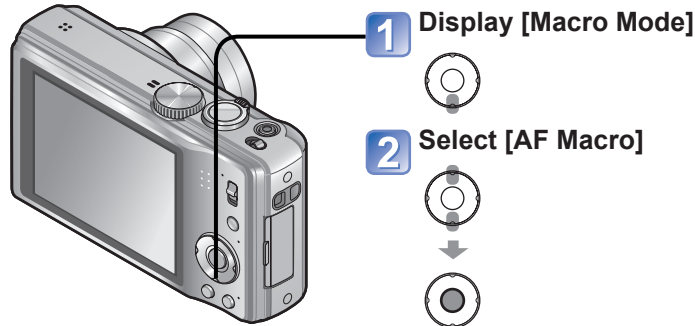

● It may take some time until distant subjects come into focus.



AF \downarrow display

Taking close-up pictures without standing close to subject “Tele macro” function

“Tele macro” operates automatically when Optical or Extended Optical Zoom ratios are close to the maximum T setting (16x or above for Optical Zoom). The focus can be aligned for distances as close as 1 m (3.28 feet). (AF \downarrow changes to TELE \downarrow)

Taking pictures at even closer range [Macro Zoom]

To take even larger images of the subject, setting to [Macro Zoom] enables the subject to appear even larger than when using [AF Macro].

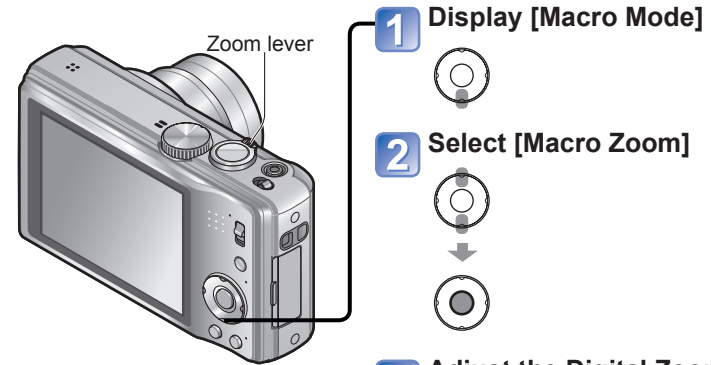

3 Adjust the Digital Zoom magnification with the zoom lever

The zoom position is fixed at the Wide end. Focus range is 3 cm (0.10 feet) - ∞ .

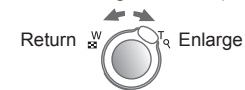

Digital Zoom magnification (1 x to 3 x)

- In [Macro Zoom], higher magnification results in lower picture quality.
- When [Macro Zoom] is set, Extended Optical Zoom or [i.ZOOM] does not work.
- When [AF Tracking] is set, zoom macro is canceled.
- Using a tripod and [Selftimer] is recommended. Also, when recording a subject that is close to the camera, setting [Flash] to [Forced Flash Off] is recommended.
- Moving the camera after aligning the focus is likely to result in poorly focused pictures if subject is close to the camera, due to the margin for focus alignment being severely reduced.
- Resolution may be reduced around the edges of the picture.

Positioning camera and subject within accessible range for focus alignment

Focus range

When a subject is too close to the camera, the picture may not be properly focused. The shortest recording distance differs depending on the zoom ratio and the setting in macro recording mode.

During optical zooming Zoom ratio (guideline)	Shortest recording distance*1	
	[Macro Mode] AF \downarrow *2	[Macro Mode] [OFF]*3
1x	3 cm (0.10 feet)	50 cm (1.64 feet)
2x	10 cm (0.33 feet)	50 cm (1.64 feet)
3x	20 cm (0.66 feet)	50 cm (1.64 feet)
4x	40 cm (1.32 feet)	50 cm (1.64 feet)
5x	1 m (3.28 feet)	1 m (3.28 feet)
6x	1.5 m (4.92 feet)	1.5 m (4.92 feet)
7x - 11x	2 m (6.57 feet)	2 m (6.57 feet)
12x - 15x	1.5 m (4.92 feet)	2 m (6.57 feet)
16x	1 m (3.28 feet)	2 m (6.57 feet)

*1 The shortest recording distance is the distance from the lens front to the subject. This distance changes gradually depending on the zoom position.

*2 The shortest recording distance is identical under the following settings.

- [IA] ([Intelligent Auto] Mode)
- [Motion Picture] Mode
- [Food], [Candle Light], [Baby], [Pet], [High Sens.], [Hi-Speed Burst], [Flash Burst], [Pin Hole], [Film Grain], [High Dynamic], [Underwater] in Scene Mode

*3 The shortest recording distance is identical under the following settings.

- [Portrait], [Soft Skin], [Transform], [Panorama Assist], [Sports], [Party], [Sunset], [Starry Sky], [Beach], [Snow], [Photo Frame] in Scene Mode

- Ranges for focus alignment differ for Scene Modes.

Taking pictures with self-timer

Recording Mode: [IA] [P] [A] [S] [M] [MS] [MS2] [SCN]

We recommend using a tripod. This is also effective for correcting jitter when pressing the shutter button, by setting the self-timer to 2 seconds.

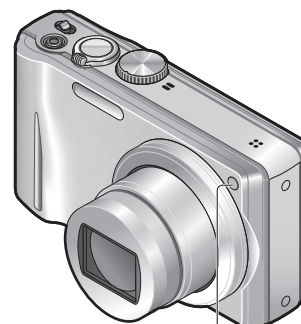
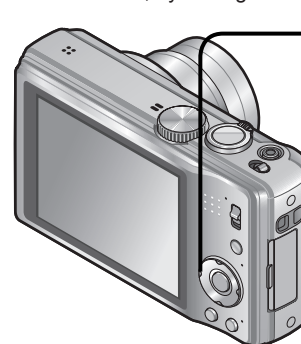

Self-timer indicator
(Flashes for set duration)

1 Display [Selftimer]



2 Select time duration



3 Take a picture

Press the shutter button fully to start recording after the preset time.

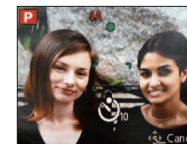

- To cancel while in operation
→ Press [MENU/SET]

- Focus will be automatically adjusted immediately before recording if shutter button is pressed fully here.
- After self-timer indicator stops flashing, it may then be lit for AF Assist Lamp.
- This function cannot be used in the [Underwater] and [Hi-Speed Burst] Scene Modes, or when recording motion pictures.
- [10sec.] cannot be chosen in [Self Portrait] Scene Mode.

Taking pictures with Exposure Compensation

Recording Mode: **P A S** MS1 MS2 SCN IE1

Corrects exposure to obtain optimum exposure (for example, if there is difference between brightness of object and background).

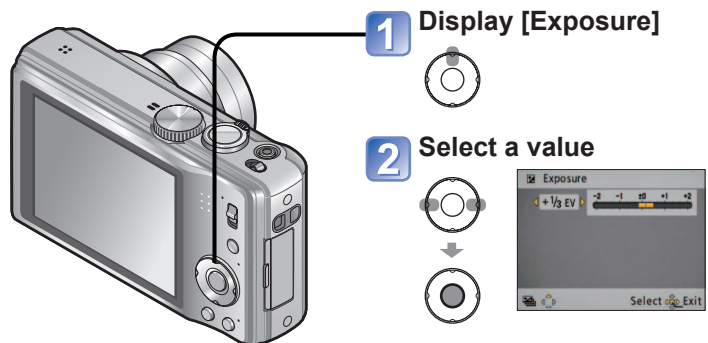

1 Display [Exposure]

2 Select a value

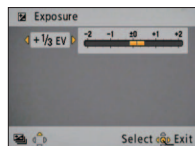

- If the picture is too dark, adjust the exposure to the "+" direction.
- If the picture is too bright, adjust the exposure to the "-" direction.

- Depending on the brightness, this may not be possible in some cases.
- After exposure adjustment, the adjustment value ($\frac{2}{3} + \frac{1}{3}$ for example) is displayed.
- The Exposure Compensation value you set is retained even after the camera is turned off.
- Exposure Compensation cannot be used with the [Starry Sky] Scene Mode.

Recording while exposure is changed automatically ([Auto Bracket])

Recording Mode: **P A S M** MS1 MS2 SCN

Records 3 pictures in continuous succession while exposure is changed automatically. After exposure adjustment, the adjustment value is set as the standard.

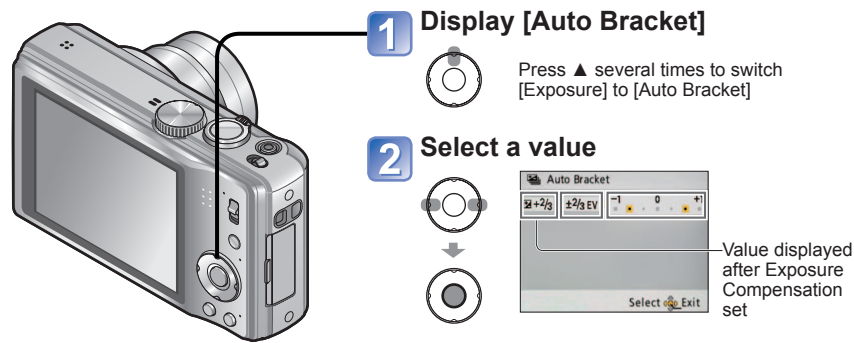

1 Display [Auto Bracket]

2 Select a value

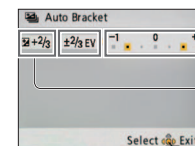

Value displayed after Exposure Compensation set

- The first still picture is recorded without compensation, the second still picture is recorded with exposure adjusted in the "-" direction, and the third still picture is recorded with exposure adjusted in the "+" direction.

- Cannot be used with flash.
- Canceled when the power is turned off.
- When [Auto Bracket] is set, [Burst] is canceled.
- Cannot be set in [Transform], [Panorama Assist], [Hi-Speed Burst], [Flash Burst], [Starry Sky], [Pin Hole], [Film Grain], and [Photo Frame] Scene Modes or when recording motion pictures.

Determine aperture and record

[Aperture-Priority] Mode

Recording Mode: **A**

When recording, you can control the range of focus (depth of field) to meet your recording purposes.

Shutter speed is automatically adjusted to be appropriate for the set aperture value.

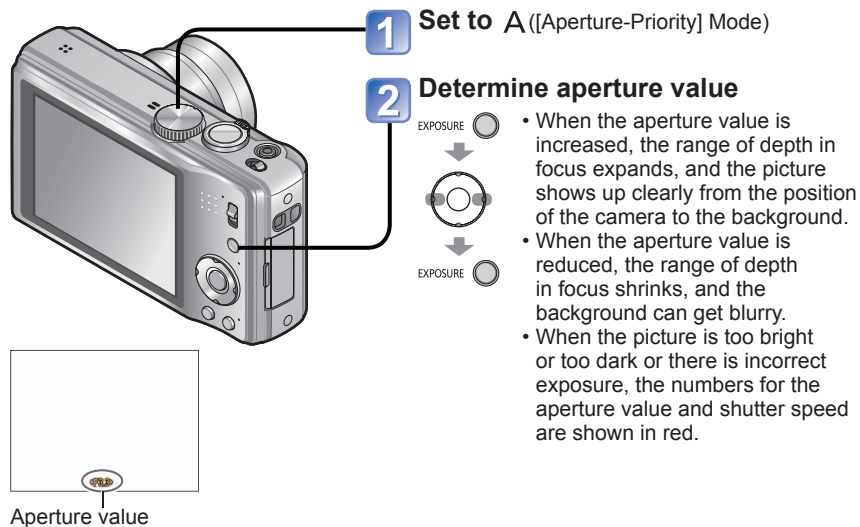

- LCD monitor brightness may vary from the actual still picture recorded.
- If too bright, increase the aperture, and if too dark, reduce the aperture.

Determine shutter speed and record

[Shutter-Priority] Mode

Recording Mode: **S**

When recording, you can control the shutter speed to meet your recording purposes.

Aperture is automatically adjusted to be appropriate for the set shutter speed.

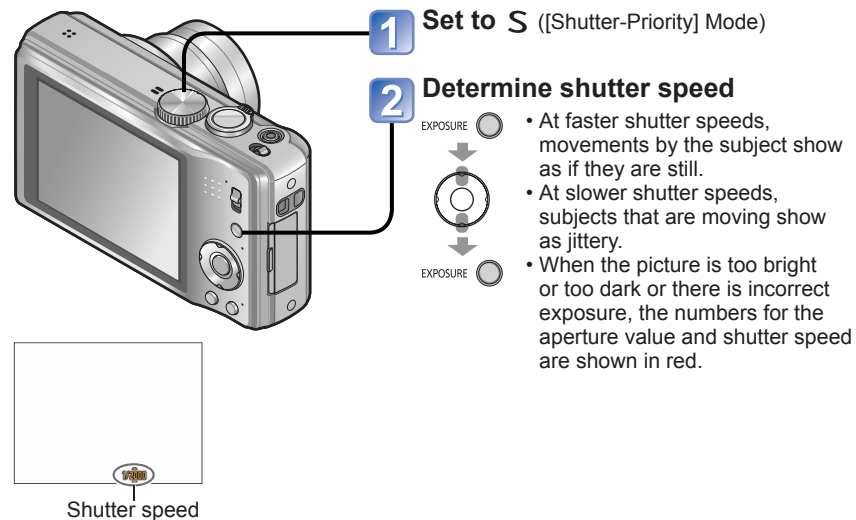

- LCD monitor brightness may vary from the actual still picture recorded.
- When using a slow shutter speed, it is recommended to use a tripod.

Determine aperture and shutter speed and record

[Manual Exposure] Mode

Recording Mode: **M**

This mode of recording lets you set any aperture value and shutter speed when exposure adjustment prevents you from recording at the desired exposure (brightness/darkness). Also, long-exposure recording of up to 60 seconds is possible.

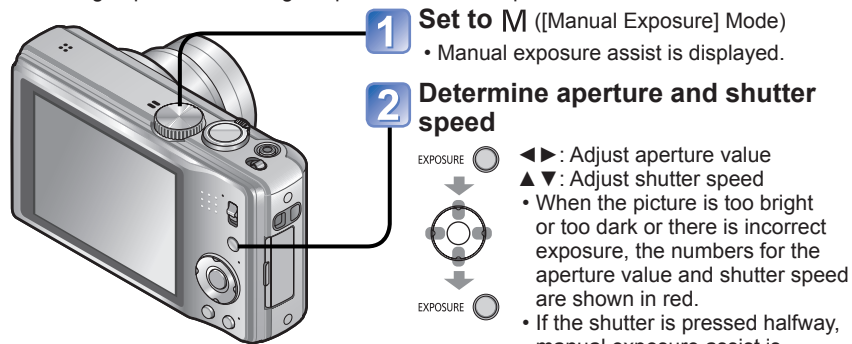

1 Set to **M** ([Manual Exposure] Mode)

- Manual exposure assist is displayed.

2 Determine aperture and shutter speed

- ◀▶: Adjust aperture value
- ▲▼: Adjust shutter speed
- When the picture is too bright or too dark or there is incorrect exposure, the numbers for the aperture value and shutter speed are shown in red.
- If the shutter is pressed halfway, manual exposure assist is displayed.



Aperture value/shutter speed

Manual exposure assist (estimate)

	Shows pictures with standard brightness.
	Shows brighter pictures. For standard brightness, either use a faster shutter speed or increase aperture value.
	Shows darker pictures. For standard brightness, either use a slower shutter speed or reduce aperture value.

- LCD monitor brightness may vary from the actual still picture recorded.

Register your own settings and record

[Custom] Mode

Recording Mode: **CUST**

Registering your preferred Recording Mode, [Rec] menu settings, etc. to [Cust.Set Mem.] and setting the mode dial to CUST allows you to switch quickly to those settings.

[Cust.Set Mem.] Registering your own settings

Up to 3 current camera settings can be registered.

Recording Mode: **P A S M MS1 MS2 SCN**

1 Select the Recording Mode you wish to register and set the [Rec] menu, [Setup] menu, etc.

2 Select [Cust.Set Mem.] from the [Setup] menu (→20)

3 Select the custom set to register



4 Select [Yes]



- Self-timer is not stored in custom set.
- The following [Setup] menus are stored in custom set.
 - [Guide Line] • [Histogram] • [Zoom Resume] • [Auto Review]

Register your own settings and record

[Custom] Mode (Continued)

Recording Mode: 

[Custom] Switch to your own settings and record

Settings registered in [Cust.Set Mem.] can be quickly called up by setting the mode dial to CUST.

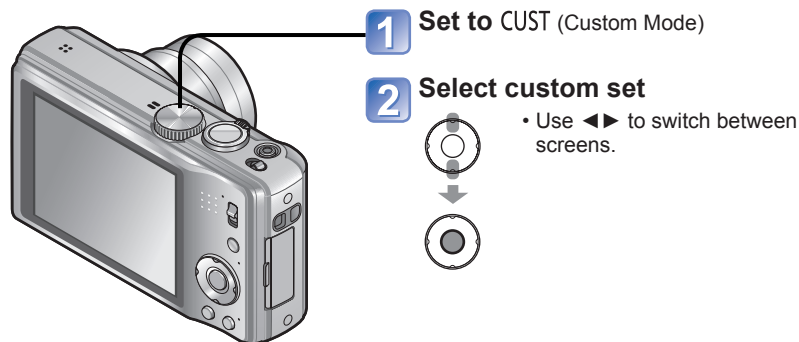

● Even if [Rec] menu, etc. is changed in [Custom], the content of the custom set does not change. When changing registration content, reset in [Cust.Set Mem.].

Taking pictures according to the scene

[Scene Mode]

Recording Mode:   

Using [Scene Mode] enables you to take pictures with optimum settings (exposure, coloring, etc.) for given scenes.

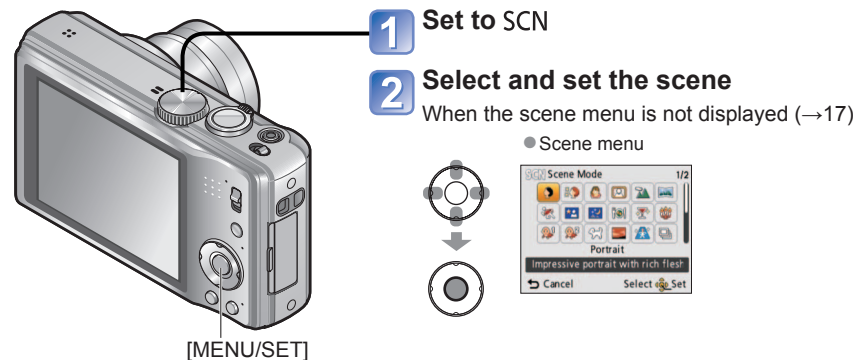

- Selecting a Scene Mode inappropriate for the actual scene may affect the coloring of your picture.
- Following [Rec] menu settings will be automatically adjusted and prevents manual selection:
[Sensitivity], [Metering Mode], [i.Exposure], [Min. Shtr Speed], [i.Resolution], [Color Mode]

Taking pictures according to the scene

[Scene Mode] (Continued)

Recording Mode:

How to select a scene (→53)

Using flash in Scene Modes (→41)

Scene	Uses, Tips	Notes
[Portrait]	<p>Improves the skin tone of subjects for a healthier appearance in bright daylight conditions.</p> <p>Tips</p> <ul style="list-style-type: none"> Stand as close as possible to subject. Zoom: As telescopic as possible (T side) 	-
[Soft Skin]	<p>Smooths skin colors in bright, outdoor daylight conditions (portraits from chest upwards).</p> <p>Tips</p> <ul style="list-style-type: none"> Stand as close as possible to subject. Zoom: As telescopic as possible (T side) 	-
[Transform]	<p>Changes the appearance of the subject by stretching the length or width, and at the same time, improves the skin appearances.</p> <p>Use to select the Transform level, and press [MENU/SET] to set.</p>	<ul style="list-style-type: none"> [Picture Size] will be fixed according to the [Aspect Ratio] setting, as detailed below. : 3 M : 2.5 M : 2 M
[Self Portrait]	<p>Take pictures of yourself.</p>  <p>Tips</p> <ul style="list-style-type: none"> Press shutter button halfway → self-timer indicator illuminates → press shutter button fully → review (if self-timer indicator flashes, focus is not correctly aligned) Use of the 2-second self-timer is recommended when the shutter speed is slow or jitter occurs easily. 	-
[Scenery]	Takes clear pictures of wide, distant subjects.	-

Scene	Uses, Tips	Notes
[Panorama Assist]	<p>Use the supplied software to join multiple pictures into a single panorama picture.</p> <ol style="list-style-type: none"> Use to select the recording direction, and press [MENU/SET] to set. Special panorama guidelines will be displayed. Take the picture. Select [Next], and press [MENU/SET] to set. <ul style="list-style-type: none"> Alternatively, press the shutter button. You can take pictures again by selecting [Retake]. Change the composition and take the picture so that a part of the picture overlaps with the previous picture.  <p>Section of picture that was taken last time</p> <p>Tips</p> <ul style="list-style-type: none"> To take more pictures, select [Next] and repeat steps ③ and ④. <ol style="list-style-type: none"> After you finish taking pictures, select [Exit], and press [MENU/SET] to set. <p>Tips</p> <ul style="list-style-type: none"> Use a tripod. When it is dark, use the self-timer to record pictures. 	<ul style="list-style-type: none"> The focus, zoom, Exposure Compensation, White Balance, shutter speed, and ISO Sensitivity are all fixed at the setting for the first picture. Shutter speed may slow down up to 8 seconds. After recording, the shutter may stay closed (up to 8 seconds) to process the signal. This is not a malfunction. Panorama picture stitching cannot be performed by this camera. Use the software on the supplied CD-ROM "PHOTOfunSTUDIO" to make the pictures you record into a panorama still picture with your computer.
[Sports]	<p>Takes pictures of scenes with fast movement, e.g. sports.</p> <p>Tips</p> <ul style="list-style-type: none"> Stand at least 5 m (16.4 feet) away. 	<ul style="list-style-type: none"> Shutter speed may slow down up to 1 second.
[Night Portrait]	<p>Takes pictures of people and nightscapes with close to actual brightness.</p> <p>Tips</p> <ul style="list-style-type: none"> Use flash. Subject should keep still. Tripod, self-timer recommended. 	<ul style="list-style-type: none"> Shutter speed may slow down up to 8 seconds. After recording, the shutter may stay closed (up to 8 seconds) to process the signal. This is not a malfunction.
[Night Scenery]	<p>Takes clear pictures of night scenes.</p> <p>Tips</p> <ul style="list-style-type: none"> Tripod, self-timer recommended 	<ul style="list-style-type: none"> Shutter speed may slow down up to 8 seconds. After recording, the shutter may stay closed (up to 8 seconds) to process the signal. This is not a malfunction.

Taking pictures according to the scene

[Scene Mode] (Continued)

Recording Mode:

How to select a scene (→53)

Using flash in Scene Modes (→41)

Scene	Uses, Tips	Notes
 [Food]	Takes natural-looking pictures of food.	-
 [Party]	Brighten subjects and background in pictures of indoor events, such as weddings. Tips • Stand approx. 1.5 m (4.92 feet) away. • Zoom: Wide (W side) • Use flash. • Tripod, self-timer recommended.	-
 [Candle Light]	Brings out the atmosphere of a candlelit room. Tips • Do not use flash. • Tripod, self-timer recommended.	• Shutter speed may slow down up to 1 second.
 [Baby]	Uses weak flash to bring out skin colors. • To record age and name ([Baby1] and [Baby2] can be set separately.) ① Select [Age] or [Name] with ▲▼, press [MENU/SET], select [SET], and press [MENU/SET]. ② Set the birthday and name. Age: Set birthday with ▲▼◀▶, and press [MENU/SET]. Name: (See “Entering Text”: (→84)) ③ Select [Exit] with ▲▼, and then press [MENU/SET]. Tips • Make sure [Age] and [Name] are [ON] before taking a picture.	• Age display format depends on [Language] setting. • [Age] and [Name] print setting can be made on your computer using the supplied CD-ROM “PHOTOofunSTUDIO”. Text may also be stamped onto the still picture using [Text Stamp].
 [Pet]	Records pet’s age and name when taking pictures. Tips • Same as for [Baby]	• Refer to [Baby] for other tips and notes.
 [Sunset]	Takes clear pictures of scenes such as sunsets.	-
 [High Sens.]	Prevents blurring of subject in dark, indoor conditions. Select the aspect ratio and the picture size with ▲▼ and press [MENU/SET].	-

Scene	Uses, Tips	Notes								
 [Hi-Speed Burst]	Takes pictures of rapid movement or a decisive moment. ① Use ▲▼ to select [Speed Priority] or [Image Priority], and press [MENU/SET] to set. ② Select the aspect ratio and the picture size with ▲▼ and press [MENU/SET]. ③ Take pictures. (Hold shutter button) Still pictures are taken continuously while the shutter button is pressed fully. <table border="1"> <tr> <td rowspan="2">Maximum speed*</td> <td>[Speed Priority]</td> <td>Approx. 10 pictures/sec.</td> </tr> <tr> <td>[Image Priority]</td> <td>Approx. 5.5 pictures/sec.</td> </tr> <tr> <td>Number of recordable pictures*</td> <td colspan="2">Approx. 15 to 100</td> </tr> </table> * The burst speed and number of recordable pictures change according to the recording conditions or types of cards.	Maximum speed*	[Speed Priority]	Approx. 10 pictures/sec.	[Image Priority]	Approx. 5.5 pictures/sec.	Number of recordable pictures*	Approx. 15 to 100		<ul style="list-style-type: none"> • The number of burst recording pictures increases immediately after formatting. • The focus, zoom, exposure, White Balance, shutter speed and ISO Sensitivity are fixed to the settings for the first picture. • If recording is repeated, depending on the usage conditions, there may be a delay before the camera takes pictures again.
Maximum speed*	[Speed Priority]		Approx. 10 pictures/sec.							
	[Image Priority]	Approx. 5.5 pictures/sec.								
Number of recordable pictures*	Approx. 15 to 100									
 [Flash Burst]	Enables continuous recording in dim locations. ① Use ▲▼ to select the picture size and aspect ratio, and press [MENU/SET] to set. ② Take pictures (Hold shutter button). Still pictures are taken continuously while the shutter button is held down. Number of continuous shots: Max. 5	<ul style="list-style-type: none"> • The focus, zoom, Exposure Compensation, shutter speed, and ISO Sensitivity are all fixed at the setting for the first picture. • When [Selftimer] is set, 5 pictures are taken. 								
 [Starry Sky]	Takes clear pictures of starry skies or dark subjects. • Shutter speed settings ① Select with ▲▼, and press [MENU/SET]. ② Press shutter button. Countdown begins. Tips • Always use a tripod. • Self-timer recommended. • Do not move the camera until the countdown has ended. (Countdown for processing is redisplayed afterwards)	-								







Taking pictures according to the scene



[Scene Mode] (Continued)

Recording Mode: **MS1 MS2 SCN**

How to select a scene (→53)

Using flash in Scene Modes (→41)

Scene	Uses, Tips	Notes
 [Fireworks]	Takes clear pictures of fireworks in the night sky. Tips • Stand at least 10 m (32.8 feet) away. • Tripod recommended.	• Shutter speed is fixed to 1/4 or 2 seconds. (Setting of shutter speed changes if Exposure Compensation is operated)
 [Beach]	Brings out the clear blues of the sky and the sea without darkening subject.	• Do not touch camera with wet hands. • Beware of sand and sea water.
 [Snow]	Brings out the natural color of snow in ski slope and mountain scenes.	-
 [Aerial Photo]	Takes pictures of the view from aircraft windows.	• Turn the camera off when taking off or landing.
 [Pin Hole]	Darkens the area around the screen for a retro effect.	-
 [Film Grain]	Produces black and white pictures with a grainy texture.	-

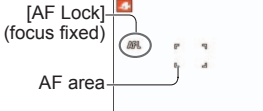
Scene	Uses, Tips	Notes
 [High Dynamic]	Reduces over- and underexposure when recording into the light and in night scenes. Use ▲ ▼ to select the effect and press [MENU/SET]. [STD.] Natural coloring effect [ART] An impressionistic effect emphasizing contrast and color [B&W] Monochrome effect	• Shutter speed may slow down up to 8 seconds. • After recording, the shutter may stay closed (up to 8 seconds) to process the signal. This is not a malfunction.
 [Photo Frame]	A frame is superimposed over the image. Press ◀▶ to select the frame, and then press [MENU/SET].	• The recording pixel level is 2 M (4:3). • Guide lines cannot be displayed.
 [Underwater]	Achieve natural colors under water. Tips • For fast moving subjects, align with the AF area and press ◀ (AF Lock). (Press ◀ again to release.) • If the zoom is operated after AF Lock is set, the AF Lock setting will be canceled and must be set again. • AF Lock cannot be set if [AF Mode] is set to [AF]. • Adjust red and blue levels with "White Balance fine adjustment" (→73).	• Always use marine case (optional).  [AF Lock] (focus fixed) AF area

Saving commonly used scenes

[My Scene Mode]

Recording Mode: MS1 MS2

You can register a commonly used Scene Mode in MS1MS2 on the mode dial. After the settings are made, pictures can be taken in the preset Scene Mode by simply setting the mode dial to MS1MS2.

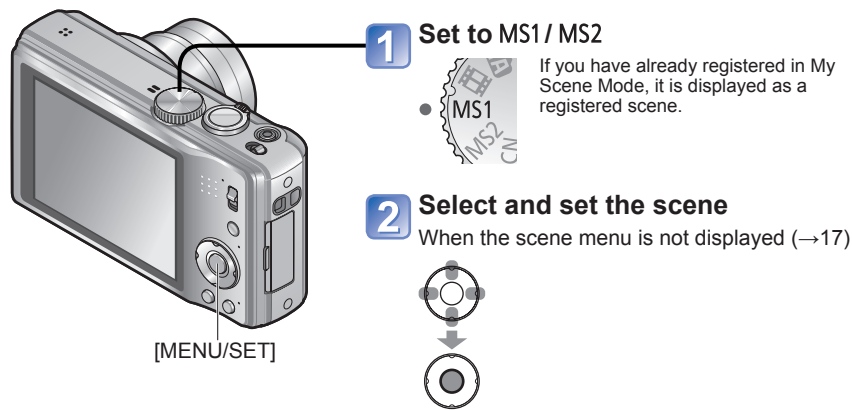

■ Taking pictures in registered Scene Modes

Set the mode dial to MS1 / MS2, and take a picture.

■ Changing registered Scene Modes

Perform the registration operation again

● MS1 and MS2

Both represent the same function. Frequently-used scenes can be preset to each position so that you can quickly and easily switch to the desired Scene Mode.

- If recording settings are reset by [Reset] in the [Setup] menu, the preset Scene Modes are cleared.

Taking motion pictures [Motion Picture] Mode

Recording Mode:

Playing back motion pictures (→86)

This records motion pictures with audio. (Sound recording is monaural*1 or stereo*2.) Zoom can also be used during recording.

*1 DMC-ZS8/DMC-TZ18

*2 DMC-ZS9

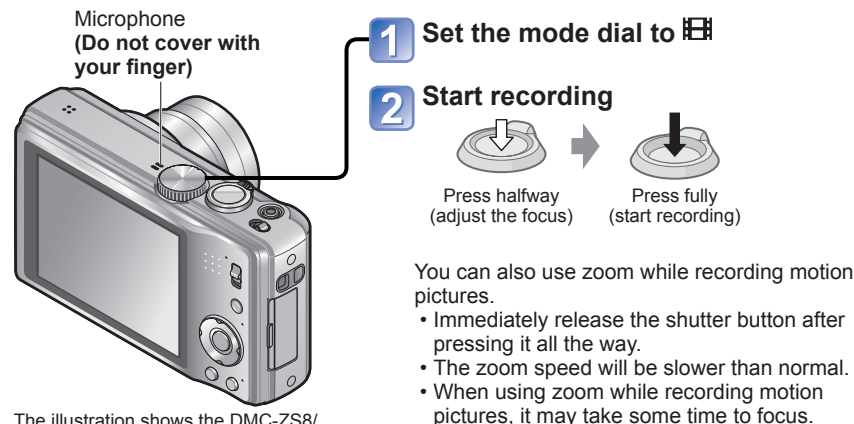

The illustration shows the DMC-ZS8/DMC-TZ18.

Remaining recording time (approx.)



Elapsed recording time

3 End recording



- Depending on the type of card used, a card-access display may appear for a while after motion picture recording. This is not a fault.
- Easy zoom cannot be used while recording a motion picture.
- The following functions are not available.
 - Extended Optical Zoom, flash, [Face Recog.] and [Rotate Disp.] for still pictures taken vertically.
- In [AF Mode], (23-area-focusing) is fixed:
- In [Stabilizer], [ON] is fixed.
- When there is no space left to store the motion picture, recording automatically ends. Additionally, recording in progress may be stopped, depending on the card used.
- Depending on the motion picture recording environment, static electricity or electromagnetic waves may cause the screen to go black momentarily or noise to be recorded.

Taking motion pictures [Motion Picture] Mode (Continued)

Recording Mode:

[Rec Quality]

Changing the motion picture size. When recording a motion picture, use a card rated with an SD speed class*1 of "Class 6" or higher.

*1 SD speed class refers to a specification for sustained write speeds.

1 Display the [Rec] menu



2 Select [Rec Quality]



3 Select the desired picture quality

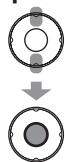

Picture Quality	Picture Size	No. of Frames	Picture Aspect Ratio
[HD]	1280 × 720 pixels	30 fps	16:9
[VGA]	640 × 480 pixels		4:3
[QVGA]*2	320 × 240 pixels		

*2 [QVGA] is fixed when recording to built-in memory.

- When recording motion pictures using an AC adaptor, if you unplug the AC adaptor or a power outage occurs, power to the camera is cut, and the motion picture in progress is no longer recorded.
- If you attempt to play motion pictures recorded with the camera on other devices, playback may not be possible, or the picture or sound quality may be poor. Additionally, incorrect recording information may be indicated.

Recording with the Face Recognition function

[Face Recog.]

Recording Mode:

Default [Face Recog.] setting is [OFF].

When the face pictures are registered, the setting will be [ON] automatically.

■ How the Face Recognition function works

During recording (When [AF Mode] is (Face Detection))

- The camera recognizes a registered face and adjusts focus and exposure
- When registered faces that have set names are recognized, the names are displayed (up to 3 people)

During playback

- The name and age are displayed (if information is registered)
- During recording, the names that have been set for the recognized faces are displayed (up to 3 people)
- Only pictures of the selected registered people are played back ([Category Selection])

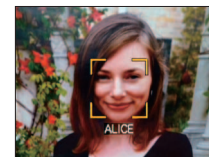

- When Burst is performed, recording information relating to Face Recognition is put only on the first picture.
- If you press the shutter button halfway, then point the camera at a different subject and record, recording information for a different person may be put on the picture.
- Face Recognition does not work in the following cases:
Motion picture recording, Scene Modes [Transform], [Panorama Assist], [Night Scenery], [Food], [Hi-Speed Burst], [Flash Burst], [Starry Sky], [Fireworks], [Aerial Photo], [Film Grain], [Underwater]
- Face Recognition searches for faces similar to those registered, but there is no guarantee it will always recognize these faces.
- Even if Face Recognition information is registered, pictures recorded when the name is [OFF] are not categorized for Face Recognition in [Category Selection].
- **Even if Face Recognition information is changed, Face Recognition information for previously recorded pictures is not changed.**
For example, if a name is changed, pictures recorded before the change are not categorized for Face Recognition in [Category Selection].
- To change name information for pictures already recorded, perform a [REPLACE] (→100) in [Face Rec Edit].

Recording with the Face Recognition function

[Face Recog.] (Continued)

Recording Mode:

For [Rec] menu setting procedures (→17)

Registering face pictures

Up to 6 people's face pictures can be registered along with such information as name and birth date.

You can facilitate Face Recognition by the way you register faces: for example, register multiple face pictures of the same person (up to 3 pictures in one registration).

■ Recording tips when registering face pictures

- Make sure the subject's eyes are open and mouth closed; have the subject face the camera directly, and make sure the outline of the face, the eyes and eyebrows are not hidden by hair.
- Make sure there are no heavy shadows on the face. (During registration, the flash is not used).

■ If the camera seems to have difficulty recognizing faces when recording

- Register additional pictures of the same person's face, indoors and outdoors or with different expressions or angles.
- Register additional pictures at the place you are recording.
- If a registered person is no longer recognized, re-register that person.

- In some cases, the camera cannot recognize or incorrectly recognizes even registered people depending on their expression or the environment.

1 Select [Face Recog.] from the [Rec] menu (→17)

2 Select [MEMORY] with ▲▼, and then press [MENU/SET]

3 Select [New] with ▲▼◀▶, and then press [MENU/SET]

- If 6 people are already registered, first delete a registered person. (→66)

4 Record the face picture

- ① Align the face with the guide and record.
 - ② Select [Yes] with ◀, and then press [MENU/SET].
 - If re-recording, select [No]
- Faces of subjects other than people (e.g. pets) cannot be registered.
 - When [DISP.] is pressed, an explanation is displayed.

5 Select the item to edit and make the setting



Item	About settings
[Name]	<ol style="list-style-type: none">① Select [SET] with ▲▼, and then press [MENU/SET]② Enter the name (text input procedure: →84)
[Age]	<p>Set the birth date.</p> <ol style="list-style-type: none">① Select [SET] with ▲▼, and then press [MENU/SET]② Use ◀▶ to select year, month and day, set with ▲▼, and press [MENU/SET]
[Focus Icon]	<p>Change the icon that is displayed when the subject is in focus.</p> <ol style="list-style-type: none">① Select the focus icon with ▲▼, and then press [MENU/SET]
[Add Images]	<p>Up to 3 face pictures of the person can be registered.</p> <ol style="list-style-type: none">① Select an unregistered frame and press [MENU/SET]<ul style="list-style-type: none">• When a registered face picture is selected with ◀▶, a screen to confirm deletion is displayed. Select [Yes] to delete the face picture. (If only one picture is registered, it cannot be deleted.)② Record the picture (Step 4 (→64))③ Press /

■ To set the Face Recognition function to [OFF]

- ① Select [Face Recog.] from the [Rec] menu (→17)
- ② Select [OFF] with ▲▼, and then press [MENU/SET]

Recording with the Face Recognition function

[Face Recog.] (Continued)

Recording Mode:

For [Rec] menu setting procedures (→17)

Editing or deleting information about registered persons

Information about registered people can be edited or deleted.

- 1 Select [Face Recog.] from the [Rec] menu (→17)
- 2 Select [MEMORY] with ▲▼, and then press [MENU/SET]
- 3 Using ▲▼◀▶, select the person whose information you wish to edit or delete, and press [MENU/SET]

- 4 Select the item

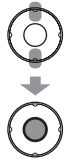

Item	About settings
Information editing	Edit name or other registered information. (→65)
Registration order	Set priority order for focus and exposure. ① Select the registration order with ▲▼◀▶, and then press [MENU/SET]
Deleting	Delete information and face pictures of registered persons.

Useful features for travel

For [Setup] menu setting procedures (→17)

[Travel Date]

If you set your travel schedule and record pictures, which day of your trip the picture was recorded will be recorded.

■ **Recording Mode:**  * Recording only. (Cannot set.)

- 1 Select [Travel Date] from [Setup] menu (→17)
- 2 Select [Travel Setup] with ▲▼, and then press [MENU/SET]
- 3 Select [SET] with ▲▼, and then press [MENU/SET]
- 4 Select the departure date with ▲▼◀▶, and then press [MENU/SET]
- 5 Set the return date in the same way

■ To record [Location]

- ① Select [Location] from the [Travel Date] menu (→17)
- ② Select [SET] and press [MENU/SET]
- ③ Enter your destination
 - Entering text (→84)

- The travel date is calculated from the set departure date and the date set in the camera's clock. When destination is set in [World Time], days elapsed are calculated based on local destination time.
- When [Travel Setup] is set to [OFF], the number of days elapsed is not recorded. It is not displayed even if [Travel Setup] is set to [SET] after recording.
- If settings are made before departure date, number of days to departure are displayed in orange with a minus sign (but not recorded).
- When [Travel Date] is displayed in white with a minus sign, the [Home] date is one day ahead of the [Destination] date due to the difference in time zones (this is recorded).
- To print the number of days that have passed or the location, either use [Text Stamp] or print using the software "PHOTOfunSTUDIO" on the supplied CD-ROM.

[World Time]

Set the recording date and time with the local time at your destination.

■ **Recording Mode:** 

1 Select [World Time] from the [Setup] menu (→17)

- [Please set the home area] will be displayed when setting for the first time. In this case, press [MENU/SET] and skip to step 3.

■ Set home area

2 Select [Home]



3 Set your home area

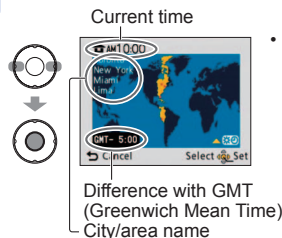

- To cancel
→ Press [Left] / [Right].

■ Set destination area

2 Select [Destination]



3 Set destination area

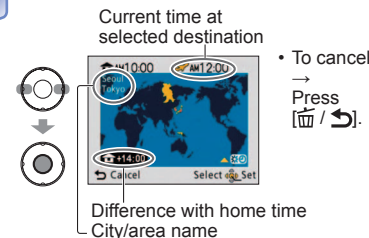

- To cancel
→ Press [Left] / [Right].

If actual destination is unavailable, select based on "difference with home time".

■ Upon your return

Go through steps 2 and 3 on the upper left, and return to the original time.

■ To set/release summer time

Press ▲ in step 3. (Press again to release)

- When summer time is set, the current time is advanced by 1 hour. If the setting is canceled, the time automatically returns to the current time.
- Still pictures and motion pictures recorded after you have specified the destination are labeled  (destination) during playback.

Using the [Rec] menu

For [Rec] menu setting procedures (→17)

[Aspect Ratio]

Aspect ratio of still picture can be changed according to printing or playback format.

■ **Recording Mode:** P A S M

■ **Settings:** 4:3 / 3:2 / 16:9 / 1:1

● Edges may be cut off when printing – be sure to check in advance.

[Picture Size]

Set the size (number of pixels) of still pictures. Number of pictures which can be recorded depends on this setting and on [Quality] (→71).

■ **Recording Mode:** P A S M

■ **Settings:**

Picture Size ([Aspect Ratio]: 4:3)					
14 M	10 M *	7 M *	5 M *	3 M *	0.3 M *
4320×3240	3648×2736	3072×2304	2560×1920	2048×1536	640×480

Picture Size ([Aspect Ratio]: 3:2)					
12.5 M	9 M *	6 M *	4.5 M *	2.5 M *	0.3 M *
4320×2880	3648×2432	3072×2048	2560×1712	2048×1360	640×424

Picture Size ([Aspect Ratio]: 16:9)					
10.5 M	7.5 M *	5.5 M *	3.5 M *	2 M *	0.2 M *
4320×2432	3648×2056	3072×1728	2560×1440	1920×1080	640×360

Picture Size ([Aspect Ratio]: 1:1)					
10.5 M	7.5 M *	5.5 M *	3.5 M *	2.5 M *	0.2 M *
3232×3232	2736×2736	2304×2304	1920×1920	1536×1536	480×480

* This setting is not available in ([Intelligent Auto] Mode).

● Mosaic effect may appear depending on subject and recording conditions.

Setting guide

Larger picture size	←→	Smaller picture size
Crisper picture		Coarser picture
Lower recording capacity		Higher recording capacity

[Quality]

Set quality of picture.

■ **Recording Mode:** P A S M

■ **Settings:** Fine (High quality, priority to picture quality)

Standard (Standard quality, priority to the number of pictures)

● The setting is fixed to (Standard) in the following Scene Modes.
([Transform], [High Sens.], [Hi-Speed Burst] and [Flash Burst])

[Sensitivity]

Set ISO Sensitivity (sensitivity to lighting) manually.

We recommend higher settings to take clear pictures in darker locations.

■ **Recording Mode:** P A S M

■ **Settings:** [AUTO] / ISO [Intelligent ISO] / [100] / [200] / [400] / [800] / [1600]

Setting guide

[Sensitivity]	[100] ←→ [1600]
Location (recommended)	Bright (outdoors) Dark
Shutter speed	Slow Fast
Interference	Low High
Jitter of the subject	Increased Less

● [AUTO] is automatically set in a range up to 400 (1000 when flash is used) based on subject brightness.

● ISO is automatically set in a range up to 1600 based on subject movement and brightness.

[White Balance]

Adjust coloring to suit light source if colors otherwise appear unnatural.

■ **Recording Mode:** **P A S M** **MS1 MS2 SCN** **EB**

■ **Settings:** **[AWB]** (automatic)/
 (outdoor, clear sky)/
 (outdoor, cloudy sky)/
 (outdoor, shade)/
 (Incandescent lighting)/
 (uses value set in SET)/
 SET (set manually)

● **[AWB] operational range:**

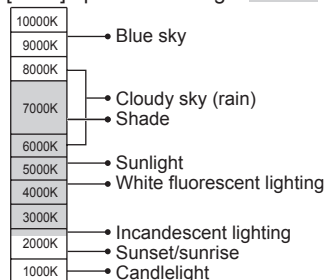

- When [AWB] (automatic White Balance) is set, the coloring is adjusted in accordance with the light source. However, if the scene is too bright or too dark or if other extreme conditions apply, the pictures may appear reddish or bluish. The White Balance may not operate correctly if there is a multiple number of light sources.
- We recommend setting to [AWB] or SET when under fluorescent lighting.
- White Balance setting is fixed to [AWB] in the following Scene Modes: [Scenery], [Night Portrait], [Night Scenery], [Food], [Party], [Candle Light], [Sunset], [Flash Burst], [Starry Sky], [Fireworks], [Beach], [Snow], [Aerial Photo], [Film Grain] and [Underwater]

■ White Balance fine adjustment (excluding [AWB])

White Balance settings can be individually fine tuned if colors still do not appear as anticipated.

- ① Select the white balance to be fine-tuned, and press the [DISP.] button to display the [WB Adjust.] screen.
- ② Adjust with if reds are strong, adjust with if blues are strong.
- ③ Press [MENU/SET].
 - Settings are remembered even if power is turned off.
 - Settings remain applied when using flash.
 - Fine adjustments cannot be made when [Color Mode] (→79) is set to [B/W], [SEPIA], [COOL], or [WARM].
 - In [Underwater] Scene Mode, you can fine-tune [AWB].
 - If fine adjustments are not made, select the center point.
 - Fine adjustments can be made separately for each white balance item.
 - White balance settings are canceled if the white balance is set manually.

■ Setting White Balance manually (SET)

- ① Select SET and press [MENU/SET].
- ② Point the camera towards a white object (e.g. paper) and press [MENU/SET].
 - Even if the camera's power is OFF, the set White Balance is remembered.
 - It may not be possible to set the correct White Balance if subjects are too bright or too dark. In this case, adjust the brightness and try to set the White Balance again.

[AF Mode]

Method of aligning focus can be changed according to position and number of subjects.

■ **Recording Mode:** P A S M MS1 MS2 SCN

■ **Settings:** / / / /

<p>Taking front-on pictures of people</p> <p> (Face Detection)</p>	<p>Detected faces (up to 15 people) and adjusts exposure and focus accordingly.</p> <ul style="list-style-type: none"> AF area <ul style="list-style-type: none"> Yellow : When the shutter button is pressed halfway, the frame turns green when the camera is focused. White : Displayed when more than one face is detected. Other faces that are the same distance away as faces within the yellow AF area are also focused.
<p>Automatically locking the focus on a moving subject</p> <p> (AF Tracking)</p>	<p>Align the AF Tracking frame with the subject, and then press .</p> <ul style="list-style-type: none"> AF Tracking frame <ul style="list-style-type: none"> When the subject is recognized, the AF Tracking frame changes from white to yellow, and the subject is automatically kept in focus. If AF Lock fails, a red frame flashes. To clear AF Lock, press . Focus (same as macro recording) <ul style="list-style-type: none"> Max. W: 3 cm (0.10 feet) and above Max. T: 1 m (3.28 feet) and above (7 × to 11 × is 2 m (6.57 feet) to ∞)
<p>Subject not centered in picture (AF area displayed only when focused)</p> <p> (23-area-focusing)</p>	<p>Focuses on up to 23 points in each AF area.</p>
<p>Determined position for focus</p> <p> (1-area-focusing)</p> <p> (Spot-focusing)</p>	<p>1-area-focusing: Focuses on AF area in center of picture. (Recommended when focus is difficult to align)</p> <p>Spot-focusing: Focuses on smaller, limited area.</p>

- In [Starry Sky] and [Fireworks] Scene Modes, the AF Mode setting is fixed to (1-area-focusing).
- Use (1-area-focusing) if focus is difficult to align with (Spot-focusing).
- Cannot set to (Face Detection) in the following cases: [Panorama Assist], [Night Scenery], [Food], [Aerial Photo], [Underwater] Scene Modes
- If the camera misinterprets a non-human subject as a face in the (Face Detection) setting, switch to another setting.
- If conditions prevent the face from being recognized, such as when the movement of the subject is too rapid, the AF mode setting switches to (23-area-focusing).
- Under certain recording conditions, such as when the subject is small or when it is dark, AF Tracking may not operate correctly.
- When AF Tracking does not work, focus will be on (1-area-focusing).
- Cannot set to in the following cases.
 - [Panorama Assist], [Starry Sky], [Fireworks], [Pin Hole], [Film Grain], or [High Dynamic] Scene Modes.

[Quick AF]

Focus is continually aligned according to movement of subject when camera blurring is small even when shutter button is not pressed. (Increases battery consumption)

■ **Recording Mode:** **P A S M**   

■ **Settings:** [ON]/[OFF]

- Focus alignment may take time if zoom is suddenly changed from max. W to max. T, or if suddenly moving closer to subject.
- Press shutter button halfway if focus is difficult to align.
- The function will turn [OFF] in the following cases.
 - In Scene Modes [Night Portrait], [Night Scenery], [Starry Sky] or [Fireworks]
 - [Quick AF] will not work while AF Tracking is operating.

[Face Recog.]



For details (→63).

[Metering Mode]

You can change the position for measuring brightness when correcting exposure.

■ **Recording Mode:** **P A S M**

■ **Settings:**

	Brightness measurement position	Conditions
 Multiple	Whole screen	Normal usage (produces balanced pictures)
 Center weighted	Center and surrounding area	Subject in center
 Spot	Center and close surrounding area	Great difference between brightness of subject and background (e.g. person in spotlight on stage, backlighting)

[i.Exposure]

Automatically adjusts contrast and exposure to give more lifelike colors when there is significant contrast between background and subject.

■ **Recording Mode:** **P A S M** 

■ **Settings:** [LOW]/[STANDARD]/[HIGH]/[OFF]



- [LOW], [STANDARD] and [HIGH] indicate the maximum range of correction.
- When [i.Exposure] works, the color of **iA** changes.
- Even if [Sensitivity] is set to [100], when [i.Exposure] is activated, pictures may be taken at a higher ISO sensitivity than the setting.

[Min. Shtr Speed]

Sets shutter speed to minimum. We recommend using slower shutter speeds to take brighter pictures in dark locations.

■ **Recording Mode:** **P**

■ **Settings:** [AUTO] [1/250] [1/125] [1/60] [1/30] [1/15] [1/8] [1/4] [1/2] [1]

- Slower shutter speeds allow for brighter pictures but increase risk of jitter, so we recommend using a tripod and the self-timer.
- As still pictures may become dark when using faster values such as [1/250], we recommend that still pictures are taken in bright locations ( flashes red when shutter button is half-pressed if still picture will be dark).
-  displayed on screen for settings other than [AUTO].

[i.Resolution]

Super resolution technology can be used to record still pictures with sharper outlines and clearer resolution. Also, when [i.ZOOM] is set, the zoom ratio can be increased to about 1.3 with almost no deterioration of picture quality.

■ **Recording Mode:** **P A S M**

■ **Settings:** [ON]/[i.ZOOM]/[OFF]

- About i.ZOOM (→34)
- The setting is fixed to [i.ZOOM] in **iA** ([Intelligent Auto] Mode).
- The setting is fixed to [ON] in [High Sens.] and [Hi-Speed Burst] Scene Modes, [OFF] in [Flash Burst] and [Pin Hole] Scene Modes, and [i.ZOOM] in other Scene Modes.

Using the [Rec] menu (Continued)

For [Rec] menu setting procedures (→17)

[Digital Zoom]

Multiplies effect of Optical Zoom or Extended Optical Zoom by up to 4 times. For details (→36)

■ **Recording Mode:** **P** **A** **S** **M** **MS1** **MS2** **SCN**

■ **Settings:** [ON]/[OFF]



- This is fixed to [ON] when [Macro Zoom] is set.

[Burst]

Enables a rapid succession of still pictures to be taken. Succession of still pictures taken while shutter button is held down.

■ **Recording Mode:** **iA** **P** **A** **S** **M** **MS1** **MS2** **SCN**

■ **Settings:**

[Burst] setting	Speed	No. of pictures*
 (Burst)	Apporox. 1.9 pictures/sec.	 Fine: Max. 3  Standard: Max. 5
[OFF]	No burst	

* When using self-timer: Fixed at 3 pictures

- Focus, exposure and White Balance are fixed in the first picture. Depending on changes in the brightness of the subject, the second and subsequent pictures may be recorded brighter or darker.
- Burst speed may be reduced if [Sensitivity] is set to high, or if shutter speed is reduced in darker locations.
- [Auto Bracket] setting is canceled.
- Settings will be stored even if power is turned off.
- Burst is not available in the Scene Modes [Panorama Assist], [Flash Burst], [Hi-Speed Burst], [Starry Sky], [Fireworks], [Pin Hole], and [Photo Frame].

[Color Mode]

Set color effects.

■ **Recording Mode:** **iA** **P** **A** **S** **M** **iA**

■ **Settings:** [STANDARD]/[NATURAL] (soft)/[VIVID] (sharp) /[B/W]/[SEPIA]/[COOL] (more blue)/[WARM] (more red)/[Happy] (**iA** only)

- If interference is noticeable in dark locations: Set to [NATURAL].
- In **iA** ([Intelligent Auto]), only [STANDARD], [Happy], [B/W] or [SEPIA] can be set.

Using the [Rec] menu (Continued)

For [Rec] menu setting procedures (→17)

[AF Assist Lamp]

Illuminates lamp when dark to facilitate focus alignment.

■ **Recording Mode:** P A S M MS1 MS2 SCN

■ **Settings:** [ON] : Lamp illuminated with halfway press of shutter button (AF* and larger AF area displayed)
[OFF] : Lamp off (taking pictures of animals in dark, etc.)



AF Assist Lamp



- The AF Assist Lamp has an effective distance of 1.5 m (4.92 feet).
 - Do not block the lamp with your fingers or look at it from close range.
- The setting is fixed to [OFF] in the following Scene Modes. [Self Portrait], [Scenery], [Night Scenery], [Sunset], [Fireworks], [Aerial Photo], [Underwater]

[Red-Eye Removal]

Automatically detects red-eye and corrects still picture data when recording with flash Red-Eye Reduction (A^o f^o S^o).

■ **Recording Mode:** P A S M MS1 MS2 SCN

■ **Settings:** [ON]/[OFF]

- This setting will work only when [AF Mode] is  (Face Detection).
- The red-eye effect may not be corrected under certain conditions.
- When the function setting is [ON], a  appears with the flash icon.

[Stabilizer]

Automatically detects and prevents jitter.

■ **Recording Mode:** P A S M MS1 MS2 SCN

■ **Settings:** [ON]/[OFF]

- Setting fixed to [ON] in [Self Portrait] and [OFF] in [Starry Sky] Scene Modes.
- Cases where Optical Image Stabilizer may be ineffective:
 - Heavy jitter, high zoom ratio (also in the Digital Zoom range), fast-moving objects, indoors or in dark locations (due to low shutter speed)
- This is fixed at [ON] during motion picture recording.

[Date Stamp]

Still pictures can be taken with the recording date and time stamped on the still picture.

■ **Recording Mode:** P A S M MS1 MS2 SCN

■ **Settings:** [W/O TIME]/[WITH TIME]/[OFF]

- Date stamps on still pictures cannot be erased.
- The date is not stamped when [Burst] is set or when [Panorama Assist], [Hi-Speed Burst] or [Flash Burst] Scene Modes is set.
- Do not request date printing in store or make date printing on printer for still pictures with date stamps. (Date printing may be overlapping.)

[Clock Set]

Set the clock. Same function as that in [Setup] menu.

Using the [Rec] menu for motion pictures

Recording Mode: 

For [Rec] menu setting procedures (→17)

[Rec Quality]

For details (→62)

[Continuous AF]

Either allows the focus to be constantly adjusted during motion picture recording, or fixes the focus position at the start of recording.

- **Settings:** **[ON]** : Adjust focus according to movement of subject during motion picture recording.
- [OFF]** : Fix focus position at the start of motion picture recording.
Use this setting to keep the same focus position for subjects with little forward/backward movement.

[Wind Cut]

Reduces recording of wind sounds (wind noise) when recording in a strong wind.

■ **Settings:** **[ON]/[OFF]**

- When [Wind Cut] is set to [ON], lower sounds will be eliminated and the sound quality will differ from that of normal recordings.

Using Quick menu

Recording menu items can be called up easily.

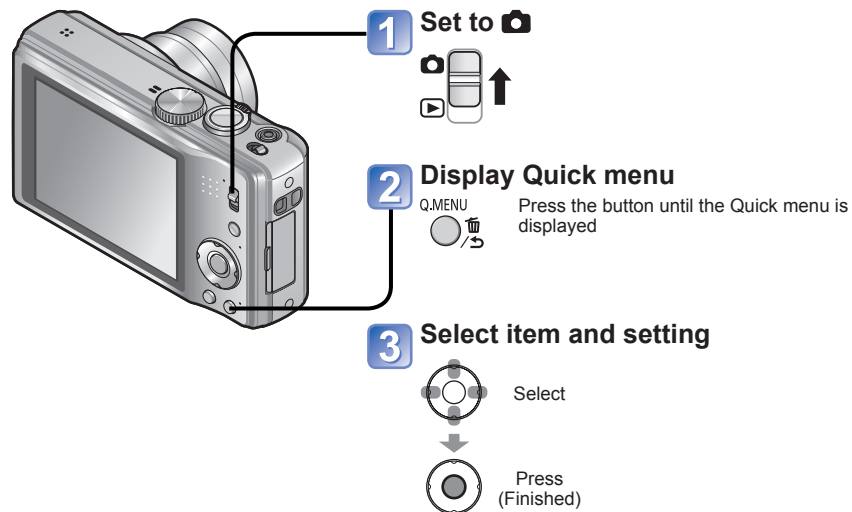

● Setting items displayed vary depending on Recording Mode.

Entering Text

Use the cursor buttons to enter names with the Face Recognition function and in Scene Modes [Baby] and [Pet], or to register destinations in [Travel Date] etc.

1 Press ▲▼◀▶ to select characters

2 Press [MENU/SET] several times until the desired character is displayed



Cursor position

■ Editing text

- ① Press ▲▼◀▶ to move the cursor to text to edit.
 - You can also use the zoom lever to reposition the cursor.
- ② Press ▲▼◀▶ to select [Delete], and then press [MENU/SET].
- ③ Press ▲▼◀▶ to select the correct text, and then press [MENU/SET].

3 When you are finished entering text, press ▲▼◀▶ to select [Set] and press [MENU/SET]



- A maximum of 30 characters can be entered. (Maximum of 9 characters for [Face Recog.] names)
- The entry position cursor can be moved left and right with the zoom lever.

Viewing as list (Multi Playback/Calendar Playback)

Playback Mode:

You can view 12 (or 30) pictures at once (Multi Playback), or view all pictures taken on a certain date (Calendar Playback).

1 Set to

2 Set to multiple screen display

Date recorded Picture no. Total no. Scroll bar

Scrolls with each turn to W side

(12 screens)

(30 screens)

Selected date (First picture from the date)

(Calendar screen)

■ To restore

Turn to T side

■ To change from 12/30-screen display to single-screen display

Select picture with ▲▼◀▶ and press [MENU/SET]

- Only months when pictures were taken are shown on the calendar screen. Pictures taken without clock settings are displayed with the date January 1st, 2011.
- Pictures displayed with [!] cannot be played back.
- Pictures taken with destination settings of [World Time] are displayed in the calendar screen with appropriate date of the destination's time zone.



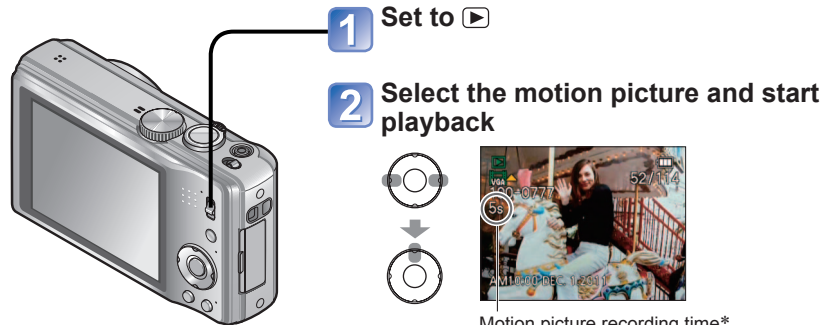

Watching motion pictures

Playback Mode: 

Motion pictures can be played back just as you view still pictures.



■ Operations during motion picture playback

- :Pause/play
- :Stop
- :Fast rewind (2 steps)
Single-frame rewind (while paused)
- :Fast forward (2 steps)
Single-frame forward (while paused)

- If  is pressed during fast forward or rewind, it will return to normal playback speed.
- Volume can be adjusted with zoom lever.

Motion picture recording time*

- * When playback starts, the elapsed playback time is displayed in the top right of the screen.
- Example: After 3 minutes and 30 seconds:
[3m30s]

Different playback methods [Playback Mode]

Playback Mode: 

Recorded pictures can be played back in a variety of ways.

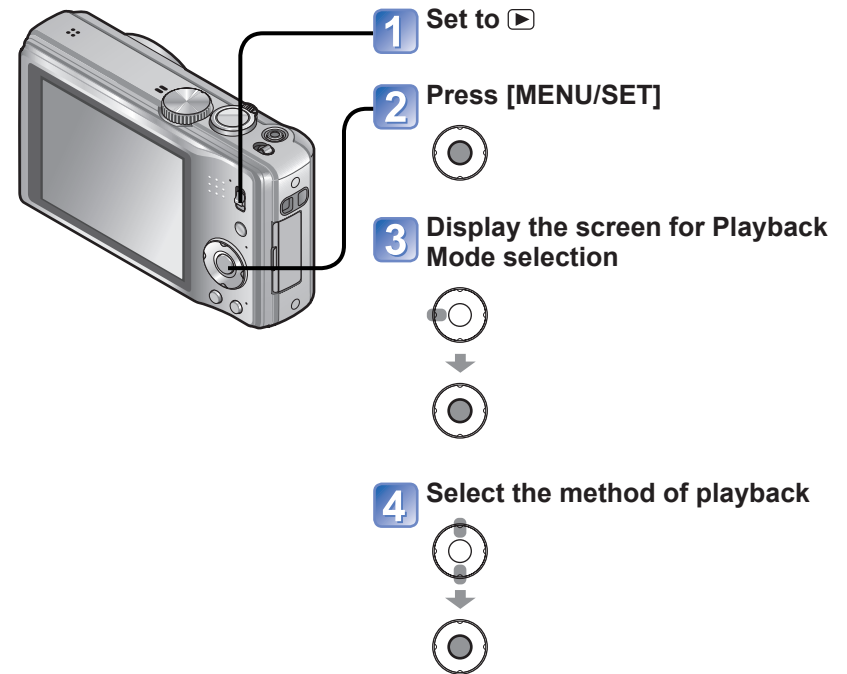

- When no card is inserted, pictures are played back from the built-in memory.
- The [Playback Mode] automatically becomes [Normal Play] when the REC/PLAY switch is set to  and the power is turned on, or when switching from Recording Mode to Playback Mode.

Different playback methods [Playback Mode]

(Continued)

Playback Mode:

For switching [Playback Mode] procedure (→87)

[Slide Show]

Automatically plays back still pictures in order and to music. Recommended when viewing on TV screen.

1 Select the playback method



- [All]
- [Picture Only]
- [Video Only]
- [Travel]: Play back only pictures that were recorded with the [Travel Date] or [Location]
- [Category Selection]: Select category and playback still pictures only. (Select category with ▲▼◀▶ and press [MENU/SET].) (→90)
- [Favorite]: Play back pictures set as [Favorite]



2 Set playback effects

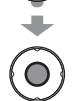

[Effect] (Select music and effects according to picture atmosphere)

[AUTO] (only available with [Category Selection] setting) / [NATURAL] / [SLOW] / [SWING] / [URBAN] / [OFF]*

[Setup]

[Duration]*	[1 SEC.] / [2 SEC.] / [3 SEC.] / [5 SEC.] (Only available when [Effect] is [OFF])
[Repeat]	[ON]/[OFF]
[Sound]	[AUTO]: With still pictures, music will play back, and with motion pictures, audio will play back. [Music]: Music effect will play back. [Audio]: Audio is played back from motion pictures. [OFF]: Music and audio will not play back.

* If [Video Only] was selected in step 1, [Effect] is fixed at [OFF]. Also, the duration cannot be set.

3 Select [Start] with ▲ and press [MENU/SET]

■ Operations during Slide Show

During motion picture playback
Pause/play

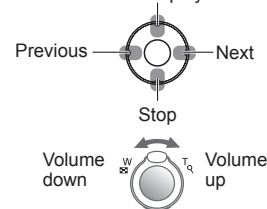

During still picture playback
Pause/play

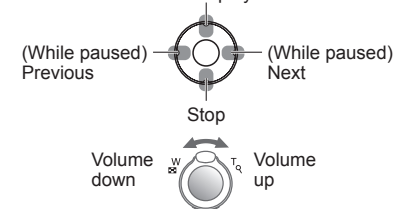

- When [URBAN] has been selected, the picture may appear in black and white as a screen effect.
- Music effects cannot be added.

Different playback methods [Playback Mode]

(Continued)

Playback Mode:

For switching [Playback Mode] procedure (→87)

[Filtering Play]

You can refine the selection of pictures to be viewed by narrowing them down to pictures in selected categories or to favourite pictures, and then view those pictures.

1 Select the refining method using ▲▼, and press [MENU/SET]

[Picture Only]	Play back still pictures.																		
[Video Only]	Play back motion pictures.																		
[Travel]	Play back pictures with [Travel Date] that have been set at the time of their recording. ① Select whether to play back the pictures by date or by travel destination using ▲▼, and press [MENU/SET]. • When [All] is selected, the pictures recorded with [Travel Date] are played back. ② Select the date or travel destination using ▲▼◀▶, and press [MENU/SET].																		
[Category Selection]	Play back pictures that have been narrowed down by category, such as Scene Mode. <table border="1" style="width: 100%; border-collapse: collapse;"> <tr> <td></td> <td>Pictures taken using Face Recognition</td> </tr> <tr> <td></td> <td>[Portrait]/ /[Soft Skin]/[Transform]/[Self Portrait]/[Night Portrait]/ /[Baby]/ </td> </tr> <tr> <td></td> <td>[Scenery]/ /[Sunset]/ /[Aerial Photo]</td> </tr> <tr> <td></td> <td>[Night Portrait]/ /[Night Scenery]/ /[Starry Sky]</td> </tr> <tr> <td></td> <td>[Sports]/[Party]/[Candle Light]/[Fireworks]/[Beach]/ [Snow]/[Aerial Photo]</td> </tr> <tr> <td></td> <td>[Baby]/ </td> </tr> <tr> <td></td> <td>[Pet]</td> </tr> <tr> <td></td> <td>[Food]</td> </tr> <tr> <td></td> <td>[Underwater]</td> </tr> </table>		Pictures taken using Face Recognition		[Portrait]/ /[Soft Skin]/[Transform]/[Self Portrait]/[Night Portrait]/ /[Baby]/		[Scenery]/ /[Sunset]/ /[Aerial Photo]		[Night Portrait]/ /[Night Scenery]/ /[Starry Sky]		[Sports]/[Party]/[Candle Light]/[Fireworks]/[Beach]/ [Snow]/[Aerial Photo]		[Baby]/		[Pet]		[Food]		[Underwater]
	Pictures taken using Face Recognition																		
	[Portrait]/ /[Soft Skin]/[Transform]/[Self Portrait]/[Night Portrait]/ /[Baby]/																		
	[Scenery]/ /[Sunset]/ /[Aerial Photo]																		
	[Night Portrait]/ /[Night Scenery]/ /[Starry Sky]																		
	[Sports]/[Party]/[Candle Light]/[Fireworks]/[Beach]/ [Snow]/[Aerial Photo]																		
	[Baby]/																		
	[Pet]																		
	[Food]																		
	[Underwater]																		
[Favorite]	Play back pictures set as [Favorite].																		

[Calendar]

Select the date from the calendar screen to view only the pictures taken on that day. (→85)

Using the [Playback] menu

Playback Mode:

For the [Playback] menu setting procedure (→17).

You can set the recorded picture to upload to the image-sharing websites, edit the picture (for example, trimming), and set a protection setting in the picture.

- Depending on the Playback Mode, some [Playback] menu items are not displayed.
- New pictures are created after editing pictures with tools such as [Text Stamp] and [Resize]. Before starting to edit, make sure that there is enough free space in the built-in memory or memory card.

[Upload Set]

You can select pictures on the camera for uploading to image-sharing websites (Facebook or YouTube).

- Only still pictures can be uploaded to Facebook and only motion pictures can be uploaded to YouTube.
- Pictures on the built-in memory cannot be set. Copy pictures to a card (→101) before making [Upload Set] settings.

1 Press ▲▼ to select [SINGLE] or [MULTI], and then press [MENU/SET]

2 Select picture and make setting

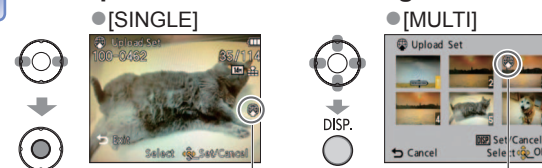

- To cancel → Press [DISP.] again.
- To execute → Press [MENU/SET].

Web upload setting
• Press ◀ to select [Yes], and then press [MENU/SET]

Using the [Playback] menu (Continued)

Playback Mode:

■ Uploading to image-sharing websites

When setting [Upload Set], the built-in uploading tool automatically makes copies on the card inside the camera. Connect the camera to your computer (→103) before performing uploading operations. For more details, refer to (→105).

■ To clear all

Select [CANCEL] in step 1 and select [Yes].

- May not be compatible with pictures taken on other devices.
- Not available on cards with less than 512 MB.

[Title Edit]

You can give titles, etc. to your favorite still pictures.

1 Press **▲▼** to select [SINGLE] or [MULTI], and then press [MENU/SET]

2 Select still picture

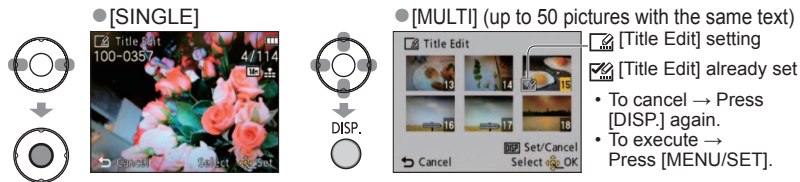

3 Enter characters (Entering text (→84))

To delete a title, delete all the characters in the character input screen.

- Cannot be used with still pictures taken by other devices or motion pictures.
- To print text, use [Text Stamp] or the supplied CD-ROM "PHOTOfunSTUDIO".

For the [Playback] menu setting procedure (→17)

[Text Stamp]

The recording date and time, location name information and the text registered in the [Baby], [Pet] Scene Modes, [Travel Date] and [Title Edit] are stamped on the still picture.

1 Press **▲▼** to select [SINGLE] or [MULTI], and then press [MENU/SET]

2 Select still picture



● [MULTI] (up to 50 pictures)

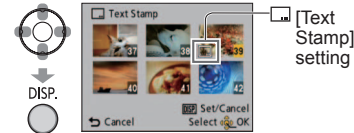

- To cancel → Press [DISP.] button again.
- To execute → Press [MENU/SET].

3 Select [Set]



4 Select the item



5 Select the setting



6 Select [OK]



7 Select whether to stamp age

- If [Name] is [OFF] in Step 5, this screen will not be displayed.



8 Select [Yes]

(Screen varies according to picture size, etc.)

- When you have selected [SINGLE], after step 8, press [left] / [right] to return to the menu screen.



Using the [Playback] menu (Continued)

Playback Mode:

Items that can be stamped

[Shooting Date]	[W/O TIME]: Stamp the recording date [WITH TIME]: Stamp the recording date and time
[Name]	Stamp name registered in Face Recognition / Stamp name registered in [Baby] or [Pet]
[Location]	[ON]: Stamp Destination registered in [Setup]'s [Travel Date]
[Travel Date]	[ON]: Stamp Travel Date set in [Setup]'s [Travel Date]
[Title]	[ON]: Stamp text registered in [Title Edit]

• [OFF] items are not stamped.

- Cannot be used with still pictures taken on other devices, still pictures taken without setting the clock, or motion pictures.
- Characters may be cut off on certain printers.
- Text is difficult to read when stamped on pictures of 0.3 M or less.
- **Do not request date printing in store or make date printing on printer for still pictures with date stamps. (Date printing may be overlapping.)**

For the [Playback] menu setting procedure (→17)

[Resize]

Picture size can be reduced to facilitate e-mail attachment and use in web pages, etc. (Still pictures recorded at the smallest recording pixel level cannot be further reduced.)

■ [SINGLE]

1 Select [SINGLE]



2 Select still picture



3 Select size



4 Select [Yes]

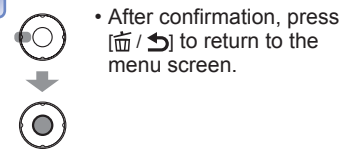

- After confirmation, press [DISP.] to return to the menu screen.

■ [MULTI]

1 Select [MULTI] in step 1 above

2 Select size

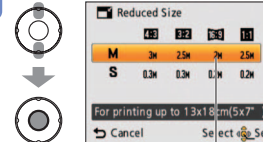

Select number of pixels after resizing

3 Select still picture (up to 50 pictures)

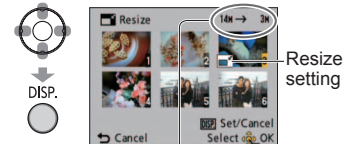

Number of pixels before/after resizing

- To cancel → Press [DISP.] button again.
- To execute → Press [MENU/SET].

4 Press ◀ to select [Yes], and then press [MENU/SET]

- Picture quality is reduced after resizing.
- Cannot be used with motion pictures, or still pictures with text stamp and date stamp. May not be compatible with still pictures taken on other devices.

Using the [Playback] menu (Continued)

Playback Mode:

For the [Playback] menu setting procedure (→17)

[Cropping]

Enlarge your still pictures and crop unwanted areas.

1 Press **◀▶** to select a still picture, and then press [MENU/SET]

2 Select area to crop

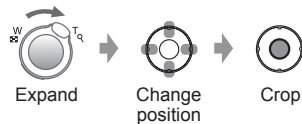

3 Press **◀** to select [Yes], and then press [MENU/SET]

- Picture quality is reduced after cropping.
- Cannot be used with motion pictures, or still pictures with text stamp and date stamp. May not be compatible with still pictures taken on other devices.
- Original Face Recognition information will not be copied when still pictures are cropped.

[Favorite]

By labeling your favorite pictures with a star (★), you can enjoy [Slide Show] or [Filtering Play] of these pictures only, or you can delete all pictures except your favorites.

1 Select [SINGLE] or [MULTI]



2 Select picture and make setting

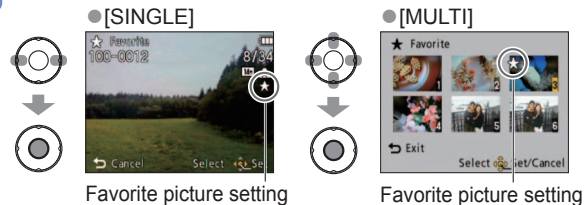

• To cancel → Press [MENU/SET] again.

■ To clear all

Select [CANCEL] in step **1** and select [Yes].

■ To cancel while releasing all

Press [MENU/SET].

- It may not be possible to set pictures taken with certain other devices as favorites.

Using the [Playback] menu (Continued)

Playback Mode:

For the [Playback] menu setting procedure (→17)

[Print Set]

Picture/picture no./date printing settings can be made for when printing with DPOF print-compatible shops or printers. (Ask at shop to check compatibility)

For more information visit:

http://panasonic.jp/dc/dpof_110/white_e.htm

1 Select [SINGLE] or [MULTI]

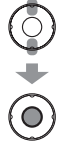

2 Select picture



3 Set number of pictures

(repeat steps 2 and 3 when using [MULTI] (up to 999 pictures))

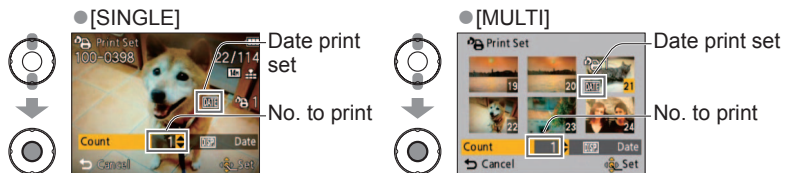

• Date print setting/release → Press [DISP.] button.

■ To clear all

Select [CANCEL] in step 1 and select [Yes].

- Depending on the type of printer, the printer settings may take priority over camera settings.
- Cannot be set for files that are not compliant with the DCF standard.
- DPOF information set by other equipment may not be used. In such cases, delete all of the DPOF information and then set it again with this camera.
- Date printing settings cannot be made for pictures with a [Text Stamp] applied.
- Date print setting cannot be made for still pictures that have been taken with [Date Stamp].

[Protect]

Set protection to disable picture deletion. Prevents deletion of important pictures.

1 Select [SINGLE] or [MULTI]



2 Select picture and make setting



• To cancel → Press [MENU/SET] again.

■ To clear all

Select [CANCEL] in step 1 and select [Yes].

■ To cancel while releasing all

Press [MENU/SET].

- May not be effective when using other devices.

Using the [Playback] menu (Continued)

Playback Mode:

For the [Playback] menu setting procedure (→17)

[Face Rec Edit]

Edit or delete the recognition information for pictures with mistaken Face Recognition.

1 Select [REPLACE] or [DELETE]



2 Select the picture



3 Select a person



- If [DELETE], go to step **5**
- People whose Face Recognition information has not been registered cannot be selected.

4 Select the person to replace for another



5 Select [Yes]



- After setting, press / to return to the menu screen.

[Copy]

You can copy pictures between built-in memory and memory card.

1 Select the copy method (direction)



- : Copy all pictures from built-in memory to card (go to step **3**).
- : Copy 1 picture at a time from card to built-in memory.

2 Select picture with ◀ ▶ and press [MENU/SET] (for)

3 Select [Yes]



- To cancel → Press [MENU/SET].
- After all the pictures are copied from the built-in memory to the memory card, the display returns automatically to the playback screen.

- Copying pictures may take several minutes. Do not turn off power or perform other operations during copying.
- If identical names (folder/file numbers) are present in the copy destination, a new folder for copying will be created when copying from built-in memory to card (). Identically-named files will not be copied from card to built-in memory ().
- The following settings are not copied. Set them again after copying.
 - [Print Set] - [Protect] - [Favorite]
- Only pictures from Panasonic digital cameras (LUMIX) may be copied.

- When Face Recognition information is deleted, it cannot be restored.
- Pictures for which all Face Recognition information has been deleted are not categorized in Face Recognition during [Category Selection].
- Recognition information cannot be edited in protected pictures.

Using with your PC

Still/motion pictures can be copied from the camera to your computer by connecting the two together.

- Some computers can read directly from the camera's memory card. For details, see the manual for your computer.
- If your computer does not support SDXC Memory Cards, a message will be displayed requesting you to format the card. (Do not format the card. This will erase recorded pictures.) If the card is not recognized, refer to the following support website. <http://panasonic.net/avc/sdcard/information/SDXC.html>
- Copied pictures can then be printed out or sent by e-mail using the "PHOTOfunSTUDIO" software on the CD-ROM (supplied).

■ Computer specifications

	Windows			Macintosh
	98/98SE	Me/2000	XP/Vista/7	OS 9/OS X
Can I use "PHOTOfunSTUDIO"?	No		Yes*	No
Can I copy still pictures and Motion JPEG motion pictures from my camera to my computer via USB connection cable?	No	Yes		Yes OS 9.2.2 OS X (10.1 - 10.6)

- USB connection cables cannot be used with Windows 98/98SE, Mac OS 8.x, or older versions of either, but still/motion pictures may still be copied with compatible SD memory card reader/writers.

*Internet Explorer 6.0 or above must be installed.

Correct playback and operation depends on your computer's environment and cannot always be guaranteed.

Copying still pictures and motion pictures

Getting Ready:

- Charge the battery sufficiently. Or, connect the AC adaptor (optional) and DC coupler (optional).
- Insert the card and turn on power. When importing pictures from the built-in memory, remove any memory cards.

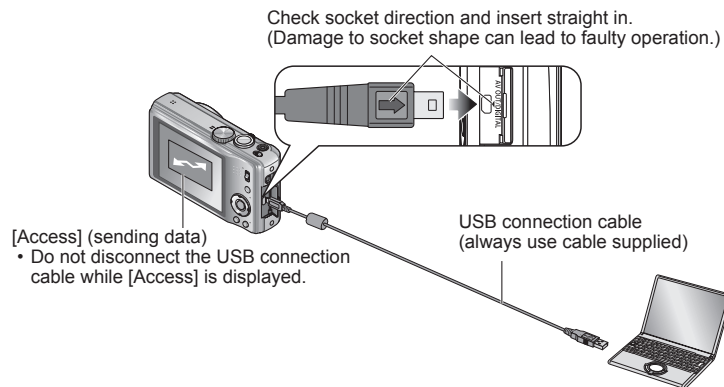

1 Turn on power of both camera and computer

2 Connect camera to computer

- Please make sure you use the supplied USB connection cable. Use of cables other than the supplied USB connection cable may cause malfunction.

3 Select [PC] on the camera



A message may be displayed on screen if [USB Mode] (→22) is set to [PictBridge(PTP)]. Select [Cancel] to close the screen, and set [USB Mode] to [PC].

4 Operate with your computer

■ To cancel connection

Click "Safely Remove Hardware" in the Windows System Tray

Using with your PC (Continued)

You can save pictures to use on your computer by dragging and dropping folders and files into separate folders on your computer.

■ Folder and file names on computer

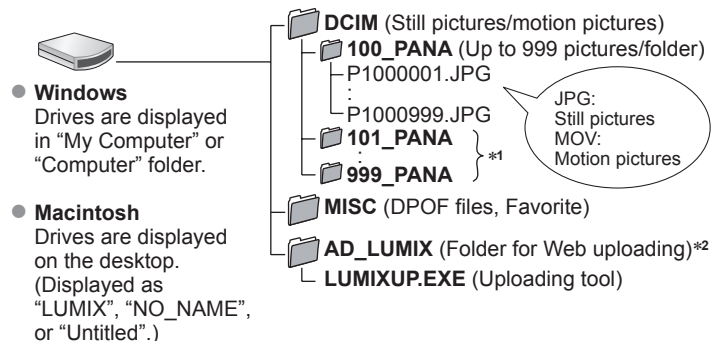

*1 New folders are created in the following cases:

- When pictures are taken to folders containing files numbered 999.
- When using cards already containing the same folder number (for example, pictures taken with other cameras, etc.)
- When recording after performing [No.Reset].

*2 Note that if files in the AD_LUMIX folder or its subfolders are deleted, pictures cannot be uploaded to image-sharing websites.

■ When using Windows XP, Windows Vista, Windows 7, or Mac OS X

The camera can be connected to your computer even if [USB Mode] (→22) is set to [PictBridge(PTP)].

- Only picture output can be performed.
- It may not be possible to import if there are 1000 or more pictures on the card.

- Do not use any other USB connection cables except the supplied one.
- Turn off power before inserting or removing memory cards.
- When the battery begins to run out during communication, a warning beep sounds. Cancel communication via your computer immediately (recharge the battery before reconnecting).
- Setting the [USB Mode] to [PC] removes the need to make the setting each time the camera is connected to the computer.
- For more details, consult your computer operating manual.

Using “PHOTOfunSTUDIO” to copy pictures to your computer

After importing pictures to your computer, you can print or e-mail them.

- Read the separate operating instructions for more information about the operating environment and the installation.

Uploading pictures to image-sharing websites

Using the uploading tool (LUMIX Image Uploader), you can upload still pictures and motion pictures to image-sharing websites (Facebook or YouTube). There is no need to copy pictures to your computer or install specialized software. Uploading pictures from the camera is easy with a computer connected to a network, even when you are away from your regular computing environment.

- This tool supports only computers that run on Windows XP, Windows Vista, and Windows 7.
(To view the manual for LUMIX Image Uploader, use Internet Explorer.)

Getting ready:

- Use [Upload Set] to select the pictures for uploading
- Connect your computer to the Internet
- Create an account for the applicable image-sharing website and prepare your login information

1 Double-click “LUMIXUP.EXE” to start it.

- If you have installed “PHOTOfunSTUDIO” from the CD-ROM (supplied), Uploading tool (LUMIX Image Uploader) may start automatically.

2 Select the upload destination

- Do the further steps in accordance with the instructions displayed on the computer screen.

- Because YouTube and Facebook services and specifications are subject to change, operation of online services cannot be guaranteed in the future. Available services and screens are subject to change without notice.
(This service is available as of December 1, 2010)
- Do not upload pictures protected by copyright except when you are the copyright holder or permission has been obtained from the corresponding copyright holder.

Printing

Some printers can print directly from the camera's memory card.
For details, see the manual for your printer.

You can connect directly to a PictBridge-compatible printer for printing.

Getting Ready:

- Charge the battery sufficiently. Or, connect the AC adaptor (optional) and DC coupler (optional).
- Insert the card and turn on power. When copying pictures from the built-in memory, remove any memory cards.
- Adjust the print quality or other settings on your printer, as needed.

- Do not disconnect the USB connection cable when the cable disconnection icon  is displayed (displayed with some printers).

Check socket direction and insert straight in. (Damage to socket shape can lead to faulty operation.)

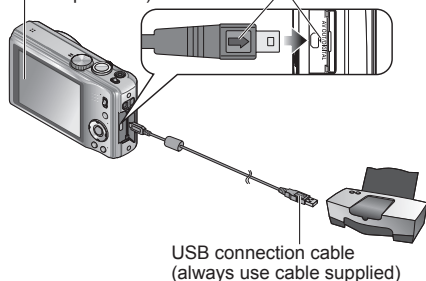

■ **To cancel print** Press [MENU/SET].

- Do not use any other USB connection cables except the supplied one.
- Disconnect USB connection cable after printing.
- Turn off power before inserting or removing memory cards.
- When the battery begins to run out during communication, a warning beep sounds. Cancel printing and disconnect USB connection cable (recharge the battery before reconnecting).

1 Turn on power of camera and printer

2 Connect camera to printer

- Make sure you use the supplied USB connection cable. Use of cables other than the supplied USB connection cable may cause malfunction.

3 Select [PictBridge(PTP)] on the camera



When [Connecting to PC...] is displayed, cancel the connection and set [USB Mode] (→22) to either [Select on connection] or [PictBridge(PTP)].

4 Press ◀▶ to select a picture to print and press [MENU/SET]

5 Select [Print start]

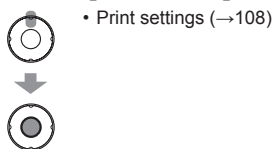

- Print settings (→108)

Printing multiple pictures

① Select [Multi Print] in step 4 on the previous page



② Select item (See below for details)



③ Print (Previous page 5)

- **[Multi Select]** :① Scroll between pictures with ▲▼◀▶, select pictures to print with the [DISP.] button. (Press [DISP.] button again to release selection.)
② Press [MENU/SET] when selection is complete.
 - **[Select All]** :Print all pictures.
 - **[Print Set (DPOF)]** :Print pictures selected in [Print Set].
 - **[Favorite]** :Print pictures selected as [Favorite]. (The setting is displayed only when there are pictures that have been set as [Favorite].)
- Select [Yes] if print confirmation screen is displayed.
 - An orange ● displayed during printing indicates an error message.
 - Print may be divided into several times if printing a large amount of pictures. (Remaining sheets display may differ from set number.)

Print with date and text

■ Printing date without [Text Stamp]

- Printing in store: Only recording date can be printed. Request date printing in store.
- Making [Print Set] settings on the camera in advance allows settings for numbers of copies and date printing to be designated before giving the card to the store.
- When printing still pictures of 16:9 Aspect Ratio, check in advance that the store can accept this size.
- Using computer: Print settings for recording date and text information can be made using the supplied CD-ROM "PHOTOfunSTUDIO".
- Using printer :Recording date can be printed by setting [Print Set] on the camera, or by setting [Print with Date] (→110) to [ON] when connecting to a printer compatible with date printing.

Printing (Continued)

Making print settings on the camera

(Make settings before selecting [Print start])

① Select item

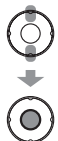

② Select setting

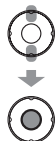

Item	Settings												
[Print with Date]	[ON]/[OFF]												
[Num. of prints]	Set number of pictures (up to 999 pictures)												
[Paper Size]	<table border="0"> <tr> <td></td> <td>[A3] (297×420 mm)</td> </tr> <tr> <td>[L/3.5"×5"] (89×127 mm)</td> <td>[10×15 cm] (100×150 mm)</td> </tr> <tr> <td>[2L/5"×7"] (127×178 mm)</td> <td>[4"×6"] (101.6×152.4 mm)</td> </tr> <tr> <td>[POSTCARD] (100×148 mm)</td> <td>[8"×10"] (203.2×254 mm)</td> </tr> <tr> <td>[16:9] (101.6×180.6 mm)</td> <td>[LETTER] (216×279.4 mm)</td> </tr> <tr> <td>[A4] (210×297 mm)</td> <td>[CARD SIZE] (54×85.6 mm)</td> </tr> </table>		[A3] (297×420 mm)	[L/3.5"×5"] (89×127 mm)	[10×15 cm] (100×150 mm)	[2L/5"×7"] (127×178 mm)	[4"×6"] (101.6×152.4 mm)	[POSTCARD] (100×148 mm)	[8"×10"] (203.2×254 mm)	[16:9] (101.6×180.6 mm)	[LETTER] (216×279.4 mm)	[A4] (210×297 mm)	[CARD SIZE] (54×85.6 mm)
	[A3] (297×420 mm)												
[L/3.5"×5"] (89×127 mm)	[10×15 cm] (100×150 mm)												
[2L/5"×7"] (127×178 mm)	[4"×6"] (101.6×152.4 mm)												
[POSTCARD] (100×148 mm)	[8"×10"] (203.2×254 mm)												
[16:9] (101.6×180.6 mm)	[LETTER] (216×279.4 mm)												
[A4] (210×297 mm)	[CARD SIZE] (54×85.6 mm)												
[Page Layout]	(1 picture, no border) / (1 picture, with border) / (2 pictures) / (4 pictures)												

- Items only compatible with the printer may be displayed.
- To arrange "2 pictures" or "4 pictures" in the same still picture, set the number of prints for the still picture to 2 or 4.
- To print to paper sizes/layouts not supported by this camera, set to and make settings on the printer. (Consult your printer's operating manual.)
- [Print with Date] and [Num. of prints] are not shown when you have selected [Print Set] settings.
- Even with completed [Print Set] settings, dates may not be printed, depending on the shop or printer used.
- When setting [Print with Date] to [ON], check the date printing settings on the printer (printer settings may be prioritized).

Viewing on TV screen

Getting Ready:

- Set [TV Aspect]. (→23)
- Turn off both camera and TV.

You can view pictures on a TV screen by connecting your camera to your TV with the AV cable (supplied).

- Also consult TV operating manual.

- 1 Connect camera to TV**
- 2 Turn on TV**
 - Set to auxiliary input.
- 3 Turn on camera**
- 4 Set REC/PLAY switch to**

Check socket direction and insert straight in.
(Damage to socket shape can lead to faulty operation.)

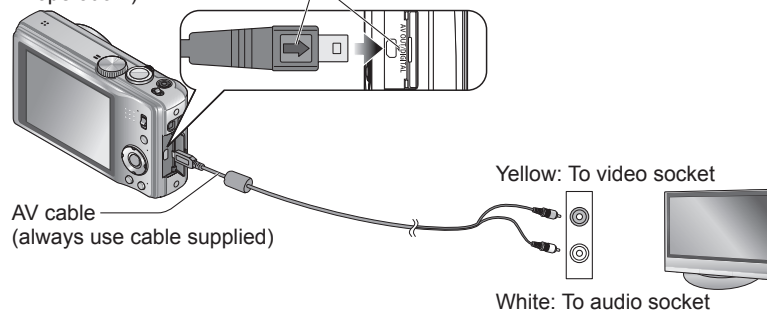

■ When TVs or DVD recorders have an SD card slot

Insert the SD Memory Card into the SD card slot

- Still pictures only can be played back.
- To play motion pictures on other televisions, please connect the camera to the television with the AV cable (supplied).
- When using both SDHC and SDXC Memory Cards, be sure to play each type of card in equipment compatible with the particular format.

- Do not use any other AV cables except the supplied one.
- You can play back pictures on TVs in other countries (regions) which use the NTSC or PAL system when you set [Output] in [Setup] menu. (→23) (DMC-ZS8PU/DMC-TZ18PR only.)
- Pictures rotated to portrait may be blurred slightly.
- Change settings for picture mode on TV if aspect ratios are incorrect on widescreen or high-definition televisions.

List of LCD monitor displays

Press the [DISP.] button to change display (→39).

In recording

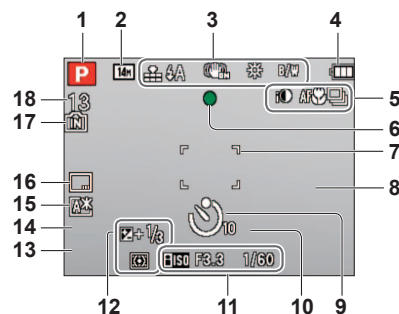

- 1 Recording Mode (→26)
- 2 Picture Size (→70)
Recording quality (→62)
- 3 Quality (→71)
Flash (→40)
Optical Image Stabilizer (→80)/
Jitter alert (→30)
White Balance (→72)
Color Mode (→79)
- 4 Battery capacity (→15)
- 5 Burst Mode (→78)
Auto Bracket (→47)
Macro recording (→42)
i.Exposure (→77)
Wind Cut (→82)
- 6 Focus (→31)
- 7 AF area (→31)
- 8 Histogram (→39)
- 9 Self-timer Mode (→45)
- 10 Focus range (→44)
Zoom (→32)/Macro Zoom (→43)
- 11 ISO Sensitivity (→71)
Aperture value/Shutter speed (→30, 48, 49, 50)
Minimum shutter speed (→77)
- 12 Exposure Compensation (→46)
AF Tracking (→29, 74)
AF Assist Lamp (→80)
Metering Mode (→76)
- 13 Current date/time (→16)
- 14 Age in years/months (→56, 65)
Destination settings (→68)
- 15 Travel elapsed days (→68)
LCD Mode (→20)
Elapsed recording time (→61)
XXhXXmXXs*
- 16 Date Stamp (→81)
- 17 Save destination (→14)
Recording state
- 18 Number of recordable pictures (→15)
Available recording time (→61)
RXXhXXmXXs*

* [h], [m] and [s] indicate "hour", "minute" and "second".

In playback

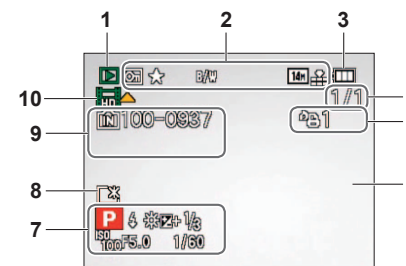

- 1 Playback Mode (→87)
- 2 Protected picture (→99)
Favorites (→97)
Text stamped display (→93)
Date Stamp (→81)
Color Mode (→79)
Picture size (→70)
Quality (→71)
- 3 Battery capacity (→15)
- 4 Picture number/Total pictures (→37)
Elapsed playback time (→86)
XXhXXmXXs*¹
- 5 Quantity of pictures to print (→98)
- 6 Histogram (→39)
- 7 Destination*² (→68)
Name*² (→56, 65)
Title*² (→92)
Recording information
Recorded date and time
Destination settings (→69)
- 8 LCD Mode (→20)
Travel elapsed days (→68)
- 9 Folder/File number (→22, 37, 104)
Save destination (→14)
Cable disconnection warning icon (→106)
Motion picture recording time (→86)
XXhXXmXXs*¹
- 10 Motion pictures (→86)

*¹ [h], [m] and [s] indicate "hour", "minute" and "second".

*² The order of priority for display is location name information, title, destination, name ([Baby]/[Pet]), name ([Face Recog.]).

Screens shown here are only examples. The actual display may vary.

Message displays

Meanings of and required responses to major messages displayed on LCD monitor.

[This memory card cannot be used]

- A MultiMediaCard was inserted.
→ Not compatible with the camera. Use a compatible card.

[Some pictures cannot be deleted] [This picture cannot be deleted]

- Non-DCF pictures (→37) cannot be deleted.
→ Save needed data on a computer or other device, and then use [Format] on the camera. (→23)

[No additional selections can be made]

- The number of pictures that can be deleted at once has exceeded.
- More than 999 pictures have been set as favorites.
- The number of pictures allowing [Title Edit], [Text Stamp] or [Resize] (multiple settings) at once has exceeded.

[Cannot be set on this picture]

- [Print Set], [Title Edit], or [Text Stamp] cannot be made for non-DCF pictures (→37).

[Please turn camera off and then on again] [System Error]

- The lens is not working correctly.
→ Turn on power again.
(Consult the dealer or your nearest Service Center if display still remains)

[Some pictures cannot be copied] [Copy could not be completed]

- Pictures cannot be copied in following cases.
→ Picture of same name already exists in built-in memory when copying from card.
→ File is not of DCF standard. (→37)
→ Picture taken or edited on a different device.

[Not enough space on built-in memory] [Not enough memory on the card]

- There is no space left on the built-in memory or the card. When you copy pictures from the built-in memory to the card (batch copy), the pictures are copied until the capacity of the card becomes full.

[Built-In Memory Error] [Format built-in memory?]

- Displayed when formatting built-in memory via computer, etc.
→ Reformat directly using camera. Data will be deleted.

[Memory Card Error] [Format this card?]

- The card format cannot be used with this camera.
→ Save needed data on a computer or other device, and then use [Format] on the camera. (→23)

[Insert SD card again] [Try another card]

- Access to card has failed.
→ Insert card again.
- Try with a different card.

[Memory card error. This card cannot be used in this camera. Format this card?]

- Card is not of SD standard.
- When cards in capacities of 4 GB or more are used, only SDHC or SDXC Memory Cards are supported.

[Read Error]/[Write Error] [Please check the card]

- Data read has failed.
→ Check whether card has been inserted correctly (→12).
- Data write has failed.
→ Turn off power and remove card, before re-inserting and turning on power again.
- Card may possibly be damaged.
- Try with a different card.

[Motion recording was cancelled due to the limitation of the writing speed of the card]

- If recording stops even when using a card of the recommended speed class (→14), the data writing speed has dropped. If this happens, we recommend backing up the data on the memory card and formatting it (→23).
- Motion picture recording may be automatically terminated with certain cards.

[A folder cannot be created]

- Folder numbers in use have reached 999.
→ Save needed data on a computer or other device, and then use [Format] on the camera. (→23)
Folder number is reset to 100 when performing [No.Reset] (→22).

[Picture is displayed for 16:9 TV] [Picture is displayed for 4:3 TV]

- AV cable (supplied) is connected to the camera.
→ To remove message immediately → Press [MENU/SET].
→ To change aspect ratio → Change [TV Aspect] (→23).
- USB connection cable (supplied) is only connected to the camera.
→ Message disappears when cable is also connected to another device.

[This battery cannot be used]

- Use a genuine Panasonic battery.
- Battery cannot be recognized as terminal is dirty.
→ Wipe any dirt away from the battery terminal.

Try checking these items (→114 - 119) first.
(Restoring menu settings to default values may solve certain problems.
Try using [Reset] in [Setup] menu in Recording Mode (→22).)

Battery, power

Camera does not work even if power is turned on.

- Battery is not inserted correctly (→12), or needs recharging.

LCD monitor shuts off even if power is turned on.

- [Sleep Mode] is activated. (→21)
→ Press shutter button halfway to release.
- Battery needs recharging.

Camera switches off as soon as power is turned on.

- Battery needs recharging.
- [Sleep Mode] is activated. (→21)
→ Press shutter button halfway to release.

Recording

Cannot record pictures.

- REC/PLAY switch is not set to  (record).
- Built-in memory/card is full. → Free space by deleting unwanted pictures (→38).

Recorded pictures look white.

- Lens is dirty (fingerprints, etc.).
→ Turn on power to extract lens barrel, and clean lens surface with a soft, dry cloth.
- Lens is foggy.

Recorded pictures are too bright/too dark.

- Adjust the exposure (→46).
- [Min. Shtr Speed] is set to fast speeds, e.g. [1/250] (→77).

2-3 pictures are taken when I press the shutter button just once.

- Camera set to use [Auto Bracket], [Burst] (→78), or the [Hi-Speed Burst] (→57) or [Flash Burst] (→57) Scene Modes.

Focus not aligned correctly.

- Not set to mode appropriate for distance to subject. (Focus range varies according to Recording Mode.)
- Subject outside of focus range.
- Caused by jitter or subject movement (→80).

Recorded pictures are blurred. Optical Image Stabilizer ineffective.

- Shutter speed is slower in dark locations and Optical Image Stabilizer is less effective.
→ Hold camera firmly with both hands, keeping arms close to body.
- Use a tripod and the self-timer (→45) when using slower shutter speed with [Min. Shtr Speed].

Recording (Continued)

Cannot use [Auto Bracket].

- Only enough memory for 2 pictures or fewer.

Recorded pictures appear coarse, or there is interference.

- ISO Sensitivity is high, or shutter speed is low.
(Default [Sensitivity] setting is [AUTO] – interference may appear with indoor pictures.)
→ Lower [Sensitivity] (→71).
- Set [Color Mode] to [NATURAL] (→79).
→ Take pictures in brighter locations.
- Camera is set to [High Sens.] or [Hi-Speed Burst] Scene Modes.
(Picture becomes slightly coarser in response to high sensitivity)

Brightness or coloring of recorded picture different from real life.

- Taking pictures under fluorescent lighting may require a faster shutter speed and result in slightly changed brightness or coloring, but this is not a fault.

Red banding may appear on the LCD monitor or part or the entire screen may have a reddish tint, when recording or pressing the shutter button halfway.



- This is a characteristic of CCD and may appear if subject contains brighter areas.
Some blurring may occur around these areas, but this is not a fault. This will be recorded in motion pictures, but not in still pictures.
- We recommend keeping the screen away from strong light sources such as sunlight when taking pictures.

Motion picture recording stops midway.

- Motion pictures can be recorded continuously up to 2 GB.
- With some cards, access display may appear briefly after recording, and recording may end midway.
- If recording stops even when using a card of the recommended speed class (→14), the data writing speed has dropped. If this happens, we recommend backing up the data on the memory card and formatting it (→23).

The subject cannot be locked. (AF track fails)

- If the color of the subject is similar to that of its background, AF Tracking may not function. Set the AF area to those colors specific to the subject by aligning that area with the AF area. (→74)

LCD monitor

LCD monitor dims during motion picture recording.

- LCD monitor may dim if continuing motion picture recording for long periods.

Brightness is unstable.

- Aperture value is set while shutter button is pressed halfway. (Does not affect recorded picture.) This symptom may also occur when the brightness changes because the zoom is operated or the camera is moved. This is the automatic aperture operation of the camera and is not a malfunction.

Monitor flickers indoors.

- Monitor may flicker after turning on (prevents influence from fluorescent lighting).

Monitor is too bright/too dark.

- [LCD Mode] is activated. (→20)

Black/blue/red/green dots or interference appears. Monitor looks distorted when touched.

- This is not a fault, and will not be recorded on the actual pictures, so there is no need to worry.

Flash

No flash emitted.



- Flash set to [Forced Flash Off]  (→40).
- Flash cannot be emitted in the [Scenery], [Panorama Assist], [Night Scenery], [Sunset], [Hi-Speed Burst], [Starry Sky], [Fireworks], and [Aerial Photo] Scene Modes, or when using [Auto Bracket] or [Burst].

Multiple flashes are emitted.

- Red-Eye Reduction is active (→40). (Flashes twice to prevent eyes appearing red.)
- The Scene Mode is set to [Flash Burst].

Playback

Pictures have been rotated.

- [Rotate Disp.] is set to  .

Cannot view pictures. There are no recorded pictures.

- REC/PLAY switch is not set to  (play).
- No pictures in built-in memory or card (pictures played from card if inserted, from built-in memory if not).
- Has the file name of the picture been changed on a computer? If so, it cannot be played back on the camera.
- The Playback Mode has been changed. → Set Playback Mode to [Normal Play] (→87).

Playback (Continued)

Folder/file number displayed as [-]. Picture is black.

- Picture edited on computer or taken on different device.
- Battery removed immediately after picture taken, or picture taken with low battery. → Use [Format] to delete (→23).

Incorrect date displayed in Calendar Playback.

- Picture edited on computer or taken on different device.
- [Clock Set] is incorrect (→16). (Incorrect date may be displayed in Calendar Playback on pictures copied to computer and then back to camera, if computer and camera dates differ.)

White round spots like soap bubbles appear on the recorded picture.







- If you take a picture with the flash in a dark place or indoors, white round spots may appear on the picture caused by the flash reflecting particles of dust in the air. This is not a fault. A characteristic of this is that the number of round spots and their position differ in every picture.



[Thumbnail is displayed] is shown on the screen.

- The pictures may have been recorded on another device. If so, they may be displayed with poor picture quality.

Blacken red areas of recorded pictures.

- When digital red-eye correction (, , ) is operating, if a subject is recorded that has skin-colored areas with red areas inside, the digital red-eye correction function may blacken the red areas. → We recommend setting the flash to , , or , or [Red-Eye Removal] to [OFF] before recording.

Sounds of camera operations such as zoom will be recorded in motion pictures.

- Camera operation sounds may be recorded as camera automatically adjusts lens aperture during motion picture recording; this is not a fault.

Motion pictures taken by this camera cannot be played in other cameras.

DMC-ZS9:

- The sound recording specifications on this model have been changed to improve audio quality. For this reason, some motion pictures recorded in [Motion JPEG] may not be played back with Panasonic digital cameras (LUMIX)*. (Motion pictures recorded with a Panasonic digital camera (LUMIX) can be played back on this model.)

* Models launched before December 2008, and some models launched in 2009 (FS, LS series).

DMC-ZS8/DMC-TZ18:

- In some cases, motion pictures taken by this camera cannot be played back by digital cameras from other companies, nor can they also cannot be played in Panasonic digital cameras (LUMIX) that were sold before July 2008.

TV, computer, printer

No image appears on TV. Image blurred or not colored.

- Not connected correctly (→109).
- The television has not been switched to auxiliary input.
- Check the [Video Out] setting (NTSC/PAL) on the camera. (DMC-ZS8PU/DMC-TZ18PR only.) (→23)

TV screen display different to LCD monitor.

- Aspect ratio may be incorrect or edges may be cut off with certain televisions.

Cannot play motion pictures on TV.

- Card is inserted into TV.
 - Connect the camera and TV with the AV cable (supplied) and play motion pictures on camera (→109)

Picture is not displayed on full TV screen.

- Check [TV Aspect] settings (→23).

Cannot send pictures to computer.

- Not connected correctly (→103).
- Check whether computer has recognized camera.
- Set [USB Mode] to [PC] (→22).

Computer does not recognize card (only reads built-in memory).

- Disconnect the USB connection cable (supplied) and reconnect with card in place.

The card is not recognized by the computer.

(You are using an SDXC Memory Card.)

- Make sure your computer supports SDXC Memory Cards.
<http://panasonic.net/avc/sdcard/information/SDXC.html>
- When you insert a card, a message will be displayed requesting you to format the card, but do not format it.
 - If the [Access] indicator on the LCD monitor does not go off, turn off the camera's power before disconnecting the USB connection cable.

Uploading to YouTube or Facebook cannot be performed properly.

- Confirm that the login information (login ID, user name, e-mail address and password) is correct.
- Confirm that the PC is connected to the Internet.
- Confirm that the resident software (such as anti-virus software and the firewall, etc.) is not blocking access to YouTube or Facebook.
- Check the YouTube or Facebook site.

Cannot print when connecting to printer.

- Printer not compatible with PictBridge.
- Set [USB Mode] to [PictBridge(PTP)] (→22).

The edges of pictures are cut off when printing.

- Release any trimming or edgeless printing settings on printer before printing.
(Consult printer operating manual.)
- The pictures were recorded in 16:9 aspect ratio.
 - If printing in shop, check if 16:9 sizes can be printed.

Others

Menu not displayed in desired language.

- Change [Language] setting (→24).

Camera rattles if shaken.

- This sound is made by the lens movement and is not a fault.

Red lamp illuminated when pressing shutter button halfway in dark locations.

- [AF Assist Lamp] is set to [ON] (→80).

AF Assist Lamp is not illuminated.

- [AF Assist Lamp] is set to [OFF].

Camera is hot.

- Camera may become a little warm during use, but this does not affect performance or quality.

Lens makes a clicking noise.

- When brightness changes, the lens may make a clicking noise and the monitor brightness may also change, but this is due to aperture settings being made.
(Does not affect recording.)

Clock is incorrect.

- Camera has been left for a long period.
 - Reset the clock (→16).
- It takes too long to set (clock will be behind by the same lapse of time.).

When using zoom, picture becomes slightly warped and the edges of the subject become colored.

- Pictures may be slightly warped or colored around the edges, depending on the zoom ratio, but this is not a fault.

Zoom movement stops momentarily.

- The zoom movement stops momentarily during Extended Optical Zoom and i.Zoom operation, but this is not a malfunction.

Zoom does not reach the maximum ratio.

- If the zoom ratio stops at 3 ×, [Macro Zoom] has been set. (→43)

File numbers are not recorded in sequence.

- File numbers are reset when new folders are created (→104).

File numbers have jumped backwards.

- Battery was removed/inserted with power on.
(Numbers may jump backwards if folder/file numbers are not correctly recorded.)

When no operation is performed for a while, the demo is suddenly displayed.

- This is the Automatic Demo Mode that introduces the features of this camera. Press [MENU/SET] to return to the previous screen.

Usage cautions and notes

When in use

- Camera may become warm if used for long periods of time, but this is not a fault.
- **Keep the camera as far away as possible from electromagnetic equipment (such as microwave ovens, TVs, video games etc.).**
 - If you use the camera on top of or near a TV, the pictures and sound on the camera may be disrupted by electromagnetic wave radiation.
 - Do not use the camera near cell phones because doing so may result in noise adversely affecting the pictures and sound.
 - Recorded data may be damaged, or pictures may be distorted, by strong magnetic fields created by speakers or large motors.
 - Electromagnetic wave radiation generated by microprocessors may adversely affect the camera, disturbing the pictures and sound.
 - If the camera is adversely affected by electromagnetic equipment and stops functioning properly, turn the camera off and remove the battery or disconnect AC adaptor (optional). Then reinsert the battery or reconnect AC adaptor and turn the camera on.
- **Do not use the camera near radio transmitters or high-voltage lines.**
 - If you record near radio transmitters or high-voltage lines, the recorded pictures and sound may be adversely affected.
- Do not extend the supplied cord or cable.
- Do not allow camera to come into contact with pesticides or volatile substances (can cause surface damage or coating to peel).
- Never leave the camera and the battery in a car or on a car hood in the summer. It may cause leakage of the battery electrolyte, a generation of heat, and may cause a fire and the battery to burst due to the high temperature.

Caring for your camera

To clean your camera, remove the battery or disconnect the power plug from the outlet, and wipe with a soft, dry cloth.

- Use a damp cloth to remove stubborn stains, before wiping with a dry cloth.
- Do not use benzene, thinners, alcohol, or kitchen detergent, as these may damage the outer casing and finish of the camera.
- If using a chemically-treated cloth, read the supplied instructions carefully.
- Do not touch the lens barrier.

When not using for a while

- Turn off camera power before removing battery and card (ensure that battery is removed to prevent damage through over-discharge).
- Do not leave in contact with rubber or plastic bags.
- Store together with a drying agent (silica gel) if leaving in a drawer, etc. Store batteries in cool (15 °C - 25 °C (59 °F - 77 °F)) places with low humidity (40 %RH - 60 %RH) and no major temperature changes.
- Charge battery once per year and use completely before storing again.

Memory cards

- To prevent damage to cards and data
 - Avoid high temperatures, direct sunlight, electromagnetic waves, and static electricity.
 - Do not bend, drop, or expose to strong impacts.
 - Do not touch connectors on reverse of card or allow them to become dirty or wet.
- When disposing of/transferring memory cards
 - If using the "format" or "delete" functions on your camera or computer, this only changes the file management information, and does not completely delete the data from within the memory card. When disposing of or transferring your memory cards, we recommend physically destroying the memory card itself, or using commercially available computer data erasing software to completely delete the data from the card. Data within memory cards should be managed responsibly.

LCD monitor

- Do not press hard on the LCD monitor. This may cause uneven display and damage the monitor.
- In cold climates or other situations when the camera becomes cold, the LCD monitor may be slightly less responsive than normal immediately after startup. Normal brightness will return once the internal components have warmed up.

Extremely high precision technology is employed to produce the LCD monitor screen. However there may be some dark or bright spots (red, blue or green) on the screen. This is not a malfunction. The LCD monitor screen has more than 99.99% effective pixels with a mere 0.01% of the pixels inactive or always lit. The spots will not be recorded on pictures on the built-in memory or a card.

Usage cautions and notes (Continued)

Lens

- If lens is dirty:
Images may appear slightly white if lens is dirty (fingerprints, etc.).
Turn the power on, hold the extracted lens barrel with your fingers, and gently wipe the lens surface with a soft, dry cloth.
- Do not leave the lens exposed to direct sunlight.
- Do not touch the lens barrier, as this may damage lens. Be careful when removing camera from bag, etc.

When using a tripod or unipod

- Do not apply excessive force or tighten screws when they are crooked. (This may damage the camera, screw hole, or label.)
- Ensure that the tripod is stable. (Refer to the tripod instructions.)

Personal Information

If names or birthdays are set in [Baby] Mode or in the [Face Recog.] function, personal information will be contained in the camera and the pictures that have been taken.

- Disclaimer
 - Data containing personal information can be altered or lost due to malfunction, static electricity, accidents, breakdowns, repairs, or other operations.
Panasonic will not be liable for any damage that occurs, direct or indirect, as a result of the alteration or loss of data containing personal information.
- When ordering repairs or transferring/disposing of the camera
 - To protect your personal information, please reset the settings. (→22)
 - If any pictures are contained in the built-in memory, copy (→101) them to a memory card if necessary, and then format (→23) the built-in memory.
 - Remove the memory card from the camera.
 - When ordering repairs, the built-in memory and other settings may be returned to the initial purchase state.
 - If the above operations cannot be performed because of a camera malfunction, consult with the dealer or nearest Service Center.

When transferring or disposing of your memory card, see “When disposing of/ transferring memory cards” in the previous section.



- SDXC Logo is a trademark of SD-3C, LLC.
- QuickTime and the QuickTime logo are trademarks or registered trademarks of Apple Inc., used under license therefrom.
- YouTube is a trademark of Google Inc.
- This product uses "DynaFont" from DynaComware Corporation. DynaFont is a registered trademark of DynaComware Taiwan Inc.
- Other names, company names, and product names printed in these instructions are trademarks or registered trademarks of the companies concerned.