

Panasonic®

Basic Owner's Manual Digital Camera

Model No. **DMC-TS25**

LUMIX

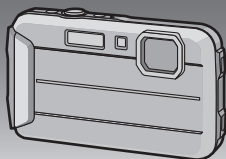

Please read these instructions carefully before using this product, and save this manual for future use.



More detailed instructions on the operation of this camera are contained in "Owner's Manual for advanced features (PDF format)" in the supplied CD-ROM. Install it on your PC to read it.



Register online at www.panasonic.com/register
(U.S. customers only)

For USA and Puerto Rico assistance, please call: 1-800-211-PANA(7262) or,
contact us via the web at: <http://www.panasonic.com/contactinfo>

P

BC

VQT4N50
F1112YS0

Dear Customer,

Thank you for choosing Panasonic!

You have purchased one of the most sophisticated and reliable products on the market today. Used properly, we're sure it will bring you and your family years of enjoyment. Please take time to fill in the information on the below. The serial number is on the tag located on the underside of your camera. Be sure to **retain this manual** as your convenient camera information source.

Date of Purchase	Dealer Phone No.
Dealer Purchased From	Model No.
Dealer Address	Serial No.

Please note that the actual controls and components, menu items, etc. of your Digital Camera may look somewhat different from those shown in the illustrations in this Owner's Manual.

Carefully observe copyright laws.

- Recording of pre-recorded tapes or discs or other published or broadcast material for purposes other than your own private use may infringe copyright laws. Even for the purpose of private use, recording of certain material may be restricted.



A lithium ion battery that is recyclable powers the product you have purchased. Please call 1-800-8-BATTERY for information on how to recycle this battery.

-If you see this symbol-

Information on Disposal in other Countries outside the European Union

This symbol is only valid in the European Union. If you wish to discard this product, please contact your local authorities or dealer and ask for the correct method of disposal.



Information for Your Safety

WARNING:

To reduce the risk of fire, electric shock or product damage,

- Do not let water or other liquids drip or splash inside the unit.
- Do not expose accessories (battery pack, battery charger, AC adaptor, SD memory card and etc.) to rain, moisture, dripping or splashing.
- Use only the recommended accessories.
- Do not remove covers.
- Do not repair this unit by yourself. Refer servicing to qualified service personnel.

The socket outlet shall be installed near the equipment and shall be easily accessible.

■ Product identification marking

Product	Location
Digital Camera	Bottom
Battery Charger	Bottom

FCC Note:

This equipment has been tested and found to comply with the limits for a Class B digital device, pursuant to Part 15 of the FCC Rules. These limits are designed to provide reasonable protection against harmful interference in a residential installation. This equipment generates, uses, and can radiate radio frequency energy and, if not installed and used in accordance with the instructions, may cause harmful interference to radio communications. However, there is no guarantee that interference will not occur in a particular installation. If this equipment does cause harmful interference to radio or television reception, which can be determined by turning the equipment off and on, the user is encouraged to try to correct the interference by one or more of the following measures:

- Reorient or relocate the receiving antenna.
- Increase the separation between the equipment and receiver.
- Connect the equipment into an outlet on a circuit different from that to which the receiver is connected.
- Consult the dealer or an experienced radio/TV technician for help.

FCC Caution: To assure continued compliance, follow the attached installation instructions and use only shielded interface cables with ferrite core when connecting to computer or peripheral devices.

Any changes or modifications not expressly approved by the party responsible for compliance could void the user's authority to operate this equipment.

Declaration of Conformity

Trade Name: Panasonic
Model No.: DMC-TS25
Responsible Party: Panasonic Corporation of North America
One Panasonic Way, Secaucus, NJ 07094
Support Contact: Panasonic Consumer Marketing Company of North America
1-800-211-PANA (7262)

This device complies with Part 15 of the FCC Rules. Operation is subject to the following two conditions: (1) This device may not cause harmful interference, and (2) this device must accept any interference received, including interference that may cause undesired operation.



■ About the battery pack

CAUTION

Battery pack (Lithium ion battery pack)

- Use the specified unit to recharge the battery pack.
- Do not use the battery pack with equipment other than the specified unit.
- Do not get dirt, sand, liquids, or other foreign matter on the terminals.
- Do not touch the plug terminals (+ and –) with metal objects.
- Do not disassemble, remodel, heat or throw into fire.

If any electrolyte should come into contact with your hands or clothes, wash it off thoroughly with water.

If any electrolyte should come into contact with your eyes, never rub the eyes. Rinse eyes thoroughly with water, and then consult a doctor.

CAUTION

- Danger of explosion if battery is incorrectly replaced. Replace only with the type recommended by the manufacturer.
- When disposing the batteries, please contact your local authorities or dealer and ask for the correct method of disposal.

- Do not heat or expose to flame.
- Do not leave the battery(ies) in a car exposed to direct sunlight for a long period of time with doors and windows closed.

Warning

Risk of fire, explosion and burns. Do not disassemble, heat above 60 °C (140 °F) or incinerate.

■ About the battery charger

CAUTION!

To reduce the risk of fire, electric shock or product damage,

- Do not install or place this unit in a bookcase, built-in cabinet or in another confined space. Ensure this unit is well ventilated.

Battery charger

This battery charger operates on AC between 110 V and 240 V.

But

- In the U.S.A. and Canada, the battery charger must be connected to a 120 V AC power supply only.
- When connecting to an AC supply outside of the U.S.A. or Canada, use a plug adaptor to suit the AC outlet configuration.

■ Cautions for Use

- Do not use any other USB connection cables except the supplied one or a genuine Panasonic USB connection cable (DMW-USBC1: optional).
- Always use a genuine Panasonic AV cable (DMW-AVC1: optional).

Keep this unit as far away as possible from electromagnetic equipment (such as microwave ovens, TVs, video games etc.).

- If you use this unit on top of or near a TV, the pictures and/or sound on this unit may be disrupted by electromagnetic wave radiation.
- Do not use this unit near cell phones because doing so may result in noise adversely affecting the pictures and/or sound.
- Recorded data may be damaged, or pictures may be distorted, by strong magnetic fields created by speakers or large motors.
- Electromagnetic wave radiation generated by microprocessors may adversely affect this unit, disturbing the pictures and/or sound.
- If this unit is adversely affected by electromagnetic equipment and stops functioning properly, turn this unit off and remove the battery or disconnect AC adaptor (DMW-AC5PP: optional). Then reinsert the battery or reconnect AC adaptor and turn this unit on.

Do not use this unit near radio transmitters or high-voltage lines.

- If you record near radio transmitters or high-voltage lines, the recorded pictures and/or sound may be adversely affected.

Contents

Information for Your Safety.....	3
Before Use	8
Standard Accessories	9
(Important) About the Waterproof/Dustproof and Anti-shock Performance of the Camera	10
Names and Functions of Main Parts	15
Charging the Battery.....	16
Inserting and Removing the Card (optional)/the Battery	17
Sequence of operations	18
Reading the Owner's Manual (PDF format)	20
Installing supplied software.....	21
Specifications	22
Digital Camera Accessory System	25
Digital Camera Accessory Order Form	26
Limited Warranty (ONLY FOR U.S.A. AND PUERTO RICO)	27

Before Use

Please be sure to read “(Important) About the Waterproof/Dustproof and Anti-shock Performance of the Camera” (P10) before using this unit underwater to prevent the unit from being mishandled, which may cause water to seep in.

- Do not apply strong shock or vibration by dropping or knocking the camera. Also, do not apply strong pressure to the camera.
 - Waterproof performance may be impaired.
 - Lens or LCD monitor may be damaged.
 - It may cause malfunction in the performance or the function.

■ When inner side of the lens is fogged (condensation)

It is not a malfunction or failure of the camera. It may be caused by the environment in which the camera is used.

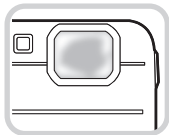

What to do when inner side of the lens is fogged

- Turn off the power and open the side door in a place with constant ambient temperature, away from high temperatures, humidity, sand and dust. The fog will disappear naturally in 10 minutes to 2 hours with the side door open when the temperature of the camera gets close to the ambient temperature.
- Contact Panasonic if the fogging does not disappear.

Conditions in which inner side of the lens may be fogged

Condensation may occur and the inner side of the lens may be fogged when the camera is used in areas that undergo a significant change in temperature or in high humidity, such as the following:

- When the camera is used underwater suddenly after being on a hot beach etc.
- When the camera is moved to a warm area from a cold area, such as at a ski resort or at high altitude
- When the side door is opened in a high-humidity environment

Standard Accessories

Check that all the accessories are supplied before using the camera.
Product numbers correct as of January 2013. These may be subject to change.

- 1 Battery Pack
(Indicated as **battery pack** or **battery** in the text)
Charge the battery before use.
- 2 Battery Charger
(Indicated as **battery charger** or **charger** in the text)
- 3 USB Connection Cable
- 4 CD-ROM
 - Software
 - Owner's Manual for advanced featuresInstall on your PC before use.
- 5 Hand Strap

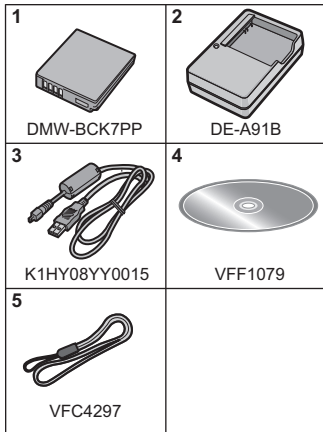

- Supplied accessories are not waterproof.
- SD Memory Card, SDHC Memory Card and SDXC Memory Card are indicated as **card** in the text.
- **The card is optional.**
You can record or play back pictures on the built-in memory when you are not using a card.
- For information about optional accessories, refer to the “Digital Camera Accessory System”.
- If any accessories are lost, customers should contact Panasonic's parts department at 1-800-833-9626 for further information about obtaining replacement parts.

(Important) About the Waterproof/ Dustproof and Anti-shock Performance of the Camera

Waterproof/Dustproof Performance

This camera's waterproof/dustproof rating complies with the "IPX8" and "IP6X" ratings. Provided the care and maintenance guidelines described in this document are strictly followed, this camera can operate underwater, to a depth not exceeding 7 m (23 feet) for a time not exceeding 60 minutes. (*1)

Anti-shock Performance

This camera also complies with "MIL-STD 810F Method 516.5-Shock". The camera has cleared a drop test from a height of 1.5 m (5 feet) onto 3 cm (0.1 feet) thick plywood. In most cases this camera should not sustain any damage if dropped from a height not exceeding 1.5 m (5 feet). (*2)

This does not guarantee no destruction, no malfunction, or waterproofing in all conditions.

- *1 This means that the camera can be used underwater for specified time in specified pressure in accordance with the handling method established by Panasonic.
- *2 "MIL-STD 810F Method 516.5-Shock" is the test method standard of the U.S. Defense Department, which specifies performing drop tests from a height of 122 cm (4 feet), at 26 orientations (8 corners, 12 ridges, 6 faces) using 5 sets of devices, and passing the 26 orientation drops within 5 devices. (If failure occurs during the test, a new set is used to pass the drop orientation test within a total of 5 devices)
Panasonic's test method is based on the above "MIL-STD 810F Method 516.5-Shock". However, the drop height was changed from 122 cm (4 feet) to 150 cm (5 feet) dropping onto 3 cm (0.1 feet) thick plywood. This drop test was passed.
(Disregarding appearance change such as loss of paint or distortion of the part where drop impact is applied.)

■ Handling of the camera

- Waterproofing is not guaranteed if the unit is subject to an impact as a result of being hit or dropped etc. If an impact to the camera occurs, it should be inspected (subject to a fee) by a Panasonic to verify that the waterproofing is still effective.
- When the camera is splashed with detergent, soap, hot spring, bath additive, sun oil, sun screen, chemical, etc., wipe it off immediately.
- Waterproof function of the camera is for sea water and fresh water only.
- Any malfunction caused by customer misuse, or mishandling will not be covered by the warranty.
- The inside of this unit is not waterproof. Water leakage will cause malfunction.
- Supplied accessories are not waterproof.
- Card and battery are not waterproof. Do not handle with a wet hand. Also, do not insert wet card or battery into the camera.
- Do not leave the camera for a long period of time in places where the temperature is very low (such as at ski resorts or high altitudes) or where the temperature may exceed 40 °C (104 °F) (such as inside cars in strong sunlight, close to a heater, on boats, or on the beach). (Waterproof performance may become degraded.)

■ About the [Precautions] demonstration display ([Requirements for Underwater use])

- [Precautions] is displayed when the power is turned on for the first time after purchase, with the side door completely closed.
- Please check beforehand to maintain the waterproof performance.

1 Press ◀ to select [Yes], and press [MENU/SET].

- It will automatically skip to the clock setting screen if [No] is selected before it starts.

2 Press ◀/▶ to select the picture.

◀: Return to the previous screen

▶: View the next screen

- It can be forcefully ended by pressing [MENU/SET].
- When it is forcefully ended while checking by turning the unit off or pressing [MENU/SET], [Precautions] is displayed every time the power is turned on.

3 After the final screen (12/12), press [MENU/SET] to finish.

- When [MENU/SET] is pressed after the final screen (12/12), [Precautions] is not displayed from the next time the power is turned on.
- This can also be viewed from [Precautions] in the [Setup] menu.

Check before using underwater

Always wipe the rubber seal on the side door and the area where rubber seal sits with a dry, lint-free cloth.

- 1 Check that there are no foreign objects on the inner side of the side door.**
 - If there is any foreign object, such as lint, hair, sand, etc., on the surrounding area, water will leak within a few seconds causing malfunction.
 - Wipe it off with a dry soft cloth if there is any liquid.
It may cause water leaks and malfunction if you use the camera with liquid adhered.
 - If foreign objects are present, wipe them off with a dry, lint-free cloth.
 - Be extremely careful to remove the small sand etc. that may adhere to the sides and corners of the rubber seal.
- 2 Check for cracks and deformation of the rubber seal on the side door.**
 - The integrity of the rubber seals may decrease after about 1 year, with use and age. To avoid permanently damaging the camera, the seals should be replaced once each year. Please contact Panasonic for related costs and other information.
- 3 Close the side door securely.**
 - [LOCK] switch (gray part)
 - Red part
 - Released state
 - Locked state
 - Lock the [LOCK] switch securely until the red part is no longer visible.
 - To prevent water intrusion, be careful not to catch foreign objects such as liquids, sand, hair, dust, or the strap cord.

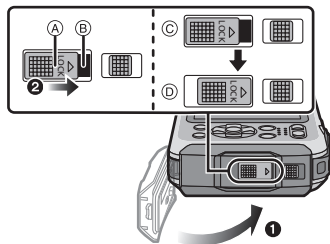

Do not open or close the side door in places with sand and dust, close to water, or with wet hands. Sand or dust adhering may cause water leaks.

Using the camera underwater

- Use the camera underwater to 7 m (23 feet) with the water temperature between 0 °C and 40 °C (32 °F and 104 °F).
- Do not use for scuba diving (Aqualung).
- Do not use the camera at a depth of over 7 m (23 feet).
- Do not use it in the hot water over 40 °C (104 °F) (in the bath or hot spring).
- Do not use the camera underwater longer than 60 minutes continuously.
- Do not open or close the side door underwater.
- Do not apply shock to the camera underwater. (Waterproof performance may not be maintained, and there is a chance of water leak.)
- Do not dive into the water holding the camera. Do not use the camera in a location where the water will splash strongly, such as rapid flow or waterfall. (Strong water pressure may be applied, and it may cause malfunction.)
- The camera will sink in the water. Take care not to drop the camera and lose it underwater by securely placing the strap around your wrist or similar measure.

Caring of the camera after using it underwater

Do not open or close the side door until the sand and dust is removed by rinsing the camera with water.

Make sure to clean the camera after using it.

- Thoroughly wipe off any water droplets, sand, and saline matter on your hands, body, hair, etc.
- It is recommended to clean the camera indoors, avoiding places where water spray or sand may fall.

After using it underwater, always clean the camera rather than leaving it in a dirty state.

- Leaving the camera with foreign objects or saline matter on it may cause damage, discoloration, corrosion, unusual odour, or deterioration of the waterproof performance.

1 Rinse with water with the side door closed.

- After use at the seaside or underwater, soak the unit in fresh water pooled in a shallow container for 10 minutes or less.
- If the zoom button or camera [ON/OFF] button do not press smoothly, it may be caused by an adhesion of foreign objects. Using in such a state may cause malfunctions, such as locking up, so wash off any foreign objects by shaking the camera in fresh water.
- Bubbles may come out of the drainage hole when you immerse the camera in water, but this is not a malfunction.



2 Drain water by holding the camera upside-down (A) and the right way up (B) and shaking it lightly a few times.

- After using the camera at the beach or in water, or after washing it, water may remain around the speaker and microphone for a while and may cause a drop in volume or sound distortion.
- Make sure to put your hand through the strap to prevent the camera from falling.

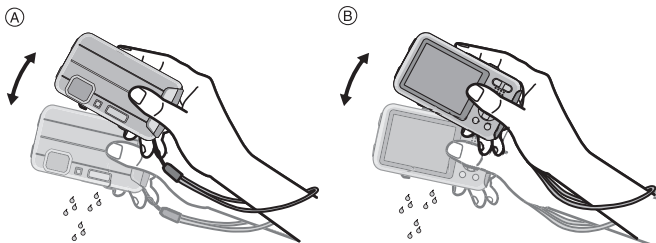

3 Wipe off water drops on the camera with a soft, dry cloth and dry the camera in a shaded area that is well ventilated.

- Dry the camera by standing it on a dry cloth. This unit incorporates drain design, draining water in gaps in the camera [ON/OFF] button and zoom button etc.
- Do not dry the camera with hot air from dryer or similar. Waterproof performance will deteriorate due to deformation.
- Do not use chemicals such as benzene, thinner, alcohol or cleanser, soap or detergents.



4 Confirm that there are no water droplets, open the side door, and wipe off any water droplets or sand left inside using a soft, dry cloth.

- Water droplets may adhere to the card or battery when the side door is opened without thoroughly drying. Also, water may accumulate in the gap around the card/battery slot or the terminal connector. Be sure to wipe any water off with a soft, dry cloth.
- The water droplets may seep into the camera when the side door is closed while it is still wet, causing condensation or failure.

Names and Functions of Main Parts

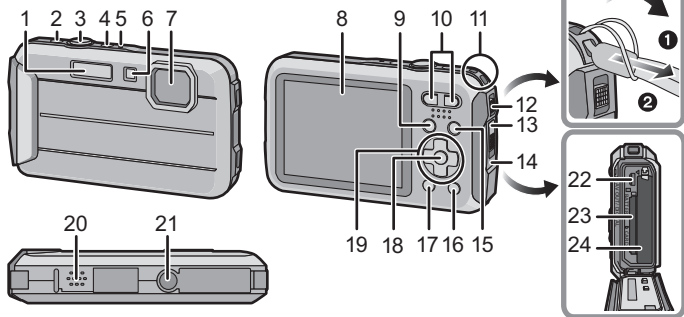

- | | | | |
|----|---|---|-------------------------|
| 1 | Flash | 17 | [DISP.] button |
| 2 | Motion picture button | 18 | [MENU/SET] button |
| 3 | Shutter button | 19 | Cursor buttons |
| 4 | Camera [ON/OFF] button | 20 | Speaker |
| 5 | Microphone | <ul style="list-style-type: none"> • Be careful not to cover the speaker with your finger. Doing so may make sound difficult to hear. | |
| 6 | Self-timer indicator/
AF Assist Lamp/
LED light | 21 | Tripod mount |
| 7 | Lens | <ul style="list-style-type: none"> • A tripod with a screw length of 5.5 mm (0.22 inch) or more may damage this unit if attached. | |
| 8 | LCD monitor | 22 | [AV OUT/DIGITAL] socket |
| 9 | [MODE] button | 23 | Card slot |
| 10 | Zoom button | 24 | Battery slot |
| 11 | Strap eyelet | <ul style="list-style-type: none"> • When using an AC adaptor, ensure that the Panasonic DC coupler (DMW-DCC10: optional) and AC adaptor (DMW-AC5PP: optional) are used. • Always use a genuine Panasonic AC adaptor (DMW-AC5PP: optional). | |
| 12 | Release lever | | |
| 13 | [LOCK] switch | | |
| 14 | Side door | | |
| 15 | [▶] (Playback) button | | |
| 16 | [Q.MENU] button/[⏏/↵] (Delete/
Cancel) button | | |

Charging the Battery

Use the dedicated charger and battery.

- The battery is not charged when the camera is shipped. Charge the battery before use.
- Charge the battery with the charger indoors [10 °C to 30 °C (50 °F to 86 °F)].

- 1** Attach the battery paying attention to the direction of the battery.

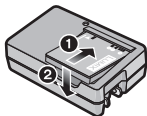

- 2** Connect the charger to the electrical outlet.

- The [CHARGE] indicator (A) lights up and charging begins.

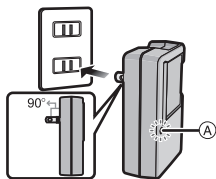

■ About the [CHARGE] indicator

On: Charging.

Off: Charging has completed. (Charging time: Approx. 120 min)

■ About batteries that you can use with this unit

The battery that can be used with this unit is DMW-BCK7PP.

Inserting and Removing the Card (optional)/the Battery

- Check that this unit is turned off.
- **Confirm that there is no foreign object.**
- We recommend using a Panasonic card.

1 ①: Slide the [LOCK] switch (A), and release the lock.

②: Slide the release lever (B) and open the side door.

- Always use genuine Panasonic batteries (DMW-BCK7PP).
- If you use other batteries, we cannot guarantee the quality of this product.

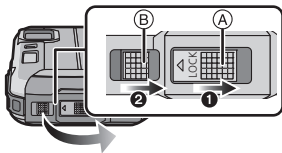

2 **Battery:** Being careful about the battery orientation, insert all the way until you hear a locking sound and then check that it is locked by lever (C). Pull the lever (C) in the direction of the arrow to remove the battery.

Card: Push it securely all the way until you hear a “click” while being careful about the direction in which you insert it. To remove the card, push the card until it clicks, then pull the card out upright.

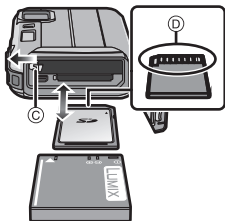

ⓓ: Do not touch the connection terminals of the card.

3 Close the side door until it clicks, and then lock the [LOCK] switch by sliding it toward [▶].

- Confirm that the red part on the [LOCK] switch is not showing.

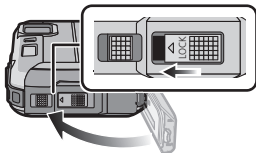

Note

- Keep the Memory Card out of reach of children to prevent swallowing.

Sequence of operations

1 Press camera [ON/OFF] button.

- The clock is not set when the camera is shipped. Set the date and time before using the camera.

2 Press the shutter button halfway to focus and then press it fully to take the picture.

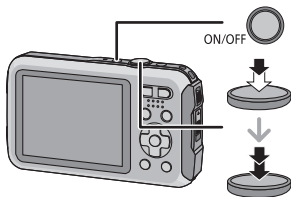

■ Selecting the Recording Mode

Press [MODE] to select the Recording Mode.

: Take pictures with automatic settings.

: Take pictures with your own settings.

: Record while checking the image effect.

: This mode is optimal for taking pictures of sporting events, etc.

: This mode is optimal for taking pictures that show the snow as white as possible at a ski resort or a snow-covered mountain.

: This mode is optimal for taking pictures to 3 m (10 feet) underwater and at the beach.

: This mode is optimal for taking pictures at depths of 3 m (10 feet) to 7 m (23 feet).

: This mode allows you to take panorama pictures.

SCN: Take pictures according to scene.

■ Recording Motion Pictures

Start recording by pressing the motion picture button.

- Stop the recording by pressing the motion picture button again.
 - Maximum time to record motion pictures continuously is 29 minutes 59 seconds.
The maximum available recording time continuously is displayed on the screen.
-

■ Setting the Menu

Press [MENU/SET] to display the menu screen to change the recording function, camera settings, and other settings.

■ Playing Back Pictures

Press [▶].

- Press ◀ or ▶ to select the picture.
-

■ Deleting Pictures

Select the picture, and then press [🗑️/↶].

- Confirmation screen is displayed. Picture is deleted by selecting [Yes].
-

■ About the [LED Light] ([Setup])

If you set to [🔦], and press and hold down ▶ (🔦) on the recording standby screen, the LED light will come on for 60 seconds.



Reading the Owner's Manual (PDF format)

More detailed instructions on the operation of this camera are contained in "Owner's Manual for advanced features (PDF format)" in the supplied CD-ROM. Install it on your PC to read it.

■ For Windows

- 1 Turn the PC on and insert the CD-ROM containing the Owner's Manual (supplied).
- 2 Click the [Owner's Manual].
- 3 Select the desired language and then click [Owner's Manual] to install.
Ⓐ To return to the install menu.
- 4 Double-click the "Owner's Manual" shortcut icon on the desktop.

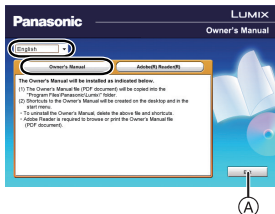

■ When the Owner's Manual (PDF format) will not open

You will need Adobe Acrobat Reader 5.0 or later, or Adobe Reader 7.0 or later to browse or print the Owner's Manual (PDF format).

- You can download and install a version of Adobe Reader that you can use with your OS from the following website.
<http://get.adobe.com/reader/otherversions/>

Installing supplied software

- The supplied CD-ROM includes the following software.
 - PHOTOfunSTUDIO 9.0 SE (Windows8/7/Vista/XP)
 - LoiLoScope 30 day full trial version (Windows8/7/Vista/XP)
(This will only install a shortcut to the trial version download site.)
- Before inserting the CD-ROM, close all running applications.

1 Check the environment of your PC.

- For details about information such as the operating environment or operating method, refer to the “Owner’s Manual for advanced features” (PDF file) or the operating instructions for the respective software programs.

2 Insert the CD-ROM with the supplied software.

- When you insert the supplied CD-ROM, the install menu will start.

3 Click on the [Applications] on the install menu.

4 Click on the [Recommended Installation].

- Proceed with installation according to messages appearing on the screen.

Note

- The software compatible with your PC will be installed.
- “PHOTOfunSTUDIO” and “LoiLoScope” are not compatible with Mac.

Specifications

Specifications are subject to change without notice.

Digital Camera:

Information for your safety

Power Source:	DC 5.1 V
Power Consumption:	1.0 W (When recording) 0.6 W (When playing back)

Camera effective pixels	16,100,000 pixels	
Image sensor	1/2.33" CCD, total pixel number 16,600,000 pixels, Primary color filter	
Lens	Optical 4× zoom, f=4.5 mm to 18 mm (35 mm film camera equivalent: 25 mm to 100 mm)/F3.9 (Wide) to F5.7 (Tele)	
Image stabilizer	Optical method	
Focus range	Normal	50 cm (1.6 feet) (Wide)/1 m (3.3 feet) (Tele) to ∞
	Macro/ Intelligent auto/ Motion picture	5 cm (0.16 feet) (Wide)/1 m (3.3 feet) (Tele) to ∞
	Scene Mode	There may be differences in the above settings.
Shutter system	Electronic shutter+Mechanical shutter	
Minimum Illumination	Approx. 14 lx (when i-low light is used, the shutter speed is 1/30th of a second)	
Shutter speed	8 seconds to 1/1300th of a second [Starry Sky] Mode: 15 seconds, 30 seconds, 60 seconds	
Exposure (AE)	Auto (Program AE)	
Metering mode	Multiple	
LCD monitor	2.7" TFT LCD (4:3) (Approx. 230,000 dots) (field of view ratio about 100%)	

Microphone	Monaural
Speaker	Monaural
Recording media	Built-in Memory (Approx. 70 MB)/SD Memory Card/ SDHC Memory Card/SDXC Memory Card
Recording file format	
Still Picture	JPEG (based on "Design rule for Camera File system", based on "Exif 2.3" standard)/DPOF corresponding
Motion pictures	MP4
Audio compression format	AAC
Interface	
Digital	"USB 2.0" (High Speed)
Analog video	NTSC
Audio	Audio line output (monaural)
Terminal	
[AV OUT/DIGITAL]	Dedicated jack (8 pin)
Dimensions (excluding the projecting parts)	Approx. 103.7 mm (W)×58.3 mm (H)×19.7 mm (D) [4.08"(W)×2.3"(H)×0.77"(D)]
Mass (weight)	Approx. 144 g/0.317 lb (with card and battery) Approx. 125 g/0.275 lb (excluding card and battery)
Operating temperature	−10 °C* to 40 °C (14 °F* to 104 °F) * The performance of the battery (number of recordable pictures/operating time) may decrease temporarily when using in a temperature between −10 °C and 0 °C (14 °F and 32 °F) (cold places such as ski resorts or places at high altitude).
Operating humidity	10%RH to 80%RH
Language select	[ENGLISH]/[ESPAÑOL]
Waterproof performance	Equivalent to IEC 60529 "IPX8". [Usable for 60 minutes in 7 m (23 feet) water depth]

Crash resistance performance	<p>The test method of the camera is in compliance with "MIL-STD 810F Method 516.5-Shock"*.</p> <p>* "MIL-STD 810F Method 516.5-Shock" is the test method standard of the U.S. Defense Department, which specifies performing drop tests from a height of 122 cm (4 feet), at 26 orientations (8 corners, 12 ridges, 6 faces) using 5 sets of devices, and passing the 26 orientation drops within 5 devices.</p> <p>(If failure occurs during the test, a new set is used to pass the drop orientation test within a total of 5 devices)</p> <ul style="list-style-type: none"> • Panasonic's test method is based on the above "MIL-STD 810F Method 516.5-Shock". However, the drop height was changed from 122 cm (4 feet) to 150 cm (5 feet) dropping onto 3 cm (0.1 feet) thick plywood. This drop test was passed. <p>(Disregarding appearance change such as loss of paint or distortion of the part where drop impact is applied.)</p> <p>There is no guarantee of not breaking or malfunctioning under all conditions.</p>
Dustproof performance	<p>Equivalent to IEC 60529 "IP6X".</p>

Battery Charger (Panasonic DE-A91B):

Information for your safety

Input:	<p>~ 110 V to 240 V, 50/60 Hz, 0.2 A</p>
Output:	<p>=== 4.2 V, 0.43 A</p>
Operating temperature:	<p>0 °C* to 40 °C (32 °F* to 104 °F)</p> <p>* The battery cannot be recharged in a temperature less than 0 °C (32 °F). (The [CHARGE] indicator blinks when the battery cannot be recharged.)</p>

Equipment mobility:





Movable

Battery Pack (lithium-ion) (Panasonic DMW-BCK7PP):

Information for your safety

Voltage/capacity:	<p>3.6 V/680 mAh</p>
--------------------------	----------------------

Digital Camera Accessory System

Accessory#	Illustration	Description
DMW-BCK7		Battery Pack
DMW-AC5		AC Adaptor*
DMW-DCC10		DC Coupler*
DMW-USBC1		USB Connection Cable
DMW-AVC1		AV Cable

Product numbers correct as of January 2013. These may be subject to change.

- * The AC Adaptor (optional) can only be used with the designated Panasonic DC Coupler (optional). The AC adaptor (optional) cannot be used by itself.
- NOTE: Accessories and/or model numbers may vary between countries. Consult your local dealer.

Digital Camera Accessory Order Form

Please photocopy this form when placing an order.

1. Digital Camera Model # _____

2. Items Ordered

Accessory #	Description	Price Each	Quantity	Total Price
Shipping & Handling				\$6.95
Subtotal				
Your State & Local Sales Tax				
Total				

3. Method of payment (check one)

American Express

VISA Credit Card # _____

MasterCard Expiration Date _____

Discover Customer Signature _____

(Please do not send cash)

4. Shipping information (UPS delivery requires complete street address)

Ship To:

Mr.

Mrs.

Ms.

First

Last

Phone#:

Day () _____

Street Address

Night () _____

City

State

Zip

TO OBTAIN ANY OF OUR DIGITAL CAMERA ACCESSORIES YOU CAN DO ANY OF
THE FOLLOWING:

VISIT YOUR LOCAL PANASONIC DEALER

OR

CALL PANASONIC'S ACCESSORY ORDER LINE AT 1-800-332-5368

[6 AM-6 PM M-F, PACIFIC TIME]

OR

MAIL THIS ORDER TO: PANASONIC NATIONAL PARTS CENTER

20421 84th Ave S., Kent, WA 98032

Limited Warranty (ONLY FOR U.S.A. AND PUERTO RICO)

**Panasonic Consumer Marketing Company of North America,
Division of Panasonic Corporation of North America**
One Panasonic Way, Secaucus, New Jersey 07094

Panasonic Products Limited Warranty

Limited Warranty Coverage (For USA and Puerto Rico Only)

If your product does not work properly because of a defect in materials or workmanship, Panasonic Consumer Marketing Company of North America (referred to as “the warrantor”) will, for the length of the period indicated on the chart below, which starts with the date of original purchase (“warranty period”), at its option either (a) repair your product with new or refurbished parts, (b) replace it with a new or a refurbished equivalent value product, or (c) refund your purchase price. The decision to repair, replace or refund will be made by the warrantor.

Product or Part Name	Parts	Labor
Digital Camera	1 Year	1 Year
All included Accessories (Except Non-Rechargeable Batteries)	90 Days	Not Applicable
Only Non-Rechargeable Batteries	10 Days	Not Applicable

During the “Labor” warranty period there will be no charge for labor. During the “Parts” warranty period, there will be no charge for parts. This Limited Warranty excludes both parts and labor for non-rechargeable batteries, antennas, and cosmetic parts (cabinet). This warranty only applies to products purchased and serviced in the United States or Puerto Rico. This warranty is extended only to the original purchaser of a new product which was not sold “as is”.

Mail-In Service

For assistance in the U.S.A. and Puerto Rico in obtaining repairs, please ship the product prepaid to:

Panasonic Exchange Center
4900 George McVay Drive
Suite B
McAllen, TX 78503
panacare@us.panasonic.com

Online Repair Request

To submit a new repair request and for quick repair status visit our Web Site at www.panasonic.com/repair.

When shipping the unit, carefully pack, include all supplied accessories listed in the Owner's Manual, and send it prepaid, adequately insured and packed well in a carton box. When shipping Lithium Ion batteries please visit our Web Site at www.panasonic.com/BatteryHandling as Panasonic is committed to providing the most up to date information. Include a letter detailing the complaint, a return address and provide a daytime phone number where you can be reached. A valid registered receipt is required under the Limited Warranty.

IF REPAIR IS NEEDED DURING THE WARRANTY PERIOD, THE PURCHASER WILL BE REQUIRED TO FURNISH A SALES RECEIPT/PROOF OF PURCHASE INDICATING DATE OF PURCHASE, AMOUNT PAID AND PLACE OF PURCHASE. CUSTOMER WILL BE CHARGED FOR THE REPAIR OF ANY UNIT RECEIVED WITHOUT SUCH PROOF OF PURCHASE.

Limited Warranty Limits And Exclusions

This warranty ONLY COVERS failures due to defects in materials or workmanship, and DOES NOT COVER normal wear and tear or cosmetic damage. The warranty ALSO DOES NOT COVER damages which occurred in shipment, or failures which are caused by products not supplied by the warrantor, or failures which result from accidents, misuse, abuse, neglect, mishandling, misapplication, alteration, faulty installation, set-up adjustments, misadjustment of consumer controls, improper maintenance, power line surge, lightning damage, modification, introduction of sand, humidity or liquids, commercial use such as hotel, office, restaurant, or other business or rental use of the product, or service by anyone other than a Factory Service Center or other Authorized Servicer, or damage that is attributable to acts of God.

THERE ARE NO EXPRESS WARRANTIES EXCEPT AS LISTED UNDER “LIMITED WARRANTY COVERAGE”.

THE WARRANTOR IS NOT LIABLE FOR INCIDENTAL OR CONSEQUENTIAL DAMAGES RESULTING FROM THE USE OF THIS PRODUCT, OR ARISING OUT OF ANY BREACH OF THIS WARRANTY.

(As examples, this excludes damages for lost time, travel to and from the servicer, loss of or damage to media or images, data or other memory or recorded content. The items listed are not exclusive, but for illustration only.)

ALL EXPRESS AND IMPLIED WARRANTIES, INCLUDING THE WARRANTY OF MERCHANTABILITY, ARE LIMITED TO THE PERIOD OF THE LIMITED WARRANTY.

Some states do not allow the exclusion or limitation of incidental or consequential damages, or limitations on how long an implied warranty lasts, so the exclusions may not apply to you.

This warranty gives you specific legal rights and you may also have other rights which vary from state to state. If a problem with this product develops during or after the warranty period, you may contact your dealer or Service Center. If the problem is not handled to your satisfaction, then write to the warrantor's Consumer Affairs Department at the addresses listed for the warrantor.

PARTS AND SERVICE, WHICH ARE NOT COVERED BY THIS LIMITED WARRANTY, ARE YOUR RESPONSIBILITY.

Customer Services Directory (United States and Puerto Rico)

Obtain Product Information and Operating Assistance; locate your nearest Dealer or Service Center; purchase Parts and Accessories; or make Customer Service and Literature requests by visiting our Web Site at:

<http://www.panasonic.com/help>

or, contact us via the web at:

<http://www.panasonic.com/contactinfo>

You may also contact us directly at:

1-800-211-PANA (7262)

Monday-Friday 9am-9pm, Saturday-Sunday 10am-7pm EST

For hearing or speech impaired TTY users, TTY: 1-877-833-8855

Accessory Purchases (United States and Puerto Rico)

Purchase Parts, Accessories and Instruction Books online for all Panasonic Products by visiting our Web Site at:

<http://www.pstc.panasonic.com>

Or, send your request by E-mail to:

npcparts@us.panasonic.com

You may also contact us directly at:

1-800-332-5368 (Phone) 1-800-237-9080 (Fax Only)

(Monday-Friday 9am-9pm EST)

Panasonic National Parts Center

20421 84th Ave S., Kent, WA 98032

(We accept Visa, Master Card, Discover Card and American Express.)

For hearing or speech impaired TTY users, TTY: 1-866-605-1277

As of October 2012

- SDXC Logo is a trademark of SD-3C, LLC.
- QuickTime and the QuickTime logo are trademarks or registered trademarks of Apple Inc., used under license therefrom.
- Mac and Mac OS are trademarks of Apple Inc., registered in the U.S. and other countries.
- Windows and Windows Vista are either registered trademarks or trademarks of Microsoft Corporation in the United States and/or other countries.
- This product uses "DynaFont" from DynaComware Corporation. DynaFont is a registered trademark of DynaComware Taiwan Inc.
- Other names of systems and products mentioned in these instructions are usually the registered trademarks or trademarks of the manufacturers who developed the system or product concerned.



This product is licensed under the AVC patent portfolio license for the personal and non-commercial use of a consumer to (i) encode video in compliance with the AVC Standard ("AVC Video") and/or (ii) decode AVC Video that was encoded by a consumer engaged in a personal and non-commercial activity and/or was obtained from a video provider licensed to provide AVC Video. No license is granted or shall be implied for any other use. Additional information may be obtained from MPEG LA, LLC. See <http://www.mpegla.com> .

Panasonic Consumer Marketing Company of North America,
Division of Panasonic Corporation of North America

One Panasonic Way, Secaucus, NJ 07094

© Panasonic Corporation 2013

Printed in China