

# Panasonic®

## Basic Owner's Manual Digital Camera

Model No. **DMC-SZ5**

# LUMIX

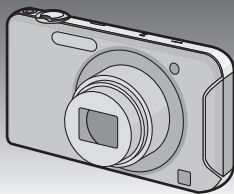

Before connecting, operating or adjusting this product,  
please read the instructions completely.



More detailed instructions on the operation of this camera are contained in "Owner's Manual for advanced features (PDF format)" in the supplied CD-ROM. Install it on your PC to read it.



For Canadian assistance, please call: 1-800-99-LUMIX (1-800-995-8649) or  
send e-mail to: [lumixconciierge@ca.panasonic.com](mailto:lumixconciierge@ca.panasonic.com)

PC

VQT4J94  
F0712MR0

**Dear Customer,**

**Thank you for choosing Panasonic!**

You have purchased one of the most sophisticated and reliable products on the market today. Used properly, we're sure it will bring you and your family years of enjoyment. Please take time to fill in the information on the below. The serial number is on the tag located on the underside of your camera. Be sure to **retain this manual** as your convenient camera information source.

Date of Purchase	Dealer Phone No.
Dealer Purchased From	Model No.
Dealer Address	Serial No.

Please note that the actual controls and components, menu items, etc. of your Digital Camera may look somewhat different from those shown in the illustrations in this Owner's Manual.

**Carefully observe copyright laws.**

- Recording of pre-recorded tapes or discs or other published or broadcast material for purposes other than your own private use may infringe copyright laws. Even for the purpose of private use, recording of certain material may be restricted.



A lithium ion battery that is recyclable powers the product you have purchased. Please call 1-800-8-BATTERY for information on how to recycle this battery.

**-If you see this symbol-**

**Information on Disposal in other Countries outside the European Union**

This symbol is only valid in the European Union. If you wish to discard this product, please contact your local authorities or dealer and ask for the correct method of disposal.



# Information for Your Safety

## WARNING:

To reduce the risk of fire, electric shock or product damage,

- Do not expose this unit to rain, moisture, dripping or splashing.
- Use only the recommended accessories.
- Do not remove covers.
- Do not repair this unit by yourself. Refer servicing to qualified service personnel.

The socket outlet shall be installed near the equipment and shall be easily accessible.

## ■ Product identification marking

Product	Location
Digital Camera	Bottom

This Class B digital apparatus complies with Canadian ICES-003.

This device complies with RSS-210 of the IC Rules.

Operation is subject to the following two conditions:

- (1) This device may not cause harmful interference,
- (2) This device must accept any interference received, including interference that may cause undesired operation of the device.

This equipment complies with IC radiation exposure limits set forth for an uncontrolled environment and meets RSS-102 of the IC radio frequency (RF) Exposure rules.

This equipment has very low levels of RF energy that are deemed to comply without testing of specific absorption ratio (SAR).

## ■ About the battery pack

### CAUTION

Battery pack (Lithium ion battery pack)

- Use the specified unit to recharge the battery pack.
- Do not use the battery pack with equipment other than the specified unit.
- Do not get dirt, sand, liquids, or other foreign matter on the terminals.
- Do not touch the plug terminals (+ and -) with metal objects.
- Do not disassemble, remodel, heat or throw into fire.

If any electrolyte should come into contact with your hands or clothes, wash it off thoroughly with water.

If any electrolyte should come into contact with your eyes, never rub the eyes. Rinse eyes thoroughly with water, and then consult a doctor.

### CAUTION

- Danger of explosion if battery is incorrectly replaced. Replace only with the type recommended by the manufacturer.
- When disposing the batteries, please contact your local authorities or dealer and ask for the correct method of disposal.

- Do not heat or expose to flame.
- Do not leave the battery(ies) in a car exposed to direct sunlight for a long period of time with doors and windows closed.

### Warning

Risk of fire, explosion and burns. Do not disassemble, heat above 60 °C (140 °F) or incinerate.

## ■ About the AC adaptor (supplied)

### CAUTION!

To reduce the risk of fire, electric shock or product damage,

- Do not install or place this unit in a bookcase, built-in cabinet or in another confined space. Ensure this unit is well ventilated.

### AC adaptor

This AC adaptor operates on AC between 110 V and 240 V.

But

- In the U.S.A. and Canada, the AC adaptor must be connected to a 120 V AC power supply only.
- When connecting to an AC supply outside of the U.S.A. or Canada, use a plug adaptor to suit the AC outlet configuration.

## ■ Cautions for Use

- Do not use any other USB connection cables except the supplied one or a genuine Panasonic USB connection cable (DMW-USBC1: optional).
- Always use a genuine Panasonic AV cable (DMW-AVC1: optional).

**Keep this unit as far away as possible from electromagnetic equipment (such as microwave ovens, TVs, video games etc.).**

- If you use this unit on top of or near a TV, the pictures and/or sound on this unit may be disrupted by electromagnetic wave radiation.
- Do not use this unit near cell phones because doing so may result in noise adversely affecting the pictures and/or sound.
- Recorded data may be damaged, or pictures may be distorted, by strong magnetic fields created by speakers or large motors.
- Electromagnetic wave radiation generated by microprocessors may adversely affect this unit, disturbing the pictures and/or sound.
- If this unit is adversely affected by electromagnetic equipment and stops functioning properly, turn this unit off and remove the battery or disconnect AC adaptor (supplied)/AC adaptor (DMW-AC5PP: optional). Then reinsert the battery or reconnect AC adaptor and turn this unit on.

**Do not use this unit near radio transmitters or high-voltage lines.**

- If you record near radio transmitters or high-voltage lines, the recorded pictures and/or sound may be adversely affected.

# Contents

Information for Your Safety .....	3
Before Use .....	6
Standard Accessories.....	7
Names and Functions of Main Parts .....	8
Inserting and Removing the Card (optional)/the Battery .....	9
Charging the Battery.....	10
Sequence of operations .....	11
Smartphone operations.....	13
Reading the Owner's Manual (PDF format) .....	15
Installing supplied software .....	16
Message Display .....	17
Troubleshooting .....	19
Specifications .....	22
Digital Camera Accessory System .....	25
Limited Warranty .....	26

## Before Use

### ■ Care of the camera

- Do not subject to strong vibration, shock, or pressure.
- This camera is not dust/splash/water proof.  
Avoid using the camera in places with a lot of dust, water, sand, etc.

### ■ About Condensation (When the lens is fogged up)

- Condensation occurs when the ambient temperature or humidity changes. Be careful of condensation since it causes lens stains, fungus and camera malfunction.
- If condensation occurs, turn the camera off and leave it for about 2 hours. The fog will disappear naturally when the temperature of the camera becomes close to the ambient temperature.

# Standard Accessories

Check that all the accessories are supplied before using the camera.  
Product numbers correct as of July 2012. These may be subject to change.

- 1 Battery Pack  
(Indicated as **battery pack** or **battery** in the text)

Charge the battery before use.

- 2 AC Adaptor

Can be used for charging and playback.

- 3 USB Connection Cable

- 4 CD-ROM

- Software
  - Owner's Manual for advanced features
- Install on your PC before use.

- 5 Hand Strap

- SD Memory Card, SDHC Memory Card and SDXC Memory Card are indicated as **card** in the text.

- **The card is optional.**

**You can record or play back pictures on the built-in memory when you are not using a card.**

- For information about optional accessories, refer to the "Digital Camera Accessory System".
- If any accessories are lost, customers in Canada should contact 1-800-99-LUMIX (1-800-995-8649) for further information about obtaining replacement parts.

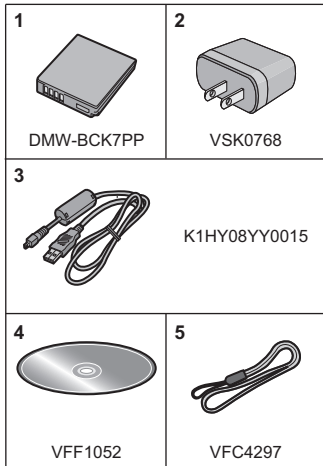

# Names and Functions of Main Parts

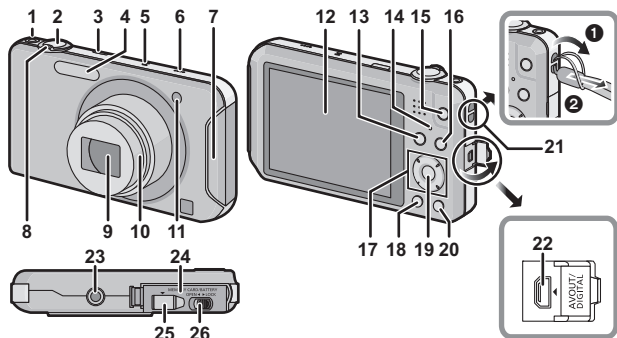

- |  |  |   |   |
|--|--|---|---|
| 1  | Motion picture button                  | 19  | [MENU/SET] button   |
| 2  | Shutter button                         | 20  | [Q.MENU]/[ <del>⏏</del> / <del>↵</del> ] (Delete/Cancel) button |
| 3  | Power button                           | 21  | Strap eyelet  |
| 4  | Flash                                  | <ul style="list-style-type: none"> <li>• Be sure to attach the strap when using the camera to ensure that you will not drop it.</li> </ul>  |   |
| 5  | Microphone                             | 22  | [AV OUT/DIGITAL] socket   |
| 6  | Speaker                                | <ul style="list-style-type: none"> <li>• This socket is also used when charging the battery.</li> </ul>   |   |
| <ul style="list-style-type: none"> <li>• Be careful not to cover the speaker with your finger. Doing so may make sound difficult to hear.</li> </ul> |  | 23  | Tripod mount  |
| 7  | Wi-Fi® Transmitter                     | <ul style="list-style-type: none"> <li>• A tripod with a screw length of 5.5 mm (0.22 inch) or more may damage this unit if attached.</li> </ul>  |   |
| 8  | Zoom lever                             | 24  | Card/Battery door   |
| 9  | Lens                                   | 25  | DC coupler cover  |
| 10   | Lens barrel                            | <ul style="list-style-type: none"> <li>• When using an AC adaptor (DMW-AC5PP: optional), ensure that the Panasonic DC coupler (DMW-DCC10: optional) and AC adaptor are used.</li> </ul> |   |
| 11   | Self-timer indicator<br>AF Assist Lamp | <ul style="list-style-type: none"> <li>• Always use a genuine Panasonic AC adaptor (DMW-AC5PP: optional).</li> </ul>  |   |
| 12   | LCD monitor                            | 26  | Release lever   |
| 13   | [MODE] button                          |   |   |
| 14   | Charging lamp<br>Wi-Fi connection lamp |   |   |
| 15   | [Wi-Fi] button                         |   |   |
| 16   | [▶] (Playback) button                  |   |   |
| 17   | Cursor buttons                         |   |   |
| 18   | [DISP.] button                         |   |   |



# Inserting and Removing the Card (optional)/the Battery

- Check that this unit is turned off.
- We recommend using a Panasonic card.

**1** Slide the release lever in the direction of the arrow and open the card/battery door.

- Always use genuine Panasonic batteries (DMW-BCK7PP).
- If you use other batteries, we cannot guarantee the quality of this product.

**2** **Battery:** Being careful about the battery orientation, insert all the way until you hear a locking sound and then check that it is locked by lever (A). Pull the lever (A) in the direction of the arrow to remove the battery.

**Card:** Push it securely all the way until you hear a “click” while being careful about the direction in which you insert it.

To remove the card, push the card until it clicks, then pull the card out upright.

(B): Do not touch the connection terminals of the card.

**3** **1:** Close the card/battery door.

**2:** Slide the release lever in the direction of the arrow.

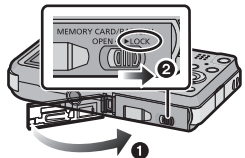
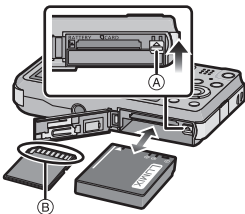
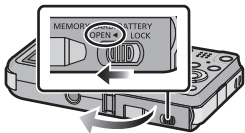

## Note

- Keep the Memory Card out of reach of children to prevent swallowing.

# Charging the Battery

- The battery that can be used with this unit is DMW-BCK7PP.
- The battery is not charged when the camera is shipped. Charge the battery before use.
- Charge the battery with the AC adaptor (supplied) indoors [10 °C to 30 °C (50 °F to 86 °F)].

- Check that this unit is turned off.

Insert the battery to this unit, and then connect this unit to the AC adaptor (A) (supplied) or a PC (B).

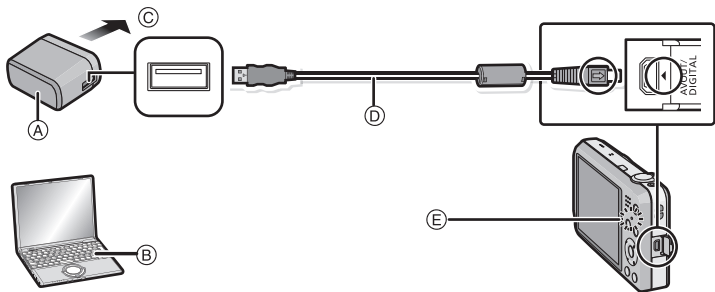

- © To power outlet
- © USB connection cable (supplied)

## ■ About the charging lamp (E)

**Lit red:** Charging.

**Off:** Charging has completed. (Charging time: Approx. 180 min)

When using the AC adaptor (supplied), observe the following points as improper connections may cause malfunctions.

- Do not use any other USB connection cables except the supplied one or a genuine Panasonic USB connection cable (DMW-USBC1: optional).
- Do not use any other AC adaptors except the supplied one.
- Do not use the AC adaptor (supplied) or the USB connection cable (supplied/optional) with other devices.

# Sequence of operations

- 1 Press power button.**
  - The clock is not set when the camera is shipped. Set the date and time before using the camera.
- 2 Press the shutter button halfway to focus and then press it fully to take the picture.**

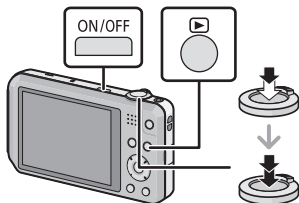

## ■ Selecting the Recording Mode

Press [MODE] to select the Recording Mode.

**fA**: Take pictures with automatic settings.

**O**: Take pictures with your own settings.

**MINI**: Take pictures to make them look like a diorama. (also known as Tilt Shift Focus)

**SCN**: Take pictures according to scene.

: This mode allows you to improve the appearance of the persons concerned and make their skin tones look healthier.

: Take a portrait emphasizing the skin softness.

: This allows you to take pictures of a wide landscape.

: You can take panorama pictures.

: You can take pictures of a fast-moving subject.

: This allows you to take pictures of a person and the background with near real-life brightness.

: This allows you to take vivid pictures of the nightscape.

: This mode allows you to take pictures of food with a natural hue without being affected by the ambient light.

: These take pictures of a baby with a healthy complexion. When you use the flash, the light from it is weaker than usual.

: You can set your pet's birthday and name.

: This allows you to take vivid pictures of the red color of the sun.

: This mode minimizes the jitter of the subjects, and enables you to take pictures of these subjects in dimly lit rooms.

: This mode is best suited for taking pictures through clear glass.

: Record the image with a frame around it.

## ■ Recording Motion Pictures

Start recording by pressing the motion picture button.

- Stop the recording by pressing the motion picture button again.
  - Maximum time to record motion pictures continuously is 29 minutes 59 seconds. The maximum available recording time continuously is displayed on the screen.
- 

## ■ Setting the Menu

Press [MENU/SET] to display the menu screen to change the recording function, camera settings, and other settings.

---

## ■ Playing Back Pictures ([Normal Play])

Press [▶].

- Press ◀ or ▶ to select the picture.
- 

## ■ Deleting Pictures

Select the picture, and then press [🗑️/↶].

- Confirmation screen is displayed. Picture is deleted by selecting [Yes].

# Smartphone operations

You can operate the camera from a smartphone by connecting these two devices via Wi-Fi.

- The connection requires the smartphone application “LUMIX LINK”.
- Refer to the “Wi-Fi connection guide” for the installation of “LUMIX LINK” and the connection with a smartphone.

## 1 Press and hold [Wi-Fi].

- The screen that notifies that the camera is waiting to get connected with a smartphone is displayed.

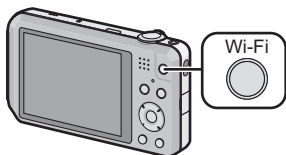

## 2 Start up “LUMIX LINK” on your smartphone.

- When the connection is complete, images stored in this unit is displayed on the smartphone screen.



## ■ Operations you can perform on a smartphone

- Read the [Help] in the "LUMIX LINK" menu for further details on how to operate.

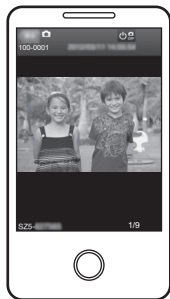

\* The screen differs depending on the operating system.

Feature	Description of functions
<b>Wireless shooting</b>	You can record images with this camera through controls on your smartphone. <ul style="list-style-type: none"><li>• Recorded images are saved in the camera.</li></ul>
<b>Playing back images on a smartphone screen</b>	You can play back images in the camera on a smartphone screen.
<b>Saving images on a smartphone</b>	You can save images in the camera to a smartphone.
<b>Uploading photos on SNS (Social Networking Service)</b>	You can upload images in the camera or a smartphone to SNS.
<b>Setting the menu items</b>	You can set the camera's menu items on a smartphone.
<b>Recording location information</b>	Using the location information function of a smartphone, you can record location information onto the images taken by the camera.

# Reading the Owner's Manual (PDF format)

More detailed instructions on the operation of this camera are contained in "Owner's Manual for advanced features (PDF format)" in the supplied CD-ROM. Install it on your PC to read it.

## ■ For Windows

- 1 Turn the PC on and insert the CD-ROM containing the Owner's Manual (supplied).
- 2 Click the [Owner's Manual].
- 3 Select the desired language and then click [Owner's Manual] to install.  
(A) To return to the install menu.
- 4 Double-click the "Owner's Manual" shortcut icon on the desktop.

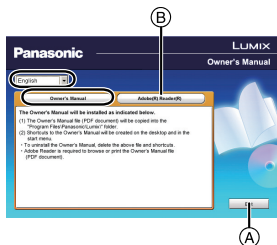

## ■ When the Owner's Manual (PDF format) will not open

You will need Adobe Acrobat Reader 5.0 or later, or Adobe Reader 7.0 or later to browse or print the Owner's Manual (PDF format).

Insert the CD-ROM containing the Owner's Manual (supplied), click (B) and then follow the messages on the screen to install.

(Compatible OS: Windows XP SP3/Windows Vista SP2/Windows 7)

- You can download and install a version of Adobe Reader that you can use with your OS from the following website.

<http://get.adobe.com/reader/otherversions/>

# Installing supplied software

- The supplied CD-ROM includes the following software.
  - PHOTOfunSTUDIO 8.4 SE (Windows XP/Vista/7)
  - LoLoScope 30-day full trial version (Windows XP/Vista/7)  
(This will only install a shortcut to the trial version download site.)
- Before inserting the CD-ROM, close all running applications.

## 1 Check the environment of your PC.

### • Operating environment of “PHOTOfunSTUDIO 8.4 SE”

- OS:
    - Windows® XP (32bit) SP3,
    - Windows Vista® (32bit) SP2,
    - Windows® 7 (32bit/64bit) and SP1
  - CPU:
    - Pentium® III 500 MHz or higher (Windows® XP),
    - Pentium® III 800 MHz or higher (Windows Vista®),
    - Pentium® III 1 GHz or higher (Windows® 7)
  - Display:
    - 1024×768 pixels or more (1920×1080 pixels or more recommended)
  - RAM:
    - 512 MB or more (Windows® XP/Windows Vista®),
    - 1 GB or more (Windows® 7 32bit),
    - 2 GB or more (Windows® 7 64bit)
  - Free hard disk space:
    - 450 MB or more for installing software
- Refer to the operating instructions of “PHOTOfunSTUDIO” (PDF) for further operating environment.

## 2 Insert the CD-ROM with the supplied software.

- When you insert the supplied CD-ROM, the install menu will start.

## 3 Click on the [Applications] on the install menu.

## 4 Click on the [Recommended Installation].

- Proceed with installation according to messages appearing on the screen.

### Note

- The software compatible with your PC will be installed.
- “PHOTOfunSTUDIO” is not compatible with Mac.



# Message Display

Confirmation messages or error messages will be displayed on the screen in some cases.

The major messages are described below as examples.

## **[Some pictures cannot be deleted]/[This picture cannot be deleted]**

- Pictures not based on the DCF standard cannot be deleted.  
→ Format the card after saving necessary data on a PC etc.

## **[Built-in memory full]/[Memory card full]/[Not enough space on built-in memory]/[Not enough memory on the card]**

- There is no space left on the built-in memory or the card.
- When you copy pictures from the built-in memory to the card (batch copy), the pictures are copied until the capacity of the card becomes full.

## **[Memory card error.**

**This card cannot be used in this camera.**

### **Format this card?]**

- It is a format that cannot be used with this unit.  
→ Insert a different card and try again.  
→ Reformat on this unit after saving necessary data using a PC, etc. Data will be deleted.

## **[Please turn camera off and then on again]/[System Error]**

- This message appears when the camera is not operating properly.  
→ Turn the camera off and on. If the message persists, contact the dealer or Panasonic.

## **[Insert SD card again]/[Try another card]**

- An error has occurred accessing the card.  
→ Insert the card again.  
→ Insert a different card.

## **[This battery cannot be used]**

- Use a genuine Panasonic battery. If this message is displayed even when a genuine Panasonic battery is used, contact the dealer or Panasonic.
- If the battery terminal is dirty, clean it and remove any objects.

## **[Failed to connect wireless access point]/[Connection failed]/[No destination found]**

- Check following regarding the wireless access point.
  - The wireless access point information set on this camera is wrong. Check the authentication type, encryption type, and encryption key.
  - Power of the wireless access point is not turned on.
  - Setting of the wireless access point is not supported by this unit.
- Check the network setting of the destination.
- Radio waves from other devices may block the connection to a wireless access point. Check other devices that are connected to the wireless access point and devices that use the 2.4 GHz band.

# Troubleshooting

First, try out the following procedures.

- Check “Troubleshooting” in the “Owner’s Manual for advanced features (PDF format)”.

If the problem is not resolved, **it may be improved by selecting [Reset] on the [Setup] menu.**

## Battery and power source

**The camera cannot be operated even when it is turned on.  
The camera turns off immediately after it is turned on.**

- The battery is exhausted. Charge the battery.
- If you leave the camera on, the battery will be exhausted.
  - Turn the camera off frequently by using the [Auto Power Off].

**Card/battery door does not close.**

- Insert the battery securely all the way in.

## Recording

**The picture cannot be recorded.**

- Is there any memory remaining on the built-in memory or the card?
  - Delete the pictures which are not necessary to increase available space in the memory.
- You may not be able to record for a short while after turning this unit on when using a large capacity card.

### **The subject is not focused properly.**

- The focus range varies depending on the Recording Mode.
  - Set to the proper mode for the distance to the subject.
- The subject is beyond the focus range of the camera.
- There is camera shake (jitter) or the subject is moving slightly.

### **The recorded picture is blurred. The Optical Image Stabilizer is not effective.**

- The shutter speed becomes slower when pictures are taken in dark places so hold the camera firmly with both hands to take the pictures.
- When taking pictures at a slow shutter speed, use the Self-timer.

### **The brightness or the hue of the recorded picture is different from the actual scene.**

- When recording under fluorescent or LED lighting fixture etc., increasing the shutter speed may introduce slight changes to brightness and color. These are a result of the characteristics of the light source and do not indicate a malfunction.

### **Motion picture recording stops in the middle.**

- Use a card with SD Speed Class with "Class 4" or higher when recording motion pictures.
- Depending on the type of the card, recording may stop in the middle.
  - If motion picture recording stops during use of a card of at least "Class 4" or if you use a card that has been formatted on a PC or other equipment, the data-writing speed is lower. In such cases, we recommend that you make a backup of the data and then format the card in this unit.

## **LCD monitor**

### **The LCD monitor becomes darker or brighter for a moment.**

- This phenomenon appears when you press the shutter button halfway to set the aperture value and does not affect the recorded pictures.
- This phenomenon also appears when the brightness changes when the camera is zoomed or when the camera is moved. This is because of operation of the automatic aperture of the camera, and it is not a malfunction.

### **Black, red, blue and green dots appear on the LCD monitor.**

- This is not a malfunction.  
These pixels do not affect the recorded pictures.

## Playback

### **The picture is not played back. The recorded pictures are not displayed.**

- Is there a picture on the built-in memory or the card?
  - The pictures on the built-in memory appear when a card is not inserted. The picture data on the card appears when a card is inserted.
- Is this a folder or picture which was processed in the PC? If it is, it cannot be played back by this unit.
  - It is recommended to use the "PHOTOfunSTUDIO" software in the CD-ROM (supplied) to write pictures from PC to card.
- Has [Filtering Play] been set for playback?
  - Change to [Normal Play].

## About the Wi-Fi function

### **It cannot connect to the wireless LAN. Radio waves get disconnected.**

- Use within the communication range of the wireless LAN network.
- Connection types and security setting methods are different depending on the wireless access point.
  - Refer to the operating instructions of the wireless access point.
- When the radio waves are interrupted, the condition may improve by moving the location or changing the angle of the wireless access point.
- It may not automatically connect when the network SSID of the wireless access point is set not to broadcast.
  - Set the network SSID of the wireless access point to broadcast.
- Is any device, such as microwave oven, cordless phone, etc., that uses 2.4 GHz frequency operated nearby?
  - Radio waves may get interrupted when used simultaneously. Use them sufficiently away from the device.
- Is the 5 GHz/2.4 GHz switchable wireless access point connected to other equipment using the 5 GHz band?
  - The use of a wireless access point that can use 5 GHz/2.4 GHz simultaneously is recommended. It cannot be used simultaneously with this camera if it is not compatible.

## Others

### **The clock is reset.**

- If you do not use the camera for a long time, the clock may be reset.
  - [Please set the clock] message will be displayed; please reset the clock.

# Specifications

Specifications are subject to change without notice.

## Digital Camera:

Information for your safety

<b>Power Source:</b>	DC 5.1 V
<b>Power Consumption:</b>	1.1 W (When recording) 0.6 W (When playing back)

<b>Camera effective pixels</b>	14,100,000 pixels	
<b>Image sensor</b>	1/2.33" CCD, total pixel number 14,500,000 pixels, Primary color filter	
<b>Lens</b>	Optical 10× zoom, f=4.5 mm to 45 mm (35 mm film camera equivalent: 25 mm to 250 mm)/F3.1 (Wide) to F5.9 (Tele)	
<b>Image stabilizer</b>	Optical method	
<b>Focus range</b>	Normal	50 cm (1.6 feet) (Wide)/1.5 m (4.9 feet) (Tele) to ∞ [9× is 2 m (6.6 feet) to ∞]
	Macro/ Intelligent auto/ Motion picture	5 cm (0.16 feet) (Wide)/1.5 m (4.9 feet) (Tele) to ∞ [9× is 2 m (6.6 feet) to ∞]
	Scene Mode	There may be differences in the above settings.
<b>Shutter system</b>	Electronic shutter+Mechanical shutter	
<b>Minimum Illumination</b>	Approx. 10 lx (when i-low light is used, the shutter speed is 1/30th of a second)	
<b>Shutter speed</b>	8 seconds to 1/1600th of a second	
<b>Exposure (AE)</b>	Auto (Program AE)	
<b>Metering mode</b>	Multiple	
<b>LCD monitor</b>	3.0" TFT LCD (4:3) (Approx. 230,000 dots) (field of view ratio about 100%)	
<b>Microphone</b>	Monaural	
<b>Speaker</b>	Monaural	

<b>Recording media</b>	Built-in Memory (Approx. 55 MB)/SD Memory Card/ SDHC Memory Card/SDXC Memory Card
<b>Recording file format</b>	
<b>Still Picture</b>	JPEG (based on "Design rule for Camera File system", based on "Exif 2.3" standard)/DPOF corresponding
<b>Motion pictures</b>	MP4
<b>Audio compression format</b>	AAC
<b>Interface</b>	
<b>Digital</b>	"USB 2.0" (High Speed)
<b>Analog video</b>	NTSC
<b>Audio</b>	Audio line output (monaural)
<b>Terminal</b>	
<b>[AV OUT/DIGITAL]</b>	Dedicated jack (8 pin)
<b>Dimensions</b> (excluding the projecting parts)	Approx. 104.1 mm (W)×57.6 mm (H)×20.8 mm (D) [4.1"(W)×2.3"(H)×0.8"(D)]
<b>Mass (weight)</b>	Approx. 136 g/0.3 lb (with card and battery) Approx. 120 g/0.27 lb (excluding card and battery)
<b>Operating temperature</b>	0 °C to 40 °C (32 °F to 104 °F)
<b>Operating humidity</b>	10%RH to 80%RH

## Wireless transmitter

<b>Compliance standard</b>	IEEE 802.11b/g/n (standard wireless LAN protocol)
<b>Frequency range used (central frequency)</b>	2412 MHz to 2462 MHz (11ch)
<b>Encryption method</b>	Wi-Fi compliant WPA™/WPA2™
<b>Access method</b>	Infrastructure mode

## AC Adaptor (Panasonic VSK0768):

Information for your safety

<b>Input:</b>	~ 110 V to 240 V, 50/60 Hz, 0.2 A
<b>Output:</b>	=== 5 V, 800 mA

## Battery Pack (lithium-ion) (Panasonic DMW-BCK7PP):

Information for your safety

<b>Voltage/capacity:</b>	3.6 V/680 mAh
--------------------------	---------------







This product incorporates the following software:

- (1) the software developed independently by or for Panasonic Corporation,
- (2) the software owned by third party and licensed to Panasonic Corporation and/or,
- (3) open sourced software including the software developed by the OpenSSL Project for use in the OpenSSL Toolkit (<http://www.openssl.org/>), and the software written by Eric Young ([eay@cryptsoft.com](mailto:eay@cryptsoft.com)).

For the software categorized as (3), please refer to the applicable license terms in the following "Owner's Manual for advanced features (PDF format)".



# Digital Camera Accessory System

Accessory#	Illustration	Description
DMW-BCK7		Battery Pack
DMW-AC5		AC Adaptor *
DMW-DCC10		DC Coupler *
DMW-USBC1		USB Connection Cable
DMW-AVC1		AV Cable
RP-SDUA64GUK RP-SDUA32GUK RP-SDUA16GUK RP-SDUA08GUK RP-SDUA04GUK		Class 10 64 GB SDXC Memory Card Class 10 32 GB SDHC Memory Card Class 10 16 GB SDHC Memory Card Class 10 8 GB SDHC Memory Card Class 10 4 GB SDHC Memory Card
RP-SDQA32GUK RP-SDQA16GUK RP-SDQA08GUK RP-SDQA04GUK		Class 6 32 GB SDHC Memory Card Class 6 16 GB SDHC Memory Card Class 6 8 GB SDHC Memory Card Class 6 4 GB SDHC Memory Card
RP-SDLA32GUK RP-SDLA16GUK RP-SDLA08GUK RP-SDLA04GUK RP-SDLA02GUK		Class 4 32 GB SDHC Memory Card Class 4 16 GB SDHC Memory Card Class 4 8 GB SDHC Memory Card Class 4 4 GB SDHC Memory Card Class 4 2 GB SD Memory Card

Product numbers correct as of July 2012. These may be subject to change.

- \* The AC Adaptor (optional) can only be used with the designated Panasonic DC Coupler (optional). The AC adaptor (optional) cannot be used by itself.
- NOTE: Accessories and/or model numbers may vary between countries. Consult your local dealer.

# Limited Warranty

## Panasonic Canada Inc.

5770 Ambler Drive, Mississauga, Ontario L4W 2T3

### PANASONIC PRODUCT – LIMITED WARRANTY

### EXCHANGE PROGRAM

Panasonic Canada Inc. warrants this product to be free from defects in material and workmanship under normal use and for a period as stated below from the date of original purchase agrees to, at its option either (a) repair your product with new or refurbished parts, (b) replace it with a new or a refurbished equivalent value product, or (c) refund your purchase price. The decision to repair, replace or refund will be made by Panasonic Canada Inc.

LUMIX DMC-SZ5	One (1) year
---------------	--------------

This warranty is given only to the original purchaser, or the person for whom it was purchased as a gift, of a Panasonic brand product mentioned above sold by an authorized Panasonic dealer in Canada and purchased and used in Canada, which product was not sold “as is”, and which product was delivered to you in new condition in the original packaging.

**IN ORDER TO BE ELIGIBLE TO RECEIVE WARRANTY SERVICE HEREUNDER, A PURCHASE RECEIPT OR OTHER PROOF OF DATE OF ORIGINAL PURCHASE, SHOWING AMOUNT PAID AND PLACE OF PURCHASE IS REQUIRED**

#### **LIMITATIONS AND EXCLUSIONS**

This warranty **ONLY COVERS** failures due to defects in materials or workmanship, and **DOES NOT COVER** normal wear and tear or cosmetic damage. The warranty **ALSO DOES NOT COVER** damages which occurred in shipment, or failures which are caused by products not supplied by Panasonic Canada Inc., or failures which result from accidents, misuse, abuse, neglect, mishandling, misapplication, alteration, faulty installation, set-up adjustments, misadjustment of consumer controls, improper maintenance, improper batteries, power line surge, lightning damage, modification, introduction of sand, humidity or liquids, commercial use such as hotel, office, restaurant, or other business or rental use of the product, or service by anyone other than a Authorized Servicer, or damage that is attributable to acts of God. Dry cell batteries are also excluded from coverage under this warranty.

Rechargeable batteries are warranted for ninety (90) days from date of original purchase.

THIS EXPRESS, LIMITED WARRANTY IS IN LIEU OF ALL OTHER WARRANTIES, EXPRESS OR IMPLIED, INCLUDING ANY IMPLIED WARRANTIES OF MERCHANTABILITY AND FITNESS FOR A PARTICULAR PURPOSE. IN NO EVENT WILL PANASONIC CANADA INC. BE LIABLE FOR ANY SPECIAL, INDIRECT OR CONSEQUENTIAL DAMAGES RESULTING FROM THE USE OF THIS PRODUCT OR ARISING OUT OF ANY BREACH OF ANY EXPRESS OR IMPLIED WARRANTY. (As examples, this warranty excludes damages for lost time, travel to and from the Authorized Servicer, loss of or damage to media or images, data or other memory or recorded content. This list of items is not exhaustive, but for illustration only.)

In certain instances, some jurisdictions do not allow the exclusion or limitation of incidental or consequential damages, or the exclusion of implied warranties, so the above limitations and exclusions may not be applicable. This warranty gives you specific legal rights and you may have other rights which vary depending on your province or territory.

### **CONTACT INFORMATION**

**For product operation and information assistance, please contact:**

Our Customer Care Centre: Telephone #: 1-800-99-LUMIX (1-800-995-8649)

Fax #: (905) 238-2360

Lumix Email link: [lumixconcierge@ca.panasonic.com](mailto:lumixconcierge@ca.panasonic.com)

For defective product exchange within the warranty period, please contact the original dealer or our Customer Care Centre.

- SDXC Logo is a trademark of SD-3C, LLC.
- QuickTime and the QuickTime logo are trademarks or registered trademarks of Apple Inc., used under license therefrom.
- Mac and Mac OS are trademarks of Apple Inc., registered in the U.S. and other countries.
- Windows and Windows Vista are either registered trademarks or trademarks of Microsoft Corporation in the United States and/or other countries.
- The Wi-Fi CERTIFIED Logo is a certification mark of the Wi-Fi Alliance.
- The Wi-Fi Protected Setup Mark is a mark of the Wi-Fi Alliance.
- "Wi-Fi", "Wi-Fi Protected Setup", "WPA" and "WPA2" are marks or registered marks of the Wi-Fi Alliance.
- DLNA, the DLNA Logo and DLNA CERTIFIED are trademarks, service marks, or certification marks of the Digital Living Network Alliance.
- This product uses "DynaFont" from DynaComware Corporation. DynaFont is a registered trademark of DynaComware Taiwan Inc.
- Other names of systems and products mentioned in these instructions are usually the registered trademarks or trademarks of the manufacturers who developed the system or product concerned.



This product is licensed under the AVC patent portfolio license for the personal and non-commercial use of a consumer to (i) encode video in compliance with the AVC Standard ("AVC Video") and/or (ii) decode AVC Video that was encoded by a consumer engaged in a personal and non-commercial activity and/or was obtained from a video provider licensed to provide AVC Video. No license is granted or shall be implied for any other use. Additional information may be obtained from MPEG LA, LLC.

See <http://www.mpegla.com>.

---

# Panasonic<sup>®</sup>

Panasonic Canada Inc.

5770 Ambler Drive  
Mississauga, Ontario  
L4W 2T3  
(905) 624-5010  
[www.panasonic.ca](http://www.panasonic.ca)

© Panasonic Corporation 2012

Printed in China