

Panasonic[®]

Owner's Manual for advanced features

Digital Camera

Model No. **DMC-LZ40**

LUMIX

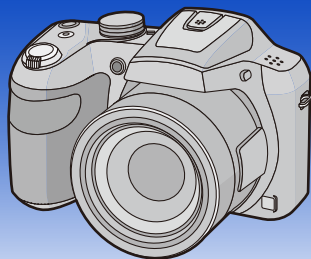

Please read these instructions carefully before using this product,
and save this manual for future use.



Register online at
www.panasonic.com/register
(U.S. customers only)

VQT5G13
F0114NK0

Contents

Before Use

Care of the camera	5
Standard Accessories	6
Names and Functions of Main Parts	7

Preparation

Attaching the Lens Cap/Shoulder Strap	9
• Attaching the Lens Cap	9
• Attaching the Shoulder Strap	10
Charging the Battery	11
• Inserting the Battery	12
• Charging	13
• Approximate operating time and number of recordable pictures	16
Inserting and Removing the Card (optional)	18
About the Built-in Memory/the Card	19
• Approximate number of recordable pictures and available recording time	21
Setting Date/Time (Clock Set)	22
• Changing the Clock Setting	23
Tips for taking good pictures	24
• Preventing jitter (camera shake)	24

Basic

Selecting the Recording Mode	25
Taking pictures using the automatic function (Intelligent Auto Mode)	26
• Changing the settings	29
Taking Pictures with Your Favorite Settings (Program AE Mode)	30
Focusing	31
Recording Motion Pictures	33
Playing Back	35
• Displaying Multiple Screens (Multi Playback)	36
• Using the Playback Zoom	36
Deleting Pictures	37
• To delete a single picture	37
• To delete multiple pictures (up to 50) or all the pictures	37
Setting the Menu	38
• Setting menu items	38
• Using the Quick Menu	40
About the Setup Menu	41

Recording

About the Monitor	47
Using the Zoom	48

• Optical Zoom	48
• Extended Optical Zoom (EZ)	49
• Intelligent Zoom	49
• Digital Zoom.....	49
Taking Pictures Using the Built-in Flash	50
• Switching to the appropriate flash setting	50
Taking Close-up Pictures ([AF Macro]/[Macro Zoom]).....	54
Taking Pictures with the Self-timer.....	55
Compensating the Exposure.....	56
Taking Pictures Using Auto Bracket	57
Taking Pictures by Specifying the Aperture/ Shutter Speed (Manual Exposure Mode)	58
Taking panorama pictures (Panorama Shot Mode).....	59
Taking pictures that match the scene being recorded (Scene Mode).....	62
• [Soft Skin]	63
• [Sports].....	63
• [Night Portrait].....	63
• [Night Scenery]	64
• [HDR]	64
• [Food].....	64
• [Baby1]/[Baby2]	65
• [Pet]	65
• [Sunset].....	65
• [High Sens.]	65
• [Starry Sky]	66
• [Glass Through].....	66
Taking pictures of Scenery (Scenery Mode).....	67
Taking pictures of People (Portrait Mode)	67
Taking Pictures with different image effects (Creative Control Mode).....	68
• [Expressive]	69
• [Retro]	69
• [Old Days]	69
• [High Key]	69
• [Low Key]	70
• [Sepia].....	70
• [Dynamic Monochrome].....	70
• [Impressive Art].....	70
• [High Dynamic]	71
• [Cross Process]	71
• [Toy Effect].....	71
• [Miniature Effect].....	72
• [Soft Focus].....	72
• [Star Filter]	73
• [One Point Color]	73
Using the [Rec] Menu.....	74
• [Picture Size].....	74

• [Quality].....	75
• [Sensitivity].....	76
• [White Balance].....	77
• [AF Mode].....	80
• [Metering Mode].....	82
• [i.Exposure].....	83
• [i.Zoom].....	83
• [Digital Zoom].....	83
• [Burst].....	84
• [AF Assist Lamp].....	85
• [Red-Eye Removal].....	86
• [Stabilizer].....	86
• [Date Stamp].....	87
Using the [Motion Picture] Menu	88
• [Rec Quality].....	88
• [Continuous AF].....	88

Playback/Editing

Various methods of playback.....	89
• [Slide Show].....	90
• [Category Selection].....	92
• [Calendar].....	93
Having Fun with Recorded Pictures ([Creative Retouch])	94
Using the [Playback] Menu.....	95
• [Creative Retouch].....	95
• [Resize].....	96
• [Cropping].....	97
• [Protect].....	98
• [Copy].....	99

Connecting to other equipment

Playing Back Pictures on a TV Screen.....	100
Saving still pictures and motion pictures on your PC.....	102
• Transferring images to a PC.....	103
Printing the Pictures	105
• Selecting a single picture and printing it.....	106
• Selecting multiple pictures and printing them.....	106
• Print Settings.....	107

Others

Screen Display.....	110
Message Display	112
Troubleshooting	114
Cautions for Use.....	123

Care of the camera

Do not subject to strong vibration, shock, or pressure.

- The lens, monitor, or external case may be damaged if used in the following conditions.

It may also malfunction or image may not be recorded if you:

- Drop or hit the camera.
- Press hard on the lens or the monitor.

- **When camera is not in use or when using the playback feature, ensure that the lens is in the stored position, with lens cap on.**

- **There are times when rattling sounds or vibrations will come from the camera, but these are due to the motion of the aperture, the zoom and the motor and do not indicate a defect.**

This camera is not dust/splash/water proof.

Avoid using the camera in places with a lot of dust, water, sand, etc.

- Liquid, sand and other foreign material may get into the space around the lens, buttons, etc. Be particularly careful since it may not just cause malfunctions, but it may also become irreparable.

- Places with a lot of sand or dust.
- Places where water can come into contact with this unit, such as when using it on a rainy day or at the beach.

■ About Condensation (When the lens is fogged up)

- Condensation occurs when the ambient temperature or humidity changes. Be careful of condensation since it causes lens stains, fungus and camera malfunction.
- If condensation occurs, turn the camera off and leave it for about 2 hours. The fog will disappear naturally when the temperature of the camera becomes close to the ambient temperature.

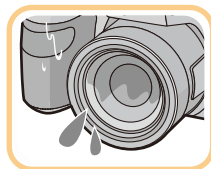
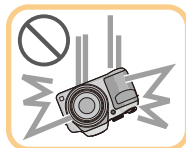

Standard Accessories

Check that all the accessories are supplied before using the camera.

- The accessories and their shape will differ depending on the country or area where the camera was purchased.
For details on the accessories, refer to “Basic Owner’s Manual”.
- Battery Pack is indicated as **battery pack** or **battery** in the text.
- SD Memory Card, SDHC Memory Card and SDXC Memory Card are indicated as **card** in the text.
- **The card is optional.**
You can record or play back pictures on the built-in memory when you are not using a card.

Names and Functions of Main Parts

- 1 Flash (P50)
- 2 [⚡OPEN] (Flash open) button (P50)
- 3 Self-timer indicator (P55)
AF Assist Lamp (P85)
- 4 Lens (P5, 124)

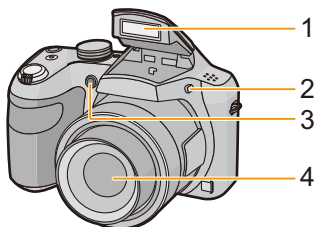

- 5 Monitor (P47, 110, 124)
- 6 Mode dial (P25)
- 7 [EXPOSURE] button (P58)
- 8 [▶] (Playback) button (P35)
- 9 [MENU/SET] button (P38)
- 10 Charging lamp (P13)
- 11 [Q.MENU] button (P40)
- 12 [🗑️/↵] (Delete/Cancel) button (P37)
[DISP.] button (P47)

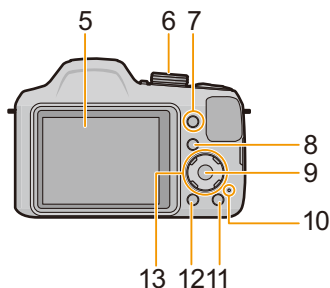

- 13 Cursor buttons
 - (A): ▲/[📷] (Exposure compensation) (P56)
(Auto Bracket) (P57)
 - (B): ▼/[🌿] (Macro Mode) (P54)
(AF Tracking) (P82)
 - (C): ◀/[🕒] (Self-timer) (P55)
 - (D): ▶/[⚡] (Flash setting) (P50)

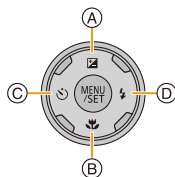

In this Owner's Manual, the cursor buttons are described as shown in the figure below or described with ▲/▼/◀/▶.

e.g.: When you press the ▼ (down) button



or **Press ▼**

14 Speaker

- Be careful not to cover the speaker with your finger. Doing so may make sound difficult to hear.

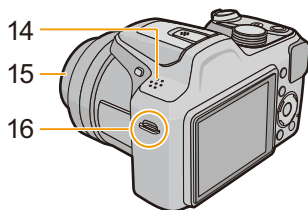
15 Lens barrel**16 Shoulder strap eyelet (P10)****17 Zoom lever (P48)****18 Shutter button (P27, 30)****19 Motion picture button (P33)****20 Camera [ON/OFF] button (P22)****21 Microphone**

- Be careful not to cover the microphone with your finger.

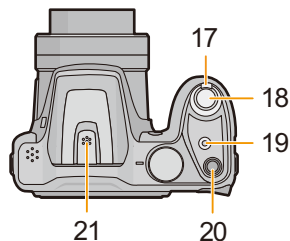
**22 Tripod mount**

- A tripod with a screw length of 5.5 mm (0.22 inch) or more may damage this unit if attached.

23 Card/Battery door (P12, 18)**24 Release lever (P12, 18)****25 [AV OUT/DIGITAL] socket (P13, 100, 103, 105)**

- This socket is also used when charging the battery.

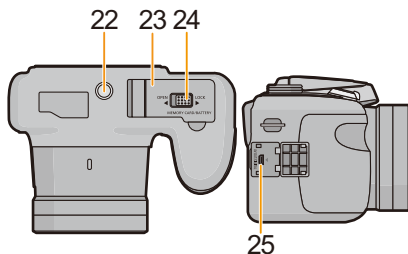

Attaching the Lens Cap/Shoulder Strap

Attaching the Lens Cap

- When you turn the camera off or carry the camera, attach the lens cap to protect the surface of the lens.

1 Pass the string through the hole at the shoulder strap eyelet.

Ⓐ: Shoulder strap eyelet

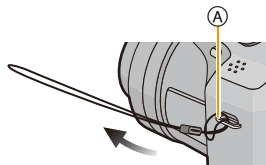

2 Pass the same string through the hole on the lens cap.

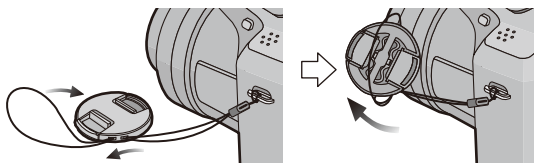

3 Attach the lens cap.

- Do not hang or swing around this unit.
- Make sure to detach the lens cap when turning this unit on.
- Be careful not to lose the lens cap.**
- Be careful that the lens cap string does not become entangled with the shoulder strap.

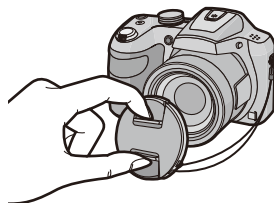

Attaching the Shoulder Strap

- We recommend attaching the shoulder strap when using the camera to prevent it from dropping.

1 Pass the shoulder strap through the hole at the shoulder strap eyelet.

- Attach the shoulder strap with the "LUMIX" logo facing out.

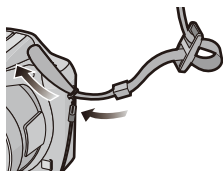

2 Pass the end of the shoulder strap through the ring in the direction of the arrow and then pass it through the stopper.

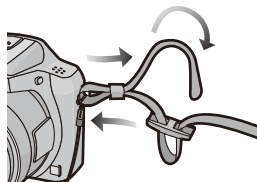

3 Pass the end of the shoulder strap through the hole on the other side of the stopper.

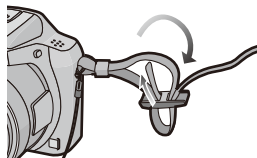

4 Pull the other side of the shoulder strap and then check that it will not come out.

- Perform steps **1** to **4** and then attach the other side of the shoulder strap.

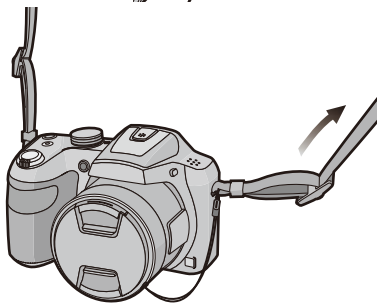

- Use the shoulder strap around your shoulder.
 - Do not wrap the strap around your neck.
 - It may result in injury or accident.
- Do not leave the shoulder strap where an infant can reach it.
 - It may result in an accident by mistakenly wrapping around the neck.

Charging the Battery

Use the dedicated AC adaptor (supplied), USB connection cable (supplied) and battery.

- The battery is not charged when the camera is shipped. Charge the battery before use.
- Charge the battery only when it is inserted in the camera.

Camera conditions	Charge
Turned off	○
Turned on	—

■ About batteries that you can use with this unit

It has been found that counterfeit battery packs which look very similar to the genuine product are made available for purchase in some markets. Some of these battery packs are not adequately protected with internal protection to meet the requirements of appropriate safety standards. There is a possibility that these battery packs may lead to fire or explosion. Please be advised that we are not liable for any accident or failure occurring as a result of use of a counterfeit battery pack. To ensure that safe products are used, we recommend that a genuine Panasonic battery pack is used.

■ About the power supply

If you use the AC adaptor (supplied) when the battery is in this unit, you can supply power from a power outlet via the USB connection cable (supplied).

- **The battery may be running out during recording.**
The camera will turn off if the battery power is gone.
- Before connecting or disconnecting the AC adaptor (supplied), turn the camera off.

Inserting the Battery

1 Slide the release lever in the direction of the arrow and open the card/battery door.

- Always use genuine Panasonic batteries.
- If you use other batteries, we cannot guarantee the quality of this product.

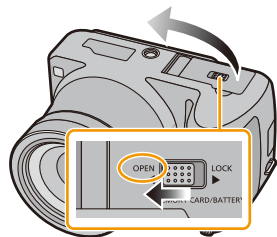

2 Being careful about the battery orientation, securely insert it all the way in, and then check that it is locked by the lever (A).

To remove the battery, move the lever (A) in the direction of the arrow.

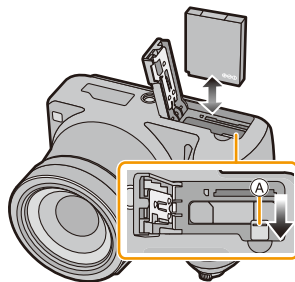

3 **1**: Close the card/battery door.

2: Slide the release lever in the direction of the arrow.

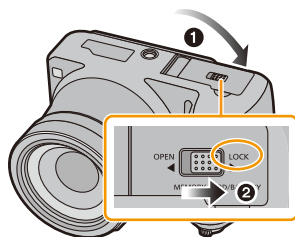

- Turn the camera off and wait for the “LUMIX” display on the monitor to clear before removing the battery.
(Otherwise, this unit may no longer operate normally and the card itself may be damaged or the recorded pictures may be lost.)

Charging

- Charge the battery in areas with an ambient temperature, between 10 °C and 30 °C (50 °F and 86 °F) (same as the battery temperature), is recommended.

**Insert the battery into this unit.
Check that this unit is turned off.**

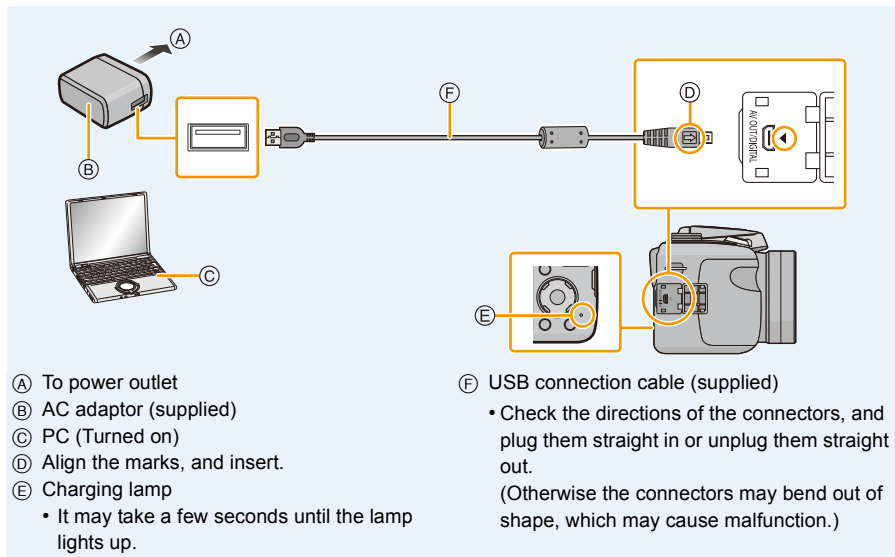

(Charging from the power outlet)

Connect the AC adaptor (supplied) and this camera with the USB connection cable (supplied), and insert the AC adaptor (supplied) into the power outlet.

(Charging from a computer)

Connect the computer and this camera with the USB connection cable (supplied).

- If the computer enters a suspended state while charging the battery, charging will stop.
- Connecting this camera to a notebook computer that is not connected to a power outlet will cause the notebook computer battery to drain faster. Do not leave the camera connected for extended periods of time.
- Be sure to always connect the camera to a computer USB terminal.
Do not connect the camera to a monitor, keyboard or printer USB terminal, or a USB hub.

■ About the charging lamp

On: Charging.

Off: Charging has completed.
(When charging is complete, disconnect the camera from the power outlet or computer.)

Blinking: Charging error.
(Refer to [P114](#) for details.)

■ Charging time

When using the AC adaptor (supplied)

Charging time	Approx. 210 min
<ul style="list-style-type: none"> • The indicated charging time is for when the battery has been discharged completely. The charging time may vary depending on how the battery has been used. The charging time for the battery in hot/cold environments or a battery that has not been used for a long time may be longer than normal. • When power is supplied from a computer, the power supply capacity of the computer determines the charging time. 	

- The indicated charging time is for when the battery has been discharged completely. The charging time may vary depending on how the battery has been used. The charging time for the battery in hot/cold environments or a battery that has not been used for a long time may be longer than normal.
- When power is supplied from a computer, the power supply capacity of the computer determines the charging time.

■ Battery indication

The battery indication is displayed on the monitor.

- The indication turns red and blinks if the remaining battery power is low. Recharge the battery or replace it with a fully charged battery.

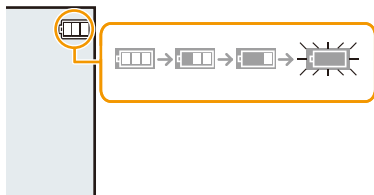

- **Do not leave any metal items (such as clips) near the contact areas of the power plug. Otherwise, a fire and/or electric shocks may be caused by short-circuiting or the resulting heat generated.**
- Do not use any other USB connection cables except the supplied one or a genuine Panasonic USB connection cable (DMW-USBC1: optional).
- Do not use any other AC adaptors except the supplied one.
- Do not use a USB extension cable.
- The AC adaptor (supplied) and USB connection cable (supplied) are for this camera only. Do not use them with other devices.
- Remove the battery after use.
(The battery will be exhausted if left for a long period of time after being charged.)
- The battery becomes warm after using and during and after charging. The camera also becomes warm during use. This is not a malfunction.
- The battery can be recharged even when it still has some power left, but it is not recommended that the battery charge be frequently topped up while the battery is fully charged.
(Since characteristic swelling may occur.)
- If a problem occurs in the power outlet, such as a power outage, charging may not be completed normally. If this happens, disconnect the USB connection cable (supplied) and connect it again.
- When the charging lamp does not light even if you connect the camera to the AC adaptor (supplied) or a PC, check if they are connected correctly.
- If you reconnect the USB connection cable (supplied) when the camera is fully charged, the charging lamp turns on for a while.

Approximate operating time and number of recordable pictures

Recording still pictures

Number of recordable pictures	Approx. 320 pictures	By CIPA standard in Program AE Mode
Recording time	Approx. 160 min	

Recording conditions by CIPA standard

- CIPA is an abbreviation of [Camera & Imaging Products Association].
- Temperature: 23 °C (73.4 °F)/Humidity: 50%RH when monitor is on.
- Using a Panasonic SD Memory Card.
- Using the supplied battery.
- Starting recording 30 seconds after the camera is turned on.
(When the Optical Image Stabilizer function is set to [ON].)
- **Recording once every 30 seconds** using full flash every second recording.
- Changing the zoom magnification from Tele to Wide or vice versa in every recording.
- Turning the camera off every 10 recordings and leaving it until the temperature of the battery decreases.

The number of recordable pictures varies depending on the recording interval time. As the recording interval time becomes longer, the number of recordable pictures decreases.

[For example, if you were to take one picture every two minutes, then the number of pictures would be reduced to approximately one-quarter of the number of pictures given above (based upon one picture taken every 30 seconds).]

Recording motion pictures

When [Rec Quality] is set to [HD]

Recordable time	Approx. 130 min
Actual recordable time	Approx. 65 min

- These times are for an ambient temperature of 23 °C (73.4 °F) and a humidity of 50%RH. Please be aware that these times are approximate.
- Actual recordable time is the time available for recording when repeating actions such as turning this unit on and off, starting/stopping recording, zoom operation, etc.
- Motion pictures can be recorded continuously up to 2 GB.
The maximum available recording time for up to 2 GB only is displayed on the screen.

■ Playback**Playback time****Approx. 350 min****• The operating times and number of recordable pictures will differ according to the environment and the operating conditions.**

For example, in the following cases, the operating times will shorten and the number of recordable pictures is reduced:

- In low-temperature environments, such as on ski slopes.
 - When using [Monitor Luminance].
 - When operations such as flash and zoom are used repeatedly.
- When the operating time of the camera becomes extremely short even after properly charging the battery, the life of the battery may have expired. Buy a new battery.

Inserting and Removing the Card (optional)

- Check that this unit is turned off.
- We recommend using a Panasonic card.

1 Slide the release lever in the direction of the arrow and open the card/battery door.

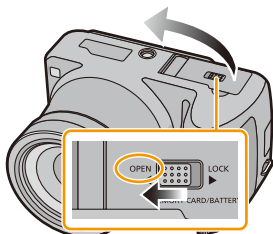

2 Push it securely all the way until you hear a “click” while being careful about the direction in which you insert it.

To remove the card, push the card until it clicks, then pull the card out upright.

(A): Do not touch the connection terminals of the card.

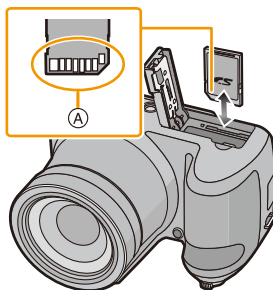

3 **①**: Close the card/battery door.

②: Slide the release lever in the direction of the arrow.

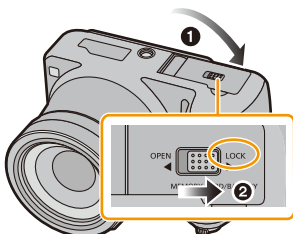

- Turn the camera off and wait for the “LUMIX” display on the monitor to clear before removing the card.
(Otherwise, this unit may no longer operate normally and the card itself may be damaged or the recorded pictures may be lost.)

About the Built-in Memory/the Card

The following operations can be performed using this unit:

When a card has not been inserted	Pictures can be recorded on the built-in memory and played back.
When a card has been inserted	Pictures can be recorded on the card and played back.

• **When using the built-in memory:**

 →  (access indication^{*1})

• **When using the card:**

 (access indication^{*1})

*1 The access indication is displayed in red when pictures are being recorded on the built-in memory (or the card).



Built-in Memory

- You can copy the recorded pictures to a card. (P99)
- **Memory size: Approx. 80 MB**
- The access time for the built-in memory may be longer than the access time for a card.

Card

The following cards, which conform to the SD standard, can be used with this unit.
(These cards are indicated as **card** in the text.)

	Remarks
SD Memory Card (8 MB to 2 GB)	<ul style="list-style-type: none"> • Use a card with SD Speed Class^{*2} with “Class 6” or higher when recording motion pictures. • SDHC Memory Cards and SDXC Memory Cards can be used only with their compatible devices. • Check that the PC and other equipment are compatible when using the SDXC Memory Cards. http://panasonic.net/avc/sdcard/information/SDXC.html • Only the cards with capacity listed left can be used.
SDHC Memory Card (4 GB to 32 GB)	
SDXC Memory Card (48 GB, 64 GB)	

*2 SD Speed Class is the speed standard regarding continuous writing. Check via the label on the card, etc.

e.g.:

CLASS 



- Please confirm the latest information on the following website.

<http://panasonic.jp/support/global/cs/dsc/>

(This site is English only.)

- During access (image writing, reading and deleting, formatting etc.), do not turn this unit off, remove the battery, card or disconnect the AC adaptor (supplied). Furthermore, do not subject the camera to vibration, impact or static electricity.

The card or the data on the card may be damaged, and this unit may no longer operate normally.

If operation fails due to vibration, impact or static electricity, perform the operation again.

- Write-Protect switch (A) provided (When this switch is set to the [LOCK] position, no further data writing, deletion or formatting is possible. The ability to write, delete and format data is restored when the switch is returned to its original position.)
- The data on the built-in memory or the card may be damaged or lost due to electromagnetic waves, static electricity or breakdown of the camera or the card. We recommend storing important data on a PC etc.
- Do not format the card on your PC or other equipment. Format it on the camera only to ensure proper operation. (P46)
- Keep the Memory Card out of reach of children to prevent swallowing.

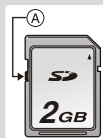

Approximate number of recordable pictures and available recording time

About the display of the number of recordable pictures and available recording time

- Switch the display (number of recordable pictures, available recording time, etc.) by pressing [DISP.].

(P47)

- The number of recordable pictures and the available recording time are an approximation.

(These vary depending on the recording conditions and the type of card.)

Number of
recordable pictures



Available recording
time



Number of recordable pictures

- [+99999] is displayed if there are more than 100,000 pictures remaining.

Quality []

Picture size	Built-in Memory (Approx. 80 MB)	2 GB	32 GB	64 GB
20M (4:3)	7	150	2650	5300
3M (4:3)	40	950	16500	33000
0.3M (4:3)	220	4900	80400	178000

Available recording time (when recording motion pictures)

- "h" is an abbreviation for hour, "m" for minute and "s" for second.

Recording quality setting	Built-in Memory (Approx. 80 MB)	2 GB	32 GB	64 GB
HD	—	9m20s	2h32m	5h03m
VGA	—	22m30s	6h07m	12h13m
QVGA	2m30s	1h05m	17h40m	35h15m

- The recordable time is the total time of all the motion pictures which have been recorded.
- Motion pictures can be recorded continuously up to 2 GB.
The maximum available recording time for up to 2 GB only is displayed on the screen.

Setting Date/Time (Clock Set)

- The clock is not set when the camera is shipped.
- Before turning on the camera, remove the lens cap.

1 Press camera [ON/OFF] button.

- If the language select screen is not displayed, proceed to step 4.

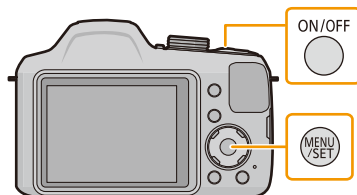

2 Press [MENU/SET].

3 Press ▲/▼ to select the language, and press [MENU/SET].

4 Press [MENU/SET].

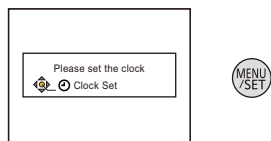

5 Press ◀/▶ to select the items (year, month, day, hour, minute, display sequence or time display format), and press ▲/▼ to set.

(A): Time at the home area

(B): Time at the travel destination

- You can cancel without setting the clock by pressing [🗑️/↵].

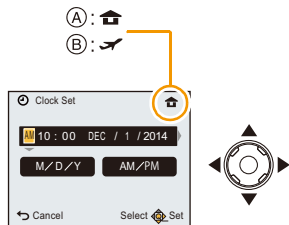

6 Press [MENU/SET] to set.

7 Press [MENU/SET].

Changing the Clock Setting

Select **[Clock Set]** on the **[Setup]** menu and then press **[MENU/SET]**. (P38)

- The clock can be reset as shown in steps **5** and **6**.
- **The clock setting is maintained for about 120 hours using the built-in clock battery even without the battery.**
(Leave the charged battery in the unit for about 2 hours to charge the built-in battery.)

- If the clock is not set, the correct date cannot be printed when you order a photo studio to print the picture, or when you stamp the date on the pictures with [Date Stamp].
In addition, if you turn off the unit, various settings may be reset.

Tips for taking good pictures

Hold the camera gently with both hands, keep your arms still at your side and stand with your feet slightly apart.

- Be careful not to move the camera when you press the shutter button.
- **Be careful not to put your fingers on the flash, AF Assist Lamp (A), microphone (B), speaker or lens etc.**
- Do not hold the lens barrel as you take pictures. There is a risk that your finger will be trapped as the lens retracts.

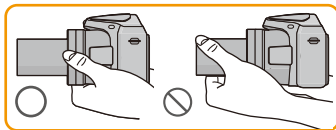
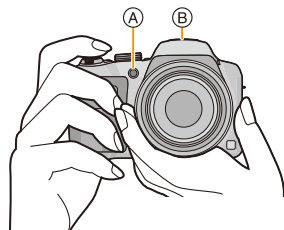

Preventing jitter (camera shake)

- When the Jitter alert [||⊕||] appears, use [Stabilizer] (P86), a tripod or the Self-timer (P55).
- Shutter speed will be slower particularly in the following cases. Keep the camera still from the moment the shutter button is pressed until the picture appears on the screen.
 - Slow sync./Red-Eye Reduction
 - [Night Portrait]/[Night Scenery]/[Starry Sky] (Scene Mode)

Selecting the Recording Mode



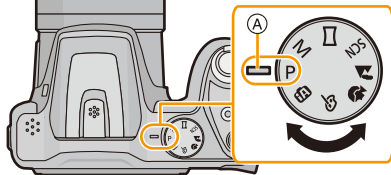

Switching the mode by rotating the mode dial.

- Rotate the mode dial slowly to select the desired mode.



Align a desired mode with part ①.

List of Recording Modes

	Intelligent Auto Mode (P26)
	The subjects are recorded using settings automatically selected by the camera.
P	Program AE Mode (P30)
	The subjects are recorded using your own settings.
M	Manual Exposure Mode (P58)
	The exposure is adjusted by the aperture value and the shutter speed which are manually adjusted.
	Panorama Shot Mode (P59)
	This mode allows you to take panorama pictures.
SCN	Scene Mode (P62)
	This mode allows you to take pictures that match the scene being recorded.
	Scenery Mode (P67)
	This allows you to take pictures of a wide landscape.
	Portrait Mode (P67)
	When taking pictures of people outdoors during the daytime, this mode allows you to improve the appearance and make their skin tones look healthier.
	Creative Control Mode (P68)
	Record while checking the image effect.

- If you keep rotating the mode dial, screens may switch slower.

Taking pictures using the automatic function

(Intelligent Auto Mode)

Recording Mode:

The camera will set the most appropriate settings to match the subject and the recording conditions so we recommend this mode for beginners or those who want to leave the settings to the camera and take pictures easily.

• The following functions are activated automatically.

- Scene Detection
- Backlight Compensation
- Intelligent ISO sensitivity control
- Auto White Balance
- Face Detection
- [i.Exposure]
- [i.Zoom]
- [AF Assist Lamp]
- [Red-Eye Removal]
- [Stabilizer]
- [Continuous AF]

1 Set the mode dial to [].

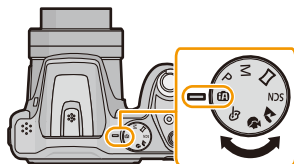

2 Press the shutter button halfway to focus.

- The focus indication **(A)** (green) lights when the subject is focused.
- The AF area **(B)** is displayed around the subject's face by the Face Detection function. In other cases, it is displayed at the point on the subject which is in focus.
- The minimal distance (how close you can be to the subject) will change depending on the zoom factor. Please check with the recordable range display on the screen. (P31)
- If you press ▲ while [AF Tracking] is displayed, you can set AF tracking.
For details, refer to P82.
(AF tracking is canceled by pressing ▲ again.)

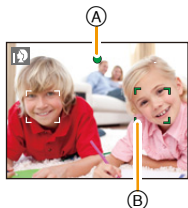







3 Press the shutter button fully (push it in further), and take the picture.



Scene Detection

When the camera identifies the optimum scene, the icon of the scene concerned is displayed in blue for 2 seconds, after which its color changes to the usual red.

When taking pictures

 [i-Portrait]	 [i-Scenery]
 [i-Macro]	 [i-Night Portrait]*
 [i-Night Scenery]	 [i-Sunset]

* Only displayed when the flash is set to [i↯A].

- [iA] is set if none of the scenes are applicable, and the standard settings are set.
- When [iP] or [iM] is selected, the camera automatically detects a person's face, and it will adjust the focus and exposure. **(Face Detection)**
- Due to conditions such as the ones below, a different scene may be identified for the same subject.
 - Subject conditions: When the face is bright or dark, the size of the subject, the color of the subject, the distance to the subject, the contrast of the subject, when the subject is moving
 - Recording conditions: Sunset, sunrise, under low brightness conditions, when the camera is shaken, when zoom is used
- [iA] is used for recording when recording motion pictures. Scene Detection does not work.

The Backlight Compensation

When there is a backlight, the subject appears darker and the camera will automatically attempt to correct it by increasing the brightness of the picture.

In Intelligent Auto Mode, backlight compensation works automatically.

(Depending on the backlighting conditions, backlighting may not be detected correctly.)

Changing the settings

Following menus can be set.

Menu	Item
[Rec]	[Picture Size]*/[Burst]*
[Motion Picture]	[Rec Quality]
[Setup]	[Online Manual]/[Clock Set]/[World Time]/[Beep]/[Language] • Menu items other than those listed above are not displayed, but you can set them in other Recording Modes.

• For the setting method of the menu, refer to P38.

* Available settings may be different from other Recording Modes.

About the flash (P50)

Press [OPEN] to open the flash.

- When [iA] is selected, [iA], [iA[Ⓜ]], [iS[Ⓜ]] or [iS] is set depending on the type of subject and brightness.
- When [iA[Ⓜ]], [iS[Ⓜ]] is set, [Red-Eye Removal] is enabled.
- Shutter speed will be slower during [iS[Ⓜ]] or [iS].

Taking Pictures with Your Favorite Settings

(Program AE Mode)

Recording Mode: **P**

The camera automatically sets the shutter speed and the aperture value according to the brightness of the subject.

You can take pictures with greater freedom by changing various settings in the [Rec] menu.

1 Set the mode dial to [P].

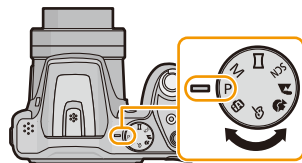

2 Aim the AF area at the point you want to focus on.

3 Press the shutter button halfway to focus and then press it fully to take the picture.

- (A) ISO sensitivity
- (B) Aperture value
- (C) Shutter speed

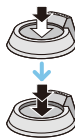

- Aperture value and shutter speed is displayed in red when correct exposure is not achieved.
(Exclude when using a flash)

Focusing

Aim the AF area at the subject, and then press the shutter button halfway.

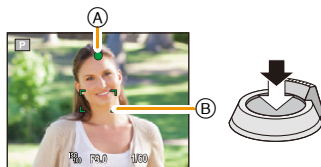

Focus	When the subject is focused	When the subject is not focused
Focus indication (A)	On	Blinks
AF area (B)	White→Green	White→Red
Sound	Beeps 2 times	Beeps 4 times

• The AF area may be displayed larger for certain zoom magnifications and in dark places.

About focus range

The focus range is displayed when operating the zoom.

• The focus range is displayed in red when it is not focused after pressing the shutter button halfway.



The focus range may change gradually depending on the zoom position.

e.g.: Range of focus during the Intelligent Auto Mode

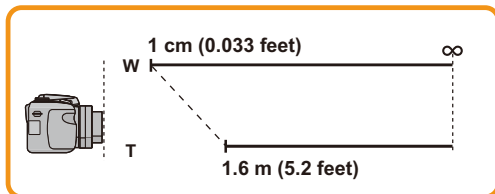

■ When the subject is not in focus (such as when it is not in the center of the composition of the picture you want to take)

- 1 Aim the AF area at the subject, and press the shutter button half way to fix the focus and exposure.
- 2 Press and hold the shutter button half way while moving the camera as you compose the picture.



- You can repeatedly retry the actions in step 1 before pressing the shutter button fully.

■ Subject and recording conditions which are difficult to focus in

- Fast-moving subjects, extremely bright subjects or subjects without contrast
- When recording subjects through windows or near shiny objects
- When it is dark or when jitter occurs
- When the camera is too close to the subject or when taking a picture of both distant and near subjects

Recording Motion Pictures

Applicable modes:       

This unit can record motion pictures in QuickTime Motion JPEG format.

1 Start recording by pressing the motion picture button.

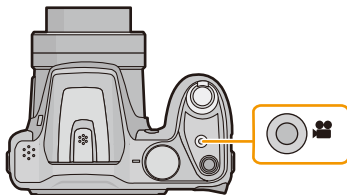

(A) Available recording time

(B) Elapsed recording time

- It is recommended that you close the flash when recording motion pictures.
- You can record motion pictures fitting each Recording Mode.
- Release the motion picture button right after you press it.
- The recording state indicator (red) (C) will flash while recording motion pictures.
- For the setting of [Rec Quality], refer to [P88](#).

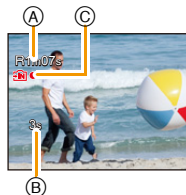

2 Stop the recording by pressing the motion picture button again.

- Depending on the type of the card, the card access indication may appear for a while after recording motion pictures. This is not a malfunction.
- The screen may be blacked out momentarily, or the unit may record noise due to static electricity or electromagnetic waves etc. depending on the environment of the motion picture recording.
- Even if the aspect ratio setting is the same in still pictures and motion pictures, the angle of view may change at the start of the motion picture recording.
When [Video Rec Area] (P43) is set to [ON], angle of view during motion picture recording is displayed.
- **About zooming while recording motion pictures**
 - If you use Extended Optical Zoom or Intelligent Zoom, the angle of view may change drastically when you start or finish recording a motion picture.
 - If you operate the zoom etc. while recording motion pictures, the sound of the operation may be recorded.
 - The zoom speed will be slower than usual when recording motion pictures.
 - Operating the zoom while recording motion pictures can take time for the image to come into focus.
- Since the camera adjusts the focus and lens aperture automatically while recording a motion picture, it may record the operation sound.
- Motion pictures cannot be recorded in the following cases.
 - [Soft Focus]/[Star Filter] (Creative Control Mode)
- It will be recorded in the following categorize for certain Recording Modes. A motion picture recording matching each Recording Mode will be performed for the ones not listed below.

Selected Recording Mode	Recording Mode while recording motion picture
• [Baby1]/[Baby2] (Scene Mode)	Portrait Mode
• [Night Portrait]/[Night Scenery]/[Starry Sky] (Scene Mode)	Low Light Mode
• Program AE Mode • Manual Exposure Mode • [Sports]/[HDR]/[Pet] (Scene Mode)	Normal motion picture
• [Glass Through] (Scene Mode)	Scenery Mode

Playing Back

1 Press [▶].

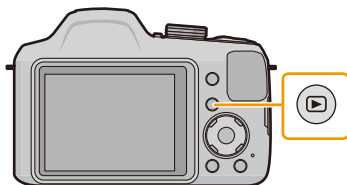

2 Press ◀/▶ to select pictures.

Ⓐ File number

Ⓑ Picture number

- If you press and hold ◀/▶, you can play back the pictures in succession.
- Speed of picture Forwarding/Rewinding changes depending on the playback status.

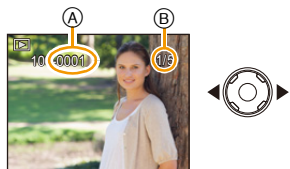

■ Playing Back Motion Pictures

Press ◀/▶ to select a picture with a Motion Picture icon (such as ) , and then press ▲ to play back.

Ⓒ Motion picture icon

Ⓓ Motion picture recording time

- After playback starts, the elapsed playback time is displayed on the screen.

For example, 8 minutes and 30 seconds is displayed as [08m30s].

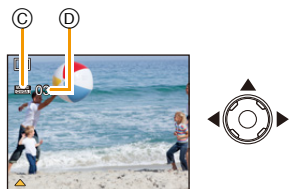

• Operations during Motion Picture Playback

	▲	Play/Pause
	▼	Stop
	◀	Fast rewind*/ Frame-by-frame rewind (while pausing)
	▶	Fast forward*/ Frame-by-frame forward (while pausing)

* The fast forward/rewind speed increases if you press ▶/◀ again.

– You can adjust the volume with the zoom lever.

- When the camera is turned off, press and hold [▶]. If you turn it on this way, the playback screen will be displayed automatically.
(If too many images are stored in the card, it may take a while for the camera to turn on.)
- This camera complies with the DCF standard "Design rule for Camera File system" established by JEITA "Japan Electronics and Information Technology Industries Association" and with Exif "Exchangeable Image File Format". Files that do not comply with the DCF standard cannot be played back.
- Images recorded or edited with the camera may not be played back correctly on other devices and applied effects may not appear on the devices.
Also, images recorded on other devices may not be played back on the camera and functions of the camera may not be available for the images.
- The lens barrel retracts about 15 seconds after switching from Recording Mode to Playback Mode. While the lens barrel is retracting, you may not be able to operate the camera.
- The file format that can be played back with this camera is QuickTime Motion JPEG.

Displaying Multiple Screens (Multi Playback)

Rotate the zoom lever towards [] (W).

1 screen → 12 screens → 30 screens → Calendar screen display

(A) Number of the selected picture and the total number of recorded pictures

- Rotate the zoom lever towards [Q] (T) to return to the previous screen.
- Pictures displayed using [!] cannot be played back.

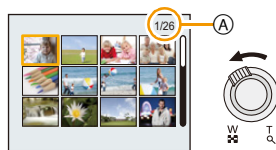

To return to normal playback

Press ▲/▼/◀/▶ to select a picture and then press [MENU/SET].

Using the Playback Zoom

Rotate the zoom lever towards [Q] (T).

1× → 2× → 4× → 8× → 16×

- When you rotate the zoom lever towards [] (W) after enlarging the picture, the magnification becomes lower.
- When you change the magnification, the zoom position indication (B) appears for about 2 seconds, and the position of the enlarged section can be moved by pressing ▲/▼/◀/▶.
- The more a picture is enlarged, the more its quality deteriorates.



Deleting Pictures

Once deleted, pictures cannot be recovered.

- Pictures on the built-in memory or the card that are being played back will be deleted.
- Pictures that are not in the DCF standard or those that are protected cannot be deleted.

To delete a single picture

Select the picture to be deleted, and then press **[/↵]**.

- Confirmation screen is displayed.
Picture is deleted by selecting [Yes].

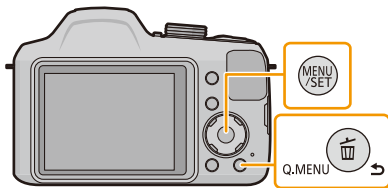

To delete multiple pictures (up to 50) or all the pictures

1 Press **[/↵]**.

2 Press **▲/▼** to select **[Delete Multi]** or **[Delete All]** and then press **[MENU/SET]**.

- [Delete All] → Confirmation screen is displayed.
Pictures are deleted by selecting [Yes].



3 (When **[Delete Multi]** is selected)

Press **▲/▼/◀/▶** to select the picture, and then press **[DISP.]** to set. (Repeat this step.)

-  appears on the selected pictures.
If [DISP.] is pressed again, the setting is canceled.



4 (When **[Delete Multi]** is selected)

Press **[MENU/SET]**.

- Confirmation screen is displayed.
Pictures are deleted by selecting [Yes].

- Do not turn the camera off while deleting.
- Depending on the number of pictures to be deleted, it may take some time to delete them.

Setting the Menu

The camera comes with menus that allow you to choose the settings for taking pictures and playing them back just as you like and menus that enable you to have more fun with the camera and use it more easily.

In particular, the [Setup] menu contains some important settings relating to the camera's clock and power.

Check the settings of this menu before proceeding to use the camera.

Setting menu items

Example: In the [Rec] menu, change [AF Mode] from [■] ([1-Area]) to [👤] ([Face Detection])

1 Press [MENU/SET].

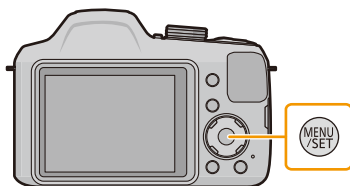

2 Press ◀▶ to select menu and then press [MENU/SET].

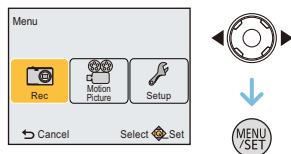

Menu	Description of settings
[Rec] (P74) (Recording Mode only)	The menu lets you set the Coloring, Sensitivity or Number of pixels, etc. of pictures you are recording.
[Motion Picture] (P88) (Recording Mode only)	This menu lets you set the setting for motion pictures such as recording quality.
[Playback Mode] (P89) (Playback Mode only)	This menu lets you select the playback method. The options include slideshow playback.
[Playback] (P95) (Playback Mode only)	This menu lets you set the Protection or Cropping, etc. of recorded pictures.
[Setup] (P41)	This menu lets you perform the clock settings, beep tone settings and other settings which make it easier for you to operate the camera.

3 Press ▲/▼ to select the menu item and then press [MENU/SET].

Ⓐ Menu screen page

- It will switch to the next page when you reach the bottom. (It will also switch by rotating the zoom lever)

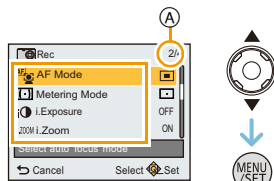

4 Press ▲/▼ to select the setting and then press [MENU/SET].

- Depending on the menu item, its setting may not appear or it may be displayed in a different way.

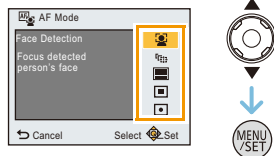

■ Close the menu

Press [🗑️/➡️] repeatedly until the screen returns to the recording/playback screen.

- In recording mode, the menu screen can also be exited by pressing the shutter button halfway.

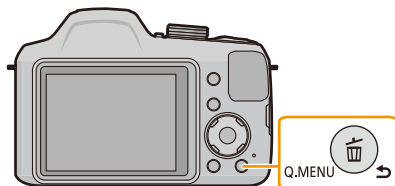

- There are functions that cannot be set or used depending on the modes or menu settings being used on the camera due to the specifications.

Using the Quick Menu

By using the Quick Menu, some of the menu settings can be easily found.

- The features that can be adjusted using Quick Menu are determined by the mode or a display style the camera is in.

1 Press [Q.MENU] when recording.

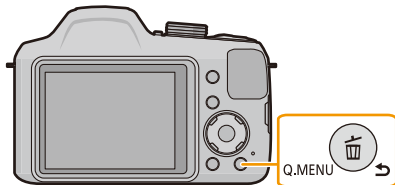

2 Press ▲/▼/◀/▶ to select the menu item and the setting and then press [MENU/SET] to close the menu.



About the Setup Menu





For details on how to select the [Setup] menu settings, refer to P38.





- [Clock Set], [Economy] and [Auto Review] are important items. Check their settings before using them.
- In Intelligent Auto Mode, only [Online Manual], [Clock Set], [World Time], [Beep], [Language] can be set.

 [Online Manual]	[URL display]/[USB connection]/[QR Code display]
---	--

 [Clock Set]	Setting Date/Time.
---	--------------------

- Refer to P22 for details.

 [World Time]	<p>Set the time in your home area and travel destination. You can display the local times at the travel destinations and record them on the pictures you take.</p> <p>After selecting [Destination] or [Home], press ◀/▶ to select an area, and press [MENU/SET] to set.</p> <ul style="list-style-type: none"> • Set [Home] first thing after purchasing. [Destination] can be set after setting up [Home]. <p>✈ [Destination]: Travel destination area</p> <p>(A) Current time of the destination area (B) Time difference from home area</p> <p>🏠 [Home]: Your home area</p> <p>(C) Current time (D) Time difference from GMT (Greenwich Mean Time)</p>	 
	<ul style="list-style-type: none"> • Press ▲ if you are using Daylight Savings []. (The time will move forward by 1 hour.) Press ▲ once more to return to the normal time. • If you cannot find the travel destination in the areas displayed on the screen, set by the time difference from the home area. 	

 [Beep]	This allows you to set the beep and shutter sound.
	[] ([Low])/[] ([High])/[] ([OFF])

✧ [Monitor Display]	Brightness, color, or red or blue tint of the monitor is adjusted.
	<p>[Brightness]: Adjust the brightness.</p> <p>[Contrast · Saturation]: Adjust the contrast or clarity of colors.</p> <p>[Red Tint]: Adjust the red tint.</p> <p>[Blue Tint]: Adjust the blue tint.</p> <p>1 Select the settings by pressing ▲/▼, and adjust with ◀/▶. 2 Press [MENU/SET] to set.</p>

- Some subjects may appear differently from actuality on the monitor. However, this does not affect the recorded pictures.
- When [Monitor Luminance] is set to [High Angle], [Brightness] and [Contrast · Saturation] cannot be adjusted.

MON [Monitor Luminance]	These menu settings make it easier to see the monitor when you are in bright places or when you are holding the camera high above your head.
	<p>[A*] ([Auto Power Monitor])*: The brightness is adjusted automatically depending on how bright it is around the camera.</p> <p>[□*] ([Power Monitor]): The monitor becomes brighter and easier to see even when taking pictures outdoors.</p> <p>[P] ([High Angle])*: The monitor is easier to see when taking pictures with the camera held high above your head.</p> <p>[OFF]</p> <p>* Can be set only when Recording Mode is set.</p>

- [High Angle] is also canceled if you turn the camera off or [Auto Power Off] is activated.
- The brightness of the pictures displayed on the monitor is increased so some subjects may appear different from real life on the monitor. However, this does not affect the recorded pictures.
- When [Monitor Luminance] is set, the usage time is reduced.

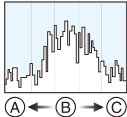

 [Histogram]	This allows you to set either to display or not display the Histogram.
	[ON]/[OFF]
	<p>A Histogram is a graph that displays brightness along the horizontal axis (black to white) and the number of pixels at each brightness level on the vertical axis. It allows you to easily check a picture's exposure.</p> <p>(A) dark (B) optimal (C) bright</p> 

• **When the recorded picture and the histogram do not match each other under the following conditions, the histogram is displayed in orange.**

- When the Manual Exposure Assistance is other than [0] during exposure compensation or in the Manual Exposure Mode
 - When the flash is activated
 - When the exposure is not adequately adjusted
 - When the brightness of the screen is not correctly displayed in dark places
- When you record images, the Histogram before exposure compensation will be displayed.
- The Histogram is an approximation in Recording Mode.
- The Histogram of a picture may not match in the Recording Mode and the Playback Mode.
- The Histogram displayed in this camera does not match Histograms displayed by picture editing software used in PCs, etc.
- Histograms are not displayed in the following cases.
- Intelligent Auto Mode
 - Panorama Shot Mode
 - When recording motion pictures
 - Calendar
 - Multi Playback
 - Playback Zoom

 [Video Rec Area]	Angle of view for motion picture recording can be checked.
	[ON]/[OFF]

- Motion picture recording area display is only an approximation.
- Recording area display may disappear when zooming to Tele depending on the picture size setting.
- The setting is fixed to [OFF] in the following case.
 - Intelligent Auto Mode

ECO [Economy]	The camera is automatically turned off if the camera has not been used for the time selected on the setting. Also, the battery life is conserved by dimming the monitor.
	 [Auto Power Off]: The camera is automatically turned off if the camera has not been used for the time selected on the setting. [2MIN.]/[5MIN.]/[10MIN.]/[OFF]  [Monitor Power Save]: The brightness of the monitor is lowered. [ON]/[OFF]

- [Auto Power Off] is fixed to [5MIN.] in the following case.
 - Intelligent Auto Mode
- [Auto Power Off] does not work in the following cases.
 - When connecting to a PC or a printer
 - When recording or playing back motion pictures
 - During a Slide Show
- The effect of the [Monitor Power Save] is lower in the Digital Zoom range compared to the Optical Zoom range.
- [Monitor Luminance] settings take priority, even if [Monitor Power Save] has been set.



 [Auto Review]	Set the length of time that the picture is displayed after taking the still picture.
	[1 SEC.] [2 SEC.] [HOLD]: The pictures are displayed until one of the buttons is pressed. [OFF]

- The setting is fixed to [2 SEC.] in the following case.
 - Intelligent Auto Mode
- [Auto Review] does not work when recording motion pictures.

 [Exposure Comp. Reset]	When you turn off the camera or switch the Recording Mode, the exposure value is set to [0 EV].
	[ON]/[OFF]

 [Reset]	The recording or setup settings are reset to the default.
--	---

- When the [Reset] setting is selected during recording, the operation that resets the lens is also performed at the same time. You will hear the sound of the lens operating but this is normal and not indicative of malfunctioning.
- When the setup settings are reset, the following settings are also reset.
 - The birthday settings for [Baby1]/[Baby2] and [Pet] in Scene Mode.
- The folder number and the clock setting are not changed.

 [TV Connection]	Set to match the color television system in each country or the type of TV.
	 ([Video Out])*: [NTSC]: Video output is set to NTSC system. [PAL]: Video output is set to PAL system.  ([TV Aspect]): [16:9]: When connecting to a 16:9 screen TV. [4:3]: When connecting to a 4:3 screen TV.

• This will work when the AV cable (optional) is connected.

* PAL video out is not available on the version DMC-LZ40P sold in the U.S. and the version DMC-LZ40PC sold in Canada.

 [Version Disp.]	It is possible to check which version of firmware is on the camera.
--	---

 [Format]	The built-in memory or card is formatted. Formatting irretrievably deletes all the data so check the data carefully before formatting.
---	--

• Do not turn the camera off during formatting.

• If a card has been inserted, only the card is formatted. To format the built-in memory, remove the card.

• If the card has been formatted on a PC or other equipment, format it on the camera again.

• It may take longer to format the built-in memory than the card.

• If the card cannot be formatted, please try another card before contacting Panasonic.

 [Language]	Set the language displayed on the screen.
--	---

• If you set a different language by mistake, select  from the menu icons to set the desired language.

About the Monitor

Press [DISP.] to change.

- During motion picture playback, panorama playback or a slide show, you can only select “Normal Display” or “No Display”.

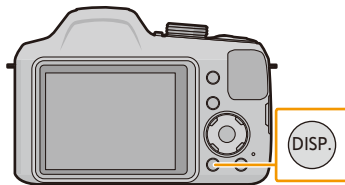

In Recording Mode

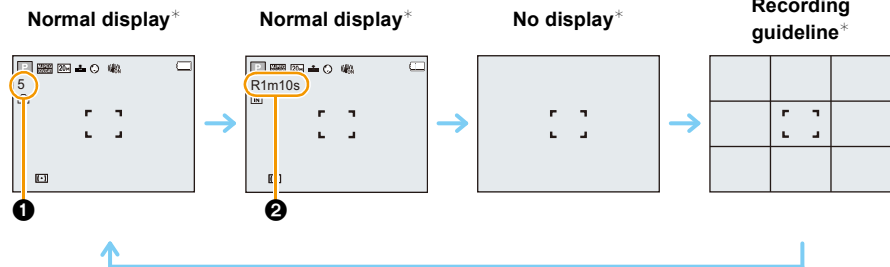

- ❶ Number of recordable pictures
- ❷ Available recording time

In Playback Mode

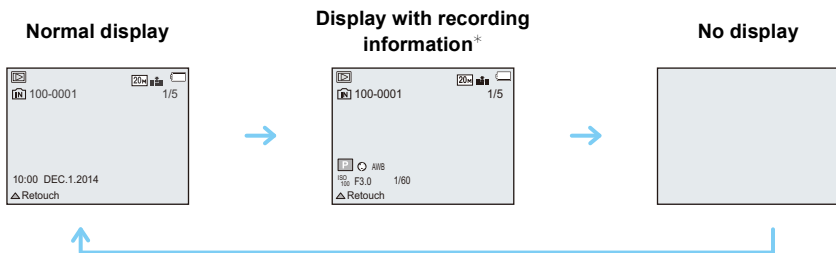

■ Recording guideline

This is used as a reference of composition, such as balance, while taking a picture.

- * If the [Histogram] in [Setup] menu is set to [ON], Histogram will be displayed.

Using the Zoom

Applicable modes:       

You can zoom in to make people and objects appear closer or zoom out to record landscapes in wide angle.

To make subjects appear further away use (Wide)

Rotate the zoom lever towards Wide.

To make subjects appear closer use (Tele)

Rotate the zoom lever towards Tele.

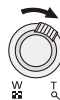

■ Screen display

Example of display when Extended Optical Zoom (EZ), Intelligent Zoom and Digital Zoom are used together.

- (A) Extended Optical Zoom indication
- (B) Optical Zoom range
- (C) Intelligent Zoom range
- (D) Digital Zoom range
- (E) Zoom magnification (approximation)

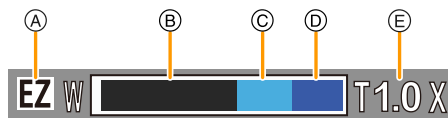

• When using the Zoom function, an estimate of the focus range will appear in conjunction with the zoom display bar. [Example: 0.01 m (0.033 ft.) -∞]

- The lens barrel will extend or retract depending on the zoom position. Take care not to obstruct the movement of the lens barrel when using the Zoom function.
- For details about using the zoom while recording motion pictures, refer to P34.

Optical Zoom

Zooms in without deteriorating the image quality.

Maximum magnification: 42×

- This function is not available in the following case:
 - Macro Zoom Mode

Extended Optical Zoom (EZ)

This function works when any of the picture sizes (P74) indicated with **EZ** is selected. You can zoom in further than you can with the Optical Zoom without deteriorating the image quality.

Maximum magnification: 105×

(This includes the optical zoom magnification. The magnification level differs depending on [Picture Size] setting.)

- “EZ” is an abbreviation of “Extended Optical Zoom”.
- This function is not available in the following cases:
 - [HDR]/[High Sens.] (Scene Mode)
 - [Impressive Art]/[Toy Effect] (Creative Control Mode)
 - Macro Zoom Mode
 - When [Burst] in the [Rec] menu is set to [☐H]
 - When recording motion pictures

Intelligent Zoom

Enabled when [i.Zoom] (P83) in the [Rec] menu is set to [ON].

You can zoom in up to twice the original zoom magnification while minimizing the deterioration of the image quality.

- This will work automatically in Intelligent Auto Mode.
- This function is not available in the following cases:
 - [HDR]/[High Sens.] (Scene Mode)
 - [Impressive Art]/[Toy Effect] (Creative Control Mode)
 - Macro Zoom Mode
 - When [Burst] in the [Rec] menu is set to [☐H]

Digital Zoom

This function works when [Digital Zoom] (P83) in the [Rec] menu is set to [ON].

Although the image quality deteriorates every time you zoom in further, you can zoom in up to four times the original zoom magnification.

- When using the [i.Zoom], the maximum magnification of the Digital Zoom is limited to 2×.
- We recommend using a tripod and the Self-timer (P55) for taking pictures.
- This function is not available in the following cases:
 - Intelligent Auto Mode
 - [HDR]/[High Sens.] (Scene Mode)
 - [Impressive Art]/[Toy Effect]/[Miniature Effect] (Creative Control Mode)
 - When [Burst] in the [Rec] menu is set to [☐H]

Taking Pictures Using the Built-in Flash

Applicable modes:       

■ To open/close the flash

(A) To open the flash

Press [ OPEN].

(B) To close the flash

Push the top of the flash cover until it clicks.

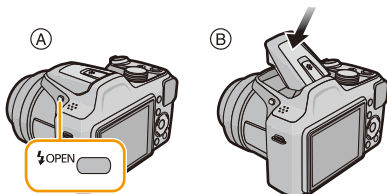

- Be careful not to catch a finger when closing a flash bulb.
- Be sure to close the flash when not in use.
- The flash setting is fixed to  while the flash is closed.
- Be sure to keep the flash clean, clear of dust and avoid exposure to anything sticky. This may cause the flash to stick and not open.
- You cannot close the flash by pushing the microphone or its periphery. Forcibly closing the flash can damage the camera.

Switching to the appropriate flash setting

Set the flash to match the recording.

- Open the flash.

1 Press  [].

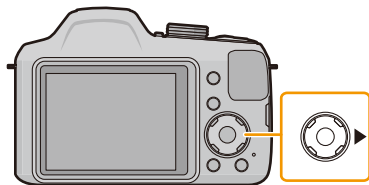

2 Press ▲/▼ to select the setting and then press [MENU/SET].

Settings	Description of settings
[A] ([Auto]) [iA] ([iAuto])* ¹	The flash is automatically activated when the recording conditions make it necessary.
[A⊙] ([Auto/Red-Eye])* ²	The flash is automatically activated when the recording conditions make it necessary. It is activated once before the actual recording to reduce the red-eye phenomenon (eyes of the subject appearing red in the picture) and then activated again for the actual recording. • Use this when you take pictures of people in low lighting conditions.
[] ([Forced Flash On])	The flash is activated every time regardless of the recording conditions. • Use this when your subject is back-lit or under fluorescent light.
[S⊙] ([Slow Sync./Red-Eye])* ²	If you take a picture with a dark background landscape, this feature will slow the shutter speed when the flash is activated so that the dark background will become bright. Simultaneously, it reduces the red-eye phenomenon. • Use this when you take pictures of people in front of a dark background.
[] ([Forced Flash Off])	The flash is not activated in any recording conditions. • This item is not displayed on the menu. To set the camera to [], close the flash. • Use this when you take pictures in places where the use of flash is not permitted.

*1 This can be set only when Intelligent Auto Mode is set.

The icon changes depending on the type of subject and brightness.













*2 **The flash is activated twice. The subject should not move until the second flash is activated.**

[Red-Eye Removal] (P86) on the [Rec] menu is set to [ON], [] appears on the flash icon.









■ Available Flash Settings in Recording Mode

The available flash settings depend on the Recording Mode.

(○: Available, —: Not available, ●: Scene Mode initial setting)

					
	○*	—	—	—	○
P	○	○	○	○	○
M 	○	○	○	—	○
	○	●	○	—	○
	—	—	—	—	●
	●	—	○	—	○
	—	—	—	●	○
	○	—	●	—	○





*  is displayed.

- When  is selected, , ,  or  is set depending on the type of subject and brightness.
- When ,  is set, [Red-Eye Removal] is enabled.
- Shutter speed will be slower during  or .
- The flash setting may change if the Recording Mode is changed. Set the flash setting again if necessary.
- The Scene Mode flash setting is reset to the initial setting when the Scene Mode is changed.
- Flash will not be activated when recording motion picture.

■ The available flash range (approximation)

	Wide	Tele
[AUTO] in [Sensitivity]	60 cm (2.0 feet) to 10.8 m (35 feet)	1.6 m (5.2 feet) to 4.9 m (16 feet)

■ Shutter speed for each flash setting

Flash setting	Shutter speed (Sec.)	Flash setting	Shutter speed (Sec.)
	1/60 to 1/1500		1 to 1/1500
			
			

- In Intelligent Auto Mode, shutter speed changes depending on the identified scene.
- In Scene Mode, shutter speed will be different from the above table.

- If you bring the flash too close to an object, the object may be distorted or discolored by the heat or lighting from the flash.
- Recording a subject from too close, or without sufficient flash will not provide the appropriate level of exposure, and may result in a picture that is too white or dark.
- When the flash is being charged, the flash icon blinks red, and you cannot take a picture even when you press the shutter button fully.
- If recording a subject without sufficient flash, the White Balance may not be properly adjusted.
- The effects of the flash may not be adequately achieved under the following condition.
 - When the shutter speed is too fast
- It may take time to charge the flash if you repeatedly take pictures. Take a picture after the access indication disappears.
- The Red-Eye Reduction effect differs between people. Also, if the subject is far away from the camera or was not looking at the first flash, the effect may not be evident.

Taking Close-up Pictures ([AF Macro]/[Macro Zoom])

Applicable modes:

This mode allows you to take close-up pictures of a subject, e.g. when taking pictures of flowers.

1 Press .

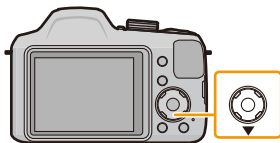

2 Press to select the item and then press [MENU/SET].

Item	Description of settings
[AF] ([AF Macro])	You can take pictures of a subject as close as 1 cm (0.033 feet) from the lens by rotating the zoom lever upmost to Wide (1×).
[] ([Macro Zoom])	Use this setting to get close to the subject and then further enlarge when taking the picture. You can take a picture with the Digital Zoom up to 3× while maintaining the distance to the subject for the extreme Wide position [1 cm (0.033 feet)]. • The image quality is poorer than during normal recording. • Zoom range will be displayed in blue. (digital zoom range)
[OFF]	—

- We recommend using a tripod and the Self-timer.
- We recommend setting the flash to (close the flash) when you take pictures at close range.
- If the distance between the camera and the subject is beyond the focus range of the camera, the picture may not be properly focused even if the focus indication lights.
- When a subject is close to the camera, the effective focus range is significantly narrowed. Therefore, if the distance between the camera and the subject is changed after focusing on the subject, it may become difficult to focus on it again.
- Macro Mode gives priority to a subject close to the camera. Therefore, if the distance between the camera and the subject is far, it takes longer to focus on it.
- When you take pictures at close range, the resolution of the periphery of the picture may decrease slightly. This is not a malfunction.
- [Macro Zoom] cannot be set in the following cases.
 - [Toy Effect]/[Miniature Effect] (Creative Control Mode)
 - When [AF Mode] is set to
 - When [Burst] in the [Rec] menu is set to



Taking Pictures with the Self-timer

Applicable modes:       

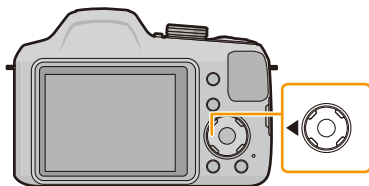
1 Press ◀ [].



2 Press ▲/▼ to select the setting and then press [MENU/SET].

Settings	Description of settings
[] ₁₀ ([10sec.])	Picture is taken 10 seconds after shutter is pressed.
[] ₂ ([2sec.])	Picture is taken 2 seconds after shutter is pressed. • When using a tripod, etc., this setting is a convenient way to avoid the jitter caused by pressing the shutter button.
[OFF]	—

3 Press the shutter button halfway to focus and then press it fully to take the picture.

- The Self-timer indicator  blinks and the shutter is activated after 10 seconds (or 2 seconds).

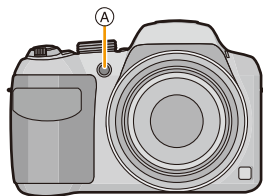
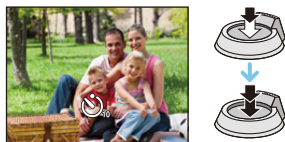

- We recommend using a tripod when recording with the Self-timer.
- This function is not available in the following case:
 - When recording motion pictures

Compensating the Exposure

Applicable modes:       

Use this function when you cannot achieve appropriate exposure due to the difference in brightness between the subject and the background.

Underexposed



Properly exposed



Overexposed



Compensate the exposure towards positive.

Compensate the exposure towards negative.

- 1 Press   to display [Exposure Comp.].

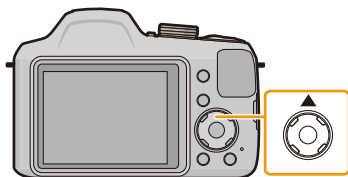

- 2 Press   to compensate the exposure and then press [MENU/SET].

- The exposure compensation value appears on the screen.
- Select [0 EV] to return to the original exposure.

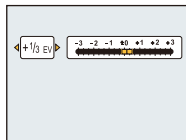

- “EV” is an abbreviation of “Exposure Value”, a unit indicating the amount of exposure. The EV changes with the aperture value or the shutter speed.
- When [Exposure Comp. Reset] in the [Setup] menu is set to [OFF], the current exposure value will be maintained even if you turn off the camera.
- This function is not available in the following case:
 - [Starry Sky] (Scene Mode)

Taking Pictures Using Auto Bracket

Applicable modes:       

In this mode, 3 pictures are automatically recorded in the selected exposure compensation range each time the shutter button is pressed.

With Auto Bracket ± 1 EV

1st picture



± 0 EV

2nd picture





-1 EV



3rd picture



+1 EV

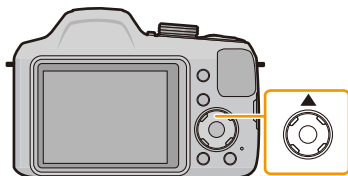

- 1 Press  [] repeatedly until [Auto Bracket] is displayed.

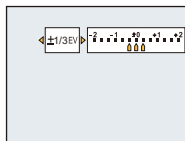

- 2 Press /  to set the compensation range of the exposure and then press [MENU/SET].

- When you do not use Auto Bracket, select [OFF] (± 0).



- If you turn off the camera, Auto Bracket will be canceled.
- When setting Auto Bracket, [] appears on the screen.
- When taking pictures using Auto Bracket after setting the Exposure Compensation range, the pictures taken are based on the selected Exposure Compensation range.
- The exposure may not be compensated with Auto Bracket depending on the brightness of the subject.
-  is set for the flash when Auto Bracket is set.
- This function is not available in the following cases:
 - [Toy Effect]/[Miniature Effect]/[Soft Focus]/[Star Filter] (Creative Control Mode)
 - [HDR]/[Starry Sky] (Scene Mode)
 - When recording motion pictures

Taking Pictures by Specifying the Aperture/ Shutter Speed (Manual Exposure Mode)

Recording Mode: **M**

Determine the exposure by manually setting the aperture value and the shutter speed. A long exposure, up to 15 seconds is possible.

- 1 Set the mode dial to [M].
- 2 Press [EXPOSURE].
- 3 Press ▲/▼/◀/▶ to set the aperture and shutter speed.
 - ◀/▶: Aperture Value (A)
 - ▲/▼: Shutter Speed (B)
- 4 Press [EXPOSURE].

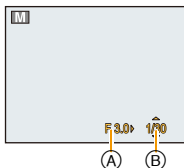

Manual Exposure Assistance

If you press the shutter button halfway, the Manual Exposure Assistance is displayed.

	The exposure is adequate.
	Set to faster shutter speed or larger aperture value.
	Set to slower shutter speed or smaller aperture value.

- The Manual Exposure Assistance is an approximation. We recommend checking the pictures on the playback screen.
- The brightness of the monitor and the recorded pictures may differ. Check the pictures on the playback screen.
- The aperture value and the shutter speed displayed on the screen turn red when the exposure is not adequate.
- We recommend using a tripod when the shutter speed is slow.
- In motion picture recording, the aperture and shutter speed are set automatically.

Taking panorama pictures (Panorama Shot Mode)

Recording Mode: 

Pictures are recorded continuously while moving the camera horizontally or vertically, and are combined to make a single panorama picture.

This mode allows you to add any of 13 types of effects before recording.

1 Set the mode dial to .

2 Press ▲/▼ to select the recording direction and then press [MENU/SET].

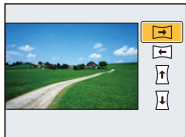

3 Press ▲/▼ to select image effects and then press [MENU/SET].

- You can add the same image effect as the Creative Control Mode with the same operation as the Creative Control Mode. (except for [Toy Effect] and [Miniature Effect]) (P69–73)
- During panorama picture recording, the following image effect of the Creative Control Mode is not visible on the screen:
 - [Star Filter]
- If you are not going to add an image effect, select [No Effect].

4 After confirming the recording direction, press [MENU/SET].

- If the selected recording direction is the same as that of the previous recording, the screen that lets you check the recording direction may not be displayed.
- A horizontal/vertical guide is displayed. If you press ►, you will return to step 2.

5 Press the shutter button halfway to focus.

6 Press the shutter button fully and record a picture while moving the camera in a small circle in the direction selected in Step 2.

Recording from left to right

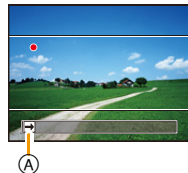
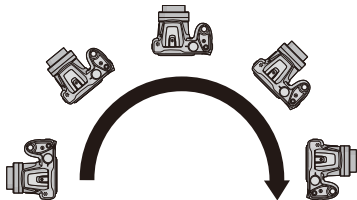

Trace a half-circle with the camera, taking about 4 seconds.

- Move the camera at a constant speed.

Pictures may not be able to be recorded properly if the camera is moved too fast or slow.

- (A) Recording direction and panning (Guide)

7 Press the shutter button once again to end the picture recording.

- Recording can also be ended by keeping the camera still while recording.

■ Technique for Panorama Shot Mode

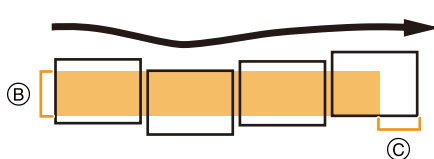

- (B) Move the camera in the recording direction without shaking it.

(If the camera shakes too much, pictures may not be able to be recorded, or the recorded panorama picture may become narrower (smaller).)

- (C) Move the camera towards the edge of the range you wish to record.

(The edge of the range will not be recorded in the last frame)

- The zoom position is fixed to Wide.
- [Stabilizer] is fixed to [OFF].
- The focus, White Balance, and exposure are fixed at the optimum values for the first picture. As a result, if the focus or brightness changes substantially during recording, the entire panorama picture may not be recorded at the suitable focus or brightness.
- White Balance is fixed to [AWB] while an image effect is applied.
- When multiple pictures are combined to create a single panorama picture, the subject may appear distorted or the connection points may be noticeable in some cases.
- The number of recording pixels in the horizontal and vertical directions of the panorama picture varies depending on the recording direction and the number of combined pictures.
The maximum number of pixels is shown below.

Recording direction	Horizontal Resolution	Vertical Resolution
Horizontal	3200 pixels	720 pixels
Vertical	960 pixels	3200 pixels

- A panorama picture may not be able to be created, or the pictures may not be combined properly when recording the following subjects or under the recording conditions below.
 - Subjects with a single, uniform color or repetitive pattern (such as the sky or a beach)
 - Moving subjects (person, pet, car, waves, flowers blowing in the breeze, etc.)
 - Subjects where the color or patterns change in a short time (such as an image appearing on a display)
 - Dark places
 - Locations with flickering light sources such as fluorescent lights or candles

■ About playback





	▲	Start panorama playback/Pause*
	▼	Stop

- * You can perform frame-by-frame forward/rewind by pressing ►/◀ during a pause.





Taking pictures that match the scene being recorded (Scene Mode)

Recording Mode: 

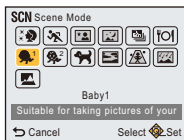
You can select any of 13 types of Scene Modes according to the subject and scene.

- 1 Set the mode dial to [SCN].
- 2 Press /// to select the Scene Mode and then press [MENU/SET].



- To change the Scene Mode, press [MENU/SET], select [Scene Mode] using ///, and then press [MENU/SET].
- The following cannot be set in Scene Mode as the camera adjusts automatically.
 - [Sensitivity]/[Metering Mode]/[i.Zoom]

[Soft Skin]

When taking pictures of people outdoors during the daytime, this mode enables the texture of their skin to appear even softer than with Portrait Mode.

(It is effective when taking pictures of people from the chest up.)

■ Technique for Soft Skin Mode

To make this mode more effective:

- ❶ Rotate the zoom lever as far as possible to Tele.
- ❷ Move close to the subject to make this mode more effective.

- If a part of the background etc. is a color similar to skin color, this part is also smoothed.
- This mode may not be effective when there is insufficient brightness.

[Sports]

Setting for when you want to take pictures of sports scenes or other fast-moving events.

- This mode is suitable for taking pictures of subjects at distances of 5 m (16 feet) or more.

[Night Portrait]

This allows you to take pictures of a person and the background with near real-life brightness.

- **Use the flash. (You can set to [].)**
- Ask the subject not to move while taking a picture.
- We recommend using a tripod and the Self-timer for taking pictures.
- Shutter speed may slow down up to 1/4 seconds.
- Noise may become visible when you take pictures in dark places.

[Night Scenery]

This allows you to take vivid pictures of the nightscape.

- We recommend using a tripod and the Self-timer for taking pictures.
- Shutter speed may slow down up to 8 seconds.
- The shutter may remain closed (max. about 8 sec.) after taking the picture because of signal processing. This is not a malfunction.
- Noise may become visible when you take pictures in dark places.

[HDR]

You can combine several pictures with different levels of exposure into a single picture with rich gradation.

You can minimize the loss of gradations in bright areas and dark areas when, for example, the contrast between the background and the subject is large.

■ Picture Size

Select the picture size of 3M (4:3), 2.5M (3:2), 2M (16:9) or 2.5M (1:1).

■ What Is HDR?

HDR stands for High Dynamic Range and refers to a technique for expressing a wide contrast range.

- Do not move the camera during the continuous shooting after pressing the shutter button.
- You cannot take the next picture until the combination of pictures is complete.
- A moving subject may be recorded with unnatural blurs.
- The continuous shooting may not work under certain recording conditions. In that case, a single picture is recorded.

[Food]

This mode allows you to take pictures of food with a natural hue without being affected by the ambient light in restaurants, etc.

[Baby1]/[Baby2]

This takes pictures of a baby with a healthy complexion.

It is possible to set different birthdays for [Baby1] and [Baby2]. You can display those during playback.

■ Birthday setting

1 Press ▲/▼ to select [Age] and then press [MENU/SET].

2 Press ▲/▼ to select [SET] and then press [MENU/SET].

3 Enter the birthday.

◀/▶: Select the items (year/month/day)

▲/▼: Setting

[MENU/SET]: Set

- When the birthday is set, [Age] is automatically set to [ON].

- If [ON] is selected when the birthday has not been registered, the setting screen appears automatically.

4 Press ▼ to select [Exit] and then press [MENU/SET] to finish.

■ To cancel [Age]

Select the [OFF] setting in step 2.

• If [Age] is set to [OFF] even when the birthday has been set, the age will not be displayed.

[Pet]

Select this when you want to take pictures of a pet such as a dog or a cat.

You can set your pet's birthday.

For information about [Age], refer to [Baby1]/[Baby2] on P65.

[Sunset]

Select this when you want to take pictures of a sunset view.

This allows you to take vivid pictures of the red color of the sun.

[High Sens.]

This mode minimizes the jitter of the subjects, and enables you to take pictures of these subjects in dimly lit rooms.

■ Picture Size

Select the picture size of 3M (4:3), 2.5M (3:2), 2M (16:9) or 2.5M (1:1).

[Starry Sky]

This mode allows you to take vivid pictures of a starry sky or a dark subject.

■ Setting the shutter speed

Select a shutter speed of [15 sec.], [30 sec.] or [60 sec.].

- Press the shutter button fully to display the countdown screen. Do not move the camera after this screen is displayed.

When countdown finishes, [Please wait...] is displayed for the same length of time as the set shutter speed for signal processing.

- The shutter opens for 15, 30 or 60 seconds. Be sure to use a tripod. We also recommend taking pictures with the Self-timer.

[Glass Through]

Objects in the distance are prioritized for focus.

This mode is ideal for taking pictures of scenery and other landscapes through clear glass, such as in vehicles or buildings.

- The camera may focus on the glass if it is dirty or has dust on it.
- The pictures taken may not look natural if the glass is colored. When this happens, change the White Balance settings. (P77)

Taking pictures of Scenery (Scenery Mode)

Recording Mode: 

This allows you to take pictures of a wide landscape.

Set the mode dial to [🏔️].

Taking pictures of People (Portrait Mode)

Recording Mode: 

When taking pictures of people outdoors during the daytime, this mode allows you to improve the appearance and make their skin tones look healthier.

Set the mode dial to [👤].

■ Technique for Portrait Mode

To make this mode more effective:

- 1 Rotate the zoom lever as far as possible to Tele.
- 2 Move close to the subject to make this mode more effective.

Taking Pictures with different image effects

(Creative Control Mode)

Recording Mode: 

This mode allows you to add any of 15 types of effects before recording. You can set the effects to add by selecting example images and checking them on the screen.

- 1** Set the mode dial to [].
- 2** Press ▲/▼ to select image effects and then press [MENU/SET].

- The image effect of the selected example image will be applied in a preview display .
- A brief description of selected image effect appears when you press [DISP].

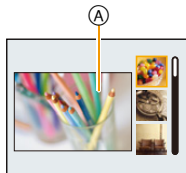

- To change the Creative Control Mode, press [MENU/SET], select [Creative Control] using ▲/▼/◀/▶, and then press [MENU/SET].
- The displayed image on the recording screen and the preview of the selected image effect may differ from the actual recorded image.
- ISO sensitivity will be fixed to [AUTO].
- White Balance will be fixed to [AWB].

For details on how to select the “Creative Control Mode” settings, refer to P68.

* These pictures are examples to show the effect.

[Expressive]



This effect emphasize the color to make a pop art picture.

[Retro]



This effect gives a faded image.

[Old Days]

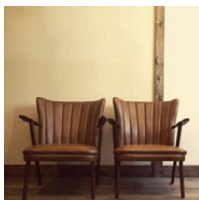

This effect adds a bright, soft and nostalgic feel to the overall image.

[High Key]



This effect adds a bright, airy and soft feel to the overall image.

- If you select this effect with Panorama Shot Mode, the effect may not be apparent in places with insufficient brightness.

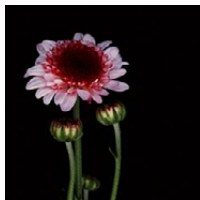
[Low Key]

This effect adds a dark and relaxing feel to the overall image and enhances bright parts.

[Sepia]

This effect creates a sepia image.

[Dynamic Monochrome]

This effect gives a higher contrast to create an impressive black and white picture.

[Impressive Art]

This effect gives your photo a dramatic contrast look.

- If you select this effect with Panorama Shot Mode, seams between pictures may become noticeable.

[High Dynamic]

This effect produces the optimum brightness for both dark and bright parts.

[Cross Process]

This effect gives your photo a dramatic color look.

Items that can be set

Color	Green tone/Blue tone/Yellow tone/Red tone
-------	---

- Press ◀/▶ to select the color to enhance, and press [MENU/SET].

**[Toy Effect]**

This effect reduces peripheral brightness to give the impression of a toy camera.

Items that can be set

Color	Orange emphasized	↔	Blue emphasized
-------	-------------------	---	-----------------

- Press ◀/▶ to select the color tone, and press [MENU/SET].



[Miniature Effect]

This effect blurs peripheral areas to give the impression of a diorama.

Items that can be set

Direction of the blur	Horizontal/Vertical
-----------------------	---------------------

- Press ◀/▶ to select the direction of the blur, and press [MENU/SET].

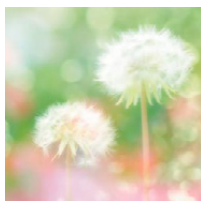

- Display of the recording screen will be delayed more than usual and the screen will look as if frames are being dropped.
- No sound is recorded in motion pictures.
- Approximately 1/10 of the time period is recorded.
(If you record for 10 minutes, the resulting motion picture recording will be approximately 1 minute long.)
The displayed available recording time is approximately 10 times. When switching to Recording Mode, please check the available recording time.
- Even if motion picture recording is terminated in a short time, the recording may actually continue for a certain period of time.
Keep the camera still until the recording is complete.
- When taking pictures of a large size, the screen may turn black after taking the picture because of signal processing. This is not a malfunction.

[Soft Focus]

This effect blurs the overall image to produce a soft feel.

- Display of the recording screen will be delayed more than usual and the screen will look as if frames are dropping.

[Star Filter]

This effect transforms pin-points of light into a star effect.

- Display of the recording screen will be delayed more than usual and the screen will look as if frames are dropping.

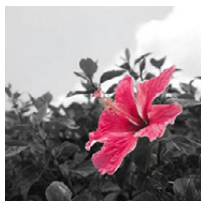
[One Point Color]

This effect leaves one selected color to emphasize impressiveness.

■ **Set the color to leave in**

- 1 Fit the color you want to leave in the frame at the center of the screen, and then press [MENU/SET].**
 - If you press [DISP.], you will return to step **1**.
- 2 Check the color you have set, and then press [MENU/SET].**
 - The set color is memorized even if the camera is turned off.



- Depending on the subject, the set color may not be left in.

Using the [Rec] Menu

For details on [Rec] menu settings, refer to P38.

[Picture Size]

Applicable modes:       

Set the number of pixels.

The higher the numbers of pixels, the finer the detail of the pictures will appear even when they are printed onto large sheets.

Settings	Picture Size
[4:3 20M]	5152×3864
[4:3 8M ^{3/4}]*	3264×2448
[4:3 3M ^{3/4}]	2048×1536
[4:3 0.3M ^{3/4}]*	640×480
[3:2 17.5M]	5152×3432
[3:2 7M ^{3/4}]*	3264×2176
[3:2 2.5M ^{3/4}]	2048×1360
[16:9 14.5M]	5152×2896
[16:9 2M ^{3/4}]	1920×1080
[1:1 15M]	3856×3856
[1:1 2.5M ^{3/4}]	1536×1536

* This item cannot be set in the Intelligent Auto Mode.

4:3 : Aspect ratio of a 4:3 TV

3:2 : Aspect ratio of a 35 mm film camera

16:9 : Aspect ratio of a high-definition TV, etc.

1:1 : Square aspect ratio

• In specific modes, Extended Optical Zoom cannot be used, and the picture size for [**3/4**] is not displayed.



For details regarding modes in which Extended Optical Zoom cannot be used, refer to P49.

• Pictures may appear mosaic depending on the subject and the recording conditions.

[Quality]

Applicable modes:  **P** **M**  **SCN**   

Set the compression rate at which the pictures are to be stored.

Settings	Description of settings
 ((Fine))	When giving priority to the picture quality
 ((Standard))	When using the standard picture quality and increasing the number of pictures to be recorded without changing the number of pixels

- The setting is fixed to  in the following cases.
 - [HDR]/[High Sens.] (Scene Mode)

[Sensitivity]

Applicable modes:  **P** **M**

This allows the Sensitivity to light (ISO sensitivity) to be set. Setting to a higher figure enables pictures to be taken even in dark places without the resulting pictures coming out dark.

Settings	Description of settings
[AUTO]	The ISO sensitivity is automatically adjusted according to the brightness. • Maximum [1600]
[ISO]	The ISO sensitivity is adjusted according to the movement of the subject and the brightness. • Maximum [1600]
[100]/[200]/[400]/[800]/[1600]	The ISO sensitivity is fixed to various settings.

	[100]  [1600]	
Recording location (recommended)	When it is light (outdoors)	When it is dark
Shutter speed	Slow	Fast
Noise	Less	Increased
Jitter of the subject	Increased	Less

- For the focus range of flash when [AUTO] is set, refer to [P53](#).
- You cannot select [AUTO] or [ISO] in Manual Exposure Mode.
- The ISO sensitivity is automatically set under the following conditions.
 - When recording motion pictures
 - When [Burst] is set to [C]H

[White Balance]

Applicable modes:       

In sunlight, under incandescent lights or in other such conditions where the color of white takes on a reddish or bluish tinge, this item adjusts to the color of white which is closest to what is seen by the eye in accordance with the light source.

Settings	Description of settings
[AWB] ([Auto White Balance])	Automatic adjustment
[☀] ([Daylight])	When taking pictures outdoors under a clear sky
[☁] ([Cloudy])	When taking pictures outdoors under a cloudy sky
[🏠] ([Shade])	When taking pictures outdoors in the shade
[💡] ([Incandescent])	When taking pictures under incandescent lights
[🖥] ([White Set])	Value set by using [🖥SET]
[🖥SET] ([White Set Setting])	Set manually

- Under fluorescent lighting, LED lighting fixture etc., the appropriate White Balance will vary depending on the lighting type, so use [AWB] or [🖥SET].
- The White Balance setting for a Scene Mode returns to [AWB] when the Scene Mode is changed.
- The setting is fixed to [AWB] in the following cases.
 - [Night Portrait]/[Night Scenery]/[Food]/[Sunset]/[Starry Sky] (Scene Mode)

■ Auto White Balance

Depending on the conditions prevailing when pictures are taken, the pictures may take on a reddish or bluish tinge. Furthermore, when a multiple number of light sources are being used or there is nothing with a color close to white, Auto White Balance may not function properly. In this case, set the White Balance to a mode other than [AWB].

- 1 Auto White Balance will work within this range
 - 2 Blue sky
 - 3 Cloudy sky (Rain)
 - 4 Shade
 - 5 Sunlight
 - 6 White fluorescent light
 - 7 Incandescent light bulb
 - 8 Sunrise and sunset
 - 9 Candlelight
- K=Kelvin Color Temperature

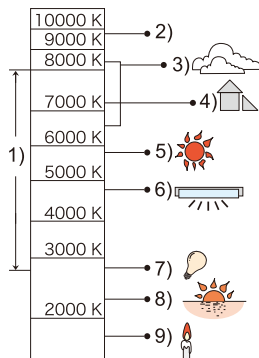

Setting the White Balance manually

Set the White Balance value. Use to match the condition when taking photographs.

- 1 Select [SET] and then press [MENU/SET].
- 2 Aim the camera at a sheet of white paper etc. so that the frame in the center is filled by the white object only and then press [MENU/SET].
 - White Balance may not be set when the subject is too bright or too dark. Set the White Balance again after adjusting to appropriate brightness.
 - Exit the menu after it is set.

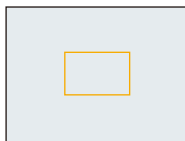

Finely adjusting the White Balance

You can finely adjust the White Balance when you cannot acquire the desired hue by setting the White Balance.

- Fine adjustment is possible only when the White Balance is set to [☼]/[🌙]/[🏠]/[🌄]/[🌃].

1 Select the White Balance to finely adjust and then press [DISP.] to display [WB Adjust.].

2 Press ◀/▶ to adjust the White Balance.

◀ ([Red]): Press when the hue is bluish.

▶ ([Blue]): Press when the hue is reddish.

- Select [0] to return to the original White Balance.





3 Press [MENU/SET] to finish.

- The White Balance icon on the screen turns red or blue.
- The White Balance fine adjustment setting is reflected in the picture when using the flash.
- You can finely adjust the White Balance independently for each White Balance item.
- The White Balance fine adjustment level in [🌃] returns to [0] when you reset the White Balance using [🌃SET].



[AF Mode]

Applicable modes: 

This allows the focusing method that suits the positions and number of the subjects to be selected.

Settings	Description of settings
 ([Face Detection])	The camera automatically detects the person's face. (max. 12 areas) The focus and exposure can then be adjusted to fit that face no matter what portion of the picture it is in.
 ([AF Tracking])*	Focus can be adjusted to a specified subject. Focus will keep on following the subject even if it moves. (Dynamic tracking)
 ([9-Area])*	Up to 9 points for each AF area can be focused. This is effective when the subject is not in the center of the screen. (AF area frame will be same as image aspect ratio setting.)
 ([1-Area])	The camera focuses on the subject in the AF area on the center of the screen.
 ([Spot]) ⁺	The camera focuses on a limited narrow area in the screen.

*  will be used during motion picture recording.

- The setting is fixed to  in the following cases.
 - [Starry Sky] (Scene Mode)
 - [Miniature Effect] (Creative Control Mode)
- It is not possible to set  in the following cases.
 - Panorama Shot Mode
 - [Night Scenery]/[Food] (Scene Mode)
 - [Soft Focus] (Creative Control Mode)
-  cannot be set in the following cases.
 - Panorama Shot Mode
 - [Sepia]/[Dynamic Monochrome]/[High Dynamic]/[Soft Focus] (Creative Control Mode)

■ About [👤] ([Face Detection])

The following AF area frames are displayed when the camera detects the faces.

Yellow:

When the shutter button is pressed halfway, the frame turns green when the camera is focused.

White:

Displayed when more than one face is detected. Other faces that are the same distance away as the faces within the yellow AF areas are also brought into focus.



- When [Metering Mode] is set to [☐], the camera will adjust the exposure to suit the person's face.
- Under certain picture-taking conditions including the following cases, the face detection function may fail to work, making it impossible to detect faces.
 - [AF Mode] is switched to [☐]. ([☐] while motion pictures are taken)
 - When the face is not facing the camera
 - When the face is at an angle
 - When the face is extremely bright or dark
 - When the facial features are hidden behind sunglasses, etc.
 - When the face appears small on the screen
 - When there is little contrast on the faces
 - When there is rapid movement
 - When the subject is not a human being
 - When the camera is shaking
 - When Digital Zoom is used
- If the camera is registering something other than someone's face, change the settings to something other than [👤].

■ Setting up [AF Tracking] ([AF Tracking])

Align the subject with the AF tracking frame, and then press **▼** to lock onto the subject.

- Ⓐ AF tracking frame
- AF area will be displayed in yellow when a subject is recognized, and focus will automatically adjust continuously following the subject's movement (Dynamic tracking).
- AF tracking is canceled when **▼** is pressed again.

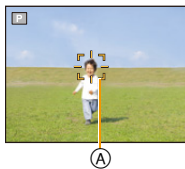

- Dynamic tracking function may not work in the following cases:
 - When the subject is too small
 - When the recording location is too dark or bright
 - When the subject is moving too fast
 - When the background has the same or similar color to the subject
 - When jitter is occurring
 - When using the zoom
- When the lock fails, the AF tracking frame will turn red and then disappear. Press **▼** again.
- The camera records pictures with [AF Mode] as [■] when locked or Dynamic Tracking is not working.

[Metering Mode]

Applicable modes: [AE-L/AF-L] [P] [M] [SCN] [ZOOM] [W] [R] [Circular Arrow]

Type of optical measurement to measure brightness can be changed.

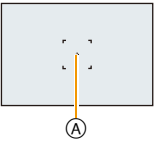
Settings	Description of settings
(Multiple)	This is the method in which the camera measures the most suitable exposure by judging the allocation of brightness on the whole screen automatically. Usually, we recommend using this method.
(Center weighted)	This is the method used to focus on the subject on the center of the screen and measure the whole screen evenly.
(Spot)	This is the method to measure the subject in the spot metering target Ⓐ . 

[i.Exposure]

Applicable modes:       

Contrast and exposure will be adjusted automatically when there is a big difference in brightness between the background and subject, to bring the image close to real life.

Settings: [ON]/[OFF]

- Compensation effect may not be achieved depending on the conditions.

[i.Zoom]

Applicable modes:       

Zoom magnification can be increased while minimizing deterioration of the image quality.

Settings: [ON]/[OFF]

- Refer to [P49](#) for details.

[Digital Zoom]

Applicable modes:       

This can enlarge subjects even more than the Optical Zoom, Extended Optical Zoom, or [i.Zoom].



Settings: [ON]/[OFF]

- Refer to [P49](#) for details.

[Burst]

Applicable modes:       

Pictures are taken continuously while the shutter button is pressed.

Settings	Description of settings		Maximum recordable pictures (pictures)
 ([Burst On])	Burst speed	approx. 1.1 picture/second	Approx. 200 pictures*
	<ul style="list-style-type: none"> • The burst speed becomes slower halfway. The exact timing of this depends on the type of card and the Picture Size. 		
 ([Hi-Speed Burst])	Burst speed	approx. 3 pictures/second	Approx. 200 pictures*
	<ul style="list-style-type: none"> • This can be set only during Program AE Mode. • The picture size is fixed to 3M (4:3), 2.5M (3:2), 2M (16:9) or 2.5M (1:1). • The Burst speed changes according to the recording conditions. • The number of Burst recording pictures are limited by the picture-taking conditions and the type and/or status of the card used. • The number of Burst recording pictures may increase when you use a card with fast writing speed or card is formatted. • The ISO sensitivity is automatically adjusted. However, the ISO sensitivity is increased to make the shutter speed become high-speed. 		
[OFF]	—		—

* The number of Burst recording pictures are limited by the picture-taking conditions and the type and/or status of the card used.

- Depending on the operating conditions, it may take time to take the next picture if you repeat the recording of pictures.
- **It may take time to save pictures taken in Burst Mode on the card. If you take pictures continuously while saving, the maximum number of recordable pictures decreases. For continuous shooting, use of a high speed memory card is recommended.**
- The burst speed (pictures/second) may become slower depending on the recording environment such as in dark places, if the ISO sensitivity is high, etc.
- The focus, zoom, exposure, White Balance, shutter speed and ISO sensitivity are fixed to the settings for the first picture.
- This function is not available in the following cases:
 - When using Auto Bracket
 - [HDR]/[Starry Sky] (Scene Mode)
 - [Toy Effect]/[Miniature Effect]/[Soft Focus]/[Star Filter] (Creative Control Mode)
- When the Self-Timer is used, the number of recordable pictures in Burst Mode is fixed to 3.
- **The flash setting is fixed to [ON].**

[AF Assist Lamp]

Applicable modes:  **P** **M**    

AF assist lamp will illuminate the subject when the shutter button is pressed halfway, making it easier for the camera to focus when recording in low light conditions.
(Larger AF area is displayed depending on the recording conditions.)

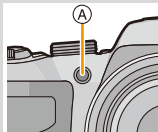

Settings: [ON]/[OFF]

- The effective distance of the assist lamp is approximately 1.5 m (4.9 feet).
- Depending on the state of the zoom or subject, the effective distance may become shorter.
- When you do not want to use the AF Assist Lamp  (e.g. when taking pictures of animals in dark places), set the [AF Assist Lamp] to [OFF]. In this case, it will become more difficult to focus on the subject.
- The setting is fixed to [OFF] in the following cases.
 - [Night Scenery]/[Sunset]/[Glass Through] (Scene Mode)



[Red-Eye Removal]

Applicable modes:        

When Red-Eye Reduction ([, [) is selected, Red-Eye Removal is performed whenever the flash is used. The camera automatically detects red-eye and corrects the picture.

Settings: [ON]/[OFF]

- This function works only when the camera detects a face.
- Under certain circumstances, red-eye cannot be corrected.

[Stabilizer]

Applicable modes:        

The camera detects jitter during recording and automatically corrects it, so you can record images with reduced jitter.

Settings: [ON]/[OFF]

- The setting is fixed to [ON] in the following case.
 - When recording motion pictures
- The setting is fixed to [OFF] in the following case.
 - [Starry Sky] (Scene Mode)
- The stabilizer function may not be effective in the following cases. Be careful of camera jitter when you press the shutter button.
 - When there is a lot of jitter.
 - When the zoom magnification is high.
 - In Digital Zoom range.
 - When taking pictures while following a moving subject.
 - When the shutter speed becomes slower to take pictures indoors or in dark places.

[Date Stamp]

Applicable modes:       

You can take a picture with date and time of recording.

Settings	Description of settings
[W/O TIME]	Stamp the year, month, and day.
[WITH TIME]	Stamp the year, month, day, hour, and minutes.
[OFF]	—

- Date information for pictures recorded with the [Date Stamp] set cannot be deleted.
- When printing pictures with [Date Stamp] at a shop or with a printer, the date will be printed on top of the other if you choose to print with the date.
- If the time has not been set, you cannot stamp with the date information.
- The setting is fixed to [OFF] in the following cases.
 - When recording motion pictures
 - When using Auto Bracket
 - When using [Burst].
- You can also set printing with the recording date (P107) by recording with [Date Stamp] set to [OFF].

Using the [Motion Picture] Menu

For details on [Motion Picture] menu settings, refer to P38.

- The [Motion Picture] menu is not displayed in the following cases.
 - [Soft Focus]/[Star Filter] (Creative Control Mode)

[Rec Quality]

Applicable modes:  **P** **M** **SCN**   

This sets up the picture quality of motion pictures.

Settings	Picture size	fps	Aspect ratio
[HD]	1280×720	30	16:9
[VGA]	640×480		4:3
[QVGA]	320×240		

- When recording to the built-in memory, [Rec Quality] is fixed to [QVGA].

[Continuous AF]

Applicable modes:  **P** **M** **SCN**   







It will continually keep on focusing on a subject for which the focus was once set.

Settings: [ON]/[OFF]





- Set this function to [OFF] if you wish to fix the focus on the position where you started the motion picture recording.
- The setting is fixed to [OFF] in the following case.
 - [Starry Sky] (Scene Mode)

Various methods of playback

You can play back the recorded pictures in various methods.

- 1** Press .
- 2** Press [MENU/SET].
- 3** Press /// to select [Playback Mode], and then press [MENU/SET].
- 4** Press / to select item, and then press [MENU/SET].

- Following items can be selected.

	((Normal Play)) (P35)
	((Slide Show)) (P90)
	((Category Selection)) (P92)
	((Calendar)) (P93)

[Slide Show]

You can play back the pictures you have taken in sequence at specified intervals. This playback method is recommended when you have connected the camera to a TV set to view the pictures you have taken.

1 Select the group to play back by pressing ▲/▼, and then press [MENU/SET].

- During [Category Selection], press ▲/▼/◀/▶ to select a category, and then press [MENU/SET]. Refer to [P92](#) for category details.

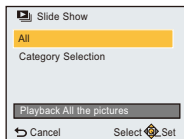

2 Press ▲ to select [Start] and then press [MENU/SET].

■ Operations during slide show

The cursor displayed during playback is the same as ▲/▼/◀/▶.

	▲	Play/Pause
	▼	Stop
	◀	Back to previous picture (while pausing)
	▶	Ahead to next picture (while pausing)

■ Changing the slide show settings

You can change the settings for Slide Show Playback by selecting [Effect] or [Setup] on the slide show menu screen.

[Effect]

Screen effects can be added to picture transitions.

[ON]/[OFF]

- When playing back a panorama picture, the [Effect] setting is disabled.

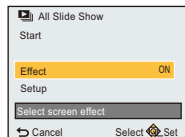

[Setup]

[Duration] or [Repeat] can be set.

Settings	Description of settings
[Duration]	[1 SEC.]/[2 SEC.]/[3 SEC.]/[5 SEC.]
[Repeat]	[ON]/[OFF]

- [Duration] can be set only when [OFF] has been selected as the [Effect] setting.
- When playing back a panorama picture, the [Duration] setting is disabled.

- Motion pictures cannot be played back as a slide show. When [🎬] (motion picture) is selected in [Category Selection], the first frames of the motion pictures are displayed as still pictures in a slide show.

[Category Selection]







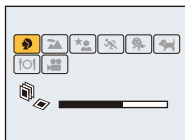

This mode allows you to search images by Scene Mode or other categorize (such as [Soft Skin], [Sports] or [Night Scenery]) and sort the pictures into each of the categorize. You can then play back the pictures in each category.

Press ▲/▼/◀/▶ to select the category and then press [MENU/SET] to set.

- You can play back only the category in which an image has been found.



■ About the categorize to be sorted

Category	Recording information e.g. Scene Modes
	[i-Portrait]/[Soft Skin]/[Night Portrait]/[i-Night Portrait]/[Baby1]/[Baby2]/Portrait Mode
	Panorama Shot Mode/[i-Scenery]/[Sunset]/[i-Sunset]/[Glass Through]/Scenery Mode
	[Night Portrait]/[i-Night Portrait]/[Night Scenery]/[i-Night Scenery]/[Starry Sky]
	[Sports]
	[Baby1]/[Baby2]
	[Pet]
	[Food]
	[Motion Picture]

- If you run a Calendar Search, Category Selection will be canceled.

[Calendar]

You can search for images by recorded date.

1 Press **▲/▼/◀/▶** to select the date you want to search.



2 Press **[MENU/SET]** to display a list of pictures.

- Pictures are displayed with Multi Playback (30 screens).
The cursor appears on the picture at the beginning of the selected date.

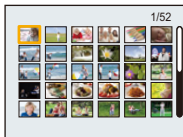

3 Press **▲/▼/◀/▶** to select a picture and then press **[MENU/SET]**.

- To continue the search, return to the previous screen by rotating the zoom lever towards [W]. (P36)

- The recording date of the picture selected in the playback screen becomes the date selected when the calendar screen is first displayed.
- You can display the calendar between January 2000 and December 2009.
- If the date is not set in the camera, the recording date is set as January 1st, 2014.
- If you take pictures after setting the travel destination in [World Time], the pictures are displayed by the dates at the travel destination in Calendar Playback.

Having Fun with Recorded Pictures ([Creative Retouch])

You can add your desired effects to the pictures that you have taken.

- The processed pictures are newly generated, so be sure that you have enough space in the built-in memory or on the card. Note also that processing will not be possible if the Write-Protect switch of the card is in the [LOCK] position.
- Effects may be difficult to see depending on the picture.

1 Press ◀/▶ to select a picture, and then press ▲.

2 Press ▲/▼ to select image effects and then press [MENU/SET].

- Image effects that are the same as the ones in Creative Control Mode can be added. (P69–73)
- A brief description of selected image effect appears when you press [DISP].
- To set the color you want to keep by using [One Point Color], move the frame at the center of the screen to the desired color with ▲/▼/◀/▶, and then press [MENU/SET].
- If you select [No Effect], an image with no effect is displayed. To proceed the retouch operation, select another image effect. If you are not going to add any effect, exit the menu.
- Confirmation screen is displayed. It is executed when [Yes] is selected.



■ When selecting [Creative Retouch] from the [Playback] menu

1 Select [Creative Retouch] on the [Playback] menu. (P38)

2 Press ◀/▶ to select a picture, and then press [MENU/SET].

3 Press ▲/▼ to select image effects and then press [MENU/SET].

- Confirmation screen is displayed. It is executed when [Yes] is selected.

- The image effect may appear weak compared to the effect given by the Creative Control Mode.
- The preview display and the image after the retouch operation may differ in the level of effects.
- This function is not available in the following cases:
 - Motion pictures
 - Pictures taken in Panorama Shot Mode

Using the [Playback] Menu

For details on [Playback] menu settings, refer to [P38](#).

You can perform actions like cropping recorded pictures, as well as set up the protection of recorded images, etc.

- With [Creative Retouch], [Resize] or [Cropping], a new edited picture is created.
A new picture cannot be created if there is no free space on the built-in memory or the card so we recommend checking that there is free space and then editing the picture.
- Images recorded or edited with the camera may not be played back correctly on other devices and applied effects may not appear on the devices.
Also, images recorded on other devices may not be played back on the camera and functions of the camera may not be available for the images.

[Creative Retouch]

You can add the effect of [Creative Retouch] to recorded pictures.

- For details, refer to [P94](#).

[Resize]

To allow easy posting to web pages, attachment to email etc., picture size (number of pixels) is reduced.

- 1 Select [Resize] on the [Playback] menu.
- 2 Press ▲/▼ to select [SINGLE] or [MULTI] and then press [MENU/SET].
- 3 Select the picture and size.

[SINGLE] setting

- 1 Press ◀/▶ to select the picture, and then press [MENU/SET].
- 2 Press ◀/▶ to select the size, and then press [MENU/SET].

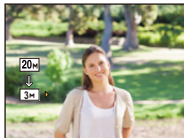

[MULTI] setting

- 1 Press ▲/▼ to select the size, and then press [MENU/SET].
- 2 Press ▲/▼/◀/▶ to select the picture, and then press [DISP.].



- If you press [DISP.] again, the setting is canceled.
 - Repeat this step for each picture, and press [MENU/SET] to set.
- Confirmation screen is displayed.
It is executed when [Yes] is selected.
Exit the menu after it is executed.

- You can set up to 50 pictures at one time in [MULTI].
- The picture quality of the resized picture will deteriorate.
- This function is not available in the following cases:
 - Motion pictures
 - Pictures taken in Panorama Shot Mode
 - Pictures with date stamped

[Cropping]

You can enlarge and then clip the important part of the recorded picture.

- 1** Select **[Cropping]** on the **[Playback]** menu.
- 2** Press **◀/▶** to select the picture, and then press **[MENU/SET]**.
- 3** Use the zoom lever and press **▲/▼/◀/▶** to select the parts to be cropped.



Zoom lever (W):	Reduction
Zoom lever (T):	Enlargement
▲/▼/◀/▶:	Move

- 4** Press **[MENU/SET]**.

- Confirmation screen is displayed.
It is executed when [Yes] is selected.
Exit the menu after it is executed.

- The picture quality of the cropped picture will deteriorate.
- Small size pictures may not be cropped.
- This function is not available in the following cases:
 - Motion pictures
 - Pictures taken in Panorama Shot Mode
 - Pictures with date stamped

[Protect]

You can set protection for pictures you do not want to be deleted by mistake.

- 1** Select **[Protect]** on the **[Playback]** menu.
- 2** Press **▲/▼** to select **[SINGLE]** or **[MULTI]** and then press **[MENU/SET]**.
- 3** Select the picture, and then press **[MENU/SET]**.

- The settings are canceled when **[MENU/SET]** is pressed again.
- Exit the menu after it is set.

[SINGLE]**[MULTI]**

■ Canceling all the **[Protect]** settings

- 1** Select **[Protect]** on the **[Playback]** menu.
- 2** Press **▲/▼** to select **[CANCEL]** and then press **[MENU/SET]**.

- Confirmation screen is displayed.
It is executed when **[Yes]** is selected.
Exit the menu after it is executed.

- Even if you protect pictures in the built-in memory or a card, they will be deleted if the built-in memory or the card is formatted.

[Copy]

You can copy the data of the pictures you have taken from the built-in memory to a card or from a card to the built-in memory.

- 1 Select [Copy] on the [Playback] menu.**
- 2 Press ▲/▼ to select the copy destination and then press [MENU/SET].**

[IN→SD] ([IN→SD]): All the picture data in the built-in memory are copied onto the card at one time.

[SD→IN] ([SD→IN]): One picture at a time is copied from the card to the built-in memory.

Press ◀/▶ to select the picture and then press [MENU/SET].

- Confirmation screen is displayed.
It is executed when [Yes] is selected.
Exit the menu after it is executed.
- Do not turn the camera off at any point during the copying process.

- If a picture exists with the same name (folder number/file number) as the picture to be copied in the copy destination when **[SD→IN]** is selected, that picture is not copied.
- It may take time to copy the picture data.
- [Protect] settings will not be copied. Set them again after copying has finished.

Playing Back Pictures on a TV Screen

Pictures recorded with this unit can be played back on a TV screen.

Preparations:

Set the [TV Aspect]. (P46)

Turn this unit and the TV off.

1 Connect the camera and a TV.

- Check the directions of the connectors, and plug them straight in or unplug them straight out. (Otherwise the connectors may bend out of shape, which may cause malfunction.)
- Always use a genuine Panasonic AV cable (DMW-AVC1: optional).

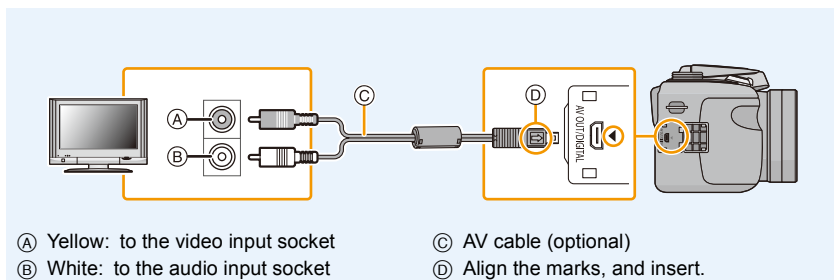

2 Turn the TV on and select external input.

3 Turn the camera on and then press [▶].

- Depending on the [Picture Size], black bands may be displayed on the top and bottom or the left and right of the pictures.
- Change the screen mode on your TV if the picture is displayed with the top or bottom cut off.
- When pictures are displayed, they may not be displayed properly depending on the type of TV.
- If you perform Multi Playback or Playback Zoom on a TV screen with an aspect ratio of 16:9, images may appear distorted when you play them back.
- You can view pictures on TVs in other countries (regions) which use the NTSC or PAL system when you set [Video Out] in the [Setup] menu.
(PAL video out is not available on the version DMC-LZ40P sold in the U.S. and the version DMC-LZ40PC sold in Canada.)
- No sound is output from the camera speakers. Also, pictures are not displayed on the monitor.
- When the camera is connected to the TV with an AV cable, motion pictures recorded in [HD] are not displayed in the HD picture quality.
- Read the operating instructions for the TV.

The recorded still pictures can be played back on a TV with an SD Memory Card slot.

- Depending on the TV model, pictures may not be displayed on the full screen.
- The file format of the motion pictures that can be played back differs depending on the TV model.
- In some cases, panorama pictures cannot be played back. Also, auto-scroll playback of panorama pictures may not work.
- For cards compatible with playback, refer to the operating instructions of the TV.

Saving still pictures and motion pictures on your PC

You can transfer the pictures in the camera to a PC by connecting the camera and the PC.

- Some PCs can read directly from the card removed from the camera. For details, refer to the operating instructions of your PC.
- **If the computer being used does not support SDXC Memory Cards, a message prompting you to format may appear.**
(Doing so will cause recorded images to be erased so do not choose to format.)
If the card is not recognized, please refer to the below support site.
<http://panasonic.net/avc/sdcard/information/SDXC.html>

■ PC that can be used (OS)

The unit can be connected to any PC capable of recognizing a mass storage device.

- Windows support: Windows® XP/Windows Vista®/Windows® 7/Windows® 8/Windows® 8.1
- Mac support: OS X v10.5 to v10.9

■ Playback and editing on a PC

Software for image playback or editing is not supplied with this product.

To play back or edit still pictures or to play back motion pictures, use the following software:

Software for still pictures

- For Windows: Microsoft® Windows Photo Viewer/Windows Photo Gallery/Windows Live® Photo Gallery (online service)
- For Mac: iPhoto, provided by Apple

Software for motion pictures

- Software supporting Motion JPEG format.
- The software information above is current as of January 2014. The software specifications are subject to changes without prior notice, and do not guarantee that the software will continue to operate in the future.
- To play back motion pictures, use standard software.
 - If software is not installed on your PC, download it from the website of the software provider.
 - For information on how to use software, contact the software provider.

Transferring images to a PC

1 Connect the computer and camera with the USB connection cable (supplied).

- Please turn this unit on and your PC before connecting.
- Check the directions of the connectors, and plug them straight in or unplug them straight out. (Otherwise the connectors may bend out of shape, which may cause malfunction.)
- Do not use any other USB connection cables except the supplied one or a genuine Panasonic USB connection cable (DMW-USBC1: optional).

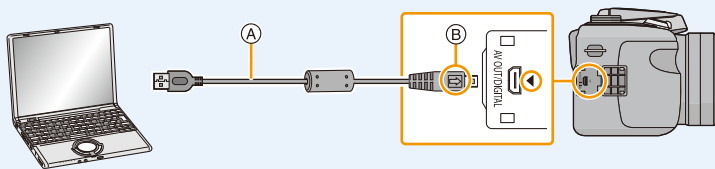

- Ⓐ USB connection cable (supplied)
- Ⓑ Align the marks, and insert.

2 Press ▲/▼ to select [PC], and then press [MENU/SET].

- For Windows: A drive ([Removable Disk]) is displayed in [Computer]
- For Mac: A drive ([NO_NAME]) is displayed on the desktop

3 Drag and drop files and folders in the camera to the PC.

- When the image transfer is complete, disconnect the USB connection cable safely.

- If the remaining battery power becomes low while the camera and the PC are communicating, the alarm beeps.
Disconnect the USB connection cable safely. Otherwise, data may be destroyed.
- Before inserting or removing a card, turn the camera off and disconnect the USB connection cable.
Otherwise, data may be destroyed.

About the folder structure of the camera

The content (folder structure) of the built-in memory of the camera/the card is displayed on a PC as follows:

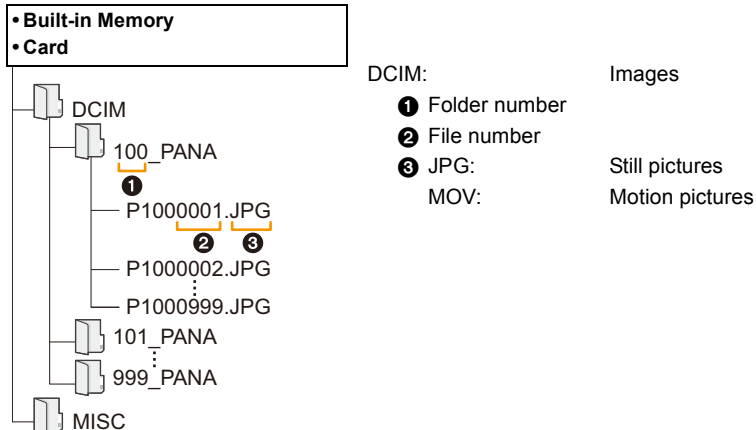

- A new folder is created when pictures are taken in the following situations.
 - When a card containing a folder with the same folder number has been inserted (Such as when pictures were taken using another maker of camera)
 - When there is a picture with file number 999 inside the folder

Connection in the PTP Mode

Select [PictBridge(PTP)] when connecting USB connection cable.

- Data can now be read only from the card in the PC.
- When there are 1000 or more pictures on a card, the pictures may not be imported in the PTP Mode.
- Motion picture cannot be played back in PTP Mode.

Printing the Pictures

If you connect the camera to a printer supporting PictBridge, you can select the pictures to be printed out and instruct that printing be started on the camera's monitor.

- Some printers can print directly from the card removed from the camera. For details, refer to the operating instructions of your printer.

Preparations:

Turn on the camera and the printer.

Remove the card before printing the pictures from the built-in memory.

Check print quality and other settings on the printer before printing the pictures.

1 Connect the printer and camera with the USB connection cable (supplied).

- Check the directions of the connectors, and plug them straight in or unplug them straight out. (Otherwise the connectors may bend out of shape, which may cause malfunction.)
- Do not use any other USB connection cables except the supplied one or a genuine Panasonic USB connection cable (DMW-USBC1: optional).

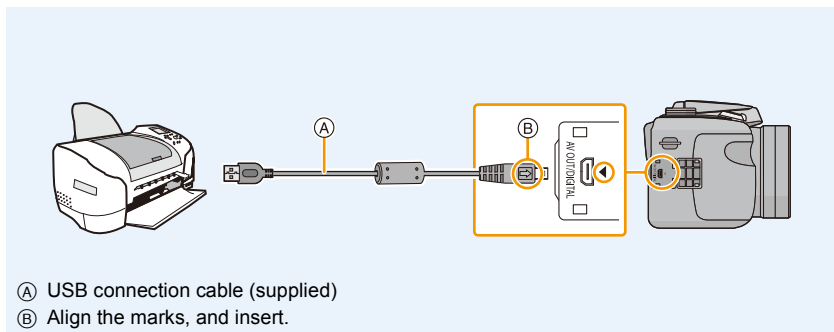

2 Press $\blacktriangle/\blacktriangledown$ to select [PictBridge(PTP)], and then press [MENU/SET].

- If the remaining battery power becomes low while the camera and the printer are connected, the alarm beeps. If this happens during printing, stop printing at once. If not printing, disconnect the USB connection cable.
- Disconnect the USB cable only after you turn off the camera.
- Do not disconnect the USB connection cable while $\left[\text{Cable disconnect prohibit icon} \right]$ (Cable disconnect prohibit icon) is displayed. (May not be displayed depending on the type of printer used)
- Before inserting or removing a card, turn the camera off, and disconnect the USB connection cable.
- Motion pictures cannot be printed out.

Selecting a single picture and printing it

1 Press ◀/▶ to select the picture and then press [MENU/SET].



2 Press ▲ to select [Print start] and then press [MENU/SET].

- Refer to P107 for the items which can be set before starting to print the pictures.
- Disconnect the USB connection cable after printing.

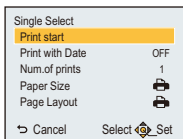

Selecting multiple pictures and printing them

1 Press ▲.

2 Press ▲/▼ to select an item and then press [MENU/SET].

[Multi Select]	<p>Multiple pictures are printed at one time.</p> <ul style="list-style-type: none"> • Press ▲/▼/◀/▶ to select the still pictures, and then press [DISP.]. (When [DISP.] is pressed again, the setting is canceled.) • After the still pictures have been selected, press [MENU/SET].
[Select All]	<p>Prints all the stored pictures.</p> <ul style="list-style-type: none"> • When 1000 or more images are stored, 999 images will be printed, starting from the newest one.

3 Press ▲ to select [Print start] and then press [MENU/SET].

- If the print check screen has appeared, select [Yes], and print the pictures.
- Refer to P107 for the items which can be set before starting to print the pictures.
- Disconnect the USB connection cable after printing.

Print Settings

Select and set the items both on the screen in step 2 of the “Selecting a single picture and printing it” and in step 3 of the “Selecting multiple pictures and printing them” procedures.

- When you want to print pictures in a paper size or a layout which is not supported by the camera, set [Paper Size] or [Page Layout] to  and then set the paper size or the layout on the printer. (For details, refer to the operating instructions of the printer.)

[Print with Date]

[ON]	Date is printed.
[OFF]	Date is not printed.

- If the printer does not support date printing, the date cannot be printed on the picture.
- Depending on the printer, the date print settings of the printer may take precedence so check if this is the case.
- When printing images with [Date Stamp], please remember to set [Print with Date] to [OFF] or the date will print on top.

When asking the photo shop to print the pictures

- By stamping the date using [Date Stamp] (P87) before going to a photo shop, the dates can be printed at the photo shop.

[Num.of prints]





You can set the number of prints up to 999.

[Paper Size]

	Settings on the printer are prioritized.
[L/3.5"×5"]	89 mm×127 mm
[2L/5"×7"]	127 mm×178 mm
[POSTCARD]	100 mm×148 mm
[16:9]	101.6 mm×180.6 mm
[A4]	210 mm×297 mm
[A3]	297 mm×420 mm
[10×15cm]	100 mm×150 mm
[4"×6"]	101.6 mm×152.4 mm
[8"×10"]	203.2 mm×254 mm
[LETTER]	216 mm×279.4 mm
[CARD SIZE]	54 mm×85.6 mm

• Paper sizes not supported by the printer will not be displayed.

[Page Layout] (Layouts for printing that can be set with this unit)

	Settings on the printer are prioritized.
	1 picture with no frame on 1 page
	1 picture with a frame on 1 page
	2 pictures on 1 page
	4 pictures on 1 page

- An item cannot be selected if the printer does not support the page layout.

■ Layout printing**When printing a picture several times on 1 sheet of paper**

For example, if you want to print the same picture 4 times on 1 sheet of paper, set [Page Layout] to  and then set [Num.of prints] to 4 for the picture that you want to print.

When printing different pictures on 1 sheet of paper

For example, if you want to print 4 different pictures on 1 sheet of paper, set [Page Layout] to  and then set [Num.of prints] to 1 for each of the 4 pictures.

- The camera is receiving an error message from the printer when the  indication lights orange during printing. After finishing printing, make sure there are no problems with the printer.
- If the number of prints is high, the pictures may be printed several times. In this case, the remaining number of prints indicated may differ from the number set.

Screen Display

In recording

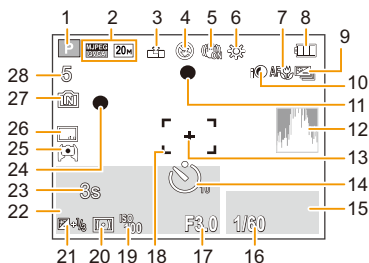



- | | | | |
|----|--|----|---|
| 1 | Recording Mode | 18 | AF area (P31) |
| 2 | Recording Quality (P88) | 19 | ISO sensitivity (P76) |
| | Picture Size (P74) | 20 | Metering Mode (P82) |
| 3 | Quality (P75) | 21 | Exposure compensation (P56) |
| 4 | Flash (P50) | | AF Tracking (P82): |
| 5 | Optical Image Stabilizer (P86) | | AF assist lamp (P85): AF* |
| | Jitter alert (P24): | 22 | Age (P65) |
| 6 | White Balance (P77) | | Current date and time |
| | Creative control adjustment display (P68): | | World Time (P41): |
| | | | Zoom (P48): |
| 7 | AF Macro Mode (P54) | 23 | Elapsed recording time (P33): 8m30s* |
| | Macro Zoom Mode (P54): | 24 | Recording state (P33) |
| 8 | Battery indication (P14) | 25 | Monitor Luminance (P42) |
| 9 | Auto Bracket (P57) | | Monitor power save (P44): |
| | Burst (P84): | 26 | Date Stamp (P87) |
| 10 | Intelligent Exposure (P83) | 27 | Built-in memory (P19) |
| 11 | Focus (P31) | | Card (P19) (displayed only during recording): |
| 12 | Histogram (P43) | 28 | Number of recordable pictures (P21) |
| 13 | Spot Metering Target (P82) | | Available recording time (P21, |
| 14 | Self-timer (P55) | | 33): R8m30s* |
| 15 | AF tracking operation (P82) | | |
| 16 | Shutter speed (P30) | | |
| 17 | Aperture value (P30) | | |

* h: hour, m: minute, s: second

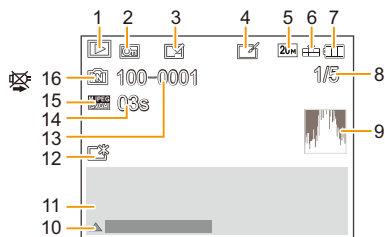
In playback



- | | |
|--|---|
| <p>1 Playback Mode (P89)</p> <p>2 Protected picture (P98)</p> <p>3 Date stamped display (P87)</p> <p>4 After Creative Retouch (P94)</p> <p>5 Picture Size (P74)</p> <p>6 Quality (P75)</p> <p>7 Battery indication (P14)</p> <p>8 Picture number
Total pictures
Elapsed playback time (P35): 08m30s*</p> <p>9 Histogram (P43)</p> <p>10 Creative Retouch (P94)
Motion picture playback (P35)
Play panorama (P61)</p> | <p>11 Recorded date and time
World Time (P41): </p> <p>Recording information (P47)
Age (P65)</p> <p>12 Power Monitor (P42)
Monitor power save (P44): </p> <p>13 Folder/File number (P104)</p> <p>14 Motion picture recording time
(P35): 08m30s*</p> <p>15 Recording Quality (P88)</p> <p>16 Built-in memory (P19)
Cable disconnect prohibit icon (P105)</p> <p>* h: hour, m: minute, s: second</p> |
|--|---|

- The information of images recorded with other devices, such as their icons or recording information, may not be displayed correctly. In addition, the functions of the camera may not be available for them.

Message Display

Confirmation messages or error messages will be displayed on the screen in some cases. The major messages are described below as examples.

[This picture is protected]

- Delete the picture after canceling the protect setting. (P98)

[Some pictures cannot be deleted]/[This picture cannot be deleted]

- Pictures not based on the DCF standard cannot be deleted.
Perform formatting (P46) on this unit after saving necessary data on a PC, etc.

[Built-in memory full. Please insert memory card.]/[Memory card full]/[Not enough space on built-in memory]/[Not enough memory on the card]

- There is no space left on the built-in memory or the card.
- When you copy pictures from the built-in memory to the card (batch copy), the pictures are copied until the capacity of the card becomes full.

[Some pictures cannot be copied]/[Copy could not be completed]

- The following pictures cannot be copied.
 - When a picture with the same name as the picture to be copied exists in the copy destination. (Only when copying from a card to the built-in memory.)
 - Pictures not based on the DCF standard.

[Built-In Memory Error]/[Format built-in memory?]

- This message will be displayed when you format the built-in memory on a PC.
Format the built-in memory on the camera again. (P46)
The data on the built-in memory will be deleted.

[Memory card error. This card cannot be used in this camera. Format this card?]

- It is a format that cannot be used with this unit.
 - Insert a different card and try again.
 - Reformat on this unit (P46) after saving necessary data using a PC, etc.
Data will be deleted.

[Please turn camera off and then on again]/[System Error]

- This is displayed when the lens has stopped operating normally due to being pressed on by a hand etc.
Turn the camera off and on. If the message persists, contact the dealer or Panasonic.

[Memory Card Error]/[This memory card cannot be used]

- Use a card compatible with this unit. (P19)

[Insert SD card again]/[Try another card]

- An error has occurred accessing the card.
Insert the card again.
- Insert a different card.

**[Read Error/Write Error
Please check the card]**

- It has failed to read or write data.
Remove the card after turning this unit off. Insert the card again, turn this unit on, and try to read or write the data again.
- The card may be broken.
- Insert a different card.

[Motion recording was cancelled due to the limitation of the writing speed of the card]

- Use a card with SD Speed Class with "Class 6" or higher when recording motion pictures.
- In the event that it stops even after using a "Class 6" card or higher, the data writing speed has deteriorated so it is recommended to make a backup and then format (P46).
Depending on the type of the card, motion picture recording may stop in the middle.

[A folder cannot be created]

- A folder cannot be created because there are no remaining folder numbers that can be used.
Format the card on this unit after saving necessary data on a PC etc. (P46)

[This battery cannot be used]

- Use a genuine Panasonic battery. If this message is displayed even when a genuine Panasonic battery is used, contact the dealer or Panasonic.
- If the battery terminal is dirty, clean it and remove any objects.

Troubleshooting

First, try out the following procedures (P114–122).

If the problem is not resolved, **it may be improved by selecting [Reset] (P45) on the [Setup] menu.**

Battery and power source

The charging lamp blinks.

- This phenomenon occurs when charging in a location where the temperature is very high or very low.
 - Reconnect the USB connection cable (supplied) in a location where the ambient temperature (and the temperature of battery) is in a 10 °C to 30 °C (50 °F to 86 °F) range, and try charging again.

Cannot charge the battery.

- Disconnect the USB connection cable (supplied) and connect it again.
- If your PC is not capable of supplying sufficient power, charging is not possible.

The camera cannot be operated even when it is turned on.

The camera turns off immediately after it is turned on.

- The battery is exhausted.
 - Charge the battery.
- If you leave the camera on, the battery will be exhausted.
 - Turn the camera off frequently by using the [Economy]. (P44)

Card/battery door does not close.

- Insert the battery securely all the way in. (P12)

Recording

The picture cannot be recorded.

- Is there any memory remaining on the built-in memory or the card?
→ Delete the pictures which are not necessary to increase available space in the memory. (P37)
- You may not be able to record for a short while after turning this unit on when using a large capacity card.

The recorded picture is whitish.

- The picture can become whitish if there is dirt, e.g. fingerprints on the lens.
→ Lightly wipe the surface of the lens with a soft, dry cloth before and after taking pictures.

The recorded picture is too bright or dark.

- Check that the exposure is correctly compensated. (P56)

Multiple pictures are taken at one time.

- Set [Auto Bracket] (P57) or [Burst] (P84) of the [Rec] menu to [OFF].

The subject is not focused properly.

- The focus range varies depending on the Recording Mode.
→ Set to the proper mode for the distance to the subject.
- The subject is beyond the focus range of the camera. (P31)
- There is camera shake (jitter) or the subject is moving slightly. (P24)

The recorded picture is blurred.

The Optical Image Stabilizer is not effective.

- The shutter speed becomes slower when pictures are taken in dark places so hold the camera firmly with both hands to take the pictures. (P24)
- When taking pictures at a slow shutter speed, use the Self-timer. (P55)

Taking pictures using Auto Bracket is not possible.

- Is there any memory remaining on the built-in memory or the card?

The recorded picture looks rough.**Noise appears on the picture.**

- Is the ISO sensitivity high or the shutter speed slow?
(ISO sensitivity is set to [AUTO] when the camera is shipped. Therefore, when taking pictures indoors etc. noise will appear.)
→ Decrease the ISO sensitivity. (P76)
→ Take pictures in bright places.
- Have you set [High Sens.] in Scene Mode, or [Burst] in [Rec] menu to [□H]?
If so, the resolution of the recorded picture decreases slightly because of high sensitivity processing, but this is not a malfunction.

The brightness or the hue of the recorded picture is different from the actual scene.

- When recording under fluorescent or LED lighting fixture etc., increasing the shutter speed may introduce slight changes to brightness and color. These are a result of the characteristics of the light source and do not indicate a malfunction.

When recording pictures or half-pressing the shutter button, reddish stripes may appear on the monitor. Alternatively, part or all of the monitor may turn a reddish color.

- This is a characteristic of CCDs, and it appears when the subject has a bright part. Some unevenness may occur in the surrounding areas, but this is not a malfunction.
It is recorded in motion pictures but is not recorded on still pictures.
- It is recommended that when you take pictures you take care not to expose the screen to sunlight or any other source of strong light.

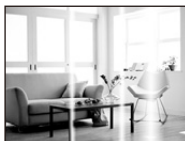
**Motion picture recording stops in the middle.**

- Use a card with SD Speed Class with “Class 6” or higher when recording motion pictures.
- Depending on the type of the card, recording may stop in the middle.
→ If motion picture recording stops during use of a card of at least “Class 6” or if you use a card that has been formatted on a PC or other equipment, the data-writing speed is lower. In such cases, we recommend that you make a backup of the data and then format (P46) the card in this unit.

Subject cannot be locked.**(AF tracking not possible)**

- Set the AF area to the distinctive color of the subject if there is a part that is different from the surrounding color. (P82)

Recording by Panorama Shot Mode is ended before finishing.

- If the camera is moved too slowly, the camera assumes that camera motion was stopped and ends the still picture recording.
- If there is a lot of camera shake in the recording direction while moving the camera, recording ends.
→ When recording in Panorama Shot Mode, try to trace a small half-circle parallel to the recording direction, taking about 4 seconds to complete the half-circle (approximate).

The Burst speed is slow.

- Depending on the operating conditions, it may take time to take the next picture if you repeat the recording of pictures.
- It may take time to save pictures taken in Burst Mode on the card. If you take pictures continuously while saving, the maximum number of recordable pictures decreases. For continuous shooting, use of a high speed memory card is recommended.
- The burst speed (pictures/second) may become slower depending on the recording environment such as in dark places, if the ISO sensitivity is high, etc.
- The burst speed becomes slower halfway.
The exact timing of this depends on the type of card and the Picture Size.

Monitor**The monitor becomes darker or brighter for a moment.**

- This phenomenon appears when you press the shutter button halfway to set the aperture value and does not affect the recorded pictures.
- This phenomenon also appears when the brightness changes when the camera is zoomed or when the camera is moved. This is because of operation of the automatic aperture of the camera, and it is not a malfunction.

The monitor flickers indoors.

- The monitor may flicker for a few seconds after turning this unit on. This is an operation to correct flicker caused by lighting such as fluorescent lights, LED lights etc. and is not a malfunction.

The monitor is too bright or dark.

- Is [Monitor Luminance] active? (P42)
- Perform [Monitor Display]. (P42)

Black, red, blue and green dots appear on the monitor.

- This is not a malfunction. These pixels do not affect the recorded pictures.

Noise appears on the monitor.

- In dark places, noise may appear to maintain the brightness of the monitor.
This does not affect the pictures you are recording.

Flash

The flash is not activated.

- Is the flash closed?
 - Open the flash. (P50)
- The flash cannot be used in the following cases:
 - When using Auto Bracket (P57)
 - Panorama Shot Mode (P59)
 - [Night Scenery]/[HDR]/[Sunset]/[Starry Sky]/[Glass Through] (Scene Mode) (P62)
 - Scenery Mode (P67)
 - Creative Control Mode (P68)
 - When recording in [Burst] (P84)

Flash is activated several times.

- The flash is activated twice when Red-Eye Reduction (P51) has been set.

Playback

The picture is not played back.

The recorded pictures are not displayed.

- Is there a picture on the built-in memory or the card?

The pictures on the built-in memory appear when a card is not inserted. The picture data on the card appears when a card is inserted.
- Is this a folder or picture which was processed in the PC?

If it is, it cannot be played back by this unit.
- Has [Category Selection] been set for playback?
 - Change to [Normal Play]. (P89)

The folder number and the file number are displayed as [—] and the screen turns black.

- Is this a non-standard picture, a picture which has been edited using a PC or a picture which was taken by another maker of digital cameras?
- Did you remove the battery immediately after picture-taking or did you take the picture using a battery with a low remaining charge?
 - Format the data to delete the pictures mentioned above. (P46)
 - (Other pictures will be deleted as well and it will not be possible to restore them. Therefore, check well before formatting.)

With a Calendar Search, pictures display dates differing from the actual dates on which the pictures were taken.





- Is the clock in the camera set properly? (P22)
- When pictures edited using a PC or pictures taken by other equipment are searched, they may display dates differing from the actual dates on which the pictures were taken.

White round spots like soap bubbles appear on the recorded picture.

- If you take a picture with the flash in a dark place or indoors, white round spots may appear on the picture caused by the flash reflecting off of particles of dust in the air. This is not a malfunction.



Red part of the recorded image has changed color to black.

- When Red-Eye Removal ([, [) is in operation, if you take a picture of a subject with red color surrounded by a skin tone color, that red part may be corrected to black by the Red-Eye Removal function.
→ It is recommended to take a picture with the flash setting set to [, [, or [, or [Red-Eye Removal] on the [Rec] menu set to [OFF]. (P86)

[Thumbnail is displayed] appears on the screen.

- Is it a picture that has been recorded with other equipment?
In such cases, these pictures may be displayed with a deteriorated picture quality.

The sound of the recorded motion pictures sometimes breaks up.

- This unit automatically adjusts the aperture during motion picture recording. At such times, the sound may break up. This is not a malfunction.

TV, PC and printer

The picture does not appear on the television.

- Is the camera connected to the TV correctly?
→ Set the TV input to External Input Mode.

The display areas on the TV screen and the camera's monitor are different.

- Depending on the TV model, the pictures may be elongated horizontally or vertically or they may be displayed with their edges cut off.

The motion pictures cannot be played back on a TV.

- Are you trying to play back the motion pictures by directly inserting the card in the card slot of the TV?
→ Connect the camera to the TV with the AV cable (optional) and then play back the pictures on the camera. (P100)

The picture is not displayed fully on the TV.

- Check [TV Aspect] setting. (P46)

Cannot communicate with the PC.

- Is the camera connected to the PC correctly?
- Is the camera recognized by the PC correctly?
→ Select [PC] when connecting. (P103)
→ Turn this unit off and on.

The card is not recognized by the PC. (The built-in memory is recognized.)

- Disconnect the USB connection cable. Connect it again while the card is inserted in the camera.
- If there are two or more USB terminal on a single PC, try connecting the USB connection cable to another USB terminal.

The card is not recognized by the PC. (SDXC memory card is used)

- Check if your PC is compatible with SDXC memory cards.
<http://panasonic.net/avc/sdcard/information/SDXC.html>
- A message prompting to format the card may be displayed when connecting, but do not format.
- If the [Access] displayed on the monitor does not disappear, disconnect the USB connection cable after turning this unit off.

The picture cannot be printed when the camera is connected to a printer.

- Pictures cannot be printed using a printer that does not support PictBridge.
→ Select [PictBridge(PTP)] when connecting. (P105)

The ends of the pictures are cut at printing.

- When using a printer with a Cropping or borderless printing function, cancel this function before printing.
(For details, refer to the operating instructions for the printer.)
- When you order photo studios to print pictures, ask the photo studio if the 16:9 pictures can be printed.



The panorama picture is not printing correctly.

- Since aspect ratio of a panorama picture differs from normal pictures, it may not always be possible to print it correctly.
→ Please use a printer that supports panorama pictures.
(For details, refer to the operating instructions for the printer.)

Others**When shaking the camera, there is a rattling sound.**

- In the following cases, there is no problem with the camera, so do not worry.
 - There is a rattling sound when the camera is shaken while this unit is turned off or during Playback Mode. (Sound of lens moving)
 - This unit makes a rattling sound etc., when this unit is turned on or off, or when switching from Recording Mode to Playback Mode. (Sound of the aperture)
 - Vibration is felt when zooming. (Movement of the lens barrel motor)
 - When you hear a clicking or snapping sound from the lens while taking pictures. (The sound of the aperture adjusting to changes in light levels)
When this occurs, the image on the monitor may appear to change dramatically. However, the picture is not affected.

An unreadable language was selected by mistake.

- Press [MENU/SET], select the [Setup] menu icon [].
Then press [MENU/SET], and then select the [] icon to set the desired language. (P46)

A red lamp sometimes turns on when the shutter button is pressed halfway.

- In dark places, the AF Assist Lamp lights red to make it easier to focus on a subject.

The AF Assist Lamp does not turn on.

- Is [AF Assist Lamp] on the [Rec] menu set to [ON]? (P85)
- The AF Assist Lamp does not turn on in bright places.

The camera becomes warm.

- The surface of the camera may become warm during use. This does not affect the performance or quality of the camera.

The lens clicks.

- When the brightness changes due to zoom or camera movement, etc., the lens may click and the picture on the screen may drastically change. However, the picture is not affected. The sound is caused by the automatic adjustment of the aperture. This is not a malfunction.

The clock is reset.

- If you do not use the camera for a long time, the clock may be reset.
→ [Please set the clock] message will be displayed; please reset the clock. (P22)

When pictures are taken using the zoom, they are slightly distorted and the areas around the subject contain colors which are not actually present.

- It is possible that the subject may be warped slightly, or the borders get colored, depending on the zoom magnification, due to the characteristics of the lens, but this is not a malfunction.

Zooming stops instantaneously.

- When using the Extended Optical Zoom, the zooming action will stop temporarily. This is not a malfunction.

Zoom does not go up to maximum magnification.

- Is the camera set to Macro Zoom Mode? (P54)
Maximum zoom during Macro Zoom Mode is 3× digital zoom.

The file numbers are not recorded consecutively.

- When you perform an operation after taking a certain action, the pictures may be recorded in folders with different numbers from the ones used prior to the operation.

The file numbers are recorded with previously used numbers.

- If you insert or remove the battery before turning off this unit, the folder and file numbers for the pictures taken will not be stored in the memory. When this unit is turned on again and pictures are taken, they may be stored under file numbers which should have been assigned to previous pictures.

The card cannot be formatted.

- Formatting is not available in Intelligent Auto Mode. Switch the Recording Mode to another one. (P25)

Cautions for Use

Optimal use of the camera

Keep this unit as far away as possible from electromagnetic equipment (such as microwave ovens, TVs, video games etc.).

- If you use this unit on top of or near a TV, the pictures and/or sound on this unit may be disrupted by electromagnetic wave radiation.
- Do not use this unit near cell phones because doing so may result in noise adversely affecting the pictures and/or sound.
- Recorded data may be damaged, or pictures may be distorted, by strong magnetic fields created by speakers or large motors.
- Electromagnetic wave radiation may adversely affect this unit, disturbing the pictures and/or sound.
- If this unit is adversely affected by electromagnetic equipment and stops functioning properly, turn this unit off and remove the battery or disconnect AC adaptor (supplied). Then reinsert the battery or reconnect AC adaptor and turn this unit on.

Do not use this unit near radio transmitters or high-voltage lines.

- If you record near radio transmitters or high-voltage lines, the recorded pictures and/or sound may be adversely affected.

Always use the supplied cords and cables.

If you use optional accessories, use the cords and the cables supplied with them.

Do not extend the cords or the cables.

Do not spray the camera with insecticides or volatile chemicals.

- If the camera is sprayed with such chemicals, the body of the camera may be damaged and the surface finish may peel off.

Do not keep rubber or plastic products in contact with the camera for a long period of time.

Cleaning

Before cleaning the camera, remove the battery or disconnect the power plug from the outlet. Then wipe the camera with a dry, soft cloth.

- When the camera is soiled badly, it can be cleaned by wiping the dirt off with a wrung wet cloth, and then with a dry cloth.
- Do not use solvents such as benzine, thinner, alcohol, kitchen detergents, etc., to clean the camera, since it may deteriorate the external case or the coating may peel off.
- When using a chemical cloth, be sure to follow the accompanying instructions.

About the monitor

- Do not press the monitor with excessive force. Uneven colors may appear on the monitor and it may malfunction.
- If the camera is cold when you turn it on, the picture on the monitor will be slightly darker than usual at first. However, the picture will return to normal brightness when the internal temperature of the camera increases.

Extremely high precision technology is employed to produce the monitor screen. However, there may be some dark or bright spots (red, blue, or green) on the screen. This is not a malfunction. The monitor screen has more than 99.99% effective pixels with a mere 0.01% of the pixels inactive or always lit. The spots will not be recorded on pictures on the built-in memory or a card.

About the lens

- If there is liquid or sand on the lens, wipe it with a soft, dry cloth.
- When there is dirt (water, oil, and fingerprints, etc.) on the surface of the lens, the picture may be affected. Lightly wipe the surface of the lens with a soft, dry cloth before and after taking pictures.
- Do not press the lens with excessive force.
- Do not leave the camera with the lens facing the sun, as rays of light from the sun may cause it to malfunction. Also, be careful when placing the camera outside or near a window.

Battery

The battery is a rechargeable lithium ion battery. If the surrounding temperature is too high or too low, the operating time of the battery may become shorter.

Always remove the battery after use.

- Place the removed battery in a plastic bag, and store or carry away from metallic objects (clips, etc.).

If you drop the battery accidentally, check to see if the body of the battery and the terminals are damaged.

- Inserting a damaged battery in the camera will damage the camera.

Do not remove or damage the external label on the battery.

- Using a battery with part or all of the external label removed or using the one with a torn label may result in malfunctions.

Bring charged spare batteries when going out.

- Be aware that the operating time of the battery becomes shorter in low temperature conditions such as at a ski resort.
- When you travel, do not forget to bring the AC adaptor (supplied) and USB connection cable (supplied) so that you can charge the battery in the country that you are traveling in.

Dispose of unusable battery.

- The battery has a limited life.
- Do not throw the battery into fire because it may cause an explosion.
- The unusable battery should be discarded in accordance with battery recycling laws. Call the RBRC hotline at 1-800-822-8837 for information.

Do not allow battery terminals to come into contact with metal objects (such as necklaces, hairpins, etc.).

- This can cause short-circuiting or heat generation and you may be badly burned if you touch a battery.

AC adaptor (supplied)

- If you use the AC adaptor (supplied) near a radio, the radio reception may be disturbed. Keep the AC adaptor (supplied) 1 m (3.3 feet) or further away from radios.
- The AC adaptor (supplied) may generate whirring sounds when it is being used. This is not a malfunction.
- After use, be sure to disconnect the power supply device from the electrical outlet. (A very small amount of current is consumed if it is left connected.)

Card

Do not leave the card where the temperature is high, where electromagnetic waves or static electricity are easily generated or exposed to direct sunlight.

Do not bend or drop the card.

- The card may be damaged or the recorded content may be damaged or deleted.
- Put the card in the card case or the storage bag after use and when storing or carrying the card.
- Do not allow dirt, dust, or water to get into the terminals on the back of the card and do not touch the terminals with your fingers.

Notice for when transferring to another party, or disposing of the memory card “Format” or “delete” using the camera or a PC will only modify the file management information, it will not erase the data in the memory card completely.

It is recommended to physically destroy the memory card or use the commercially available computer data deletion software to completely erase the data in the memory card before transferring to another party or disposing.

Management of data in the memory card is the responsibility of the user.

About the personal information

If a birthday is set for [Baby1]/[Baby2], this personal information is kept in the camera and recorded in the image.

Disclaimer

- Information including personal information may be altered or vanish due to erroneous operation, effect of static electricity, accident, malfunction, repair, or other handlings.

Please note in advance that Panasonic is not liable in any way for any direct or indirect damage from the alteration or vanishing of information or personal information.

When requesting a repair, transferring to another party, or disposing

- Reset the settings to protect the personal information. (P45)
- If there are pictures stored in the built-in memory, copy them onto the memory card (P99) before formatting the built-in memory (P46) as needed.
- Remove the memory card from the camera when requesting a repair.
- Built-in memory and settings may return to factory default when camera is repaired.
- Please contact the dealer where you purchased the camera or Panasonic if above operations are not possible due to malfunction.

When transferring to another party, or disposing of the memory card, please refer to “Notice for when transferring to another party, or disposing of the memory card” above.

When uploading images on web services

- Images may contain information that can be used for identifying individuals such as titles, recording dates, and location information. When uploading images on web services, check carefully, and then upload.

When not using the camera for a long period of time

- Store the battery in a cool and dry place with a relatively stable temperature: [Recommended temperature: 15 °C to 25 °C (59 °F to 77 °F), Recommended humidity: 40%RH to 60%RH]
- Always remove the battery and the card from the camera.
- If the battery is left inserted in the camera, it will discharge even if the camera is turned off. If the battery continues to be left in the camera, it will discharge excessively and may become unusable even if charged.
- When storing the battery for a long period of time, we recommend charging it once a year. Remove the battery from the camera and store it again after it has completely discharged.
- We recommend storing the camera with a desiccant (silica gel) when you keep it in a closet or a cabinet.

About the picture data

- Recorded data may be damaged or lost if the camera breaks down due to inappropriate handling. Panasonic will not be liable for any damage suffered due to loss of recorded data.

About tripods or unipods

- When you use a tripod, make sure the tripod is stable when this unit is attached to it.
- You may not be able to remove the card or the battery when using a tripod or unipod.
- Make sure that the screw on the tripod or unipod is not at an angle when attaching or detaching the camera. You may damage the screw on the camera if you use excessive force when turning it. Also, the camera body and the rating label may be damaged or scratched if the camera is attached too tightly to the tripod or unipod.
- Read the operating instructions for the tripod or unipod carefully.

- SDXC Logo is a trademark of SD-3C, LLC.
- QuickTime and the QuickTime logo are trademarks or registered trademarks of Apple Inc., used under license therefrom.
- iPhoto, Mac and Mac OS are trademarks of Apple Inc., registered in the U.S. and other countries.
- Microsoft, Windows, Windows Vista and Windows Live are either registered trademarks or trademarks of Microsoft Corporation in the United States and/or other countries.
- QR Code is a registered trademark of DENSO WAVE INCORPORATED.
- Other names of systems and products mentioned in these instructions are usually the registered trademarks or trademarks of the manufacturers who developed the system or product concerned.

