

Panasonic[®]

Owner's Manual for advanced features

Digital Camera

Model No. **DMC-LZ30**

LUMIX

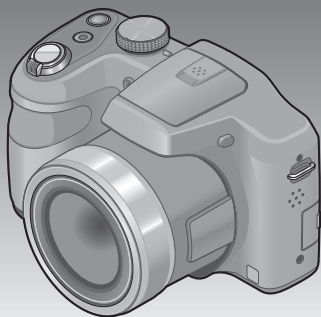

Please read these instructions carefully before using this product, and save this manual for future use.



Register online at
www.panasonic.com/register
(U.S. customers only)

Contents

Before use

Before use	6
Standard Accessories	8
Names and Functions of Main Parts	9
Cursor button	11
Attaching the lens cap/shoulder strap	12
Attaching the lens cap	12
Attaching the shoulder strap	13

Preparations

About the batteries	14
Inserting and removing the batteries	15
Remaining battery	17
Guidelines for number of recordable pictures and operating time	17
Inserting and removing the card (optional)	20
About built-in memory/cards	22
Saving your pictures (cards and built-in memory)	22
Recording capacity guidelines (pictures/recording time)	23
Setting the clock	24
Changing time setting	25

Basics

Sequence of operations	26
Taking pictures with automatic settings [Intelligent Auto] Mode	29
Using flash	30
Automatic Scene Detection	30
[AF Tracking]	31
[Intelligent Auto] Mode restrictions	32
Taking pictures with your own settings [Program AE] Mode	33
Adjusting focus	34
Recording motion pictures	35
Viewing your pictures [Normal Play]	37
Zooming in and viewing "Playback Zoom"	38
Viewing a list of pictures "Multi Playback"	38
Searching pictures by their recording date "Calendar"	39
Viewing motion pictures	40
Deleting pictures	41
To delete multiple (up to 50)/To delete all pictures	42
Setting the menu	43
Menu type	44
Using Quick menu	45

Using the [Setup] menu	46
[Battery]	46
[Clock Set]	46
[Beep]	46
[Volume]	46
[Monitor Display]	46
[Monitor Luminance]	47
[Histogram]	48
[Video Rec Area]	48
[Economy]	49
[Auto Review]	50
[Reset]	50
[Output]	50
[Version Disp.]	51
[Format]	51
[Language]	51
Application (Record)	
Changing recording information display	52
Using Zoom	53
Zoom types and use	54
Taking pictures with flash	55
Taking close-up pictures	59
Focus range	60
[Macro Zoom]	61
Taking pictures with self-timer	62
Taking pictures with Exposure Compensation	63
[Auto Bracket]	64
Determining aperture and shutter speed and recording	
[Manual Exposure] Mode	65
Taking Pictures with different picture effects [Creative Control] mode	66
[Expressive]	67
[Retro]	67
[High Key]	67
[Low Key]	67
[Sepia]	68
[Dynamic Monochrome]	68
[Impressive Art]	68
[High Dynamic]	68
[Cross Process]	69
[One Point Color]	69
Taking pictures of people [Portrait] Mode	70
Taking pictures of scenery [Scenery] Mode	71
Taking pictures of sporting events [Sports] Mode	72

Taking pictures according to the scene [Scene Mode]	73
[Panorama Shot]	74
[Night Portrait]	76
[Night Scenery]	76
[HDR]	77
[Food]	78
[Baby]	78
[Sunset]	79
[High Sens.]	79
Using the [Rec] menu	80
[Picture Size]	80
[Quality]	81
[Sensitivity]	81
[White Balance]	82
[AF Mode]	84
[Metering Mode]	85
[i.Exposure]	86
[Digital Zoom]	86
[Burst]	87
[Color Mode]	88
[AF Assist Lamp]	88
[Red-Eye Removal]	89
[Stabilizer]	89
[Date Stamp]	90
[Clock Set]	90
Using the [Motion Picture] menu	91
[Rec Quality]	91
[Continuous AF]	91

Application (View)

Different playback methods [Playback Mode]	92
[Slide Show].....	93
[Category Selection].....	94
[Calendar].....	94
Retouching pictures [Creative Retouch]	95
[Toy Effect].....	96
[Miniature Effect].....	96
[Star Filter].....	96
[One Point Color].....	96
Using the [Playback] menu	97
[Creative Retouch].....	97
[Resize].....	97
[Cropping].....	99
[Protect].....	100
[Copy].....	101

Connecting with other devices

Viewing on TV screen	102
Using with your PC	104
Using the supplied software.....	105
Installing supplied software (PHOTOfunSTUDIO).....	106
Copying still pictures and motion pictures.....	107
Printing	109
Printing multiple pictures.....	110
Making print settings on the camera.....	111
Printing with date and text.....	112

Others

List of LCD monitor displays	113
Message displays	115
Q&A Troubleshooting	117
Usage cautions and notes	123

■ How to read this document

- Recording mode icons

Recording mode:



Available recording modes

Unavailable recording modes

Before use

■ Camera handling

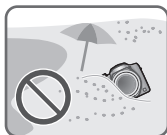
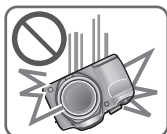

Keep the camera away from excessive vibration, force, or pressure.

- Avoid using the camera under the following conditions, which may damage the lens, LCD monitor, or camera body. This may also cause the camera to malfunction or prevent recording.
 - Dropping or hitting the camera against a hard surface
 - Pushing with excessive force on the lens or LCD monitor
 - When carrying or using the playback feature, ensure that the lens is in the stored position, with lens cap on.

The camera is not dust resistant, splash resistant, or waterproof.

Avoid using the camera in places with excessive dust or sand, or where water can come into contact with the camera.

- Avoid using the camera under the following conditions, which present a risk that sand, water, or foreign material may enter the camera through the lens or openings around buttons. Be especially careful, because these conditions may damage the camera and such damage may not be repairable.
 - In extremely dusty or sandy places
 - In the rain or by the shore, where the camera may be exposed to water

■ Condensation (When the lens or the LCD monitor is fogged up)

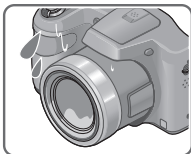

- Condensation may occur when the camera is exposed to sudden changes of temperature or humidity. Avoid these conditions, which may make the lens or LCD monitor dirty, cause mold, or damage the camera.
- If condensation does occur, turn off the camera and wait about two hours before using it. Once the camera adjusts to the surrounding temperature, the fogging will clear naturally.

■ **Always take a test shot first**

Before important events when you will use the camera (at weddings, for example), always take a test shot to make sure that pictures and sound record correctly.

■ **No compensation for missed shots**

We cannot compensate for missed shots if technical problems with the camera or card prevent recording.

■ **Carefully observe copyright laws**

Unauthorized use of recordings that contain works with copyright for purposes other than personal use is prohibited under copyright law. Recording of certain material may be restricted even for the purpose of personal use.

■ **Also refer to “Usage cautions and notes” (→123)**

Standard Accessories

Check that all the accessories are supplied before using the camera.

- The accessories and their shape may differ depending on the country or area where the camera was purchased.
For details on the accessories, refer to Basic Owner's Manual.
- LR6/AA alkaline batteries or HR6/AA rechargeable Ni-MH (nickel metal hydride) batteries are indicated as battery (or batteries) in the text.
- SD Memory Card, SDHC Memory Card and SDXC Memory Card are indicated as card in the text.
- Please dispose of all packaging appropriately.
- Keep small parts in a safe place out of the reach of children.

■ Optional accessories

- **Cards are optional.** You can record or play back pictures on the built-in memory when you are not using a card.
- If any accessories are lost, customers in the USA and Puerto Rico should contact Panasonic's parts department at 1-800-833-9626 and customers in Canada should contact 1-800-99-LUMIX (1-800-995-8649) for further information about obtaining replacement parts.

Names and Functions of Main Parts

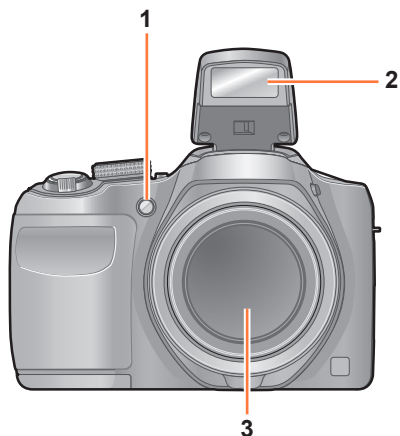

- 1 **Self-timer indicator** (→62) / **AF Assist Lamp** (→27, 88)
- 2 **Flash** (→27, 55)
- 3 **Lens**

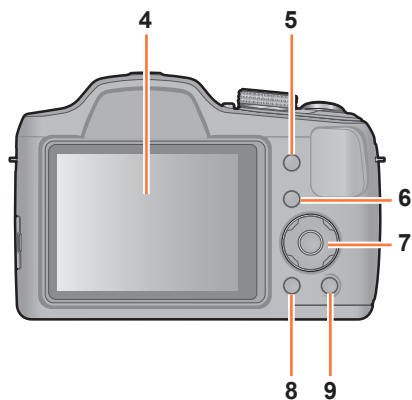

- 4 **LCD monitor** (→52, 113, 114)
- 5 **[EXPOSURE] button** (→65)
Operate this when setting the shutter speed or aperture value (only in the **M** mode).
- 6 **Playback button** (→28, 37, 92)
Use this to switch to playback mode.
- 7 **Cursor button** (→11)
- 8 **[DISP.] button** (→52)
Use this to change display.
- 9 **[Q.MENU] / [MENU] / [RECALL] button**
In the recording mode:
Quick menu is displayed. (→45)
In the playback mode:
Pictures are deleted. (→41)
During menu operations:
Previous screen is restored. (→43)

● The illustrations and screens in this manual may differ from the actual product.

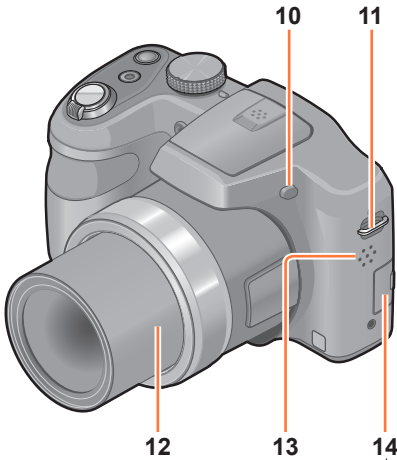

- 10 Flash open button (→55)
- 11 Shoulder strap eyelet (→13)
- 12 Lens barrel
- 13 Speaker (→46)
- 14 [AV OUT/DIGITAL] socket

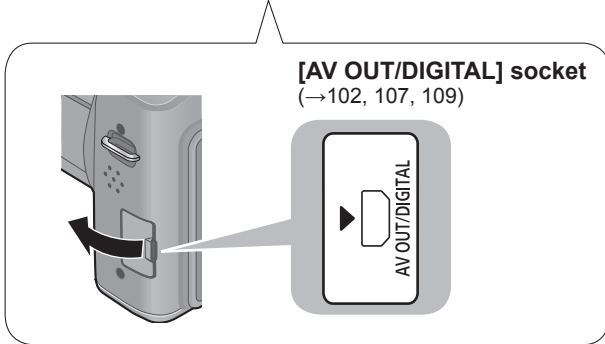

● Some methods of holding the camera may block the speaker, making it difficult to hear the beep, etc.

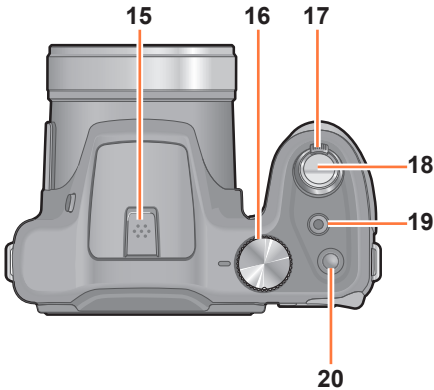

- 15 Microphone** (→27, 35)
16 Mode dial (→26)
 Use this to select the recording mode.
17 Zoom lever (→53)
 Operate this when zooming in on a distant subject to record it larger.
18 Shutter button (→27, 29)
 Use this to focus and record still pictures.
19 Motion picture button (→27, 35)
 Record motion pictures.
20 Camera [ON/OFF] button (→24, 26)
 Use this to turn the camera on and off.

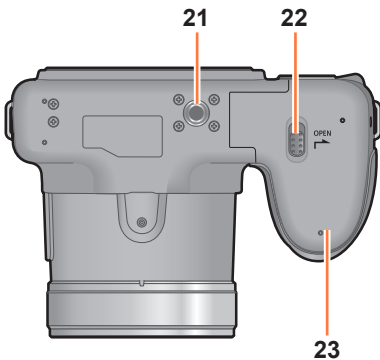

- 21 Tripod Mount** (→127)
 Do not attach to a tripod with a 5.5 mm (0.22 inch) or longer screw. Doing so may damage this unit.
22 Release lever (→15, 20)
23 Card/Battery door (→15, 20)

Cursor button

[MENU/SET]

Use this to display the menus, enter the settings, etc. (→43)

Left cursor button (◀)

• Self-timer (→62)

Down cursor button (▼)

• Macro Mode etc. (→59)

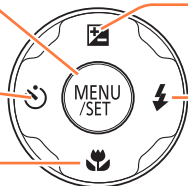

Up cursor button (▲)

• Exposure Compensation, Auto Bracket etc. (→63)

Right cursor button (▶)

• Flash (→56)

● In this manual, the button that is used is indicated by ▲▼◀▶.

Attaching the lens cap/shoulder strap

Attaching the lens cap

When you turn the camera off or carry the camera, attach the lens cap (supplied) to protect the surface of the lens.

1 Pass the lens cap string through the shoulder strap eyelet on the camera body

- Attach the lens cap string before attaching the shoulder strap.
- Pass the shorter loop of the string through the eyelet.

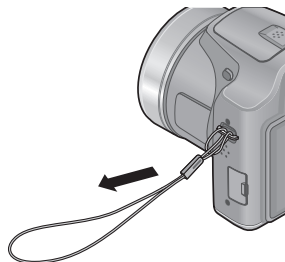

2 Pass the lens cap string through the lens cap eyelet

- Pass the lens cap through the loop of the string and tighten it.

①

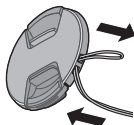

②

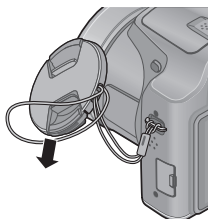

③

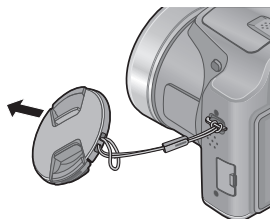

3 Attach the lens cap

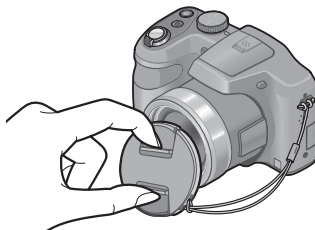

- Do not hang or swing around this unit.
- Make sure to detach the lens cap when turning on the camera.
- Be careful not to lose the lens cap.
- Be careful that the lens cap string does not become entangled with the shoulder strap.

Attaching the shoulder strap

We recommend attaching the shoulder strap (supplied) when using the camera to prevent it from dropping.

1 Pass the shoulder strap through the shoulder strap eyelet on the camera body

- Attach the shoulder strap so that the “LUMIX” Logo is on the outside.

Shoulder strap eyelet

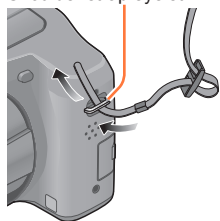

2 Pass the end of the shoulder strap through the ring in the direction of the arrow and then pass it through the stopper

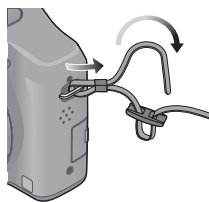

3 Pass the end of the shoulder strap through the hole on the other side of the stopper

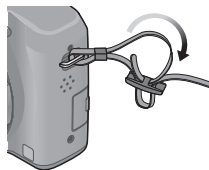

4 Pull the other side of the shoulder strap and then check that it is secure

- Perform steps 1 to 4 and then attach the other side of the shoulder strap.

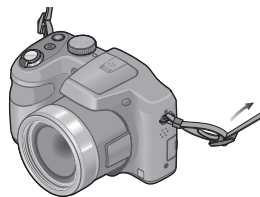

- Be sure to follow the steps and attach the shoulder strap correctly.
- Check that the shoulder strap is firmly attached to the camera.
- Use the shoulder strap around your shoulder.
 - Do not wrap the strap around the neck. It may result in injury or accident.
- Do not leave the shoulder strap where an infant can reach it.
 - It may result in an accident by mistakenly wrapping around the neck.

About the batteries

■ About batteries that you can use with this unit

LR6/AA alkaline batteries or optional HR6/AA rechargeable Ni-MH (nickel metal hydride) batteries can be used with this unit.

- EVOLTA (EVOIA) batteries (Panasonic battery) can also be used.
- **The following batteries cannot be used.**
 - Manganese batteries
 - Lithium batteries
 - Nickel batteries
 - Ni-Cd batteries
 - Oxyride batteries
- **If these batteries are used, the following problems may occur:**
 - Battery leakage
 - Incorrect display of remaining battery power
 - Failure to turn on camera
 - Damage to data written to built-in memory or card
 - Other troubles
- **Never use batteries such as those indicated below.**
 - Batteries with all or part of their covering peeled off
 - Batteries with flat ⊖ poles

Inserting and removing the batteries

- 1 Move the release lever to the [OPEN] position (①) and slide the card/battery door in the direction (②) to open it

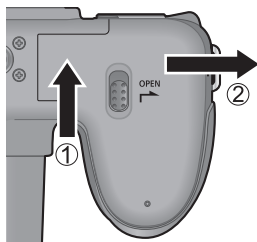

- 2 Insert the batteries all the way with correct orientation of \oplus and \ominus poles

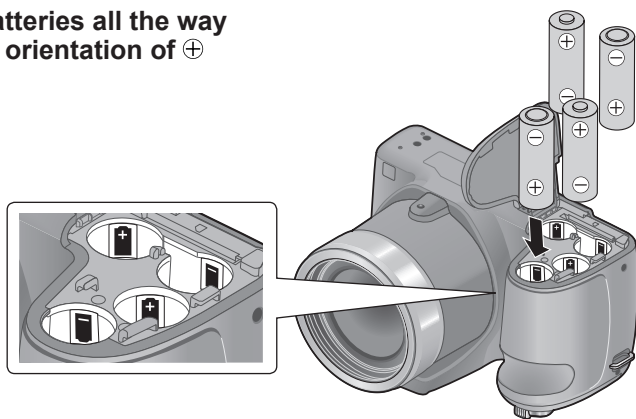

- 3 Close the card/battery door and slide the door in until you hear a locking sound

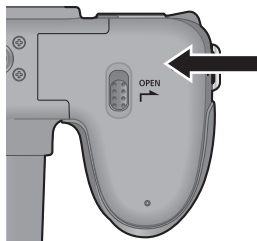

Turn off the camera.

■ To remove batteries

Tilt the camera and catch the batteries in your hand.
Be careful not to drop them.

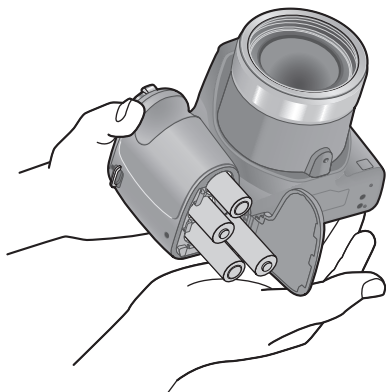

- To remove the batteries, turn the camera off and wait until the LUMIX indicator on the LCD monitor goes off. (Failure to wait may cause the camera to malfunction and may damage the card or recorded data.)
- Be sure to remove the batteries if you are not using the camera for a long period of time. Batteries may be hot immediately after use. Turn off the camera and wait until the battery temperature lowers before removing them.
- The clock settings may reset if batteries are removed from the camera for 120 hours or more.
- Always use all new batteries of the same type and brand when replacing batteries.
- The unusable battery should be discarded in accordance with battery recycling laws. Call the RBRC hotline at 1-800-822-8837 for information.

Remaining battery



Remaining battery



If the battery mark flashes red, replace the batteries with new ones.

When you insert new batteries, one of the following messages will be displayed.

- [To use alkaline battery (LR6)]
- [To use nickel metal hydride battery]

If the type of new batteries is different from that indicated in the message, change the setting of [Battery] (→46) in the [Setup] menu.

Guidelines for number of recordable pictures and operating time

The number of recordable pictures or available operating time may vary according to surrounding environment and usage conditions. Figures may be reduced if flash, zoom, or other functions are used frequently, or in colder climates. (→19)

■ Recording still pictures (By CIPA standard)

	Supplied batteries or optional Panasonic alkaline batteries	Fully-charged Panasonic Ni-MH batteries (optional, when the battery capacity is 1900 mAh)
Number of recordable pictures	Approx. 380 pictures	Approx. 540 pictures
Recording time	Approx. 190 min	Approx. 270 min

● Recording conditions by CIPA standard

CIPA is an abbreviation of [Camera & Imaging Products Association].

- [Program AE] Mode
- Temperature: 23 °C (73.4 °F)/Humidity: 50%RH when LCD monitor is on.
- Using a Panasonic SD Memory Card (32 MB).
- Starting recording 30 seconds after the camera is turned on (when the Image Stabilizer function is set to [ON]).
- Recording once every 30 seconds with full flash every second recording.
- Rotating the zoom lever from max. Tele to max. Wide or vice versa in every recording.
- Turning the camera off every 10 recordings and leaving it until the temperature of the batteries decreases.

Number reduced if intervals are longer (e.g. to approx. one quarter for 2-minute intervals under the above conditions).

■ Recording motion pictures*1

	Supplied batteries or optional Panasonic alkaline batteries	Fully-charged Panasonic Ni-MH batteries (optional, when the battery capacity is 1900 mAh)
[Rec Quality]	[HD]	[HD]
Available recording time	Approx. 210 min	Approx. 280 min
Actual available recording time*2	Approx. 105 min	Approx. 140 min

● Recording conditions

- Temperature 23 °C (73.4 °F), humidity 50%RH

*1 Motion pictures can be recorded continuously up to 2 GB.

The maximum available recording time for up to 2 GB only is displayed on the screen.

*2 The time you can actually record when repeatedly turning the camera on and off, starting and stopping recording and using zoom.

■ Viewing pictures

	Supplied batteries or optional Panasonic alkaline batteries	Fully-charged Panasonic Ni-MH batteries (optional, when the battery capacity is 1900 mAh)
Playback time	Approx. 430 min	Approx. 560 min

- The number of recordable pictures, recording time, and playback time vary, depending on the storage and operating conditions of the batteries, the brand and type of batteries.
- We recommend using [Economy] (→49) or turning off the camera frequently between recording sessions to save battery power. If you are going to use the camera for long periods of time, the use of rechargeable Ni-MH batteries is recommended. If the available battery power is significantly reduced even when fully charged Ni-MH batteries are used, the batteries have reached the end of their life. Please purchase new batteries.
- Do not use a damaged or dented battery (especially connectors), e.g. by dropping (can cause faults).

Please note that the performance of alkaline batteries significantly decreases in low temperature conditions.

(When the temperature is 0 °C (32 °F))

■ Recording still pictures

	Supplied batteries or optional Panasonic alkaline batteries	Fully-charged Panasonic Ni-MH batteries (optional, when the battery capacity is 1900 mAh)
Number of recordable pictures	Approx. 120 pictures	Approx. 500 pictures
Recording time	Approx. 60 min	Approx. 250 min

■ Recording motion pictures

	Supplied batteries or optional Panasonic alkaline batteries	Fully-charged Panasonic Ni-MH batteries (optional, when the battery capacity is 1900 mAh)
[Rec Quality]	[HD]	[HD]
Available recording time	Approx. 70 min	Approx. 240 min
Actual available recording time	Approx. 35 min	Approx. 120 min

■ Viewing pictures

	Supplied batteries or optional Panasonic alkaline batteries	Fully-charged Panasonic Ni-MH batteries (optional, when the battery capacity is 1900 mAh)
Playback time	Approx. 340 min	Approx. 540 min

Inserting and removing the card (optional)

Turn off the camera.

- 1** Move the release lever to the [OPEN] position (①) and slide the card/battery door in the direction (②) to open it

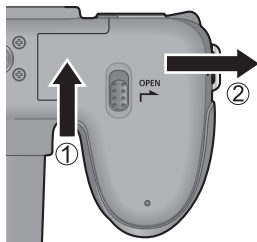

- 2** Insert the card all the way
 - Push in until it clicks.

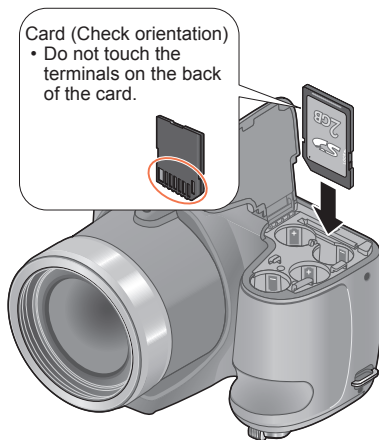

- 3** Close the card/battery door and slide the door inward until it locks firmly

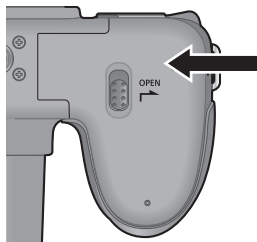

Turn off the camera.

■ To remove card

Press the center of the card.

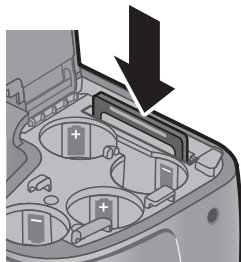

- Keep the Memory Card out of reach of children to prevent swallowing.
- To remove the card, turn the camera off and wait until the LUMIX indicator on the LCD monitor goes off. (Failure to wait may cause the camera to malfunction and may damage the card or recorded data.)

About built-in memory/cards

Saving your pictures (cards and built-in memory)

Pictures will be saved to a card if one is inserted, or to the built-in memory  if not.

■ Built-in memory (approx. 100 MB)

- Pictures may be copied between cards and the built-in memory. (→101)
- The access time for the built-in memory may be longer than the access time for a card.

■ Compatible memory cards (optional)

The following SD standard-based cards (Panasonic brand recommended)

Type of Card	Capacity	Notes
SD Memory Cards	8 MB – 2 GB	<ul style="list-style-type: none">• Use an SDHC Memory Card/SDXC Memory Card of SD Speed "Class 6"* or higher for recording motion pictures.• Can be used with devices compatible with the respective formats.• Before using SDXC Memory Cards, check that your computer and other devices support this type of card. http://panasonic.net/avc/sdcard/information/SDXC.html• Only the cards listed on the left with the given capacities are supported.
SDHC Memory Cards	4 GB – 32 GB	
SDXC Memory Cards	48 GB, 64 GB	

* SD speed class refers to a specification for sustained write speeds. Confirm the SD speed by checking the card label or other card related materials.

(Example)



- While the camera is accessing the card or built-in memory (for an operation such as picture writing, reading, deletion or formatting), do not turn off the camera or remove the batteries/card. Do not subject the camera to vibrations, impact, or static electricity. Should any of these cause camera operation to be terminated, attempt to perform the operation again.
- Please reformat the card with this camera if it has already been formatted with a computer or another device. (→51)
- If the write-protect switch is set to "LOCK", the card cannot be used to record or delete pictures, and it cannot be formatted.
- It is recommended that you copy important pictures to your computer (as electromagnetic waves, static electricity, or faults may cause data to be damaged).
- Latest information:
<http://panasonic.jp/support/global/cs/dsc/>
(This site is available in English only.)



Switch

Recording capacity guidelines (pictures/recording time)

The number of pictures you can take and the recording time vary in proportion to card capacity (and depending on recording conditions and type of card).

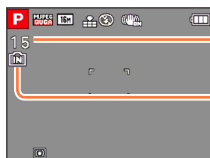

Estimated remaining pictures or recording time capacity
(press [DISP.] button to switch display)

Displayed when no card is inserted
(pictures will be saved to built-in memory)

■ Recording picture capacity (still pictures)

[Picture Size]	Built-in memory	2 GB	32 GB	64 GB
4:3 16M	15	340	5580	10970
4:3 5M	45	850	14130	27450
4:3 0.3M	260	4620	76150	123570

- When the number of recordable pictures exceeds 99,999, "+99999" is displayed.

■ Recording time capacity (motion pictures)

[Rec Quality]	Built-in memory	2 GB	32 GB	64 GB
HD	–	8m30s	2h10m	4h30m
VGA	–	21m50s	5h50m	11h45m
QVGA	3m20s	1h00m	17h00m	34h00m

([h], [m] and [s] indicate "hour", "minute" and "second".)

- Motion pictures can be recorded continuously up to 2 GB.
The maximum available recording time for up to 2 GB only is displayed on the screen.

Setting the clock

The clock is not set when the camera is shipped.

- Make sure to detach the lens cap when turning on the camera.

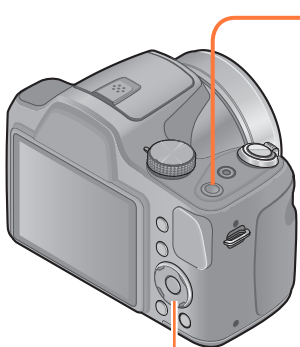

Cursor button / [MENU/SET]

1 Press the Camera [ON/OFF] button

The camera is turned on.

If the language select screen is not displayed, proceed to step 4.

ON/OFF



2 Press [MENU/SET] while the message is displayed

3 Press ▲ ▼ to select the language, and press [MENU/SET]

4 Press [MENU/SET]

5 Press ◀ ▶ to select the items (year, month, day, hour, minute, display order or time display format), and press ▲ ▼ to set

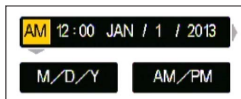

- To cancel → Press [↵] button.

6 Press [MENU/SET] to set

7 Press [MENU/SET]

- To return to the previous screen, press [↵] button.

Changing time setting

Select [Clock Set] from the [Setup] menu or [Rec] menu to change the current time settings.

- If approximately 2 hours have elapsed after installing the batteries with sufficient power in the camera, the clock settings will be retained for about 120 hours even if the batteries are removed.

1 Select [Clock Set] from the [Setup] menu or [Rec] menu (→43)

2 Press ◀▶ to select the items (year, month, day, hour, minute, display order or time display format), and press ▲▼ to set

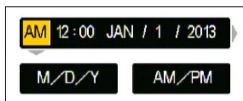

- To cancel → Press [↵] button.

3 Press [MENU/SET] to set

- If the clock is not set, the correct date cannot be printed.
- If the clock is set, the correct date can be printed even if the date is not displayed on the screen of the camera.

Sequence of operations

Make sure to detach the lens cap when turning on the camera.

Press the Camera [ON/OFF] button

ON/OFF



1

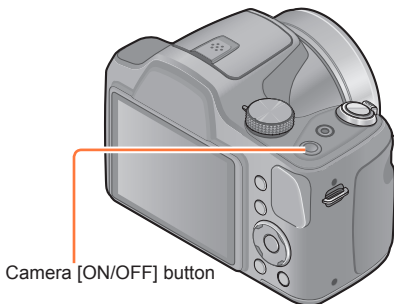



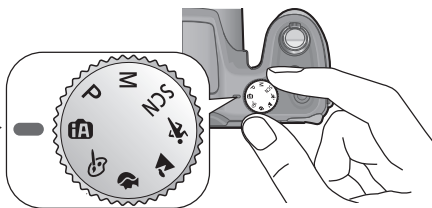

Camera [ON/OFF] button

Set to the desired recording mode

Align the mode dial correctly to the mode that you want to use. →



2

	[Intelligent Auto] Mode	Take pictures with automatic settings. (→29)
P	[Program AE] Mode	Take pictures with your own settings. (→33)
M	[Manual Exposure] Mode	Determine aperture and shutter speed, then take pictures. (→65)
SCN	[Scene Mode]	Take pictures according to scene. (→73)
	[Sports] Mode	Take pictures of sporting events, etc. (→72)
	[Scenery] Mode	Take pictures of scenery. (→71)
	[Portrait] Mode	Take pictures of people. (→70)
	[Creative Control] Mode	Take pictures by selecting your preferred picture effect. (→66)

(Continued on the next page)

Aim the camera and shoot

■ Taking still pictures

- ① Press the shutter button halfway to focus
- ② Press and hold the shutter button to take the picture

■ Recording motion pictures (→35)

- ① Press the motion picture button to start recording
- ② Press the motion picture button again to finish recording

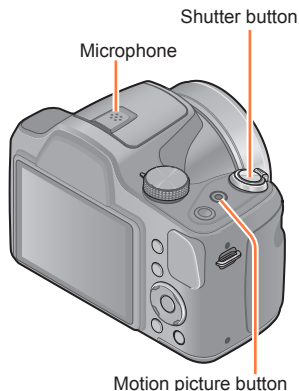

3

■ Holding the camera

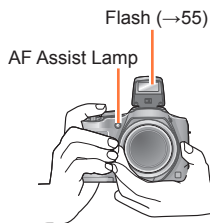

- To avoid camera shake, hold it with both hands keeping your arms close to your body while standing with your feet slightly apart.
- Do not touch the lens.
- Do not hold the lens barrel as you take pictures. There is a risk that your finger will be trapped as the lens retracts.
- Do not block the flash or the lamp. Do not look at it from close range.
- Make sure that the camera does not move at the moment the shutter button is pressed.

- We recommend attaching the shoulder strap (supplied) when using the camera to prevent it from dropping. (→13)

(Continued on the next page)

4 Press the Playback button



4

Playback button

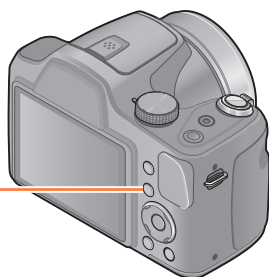

5 View pictures (→37, 75)



5

- Press ◀▶ to select a picture
- Press ▲ to play back motion pictures or panorama pictures

■ Taking pictures once again

- Press Playback button to enter the recording mode

6 Turn off the camera (Press the Camera [ON/OFF] button)

ON/OFF



6

■ To turn on the camera in Playback Mode



Press and hold the playback button.

- Pictures on the card or built-in memory are displayed.

Taking pictures with automatic settings

[Intelligent Auto] Mode

Recording mode:  P M SCN 

Optimum settings are made automatically from information such as “face”, “movement”, “brightness”, and “distance” just by pointing the camera at the subject, meaning that clear pictures can be taken without the need to make settings manually.

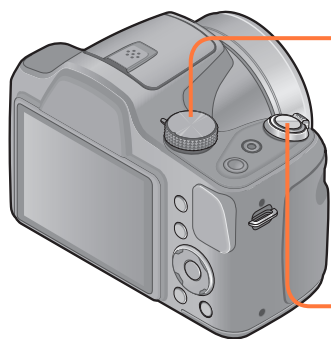

1 Set to **iA** ([Intelligent Auto] Mode)



2 Take a picture



Press halfway
(press lightly to focus)



Press fully
(press the button all the way to record)

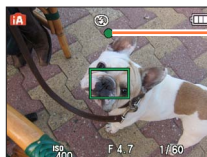

Focus display
(When focus is aligned:
illuminated
When focus is not
aligned: flashing)

Using flash

Press [FLASH] to open the flash (→55).

- When **iA** is selected, the optimum flash (**iA**, **iA**, **iS**, **iS**) is selected automatically depending on conditions. (→58)
- When **iA** or **iS** is selected, the red-eye reduction function is activated.
- When **iS** or **iS** is selected, the shutter speed is reduced.

Automatic Scene Detection

Camera reads scene when pointed at subject, and makes optimum settings automatically.



The icon of scene detected

	Recognizes people
	Recognizes landscapes
	Recognizes night scenes and people in them (Only when iA is selected)*
	Recognizes night scenes*
	Recognizes close-ups
	Recognizes sunsets
	Reads subject movement to avoid blurring when scene does not correspond to any of the above.

* We recommend using a tripod and the self-timer.

- Depending on recording conditions, different scene types may be determined for the same subject.
- If desired scene type is not selected, we recommend manually selecting the appropriate scene mode.
- When **iA** or **iA** is detected, Face Detection is activated, and the focus and exposure are adjusted to the recognized faces.

■ About Backlight Compensation

Backlight compensation is automatically activated in [Intelligent Auto] mode.

Backlight is a condition where a light shines from behind a subject. When there is a backlight, the subject appears darker and the camera will automatically attempt to correct it by increasing the brightness of the picture.

[AF Tracking]

This function enables the camera to continue to focus on the subject and adjust the exposure of the subject even when the subject is moving.

1 Press ▲ to set AF Mode to [AF Tracking]

- To cancel AF Tracking → Press ▲ again.

2 Align the AF Tracking frame with the subject, and then press ▼ to lock

- To cancel AF Lock → Press ▼.

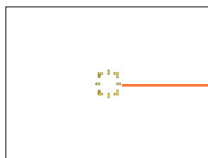

AF Tracking frame
AF Lock successful: Yellow
AF Lock failed: Red

- The optimal scene for the AF locked subject is automatically identified.
- Under certain recording conditions, such as when the subject is small or when it is dark, [AF Tracking] may not operate correctly.



[Intelligent Auto] Mode restrictions

Only the menu items which are displayed in the [Intelligent Auto] Mode can be set. The settings selected in the [Program AE] or other modes will reflect on the menu items in the [Setup] menu that are not displayed.

- The settings for the following items are different from other recording modes:
[Picture Size] and [Burst] on the [Rec] menu

- The settings for the following functions are fixed:

[Rec] menu

- [Sensitivity]: [AUTO]
- [White Balance]: [AWB]
- [AF Mode]:  [Face Detection]*
- [Metering Mode]:  [Multi Metering]
- [i.Exposure]: [ON]
- [AF Assist Lamp]: [ON]
- [Red-Eye Removal]: [ON]

* (9-area-focusing) when face cannot be recognized

[Motion Picture] menu

- [Continuous AF]: [ON]

- The following functions cannot be used:

[Histogram] [Video Rec Area] [Exposure] [Auto Bracket] [Digital Zoom]

Taking pictures with your own settings

[Program AE] Mode

Recording mode:

Using the [Rec] menu to change settings and set up your own recording environment.

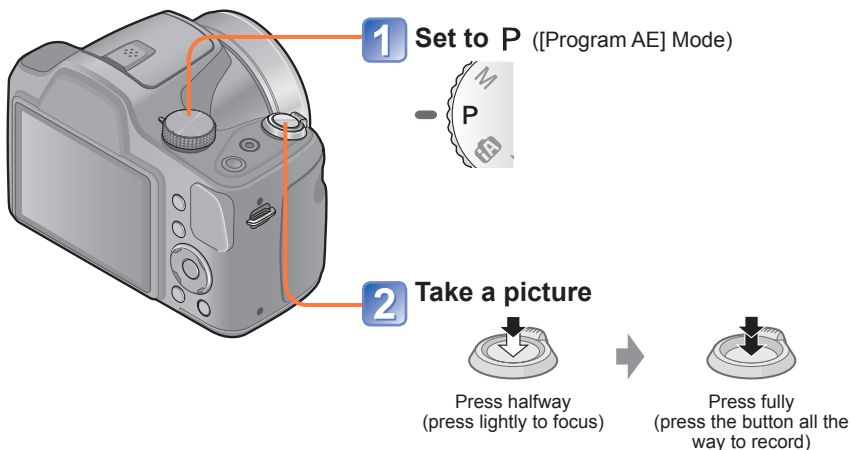

- If a warning is displayed about jitter, use [Stabilizer], a tripod, or [Selftimer].
- If aperture and shutter speed are shown in red, you do not have appropriate exposure. You should either use the flash or change [Sensitivity] settings.

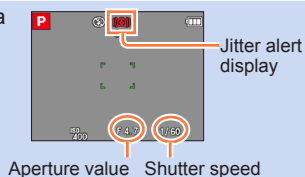

Adjusting focus

When [AF Mode] is set to  (1-area-focusing), focus on the AF area in the center of the picture. If a subject you want to record is not in the center, follow the steps below.

1 Adjust focus according to subject

Align the AF area
with the subject



Hold down halfway

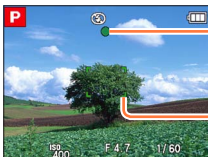

Focus display

(When focus is aligned: illuminated
When focus is not aligned: flashing)

AF area

(When focus is aligned: green
When focus is not aligned: red)

2 Return to desired composition



Press fully

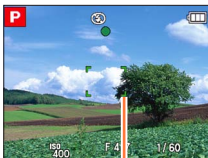

AF area

- Subjects/environments which may make focusing difficult:
 - Fast-moving or extremely bright objects, or objects with no color contrast.
 - Taking pictures through glass or near objects emitting light. In dark, or with significant jitter.
 - When too close to object or when taking pictures of both distant and close objects together in the same picture.
- The focus display flashes and beep sounds when focus is not aligned. Use the focus range displayed in red as a reference. (→60)
Even if the focus display is lit, the camera may be unable to bring the subject into focus if it is out of range.
- The AF area display may be larger depending on recording conditions such as dark locations or zoom ratio.

Recording motion pictures

Recording mode:        

You can record motion pictures with audio (monaural).

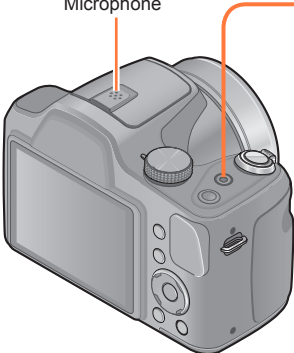

1 Press the motion picture button to start recording

[Rec Quality] (→91)

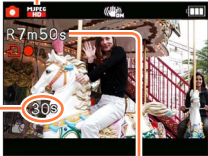

Elapsed recording time Remaining recording time (approx.)

- Immediately release the motion picture button after pressing it.
- You can use digital zoom even while recording motion pictures.
 - Set the [Digital Zoom] to [ON] beforehand. (→54)

2 Press the motion picture button again to end recording

(Continued on the next page)

■ Recording motion pictures in iA

A motion picture will be recorded without Automatic Scene Detection operating.

■ Recording motion pictures in P

Records a motion picture at your preferred settings.

- Aperture and shutter speed are automatically set.

■ Motion picture recording in other recording modes

For details, refer to the pages relating to the respective recording modes.

Motion pictures cannot be recorded in the following cases.

- Scene Mode ([Panorama Shot])
- [Creative Control] Mode ([Impressive Art])

- When recording motion pictures, we recommend using batteries with sufficient power.
- The available recording time displayed on the screen may not decrease regularly.
- If data is repeatedly recorded and deleted, the total available recording time on the SD card may be reduced. To restore the original capacity, use the camera to format the SD card. Be sure to save all important data to your computer or other media before formatting, as all data saved to the card will be erased.
- The flash is set to  [Forced Flash Off]. (→58)
- For certain memory cards, recording may end while in progress. (→118)
- The recording range may become narrower in motion pictures compared to still pictures. Also, if the aspect ratio is different for still pictures and motion pictures, the angle of view will change when starting to record a motion picture. The recordable area is displayed by setting [Video Rec Area] (→48) to [ON].
- If Extended optical zoom is used before pressing the motion picture button, these settings will be cleared, and the recordable area will be changed significantly.
- Depending on the environment when recording motion pictures, the screen may turn black for an instant or noise may be recorded because of static electricity, electromagnetic waves, etc.
- This unit automatically adjusts the aperture during motion picture recording. At such times, the sound may break up. This is not a malfunction.

Viewing your pictures [Normal Play]

When a card is in the camera, pictures are played back from the card. Without a card, pictures are played back from the built-in memory.

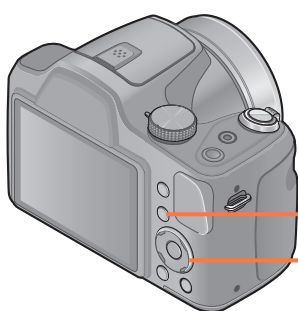

1 Press the Playback button



- Press again to enter the recording mode.

2 Use the ◀▶ cursor button to select a picture that you want to play back

- Hold down to quickly scroll forwards/backwards.

3 View pictures



Folder/File number

Picture number/Total pictures

- It may not be possible to view pictures on this camera that were previously edited on a computer.
- After pressing the Playback button and switching it into the playback mode, the lens barrel will be retracted after approx. 15 seconds.
- This camera is compliant with the unified DCF (Design rule for Camera File system) standard formulated by the Japan Electronics and Information Technology Industries Association (JEITA), and with Exif (Exchangeable image file format). Files that are not DCF-compliant cannot be played back.

Zooming in and viewing "Playback Zoom"



Move to T side



Current zoom position

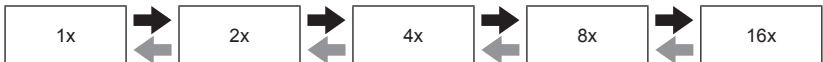

➡ Move to T side

⬅ Move to W side

- Move zoom position → ▲▼◀▶

● Playback zoom cannot be used during motion picture playback.

Viewing a list of pictures "Multi Playback"



Move to W side

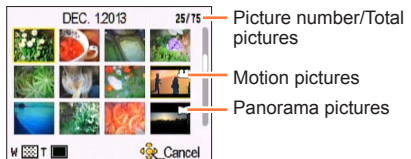

➡ Move to W side

⬅ Move to T side

- When you select a picture using the cursor button and press [MENU/SET] on the 12-picture or 30-picture screen, the selected picture is displayed on the 1-picture screen (full-screen).

● Pictures displayed with [!] cannot be played back.

Searching pictures by their recording date "Calendar"



Move to W side

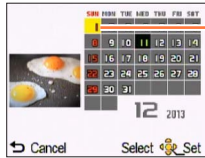

Selected date



Move to W side

Move to T side

- When you select a recording date using the cursor button and press [MENU/SET], the display method changes to the 30-picture screen.

● Only months when pictures were taken are shown on the calendar screen. If the clock was not set, pictures will be displayed as January 1st, 2013. If the date / time was set incorrectly, pictures will be displayed with the incorrect settings.

Viewing motion pictures

- 1** Select a picture with the motion picture icon, and press **▲**
Playback now starts.



Motion picture icon

Motion picture recording time
When playback starts, the elapsed playback time is displayed in the top right of the screen.

■ Operations during motion picture playback

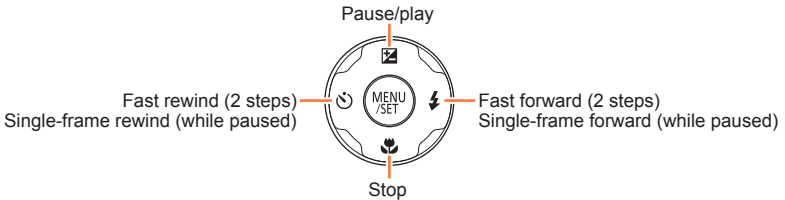

- Volume can be adjusted with the zoom lever.

- It may not be possible to properly play back the motion pictures recorded using other cameras.
- Motion pictures can be viewed on your computer using "PHOTOfunSTUDIO" on the supplied CD-ROM.

Deleting pictures

Pictures will be deleted from the card if the card is inserted, or from the built-in memory if the card is not inserted. (Deleted pictures cannot be recovered.)

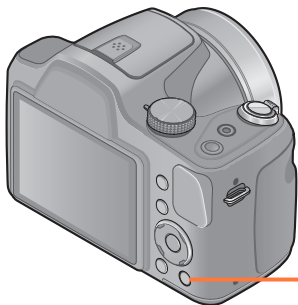

1 Press to delete displayed picture



Q.MENU



- A confirmation screen is displayed. Select [Yes] with cursor button and then press [MENU/SET].

- Do not turn off the camera during deletion.
- Use batteries with sufficient power.
- Pictures cannot be deleted in the following cases:
 - Protected pictures
 - Card switch is in "LOCK" position.
 - Pictures not of DCF standard (→37)

To delete multiple (up to 50)/To delete all pictures

1 Press while viewing a picture



Q.MENU 

2 Use to select [Delete Multi]/[Delete All] and press [MENU/SET]

■ [Delete Multi]

Use cursor button to select picture and press [DISP.] button



- To cancel → Press [DISP.] button again.
- To execute → Press [MENU/SET].

 Picture selected

- A confirmation screen is displayed. Select [Yes] with cursor button and then press [MENU/SET].
- May take time depending on number of pictures deleted.

Setting the menu

Refer to the procedure below for an example on how to operate the menus.

Example: Changing [AF Mode] in the [Rec] menu in [Program AE] Mode

1 Press [MENU/SET]

The menu selection screen is displayed.

2 Press ◀▶ to select [Rec] menu and press [MENU/SET]

3 Press ▲▼ to select [AF Mode] and press [MENU/SET]

(A): Pages

The pages can also be selected with the zoom lever.

(B): Menu description

(C): Menu items

(D): Operation guide

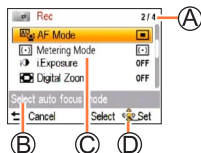

4 Press ▲▼ to select a setting, and then press [MENU/SET]

The selected setting is set.

• To cancel → Press [⏏] button.

(E): Settings

(F): Selected setting

(G): Setting description

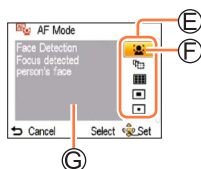

5 Press [⏏] button until the menu closes and the monitor returns to the previous screen

The screen changes each time you press the button.

- The operation screen examples in this manual may differ from the actual screen display or some parts of the screen display are omitted.
- The menu types and items that are displayed vary according to the mode.
- The setting methods vary depending on the menu item.
- Press the shutter button halfway to exit the menu and enter the recording screen.

Menu type

[Rec] menu

(In recording mode only)

Changing picture preferences (→80)

- Enables you to set the coloring, picture size, and other items.

[Motion Picture] menu

(In recording mode only)

Recording motion pictures using your own settings (→91)

- You can select the picture quality, etc.

[Setup] menu

Making the camera more convenient to use (→46)

- Enables you to specify clock settings, sound volume, and so on to make the camera easier to use.

[Playback Mode] menu

(In playback mode only)

Viewing recorded pictures (→92)

- Enables you to see Slide Show or to display pictures separately under the selected categories, etc.

[Playback] menu

(In playback mode only)

Using your pictures (→97)

- Enables you to specify picture protection, resizing, and other settings for pictures you have taken.

● The following menus are also displayed depending on the recording mode.

- In the Scene Mode: Scene menu (→73)
- In the [Creative Control] mode: [Creative Control] menu (→66)

Using Quick menu

During recording, you can easily call some of the menu items and set them.









- 1** Press [Q.MENU] button
- 2** Press ◀▶ to select a menu item
- 3** Press ▲▼ to select the settings
- 4** Press [MENU/SET]

● The menu items and setting items that are displayed differ depending on the recording mode.

Using the [Setup] menu

[Clock Set], [Economy] and [Auto Review] are important for clock setting and battery life. Please check these before use.



- For details about the setting procedure in the [Setup] menu (→43)

Item	Settings, notes
 [Battery] Specify the battery type so that the correct remaining battery power will be displayed.	AL [Alkaline] / Ni-MH [Ni-MH] Select the type of batteries used.
 [Clock Set] (→24, 25)	Set time, date, and display format.
 [Beep] Change or mute the beep/shutter sounds.	 /  /  : Low / High / Mute
 [Volume] Adjust volume of sound from speakers (7 levels).	[0] / [1] / [2] / [3] / [4] / [5] / [6] <ul style="list-style-type: none"> • Cannot be used to adjust TV speaker volume when connected to TV. Also, the camera speaker will not emit any sound.
 [Monitor Display] Adjust brightness and color of the LCD monitor. It is suggested to use the default settings. These are intended to provide a preview of the actual picture, as accurately as possible.	<ol style="list-style-type: none"> ① Press ▲▼ to select the setting item and press ◀▶ to make adjustments ② Press [MENU/SET] <ul style="list-style-type: none"> • Some subjects may look different from their actual appearance, but the recorded picture will not be affected. • Cannot be used to set brightness and contrast when [High Angle] is selected under [Monitor Luminance].

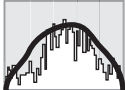

- For details about the setting procedure in the [Setup] menu (→43)

Item	Settings, notes
<p>[MON] [Monitor Luminance] Make LCD monitor easier to see.</p>	<p>[A*] [Auto Power Monitor]: The brightness is adjusted automatically depending on how bright it is around the camera.</p> <p>[☐*] [Power Monitor]: Makes screen brighter than normal (for outdoor use).</p> <p>[Ⓚ] [High Angle]: Makes the LCD monitor screen easier to see when the camera is held above eye level.</p> <p>[OFF]</p> <ul style="list-style-type: none"> • Cannot select [Auto Power Monitor] and [High Angle] in playback mode. • [Power Monitor] returns to ordinary brightness if there is no operation for 30 seconds when recording. (Press any button to make the screen brighter again.) • [High Angle] will be canceled when the camera is turned off (including [Auto Power Off]). • Setting [Monitor Luminance] reduces the operating time. • Because the picture shown on the LCD monitor screen emphasizes brightness, some subjects may look different than their actual appearance, but this will not affect the recorded picture.





- For details about the setting procedure in the [Setup] menu (→43)

Item	Settings, notes
 [Histogram] Check brightness in picture on graph.	<p>[ON] / [OFF]</p> <p>A peak in the center represents correct brightness (correct exposure). This can be used as a reference for exposure correction, etc.</p> <div style="text-align: center;"> <p>(Example)</p>  <p>Dark ← OK → Bright</p> </div> <ul style="list-style-type: none"> • Histogram from time of recording is different to Histogram in playback and displayed in orange, when recording with flash or in dark locations. Also, Histogram may differ from Histograms made with image editing software. • Histogram is not displayed during a performance of  ([Intelligent Auto] Mode), [Panorama Shot] Scene Mode or Playback Zoom.
 [Video Rec Area] Enables verification of the recordable area for a motion picture before recording.	<p>[ON] / [OFF]</p> <ul style="list-style-type: none"> • Recordable area displayed for motion pictures should be interpreted as a guideline. • When using Extended optical zoom, the recordable area may not always be displayed for certain zoom ratios.



- For details about the setting procedure in the [Setup] menu (→43)

Item	Settings, notes
ECO [Economy] Turn off the camera or make the LCD monitor go dark while not using the camera to minimize battery consumption.	 [Auto Power Off] [2 MIN.] / [5 MIN.] / [10MIN.] / [OFF]: Automatically shut off the camera while not in use. <ul style="list-style-type: none"> • To restore → Press the Camera [ON/OFF] button. • Cannot be used in the following cases: When connected to computer/printer, during motion picture recording/playback, during Slide Shows
	 [Monitor Power Save] [ON] / [OFF]: The LCD monitor goes dark to minimize battery consumption. <ul style="list-style-type: none"> • Reduces the picture quality of the LCD monitor display during recording to minimize battery consumption (except for the Digital Zoom area). Note, however, that there is no effect on the recorded picture. • The setting in [Monitor Luminance] is prioritized over the setting in [Monitor Power Save] for the brightness of the LCD monitor.

- For details about the setting procedure in the [Setup] menu (→43)

Item	Settings, notes
 [Auto Review] Automatically display still pictures immediately after taking them.	[ON] / [OFF] <ul style="list-style-type: none"> • Automatically displays still pictures immediately after they are taken, regardless of [Auto Review] setting in [Auto Bracket] and [Burst] modes. • Motion pictures cannot be automatically reviewed. • It is recommended to set [Auto Review] to [OFF] if you want to take the next shot quickly.
 [Reset] Reset to the default settings.	[Reset Rec. settings?] [Reset setup parameters?] <ul style="list-style-type: none"> • When [Setup] settings are reset, [Age] setting in [Baby] Scene Mode is also reset. • Folder numbers and clock settings will not be reset.
 [Output] Change the settings to be used when the camera is connected to a TV or other device.	 [Video Out] (DMC-LZ30PU only.) [NTSC] / [PAL]  [TV Aspect] 16:9 / 4:3

- For details about the setting procedure in the [Setup] menu (→43)

Item	Settings, notes
 [Version Disp.]	Current version is displayed.
 [Format] Use when [Built-In Memory Error] or [Memory Card Error] appears, or when formatting the built-in memory or card. When a card/built-in memory is formatted, the data cannot be restored. Check the content of the card/built-in memory carefully before formatting.	<ul style="list-style-type: none"> • Use batteries with sufficient power. When formatting the built-in memory, remove the cards. (Only inserted card will be formatted if present; built-in memory will be formatted if no card is inserted.) • Always format cards with this camera. • All protected pictures and other picture data will be deleted. • Do not turn off the camera or perform other operations during formatting. • Formatting the built-in memory may take several minutes. • If the card cannot be formatted, please try another card before contacting Panasonic. <div data-bbox="366 631 951 710" style="background-color: black; color: white; padding: 5px;"> For USA and Puerto Rico assistance, please call: 1-800-211-PANA(7262) or, contact us via the web at: http://www.panasonic.com/contactinfo </div> <div data-bbox="366 729 951 783" style="background-color: black; color: white; padding: 5px;"> For Canadian assistance, please call: 1-800-99-LUMIX (1-800-995-8649). </div>
 [Language] Change display language.	Set the language displayed on the screen.

Changing recording information display

Change between different LCD monitor displays, such as Histograms.

1 Press [DISP.] button to change display

DISP.

■ In Recording Mode

Recording information,
Number of recordable
pictures*

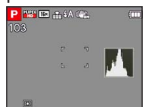

Recording information,
Available recording
time*

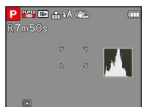

No display



Guide lines*

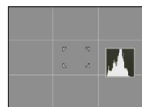

■ In Playback Mode

Picture
information

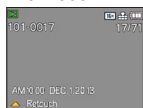

Recording
information*

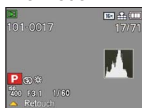

No display



* Set [Histogram] to display a histogram. (→48)

- During Playback Zoom, Motion Picture Playback, Panorama Playback or Slide Show: You can only turn on and turn off the display.
- During menu display, Multi Playback or [Calendar]: Display cannot be changed.

Using Zoom

Recording mode:

You can adjust the area of a picture to be taken using zoom.

1 Zoom In/Out

Capture a wider area (wide-angle)



Enlarge the subject (telephoto)

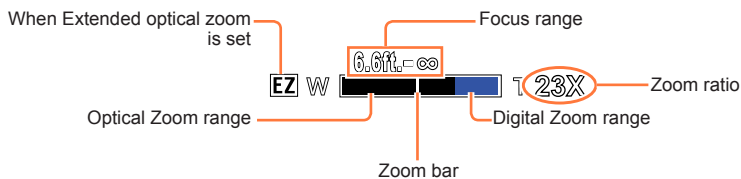

- Adjust the focus after adjusting the zoom.
- Do not touch the lens barrel during zooming.
- The zoom ratio and the zoom bar displayed on the screen are estimates.
- The camera may make a rattling noise and vibrate when the zoom lever is operated - this is not a fault.

Zoom types and use

The zoom ratio changes when the picture size is changed. (→80)

■ Optical Zoom

Zooming in up to 35x is possible if pictures without  have been selected by [Picture Size] on the [Rec] menu.

- Optical Zoom cannot be used in the following cases:
 - Scene Mode ([Panorama Shot])
 - [Macro Zoom]
- The optical zoom ratio cannot be changed after starting to record motion pictures.

■ Extended optical zoom

Zooming in up to 78.8x is possible when pictures with  have been selected by [Picture Size] on the [Rec] menu.
EZ is short for “Extended optical zoom”.

- Extended optical zoom cannot be used in the following cases:
 - Motion picture
 - Scene Modes ([Panorama Shot] [HDR] [High Sens.])
 - When the [Burst] setting is set to 
 - [Macro Zoom]

To increase the zoom ratio further, the following zoom can be used in combination.

■ [Digital Zoom]

Zoom 4x further than Optical/Extended optical zoom. Note that, with Digital Zoom, enlarging will decrease picture quality. Set the [Digital Zoom] in the [Rec] menu to [ON]. (→86)

- Digital Zoom cannot be used in the following cases:
 - [Intelligent Auto] Mode
 - Scene Modes ([Panorama Shot] [HDR] [High Sens.])
 - When the [Burst] setting is set to 



Taking pictures with flash

Recording mode:        

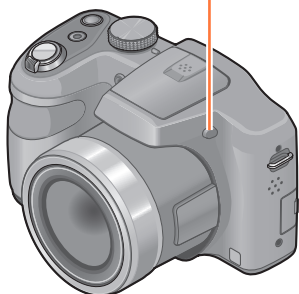
Flash open button



■ To open the flash

Press  OPEN

- Be sure to close the flash when not in use.

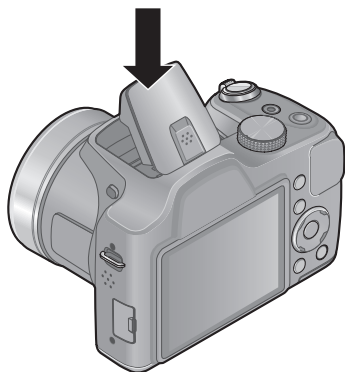

■ To close the flash

Press the flash until it clicks.

- The flash setting is fixed to  [Forced Flash Off] while the flash is closed.

● Be careful not to catch a finger when closing the flash.

(Continued on the next page)

1 Press **▶** to display [Flash]

2 Use cursor button to select the desired type and press **[MENU/SET]**

Type, operations		Uses
[Auto] *1 • Automatically judges when to use flash		Normal use
[Auto/Red-Eye]*2 • Automatically judges when to use flash (reduces red-eye)		Taking pictures of subjects in dark places
[Forced Flash On] • Always uses flash		Taking pictures with backlight or under bright lighting (e.g. fluorescent)
[Slow Sync./Red-Eye]*2 • Automatically judges when to use flash (reduces red-eye; slow shutter speed to take brighter pictures)		Taking pictures of subjects against a nightscape (tripod recommended)

*1 Only in the **[fA]** mode

*2 Two flashes will be emitted. Do not move until after the second flash.

If [Red-Eye Removal] on the [Rec] menu is [ON], the appears with the flash icon, red-eye is automatically detected and still picture data is corrected. (Only when [AF Mode] is (Face Detection))

(Continued on the next page)

- The effect of red-eye reduction varies depending on the subject and is affected by factors such as distance to the subject, whether the subject is looking at the camera during preliminary flash, and so on. In some cases, the effect of red-eye reduction may be negligible.
- **Do not put your hands over the light-emitting area of the flash or look at it from close range.**
Do not use the flash at close distances to other subjects (heat/light may damage subject).

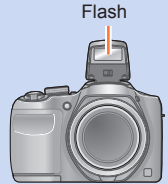

- Flash settings may be changed when changing recording mode.
- Scene Mode flash settings are restored to default when Scene Mode is changed.
- Edges of picture may become slightly dark if using flash at short distances without using zoom (close to max. Wide). This may be remedied by using a little zoom.
- If light from the flash on a subject is insufficient, neither the proper exposure nor White Balance is achieved.
- No pictures may be taken if these marks (e.g. ) are flashing (flash is charging).
- Flash charging may take time if battery is low or if using flash repeatedly.

■ Available types in each mode (○: Available, –: Not available, □: Default setting)

	iA	P	M			[Scene Mode]			
	○*1	○	○	○	○	–	○	○	○
	–	○	○	○	–	–	–	○	–
	–	○	○	○	○	–	○	○	○
	–	○	–	–	–	○	–	–	–

*1 Set to A, A[Ⓞ], S[Ⓞ] or S depending on the subject and brightness.

- The flash cannot be used in the following cases.
 - Recording motion pictures
 - The following Scene Modes:
[Panorama Shot] [Night Scenery] [HDR] [Sunset]

■ The available flash range when [Sensitivity] setting is [AUTO]

Max. Wide	Approx. 60 cm - 10.0 m (2.0 - 33 feet)
Max. Tele	Approx. 1.5 m - 5.0 m (4.9 - 16 feet)

■ Shutter speeds for each flash mode

A A [Ⓞ]	1/60*2 - 1/2000th
S [Ⓞ]	1*2 - 1/2000th

*2 Differs for each mode other than P mode.

Taking close-up pictures

Recording mode:   SCN    

When you want to enlarge the subject, setting to [AF Macro] (AF ) enables you to take pictures at an even closer distance than the normal focus range (up to 1 cm (0.033 feet) for max. Wide).

1 Press **▼** to display [Macro Mode]

2 Use cursor button to select [AF Macro] and press [MENU/SET]



Focus range

When a subject is too close to the camera, the picture may not be properly focused. The shortest recording distance differs depending on the zoom ratio and the setting in macro recording mode.

■ Shortest recording distance

The shortest recording distance is the distance from the lens front to the subject. This distance changes gradually depending on the zoom position. At the time of zooming, even if [Macro Mode] is set to [AF Macro] (AF👉), the shortest recording distance is the same as when the mode is set to OFF.

Zoom	[Macro Mode]	
	[AF👉]	[OFF]
Max. Wide	1 cm (0.033 feet)	30 cm (0.98 feet)
Max. Tele	1.5 m (4.9 feet)	2 m (6.6 feet)

- Focus range is displayed when operating the zoom, etc.



- It may take some time until distant subjects come into focus.
- Using a tripod and [Selftimer] is recommended. Also, when recording a subject that is close to the camera, we recommend that you close the flash to set to  (Forced flash off).
- Moving the camera after aligning the focus is likely to result in poorly focused pictures if subject is close to the camera, due to the margin for focus alignment being severely reduced.
- Resolution may be reduced around the edges of the picture.

[Macro Zoom]

To take even larger images of the subject, setting to [Macro Zoom] enables the subject to appear even larger than when using [AF Macro].

- 1 Press **▼** to display [Macro Mode]
- 2 Use cursor button to select [Macro Zoom] and press [MENU/SET]
- 3 Adjust the Digital Zoom magnification with the zoom lever

The zoom position is fixed at the max. Wide. Focus range is 1 cm (0.033 feet) - ∞.



- In [Macro Zoom], higher magnification results in lower picture quality.
- When [Macro Zoom] is set, Extended optical zoom does not work.
- When [AF Tracking] or  [Hi-Speed Burst] is set, macro zoom is canceled.

Taking pictures with self-timer

Recording mode:        

We recommend using a tripod. This is also effective for correcting jitter when pressing the shutter button, by setting the self-timer to 2 seconds.

1 Press  to display [Selftimer]

2 Use cursor button to select time duration and press [MENU/SET]

3 Take a picture

Press the shutter button fully to start recording after the preset time.

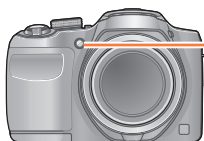
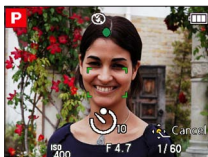

Self-timer indicator
(Flashes for set duration)

• To cancel while in operation → Press [MENU/SET]

- After Self-timer indicator stops flashing, it may then be lit for AF Assist Lamp.
- You cannot use the self-timer for motion picture recording.

Taking pictures with Exposure Compensation

This feature allows the user to manually adjust the exposure when a proper auto exposure cannot be obtained.

■ Recording mode:   M      

1 Press **▲** to display [Exposure]

2 Use cursor button to select a value and press [MENU/SET]

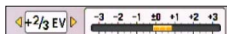

- If the picture is too dark, adjust the exposure to the “+” direction.
- If the picture is too bright, adjust the exposure to the “-” direction.
- After exposure adjustment, the adjustment value ( for example) is displayed in the bottom-left corner of the screen.

- Depending on the brightness, this may not be possible in some cases.
- The Exposure Compensation value you set is retained even after the camera is turned off.

[Auto Bracket]

Records 3 pictures in continuous succession while exposure is changed automatically. After exposure adjustment, the adjustment value is set as the standard.

■ Recording mode:        

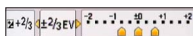
1 Press ▲ several times to display [Auto Bracket]**2 Use cursor button to select a value and press [MENU/SET]**

Value displayed after
Exposure Compensation set

- The first still picture is recorded without compensation, the second still picture is recorded with exposure adjusted in the “-” direction, and the third still picture is recorded with exposure adjusted in the “+” direction.

- Cannot be used with flash.
- When [Auto Bracket] is set, [Burst] is canceled.
- Canceled when the camera is turned off.
- [Auto Bracket] cannot be used in the following cases:
 - Scene Modes ([Panorama Shot] [HDR])
 - Recording motion pictures

Determining aperture and shutter speed and recording [Manual Exposure] Mode

Recording mode: P M SCN A S B

This mode allows the user to manually set the aperture value and shutter speed. It may be useful when adverse conditions do not allow the auto exposure to produce an acceptable picture. A long exposure, up to 15 seconds is possible. For long exposures a tripod is recommended.

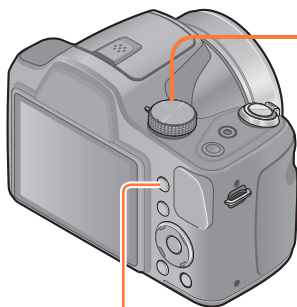

[EXPOSURE] button

- 1 Set mode dial to M**
([Manual Exposure] Mode)



- Manual exposure assist is displayed.

- 2 Press [EXPOSURE] button and use cursor button to determine aperture value and shutter speed**



Aperture value/
shutter speed

- 3 Press [EXPOSURE] button**

■ Recording motion pictures in M

- Aperture and shutter speed are automatically set.

■ Manual exposure assist (estimate)

If the shutter button is pressed halfway, manual exposure assist is displayed.

	Shows pictures with standard brightness.
	Shows brighter pictures. For standard brightness, either use a faster shutter speed or increase aperture value.
	Shows darker pictures. For standard brightness, either use a slower shutter speed or reduce aperture value.

- When the picture is too bright or too dark or there is incorrect exposure, the numbers for the aperture value and shutter speed are shown in red.
- LCD monitor brightness may vary from the actual still picture recorded.

Taking Pictures with different picture effects

[Creative Control] mode

Recording mode:  P M SCN    

You can select your own settings from various effects and take pictures while confirming these effects on the LCD monitor.

1 Set mode dial to

2 Press to select an effect, and press [MENU/SET] (→67 - 69)



- When you press [DISP.] button, a description of the selected effect is displayed.

■ Changing the selected picture effects ([Creative Control] menu)

- ① Press [MENU/SET]
- ② Use cursor button to select [Creative Control] menu and press [MENU/SET]
- ③ Press   to select an effect, and press [MENU/SET]

■ Recording motion pictures in

- Records a motion picture at the optimum settings for the selected effects.
- A motion picture cannot be recorded using [Impressive Art] in [Creative Control] Mode.

- The flash is set to  [Forced Flash Off]. (→55)
- The display of a picture reflecting a selected effect in the preview screen or recording screen may differ from the actual recorded pictures.
- A setting that was selected in [Creative Control] mode is retained even after the camera is turned off.
- Following [Rec] menu settings will be automatically adjusted and cannot be selected manually.
[Sensitivity] [White Balance] [i.Exposure] [Color Mode]

For the [Creative Control] menu setting procedures. (→66)

[Expressive]

This effect emphasizes the color to make a pop art picture.



[Retro]

This effect gives a faded image.

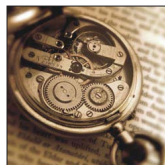

[High Key]

This effect adds a bright, airy and soft feel to the overall image.



[Low Key]

This effect adds a dark and relaxing feel to the overall image and enhances bright parts.



For the [Creative Control] menu setting procedures. (→66)

[Sepia]

This effect creates a sepia image.



[Dynamic Monochrome]

This effect gives a higher contrast to create an impressive black and white picture.



[Impressive Art]

This effect gives your photo a dramatic contrast look.



[High Dynamic]

This effect produces the optimum brightness for both dark and bright parts.

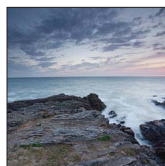

For the [Creative Control] menu setting procedures. (→66)

[Cross Process]

This effect gives your photo a dramatic color look.

■ Adjusting color

Use cursor button to adjust coloring, then press [MENU/SET]

- Settings: Greenish coloring / Bluish coloring / Yellowish coloring / Reddish coloring

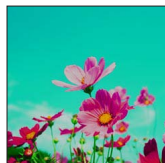

[One Point Color]

This effect leaves one selected color to emphasize impressiveness.

■ Selecting color

- ① Select the color to be retained using the frame in the center of the screen and press [MENU/SET]
- ② Check the effect in the preview screen and press [MENU/SET]
 - The next time this effect is used, the preview screen will display a picture with the settings of the color selected previously.
 - To reselect a color: Press the [DISP.] button
 - To record with current settings: Press [MENU/SET]



- The selected color may not be retained for some subjects.

Taking pictures of people [Portrait] Mode

Recording mode: P M SCN

Improves the skin tone of subjects for a healthier appearance in bright daylight conditions.

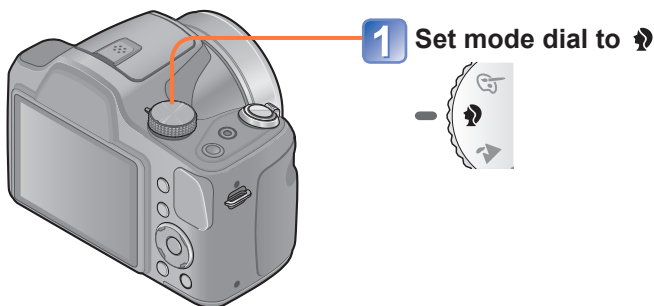

■ Tips

- The more the zoom is drawn towards T side and the closer the camera is brought to the subject, the greater the effect will be.

■ Recording motion pictures in

Records a motion picture at the optimum settings when the subject is people.

Taking pictures of scenery [Scenery] Mode

Recording mode: P M SCN

Takes clear pictures of wide, distant subjects.

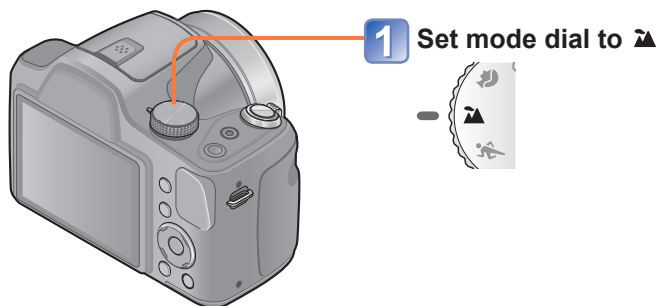

■ Recording motion pictures in

Records a motion picture at the optimum settings when the subject is scenery.

● The flash is set to [Forced Flash Off]. (→55)

Taking pictures of sporting events

[Sports] Mode

Recording mode:  P M SCN    

Takes pictures of scenes with fast movement, e.g. sports.

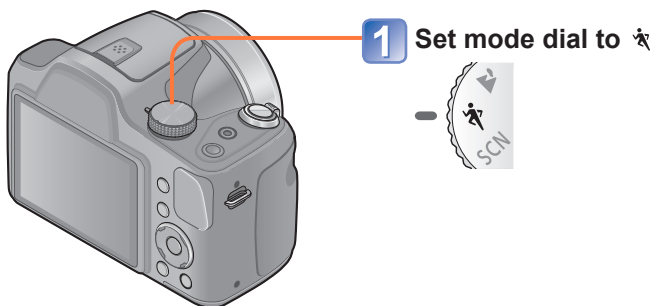

■ Tips

- Stand at least 5 m (16 feet) away.

■ Recording motion pictures in

The recording mode changes to Normal motion picture.

- Sports mode requires adequate lighting, to enable the higher shutter speed to be used. This mode may not product acceptable results when shooting indoors, under limited lighting.
- About flash (→58)

Taking pictures according to the scene

[Scene Mode]

Recording mode: P M SCN A S B

Using [Scene Mode] enables you to take pictures with optimum settings (exposure, coloring, etc.) for given scenes.

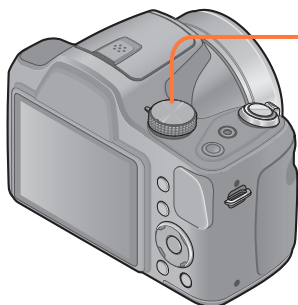

1 Set mode dial to SCN



2 Use cursor button to select the scene and press [MENU/SET]

■ Changing the selected scene mode ([Scene Mode] menu)

- ① Press [MENU/SET]
- ② Use cursor button to select [Scene Mode] menu and press [MENU/SET]
- ③ Use cursor button to select the scene and press [MENU/SET]

■ Recording motion pictures in SCN

Records a motion picture at the optimum settings for the selected scene.

- A motion picture cannot be recorded in [Panorama Shot] Scene Mode.
- Some scenes are switched to the following scenes:

Selected scene	Scenes for motion picture
[Baby]	Portrait motion picture
[Night Portrait] [Night Scenery]	Low light motion picture
[HDR]	Normal motion picture

- Selecting a Scene Mode inappropriate for the actual scene may affect the coloring of your picture.
- Following [Rec] menu settings will be automatically adjusted and cannot be selected manually.
[Sensitivity] [Metering Mode] [i.Exposure] [Color Mode]
- Using flash in Scene Modes (→58)

- How to select a scene (→73)
- Using flash in Scene Modes (→58)

[Panorama Shot]

Creates a single panorama picture by stitching 3 still pictures.

- 1 Use cursor button to select the recording direction, and press [MENU/SET] to set**
- 2 Check the recording direction and press [MENU/SET]**
Special panorama guidelines will be displayed during recording.
- 3 Press the shutter button halfway to focus**
- 4 Press the shutter button fully to start recording**

(Example) Taking pictures from left to right

Ⓐ indicates the recording progress.

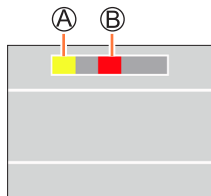

Ⓑ is displayed after the first picture is taken.

- Do not move the camera until Ⓑ is displayed.
- Carefully pan the camera horizontally until Ⓐ overlaps on Ⓑ and the shutter snaps automatically.

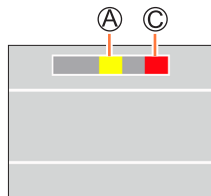

Ⓒ is displayed after the second picture is taken.

- Do not move the camera until Ⓒ is displayed.
- Carefully pan the camera horizontally until Ⓐ overlaps on Ⓒ and the shutter snaps automatically.

- Recording ends automatically after the 3 pictures are taken.

(Continued on the next page)

- The zoom position is fixed to the max. Wide.
- The focus, exposure and White Balance are all fixed to optimal values for the first picture.
If the focusing or brightness of pictures recorded as part of a Panorama picture after the first picture are significantly different from those of the first picture, the Panorama picture as a whole (when all pictures are stitched together) may not have consistent focus and brightness.
- The following functions are fixed to the settings indicated below.
[Stabilizer]: [OFF] [Date Stamp]: [OFF]
- Since several pictures are stitched together to create a Panorama picture, some subjects may be distorted or the joining portions of successively taken pictures that are stitched may be noticeable.
- Panorama pictures may not be created or pictures may not be recorded properly when taking pictures of the following subjects or when taking pictures in the following recording conditions:
 - Subjects that have a continuous monotone or pattern (sky, beach, etc.)
 - Moving subjects (person, pet, vehicle, waves, or flowers swaying in the wind, etc.)
 - Subjects whose colors or patterns change quickly (such as an image appearing on a display)
 - Dark locations
 - Locations with a flickering light source (fluorescent lamp, candle light, etc.)

■ About panorama playback

You can operate the zoom lever to enlarge still pictures taken in [Panorama Shot] Scene Mode in the same way as with other still pictures (Playback Zoom →38). You can also press ▲ to automatically scroll pictures in the same way as when playing back a motion picture (Motion Picture Playback →40).

- Unlike motion picture playback, you cannot perform fast forward or fast rewind by pressing ◀ or ▶ while the pictures are scrolling automatically. (You can perform single-frame forward or rewind while the automatic scrolling operation is paused.)

- How to select a scene (→73)
- Using flash in Scene Modes (→58)

[Night Portrait]

Takes pictures of people and nightscapes with close to actual brightness.

■ Tips

- Use flash.
- Subject should not move.
- Tripod, self-timer recommended.

[Night Scenery]

Takes clear pictures of night scenes.

■ Tips

- Tripod, self-timer recommended.

- Shutter speed may slow down up to 8 seconds.
- After recording, the shutter may stay closed (up to 8 seconds) to process the signal. This is not a malfunction.

- How to select a scene (→73)
- Using flash in Scene Modes (→58)

[HDR]

The camera can combine several still pictures taken with different exposures into a single properly exposed picture with rich gradation. The individual pictures used to create the HDR picture are not saved. You can minimize the loss of gradations in bright areas and dark areas when, for example, the contrast between the background and the subject is large.

■ What is HDR?

HDR stands for High Dynamic Range and refers to a technique for expressing a wide contrast range.

1 Select the aspect ratio and the picture size with cursor button and press [MENU/SET]

■ Settings: **4:3** 3M / **3:2** 2.5M / **16:9** 2M / **1:1** 2.5M

■ Tips

- After the shutter button has been pressed, do not move the camera during the burst operation.
- Since a burst of still pictures are combined after they have been recorded, it will be a few moments before you will be able to record another picture.
- A subject that was in motion when it was recorded may be recorded as an afterimage.
- The camera may take a single still picture instead of several pictures under certain recording conditions.

- How to select a scene (→73)
- Using flash in Scene Modes (→58)

[Food]

Takes natural-looking pictures of food.

[Baby]

Taking pictures of a baby with a healthy complexion.

- 1** Use cursor button to select [Age] and press [MENU/SET]
- 2** Use cursor button to select [SET] and press [MENU/SET]
- 3** Set birthday with cursor button, and press [MENU/SET]
- 4** Use cursor button to select [Exit] and press [MENU/SET]

■ Tips

- Make sure [Age] is [ON] before taking a picture.

● [Age] print setting can be made on your computer using "PHOTOfunSTUDIO" on the supplied CD-ROM.

- How to select a scene (→73)
- Using flash in Scene Modes (→58)

[Sunset]

Takes clear pictures of scenes such as sunsets.

[High Sens.]

Prevents blurring of subject in dark, indoor conditions.

1 Select the aspect ratio and the picture size with cursor button and press [MENU/SET]

■ Settings: **4:3** 3M / **3:2** 2.5M / **16:9** 2M / **1:1** 2.5M

Using the [Rec] menu

- For [Rec] menu setting procedures (→43)

[Picture Size]

Set the size (number of pixels) of still pictures. Number of pictures which can be recorded depends on this setting and on [Quality].

■ Recording mode:

■ Settings:

Recording pixel level type		
	16M	4608x3456
	10M	3648x2736
	5M	2560x1920
	3M	2048x1536
	0.3M	640x480
	14M	4608x3072
	12M	4608x2592
	12M	3456x3456

* This setting is not available in ([Intelligent Auto] Mode).

- represent the aspect ratios of the still pictures.
- Mosaic effect may appear depending on subject and recording conditions.
- [Picture Size] cannot be used in [Panorama Shot] Scene Mode.

Setting guide

Larger picture size	←→	Smaller picture size
Sharper		Less detailed
Lower recording capacity		Higher recording capacity

- For [Rec] menu setting procedures (→43)

[Quality]

Set quality of picture.

■ **Recording mode:**

■ **Settings:** High quality, priority to picture quality
 Standard quality, priority to the number of pictures

- The setting is fixed to in the following cases:
 - Scene Modes ([HDR] [High Sens.]

[Sensitivity]

Set ISO Sensitivity (sensitivity to lighting) manually.

We recommend higher settings to take clear pictures in darker locations.

■ **Recording mode:**

■ **Settings:** [AUTO] / [100] / [200] / [400] / [800] / [1600]

Setting guide

[Sensitivity]	[100] ←→ [1600]
Location (recommended)	Bright (outdoors) Dark
Shutter speed	Slow Fast
Interference	Low High
Subject blur	High Low

- [AUTO] is automatically set in a range up to 1600 based on subject brightness.
- [AUTO] cannot be selected in [Manual Exposure] Mode.
- The [Sensitivity] is automatically set in the following case:
 - When recording motion pictures

- For [Rec] menu setting procedures (→43)

[White Balance]

Adjust the color depending on the light source to ensure natural color.

■ **Recording mode:**

■ **Settings:** [AWB] (automatic) / (outdoor, clear sky) / (outdoor, cloudy sky) / (outdoor, shade) / (Incandescent lighting) / (uses value set in _SET) / _SET (set manually)

- When [AWB] (Automatic White Balance) is set, the coloring is adjusted in accordance with the light source. However, if the scene is too bright or too dark or if other extreme conditions apply, the pictures may appear reddish or bluish. The White Balance may not operate correctly if there is a multiple number of light sources.
- Under fluorescent lighting, LED lighting fixture etc., the appropriate White Balance will vary depending on the lighting type, so use [AWB] or _SET.
- White Balance setting is fixed to [AWB] in the following cases:
 - Scene Modes ([Night Portrait], [Night Scenery], [Food], [Sunset])



■ White Balance fine adjustment (excluding [AWB])

White Balance settings can be individually fine tuned if colors still do not appear as anticipated.

- ① Select the white balance to be fine-tuned, and press the [DISP.] button to display the [WB Adjust.] screen.
- ② Adjust with if red is strong, adjust with if blue is strong.
- ③ Press [MENU/SET].
 - Settings are remembered even if the camera is turned off.
 - Settings remain applied when using flash.
 - Fine adjustments cannot be made when [Color Mode] (→88) is set to [B&W] or [SEPIA].
 - The White Balance fine adjustment level in returns to [0] when you reset the White Balance using _SET.

(Continued on the next page)

■ Setting White Balance manually (SET)

- ① Select  SET and press [MENU/SET].
- ② Point the camera towards a white object (e.g. paper) and press [MENU/SET].
 - White Balance is set to .
 - Even if the camera is turned off, the set White Balance is remembered.
 - Adjust the brightness and try to set the White Balance.

■ [AWB] operational range:

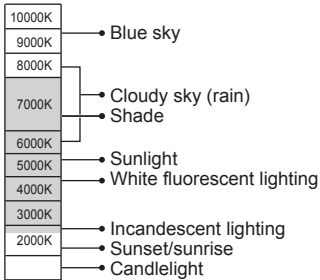

K=Kelvin color Temperature

- For [Rec] menu setting procedures (→43)

[AF Mode]

Method of aligning focus can be changed according to position and number of subjects.









■ **Recording mode:**

■ **Settings:** / / / /

<p>Taking front-on pictures of people</p> <p> (Face Detection)*</p>	<p>Recognizes faces (up to 10 people) and adjusts exposure and focus accordingly.</p> <p>AF area Yellow : When the shutter button is pressed halfway, the frame turns green when the camera is focused. White : Displayed when more than one face is detected. Other faces that are the same distance away as faces within the yellow AF area are also focused.</p>
<p>Automatically locking the focus on a moving subject</p> <p> (AF Tracking)*</p>	<p>Align the AF Tracking frame with the subject, and then press ▼.</p> <p>AF Tracking frame When the subject is recognized, the AF Tracking frame changes from white to yellow, and the subject is automatically kept in focus. If AF Lock fails, a red frame flashes.</p> <ul style="list-style-type: none"> • To release AF tracking →Press ▼. • Focus range (same as macro recording) (→60)
<p>Subject not centered in picture</p> <p> (9-area-focusing)*</p>	<p>Focuses on up to 9 points.</p>
<p>Determined position for focus</p> <p> (1-area-focusing) (Spot-focusing)*</p>	<p>1-area-focusing: Focuses on AF area in center of picture. (Recommended when focus is difficult to align) Spot-focusing: Focuses on smaller, limited area.</p>

* (1-area-focusing) will be used during motion picture recording.

(Continued on the next page)



- Cannot set to  (Face Detection) in the following case:
 - Scene Modes ([Panorama Shot] [Night Scenery] [Food])
- If the camera misinterprets a non-human subject as a face in  (Face Detection) setting, switch to another setting.
- If conditions prevent the face from being recognized, such as when the movement of the subject is too rapid, the [AF Mode] setting switches to  (9-area-focusing).
- Use  (1-area-focusing) if focus is difficult to align with  (Spot-focusing).
- When  (AF Tracking) does not work, focus will be on  (1-area-focusing).
- Cannot set to  (AF Tracking) in the following cases.
 - [Panorama Shot] Scene Mode
 - [Creative Control] Mode ([Sepia] [Dynamic Monochrome] [High Dynamic])
 - [B&W] and [SEPIA] in [Color Mode]

[Metering Mode]

You can change the position for measuring brightness when correcting exposure.

■ Recording mode:        

■ Settings

[Metering Mode]	Brightness measurement position	Conditions
 [Multi Metering]	Whole screen	Normal usage (produces balanced pictures)
 [Center Weighted]	Center and surrounding area	Subject in center
 [Spot]	Center and close surrounding area	Great difference between brightness of subject and background (e.g. person in spotlight on stage, backlighting)

- For [Rec] menu setting procedures (→43)

[i.Exposure]

Automatically adjusts contrast and exposure to give more lifelike colors when there is significant contrast between background and subject.

- **Recording mode:**  **P** **M** **SCN**    
- **Settings:** [ON] / [OFF]

[Digital Zoom]

Zoom 4x further than Optical/Extended optical zoom. (Note that enlarging will decrease picture quality with Digital Zoom.)

- **Recording mode:**  **P** **M** **SCN**    
- **Settings:** [ON] / [OFF]

- This is fixed to [ON] when [Macro Zoom] is set.



- For [Rec] menu setting procedures (→43)

[Burst]

A burst of still pictures can be recorded while the shutter button is pressed fully.

■ **Recording mode:**        

■ **Settings:**

Setting	Description										
	<p>Speed: Approx. 1 picture/sec.</p> <ul style="list-style-type: none"> • You can record a series of still pictures successively until the card or built-in memory is full, but at some point the burst speed drops. (The timing at which the burst speed drops varies depending on the type of card and the number of recording pixels.) • Focus and exposure are fixed in the first picture. • When [Selftimer] is set, 3 pictures are taken. • When burst is selected, the flash is unavailable. 										
 [Hi-Speed Burst]	<p>Speed: Approx. 3 pictures/sec.</p> <ul style="list-style-type: none"> • Number of pictures taken using burst* Approx. 10 pictures or more * The number of pictures that can be taken using burst varies depending on the recording conditions and the type of card. • Focus, exposure and White Balance are fixed in the first picture. • [Sensitivity] is automatically adjusted. • When [Selftimer] is set, 3 pictures are taken. • When burst is selected, the flash is unavailable. • The settings can be made in [Program AE] Mode only. • The picture size is changed in accordance with the aspect ratios of the pictures (→80) prior to the setting. <table border="1"> <tbody> <tr> <td>Picture Aspect Ratio</td> <td>4:3</td> <td>3:2</td> <td>16:9</td> <td>1:1</td> </tr> <tr> <td>Picture Size</td> <td>3M</td> <td>2.5M</td> <td>2M</td> <td>2.5M</td> </tr> </tbody> </table>	Picture Aspect Ratio	4:3	3:2	16:9	1:1	Picture Size	3M	2.5M	2M	2.5M
Picture Aspect Ratio	4:3	3:2	16:9	1:1							
Picture Size	3M	2.5M	2M	2.5M							
[OFF]	The burst function is released.										

(Continued on the next page)

- Burst speed may be reduced if shutter speed is reduced in darker locations.
- With repeated recordings, it may take a while between recordings, depending on the usage conditions.
- It may take a while to store still pictures that were taken using the burst function. If you continue to record while storing, the number of burst pictures that can be taken will be reduced. A high-speed card is recommended when recording using the burst function.
- The burst function cannot be used in the following cases:
 - Scene Modes ([Panorama Shot] [HDR])

[Color Mode]

Set color effects.

- **Recording mode:**
- **Settings:** [STANDARD] / [VIVID] (sharper) / [B&W] / [SEPIA]

[AF Assist Lamp]

Illuminates lamp when dark to facilitate focus alignment.

- **Recording mode:**
- **Settings:** [ON] : Lamp illuminated with halfway press of shutter button
(AF* displayed)
- [OFF] : Lamp off (taking pictures of animals in the dark, etc.)

- The AF Assist Lamp has an effective distance of 1.5 m (4.9 feet).
 - Do not block the lamp with your fingers or look at it from close range.
- The setting is fixed to [OFF] in the following cases:
 - Scene Modes ([Night Scenery] [Sunset])

AF Assist Lamp

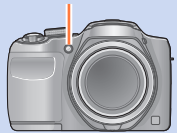

- For [Rec] menu setting procedures (→43)

[Red-Eye Removal]

Automatically detects red-eye and corrects still picture data when recording with flash red-eye reduction (⚡AⓄ ⚡SⓄ).

- **Recording mode:**
- **Settings:** [ON] / [OFF]

- This setting will work only when [AF Mode] is (Face Detection).
- The function will turn [OFF] in the following cases:
 - Scene Modes ([Panorama Shot] [Night Scenery] [HDR] [Food] [Sunset] [High Sens.]
- Depending on the circumstance, it may not be possible to correct red-eye.
- When the function setting is [ON], a appears with the flash icon.

[Stabilizer]

Automatically detects and prevents jitter.

- **Recording mode:**
- **Settings:** [ON] / [OFF]

- Cases where Image Stabilizer may be ineffective:
 - Heavy jitter, high zoom ratio (also in the Digital Zoom range), fast-moving objects, indoors or in dark locations (due to low shutter speed)
- When recording a motion picture with a tripod, we recommend that you set the [Stabilizer] to [OFF].

- For [Rec] menu setting procedures (→43)

[Date Stamp]

Still pictures can be taken with the recording date and time stamped on the still picture.

■ **Recording mode:**        

■ **Settings:** [W/O TIME] / [WITH TIME] / [OFF]

- Date stamps on still pictures cannot be erased.
- The date cannot be stamped when [Auto Bracket] or [Burst] is set, when recording a motion picture, or when the [Panorama Shot] Scene Mode is set.
- Do not request date printing in store or make date printing on printer for still pictures with date stamps. (Date printing may be overlapped.)
- Cannot change the setting in [Intelligent Auto] Mode. The setting in other Recording Mode is applied.

[Clock Set]

Set the clock. Same function as that in [Setup] menu. (→25)

Using the [Motion Picture] menu

- For [Motion Picture] menu setting procedures (→43)

[Rec Quality]

Set the picture size of motion pictures.

■ **Recording mode:**        

■ **Settings:**

Picture Quality	Picture Size	No. of Frames	Picture Aspect Ratio
[HD]	1280x720	30 fps	16:9
[VGA]	640x480		4:3
[QVGA]*	320x240		

* [QVGA] is fixed when recording to the built-in memory.

- Depending on the motion picture recording environment, static electricity or electromagnetic waves may cause the screen to go black momentarily or noise to be recorded.
- When recording motion pictures, it is recommended to use batteries with sufficient power.
- If you attempt to play motion pictures recorded with the camera on other devices, playback may not be possible, or the picture or sound quality may be poor. Additionally, incorrect recording information may be indicated.

[Continuous AF]

Either allow the focus to be constantly adjusted during motion picture recording, or fix the focus position at the start of recording.

■ **Recording mode:**        

■ **Settings:** [ON]

[OFF]: Fix focus position at the start of motion picture recording.

Different playback methods [Playback Mode]

Recorded pictures can be played back in a variety of ways.

- 1 Press the Playback button**
- 2 Press [MENU/SET]**
- 3 Use cursor button to select [Playback Mode] menu and press [MENU/SET]**
- 4 Use cursor button to select the playback method and press [MENU/SET]**
 - [Normal Play] (→37)
 - [Slide Show] (→93)
 - [Category Selection] (→94)
 - [Calendar] (→39)

- When no card is inserted, pictures are played back from the built-in memory.
- The [Playback Mode] automatically becomes [Normal Play] when switching from recording mode to playback mode.

- For switching [Playback Mode] (→92)

[Slide Show]

Automatically play pictures in order. Recommended when viewing on TV screen.

1 Use cursor button to select the playback method and press [MENU/SET]

[All]	Play all.
[Category Selection]	Select category and play back motion or still pictures. (Select category with cursor button and press [MENU/SET].) (→94)

2 Use cursor button to set playback effects and press [MENU/SET]

[Effect]	
[ON] / [OFF]	
[Setup]	
[Duration]	[1 SEC.] / [2 SEC.] / [3 SEC.] / [5 SEC.] (Only available when [Effect] is [OFF])
[Repeat]	[ON] / [OFF]

3 Select [Start] with cursor button and press [MENU/SET]

■ Operations during Slide Show

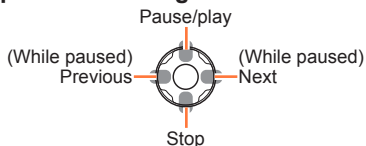













- When panorama pictures are played back, the [Duration] setting is disabled.
- Motion pictures cannot be played back in a Slide Show. The initial screens of motion pictures are played back as still pictures in the Slide Show.

- For switching [Playback Mode] (→92)

[Category Selection]

You can narrow down the pictures displayed to view only a selected category.

1 Select category with cursor button and press [MENU/SET]

	Recording information such as Scene Modes
	[Portrait] /  / [Night Portrait] /  / [Baby]
	[Scenery] /  / [Panorama Shot] / [Sunset] / 
	[Night Portrait] /  / [Night Scenery] / 
	[Sports]
	[Baby]
	[Food]
	[Motion Picture]

[Calendar]

You can specify the recording date to search pictures. (→39)

Retouching pictures [Creative Retouch]

You can retouch recorded still pictures by selecting the effect that you want to apply.

- New pictures are created after editing pictures with [Creative Retouch]. Before starting to edit, make sure that there is enough free space in the built-in memory or memory card.

1 Select a still picture to retouch during playback and press ▲

2 Press ▲ ▼ to select an effect

- The picture retouched with the selected effect is displayed. (→96)
For the following picture effects, see the corresponding effects of [Creative Control] Mode.
[Retro] [High Key] [Low Key] (→67)
[Sepia] [Dynamic Monochrome] [Impressive Art] [High Dynamic] (→68)
- When [OFF] is selected, you can restore a picture to its original condition (before retouching).
- When you press [DISP.] button, a description of the selected effect is displayed.

3 Press [MENU/SET]

- A confirmation screen is displayed. If you select [Yes], the new retouched still picture is saved.

■ Operation from the [Playback] menu

- ① Select [Creative Retouch] in the [Playback] menu, and then press [MENU/SET]
- ② Use cursor button to select a still picture and press [MENU/SET]
Read Step 2 above to perform further steps.

- The retouch effect may be less apparent in some still pictures.
- The image effect may appear weak compared to the effect given by the [Creative Control] Mode.
- It may not be possible to retouch still pictures recorded with other cameras.
- [Creative Retouch] is unable to be performed in the following cases:
 - Motion pictures
 - Panorama pictures

For the setting procedures of [Creative Retouch] (→95)

[Toy Effect]

This effect reduces peripheral brightness to give the impression of a toy camera.

■ Adjusting color

Use cursor button to adjust coloring, then press [MENU/SET]

- Settings: Orangish color \longleftrightarrow Bluish coloring



[Miniature Effect]

This effect blurs peripheral areas to give the impression of a diorama.

■ Selecting direction

Use the cursor button to select the direction in which the effect is applied, and then press [MENU/SET].

- Settings: Horizontal / Vertical



[Star Filter]

This effect transforms pin-points of light into a star effect.



[One Point Color]

This effect leaves one selected color to emphasize impressiveness.

■ Selecting color

Use cursor button to move the frame in the center of the screen, select the color to retain, and then press [MENU/SET].



- The selected color may not be retained for some subjects.

Using the [Playback] menu

You can edit the picture (for example, cropping), and set a protection setting in the picture.

- For [Playback] menu display and operation methods (→43)

- In the following cases, new pictures are created after they have been edited. Before starting to edit, make sure that there is enough free space in the built-in memory or memory card.

- [Creative Retouch]
- [Resize]
- [Cropping]

- It may not be possible to set or edit pictures taken with other cameras.

[Creative Retouch]

For details (→95)

[Resize]

Picture size can be reduced to facilitate e-mail attachment and use in web pages, etc. (Still pictures recorded at the smallest recording pixel level cannot be further reduced.)

■ [SINGLE]

1 Use cursor button to select [SINGLE] and press [MENU/SET]

2 Use cursor button to select a still picture and press [MENU/SET]

3 Use cursor button to select size and press [MENU/SET]



- Confirmation screen is displayed. If you select [Yes], the operation is executed.

(Continued on the next page)

■ [MULTI]

- 1 Use cursor button to select [MULTI] and press [MENU/SET]
- 2 Use cursor button to select size and press [MENU/SET]
- 3 Use cursor button to select a still picture and press [DISP.] button (up to 50 pictures)

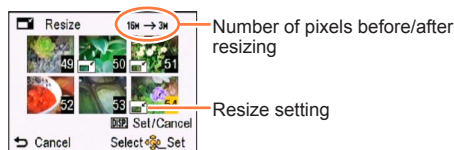

- To cancel
→ Press [DISP.] button again.
- To execute
→ Press [MENU/SET].

• Confirmation screen is displayed. If you select [Yes], the operation is executed.

- Picture quality is reduced after resizing.
- Cannot resize the following pictures.
 - Motion pictures
 - Still pictures that date had already been stamped
 - Still pictures recorded in [Panorama Shot] Scene Mode

- For [Playback] menu display and operation methods (→43)

[Cropping]

Enlarge your still pictures and crop unwanted areas.

1 Use cursor button to select a still picture, and then press [MENU/SET]

2 Select area to crop and press [MENU/SET]

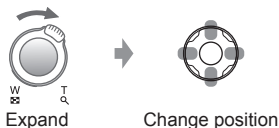

- Confirmation screen is displayed. If you select [Yes], the operation is executed.

- Picture quality is reduced after cropping.
- Cannot crop the following pictures.
 - Motion pictures
 - Still pictures that date had already been stamped
 - Still pictures recorded in [Panorama Shot] Scene Mode

- For [Playback] menu display and operation methods (→43)

[Protect]

Set protection to disable picture deletion. Prevents deletion of important pictures.

1 Use cursor button to select [SINGLE] or [MULTI] and press [MENU/SET]

2 Use cursor button to select picture and press [MENU/SET]

● [SINGLE]

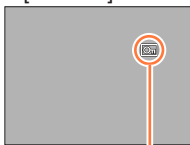

Picture protected

● [MULTI]



Picture protected

- To cancel → Press [MENU/SET] again.

■ To clear all

Select [CANCEL] in step **1** and select [Yes].

- May not be effective when using other devices.

- For [Playback] menu display and operation methods (→43)

[Copy]

You can copy pictures between built-in memory and memory card.

1 Use cursor button to select the copy method (direction) and press [MENU/SET]



Copy all pictures from built-in memory to card (go to step 3).



Copy 1 picture at a time from card to built-in memory.

2 Use cursor button to select picture and press [MENU/SET]

3 Use cursor button to select [Yes] and press [MENU/SET]

- To cancel → Press [MENU/SET].

- Copying pictures may take several minutes. Do not turn off the camera or perform other operations during copying.
- If identical names (folder/file numbers) are present in the copy destination, a new folder for copying will be created when copying from built-in memory to card (IN→SD). Identically-named files will not be copied from card to built-in memory (SD→IN).
- The following setting is not copied. Set it again after copying:
 - [Protect]
- Only pictures from Panasonic digital cameras (LUMIX) may be copied.

Viewing on TV screen

You can view pictures on a TV screen by connecting your camera to your TV with the AV cable (supplied).

- Do not use any other AV cables except the supplied one. Doing so may cause malfunction of the camera.

Getting Ready:

- Set [TV Aspect]. (→50)
- Turn off both camera and TV.

1 Connect camera to TV

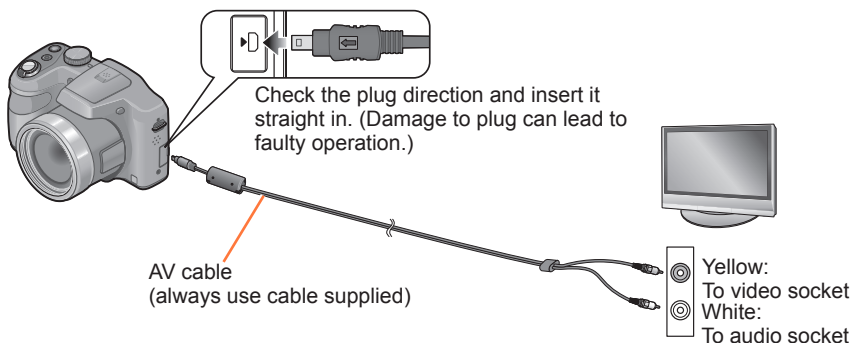

2 Turn on TV

- Set to auxiliary input.

3 Turn on camera

4 Press the Playback button

(Continued on the next page)

■When TVs, DVD recorders or Blu-ray disc recorders have an SD card slot

Insert the SD Memory Card into the SD card slot

- Still pictures can be played back.
- You may not be able to play back panorama pictures. Also you cannot perform automatic scrolling playback of panorama pictures.
- Depending on the TV model, pictures may not be displayed on the full screen.
- Read the operating instructions of compatible equipment to playback motion pictures.
- When using both SDHC and SDXC Memory Cards, be sure to play each type of card in equipment compatible with the particular format.

- Also consult TV operating manual.
- You can play back pictures on TVs in other countries (regions) which use the NTSC or PAL system when you set [Output] in [Setup] menu. (→50) (DMC-LZ30PU only.)
- Change picture mode settings on TV if aspect ratios are not displayed correctly on widescreen or high-definition televisions.
- The camera speaker will not emit any sound and the monitor will not display pictures.

Using with your PC

Still/motion pictures can be copied from the camera to your computer by connecting the two together.

- Some computers can read directly from the camera's memory card.
For details, see the manual for your computer.
- If your computer does not support SDXC Memory Cards a message will be displayed requesting you to format the card. (Do not format the card. This will erase recorded pictures.) If the card is not recognized, refer to the following support website.
<http://panasonic.net/avc/sdcard/information/SDXC.html>
- You can use pictures copied to your computer for printing, attaching them to e-mail, or other operation. The "PHOTOfunSTUDIO" software on the CD-ROM (supplied) enables you to perform these functions easily.

■ Computer specifications

You can connect the camera to a computer that can detect a mass storage device (device that stores a large volume of data).

- Windows: Windows 8 / Windows 7 / Windows Vista / Windows XP
- Mac: OS X10.1 - 10.8

Using the supplied software

The supplied CD-ROM contains the following software.
Install the software on your computer before using.

■ PHOTOfunSTUDIO 9.0 LE (Windows XP / Vista / 7 / 8)

This software allows you to import still pictures and motion pictures to a PC as well as organize by categorizing them based on their recording date or the model name of the camera used. You can also write pictures to a DVD, retouch and adjust the pictures and edit the motion pictures.

■ LoiLoScope 30 day full trial version (Windows XP / Vista / 7 / 8)

LoiLoScope is a video editing software that draws out the full power of your PC. Creating videos is as easy as organizing cards on top of a desk. Use your music, picture and video files to create videos to share with your friends and family by burning it to a DVD, uploading it to websites, or simply share your videos with your friends via e-mail.

- This will only install a shortcut to the trial version download site.

For more information on how to use LoiLoScope, read the LoiLoScope manual available for download at the link below.

Manual URL: <http://loilo.tv/product/20>

Installing supplied software (PHOTOfunSTUDIO)

Before inserting the CD-ROM, close all running applications.

1 Check the environment of your PC

Operating environment of PHOTOfunSTUDIO 9.0 LE

OS	Windows XP (32 bit) SP3 Windows Vista (32 bit) SP2 Windows 7 (32 bit/64 bit) and SP1 Windows 8 (32 bit/64 bit)	
CPU	Windows XP	Pentium III 500 MHz or higher
	Windows Vista	Pentium III 800 MHz or higher
	Windows 7	Pentium III 1 GHz or higher
	Windows 8	
Display	1024x768 pixels or more (1920x1080 pixels or more recommended)	
RAM	Windows XP	512 MB or more
	Windows Vista	
	Windows 7	1 GB or more (32 bit)
	Windows 8	2 GB or more (64 bit)
Free hard disk space	450 MB or more for installing software	

- Refer to the Operating Instructions of “PHOTOfunSTUDIO” (PDF) for further information about the operating environment.

2 Insert the CD-ROM with the supplied software

- When you insert the supplied CD-ROM, the install menu will start.

3 Click on the [Applications] on the install menu

4 Click on the [Recommended Installation]

- Proceed with installation according to messages appearing on the screen.

- The software compatible with your PC will be installed.
- PHOTOfunSTUDIO is not compatible with Mac.
- For details on how to use “PHOTOfunSTUDIO”, see the “PHOTOfunSTUDIO” manual (PDF).

Copying still pictures and motion pictures

Getting Ready:

- Use batteries with sufficient power.
- When importing pictures from the built-in memory, remove any memory cards.
- Turn on the camera and computer.

1 Connect camera to computer

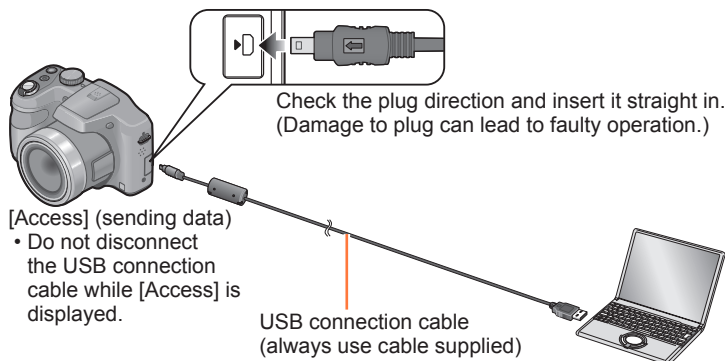

2 Use cursor button on the camera to select [PC], and press [MENU/SET]

3 Operate with your computer

- You can save pictures to use on your computer by dragging and dropping folders and files into separate folders on your computer.

- Do not use any other USB connection cables except the supplied one. Doing so may cause malfunction of the camera.
- Turn off the camera before inserting or removing memory cards.
- If the batteries run out while transmitting, a warning beep sounds. Cancel communication via your computer immediately. Use batteries with sufficient power.
- For more details, consult your computer operating manual.

■ Folder and file names on computer

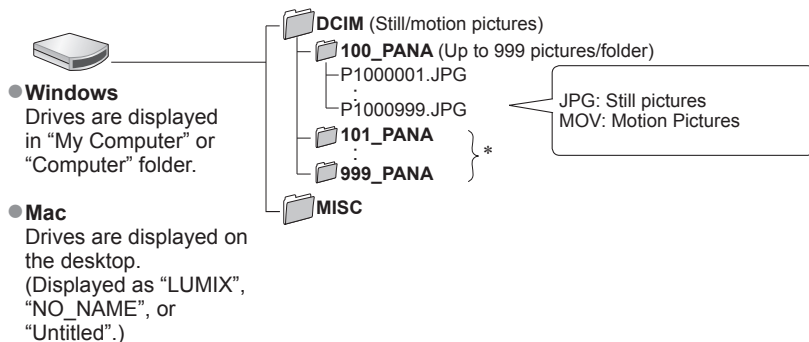

■ To cancel connection

- Windows: Execute "Safely Remove Hardware" on the taskbar
- Mac: Open the Finder and click the eject icon that appears on the sidebar

■ When using Windows XP, Windows Vista, Windows 7, Windows 8, or Mac OS X

The camera can be connected to your computer even if you select [PictBridge(PTP)] in the step 2 on the previous page.

- Only picture output can be performed.
- It may not be possible to import if there are 1000 or more pictures on the card.

Printing

You can connect directly to a PictBridge-compatible printer for printing.

- Some printers can print directly from the camera's memory card.
For details, see the manual for your printer.

Getting Ready:

- Use batteries with sufficient power.
- When printing pictures from the built-in memory, remove any memory cards.
- Adjust the print quality or other settings on your printer, as needed.
- Turn on the camera and printer.

1 Connect camera to printer

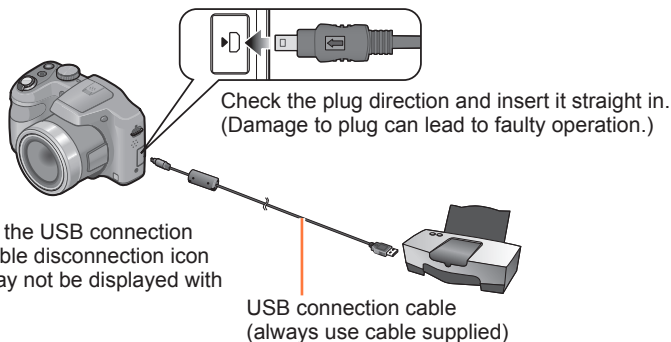

2 Use cursor button on the camera to select [PictBridge(PTP)], and press [MENU/SET]

3 Use cursor button to select a picture to print and press [MENU/SET]

4 Use cursor button to select [Print start] and press [MENU/SET]
(Print settings (→111))

■ **To cancel print** Press [MENU/SET].

(Continued on the next page)

- Do not use any other USB connection cables except the supplied one. Doing so may cause malfunction of the camera.
- Disconnect USB connection cable after printing.
- Turn off the camera before inserting or removing memory cards.
- If the batteries run out while transmitting, a warning beep sounds. Cancel printing and disconnect USB connection cable. Use batteries with sufficient power.
- Motion pictures cannot be printed.

Printing multiple pictures

1 Connect camera to printer

- Do not use any other USB connection cables except the supplied one. Doing so may cause malfunction of the camera.

2 Use cursor button on the camera to select [PictBridge(PTP)], and press [MENU/SET]

3 Press ▲

4 Use cursor button to select item and press [MENU/SET]

- [Multi Select]:
 - ① Scroll between pictures with cursor button, select pictures to print with the [DISP.] button. (Press [DISP.] button again to release selection.)
 - ② Press [MENU/SET] when selection is complete.
- [Select All]: Print all pictures.

5 Use cursor button to select [Print start] and press [MENU/SET]







- (Print settings (→111))
- Select [Yes] if print confirmation screen is displayed.

- An orange “●” displayed during printing indicates an error message.
- Print may be divided into several pictures if printing a large amount of pictures. (Remaining sheets display may differ from the number of pictures set for printing.)



Making print settings on the camera

Setting options include the number of printed pictures and their size. Make settings before selecting [Print start].

1 Use cursor button to select the item and press [MENU/SET]

Item	Settings
[Print with Date]	[ON] / [OFF]
[Num.of prints]	Set number of pictures (up to 999 pictures)
[Paper Size]	When  is selected, the printer settings take priority.
[Page Layout]	 (printer takes priority) /  (1 picture, no border) /  (1 picture, with border) /  (2 pictures) /  (4 pictures)

2 Use cursor button to select setting and press [MENU/SET]

- Items may not be displayed if incompatible with printer.
- To arrange  "2 pictures" or  "4 pictures" in the same still picture, set the number of prints for the still picture to 2 or 4.
- To print to paper sizes/layouts not supported by this camera, set to  and make settings on the printer. (Consult your printer's operating manual.)
- When setting [Print with Date] to [ON], check the date printing settings on the printer (printer settings may be prioritized).

Printing with date and text

■ Printing in store

Only recording date can be printed. Request date printing in store.

- When printing still pictures with a 16:9 aspect ratio, check in advance that the store can accept this size.

■ Using computer

Print settings for recording date and text information can be made using "PHOTOfunSTUDIO" on the supplied CD-ROM.

■ Using printer

Recording date can be printed by setting [Print with Date] (→111) to [ON] when connecting to a printer compatible with date printing.

List of LCD monitor displays

Screens shown here are only examples. The actual display may vary.

- Press the [DISP.] button to change display.

■ In recording

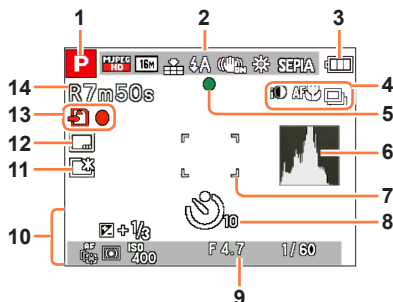

- | | |
|--|--|
| <p>1 Recording Mode (→26)</p> <p>2 Recording quality (→91)
Picture Size (→80)
Quality (→81)
Flash (→56)
Image Stabilizer (→89)
Jitter alert (→33)
White Balance (→82)
Color Mode (→88)</p> <p>3 Battery capacity (→17)</p> <p>4 Intelligent exposure (→86)
Macro recording (→59)
Burst Mode (→87)
Auto Bracket (→64)</p> <p>5 Focus (→29, 34)</p> <p>6 Histogram (→48, 52)</p> <p>7 AF area (→34)</p> <p>8 Self-timer Mode (→62)</p> | <p>9 Focus range
Zoom (→53)</p> <p>EZ W 6.0ft-∞ T 23X</p> <p>ISO Sensitivity (→81)
Aperture value/Shutter speed (→65)
AF Assist Lamp (→88)
AF Tracking (→31, 84)
Metering Mode (→85)</p> <p>10 Current date/time
Exposure Compensation (→63)
Elapsed recording time (→35)
XXhXXmXXs*
Age in years/months (→78)</p> <p>11 Monitor Luminance (→47)
Monitor Power Save (→49)</p> <p>12 Date Stamp (→90)</p> <p>13 Save destination (→22)
Recording state</p> <p>14 Number of recordable pictures (→23)
Available recording time (→23, 35)
RXXhXXmXXs*</p> |
|--|--|

* [h], [m] and [s] indicate “hour”, “minute” and “second”.

Screens shown here are only examples. The actual display may vary.

- Press the [DISP.] button to change display.

■ In playback

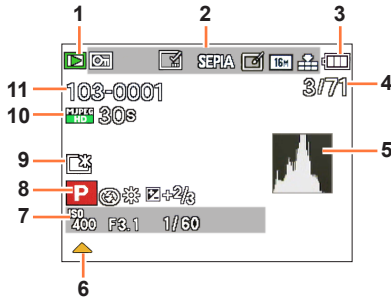

- | | |
|---------------------------------------|-------------------------------------|
| 1 Playback Mode (→92) | 7 Recording date/time |
| 2 Protected picture (→100) | Age in years/months (→78) |
| Date stamped display (→90) | ISO Sensitivity (→81) |
| Color Mode (→88) | Aperture value/Shutter speed (→65) |
| Retouched picture (→95) | 8 Recording Mode (→26) |
| Picture Size (→80) | Flash (→56) |
| Quality (→81) | White Balance (→82) |
| 3 Battery capacity (→17) | Exposure Compensation (→63) |
| 4 Picture number/Total pictures (→37) | 9 Monitor Luminance (→47) |
| Elapsed playback time (→40) | Monitor Power Save (→49) |
| XXhXXmXXs* | 10 Recording quality (→91) |
| 5 Histogram (→48, 52) | Motion picture recording time (→40) |
| 6 Motion picture playback (→40) | XXhXXmXXs* |
| Panorama playback (→75) | 11 Folder/File number (→37, 108) |
| Creative Retouch (→95) | Save destination (→22) |
| | Cable disconnection warning icon |
| | (→109) |

* [h], [m] and [s] indicate “hour”, “minute” and “second”.

Message displays

Meanings of and required responses to major messages displayed on LCD monitor.

[This memory card cannot be used]

- Not compatible with the camera.
→ Use a compatible card.

[Some pictures cannot be deleted] [This picture cannot be deleted]

- Non-DCF pictures (→37) cannot be deleted.
→ Save needed data on a computer or other device, and then use [Format] on the camera. (→51)

[No additional selections can be made]

- The number of pictures that can be deleted at once has been exceeded.
- The number of pictures allowing [Resize] (multiple settings) at once has been exceeded.

[Please turn camera off and then on again] [System Error]

- The lens is not working correctly.
→ Turn the camera on again.
(Consult the dealer or your nearest Service Center if display still remains.)

[Some pictures cannot be copied] [Copy could not be completed]

- Pictures cannot be copied in following cases.
→ Picture of same name already exists in built-in memory when copying from card.
→ File is not of DCF standard. (→37)
→ Picture taken or edited on a different device.

[Not enough space on built-in memory] [Not enough memory on the card]

- There is no space left on the built-in memory or the card. When you copy pictures from the built-in memory to the card (batch copy), the pictures are copied until the capacity of the card becomes full.

[Built-In Memory Error] [Format built-in memory?]

- Displayed when formatting built-in memory via computer, etc.
→ Reformat directly using camera. Data will be deleted.

[Memory card error. This card cannot be used in this camera. Format this card?]

- The card format cannot be used with this camera.
→ Save needed data on a computer or other device, and then use [Format] on the camera. (→51)

[Insert SD card again] [Try another card]

- Access to card has failed.
→ Turn off the camera and remove the card. Reinsert the card and turn the camera on again.
- Try with a different card.

[Memory card parameter error]

- Card is not of SD standard.
- When cards in capacities of 4 GB or more are used, only SDHC or SDXC Memory Cards are supported.

[Read Error] / [Write Error] [Please check the card]

- Data read has failed.
→ Check whether card has been inserted correctly. (→20)
- Data write has failed.
→ Turn off the camera and remove the card. Reinsert the card and turn the camera on again.
- Card may possibly be damaged.
- Try with a different card.

[Motion recording was cancelled due to the limitation of the writing speed of the card]

- If recording stops even when using a card of the recommended speed class (→22), the data writing speed has dropped. If this happens, we recommend backing up the data on the memory card and formatting it (→51).
- Motion picture recording may be automatically terminated with certain cards.

[A folder cannot be created]

- Folder numbers in use have reached 999.
→ Save needed data on a computer or other device, and then use [Format] on the camera. (→51)

[Picture is displayed for 16:9 TV] [Picture is displayed for 4:3 TV]

- AV cable (supplied) is connected to camera.
→ To remove message immediately → Press [MENU/SET].
→ To change aspect ratio → Change [TV Aspect] (→50).

Q&A Troubleshooting

Try checking these items (→117 - 122) first.

If the problem persists, performing [Reset] in the [Setup] menu may resolve the issue. (Note that except for some items such as [Clock Set], all settings are returned to their values at the time of purchase.)

Battery, power

The camera turns off immediately even with full battery power.

The remaining battery power is low even if new batteries are inserted.

- The batteries are expended.
- Depending on the battery brand and the operating temperature, the remaining battery power may not be displayed accurately.

Camera does not work even if the camera is turned on.

- Batteries are not inserted correctly (→15), or are expended.

Camera switches off as soon as the camera is turned on.

- [Auto Power Off] is activated (→49).
→ Press the Camera [ON/OFF] button.
- The batteries are expended.

Recording

Cannot record pictures.

- Built-in memory/card is full.
→ Free space by deleting unwanted pictures (→41).

Recorded pictures look white.

- Lens is dirty (fingerprints, etc.).
→ Clean lens surface with a soft, dry cloth.
- Lens is foggy (→6).

Recorded pictures are too bright/too dark.

- Adjust the exposure (→63).

Some pictures are taken when I press the shutter button just once.

- Camera is set to use [Auto Bracket] or [Burst].

Focus not aligned correctly.

- Not set to mode appropriate for distance to subject. (Focus range varies according to recording mode.)
- Subject outside of focus range.
- Caused by jitter or subject movement.

Recording (continued)

Recorded pictures are blurred. Image Stabilizer ineffective.

- Shutter speed is slower in dark locations and Image Stabilizer is less effective.
 - Hold camera firmly with both hands, keeping arms close to body.
 - Set [Sensitivity] to [AUTO] and [Digital Zoom] to [OFF]. (→81, 86)

Cannot use [Auto Bracket].

- Only enough memory for 2 pictures or fewer.

Recorded pictures appear coarse, or there is interference.

- ISO Sensitivity is high, or shutter speed is low. (Default [Sensitivity] setting is [AUTO] – interference may appear with indoor pictures.)
 - Lower [Sensitivity] (→81).
 - Take pictures in brighter locations.
- Camera set to [High Sens.] Scene mode. (Picture becomes slightly coarser in response to high sensitivity)

Brightness or coloring of recorded picture different from real life.

- When recording under fluorescent or LED lighting fixture etc., increasing the shutter speed may introduce slight changes to brightness and color. These are a result of the characteristics of the light source and do not indicate a malfunction.

Red banding may appear on the LCD monitor or part or the entire screen may have a reddish tint, when recording or pressing the shutter button halfway.

- This is a characteristic of CCD and may appear if subject contains brighter areas. Some blurring may occur around these areas, but this is not a fault. This will be recorded in motion pictures, but not in still pictures.
- We recommend keeping the screen away from strong light sources such as sunlight when taking pictures.



Motion picture recording stops midway.

- With some cards, access display may appear briefly after recording, and recording may end midway.
- If recording stops even when using a card of the recommended speed class (→22), the data writing speed has dropped. If this happens, we recommend backing up the data on the memory card and formatting it (→51).

The beep volume is low.

- The speaker is blocked.

The subject cannot be locked. (AF track fails.)

- If the color of the subject is similar to that of its background, AF Tracking may not function. Set the AF lock to the colors specific to the subject.

LCD monitor

Brightness is unstable.

- Aperture value is set while shutter button is pressed halfway. (Does not affect recorded picture.) This symptom may also occur when the brightness changes because the zoom is operated or the camera is moved. This is the automatic aperture operation of the camera and is not a malfunction.

Monitor flickers indoors.

- The LCD monitor may flicker for a few seconds after turning on. This is an operation to correct flicker caused by lighting such as fluorescent lights, LED lights etc. and is not a malfunction.

Monitor is too bright/too dark.

- [Monitor Luminance] is activated (→47).
- Use [Monitor Display] to adjust the brightness of the LCD monitor (→46).

Black/blue/red/green dots or interference appears. Monitor looks distorted when touched.

- This is not a fault, and will not be recorded on the actual pictures.

Flash

No flash emitted.

- Is the flash closed?
→ Press [**OPEN**] to open the flash (→55).
- The flash becomes unavailable in the following cases :
 - [Auto Bracket]
 - [Burst]
 - [Creative Control] Mode
 - [Scenery] mode
 - Scene Modes ([Panorama Shot] [Night Scenery] [HDR] [Sunset])

Multiple flashes are emitted.

- Red-eye reduction is active (→56). (Flashes twice to prevent eyes appearing red.)

Playback

Cannot view pictures. There are no recorded pictures.

- Press the Playback button.
- No pictures in built-in memory or card (pictures played from card if inserted, from built-in memory if not).
- Has the file name of the picture been changed on a computer? If so, it cannot be played back on the camera.
- The [Playback Mode] has been changed.
→ Set [Playback Mode] to [Normal Play] (→92).

Folder/file number displayed as [-]. Picture is black.

- Picture edited on computer or taken with different device.
- Batteries removed immediately after picture taken, or picture taken with low battery.
→ Use [Format] to delete (→51).

Playback (continued)

Incorrect date displayed in [Calendar].

- Picture edited on computer or taken with different device.
- [Clock Set] is incorrect (→25).
(Incorrect date may be displayed in [Calendar] on pictures copied to a computer and then back to the camera, if computer and camera dates differ.)

The Playback volume and beep volume are low.

- The speaker is blocked.

White round spots like soap bubbles appear on the recorded picture.

- If you take a picture with the flash in a dark place or indoors, white round spots may appear on the picture caused by the flash reflecting particles of dust in the air. This is not a fault. A characteristic of this is that the number of round spots and their position differ in every picture.



[Thumbnail is displayed] is shown on the screen.

- The pictures may have been recorded on another device. If so, they may be displayed with poor picture quality.

Red areas in pictures appear blackened.

- When digital red-eye correction (ⓂA, ⓂS) is operating, if a subject is recorded that has skin-colored areas with red areas inside, the digital red-eye correction function may blacken the red areas.
→ We recommend setting the flash to ⓂA, Ⓜ, or Ⓜ, or [Red-Eye Removal] to [OFF] before recording. (When the flash is closed, Ⓜ (Forced flash off) is set regardless of the flash setting.)

The sound of the recorded motion pictures sometimes breaks up.

- This unit automatically adjusts the aperture during motion picture recording. At such times, the sound may break up. This is not a malfunction.

Motion pictures recorded on this camera cannot be played on other devices.

- Motion pictures (Motion JPEG) recorded with this camera may not be played on digital cameras of other manufacturers. Additionally, motion pictures recorded with this camera cannot be played on Panasonic LUMIX digital cameras sold before July 2008. (However, motion pictures recorded with LUMIX digital cameras sold before this date can be played on this camera.)

TV, computer, printer

No image appears on TV. Image blurred or not colored.

- Not connected correctly (→102).
- The television has not been switched to auxiliary input.
- Check the [Video Out] setting (NTSC/PAL) on the camera. (DMC-LZ30PU only.) (→50)

TV screen display different to LCD monitor.

- Aspect ratio may be incorrect or edges may be cut off with certain televisions.

Cannot play motion pictures on TV.

- Card is inserted into TV.
→ Connect with AV cable (supplied) and play on camera (→102).

Picture is not displayed on full TV screen.

- Check [TV Aspect] settings (→50).

Cannot communicate with the computer.

- Not connected correctly (→107).
- Check whether computer has recognized camera.
→ Select [PC] when connecting the camera to your computer (→107).
→ Turn the camera off and then on again.

Computer does not recognize card (only reads built-in memory).

- Disconnect USB connection cable (supplied) and reconnect with card in place.

Computer does not recognize card. (When using an SDXC Memory Cards)

- Check whether your computer is compatible with SDXC Memory Cards.
<http://panasonic.net/avc/sdcard/information/SDXC.html>
- A message prompting you to format the card may appear when you connect it. Do not format the card.
- If the [Access] indicator on the LCD monitor does not go off, turn the camera off before disconnecting the USB connection cable.

Cannot print when connecting to printer.

- Printer not compatible with PictBridge.
- Select [PictBridge(PTP)] when connecting the camera to your printer (→109).

Cannot print the date.

- Make date printing settings before printing.
→ With the "PHOTOfunSTUDIO" software on the CD-ROM (supplied): Select "with dates" within print settings.
- Use [Date Stamp] function when taking a picture (→90).

The edges of pictures are cut off when printing.

- Release any trimming or edgeless printing settings on printer before printing.
(Consult printer operating manual.)
- The pictures were recorded in 16:9 aspect ratio.
→ If printing in shop, check if 16:9 sizes can be printed.

Cannot print panorama pictures properly.

- The aspect ratio of panorama pictures is different from that of regular still pictures, and some panorama pictures may not be printed correctly.
→ Use a printer with support for panorama pictures. (Refer to the instruction manual for the printer.)
→ We recommend adjusting the size of a picture in accordance with print paper using the "PHOTOfunSTUDIO" software on the CD-ROM (supplied).

Others**Menu not displayed in desired language.**

- Change [Language] setting (→51).

Camera rattles if shaken.

- This sound is made by the lens movement and is not a fault.

Red lamp illuminated when pressing shutter button halfway in dark locations.

- [AF Assist Lamp] is set to [ON] (→88).

AF Assist Lamp is not illuminated.

- [AF Assist Lamp] is set to [OFF] (→88).
- Not illuminated in bright locations.

Camera is hot.

- Camera may become a little warm during use, but this does not affect performance or quality.

Lens makes a clicking noise.

- When brightness changes, the lens may make a clicking noise and the monitor brightness may also change, but this is due to aperture settings being made. (Does not affect recording.)

Clock is incorrect.

- Camera has been left for a long period.
→ Reset the clock (→25).
- A long time was taken to set the clock (clock will be behind by the same lapse of time).

When using zoom, picture becomes slightly warped and the edges of the subject become colored.

- Pictures may be slightly warped or colored around the edges, depending on the zoom ratio, but this is not a fault.

Zoom movement stops momentarily.

- The zoom movement stops momentarily during Extended optical zoom operation, but this is not a malfunction.

Zoom does not reach the maximum ratio.

- If the zoom ratio stops at 3x, [Macro Zoom] has been set (→61).

File numbers are not recorded in sequence.

- File numbers are reset when new folders are created (→108).

File numbers have jumped backwards.

- Batteries were removed/inserted with the camera turned on.
(Numbers may jump backwards if folder/file numbers are not correctly recorded.)

Usage cautions and notes

When in use

- Camera may become warm if used for long periods of time, but this is not a fault.
- **Keep this unit as far away as possible from electromagnetic equipment (such as microwave ovens, TVs, video games etc.).**
 - If you use this unit on top of or near a TV, the pictures and/or sound on this unit may be disrupted by electromagnetic wave radiation.
 - Do not use this unit near cell phones because doing so may result in noise adversely affecting the pictures and/or sound.
 - Recorded data may be damaged, or pictures may be distorted, by strong magnetic fields created by speakers or large motors.
 - Electromagnetic wave radiation generated by microprocessors may adversely affect this unit, disturbing the pictures and/or sound.
 - If this unit is adversely affected by electromagnetic equipment and stops functioning properly, turn this unit off and remove the battery. Then reinsert the battery and turn this unit on.

Do not use this unit near radio transmitters or high-voltage lines.

- If you record near radio transmitters or high-voltage lines, the recorded pictures and/or sound may be adversely affected.
- Do not extend the supplied cord or cable.
- Do not allow camera to come into contact with pesticides or volatile substances (can cause surface damage or coating to peel).
- Never leave the camera and the batteries in a car or on a car hood in the summer. Doing so may cause leakage of the battery electrolyte, overheating, fire or a battery explosion due to the high temperature.

Caring for your camera

To clean your camera, remove the batteries and wipe with a soft, dry cloth.

- Use a damp cloth to remove stubborn stains, before wiping again with a dry cloth.
- Do not use benzine, thinners, alcohol, or kitchen detergent, as these may damage the outer casing and finish of the camera.
- If using a chemically-treated cloth, read the supplied instructions carefully.

When not using for a while

- Turn off the camera before removing batteries and card.
- Do not leave in contact with rubber or plastic bags.
- Store together with a drying agent (silica gel) if leaving in a drawer, etc.

Memory cards

- To prevent damage to cards and data
 - Avoid high temperatures, direct sunlight, electromagnetic waves, and static electricity.
 - Do not bend, drop, or expose to strong impacts.
 - Do not touch terminals on reverse of card or allow them to become dirty or wet.
- When disposing of/transferring memory cards
 - If using the “format” or “delete” functions on your camera or computer, this only changes the file management information, and does not completely delete the data from within the memory card. When disposing of or transferring your memory cards, we recommend physically destroying them or using commercially available computer data erasing software to completely delete the data from the card. Data within memory cards should be managed responsibly.

LCD Monitor

- Do not press hard on the LCD monitor. This may cause uneven display and damage the monitor.
- In cold climates or other situations when the camera becomes cold, the LCD monitor may appear slightly darker than normal immediately after the camera is turned on. Normal brightness will return once the internal components have warmed up.

Extremely high precision technology is employed to produce the LCD monitor screen. However there may be some dark or bright spots (red, blue or green) on the screen. This is not a malfunction. The LCD monitor screen has more than 99.99% effective pixels with a mere 0.01% of the pixels inactive or always lit. The spots will not be recorded on pictures on the built-in memory or a card.

Batteries

- Be sure to remove the batteries from the camera if you are not using it for a long period of time.
 - If the batteries are left in the camera, a small electrical current continues to flow even when the camera is turned off and the batteries will be gradually drained.
 - If the temperature is too high or low or the humidity is high, the terminals may rust causing a malfunction.
 - Be sure to store the batteries in cool (15 °C to 25 °C (59 °F to 77 °F)) location with low humidity (40%RH to 60%RH), where the temperature does not change sharply.
 - Keep batteries away from toddlers and children.
- Do not drop, throw, or subject batteries to other strong impact.
 - If you drop the batteries accidentally, make sure that the terminals have not been damaged.
 - Do not use batteries that show signs of leakage, deformation, discoloration, etc. If battery leakage occurs, remove the batteries, thoroughly wipe dry the battery compartment, and then insert new batteries or fully charged Ni-MH batteries.
- Always use the batteries in dry and clean conditions.
 - Do not immerse the batteries in water or seawater or wet the terminals.
 - If there is any foreign substance such as grease or dirt on the battery poles, the recording/playback time may become extremely short. Before inserting the batteries, carefully clean the poles with a soft dry cloth.
- Do not peel off or scratch the battery covering.
 - Do not use commercially available batteries that are entirely or partly uncovered. Do not use batteries with flat ⊖ poles. Using such batteries may cause leakage, heat generation or explosion.
- Take spare batteries when going out.
 - Be aware that the recording time is reduced in low temperature conditions such as at a ski slope. Battery performance deteriorates when the ambient temperature is low (10 °C (50 °F) or less) and the recording/playback time may become extremely short. In particular, when using alkaline batteries, warm them in your pocket etc. before using them. Make sure that pocket heaters or metal objects such as lighters do not come into contact with the batteries when warming them in your pocket etc. The battery performance will recover when the temperature returns to normal.
 - Battery performance may vary greatly depending on the brand used, the storage life from the date of manufacture, and the storage conditions of the batteries.
 - Depending on the temperature and the conditions of use, the camera may not operate properly or the batteries may run out (the remaining battery power may not be accurately displayed). This is not a malfunction.
 - Expended batteries may temporarily recover some performance if they are left for a period of time. However, they cannot be used for an extended period. Be sure to replace them with new batteries.

Rechargeable Ni-MH batteries

- You can use Ni-MH batteries after charging them with a dedicated battery charger. However, improper handling of the batteries may cause leakage, heat generation, fire or an explosion. Observe the following.
 - If there is dirt on the battery poles, you may not be able to charge the batteries normally. Carefully clean the battery poles and battery charger terminals with a soft dry cloth.
 - Do not peel off or scratch the covering on Ni-MH batteries.
 - When the batteries are used for the first time, or after having not been used for a long period of time, they may not fully charge. This is a characteristic of Ni-MH batteries and is not a malfunction. Battery performance will return to normal after a few charges and discharges.
 - We recommend charging the batteries after they are fully discharged. If you repeat charging before they are fully discharged, battery performance may be reduced. (This is called "memory effect".)
If a "memory effect" occurs, continue using the batteries until the camera can no longer perform recording or playback and then charge them fully. Battery performance will be restored after a few charges and discharges.
 - Once the Ni-MH batteries have reached full charge, do not continue to charge them.
 - Over time, Ni-MH batteries naturally discharge and their performance lowers even if they are not used. If the batteries are left in the camera in this condition, they will be drained excessively and may become unusable even if they are charged again.
 - When storing the batteries for a long period of time, we recommend charging them once a year. Remove the batteries from the camera and store them again after they have been completely expended.
 - Ni-MH batteries have a limited life. Battery performance gradually decreases over time as you keep using them and time goes by. If the length of time you can use the camera is extremely short even after fully charging the batteries, they may have exceeded their life span. Purchase new batteries.
 - Read the operating instructions for the battery charger.

Disposing of used rechargeable batteries

- Insulate the terminals using adhesive tape etc.
- Do not disassemble the batteries.

Lens

- Images may appear slightly white if lens is dirty (fingerprints, etc.). Lightly wipe the surface of the lens with a soft, dry cloth before and after taking pictures.
- Do not leave the lens exposed to direct sunlight.
- Do not press the lens with excessive force.

When using a tripod or unipod

- Do not apply excessive force or tighten screws when they are crooked. (This may damage the camera, screw hole, or label.)
- Ensure that the tripod is stable. (Refer to the tripod instructions.)
- You may not be able to remove the card or the battery when using a tripod or unipod.

Personal Information

If birthdays are set in [Baby] Mode, keep in mind that the camera and recorded pictures will contain personal information.

- **Disclaimer**
 - Data containing personal information can be altered or lost due to malfunction, static electricity, accidents, breakdowns, repairs, or other operations. Panasonic will not be liable for any damage that occurs, direct or indirect, as a result of the alteration or loss of data containing personal information.
- **When ordering repairs or transferring/disposing of the camera**
 - To protect your personal information, please reset the settings (→50).
 - If any pictures are contained in the built-in memory, copy (→101) them to a memory card if necessary, and then format (→51) the built-in memory.
 - Remove the memory card from the camera.
 - When ordering repairs, the built-in memory and other settings may be returned to the initial purchase state.
 - If the above operations cannot be performed because of a camera malfunction, consult with the dealer or nearest Service Center.
- **When transferring or disposing of your memory card, see “When disposing of/ transferring memory cards” in the previous section (→124).**
- **When uploading pictures to online services**
 - Pictures may contain information that can be used for identifying individuals, such as titles, recording dates, and location information. When uploading pictures to online services, check carefully before uploading.



- SDXC Logo is a trademark of SD-3C, LLC.
- QuickTime and the QuickTime logo are trademarks or registered trademarks of Apple Inc., used under license therefrom.
- Windows and Windows Vista are either registered trademarks or trademarks of Microsoft Corporation in the United States and/or other countries.
- Mac and Mac OS are trademarks of Apple Inc., registered in the U.S. and other countries.
- Other names, company names, and product names mentioned in these instructions are trademarks or registered trademarks of the companies concerned.