

Panasonic[®]

Operating Instructions for advanced features

Digital Camera

Model No. **DMC-GF2**



Before use, please read these instructions completely.

VQT3H68

Contents

Before Use

Standard Accessories	5
Names and Functions of Components.....	6
About the Lens	12

Preparation

Attaching/Detaching the Lens	15
Attaching the Shoulder Strap	17
Charging the Battery	18
• Approximate operating time and number of recordable pictures	21
Inserting and Removing the Card (optional)/the Battery	24
About the Card	25
• About cards that can be used with this unit	25
• Approximate number of recordable pictures and operating time	26
Setting Date/Time (Clock Set).....	28

Basic

Selecting the [REC] Mode.....	30
Taking a Still picture	32
• How to set focus when taking a still picture (AFS/AF)	32
• Taking Pictures with Your Favorite Settings (Program AE Mode).....	34
• Taking pictures using the Touch Shutter function.....	37
Playing Back Pictures	38
• Changing the information displayed on the playback screen	39
Recording Motion Picture	43
• How to set focus when recording a motion picture (Continuous AF)	43
• Recording Motion Picture.....	44
Playing Back Motion Pictures.....	46

Taking Pictures using the Automatic Function (Intelligent Auto Mode)	48
Deleting Pictures	53
Setting the Menu	55
• Setting menu items	56
Setting the Quick Menu	58
About the Setup Menu.....	60

Recording

Switching the display of the LCD Monitor	67
• Switching the Information Displayed on the recording screen	67
Taking Pictures with the Zoom	69
• Using the Optical Zoom/Using the Extended Tele Conversion (EX)/ Using the Digital Zoom.....	69
Taking Pictures using the Built-in Flash.....	71
• Switching to the appropriate flash setting	71
Optical Image Stabilizer	76
Compensating the Exposure	78
Taking Pictures using Burst Mode.....	79
Taking Pictures using Auto Bracket	81
Taking Pictures with the Self-timer	83
Setting the Method used to Focus (AF Mode)	85
Taking Pictures with Manual Focus.....	91
Adjusting the White Balance	93
Setting the Light Sensitivity	98
Taking Pictures by Specifying the Aperture/Shutter Speed.....	100
• Aperture-priority AE.....	100
• Shutter-priority AE	100
Taking Picture by Setting the Exposure Manually	102
Using the function button.....	104
• Fixing the Focus and the Exposure (AF/AE Lock).....	105
• Confirm the Effects of Aperture and Shutter Speed (Preview Mode).....	106

Taking Pictures that match the Scene being recorded (Scene Mode).....	107
• [PORTRAIT].....	107
• [SOFT SKIN].....	108
• [SCENERY].....	108
• [ARCHITECTURE].....	108
• [SPORTS].....	108
• [PERIPHERAL DEFOCUS].....	109
• [FLOWER].....	109
• [FOOD].....	110
• [OBJECTS].....	110
• [NIGHT PORTRAIT].....	110
• [NIGHT SCENERY].....	111
• [ILLUMINATIONS].....	111
• [BABY1]/[BABY2].....	112
• [PET].....	113
• [PARTY].....	113
• [SUNSET].....	113
Taking Pictures while Adjusting Color (My Color Mode).....	114
Taking Pictures in Custom Mode.....	117
Taking a Picture with Face Recognition Function.....	119
Useful Functions at	
Travel Destinations.....	125
Entering Text.....	128
Using the [REC] Mode Menu.....	129
• [ASPECT RATIO].....	129
• [PICTURE SIZE].....	130
• [QUALITY].....	131
• [FACE RECOG.].....	131
• [FOCUS MODE].....	132
• [QUICK AF].....	132
• [METERING MODE].....	133
• [FLASH].....	134
• [RED-EYE REMOVAL].....	134
• [I.RESOLUTION].....	134
• [I.DYNAMIC] (Intelligent dynamic range control).....	135
• [ISO LIMIT SET].....	135
• [ISO INCREMENTS].....	135
• [LONG SHTR NR].....	136
• [EX. TELE CONV.].....	136
• [DIGITAL ZOOM].....	136
• [BURST RATE].....	136
• [AUTO BRACKET].....	136
• [SELF-TIMER].....	137
• [PICTURE ADJUST].....	137
• [COLOR SPACE].....	138
• [STABILIZER].....	138
Using the [MOTION PICTURE] Mode Menu.....	139
• [REC MODE].....	139
• [REC QUALITY].....	140
• [CONTINUOUS AF].....	141
• [WIND CUT].....	141
• [MIC LEVEL DISP.].....	141
• [MIC LEVEL ADJ.].....	141
• [FLICKER RED.].....	141
Using the [CUSTOM] Menu.....	142

Playback/Editing

Creating Still Pictures from a Motion Picture	148
Using the [PLAYBACK] Mode Menu	149
• [2D/3D SETTINGS]	149
• [SLIDE SHOW]	149
• [PLAYBACK MODE]	151
• [TITLE EDIT]	152
• [TEXT STAMP]	153
• [VIDEO DIVIDE]	155
• [RESIZE] Reducing the picture size (number of pixels)	156
• [CROPPING]	157
• [ASPECT CONV.]	158
• [ROTATE]/[ROTATE DISP.]	159
• [FAVORITE]	160
• [PRINT SET]	161
• [PROTECT]	163
• [FACE REC EDIT]	164

Connecting to other equipment

Enjoying 3D pictures	165
Playing Back Pictures on a TV Screen	169
Saving the Recorded Still Pictures and Motion Pictures	176
Connecting to a PC	179
Printing the Pictures	182

Others

Optional accessories	188
Screen Display	192
Cautions for Use	195
Message Display	203
Troubleshooting	206

Standard Accessories

Check that all the accessories are supplied before using the camera.

- The accessories and their shape will differ depending on the country or area where the camera was purchased.
For details on the accessories, refer to Basic Operating Instructions.
- Battery Pack is indicated as **battery pack** or **battery** in the text.
- Battery Charger is indicated as **battery charger** or **charger** in the text.
- SD Memory Card, SDHC Memory Card and SDXC Memory Card are indicated as **card** in the text.
- **The card is optional.**
- Description in these operating instructions is based on the interchangeable lens (H-H014).
About unavailable functions such as [STABILIZER] (P76), Direction Detection function (P35), description in these operating instructions is based on the interchangeable lens (H-FS014042).
- If any accessories are lost, customers in the USA and Puerto Rico should contact Panasonic's parts department at 1 800 833-9626 and customers in Canada should contact 1 800 99-LUMIX (1-800-995-8649) for further information about obtaining replacement parts.

Names and Functions of Components

■ Camera body

- 1 Sensor
- 2 Self-timer indicator (P83)/
AF Assist Lamp (P144)
- 3 Flash (P71)
- 4 Lens fitting mark (P15)
- 5 Mount
- 6 Lens lock pin
- 7 Lens release button (P16)

- 8 Flash open button (P71)
- 9 Speaker (P47)
- 10 Rear dial (P10)
- 11 Touch panel/LCD monitor (P9, 38, 67, 192)
- 12 Playback button (P38, 46)
- 13 [Q.MENU/Fn] button (P11, 58, 89, 104)/
Delete/Return button
- 14 [MENU/SET] button (P10, 56)
- 15 Cursor buttons (P10)
 - ▲/ISO (P98)
 - ▶/WB (White Balance) (P93)
 - ◀/AF Mode button (P85)
 - ▼/[DRIVE MODE] button

This button in picture record mode will allow the user to select between the following options.

Single (P34)/Burst (P79)/Auto bracket (P81)/Self-timer (P83)

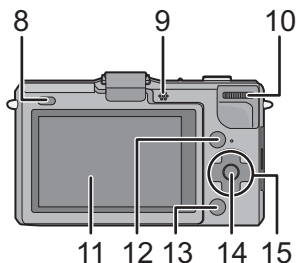
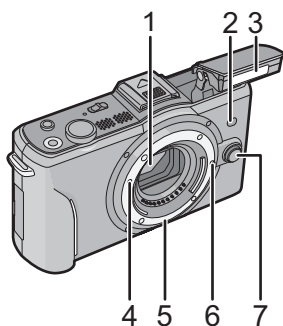

- 16 Stereo microphone
- 17 Shutter button (P34)
- 18 Motion picture button (P44)
- 19 Focus distance reference mark (P92)
- 20 Hot shoe cover (P8, 188, 190)
- 21 Camera ON/OFF switch (P28)
- 22 Status indicator (P28)
- 23 Intelligent Auto button (P48)

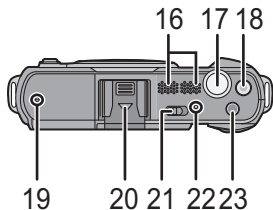

- 24 Shoulder strap eyelet (P17)
 - Be sure to attach the shoulder strap when using the camera to ensure that you will not drop it.
- 25 [HDMI] socket (P171)
- 26 [AV OUT/DIGITAL] socket (P169, 177, 179, 182)

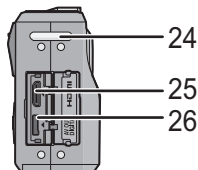

- 27 Tripod receptacle (P202)
 - When you use a tripod, make sure the tripod is stable when the camera is attached to it. If the attached lens contacts the base of the tripod, use the tripod adaptor (DMW-TA1; optional).
- 28 Card/Battery door (P24)
- 29 DC coupler cover
 - When using an AC adaptor, ensure that the Panasonic DC coupler (optional) and AC adaptor (optional) are used. (P191)
- 30 Release lever (P24)

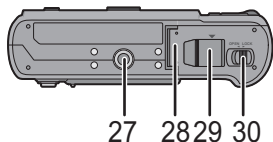

■ Removing the Hot Shoe Cover

The camera comes with a hot shoe cover attached to the hot shoe.

To use the Optional Live Viewfinder (P188) or External Flash (P190), please remove the hot shoe cover.

Remove the hot shoe cover by pulling it in the direction indicated by arrow ② while pressing it in the direction indicated by arrow ①.

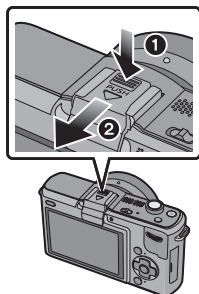

Note

- When not using the Optional Live Viewfinder or External Flash, be sure to attach the hot shoe cover.
- Please be careful not to lose the hot shoe cover.
- When not using the hot shoe cover, be careful not to let liquid, sand, or any other foreign matter enter the connection terminals.
- Keep the Hot Shoe Cover out of reach of children to prevent swallowing.

■ Lens

H-H014 (LUMIX G 14 mm/F2.5 ASPH.)

- 31 Lens surface
- 32 Focus ring (P91)
- 33 Contact point
- 34 Lens fitting mark (P15)

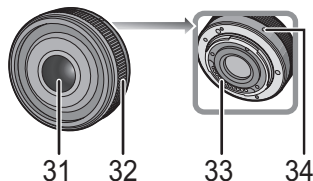

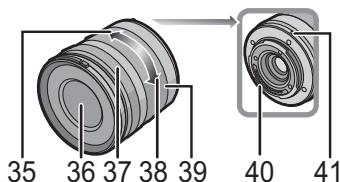

H-FS014042 (LUMIX G VARIO 14–42 mm/F3.5–5.6 ASPH./MEGA O.I.S.)

- 35 Tele
- 36 Lens surface
- 37 Focus ring (P91)
- 38 Wide
- 39 Zoom ring (P69)
- 40 Contact point
- 41 Lens fitting mark (P15)



Touch Panel

This touch panel is a type that detects pressure.

Touch the screen To touch and release the touch panel.	Drag A movement without releasing the touch panel.
 <p>Use this to perform tasks such as selecting icons or images displayed on the touch panel.</p> <ul style="list-style-type: none"> When selecting features using the touch panel, be sure to touch the center of the desired icon. 	 <p>This is used when performing tasks such as moving to the next image by dragging horizontally, or changing the range of the displayed image.</p> <p>This can also be used to perform tasks such as switching the screen by operating the slide bar.</p>

Note

- If you use a commercially available liquid crystal protection sheet, please follow the instructions that accompany the sheet. (Some liquid crystal protection sheets may impair visibility or operability.)
- If a commercially available protection sheet is used, **a little extra pressure** may be required if you notice that the touch panel is not responsive.
- Avoid having the hand holding the camera accidentally apply pressure to the touch panel. Doing so may affect the touch panel operation.
- Do not press on the LCD monitor with hard pointed tips, such as ball point pens.
- Do not operate with your fingernails.
- Wipe the LCD monitor with dry soft cloth when it gets dirty with finger prints and others.
- Do not scratch or press the LCD monitor too hard.
- For information about the icons displayed on the touch panel, refer to “Screen Display” on [P192](#).

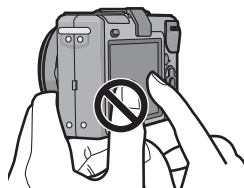

About the Stylus pen

It is easier to use the stylus pen (supplied) for detailed operation or if it is hard to operate with your fingers.

- Only use the supplied stylus pen.
- Do not place it where small children can reach.

Cursor buttons/[MENU/SET] button

This document expresses the up, down, left, and right of the cursor button as follows, or as ▲/▼/◀/▶.

e.g.: When you press the ▼ (down) button



or

Press ▼

Even when the camera is operated using the touch panel, it is possible to operate with the cursor button and [MENU/SET] button if a guide like the one shown on the right is displayed.

Cursor button: Selection of items or setting of values etc., is performed.

[MENU/SET]: Confirmation of setting contents, etc., is performed.



Rear Dial

There are 2 ways to operate the rear dial, rotating left or right, and deciding by pressing.

Rotating:

Selection of items or setting of values is performed during the various settings.

Pressing:

Operations that are the same as [MENU/SET] button, such as determine settings, etc., are performed during the various settings.

• Rear dial is described as follows in these operating instructions.

e.g.: Rotating left or right



e.g.: Pressing the rear dial



[Q.MENU] button/Function button

Ⓐ : [Q.MENU/Fn] button

[Q.MENU/Fn] button can be used in two ways, as [Q.MENU] (Quick Menu) or as [Fn] (function button). At the time of purchase, it is initially set to Quick Menu. To switch the setting, select using [Q.MENU/Fn] in [CUSTOM] menu.

- Some of the menus can be called up easily when [Q.MENU] (Quick Menu) is selected. Refer to [P58](#) for details about the Quick Menu.
- Some of the functions can be called up easily when [Fn] (function button) is selected. Refer to [P104](#) for details about the function button.

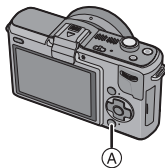

About the Lens

■ Micro Four Thirds™ mount specification lens

This unit can use the dedicated lenses compatible with the Micro Four Thirds System lens mount specification (Micro Four Thirds mount).

- Select a lens that matches the scene being recorded and your use of the pictures.



MICRO

MICRO
FOURTHIRDS

■ Four Thirds™ mount specification lens

Lens with the Four Thirds mount specification can be used by using the mount adaptor (DMW-MA1; optional).



FOURTHIRDS

■ Leica mount specification lens

- When you use the M mount adaptor or R mount adaptor (DMW-MA2M, DMW-MA3R; optional), you can use Leica M Mount or Leica R Mount interchangeable lenses.
 - For certain lenses, the actual distance at which the subject is in focus may differ slightly from the rated distance.
 - When using a Leica lens mount adaptor, set [SHOOT W/O LENS] (P147) to [ON].

About the functions of your lens

- Depending on the type of lens, some functions such as the Direction Detection Function (P35), [STABILIZER] (P76), and [QUICK AF] (P132) are disabled.
- The available flash range etc. differs depending on the aperture value of the lens you are using.
- Take some test pictures with the lens you are using.
- The focal length for the lens is twice that of a 35 mm film camera.
(A 50 mm lens is equivalent to a 100 mm lens.)
Focal length of the 3D interchangeable lens can be checked on the website. (P14)

Interchangeable lenses that can be used with this unit and Auto Focus/Auto Aperture Operation (As of December 2010)

(○: Usable, ●: Some functions/features limited, —: Not usable)

Lens type		when recording still pictures		while recording motion pictures	
		Auto Focus	Auto aperture setting	Auto Focus	Auto aperture setting
Micro Four Thirds mount specification lens	Interchangeable lens (H-H014)	○ ([AFS], [AFC])	○	●*4, 5	●*7
	Interchangeable lens (H-FS014042)	○ ([AFS], [AFC])	○	●*4, 5	●*7
	The 3D interchangeable lens (H-FT012; optional)	—	—	—	—
	Other Micro Four Thirds mount specification lens*3	○ ([AFS], [AFC])	○	●*4, 5	●*7
Four Thirds mount specification lens*1	Four Thirds mount specification lens compatible to contrast AF	● ([AFS])	○	●*6	●*7
	Four Thirds mount specification lens not compatible to contrast AF	●*8 ([AFS])	○	●*6, 8	●*7
Leica mount specification lens*2	Interchangeable lens for Leica	—	—	—	—

Before Use

- *1 Mount adaptor (DMW-MA1; optional) is necessary to use with this unit.
- *2 A Leica lens mount adaptor (DMW-MA2M, DMW-MA3R; optional) is necessary.
- *3 This function is not supported by some Micro Four Thirds mount specification lenses. For lens operations, please see our website.
- *4 When recording motion pictures, the focus is continuously adjusted for both [AFS] and [AFC] (P43).
- *5 AF tracking is slower than the HD motion picture compatible lens, also the sound of Auto Focus operation may be recorded.
- *6 Auto Focus is activated only when the shutter button is pressed halfway. The sound of Auto Focus operation may be recorded at this time.
- *7 The sound of Aperture operation may be recorded.
- *8 AF performance may differ depending on the lens used. Refer to the website for details.

Refer to catalogues/Web pages for most current information regarding compatible lenses.

<http://panasonic.jp/support/global/cs/dsc/> (This Site is English only.)

Attaching/Detaching the Lens

- Check that the camera is turned off.
- Change lenses where there is not a lot of dirt or dust. Refer to [P197](#), [P198](#) when dirt or dust gets on the lens.

Attaching a lens to the camera body

- 1** Turn the lens rear cap **A** and the body cap **B** in the direction of the arrow to detach them.

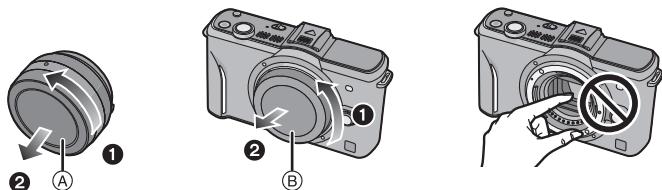

- Do not put your hands inside the mount.

- 2** Align the lens fitting marks **C** (red marks) on the camera body and the lens and then rotate the lens in the direction of the arrow until it clicks.

- Do not press the lens release button **D** when you attach a lens.
- Do not try to attach the lens when holding it at an angle to the camera body as the lens mount may get scratched.

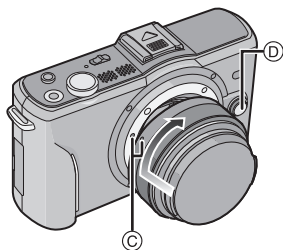

- 3** Detach the lens cap.

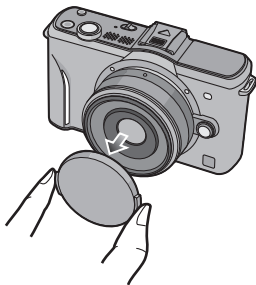

Detaching a lens from the camera body

1 Attach the lens cap.

2 Press the lens release button **(D)** while turning the lens as far as possible in the direction of the arrow to detach it.

- Always attach the body cap to the camera body so that dirt or dust does not get inside.
- Attach the lens rear cap so that the lens contact point does not get scratched.

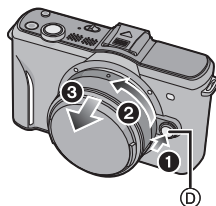

Note

- It is recommended to attach the lens cap or attach the MC Protector (optional) to protect the lens surface when carrying. (P191)

Attaching the Lens Hood

In bright sunlight or backlight, the lens hood will minimize lens flare and ghosting. The lens hood cuts off excess lighting and improves the picture quality.

To attach the lens hood (flower shape) that came with the interchangeable lens (H-FS014042)

- The interchangeable lens (H-H014) does not have a lens hood.

Insert the lens hood into the lens with the short sides at the top and bottom, and turn in the direction of the arrow until it stops.

- (A) Align with the mark.

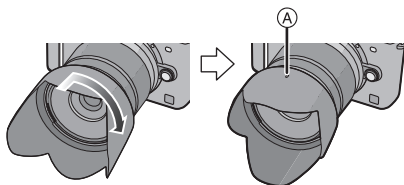

Note

- When temporarily detaching and carrying the lens hood, attach the lens hood to the lens in the reverse direction.

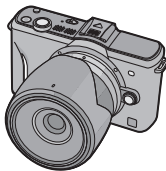

Attaching the Shoulder Strap

- We recommend attaching the shoulder strap when using the camera to prevent it from dropping.

- 1** Pass the shoulder strap through the shoulder strap eyelet on the camera body.

(A): Shoulder strap eyelet

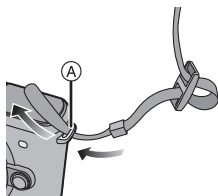

- 2** Pass the end of the shoulder strap through the ring in the direction of the arrow and then pass it through the stopper.

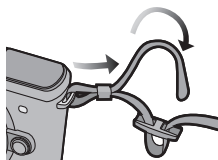

- 3** Pass the end of the shoulder strap through the hole on the other side of the stopper.

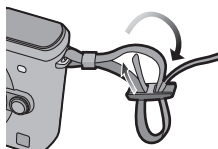

- 4** Pull the other side of the shoulder strap and then check that it will not come out.

- Perform steps **1** to **4** and then attach the other side of the shoulder strap.

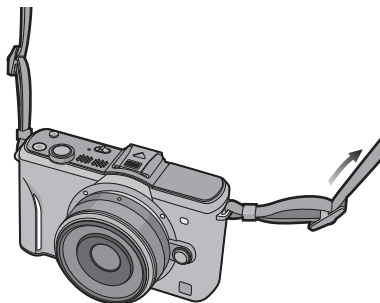

Note

- Use the shoulder strap around your shoulder.
 - Do not wrap the strap around your neck.
 - It may result in injury or accident.
- Do not leave the shoulder strap where an infant can reach it.
 - It may result in an accident by mistakenly wrapping around the neck.

Charging the Battery

■ About batteries that you can use with this unit

It has been found that counterfeit battery packs which look very similar to the genuine product are made available to purchase in some markets. Some of these battery packs are not adequately protected with internal protection to meet the requirements of appropriate safety standards. There is a possibility that these battery packs may lead to fire or explosion. Please be advised that we are not liable for any accident or failure occurring as a result of use of a counterfeit battery pack. To ensure that safe products are used we would recommend that a genuine Panasonic battery pack is used.

- Use the dedicated charger and battery.
- The camera has a function for distinguishing batteries which can be used safely. The dedicated battery supports this function. The only batteries suitable for use with this unit are genuine Panasonic products and batteries manufactured by other companies and certified by Panasonic. (Batteries which do not support this function cannot be used.) Panasonic cannot in any way guarantee the quality, performance or safety of batteries which have been manufactured by other companies and are not genuine Panasonic products.

■ Charging

- The battery is not charged when the camera is shipped. Charge the battery before use.
- Charge the battery with the charger indoors.

- 1** Attach the battery paying attention to the direction of the battery.

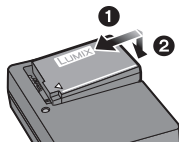

2 Connect the charger to the electrical outlet.

- Disconnect the charger from the electrical socket and detach the battery after charging is completed.

plug-in type

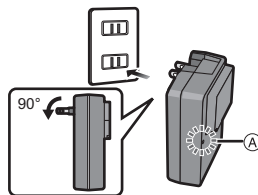

inlet type

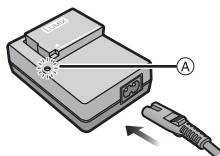

■ About the [CHARGE] indicator

The [CHARGE] indicator turns on:

The [CHARGE] indicator (A) is turned on and charging will start.

The [CHARGE] indicator turns off:

The [CHARGE] indicator (A) of the charger will turn off once the charging has completed without any problem.

• When the [CHARGE] indicator flashes

- The battery temperature is too high or too low. It is recommended to charge the battery again in an ambient temperature of between 10 °C to 30 °C (50 °F to 86 °F).
- The terminals of the charger or the battery are dirty. In this case, wipe them with a dry cloth.

■ Charging time**Charging time****Approx. 120 min**

- The indicated charging time is for when the battery has been discharged completely. The charging time may vary depending on how the battery has been used. The charging time for the battery in hot/cold environments or a battery that has not been used for a long time may be longer than normal.

 **Note**

- Do not leave any metal items (such as clips) near the contact areas of the power plug. Otherwise, a fire and/or electric shocks may be caused by short-circuiting or the resulting heat generated.
- The battery can be recharged even when it still has some charge left, but it is not recommended that the battery charge be frequently topped up while the battery is fully charged. (Since characteristic swelling may occur.)

Approximate operating time and number of recordable pictures

■ Battery indication

The battery indication is displayed on the screen.

[It does not appear when you use the camera with the AC adaptor (optional) connected.]



- The indication turns red and blinks if the remaining battery power is exhausted. (The status indicator also blinks) Recharge the battery or replace it with a fully charged battery.

■ Recording still pictures [when using the LCD monitor] (By CIPA standard in Program AE Mode)

	When the interchangeable lens (H-H014) is used
Number of recordable pictures	Approx. 320 pictures
Recording time	Approx. 160 min

	When the interchangeable lens (H-FS014042) is used
Number of recordable pictures	Approx. 300 pictures
Recording time	Approx. 150 min

■ **Recording still pictures [when using the Optional Live Viewfinder (P188)] (By CIPA standard in Program AE Mode)**

	When the interchangeable lens (H-H014) is used
Number of recordable pictures	Approx. 330 pictures
Recording time	Approx. 165 min

	When the interchangeable lens (H-FS014042) is used
Number of recordable pictures	Approx. 310 pictures
Recording time	Approx. 155 min

Recording conditions by CIPA standard

- CIPA is an abbreviation of [Camera & Imaging Products Association].
- Temperature: 23 °C (73.4 °F)/Humidity: 50%RH when LCD monitor is on.
- Using a Panasonic SD Memory Card (2 GB).
- Using the supplied battery.
- Starting recording 30 seconds after the camera is turned on.
- **Recording once every 30 seconds** with full flash every second recording.
- Turning the camera off every 10 recordings and leaving it until the temperature of the battery decreases.

The number of recordable pictures varies depending on the recording interval time. If the recording interval time becomes longer, the number of recordable pictures decreases. [For example, if you were to take one picture every two minutes, then the number of pictures would be reduced to approximately one-quarter of the number of pictures given above (based upon one picture taken every 30 seconds).]

■ Recording motion pictures (when using the LCD monitor)

– [AVCHD] (Recording with picture quality set to [FSH])

	When the interchangeable lens (H-H014) is used
Continuous recordable time	Approx. 130 min
Actual recordable time	Approx. 70 min

	When the interchangeable lens (H-FS014042) is used
Continuous recordable time	Approx. 120 min
Actual recordable time	Approx. 60 min

– [MOTION JPEG] (Recording with picture quality set to [HD])

	When the interchangeable lens (H-H014) is used
Continuous recordable time	Approx. 140 min*
Actual recordable time	Approx. 75 min*

	When the interchangeable lens (H-FS014042) is used
Continuous recordable time	Approx. 130 min*
Actual recordable time	Approx. 65 min*

• These times are for an ambient temperature of 23 °C (73.4 °F) and a humidity of 50%RH. Please be aware that these times are approximate.

• Actual recordable time is the time available for recording when repeating actions such as switching the power supply [ON]/[OFF], starting/stopping recording etc.

* Motion picture recorded continuously in [MOTION JPEG] is up to 2 GB. Only the maximum recordable time for 2 GB is displayed on the screen.

■ Playback (when using the LCD monitor)

	When the interchangeable lens (H-H014) is used
Playback time	Approx. 250 min

	When the interchangeable lens (H-FS014042) is used
Playback time	Approx. 240 min

Note

• The operating times and number of recordable pictures will differ according to the environment and the operating conditions.

For example, in the following cases, the operating times shorten and the number of recordable pictures is reduced.

– In low-temperature environments, such as on ski slopes.

– Using the [AUTO] of [LCD MODE] or [MODE1] of [LCD MODE] (P61).

– When flash is used repeatedly.

• When the operating time of the camera becomes extremely short even after properly charging the battery, the life of the battery may have expired. Buy a new battery.

Inserting and Removing the Card (optional)/the Battery

- Check that this unit is turned off.
- We recommend using a Panasonic card.

1 Slide the release lever in the direction of the arrow and open the card/battery door.

- Always use genuine Panasonic batteries.
- If you use other batteries, we cannot guarantee the quality of this product.

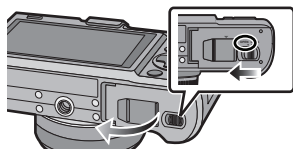

2 **Battery:** Insert until it is locked by the lever (A) being careful about the direction you insert it. Pull the lever (A) in the direction of the arrow to remove the battery.

Card: Push it fully until it clicks being careful about the direction you insert it. To remove the card, push the card until it clicks, then pull the card out upright.

(B): Do not touch the connection terminals of the card.

- The card may be damaged if it is not fully inserted.

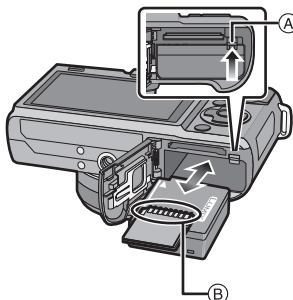

3 **1:** Close the card/battery door.

2: Slide the release lever in the direction of the arrow.

- If the card/battery door cannot be completely closed, remove the card, check its direction and then insert it again.

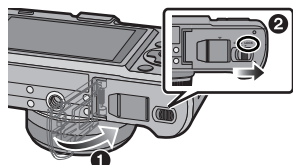

Note

- Remove the battery after use. Store the removed battery in the battery case (supplied).
- The battery will be exhausted if left for a long period of time after being charged.
- The supplied battery is designed only for the camera. Do not use it with any other equipment.
- The battery becomes warm after using it and during and after charging. The camera also becomes warm during use. This is not a malfunction.
- Before removing the card or battery, turn the camera off, and wait until the status indicator has gone off completely. (Otherwise, this unit may no longer operate normally and the card itself may be damaged or the recorded pictures may be lost.)

About the Card

About cards that can be used with this unit

The following cards which conform to the SD video standard can be used with this unit. (These cards are indicated as **card** in the text.)

Type of card which can be used with this unit	Remarks
SD Memory Card (8 MB to 2 GB)	<ul style="list-style-type: none"> • SDHC Memory Card can be used with SDHC Memory Card or SDXC Memory Card compatible equipment. • SDXC Memory Card can only be used with SDXC Memory Card compatible equipment. • Check that the PC and other equipment are compatible when using the SDXC Memory Cards. http://panasonic.net/avc/sdcard/information/SDXC.html
SDHC Memory Card (4 GB to 32 GB)	
SDXC Memory Card (48 GB, 64 GB)	

- Only cards bearing the SDHC logo (indicating that the card conforms to SD video standards) may be used as 4 GB to 32 GB cards.
- Only cards bearing the SDXC logo (indicating that the card conforms to SD video standards) may be used as 48 GB and 64 GB cards.
- Use a card with SD Speed Class* with "Class 4" or higher when recording motion pictures in [AVCHD]. Also, use a card with SD Speed Class with "Class 6" or higher when recording motion pictures in [MOTION JPEG].
 - * SD Speed Class is the speed standard regarding continuous writing. Check via the label on the card, etc.

e.g.:



Access to the card

The access indication lights red when pictures are being recorded on the card.



- **Do not turn this unit off, remove its battery or card, or disconnect the AC adaptor (optional) when the access indication is lit [when pictures are being written, read or deleted, or the card is being formatted (P66)]. Furthermore, do not subject the camera to vibration, impact or static electricity.**

The card or the data on the card may be damaged, and this unit may no longer operate normally.

If operation fails due to vibration, impact or static electricity, perform the operation again.

- Please confirm the latest information on the following website.

<http://panasonic.jp/support/global/cs/dsc/>

(This Site is English only.)

 **Note**

- Write-Protect switch (A) provided (When this switch is set to the [LOCK] position, no further data writing, deletion or formatting is possible. The ability to write, delete and format data is restored when the switch is returned to its original position.)
- The data on the card may be damaged or lost due to electromagnetic waves, static electricity or breakdown of the camera or the card. We recommend storing important data on a PC etc.
- Do not format the card on your PC or other equipment. Format it on the camera only to ensure proper operation. (P66)
- Keep the Memory Card out of reach of children to prevent swallowing.



Approximate number of recordable pictures and operating time

■ About the display of the number of recordable pictures and operating time

- Switching between the display of number of recordable pictures and operating time can be performed in the [REMAINING DISP.] (P145) in the [CUSTOM] menu.

- (A) Number of recordable pictures
- (B) Available recording time



■ Number of recordable pictures

• [9999+] is displayed if there are more than 10000 pictures remaining.

• Aspect ratio [4:3], Quality [FINE]

Picture size	2 GB	4 GB	16 GB	64 GB
L (12M)	290	570	2350	9150
M (6M)	520	1020	4220	16470
S (3M)	820	1620	6670	24710

• Aspect ratio [4:3], Quality [RAWFINE]

Picture size	2 GB	4 GB	16 GB	64 GB
L (12M)	92	180	740	2920
M (6M)	105	210	860	3400
S (3M)	115	220	930	3660

■ Available recording time (when recording motion pictures)

• [AVCHD]

Recording quality setting	2 GB	4 GB	16 GB	64 GB
FSH	15 min 00 s	30 min 00 s	2 h 6 min	8 h 27 min
FH	20 min 00 s	40 min 00 s	2 h 45 min	11 h 3 min
SH	15 min 00 s	30 min 00 s	2 h 6 min	8 h 27 min
H	20 min 00 s	40 min 00 s	2 h 45 min	11 h 3 min

• [MOTION JPEG]

Recording quality setting	2 GB	4 GB	16 GB	64 GB
HD	8 min 20 s	16 min 20 s	1 h 7 min	4 h 30 min
WVGA	20 min 50 s	41 min 00 s	2 h 48 min	11 h 14 min
VGA	21 min 40 s	42 min 40 s	2 h 55 min	11 h 41 min
QVGA	1 h 00 min	1 h 58 min	8 h 5 min	32 h 23 min

- The number of recordable pictures and operating time will increase or decrease in proportion to the capacity of the card. (These vary depending on the recording conditions and the type of card.)
- Maximum time to record motion pictures continuously with [AVCHD] is 13 hours 3 minutes 20 seconds. Screen will only display up to 13 hours 3 minutes 20 seconds. However, the recording may stop before that depending on the remaining battery level. (P21)
- Motion picture recorded continuously in [MOTION JPEG] is up to 2 GB. Only the maximum recordable time for 2 GB is displayed on the screen.

Setting Date/Time (Clock Set)

Clock can be set with touch operation at the time of purchase. To change the clock settings, refer to [CLOCK SET] in the [SETUP] menu (P60).

- The clock is not set when the camera is shipped.

1 Turn the camera on.

- The status indicator ❶ lights when you turn this unit on.
- Ⓐ [MENU/SET] button
- If the language select screen is not displayed, proceed to step 4.

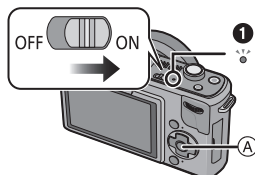

2 Touch [LANGUAGE SET].

3 Select the language.

4 Touch [CLOCK SET].



5 Touch the items you wish to set (Year/ Month/Day/Hours/Minutes), and set using [▲]/[▼].

- Ⓐ: Time at the home area
- Ⓑ: Time at the travel destination (P127)
- You can continue to switch the settings by continuously touching [▲]/[▼].
- Touch [CANCEL] to cancel the date and time settings without setting a date and time.

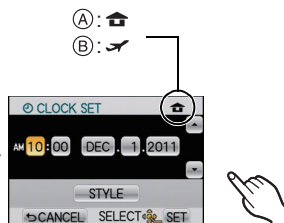

To set the display order and the time display format.

- Touch [STYLE] to display the settings screen for setting display order/time display format.
- Touch [CANCEL] to return to the previous screen without setting the display order/time display format.



6 Touch [SET] to set.

7 Touch [SET].

- After completing the clock settings, turn the camera off. Then turn the camera back on, switch to Recording Mode, and check that the display reflects the settings that were performed.

 **Note**

- **The clock setting is maintained for 3 months using the built-in clock battery even without the battery. (Leave the charged battery in the unit for 24 hours to charge the built-in battery.)**
- The clock is displayed when [DISP.] is touched several times during recording.
- You can set the year from 2000 to 2099.
- If the clock is not set, the correct date cannot be printed when you stamp the date on the pictures with [TEXT STAMP] (P153) or order a photo studio to print the pictures.
- Be sure to set the correct date and time, otherwise the date stamp will be incorrect when the picture is printed.

Selecting the [REC] Mode

1 Press [MENU/SET].

- Ⓐ [MENU/SET] button

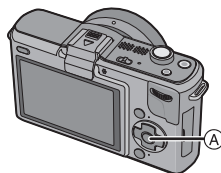

2 Touch [REC MODE].

- A screen listing the [REC] Mode is displayed.
- It is also possible to display the screen listing the [REC] Mode by touching the [REC] Mode icon in [REC] Mode.



3 Touch the [REC] Mode to select.



- [i] is displayed when [i] is touched, and a description of the [REC] Mode is displayed when [REC] Mode is touched. It will return to the screen listing the [REC] Mode when [CANCEL] is touched, and [i] will disappear.

■ To select Intelligent Auto Mode

It is also possible to switch to Intelligent Auto Mode with the **[IA]** button.

Press **[IA]**.

- Ⓐ **[IA]** button

- **[IA]** button will light up when it is switched to Intelligent Auto Mode.

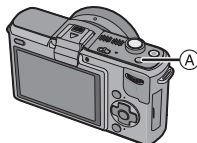

■ List of [REC] Modes**P Program AE Mode (P34)**

The subjects are recorded using your own settings.

A Aperture-Priority AE Mode (P100)

The shutter speed is automatically determined by the aperture value you set.

S Shutter-Priority AE Mode (P100)

The aperture value is automatically determined by the shutter speed you set.

M Manual Exposure Mode (P102)

The exposure is adjusted by the aperture value and the shutter speed which are manually adjusted.

iA Intelligent Auto Mode (P48)

The subjects are recorded using settings automatically selected by the camera.

 My Color Mode (P114)

Use this mode to check coloring effects, select a color mode from among nine color modes, and then take pictures.

SCN Scene Mode (P107)

This allows you to take pictures that match the scene being recorded.

C Custom Mode (P117)

Use this mode to take pictures with previously registered settings.

Taking a Still picture

How to set focus when taking a still picture (AFS/AFC)

- 1 Select **[FOCUS MODE]** from the **[REC] Mode menu**. (P56)
- 2 Press **[MENU/SET]** to select the item.
 - Normally use the **[AFS]**.

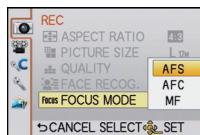

AFS	<p>"AFS" is an abbreviation of "Auto Focus Single". Focus is set and locked automatically when the shutter button is pressed halfway. Focus will be fixed while it is pressed halfway.</p>
AFC	<p>"AFC" is an abbreviation of "Auto Focus Continuous". This mode allows you to compose a picture more easily by continuously focusing on the movement of the subject while the shutter button is pressed halfway.</p> <p>When taking pictures of a moving subject, the camera predicts the movement of the subject and continually focuses on it. (motion prediction)</p> <ul style="list-style-type: none"> • It may take time to focus on the subject if you rotate the zoom ring from Wide to Tele or suddenly change the subject from a distant one to a nearby one. • Press the shutter button halfway again when it is difficult to focus on the subject. • When the brightness is not enough, this will work the same as [AFS]. • For the [AFC] feature, please see page 13 for a list of compatible lenses.
MF	<p>Set the focus manually by rotating the focus ring. (P91)</p>

3 Press the shutter button halfway.

- (A) Focus indication
(B) AF area

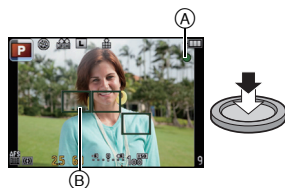

(Focusing action for [AFS])

Focus	When the subject is focused	When the subject is not focused
Focus indication	On	Blinks
AF area	Green	—
Sound	Beeps 2 times	—

 **Note**

- Focus sound will not beep if the Focus Mode is set to [AFC]. Also, the AF area will not be displayed if the AF Mode is set to [AF-ON].
- The focus range is different depending on the lens used.
 - When the interchangeable lens (H-H014) is used: 0.18 m (0.59 feet) to ∞
 - When the interchangeable lens (H-FS014042) is used: 0.3 m (0.99 feet) to ∞

■ Subjects and recording conditions which are difficult to focus

- Fast-moving subjects, extremely bright subjects or subjects without contrast
- When recording subjects through windows or near shiny objects
- When it is dark or when jitter occurs
- When the camera is too close to the subject or when taking a picture of both distant and near subjects

Taking Pictures with Your Favorite Settings (Program AE Mode)

The camera automatically sets the shutter speed and the aperture value according to the brightness of the subject.

You can take pictures with greater freedom by changing various settings in [REC] Mode menu.

- Set the drive mode to [] by pressing ▼ ([]).

1 Set [REC] Mode to [P].

- For details on setting up [REC] Mode, refer to P30.

2 Press the shutter button halfway to focus.

- (A) Aperture value
- (B) Shutter speed

- Aperture value and shutter speed are displayed. (It will flash in red if the correct exposure is not achieved, except when set to flash.)
- **You will not be able to take a picture until the focus is set, since the [FOCUS PRIORITY] (P144) is set initially to [ON].**

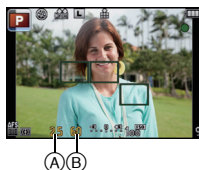

3 Press the shutter button fully (push it in further), and take the picture.

- The access indication lights (P25) red when pictures are being recorded on the card.



Note

- To change the setting while taking pictures, refer to "Using the [REC] Mode Menu" (P129) or "Using the [CUSTOM] Menu" (P142).
- The shutter speed is automatically set between about 30 seconds and 1/4000th of a second in the following cases.
 - When the [SENSITIVITY] is set to [ISO100].
 - When the aperture value is set to F2.5 [when the interchangeable lens (H-H014) is attached].
 - When the aperture value is set to F3.5 [when the interchangeable lens (H-FS014042) is attached].

Tips for taking good pictures

Ⓐ AF assist lamp

• Do not cover the flash or the AF assist lamp with your fingers or other objects.

- Hold the camera gently with both hands, keep your arms still at your side and stand with your feet slightly apart.
- Be careful not to move the camera when you press the shutter button.
- When taking pictures, make sure your footing is stable and there is no danger of colliding with another person, an object etc.
- Using the Optional Live Viewfinder, you can adjust the viewfinder angle when recording with a low camera angle. This feature is convenient for recording low-lying subjects such as flowers, etc. (P198)

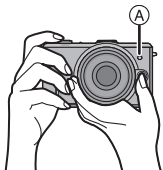

■ Direction Detection Function

A lens which supports the Direction Detection Function is required.

- The interchangeable lens (H-H014) does not support the Direction Detection Function.
- The interchangeable lens (H-FS014042) supports the Direction Detection Function.

Pictures recorded with the camera held vertically are played back vertically (rotated). (Only when [ROTATE DISP.] (P159) is set to [ON])

- The Direction Detection Function may not operate correctly if recording is performed with the camera aimed up or down.
- You can only use the Direction Detection Function when using a compatible lens. (Refer to the catalogue, website etc. for compatible lenses.)
- You cannot record 3D pictures in vertical orientation.

Program Shift

In Program AE Mode, you can change the preset aperture value and shutter speed without changing the exposure. This is called Program Shift.

You can make the background more blurred by decreasing the aperture value or record a moving subject more dynamically by slowing the shutter speed when taking a picture in Program AE Mode.

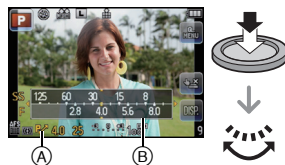

- 1 Press the shutter button halfway and display the aperture value and shutter speed value on the screen.
- 2 While the values are displayed (about 10 seconds), perform the Program Shift by rotating the rear dial.

- It will switch between Program Shift operation and Exposure Compensation operation (P78) every time the rear dial is pressed while the values are displayed.
- Rotate the rear dial to display the [EXPO.METER] (Ⓢ). (P143)
- The Program Shift indication (A) appears on the screen when Program Shift is activated.
- To cancel Program Shift, turn the camera off or rotate the rear dial until the Program Shift indication disappears.

■ Example of Program Shift

(When the interchangeable lens (H-H014) is used)

(A): Aperture value

(B): Shutter speed

- 1 Program Shift amount
- 2 Program Shift line chart
- 3 Program Shift limit

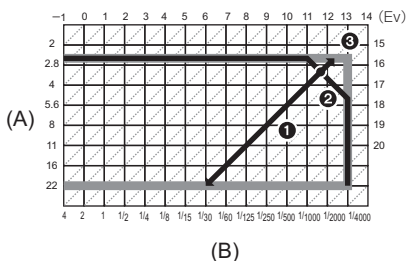

● Note

- If the exposure is not adequate when the shutter button is pressed halfway, the aperture value and shutter speed turn red and blink.
- Program Shift is canceled and the camera returns to normal Program AE Mode if more than 10 seconds pass after Program Shift is activated. However, the Program Shift setting is memorized.
- Program Shift will only allow adjustments to be made when there is an adequate amount of light.
- Program Shift is available in all ISO sensitivity settings except [ISO].

Taking pictures using the Touch Shutter function

Applicable modes: **iA P A S M**  **SCN C**

Just by touching the subject to focus, it will focus on the subject and take the picture automatically.

1 Touch in Recording Mode.

- Icon will change to , and taking a picture with the Touch Shutter function becomes possible.



2 Touch the subject you wish to focus on, and then take a picture.

- Ⓐ Rough indication of the area that can be focused with the Touch Shutter
- AF area with same function as  in AF Mode is displayed at the position you touch, and a picture is taken when it is focused. (This function is unavailable at the extreme edges of the screen.)
- If the histogram is displayed on top of the subject you want to touch, touch the subject after first moving the histogram. (P68)

3 Touch to cancel the Touch Shutter function.

Note

- If [FOCUS PRIORITY] is [ON], when the Focus Mode is set to [AFS] and the Touch Shutter fails, if the AF area briefly turns red and disappears, this signifies that the picture cannot be taken under the current conditions.
When set to [AFC], the picture will not be taken if the focus indication is flashing green, but if the subject comes into focus while you are touching the screen, the picture will be taken.
- Measurement of brightness is performed on the spot touched when the [METERING MODE] is set to . (P133)

Playing Back Pictures

1 Press [▶].

(A) [▶] button

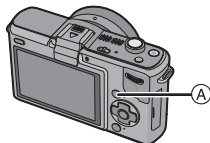

2 Forward or rewind the image by dragging (P9) the screen horizontally.

Forward: drag from right to left

Rewind: drag from left to right

- It is also possible to forward or rewind the image by pressing ◀/▶ of the cursor button.
- Speed of picture forwarding/rewinding changes depending on the playback status.
- You can forward or rewind pictures continuously by keeping your finger on the left or right sides of the screen after forwarding/rewinding a picture.
(Pictures are displayed reduced in size)



■ To finish playback

Press [▶] again, press the motion picture button or press the shutter button halfway.

Note

- This camera complies with the DCF standard "Design rule for Camera File system" established by JEITA "Japan Electronics and Information Technology Industries Association" and with Exif "Exchangeable Image File Format". This camera can only display pictures that comply with the DCF standard.

Changing the information displayed on the playback screen

Touch **[DISP.]** to switch the monitor screen.

- During Playback Zoom (P42), while playing back motion pictures (P46) and during a slide show (P149), you can only select “Normal display (A)” or “No display (E)”.
- Histogram (C) is displayed in R (red), G (green), B (blue), and Y (luminance) during the playback.

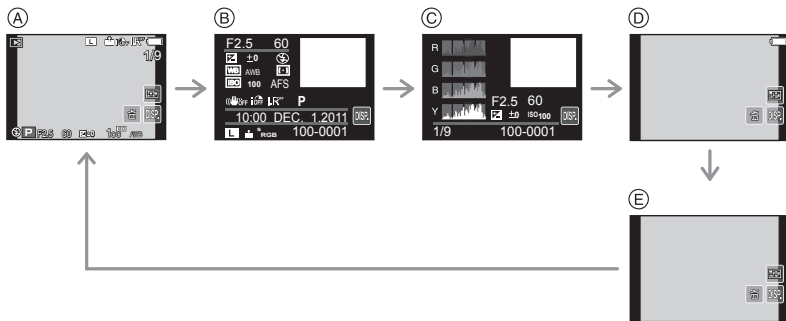

- (A) Normal display
- (B) Detailed information display
- (C) Histogram display
- (D) Highlight display^{*1,2}
- (E) No display^{*2}

*1 This is displayed if [HIGHLIGHT] (P142) in the [CUSTOM] menu is set to [ON].

*2 **[DISP.]** icon will remain if you do not perform operations for a specific period of time.

Displaying multiple screens (Multi Playback)

Rotate the rear dial left.

1 screen → 12 screens → 30 screens → Calendar screen display

- Ⓑ Number of the selected picture and the total number of recorded pictures
- Ⓒ Slide bar

• Rotate the rear dial right to return to the previous screen.

You can also switch to the Multi Playback screen by touching [] Ⓐ.

• It is possible to switch the playback screen by touching the following icons.

- []: 1 screen
- []: 12 screens
- []: 30 screens
- [CAL]: Calendar screen display

- Screen can be switched by dragging the slide bar up or down (P9).
- The screen can be switched gradually by dragging the screen up or down (P9).
- Pictures are not rotated for display.
- Pictures displayed using [] cannot be played back.

■ To return to Normal Playback

Touch the picture to select.

- You can also return to the one screen display by choosing images pressing the cursor button, and then pressing [MENU/SET] or the rear dial.

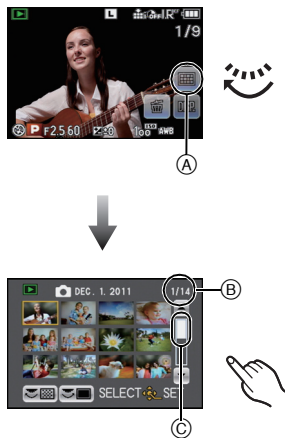

Displaying Pictures by Recording Date (Calendar Playback)

1 Rotate the rear dial left to display the Calendar screen.

- Calendar screen can be also displayed by touching [CAL].

2 Touch [▲]/[▼] to select the month to be played back.

- If there were no pictures recorded during a month, that month is not displayed.
- Touch [] to display the multi playback screen.

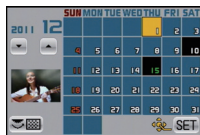

3 Select the date you wish to play back, and then touch [SET].



4 Select the picture you wish to play back.

- Switch the screen by touching [▲]/[▼] if these are displayed on the slide bar.
- To return to the calendar screen display, turn the rear dial left or touch [CAL].

Note

- The recording date of the picture selected in the playback screen becomes the date selected when the Calendar screen is first displayed.
- If there are multiple pictures with the same recording date, the first picture recorded on that day is displayed.
- You can display the Calendar between January 2000 and December 2099.
- If the date is not set in the camera, the recording date is set as January 1st, 2010.
- If you take pictures after setting the travel destination in [WORLD TIME], the pictures are displayed by the dates at the travel destination in Calendar Playback.

Using the Playback Zoom

1 Touch the part to enlarge.

1× → 2× → 4× → 8× → 16×

- Picture can also be enlarged by rotating the rear dial right.
- When you change the magnification, the zoom position indication (A) appears for about 1 second.
- The more a picture is enlarged, the more its quality deteriorates.

**2 Move the position to be displayed by dragging the picture (P9).**

- When you move the position to be displayed, the zoom position indication (A) appears for about 1 second.
- Position of the enlarged part can be also moved by pressing the cursor button.
- Picture will return to the original size (1×) by touching [Q10].
- Also, when you touch [Q9] or rotate the rear dial left, the magnification becomes lower.

**Switching the displayed image while maintaining the Playback Zoom**

You can switch the displayed image while maintaining the same zoom magnification and zoom position for the Playback Zoom.

Switch to picture select operation by pressing the rear dial during Playback Zoom, and select pictures by touching [P11]/[P12].

- It will switch between picture select operation and move zoom position operation every time the rear dial is pressed during Playback Zoom.

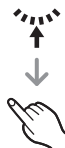
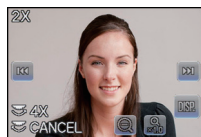
**Note**

- You can also delete the recording information etc. on the screen during Playback Zoom by touching [DISP].
- If you want to save the enlarged picture, use the Cropping function. (P157)
- The Playback Zoom may not operate if pictures have been recorded with other equipment.
- The zoom magnification and the zoom position are canceled when the camera is turned off (including Sleep Mode).
- The zoom position returns to the center in the following images.
 - Images with different aspect ratios
 - Images with different numbers of recorded pixels
 - Images with a different rotation direction (when [ROTATE DISP.] is set to [ON])
- The Playback Zoom feature is disabled during Motion Picture Playback.

[REC] Mode:      

Recording Motion Picture

This can record full high definition motion pictures compatible with the AVCHD format or motion pictures recorded in Motion JPEG.

Audio will be recorded in stereo.

The functions available when recording motion pictures differ according to the lens you are using, and the operational sound of the lens may be recorded.

Refer to page 13 for details.

How to set focus when recording a motion picture (Continuous AF)

Focusing varies depending on the settings of the [FOCUS MODE] and the [CONTINUOUS AF] in the [MOTION PICTURE] Mode menu.

Focus Mode	[CONTINUOUS AF]	Settings
AFS/AFC	ON	You can have the camera focus continuously. • Press the shutter button halfway when it is difficult to focus on the subject.
	OFF	The focus position is fixed when beginning to record a motion picture. • It is possible to set the focus by pressing the shutter button halfway or touching the subject.
MF	ON	You can focus manually.
	OFF	

- Depending on the recording conditions or lens used, operational sound may be recorded when the Auto Focus is operated while recording a motion picture. It is recommended to record with [CONTINUOUS AF] in the [MOTION PICTURE] Mode menu set to [OFF], if the sound of operation bothers you to avoid recording the lens noise.
- When operating the zoom when recording motion pictures, it may take time to come into focus.

Recording Motion Picture

Recording of motion picture appropriate for each mode is possible.

- Screen here is an example of when the [REC] mode is set to [P] (Program AE Mode).



1 Start recording by pressing the motion picture button.

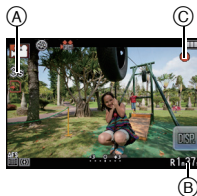

- (A) Elapsed recording time
- (B) Available recording time

- Sound will be heard when pressing the motion picture button indicating start/stop of motion picture recording.
- The recording state indicator (red) (C) will flash while recording motion pictures.



2 Stop the recording by pressing the motion picture button again.

 **Note**

- **The flash setting is fixed to [☺].**
- Audio will not be recorded for 0.5 seconds after it starts recording if the motion picture button is kept pressed. Release the motion picture button right after you press it.
- The operational sound of the zoom or button operation may be recorded when it is operated during the recording of a motion picture.
- The available recording time will be accurately updated at the end of each recording.
- Depending on the type of the card, the card access indication may appear for a while after recording motion pictures. This is not a malfunction.
- When the aspect ratio setting is different in still and motion pictures, the angle of view changes at the start of motion picture recording. When [ REC AREA] (P145) is set to [], angle of view during motion picture recording is displayed.
- When the [EX. TELE CONV.] is set to [ON], the angle of view will change when the screen is switched between the still picture screen and motion picture screen, because the zoom factor is different between still pictures and motion pictures. (P69)
- The ISO sensitivity will be set to [AUTO] (for motion pictures) when recording motion pictures.
- When recording a motion picture, [STABILIZER] will be fixed to [MODE1] even if it is set to [MODE2] or [MODE3].
- When recording motion pictures, the following functions are disabled.
 - [] in the AF Mode
(It will switch to Multi Auto Focus Mode for motion pictures.)
 - Direction Detection Function
 - [FACE RECOG.]/[ISO LIMIT SET]
- It is recommended to use a fully charged battery or AC adaptor (optional) when recording motion pictures. (P191)
- If while recording motion pictures using the AC adaptor (optional) the power supply is cut off due to a power cut or if the AC adaptor (optional) is disconnected etc., the motion picture being recorded will not be recorded.
- **Since the AVCHD format is constantly evolving, motion pictures recorded in [AVCHD] or [MOTION JPEG] can result in poor playback even with equipment that is said to be compatible with these formats.**
For details on AVCHD compatible devices, refer to the support site below.
<http://panasonic.jp/support/global/cs/dsc/>
(This Site is English only.)
- **The sound recording specifications on this model have been changed to improve audio quality. For this reason, some motion pictures recorded in [MOTION JPEG] and pictures with audio may not be played back with Panasonic digital cameras (LUMIX)*.**
(Motion pictures recorded with a Panasonic digital camera (LUMIX) can be played back on this model.)
 - * **Models launched before December 2008, and some models launched in 2009 (FS, LS series).**
- To play back AVCHD motion pictures recorded with this unit on Panasonic Blu-ray Disc Players (DMP-BD30/DMP-BD31/DMP-BD50) it is necessary to update the firmware of the Blu-ray Disc Player.
You can download the latest firmware version from the following website.
<http://panasonic.net/support/>

Playing Back Motion Pictures

- This unit was designed to play motion pictures using the AVCHD and QuickTime Motion JPEG formats that were taken with this model (only).
- Motion pictures in AVCHD format that can be played back on this unit are [AVCHD] motion pictures that were recorded with this unit, AVCHD format (including [AVCHD Lite]) motion pictures recorded with Panasonic digital cameras (LUMIX) only.

1 Press [▶].

2 Select a picture with a Motion Picture icon ([👤]), [📷]) and then touch [▶] to play back.

- Ⓐ Motion picture icon
- Ⓑ The motion picture recording time

- After playback starts, the elapsed playback time is displayed on the upper left of the screen.

For example, 8 minutes and 30 seconds is displayed as [8m30s].

- Some information (recording information, etc.) is not displayed for motion pictures recorded in [AVCHD].
- Pressing the cursor button ▲ to allows you to playback motion pictures. Display at the upper right of the screen while playing back corresponds to ▲/▼/◀/▶ on the cursor button.

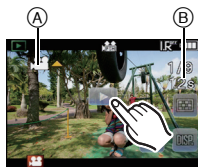

■ Operations performed during Motion Picture Playback

1 Display control panel by touching screen.

- If no operation is performed for 2 seconds, it will return to original status.

2 Operate control panel by touching.

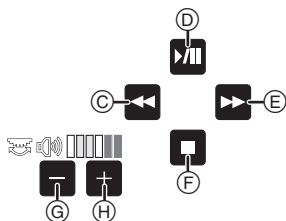

- Ⓒ Fast rewind, Frame-by-frame rewind*2
- Ⓓ Play/Pause
- Ⓔ Fast forward, Frame-by-frame forward*2
- Ⓕ Stop
- Ⓖ Reduce volume level*1
- Ⓗ Increase volume level*1

*1 You can also adjust the volume level by using the rear dial.

*2 These operations can be performed only in the Pause Mode and the following icons are displayed.

– Frame-by-frame forward: [⏩]

– Frame-by-frame rewind: [⏪]

• About fast forward/rewind playback

– Touch [⏩] during playback to fast forward (touch [⏪] to fast rewind). The fast forward/rewind speed increases if you touch [⏩]/[⏪] again. (The display on the screen changes from [⏩] to [⏩⏩].)

– Touch [⏪] to resume normal playback speed.

– When using a high capacity card, it is possible that fast rewinding may be slower than usual.

Note

- Sound can be heard through the speaker. Refer to [VOLUME] (P60) for information about how to adjust the volume in the [SETUP] menu.
- To play back the motion pictures recorded by this unit on a PC, use the “QuickTime” or the “PHOTOfunSTUDIO 6.0 HD Edition” software on the CD-ROM (supplied).
- QuickTime Motion JPEG motion pictures that were recorded with a PC or other equipment may have lower image quality or may not be able to play back with this unit.

[REC] Mode: **iA**

Taking Pictures using the Automatic Function (Intelligent Auto Mode)

The camera will set the most appropriate settings to match the subject and the recording conditions so we recommend this mode for beginners or those who want to leave the settings to the camera and take pictures easily.

Press **[iA]**.

(A) **[iA]** button

- **[iA]** button will light up when it is switched to Intelligent Auto Mode. **[iA]** button is turned off during recording to prevent the light reflecting on glass or similar, but this is not a malfunction.
- **[iA]** button is turned off and the camera is switched to [REC] Mode setup before the Intelligent Auto Mode was set when it is pressed again.
- It is also possible to switch to Intelligent Auto Mode from the screen listing the [REC] Mode. (P30)
- The following functions are activated automatically.
 - Scene Detection/[RED-EYE REMOVAL]/Face Detection/Intelligent ISO sensitivity control/[I.DYNAMIC]/[LONG SHTR NR]/[FOCUS PRIORITY]/Backlight Compensation/[I.RESOLUTION]
- In Intelligent Auto Mode, **[FOCUS PRIORITY]** (P144) is fixed to [ON]. When the subject is correctly focused, the picture will be taken.

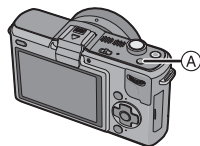

Scene Detection

When the camera identifies the optimum scene, the icon of the scene concerned is displayed in blue for 2 seconds, after which its color changes to the usual red.







When taking pictures

iA →		[i- PORTRAIT]
		[i- SCENERY]
		[i- MACRO]
		[i- NIGHT PORTRAIT]
		[i- NIGHT SCENERY]
		[i- BABY]*
		[i- SUNSET]

• Only when **[iA]** is selected

When recording motion pictures

 →	 [i-PORTRAIT]
	 [i-SCENERY]
	 [i-LOW LIGHT]
	 [i-MACRO]

- [iA] is set if none of the scenes are applicable, and the standard settings are set.
- When [iP], [iS] or [iL] is selected, the camera automatically detects a person's face, and it will adjust the focus and exposure. **(Face Detection)** (P86)
- If a tripod is used, for instance, and the camera has judged that camera shake is minimal when the Scene Mode has been identified as [iP], the shutter speed will be slower than normal. Take care not to move the camera while taking pictures.
- An optimum scene for the specified subject will be chosen when set to AF tracking (P50).
- When [FACE RECOG.] is set to [ON], and the face similar to the registered face is detected, [R] is displayed in the top right of [iP], [iS] and [iL].
- * When [FACE RECOG.] is set to [ON], [iA] will be displayed for birthdays of registered faces already set only when the face of a person 3 years old or younger is detected.

Note

- Due to conditions such as the ones below, a different scene may be identified for the same subject.
 - Subject conditions: When the face is bright or dark, the size of the subject, the color of the subject, the distance to the subject, the contrast of the subject, when the subject is moving
 - Recording conditions: Sunset, sunrise, under low brightness conditions, when the camera is shaken, when zoom is used
- To take pictures in an intended scene, it is recommended that you take pictures in the appropriate Recording Mode.
- **The Backlight Compensation**
 - Backlight refers to when light comes from the back of a subject. In this case, the subject will become dark, so this function compensates the backlight by brightening the whole of the picture automatically. Backlight compensation is automatically applied in Intelligent Auto Mode.

AF Tracking Function

It is possible to set the focus and exposure to the specified subject. Focus and exposure will keep following the subject automatically even if it moves.

■ When operating the touch panel

You can lock the subject by touching it.

- [AF-ON] is displayed in the lower left of the screen.
- AF Tracking frame will be displayed in yellow, and it will determine the most appropriate scene for the locked subject.
- AF Tracking is canceled when [OFF] is touched.



■ When operating buttons

1 Press ◀.

- [AF-ON] is displayed in the lower left of the screen.
- AF Tracking frame is displayed in the center of the screen.
- Press ◀ again to cancel.

(Tracking AF can also be canceled by touching [OFF].)

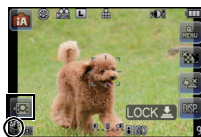

2 Place the subject in the Tracking frame, and press the shutter button halfway to lock the subject.

- AF area will turn green when the camera detects the subject.
- AF tracking frame will turn yellow when you release the shutter button and the optimum scene for the locked subject will be identified.
- Press [MENU/SET] to cancel.

(Lock can also be canceled by touching [OFF].)



Note

- The [FACE RECOG.] feature is disabled when AF Tracking is selected.
- Use AF Tracking with the Touch Shutter function canceled.
- Please read the Note regarding the AF tracking on P87.



Defocus control function

You can set to your preferred blurriness.

1 Touch  to display the setting screen.

2 Touch the slide bar to set.

3 Recording of pictures or motion pictures.

- It is also possible to record a picture by touching .
- Defocus Control is canceled by touching .

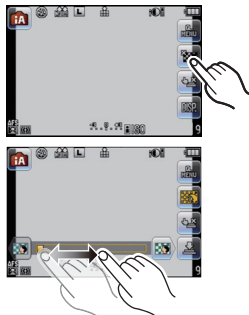

Note

- Blurriness may change during motion picture recording depending on the recording conditions.
- Aperture is controlled within the range of appropriate exposure during the recording of a motion picture, so the aperture may not actually change even when the slide bar is moved depending on the brightness of the subject, and the blurriness may not change. (For example, blurriness may not change for dark scenes, such as indoors, since the aperture is fixed to fully open.)
- Depending on the lens used, you may hear a sound from the lens when the Defocus Control is used, but this is due to operation of the aperture of the lens and it is not a malfunction.
- Depending on the lens used, operational sound of the Defocus Control may be recorded during the recording of a motion picture when the function is used.
- Depending on the lens used, use of the Defocus Control function may not be possible.

Settings in Intelligent Auto Mode

■ [REC] Mode menu

**[ASPECT RATIO] (P129)/[PICTURE SIZE] (P130)/[QUALITY] (P131)/[FACE RECOG.] (P119)/
[FOCUS MODE] (P32)/[PICTURE ADJUST]*1 (P137)/[STABILIZER]*2 (P76)**

*1 [PICTURE ADJUST] can only set [COLOR] and [B/W].

*2 [MODE3] is disabled. During motion picture recording [STABILIZER] is fixed to [MODE 1].

■ [MOTION PICTURE] Mode menu

**[REC MODE] (P139)/[REC QUALITY]*3 (P140)/[FOCUS MODE] (P32)/
[CONTINUOUS AF] (P43)/[WIND CUT] (P141)**



*3 [WVGA] is disabled when [MOTION JPEG] is selected.

■ [CUSTOM] menu

**[HISTOGRAM] (P68)/[GUIDE LINE] (P67)/[REMAINING DISP.] (P145)/
[DEFOCUS CTRL] (P146)**

■ [SETUP] menu

**[CLOCK SET] (P28)/[WORLD TIME] (P127)/[BEEP] (P60)/[LCD MODE] (P61)/
[LANGUAGE] (P65)**

•  or  can be selected for the length of the self-timer.*4 (P83)

*4 It will be reset to  when the Intelligent Auto Mode is canceled or when the power is switched [ON]/[OFF].

- The settings of the following items are fixed.

Item	Settings
[ECONOMY] ([SLEEP MODE]) (P62)	[5MIN.]
[QUICK AF] (P132)	[ON]
Flash (P71)	[iA]/[iS]
[BURST RATE] (P79)	[H] (High speed)
[AUTO BRACKET] (P81)	[□/□]SETTINGS: [□] (burst)
	[STEP]: [3•1/3]
	[SEQUENCE]: [0/-/+]
AF Mode (P85)	[i*] (Set to [i*] ^{*1} when a face cannot be detected)
[WHITE BALANCE] (P93)	[AWB]
[SENSITIVITY] (P98)	[iISO] ^{*2} (Intelligent ISO) (The maximum ISO sensitivity: [ISO800])
[METERING MODE] (P133)	[i○]
[RED-EYE REMOVAL] (P73)	[ON]
[I.DYNAMIC] (P135)	[STANDARD]
[LONG SHTR NR] (P136)	[ON]
[COLOR SPACE] (P138)	[sRGB]
[FOCUS PRIORITY] (P144)	[ON]
[AF ASSIST LAMP] (P144)	[ON]

*1 It will be set to Multi Auto Focus Mode for motion pictures when a face cannot be detected while recording motion pictures.

*2 The setting is fixed to [AUTO] (for motion pictures) when recording motion pictures.

- Depending on the scene detected, camera will automatically adjust the setting of the [I.RESOLUTION] (P134). [I.RESOLUTION] cannot be set via the [REC] Mode menu.
- The following functions cannot be used.
 - [AUTO LCD OFF] of [ECONOMY]/AF/AE lock/White Balance fine adjustment/White Balance Bracket/[ISO LIMIT SET]/[EX. TELE CONV.]/[DIGITAL ZOOM]/[HIGHLIGHT]/[AF/AE LOCK]/[DIRECT FOCUS AREA]/[SHOOT W/O LENS]
- The other items on the [SETUP] menu and [CUSTOM] menu can be set in a mode such as the Program AE Mode. What is set will be reflected in the Intelligent Auto Mode.

■ Flash

• Open the flash when the flash is to be used. (P71)

- While using the Intelligent Auto Mode, the flash mode is fixed.
- [iA], [iS], [iS] or [iS] is set depending on the type of subject and brightness.
- When [iS] or [iS] is displayed, the Digital Red-Eye Correction is turned on.
- Shutter speed will be slow when using [iS] or [iS].

Deleting Pictures

Once deleted, pictures cannot be recovered.

Press [▶].

Ⓐ [▶] button

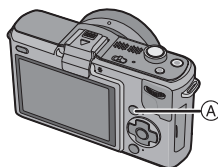

To delete a single picture

1 Select the picture to be deleted, and then touch [🗑️].



2 Touch [DELETE SINGLE].

3 Touch [YES].

To delete multiple pictures (up to 100) or all the pictures

- 1 Touch [].
- 2 Touch [DELETE MULTI] or [DELETE ALL].

- [DELETE ALL] → step 5.

- 3 Select the picture to be deleted.
(repeat this step)

- [] appears on the selected pictures. Touching again cancels the setting.
- The screen can be switched by dragging the slide bar up or down (P9).

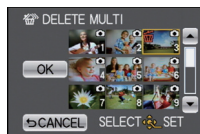

- 4 Touch [OK].
- 5 Touch [YES].

■ When [DELETE ALL] has been selected with the [FAVORITE] (P160) setting

The selection screen is displayed again. Select [DELETE ALL] or [ALL DELETE EXCEPT ★], select [YES] and delete the pictures.

Note

- Do not turn the camera off while deleting (while [] is displayed). Use a battery with sufficient battery power or the AC adaptor (optional).
- If you touch [CANCEL] while deleting pictures using [DELETE MULTI], [DELETE ALL] or [ALL DELETE EXCEPT ★], the deleting will stop halfway.
- Depending on the number of pictures to be deleted, it may take some time to delete them.
- If pictures do not conform to the DCF standard or are protected (P163), they will not be deleted even if [DELETE ALL] or [ALL DELETE EXCEPT ★] is selected.





Setting the Menu

When [MENU/SET] is pressed, [REC MODE] and 5 menus ([REC], [MOTION PICTURE], [CUSTOM], [SETUP], and [PLAYBACK]) are displayed.

In the 5 different menus, there are menus that allow you to setup the recording or playback to your preference, or make it more fun and easier to use the camera.

In particular, the [SETUP] menu contains some important settings relating to the camera's clock and power. Check the settings of this menu before proceeding to use the camera.

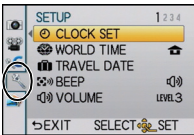
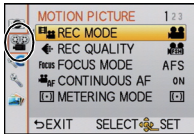

<p>[REC MODE]</p> <ul style="list-style-type: none"> For details on setting up [REC] Mode, refer to P30. 	<p>[CUSTOM] menu (P142 to 147)</p> <ul style="list-style-type: none"> Operation of the unit, such as displaying of the screen and button operations, can be set up according to your preferences. Also, it is possible to register the modified settings. 
<p>[REC] Mode menu (P129 to 138)</p> <ul style="list-style-type: none"> This menu lets you set the aspect ratio, number of pixels and other aspects of the pictures you are recording. 	<p>[SETUP] menu (P60 to 66)</p> <ul style="list-style-type: none"> This menu lets you perform the clock settings, select the operating beep tone settings and set other settings which make it easier for you to operate the camera. 
<p>[MOTION PICTURE] Mode menu (P139 to 141)</p> <ul style="list-style-type: none"> This menu lets you set the [REC MODE], [REC QUALITY], and other aspects for motion picture recording. 	<p>[PLAYBACK] Mode menu (P149 to 164)</p> <ul style="list-style-type: none"> This menu lets you set the Protection, Cropping or Print Settings, etc. of recorded pictures. 

Note

- There are functions that cannot be set or used depending on the modes or menu settings being used on the camera due to the specifications.

Setting menu items

This section describes how to setup the menu items.

- If you set [MENU RESUME] (P147) in the [CUSTOM] menu to [ON], the screen shows the last selected menu item when the camera was turned off. It is set to [ON] at the time of purchase.

1 Press [MENU/SET].

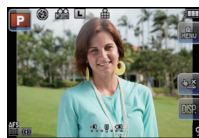

2 Select the menu by pressing ▲/▼/◀/▶ or by rotating the rear dial.

- Press [⏪/⏩] to return to the recording screen.
- It can also be set by the touch operation.



3 Press [MENU/SET] to display the menu.

- (A) Menu item
- (B) Settings

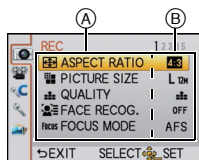

4 Select the menu item by pressing ▲/▼ or by rotating the rear dial.

- Select the item at the very bottom, and press ▼ or rotate the rear dial right to move to the next screen.

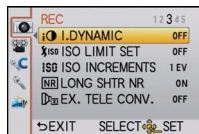

5 Press [MENU/SET] or the rear dial.

- Depending on the item, its setting may not appear or it may be displayed in a different way.
- The figure on the right is an example of selecting [I.DYNAMIC] in the Program AE Mode.

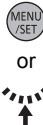
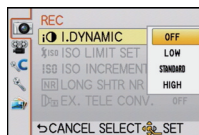

6 Select the settings by pressing ▲/▼ or by rotating the rear dial.

- The figure on the right is an example of setting [I.DYNAMIC] from [OFF] to [HIGH].

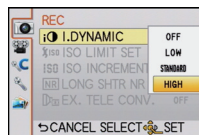

7 Press [MENU/SET] or the rear dial to set.

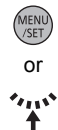
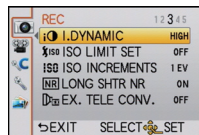

8 Press [EXIT/SET] to close the menu.

- You can also press the shutter button halfway to close the menu.

Switching to other menus

e.g.: Switching to the [SETUP] menu from [REC] mode menu

1 Press ◀.

- (A) Menu toggle icon

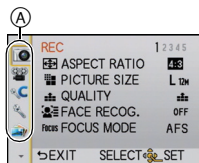

2 Press ▼ or rotate the rear dial to select the [SETUP] menu icon [🔑].

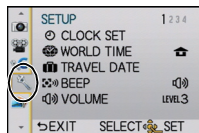

3 Press ▶ or the rear dial.

- Select a menu item next and set it.

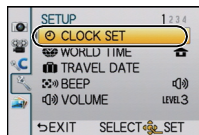



Setting the Quick Menu

By using the Quick Menu, some of the menu settings can be easily found.

- It is possible to operate with the cursor button and rear dial.
- The features that can be adjusted using Quick Menu are determined by the mode or a display style the camera is in. Items that cannot be used are displayed in gray.

1 Press [Q.MENU/Fn] to display the Quick Menu.

(A) Touch Quick Menu icon

- Quick Menu can also be displayed by touching [].
- When [Q.MENU/Fn] in the [CUSTOM] menu is set to [Fn], use [].

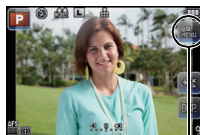

Q.MENU / Fn

A

2 Touch the menu item.

(B) Menu item

- Menu item can be switched by touching []/[].



B



3 Select and touch the setting.

(C) Settings



C



4 Touch [EXIT] to exit menu once the setting is completed.

■ Change the Quick Menu to your preferred item.

Up to 10 items to be used can be setup as Quick Menus. Set the menu items depending on the recording conditions, etc.

1 Touch [Q].



2 Select the menu in the top row and drag it to the bottom row.

Ⓓ Items that can be setup as Quick Menus.

Ⓔ Items that can be displayed in the Quick Menu screen.

• If there is no empty space in the bottom row, drag it into the menu item to be replaced.

New item can be set replacing the old item.

• When the item is dragged from the bottom row to the top row, the setting will be canceled and that space will become empty.

• Menu item or Settings can be switched by touching [◀]/[▶].

• Items that can be set are as follows:

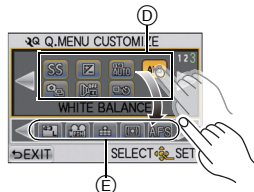

[REC] Mode menu

- [PICTURE SETTING] (P129, 130)/[QUALITY] (P131)/[FOCUS MODE] (P32)/[METERING MODE] (P133)/[FLASH] (P71)/[I.RESOLUTION] (P134)/[I.DYNAMIC] (P135)/[EX. TELE CONV.] (P69)/[BURST RATE] (P79)/[AUTO BRACKET] (P81)/[SELF-TIMER] (P83)/[STABILIZER] (P76)

Recording functions

- [AF MODE] (P85)/[SENSITIVITY] (P98)/[WHITE BALANCE] (P93)/Exposure Compensation (P78)/[APERTURE VALUE] (P100)/[SHUTTER SPEED] (P100)/[DRIVE MODE] (Single (P34)/Burst (P79)/Auto bracket (P81)/Self-timer (P83))

[MOTION PICTURE] Mode menu

- [MOTION PIC. SET] (P139, 140)

[CUSTOM] menu

- [HISTOGRAM] (P68)/[GUIDE LINE] (P68)/[REMAINING DISP.] (P145)

3 Touch [EXIT].

- It will return to screen of above step 1. Touch [EXIT] to switch to the recording screen.

Perform these settings if you need to.

About the Setup Menu

[CLOCK SET], [ECONOMY] and [AUTO REVIEW] are important items. Check their settings before using them.

For details on how to select the [SETUP] menu settings, refer to P56.

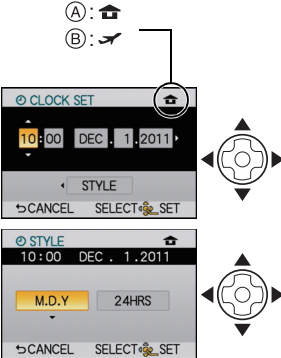
<p>⊖ [CLOCK SET]</p>	<p>1 Press ◀▶ to select the items, and press ▲▼ to set.</p> <p>(A) Time at the home area (B) Time at the travel destination (P127)</p> <ul style="list-style-type: none"> • [⏏]/[↔]: Cancel without setting the clock. <p>To set the display order and the time display format.</p> <ul style="list-style-type: none"> • Setup screen for display order and the time display format is displayed by selecting [STYLE] and then pressing [MENU/SET]. <p>2 Press [MENU/SET] to set.</p> <div style="text-align: right;">  </div>
----------------------	--

• Refer to "Setting Date/Time (Clock Set)" on P28 for other information.

<p>🌐 [WORLD TIME]</p>	<p>✈ [DESTINATION]/🏠 [HOME]</p>
-----------------------	---------------------------------

• Refer to P127 for details.

<p>📅 [TRAVEL DATE]</p>	<p>[TRAVEL SETUP]/[LOCATION]</p>
------------------------	----------------------------------

• Refer to P125 for details.

<p>🔊 [BEEP]</p>	<p>Set the volume of the focus confirmation beep, the self-timer beep and the alarm beep.</p> <p>[🔇] (Muted) [🔊] (Low) [🔊] (High)</p>
-----------------	---

<p>🔊 [VOLUME]</p>	<p>Adjust the volume of the speaker to any of 7 levels.</p>
-------------------	---

• When you connect the camera to a TV, the volume of the TV speakers does not change.

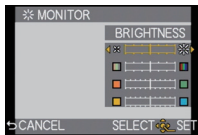

* [MONITOR]/ [VIEWFINDER]	Brightness, color, or red or blue tint of the LCD monitor/Optional Live Viewfinder is adjusted.
	<p>1 Select the settings by pressing ▲/▼, and adjust with ◀/▶ or the rear dial.</p> <ul style="list-style-type: none"> There are 4 settings: [BRIGHTNESS], [CONTRAST•SATURATION], [RED TINT] (color adjustment between red and green), and [BLUE TINT] (color adjustment between orange and blue). <p>2 Press [MENU/SET] to set.</p>



- It will adjust the LCD monitor when the LCD monitor is in use, and the viewfinder when Optional Live Viewfinder (P188) is in use.
- Some subjects may appear differently from actuality on the LCD monitor/viewfinder. However, this does not affect the recorded pictures.



LCD [LCD MODE]	The brightness of the LCD monitor can be adjusted depending on how bright it is around the camera.
	<p>[A]* [AUTO]: The brightness is adjusted automatically depending on how bright it is around the camera.</p> <p>[1]* [MODE1]: Make the LCD monitor brighter.</p> <p>[2]* [MODE2]: Set the LCD monitor to the standard brightness.</p> <p>[3]* [MODE3]: Make the LCD monitor darker.</p>





- The brightness of the pictures displayed on the LCD monitor is increased so some subjects may appear differently from actuality on the LCD monitor. However, this does not affect the recorded pictures.
- The LCD monitor automatically returns to standard brightness after 30 seconds when recording in [MODE1]. Press any button to make the LCD monitor bright again.
- If the screen is difficult to see because of light from the sun etc. shining on it, use your hand or another object to block the light.
- The number of recordable pictures decreases in [AUTO] and [MODE1].
- [AUTO] is only available in the Recording Mode.
- [AUTO] is disabled during motion picture recording.
- When the menu screen is displayed in a dark environment etc., the LCD monitor becomes darker even if [LCD MODE] is set to [MODE2].
- The initial setting when using the AC adapter (optional) is [MODE2].

ECO [ECONOMY]	You can conserve the battery life by setting these menus. Also, it will turn off the LCD monitor automatically when not in use to prevent discharge of the battery.
	 [SLEEP MODE]: The camera is automatically turned off if the camera has not been used for the time selected on the setting. [OFF]/[1MIN.]/[2MIN.]/[5MIN.]/[10MIN.]
	 [AUTO LCD OFF]: The LCD monitor is automatically turned off if the camera has not been used for the time selected on the setting. [OFF]/[15SEC.]/[30SEC.]



- Press the shutter button halfway or turn the camera off and on to cancel [SLEEP MODE].
- [SLEEP MODE] is set to [5MIN.] in the Intelligent Auto Mode.
- [SLEEP MODE] is fixed to [2MIN.] when [AUTO LCD OFF] is set to [15SEC.] or [30SEC.].
- Press any button to turn on the LCD monitor again.
- [SLEEP MODE] does not work in the following cases.
 - When using the AC adaptor
 - When connecting to a PC or a printer
 - When recording or playing back motion pictures
 - During a slide show

 [AUTO REVIEW]	Set the length of time that the picture is displayed after taking it.
	[OFF]/[1SEC.]/[3SEC.]/[5SEC.] [HOLD]: The pictures are displayed until shutter button is pressed halfway.

- If it is set to [HOLD] when the camera is set to [] (P34) or [] (P83), switching of the playback screen display (P39) or enlargement by rotating the rear dial is possible during Auto Review.
- Regardless of the Auto Review setting, pictures will automatically be reviewed when taking burst pictures with [H] set (P79), and recording with Auto Bracket (P81). (Will not hold) Under these conditions, [AUTO REVIEW] is disabled.
- If [HIGHLIGHT] (P142) is set to [ON], white saturated areas appear blinking in black and white when the Auto Review function is activated.
- [AUTO REVIEW] is disabled when Burst Mode is set to [M] or [L].
- When [AUTO REGISTRATION] in [FACE RECOG.] (P119) is set to [ON], [AUTO REVIEW] can only be set to [3SEC.] or [5SEC.].

 [USB MODE]	Select the USB communication system after or before connecting the camera to your PC or your printer with the USB connection cable (supplied).
	 [SELECT ON CONNECTION]: Select either [PC] or [PictBridge(PTP)] if you connected the camera to a PC or a printer supporting PictBridge.  [PictBridge(PTP)]: Set after or before connecting to a printer supporting PictBridge.  [PC]: Set after or before connecting to a PC.

- When [PC] is selected, the camera is connected via the “USB Mass Storage” communication system.
- When [PictBridge(PTP)] is selected, the camera is connected via the “PTP (Picture Transfer Protocol)” communication system.

 [TV ASPECT]	Set to match the type of TV.
	 [16:9]: When connecting to a 16:9 screen TV.  [4:3]: When connecting to a 4:3 screen TV.

- This will work when the AV cable is connected.

 [HDMI MODE]	<p>Set the format for the HDMI output when playing back on the HDMI compatible high-definition TV connected with this unit using the HDMI mini cable (optional).</p>
	<p>[AUTO]: The output resolution is automatically set based on the information from the connected TV.</p> <p>[1080i]: The interlace method with 1080 available scan lines is used for output.</p> <p>[720p]: The progressive method with 720 available scan lines is used for output.</p> <p>[480p]: The progressive method with 480 available scan lines is used for output.</p>

- If the images are not output on the TV when the setting is [AUTO], match with the image format your TV can display, and select the number of effective scanning lines. (Please read the operating instructions for the TV.)
- This will work when the HDMI mini cable (optional) is connected.
- Refer to [P171](#) for details.

 [VIERA Link]	<p>Setup so this unit can be controlled by the remote control of the VIERA equipment by automatically coupling this unit with the VIERA Link compatible equipment using HDMI mini cable (optional).</p>
	<p>[OFF]: Operation is performed with the buttons on this unit.</p> <p>[ON]: Remote control operation of the VIERA Link compatible equipment is enabled. (Not all operations are possible) Button operation of the main unit will be limited.</p>

- This will work when the HDMI mini cable (optional) is connected.
- Refer to [P173](#) for details.

 [3D PLAYBACK]	Setup the output method for 3D pictures.
	<p>[3D]: Set when connecting to a 3D compatible television.</p> <p>[2D]: Set when connecting to a television not compatible with 3D. Set this when you would like to view pictures in 2D (conventional image) on a 3D compatible television.</p>

- This will work when the HDMI mini cable (optional) is connected.
- Refer to [P167](#) for the method to playback 3D pictures in 3D.

 [CALIBRATION]	Adjust the position of the touch panel if a different thing gets selected from what you touched or touch operation does not respond.
	<p>1 Press [MENU/SET].</p> <p>2 Touch the orange [+] mark displayed on the screen in order with the stylus pen (supplied) (5 places).</p> <ul style="list-style-type: none"> • A message is displayed once the position is set. <p>3 Press [MENU/SET] to finish.</p>

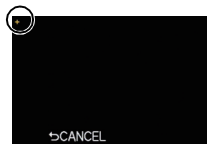

- To accurately calibrate the LCD Monitor, be sure to touch precisely at the designated locations.

 [LANGUAGE]	Set the language displayed on the screen.
--	---

- If you set a different language by mistake, select  from the menu icons to set the desired language.

 [VERSION DISP.]	This enables the firmware versions of the camera and lens to be checked.
--	--

- [-. -] is displayed as the lens firmware when the lens is not mounted.

 [NO.RESET]	Reset the file number of the next recording to 0001.
---	--

- The folder number is updated and the file number starts from 0001. (P181)
- A folder number between 100 and 999 can be assigned. The folder number should be reset before it reaches 999. We recommend formatting the card (P66) after saving the data on a PC or elsewhere.
- To reset the folder number to 100, format the card first and then use this function to reset the file number.
A reset screen for the folder number will then appear. Select [YES] to reset the folder number.

 [RESET]	The [REC] or [SETUP]/[CUSTOM] menu settings are reset to the initial settings.
--	--

- When the [REC] Mode settings are reset, data registered with [FACE RECOG.] will also be reset.
- When [SETUP]/[CUSTOM] menu settings are reset, the following settings are also reset. In addition, [FAVORITE] (P160) in [PLAYBACK] Mode menu is set to [OFF], and [ROTATE DISP.] (P159) is set to [ON].
 - The birthday and name settings for [BABY1]/[BABY2] (P112) and [PET] (P113) in Scene Mode.
 - The settings of [TRAVEL DATE] (P125) (departure date, return date, location)
 - The [WORLD TIME] (P127) setting.
- The folder number and the clock setting are not changed.

 [FORMAT]	The card is formatted. Formatting permanently deletes all data on your memory card. Please be sure all pictures and motion pictures are saved elsewhere before using this feature.
---	--

- Use a battery with sufficient battery power or the AC adaptor (optional) when formatting. Do not turn the camera off during formatting.
- If the card has been formatted on a PC or other equipment, format it on the camera again.
- If the built-in memory or the card cannot be formatted, consult your nearest Service Center.

For USA and Puerto Rico assistance, please call:
1-800-211-PANA(7262) or, contact us via the web at:
<http://www.panasonic.com/contactinfo>

For Canadian assistance, please call:
1-800-99-LUMIX (1-800-995-8649) or
send e-mail to: lumixconcierge@ca.panasonic.com

Switching the display of the LCD Monitor

Switching the Information Displayed on the recording screen

Touch **[DISP.]** to change.

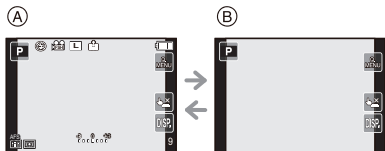

(A) Normal display*1, 2



(B) No display*1

*1 Guide lines are displayed when the [GUIDE LINE] of the [CUSTOM] menu is set to anything except [OFF].

*2 Histograms are displayed when the [HISTOGRAM] of the [CUSTOM] menu is set to [ON]. It is also possible to display the Exposure meter by setting the [EXPO.METER] of the [CUSTOM] menu to [ON]. (P143)

■ Recording guide line

When you align the subject on the horizontal and vertical guide lines or the cross point of these lines, you can take pictures with well-designed composition by viewing the size, the slope and the balance of the subject.

- (A) : This is used when dividing the entire screen into 3×3 for taking pictures with a well-balanced composition.
- (B) : This is used when you want to position the subject at the exact center of the screen.
- (C) : Position of the guide line can be set. It is used to take well balanced pictures of subjects off the center of the image.

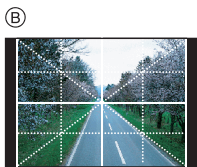

■ Set the position of the guide line with []

- Set the [GUIDE LINE] in the [CUSTOM] menu to [].

Touch [] above the guide line, and drag it to the position you want to move it to (P9).

- You can also set the position of the guide line with the cursor button in the [CUSTOM] menu.
- When it is difficult to move the guide line on the screen edge by touch operation, use the cursor button to set the position.

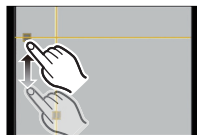

■ About the Histogram

A histogram is a graph that displays brightness along the horizontal axis (black to white) and the number of pixels at each brightness level on the vertical axis. It allows you to easily check a picture's exposure.

Examples of histogram

- 1 Properly Exposed
- 2 Under Exposed
- 3 Overexposed

1

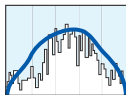

2

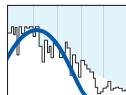

3

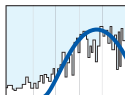

■ Set the position of the histogram

- Set the [HISTOGRAM] in the [CUSTOM] menu to [ON].

Touch the histogram and drag it to the position you want to move it to (P9).

- You can also set the position of the histogram with the cursor button in the [CUSTOM] menu.

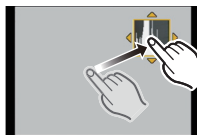

Note

- **When the recorded picture and the histogram do not match each other under the following conditions, the histogram is displayed in orange.**
 - When the manual exposure assistance is other than $[\pm 0]$ during Exposure Compensation or in the Manual Exposure Mode
 - When the flash is activated
 - When the flash is closed
 - When the brightness of the screen is not correctly displayed in dark places
 - When the exposure is not adequately adjusted
- The histogram is an approximation in the Recording Mode.
- The histogram displayed in this camera does not match histograms displayed by picture editing software used in PCs etc.

[REC] Mode: **iA PASM**  **SCN C**

Taking Pictures with the Zoom

Using the Optical Zoom/Using the Extended Tele Conversion (EX)/ Using the Digital Zoom

[You can only use the Optical Zoom in **[iA]**, and the Optical Zoom, the Extended Tele Conversion in **[SCN]** mode.]

You can zoom-out to record landscapes etc. in wide angle (Wide) or zoom-in to make people and objects appear closer (Tele) by turning the zoom ring.

(The interchangeable lens (H-H014) does not support the zoom ring function.)

To enlarge further, set the [EX. TELE CONV.] to [ON] or the [DIGITAL ZOOM] to [2×] or [4×] in the [REC] Mode menu or the [MOTION PICTURE] Mode menu. Then you can take larger photos.

When [EX. TELE CONV.] (max. 2×) is used in still picture recording, set each image aspect ratio (**4:3**/**3:2**/**16:9**/**1:1**) to a picture size other than [L] [picture size with **EX** (P130)].

■ Types of zooms

Feature	Optical Zoom	Extended Tele Conversion (EX)	Digital Zoom
Recording magnification	When the interchangeable lens (H-H014) is used		
	1×	when taking still pictures: 2× ^{*1}	[2×]
		when recording motion pictures: 3.1× ^{*2}	[4×]
	When the interchangeable lens (H-FS014042) is used		
3×	when taking still pictures: 2× ^{*1}	[2×]	
	when recording motion pictures: 3.1× ^{*2}	[4×]	
Picture quality	No deterioration	No deterioration	The higher the magnification level, the greater the deterioration.

*1 When a picture size of [S] (3 M), aspect ratio of **4:3** is selected.

The magnification level differs depending on [PICTURE SIZE] and [ASPECT RATIO] setting.

*2 When Recording Mode [AVCHD(720p)] is selected, or recording quality setting [HD] or [WVGA] is selected.

When Recording Mode [AVCHD(1080i)] is selected, there will be no enlarging with the Extended Tele Conversion (1x).

When Recording Mode [MOTION JPEG] is selected with recording quality setting [VGA] or [QVGA], Extended Tele Conversion factor will change to 4.2.

Example: When the interchangeable lens (H-FS014042) is used, you can achieve 24× magnification by 3× Optical Zoom + 2× Extended Tele Conversion + 4× Digital Zoom.

 **Note**

- With the Extended Tele Conversion, for example, when it is set to [EXS] (equal to 3 million pixels), it will take the picture using the 3 million pixels in the center out of the 12.1 million pixels of the imaging device, resulting to be more of a telephoto picture.
- When the Extended Tele Conversion is used, angle of view for still pictures will be different from the angle of view for motion pictures because the zoom factor is different between them. Angle of view for recording can be checked beforehand by matching the [REC AREA] (P145) setting to the mode you wish to record in.
- If you use the zoom function after focusing on the subject, focus on the subject again.
- The [STABILIZER] feature is disabled when using the Digital Zoom.
- If camera shake (jitter) is a problem during Digital Zooming, it is recommended that [STABILIZER] be set to [MODE1].
- When using the Digital Zoom, we recommend using a tripod and the self-timer (P83) for taking pictures.
- The AF Mode is fixed to [AF-ON] when using the Digital Zoom.
- The Extended Tele Conversion feature and Digital Zoom are disabled in the following modes:
 - When [QUALITY] is set to [RAW], [RAW] or [RAW]

[REC] Mode: **iA P A S M SCN C**

Taking Pictures using the Built-in Flash

(A) To open the flash

(B) To close the flash

Press the flash until it clicks.

- Be sure to close the flash when not in use.
- The flash setting is fixed to  while the flash is closed.

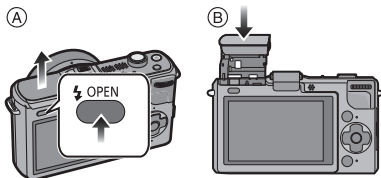

Note

- Be careful when opening the flash as the flash will jump out.
- Be careful not to catch a finger when closing a flash bulb.



Switching to the appropriate flash setting

Applicable modes: **P A S M SCN C**

Set the built-in flash to match the recording.

- Open the flash.

1 Select [FLASH] in the [REC] Mode menu. (P56)

2 Press / to select a mode and press [MENU/SET].





- For information about flash settings that can be selected, refer to “Available flash settings by Recording Mode”. (P73)

Item	Description of settings
⚡A: AUTO	The flash is automatically activated when the recording conditions make it necessary.
⚡A [Ⓢ] : AUTO/Red-Eye Reduction*	The flash is automatically activated when the recording conditions make it necessary. It is activated once before the actual recording to reduce the red-eye phenomenon (eyes of the subject appearing red in the picture) and then activated again for the actual recording. • Use this when you take pictures of people in low lighting conditions.
⚡: Forced Flash ON	The flash is activated every time regardless of the recording conditions. • Use this when your subject is back-lit or under fluorescent light.
⚡ [Ⓢ] : Forced ON/Red-Eye Reduction*	The flash is activated every time regardless of the recording conditions. Simultaneously it reduces the red-eye phenomenon. • Use this when your subject is back-lit or under fluorescent light.
⚡S: Slow Sync.	When taking pictures against a dark background landscape, this feature will slow the shutter speed when the flash is activated. Dark background landscape will appear brighter. • Use this when you take pictures of people in front of a dark background. • Using a slower speed can cause motion blur. Using a tripod can enhance your photos.
⚡S [Ⓢ] : Slow Sync./ Red-Eye Reduction*	When taking pictures against a dark background landscape, this feature will slow the shutter speed when the flash is activated. Dark background landscape will appear brighter. Simultaneously it reduces the red-eye phenomenon. • Use this when you take pictures of people in front of a dark background. • Using a slower speed can cause motion blur. Using a tripod can enhance your photos.
Ⓢ: Forced Flash OFF	The flash is not activated in any recording conditions. • Use this when you take pictures in places where the use of the flash is not permitted. • Close the flash to turn it off when the built-in flash is used.

The flash is activated twice. The interval between the first and second flash is longer when [⚡A[Ⓢ]], [⚡[Ⓢ]] or [⚡S[Ⓢ]] is set. The subject should not move until the second flash is activated.

* [RED-EYE REMOVAL] on the [REC] Mode menu is set to [ON], [🔧] appears on the flash icon.

■ About Digital Red-Eye Correction



















When [RED-EYE REMOVAL] on the [REC] Mode menu has been set to [ON] and Red-Eye Reduction ([, [, []) is selected, Digital Red-Eye Correction is performed whenever the flash is used. The camera automatically detects red-eye and corrects the picture. (Only available when the AF Mode is set to [] and Face Detection is active)

















- Red-Eye Correction works in most situations, but not all.

■ Available flash settings by Recording Mode

The available flash settings depend on the Recording Mode.

(○: Available, —: Not available, ●: Initial setting of Scene Mode)

							
	○*	—	—	—	—	—	○
	○	○	○	○	○	○	○
	○	○	○	○	○	○	○
	○	○	○	○	—	—	○
	—	—	○	○	—	—	○
	—	—	—	—	—	—	○
	○	●	○	—	—	—	○
	○	●	○	—	—	—	○
	—	—	—	—	—	—	●
	—	—	—	—	—	—	●
	●	—	○	—	—	—	○
	●	○	○	—	—	—	○

							
	●	—	○	—	—	—	○
	●	—	○	—	—	—	○
	●	—	○	—	—	—	○
	—	—	—	—	—	●	○
	—	—	—	—	—	—	●
	○	●	○	—	—	—	○
	○	●	○	—	—	—	○
	●	—	○	—	—	—	○
	—	—	—	○	—	●	○
	—	—	—	—	—	—	●

* [] is displayed. [], [], [] or [] is set depending on the type of subject and brightness.

- The flash setting may change if the Recording Mode is changed. Set the flash setting again if necessary.
- The flash setting is memorized even if the camera is turned off. However, the Scene Mode flash setting is reset to the initial setting when the Scene Mode is changed.
- Flash will not be activated when recording motion picture.

■ The available flash range to take pictures





- The available flash range is an approximation.



ISO sensitivity	When the interchangeable lens (H-H014) is used	When the interchangeable lens (H-FS014042) is used	
	Available flash range	Available flash range	
		Wide	Tele
AUTO	50 cm (1.64 feet) to 4.8 m (15.7 feet)*	1.0 m (3.28 feet) to 3.4 m (11.2 feet)*	30 cm (0.99 feet) to 2.1 m (6.88 feet)*
ISO100	50 cm (1.64 feet) to 2.4 m (7.87 feet)	1.0 m (3.28 feet) to 1.7 m (5.58 feet)	30 cm (0.99 feet) to 1.0 m (3.28 feet)
ISO200	50 cm (1.64 feet) to 3.3 m (10.8 feet)	1.0 m (3.28 feet) to 2.4 m (7.87 feet)	30 cm (0.99 feet) to 1.5 m (4.92 feet)
ISO400	50 cm (1.64 feet) to 4.8 m (15.7 feet)	1.0 m (3.28 feet) to 3.4 m (11.2 feet)	30 cm (0.99 feet) to 2.1 m (6.88 feet)
ISO800	70 cm (2.29 feet) to 6.7 m (32.5 feet)	1.0 m (3.28 feet) to 4.8 m (15.7 feet)	30 cm (0.99 feet) to 3.0 m (9.84 feet)
ISO1600	1.1 m (3.61 feet) to 9.6 m (31.5 feet)	1.0 m (3.28 feet) to 6.8 m (22.3 feet)	50 cm (1.64 feet) to 4.2 m (13.8 feet)
ISO3200	1.5 m (4.92 feet) to 13.5 m (44.3 feet)	1.1 m (3.61 feet) to 9.6 m (31.5 feet)	70 cm (2.29 feet) to 6.0 m (19.7 feet)
ISO6400	2.2 m (7.22 feet) to 19.2 m (63.0 feet)	1.6 m (5.25 feet) to 13.7 m (44.9 feet)	1.0 m (3.28 feet) to 8.5 m (51.5 feet)

* When the [ISO LIMIT SET] (P135) is set to [OFF]

- If the distance to the subject is close when taking a picture using a flash, part of the recorded image becomes dark because the light of flash is blocked by the lens or it becomes out of flash range. Check the distance to the subject when taking a picture. Distance to the subject where the light of flash is blocked depends on the lens used.
 - When the interchangeable lens (H-H014) is attached:
50 cm (1.64 feet) or less
 - When the interchangeable lens (H-FS014042) is attached:
1.0 m (3.28 feet) or less (Wide)/30 cm (0.99 feet) or less (Tele)

■ Shutter speed for each flash setting

Flash setting	Shutter speed (Sec.)
 A	1/60 ^{*1} to 1/4000th
 A [Ⓜ]	
	1/60 ^{*2} to 1/160th
	

Flash setting	Shutter speed (Sec.)
 S	1 to 1/4000th
 S [Ⓜ]	
	60 to 1/4000th

*1 This becomes 60 seconds in Shutter-Priority AE Mode.

*2 This becomes 60 seconds in Shutter-Priority AE Mode and 60 seconds in the Manual Exposure Mode.

- When the flash is activated the fastest shutter speed that can be selected is 1/160 of a second.
- In Intelligent Auto Mode, shutter speed changes depending on the identified scene.

Note

- Do not bring the flash too close to objects or close the flash while it is activated. The objects may be discolored by its heat or lighting.
- Do not close the flash soon after the flash is activated prior to taking pictures due to AUTO/Red-Eye Reduction etc. It causes a malfunction.
- Flash pictures taken closer or beyond the flash's rated distance may appear too bright or too dark.
- You must wait a moment to take the next picture while the flash icon is blinking RED indicating the flash is charging.
- When you take a picture beyond the available flash range, white balance may be set incorrectly.
- **When you use certain lenses, light from the flash may be blocked or fail to cover the lens field of view, causing dark areas to appear in the resulting pictures.**
- When taking pictures with flash with the lens hood attached, the lower portion of the photo may turn dark (vignetting effect) and the control of the flash may be disabled because the photo flash may be obscured by the lens hood. We recommend detaching the lens hood.
- It may take time to charge the flash if you repeat taking a picture. Take a picture after the access indication disappears.
- The Red-Eye Reduction effect differs between people. Also, if the subject was far away from the camera or was not looking at the first flash, the effect may not be evident.
- When you attach an external flash, it takes priority over the built-in flash. Refer to [P190](#) for the external flash.

[REC] Mode:       

Optical Image Stabilizer

Using one of these modes, jitter during picture taking is detected, and the camera automatically compensates the jitter, enabling jitter-free images to be taken.

A lens which supports the stabilizer function is required.

- The interchangeable lens (H-H014) does not support the stabilizer function.
- The interchangeable lens (H-FS014042) supports the stabilizer function.

■ Setting the Stabilizer in the [REC] Mode menu

- 1 Select [STABILIZER] in the [REC] Mode menu. (P56)
- 2 Press ▲/▼ to select the setting and then press [MENU/SET].

[OFF]: [STABILIZER] does not work.
(This can be selected only when using a lens without the [O.I.S.] switch.)

[MODE1]: Jitter is always compensated during [REC] Mode.

[MODE2]: The jitter is compensated for when the shutter button is pressed.

[MODE3]: Camera shake is corrected for up/down movements. This mode is ideal for panning (a method of taking pictures which involves turning the camera to track the movements of a subject which continues to move in a fixed direction).

- When recording a motion picture, [STABILIZER] will be fixed to [MODE1] even if it is set to [MODE2] or [MODE3].
- The [STABILIZER] feature is only available if the lens you are using has an internal stabilizer.

■ Preventing jitter (camera shake)

When the jitter alert [] appears, use [STABILIZER], a tripod or the self-timer (P83).

- Shutter speed will be slower particularly in the following cases. Keep the camera still from the moment the shutter button is pressed until the picture appears on the screen. We recommend using a tripod.
 - Slow Sync.
 - Slow Sync./Red-Eye Reduction
 - [NIGHT PORTRAIT], [NIGHT SCENERY] and [PARTY] in Scene Mode (P107)
 - When you set to a slow shutter speed

Note

- When using an optional interchangeable lens with an O.I.S. switch, it is possible to set to enable the Optical Image Stabilizer by switching the O.I.S. switch on the lens to [ON]. (At the time of purchase, it is initially set to [MODE1].)
- It is recommended to disable the Optical Image Stabilizer when using a tripod. [] is displayed on the screen at that time.
- The stabilizer function may not be effective in the following cases.
 - When there is a lot of jitter.
 - When the zoom magnification is high.
 - When using the Digital Zoom.
 - When taking pictures while following a moving subject.
 - When the shutter speed becomes slower to take pictures indoors or in dark places. Be careful of camera jitter when you press the shutter button.
- The panning effect in [MODE3] is more difficult to achieve in the following cases.
 - In brightly lit places such as in broad daylight on a summer's day
 - When the shutter speed is faster than 1/100th of a second.
 - When you move the camera too slowly because the subject is moving slowly. (The background will not become a blur.)
 - When the camera does not keep up with the subject satisfactorily
- We recommend taking pictures with the Optional Live Viewfinder (P188) when panning in [MODE3].

[REC] Mode: **iA P A S SCN C**

Compensating the Exposure

Use this function when you cannot achieve appropriate exposure due to the difference in brightness between the subject and the background. Look at the following examples.

Underexposed



Properly exposed



Overexposed



Compensate the exposure towards positive.

Compensate the exposure towards negative.

- 1 Press the rear dial to switch to Exposure Compensation operation.



- 2 Rotate the rear dial to compensate the exposure.

- (A) Exposure Compensation value
- (B) [EXPO.METER]

- Select [0] to return to the original exposure.
- Rotate the rear dial to display the [EXPO.METER]. (P143) (However, it does not appear in **iA/SCN** Mode.)

Note

- The set exposure value is memorized even if the camera is turned off. However, the exposure value during the Intelligent Auto Mode is not memorized.
- The compensation range of the exposure will be limited depending on the brightness of the subject.
- When the aperture and shutter speed values are displayed in the screen in the Program AE Mode, Program Shift operation and Exposure Compensation operation is switched every time the rear dial is pressed.
- In the Aperture-Priority AE Mode, Aperture Setting operation (P100) and Exposure Compensation operation is switched every time the rear dial is pressed.
- In the Shutter-Priority AE Mode, Shutter Speed Setting operation (P100) and Exposure Compensation operation is switched every time the rear dial is pressed.
- Exposure compensation can be performed by touching the slide bar in the Quick Menu (P58).

[REC] Mode: **iA PASM**  **SCN C**

Taking Pictures using Burst Mode

Pictures are taken continuously while the shutter button is pressed.
Select the ones you really like from among the pictures you have taken.

1 Press **▼** ( .



2 Touch burst icon (, etc.).



3 Select and touch the burst speed.



		[H] (High speed)	[M] (Middle speed)	[L] (Low speed)
Burst speed (pictures/second)		3.2	2.5	2
Live View during Burst Mode		None	Available	Available
*1	With RAW files	4 to 7*2		
	Without RAW files	Depends on the remaining capacity of the card*2		

*1 Number of recordable pictures

*2 Pictures can be taken until the capacity of the card becomes full. However the burst speed will become slower halfway. The exact timing of this depends on the aspect ratio, the picture size, the setting for the quality and the type of card used.

- First burst speed has no relation with the transfer speed of the card.
- The burst speed values given above apply when the shutter speed is 1/60 or faster and when the flash is not activated.
- The Burst Mode speed may become slower depending on the following settings.
– [SENSITIVITY] (P98)/[PICTURE SIZE] (P130)/[QUALITY] (P131)/[FOCUS MODE] (P32)/[FOCUS PRIORITY] (P144)
- Burst speed can also be set with [BURST RATE] in [REC] menu.
- Refer to P131 for information about RAW files.

4 Touch [SET].

5 Focus on the subject and take a picture.

(A) When Burst Mode is set to high speed [H].

- Hold down the shutter button fully to activate the Burst Mode.



■ Focusing in Burst Mode

The focus changes depending on the setting for [FOCUS PRIORITY] (P144) in the [CUSTOM] menu and the setting for [FOCUS MODE] (P132) in [REC] mode menu.

Focus Mode	Focus Priority	Focus
AFS	ON	At the first picture
	OFF	
AFC*1	ON	Normal focusing*2
	OFF	Predicted focusing*3
MF	—	Focus set with Manual Focus

*1 When subject is dark, the focus is fixed on the first picture.

*2 The burst speed may become slower because the camera is continuously focusing on the subject.

*3 Burst speed takes priority, and focus is estimated within possible range.

Note

- When the burst speed is set to [H] (when [FOCUS MODE] is [AFS] or [MF]), the exposure and White Balance are fixed at the settings used for the first picture for the subsequent pictures as well. Depending on the brightness of the subject, the second picture and subsequent pictures may be brighter or darker. When the burst speed is set to [H] (when [FOCUS MODE] is [AFC], [M] or [L]), they are adjusted each time you take a picture.
- If you are following a moving subject while taking pictures in a place indoors, outdoors etc. where there is a large difference between the light and shade (landscape), it may take time until the exposure is stable. If burst is used at this time, the exposure may be compensated incorrectly.
- Since the shutter speed becomes slower in dark places, the burst speed (pictures/second) may become slower.
- When set to [H], the Auto Review function is activated regardless of the Auto Review setting. (Will not hold) The Auto Review function in the [SETUP] menu is disabled. When set to [M] or [L], Live View is displayed between burst frames.
- When the flash is activated, you can take only 1 picture.
- The Burst Mode is disabled when White Balance Bracket is set.
- The Burst Mode is disabled during recording of the motion pictures.

[REC] Mode: **iA P A S M SCN C**

Taking Pictures using Auto Bracket

Maximum of 5 pictures will be recorded with different exposure settings following the Exposure Compensation range every time the shutter button is pressed.

You can select the picture with the desired exposure among different exposures.

With Auto Bracket

[STEP]: [3•1/3], [SEQUENCE]: [0/–/+]

1st picture



±0 EV

2nd picture



–1/3 EV

3rd picture



+1/3 EV

1 Press **▼** (📷☺).



2 Touch Auto Bracket icon ([3•1/3], etc.).

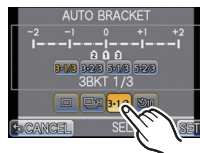

3 Select and touch the step.



4 Touch [SET].



5 Focus on the subject and take a picture.

(A) Auto Bracket indication

- If you press and hold the shutter button, the number of pictures that you set is taken.
- The Auto Bracket indication blinks until the number of pictures that you set is taken.
- The picture count is reset to [0] if you change the Auto Bracket setting or turn the camera off before all the pictures that you set are taken.



■ Changing the settings for [□/📷]SETTINGS, [STEP] and [SEQUENCE] in Auto Bracket

- 1 Select [AUTO BRACKET] in the [REC] Mode menu. (P56)
- 2 Press ▲/▼ to select [□/📷]SETTINGS, [STEP] or [SEQUENCE] and then press [MENU/SET].

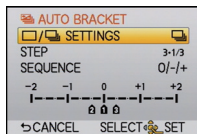

- 3 Press ▲/▼ to select the setting and then press [MENU/SET].

Item	Settings
[□/📷]SETTINGS	[□] (single)
	[📷] (burst)
[STEP]	[3•1/3] (3 pictures)
	[3•2/3] (3 pictures)
	[5•1/3] (5 pictures)
	[5•2/3] (5 pictures)

Item	Settings
[SEQUENCE]	[0/-/+]
	[-/0/+]

- You can take one picture at a time when set to [□].
- You can continuously take pictures up to set numbers when set to [📷].

- 4 Press [🔍/➔] twice to close the menu.

Note

- When taking pictures using Auto Bracket after setting the Exposure Compensation range, the pictures taken are based on the selected Exposure Compensation range.
- The exposure may be compensated incorrectly, depending on the brightness of the subject.
- When taking pictures continuously using Auto Bracket with [I.RESOLUTION] set to [EXTENDED], it may take time to record all the set number of pictures.
- In this mode the Auto Review mode is activated, regardless of the user settings.
- When the flash is activated, you can take only 1 picture.
- Auto Bracket is disabled when White Balance Bracket is set.
- The Auto Bracket will be disabled during recording of the motion pictures.

[REC] Mode: **iA PASM**  **SCN C**

Taking Pictures with the Self-timer

1 Press  ( .





2 Touch self-timer icon (, etc.).



3 Select and touch the time setting for the self timer.



Item	Settings
	10 seconds
	After 10 seconds the camera takes 3 pictures at about 2 second intervals.
	2 seconds

4 Touch [SET].



5 Press the shutter button halfway to focus and then press it fully to take the picture.

(A) When self-timer is set to .

- A picture is not taken until the subject is brought into focus. Focus and exposure will be set when the shutter button is pressed halfway.
- If you want to press the shutter button fully to take a picture even when the subject is not focused, set [FOCUS PRIORITY] in the [CUSTOM] menu to [OFF]. (P144)
- The self-timer indicator (B) blinks and the shutter is activated after 10 seconds (or 2 seconds).
- If you press [MENU/SET] while taking a picture with the self-timer, it is canceled.
- When  is selected, the self-timer indicator blinks again after the first and the second pictures are taken and the shutter is activated 2 seconds after it blinks.



 **Note**

- Time setting for the self timer can also be set by [SELF-TIMER] in the [REC] menu.
- Setting of the time setting for the self timer the [REC] menu is not possible when Intelligent Auto Mode is set.
- When using a tripod etc., setting the self-timer to 2 seconds is a convenient way to avoid the jitter caused by pressing the shutter button.
- We recommend using a tripod when recording with the self-timer.
- Depending on the recording conditions, the recording interval may become more than 2 seconds when  is selected.
- The flash output may vary slightly when the  is selected.
-  is disabled in Intelligent Auto Mode or when White Balance Bracket is set.
- The self-timer will be disabled during recording of the motion pictures.

[REC] Mode: **P A S M**  **SCN C**

Setting the Method used to Focus (AF Mode)

This allows the focusing method that suits the positions and number of the subjects to be selected.

Also, it is possible to set the focus and exposure to the subject specified on the touch panel.

Select the mode that matches the recording conditions and the composition.

1 Set the [FOCUS MODE] to [AFS] or [AFC] (P32).

- [AFS] or [AFC] will not operate with certain lenses. For details, refer to P13.



2 Press ◀ ().

3 Touch the item.



4 Touch [SET].

Note

- The  is disabled in the following cases.
 - [FOOD], [NIGHT SCENERY] and [ILLUMINATIONS] in the Scene Mode.
- The AF Mode is fixed to  when using the Digital Zoom.
- It will be set to  when a recording is performed with the Touch Shutter function (P37).
- AF area will be fixed to a small point in [PERIPHERAL DEFOCUS] in Scene Mode.

About [👤] (Face Detection)

The camera automatically detects the person's face. The focus and exposure can then be adjusted to fit that face no matter what portion of the picture it is in. (max. 15 areas)

When the camera detects a person's face, the AF area is displayed.

Yellow:

When the shutter button is pressed halfway, the frame turns green when the camera is focused.

White:

Displayed when more than one face is detected. Other faces that are the same distance away as faces within the yellow AF areas are also focused.



Note

- **Position and size of the AF area can be changed. (P89)**

- When [👤] is selected and [METERING MODE] is set to multiple [☐], the camera will adjust the exposure to suit the person's face. (P133)

- Under certain picture-taking conditions including the following cases, the Face Detection Function may fail to work, making it impossible to detect faces. The AF Mode is switched to [☐].

- When the face is not facing the camera
 - When the face is at an angle
 - When the face is extremely bright or dark
 - When there is little contrast on the faces
 - When the facial features are hidden behind sunglasses, etc.
 - When the face appears small on the screen
 - When there is rapid movement
 - When the subject is other than a human being
 - When the camera is shaking
- The camera may detect the subjects other than a person as the face. In this case, switch the AF Mode to any modes other than [👤] and then take a picture.

Setting up [AF-ON] (AF Tracking)

Focus and exposure can be adjusted to a specified subject. Focus and exposure will keep on following the subject even if it moves. (Dynamic tracking)

■ When operating the touch panel

You can lock the subject by touching it.

- The AF area turns yellow while the subject is locked.
- Lock is canceled when [MENU/SET] is touched.



■ When operating buttons

Place the subject in the AF tracking frame, and press the shutter button halfway to lock the subject.

- Ⓐ AF tracking frame
 - AF area will turn green when the camera detects the subject.
 - The AF area turns yellow when the shutter button is released.
 - Lock is canceled when [MENU/SET] is pressed.

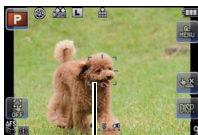

Note





- If it fails to lock, AF area will flash in red, and disappear. Try to lock again.
- AF Tracking may be disabled in certain picture conditions such as when it is very dark. AF Mode will be switched to [AF-ON] in that case.
- In the following cases, [AF-ON] operates as [AF-ON]
 - When [PICTURE ADJUST] is [B/W]
 - When My Color Mode is [MONOCHROME]
- Dynamic tracking function may not work in the following cases:
 - When the subject is too small
 - When the recording location is too dark or bright
 - When the subject is moving too fast
 - When the background has the same or similar color to the subject
 - When jitter is occurring
 - When zoom is operated

About (23-area-focusing)

Up to 23 points for each AF area can be focused. This is effective when the subject is not in the center of the screen.

(AF area frame will be same as image aspect ratio setting)

Note

- **The 23 AF areas can be divided into 9 areas and the area to be focused can be set. (P89)**
- When the AF Mode is set to  or  the AF area will be displayed as soon as the camera properly focuses. Also, if the [FOCUS MODE] is set to [AFC] while  is selected, the AF area is disabled.
- The camera is focusing on all the AF areas using  when multiple AF areas (max. 23 areas) light at the same time. If you want to determine the focus position to take pictures, switch the AF Mode to .

About (1-area-focusing)

The camera focuses on the subject in the AF area on the screen.

Note

- **Position and size of the AF area can be changed. (P89)**
- When the subject is not in the center of the composition in , you can bring the subject into the AF area, fix the focus and exposure by pressing the shutter button halfway, move the camera to the composition you want with the shutter button pressed halfway, and then take the picture. (Only when the [FOCUS MODE] is set to [AFS].)

Setting up position of the AF area/changing size of the AF area

■ When operating the touch panel

When selecting [●], [■]

Position and size of the AF area can be changed.

1 Touch the subject.

- AF area setting screen is displayed.

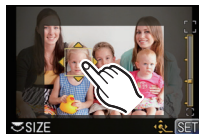

- When you touch outside the AF area frame (A), it will display the AF area setting screen, but the AF area will not be set.
- The AF area returns to the center when [Q.MENU/Fn] is pressed.

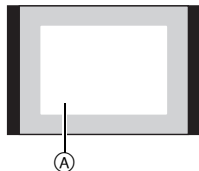

2 Touch the slide bar to change the size of AF area frame.

- It can be changed to 4 different sizes.

3 Touch [SET].

- AF area with the same function as [■] is displayed in the touched position, when the [●] is selected. Setting of the AF area is cleared when [OFF] is touched.

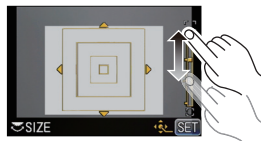

When selecting [■]

The 23 AF areas can be divided into 9 areas and the area to be focused can be set.

Touch the screen to display the AF area setting screen, and select the AF area frame as shown in the figure on the right.

- After releasing your finger from the touch panel for a while, AF area frame will disappear, and only [+] display (center point of selected AF area frame) will remain on the screen.
- Setting of the AF area frame is canceled when [OFF] is touched.

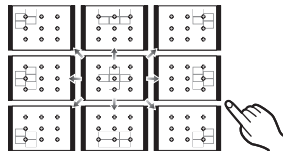

■ When operating buttons

- 1** Press **◀/▶** to select [👤], [📄], or [■], and press **▼**.

- AF area setting screen is displayed.



- 2** Press **▲/▼/◀/▶** to move the AF area.

- The AF area returns to the center when [Q.MENU/Fn] is pressed.
- AF area can be enlarged by rotating the rear dial to the right, and reduced by rotating to the left when [👤] or [■] is selected. It can be changed to 4 different sizes.



- 3** Press **[MENU/SET]** to set.

■ Move the AF area easily with [DIRECT FOCUS AREA] function

When the [DIRECT FOCUS AREA] in the [CUSTOM] menu is set to [ON] while [👤], [📄] or [■] is selected, it is possible to move the AF area directly with the cursor button.

- Use the functions that are assigned to the cursor button, such as [SENSITIVITY] (P98) or [WHITE BALANCE] (P93), by assigning them to the menu item of the Quick Menu (P58).



Note

- The spot metering target can also be moved to match the AF area when using [■]. (P133)
- Change the size of the AF area when there is trouble focusing with a small AF area.
- [DIRECT FOCUS AREA] is fixed to [OFF] in My Color Mode.

[REC] Mode: **iA P A S M**  **SCN C**

Taking Pictures with Manual Focus

Use this function when you want to fix the focus or when the distance between the lens and the subject is determined and you do not want to activate Auto Focus.

1 Set the [FOCUS MODE] in [REC] mode menu to [MF]. (P56)

2 Rotate the focus ring to focus on the subject.

- When the [MF ASSIST] in the [CUSTOM] menu is set to [ON], screen will be enlarged about 5 times as MF Assist. **(A)**
- MF guide **(B)** is displayed on the screen when the focus ring is rotated if the [MF GUIDE] in the [CUSTOM] menu is set to [ON]. You can check the direction of rotation of the focus ring is toward the near side or the far side.

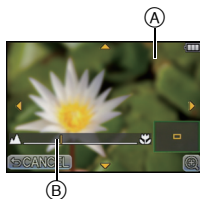

MF ASSIST



■ Displaying the MF Assist

- It is displayed by rotating the focus ring or touching the screen.
- It can also be displayed by pressing  to display the setup screen for the enlarged area, deciding the area to enlarge using the cursor button, and then pressing [MENU/SET].
- It will switch to the setting screen for the enlarged area by pressing the cursor button when the [DIRECT FOCUS AREA] in the [CUSTOM] menu is set to [ON].

■ Moving the enlarged area

- The enlarged area can be moved by dragging the screen (P9), or pressing the cursor button.
- The following will return the MF assistance to the original position.
 - When the [FOCUS MODE] is set to other than [MF]
 - Changing [ASPECT RATIO] or [PICTURE SIZE]
 - Turning the camera off

■ Changing the magnification

- It is enlarged to 10 times by touching . It will return to 5 times by touching .
- It will return to 10 times by rotating the rear dial right. It will return to 5 times by rotating the rear dial left.

■ Closing the MF Assist

- It will close when the shutter button is pressed halfway.
- It will also close by touching the [CANCEL] on the screen or pressing [MENU/SET].
- When displayed by rotating the focus ring, it is closed approximately 10 seconds after the operation is stopped.

Note

- The MF Assist is disabled when using the Digital Zoom or recording motion pictures.
- MF Assist or MF guide may not display depending on the lens used, but you can display MF Assist by direct operation of the camera, using the touch panel or a button.

Technique for Manual Focus

- 1 Rotate the focus ring to focus on the subject.
- 2 Rotate it a little more.
- 3 Finely focus on the subject by rotating the focus ring slowly in reverse.

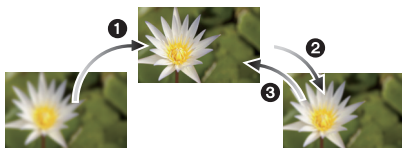

Note

- If you use the zoom function after focusing on the subject, focus on the subject again.
- After canceling Sleep Mode, focus on the subject again.
- If you are taking close-up pictures
 - We recommend using a tripod and the self-timer (P83).
 - The effective focus range (depth of field) is significantly narrowed. Therefore, if the distance between the camera and the subject is changed after focusing on the subject, it may become difficult to focus on it again.
 - The resolution of the periphery of the picture may decrease slightly. This is not a malfunction.

About the focus distance reference mark

The focus distance reference mark is a mark used to measure the focus distance. **Focus range**

Use this when taking pictures with Manual Focus or taking close-up pictures.

- (A) Focus distance reference mark
- (B) Focus distance reference line
- (C) 0.18 m (0.59 feet) [When the interchangeable lens (H-H014) is used]
- (D) 0.3 m (0.99 feet) [When the interchangeable lens (H-FS014042) is used]

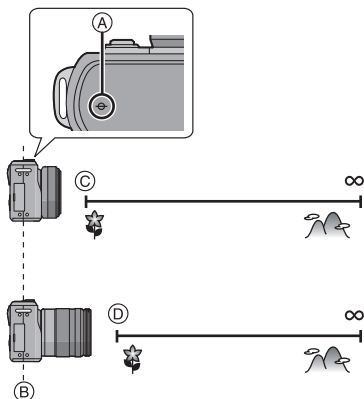

[REC] Mode: **P A S M** SCN **C**

Adjusting the White Balance

In sunlight, under incandescent lights or in other such conditions where the color of white takes on a reddish or bluish tinge, this item adjusts to the color of white which is closest to what is seen by the eye in accordance with the light source.

1 Press **▶** (WB).



2 Touch the White Balance to select.

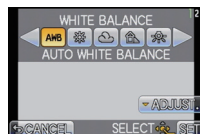

3 Touch [SET].



Item	Recording conditions
[AWB]	Automatic adjustment
[☀]	When taking pictures outdoors under a clear sky
[☁]	When taking pictures outdoors under a cloudy sky
[🏠]	When taking pictures outdoors in the shade
[💡]	When taking pictures under incandescent lights
[🔆]*	When taking pictures with the flash only
[📷]/[📷]	When using the preset White Balance
[🌡]:	When using the preset color temperature setting

*It will operate as [AWB] during motion picture recording.

■ Auto White Balance

Depending on the conditions prevailing when pictures are taken, the pictures may take on a reddish or bluish tinge. Furthermore, when a multiple number of light sources are being used or there is nothing with a color close to white, Auto White Balance may not function properly. In a case like this, set the White Balance to a mode other than [AWB].

1 Auto White Balance will work within this range.

2 Blue sky

3 Cloudy sky (Rain)

4 Shade

5 Sunlight

6 White fluorescent light

7 Incandescent light bulb

8 Sunrise and sunset

9 Candlelight

K=Kelvin Color Temperature

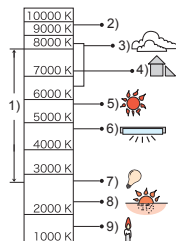

Note

- The optimal white balance will differ depending on the type of halogen lighting being recorded under so use [AWB], [☀️] or [🌧️].
- The White Balance is only calculated for subjects within the range of the camera's flash.
- The set White Balance is maintained even after the power switch is turned [OFF], but when the White Balance is changed in a different Scene Mode, [WHITE BALANCE] for the Scene Mode that was set will return to [AWB].
- White Balance is fixed to [AWB] in following conditions.
 - In Intelligent Auto Mode
 - In [SCENERY], [ARCHITECTURE], [FOOD], [NIGHT PORTRAIT], [NIGHT SCENERY], [ILLUMINATIONS], [PARTY], [SUNSET] in scene mode
 - My Color Mode
- When the [DIRECT FOCUS AREA] (P90) is set to [ON], operation of the cursor button is assigned to movement of the AF area. In such a case, assign the [WHITE BALANCE] as the menu item of the Quick Menu (P58) and perform the operation.

■ Setting the White Balance manually

Set the White Balance value. Use to match the condition when taking photographs.

1 Select [], [] and then touch [WHITE SET].

- The White Balance setting screen can also be displayed by pressing the cursor button toward ▲.

2 Aim the camera at a sheet of white paper etc. so that the frame in the center is filled by the white object only and then touch [SET].

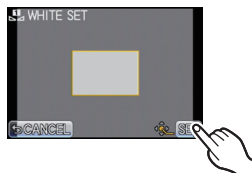

Note

- White Balance may not be set when the subject is too bright or too dark. Set the White Balance again after adjusting to appropriate brightness.

■ Setting the color temperature

You can set the color temperature manually for taking natural pictures in different lighting conditions. The color of light is measured as a number in degrees Kelvin. As the color temperature increases, the picture becomes more bluish. As the color temperature decreases, the picture becomes more reddish.

1 Select [] and then touch [WB K SET].

- The color temperature setting screen can also be displayed by pressing the cursor button toward ▲.

2 Touch the color temperature setting bar.

- It is also possible to set the values by touching [▲]/[▼] or pressing ▲/▼ of the cursor button.
- You can set a color temperature from [2500K] to [10000K].

3 Touch [SET].



■ Finely adjusting the White Balance

You can finely adjust the White Balance when you cannot acquire the desired hue by setting the White Balance.

1 Select the White Balance and then touch [ADJUST].

- The White Balance adjust screen can also be displayed by pressing the cursor button toward ▼.

2 Touch within the frame to finely adjust.

- You can finely adjust also by touching [G+]/[M-]/[A]/[B], or pressing ▲/▼/◀/▶ of the cursor button.

◀ : A (AMBER: ORANGE)

▶ : B (BLUE: BLUISH)

▲ : G+ (GREEN: GREENISH)

▼ : M- (MAGENTA: REDDISH)



3 Touch [SET].

Note

- If you finely adjust the White Balance to A (amber), the White Balance icon on the screen will change to orange. If you finely adjust the White Balance to B (blue), the White Balance icon on the screen will change to blue.
- If you finely adjust the White Balance to G+ (green) or M- (magenta), [+] (green) or [-] (magenta) appears beside the White Balance icon on the screen.
- Select the center point if you are not finely adjusting the White Balance.
- The White Balance fine adjustment setting is reflected in the picture when using the flash.
- You can finely adjust the White Balance independently for each White Balance item.
- The White Balance fine adjustment setting is memorized even if the camera is turned off.
- The White Balance fine adjustment level returns to the standard setting (center point) in the following cases.
 - When you reset the White Balance in [] or [].
 - When you reset the color temperature manually in [] [K].

■ White Balance Bracket

Bracket setting is performed based on the adjustment values for the White Balance fine adjustment, and 3 pictures with different colors are automatically recorded when the shutter button is pressed once.

1 Finely adjust the White Balance in step 2 of the “Finely adjusting the White Balance” procedure, and touch [◀] / [▶] to set the bracket.

- Bracket settings can also be made by rotating the rear dial.

[▶] or rear dial right: Horizontal (A to B)

[▶] or rear dial left: Vertical (G+ to M-)



2 Touch [SET].

Note

- [BKT] is displayed in White Balance icon in the screen when the White Balance Bracket is set.
- The White Balance Bracket setting is released when the power has been turned off (including Sleep Mode).
- You will only hear the shutter sound once.
- [RAW], [RAW+], or [RAW] of [QUALITY] cannot be set.
- The White Balance Bracket feature is disabled during motion picture recording.

[REC] Mode: **PASMC**

Setting the Light Sensitivity

This allows the sensitivity to light (ISO sensitivity) to be set. Setting to a higher figure enables pictures to be taken even in dark places without the resulting pictures coming out dark.

1 Press **▲** (ISO).



2 Touch the ISO sensitivity to select.



3 Touch [SET].



ISO sensitivity	100	6400
Recording location (recommended)	When it is light (outdoors)	When it is dark
Shutter speed	Slow	Fast
Noise	Less	Increased

ISO sensitivity	Settings
AUTO*	The ISO sensitivity is automatically adjusted according to the brightness.
ISO* (Intelligent)	The ISO sensitivity is adjusted according to the movement of the subject and the brightness.
100/200/400/800/1600/3200/6400	The ISO sensitivity is fixed to various settings. (When the [ISO INCREMENTS] in [REC] mode menu (P135) is set to [1/3 EV], items of ISO sensitivity that can be set will increase.)

* When the [ISO LIMIT SET] of [REC] Mode menu (P135) is set to anything except [OFF], it is set automatically within the value set in [ISO LIMIT SET].

It is set as following when the [ISO LIMIT SET] is set to [OFF].

[When the 3D interchangeable lens (optional) is attached, it may become higher than the following settings.]

- When [AUTO] is selected, ISO sensitivity is adjusted automatically depending on brightness within a maximum setting of [ISO400].
- When setting to [ISO], ISO sensitivity will adjust automatically depending on brightness within the maximum setting of [ISO800]. ([ISO400] when the flash is used)
- The ISO sensitivity will be set to [AUTO] (for motion pictures) when recording motion pictures. Also, the [ISO LIMIT SET] will not operate.

■ About [ISO] (Intelligent ISO sensitivity control)

The camera automatically sets the optimum ISO sensitivity and shutter speed to suit the movement of the subject and brightness of the scene to minimize the jitter of the subject.

- The actual shutter speed is calculated at the moment the picture is taken. It is continuously changing to match the movement of the subject until the shutter button is pressed fully. Confirm the actual shutter speed on the information display for the picture being played back.



Note

- The higher the value set for the ISO sensitivity, the more the jitter is reduced but the greater the amount of picture noise.
- Refer to P74 for the flash range.
- Even when [ISO] is selected, jitter reduction is limited, and related to the scene characteristics.
- Detection of image movement of small objects or objects located at the perimeter of the picture can be difficult.
- The setting is fixed to [ISO] in the following cases.
 - In [SPORTS],[BABY1]/[BABY2] and [PET] in Scene Mode
- Program Shift is deactivated when the ISO Sensitivity is set to [ISO].
- [ISO] is disabled when Shutter-Priority AE Mode and Manual Exposure Mode is selected. [AUTO] is disabled in Manual Exposure Mode.
- If picture noise becomes a problem, we recommend that you take pictures after lowering the ISO sensitivity level, increasing the setting for [NOISE REDUCTION] under [PICTURE ADJUST], or lowering the setting for each of the items other than [NOISE REDUCTION]. (P137)
- When the [DIRECT FOCUS AREA] (P90) is set to [ON], operation of the cursor button is assigned to movement of the AF area. In such a case, assign [SENSITIVITY] as a menu item in the Quick Menu (P58) and perform the operation.

[REC] Mode: **AS**

Taking Pictures by Specifying the Aperture/ Shutter Speed

Aperture-priority AE

Set the aperture value to a higher number when you want a sharp focus background. Set the aperture value to a lower number when you want a soft focus background.

1 Set [REC] Mode to [**A**].

- For details on setting up [REC] Mode, refer to P30.

2 Rotate the rear dial to set the aperture value.

- It will switch between aperture setting operation and Exposure Compensation operation every time the rear dial is pressed.
- Rotate the rear dial to display the [EXPO.METER]. (P143)



Shutter-priority AE

When you want to take a sharp picture of a fast moving subject, set with a faster shutter speed. When you want to create a trail effect, set to a slower shutter speed.

1 Set [REC] Mode to [**S**].

- For details on setting up [REC] Mode, refer to P30.

2 Rotate the rear dial to set the shutter speed.

- It will switch between shutter speed setting operation and Exposure Compensation operation every time the rear dial is pressed.
- Rotate the rear dial to display the [EXPO.METER]. (P143)



 **Note**

- **It will be a normal motion picture recording when recording a motion picture.**
- Aperture or shutter speed can be set by touching [F] (aperture) or [SS] (shutter speed) and then touching the exposure meter bar in the Quick Menu (P58).
- The brightness of the LCD monitor and the recorded pictures may differ. Check the pictures on the playback screen.
- Set the aperture value to a higher number when the subject is too bright in Aperture-Priority AE Mode. Set the aperture value to a lower number when the subject is too dim.
- When you use a lens with an aperture ring, the setting for the rear dial becomes effective if you rotate the aperture ring to the [A] position and the aperture ring setting takes priority if you rotate the aperture ring to a position other than [A] in Aperture-Priority AE Mode.
- The aperture value and the shutter speed displayed on the screen turn red and blink when the exposure is not adequate.
- We recommend using a tripod when the shutter speed is slow.
- In Shutter-Priority AE Mode, when the flash is activated, the fastest shutter speed that can be selected is 1/160th of a second. (P75)
- If you press the shutter button fully when the shutter speed is slow, the shutter speed on the screen counts down in Shutter-Priority AE Mode.
- In Shutter-Priority AE Mode the [S] and [S[⊙]] mode are disabled.
- The [SENSITIVITY] is automatically set to [AUTO] when you switch the Recording Mode to Shutter-Priority AE Mode while the [SENSITIVITY] is set to [ISO] (Intelligent).

[REC] Mode: **M**

Taking Picture by Setting the Exposure Manually

Determine the exposure by manually setting the aperture value and the shutter speed. The Manual Exposure Assistance appears on the lower portion of the screen to indicate the exposure.

1 Set [REC] Mode to [**M**].

- For details on setting up [REC] Mode, refer to P30.

2 Rotate the rear dial to set the aperture and shutter speed.

- It will switch between aperture setting operation and shutter speed setting operation every time the rear dial is pressed.
- Rotate the rear dial to display the [EXPO.METER]. (P143)
- You can also set the focus manually by setting the [FOCUS MODE] to [MF]. (P91)





3 Press the shutter button halfway.

- (A) Manual Exposure Assistance
- Set the aperture value and the shutter speed again when the exposure is not adequate.



Manual Exposure Assistance

	The exposure is adequate.
	Set to faster shutter speed or larger aperture value.
	Set to slower shutter speed or smaller aperture value.

- The manual exposure assistance is an approximation. We recommend checking the pictures on the playback screen.

 **Note**

- **It will be a normal motion picture recording when recording a motion picture.**
- Aperture or shutter speed can be set by touching [F] (aperture) or [SS] (shutter speed) and then touching the exposure meter bar in the Quick Menu (P58).
- The brightness of the LCD monitor and the recorded pictures may differ. Check the pictures on the playback screen.
- If the exposure is not adequate, the aperture value and the shutter speed turn red and blink when the shutter button is pressed halfway.
- In Manual Exposure Mode [A], [A[Ⓢ]], [S] and [S[Ⓢ]] are disabled.
- The [SENSITIVITY] is automatically set to [ISO100] when you switch the Recording Mode to Manual exposure while the [SENSITIVITY] is set to [AUTO] or [ISO] (Intelligent).
- If you press the shutter button fully when the shutter speed is slow, the shutter speed on the screen counts down.
- When you use a lens with an aperture ring, the aperture ring setting takes priority.

Using the function button

By assigning functions to the [Fn] (function) button, you can use [AF/AE LOCK] that allows you to take pictures with fixed exposure or focus, [PREVIEW] that allows you to confirm the effect of aperture and shutter speed, and other functions.

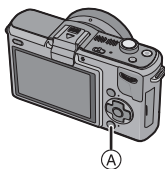

1 Set [Q.MENU/Fn] in the [CUSTOM] menu to [Fn].
(P56)

Ⓐ Q.MENU/Fn button

2 Select [Fn BUTTON SET] in [CUSTOM] menu.

3 Select the function you want to assign and press [MENU/SET].

[REC] Mode menu/Recording functions	[CUSTOM] menu
[AF/AE LOCK] (P105)/[PREVIEW] (P106)/ [ASPECT RATIO] (P129)/[QUALITY] (P131)/ [FOCUS MODE] (P32)/[METERING MODE] (P133)/ [I.RESOLUTION] (P134)/[I.DYNAMIC] (P135)/ [EX. TELE CONV.] (P136)/[PICTURE ADJUST] (P137)	[GUIDE LINE] (P67)/ [REC AREA] (P145)

Note

- Some functions cannot be used depending on the mode or displayed screen.

Fixing the Focus and the Exposure (AF/AE Lock)

Applicable modes: **P A S M**  **SCN C**

This is useful when you want to take a picture of a subject outside the AF area or the contrast is too strong and you cannot achieve appropriate exposure.

1 Set [Fn BUTTON SET] in the [CUSTOM] menu to [AF/AE LOCK]. (P56)

2 Align the screen with the subject.

3 Press [Q.MENU/Fn] to fix the focus or exposure.

- Ⓐ AE lock indication
- AF/AE Lock is canceled by pressing [Q.MENU/Fn] button again.

4 Move the camera as you compose the picture and then press shutter button fully.

- When [AE] is set, after pressing the shutter button halfway to focus, press the shutter button fully.



■ AF/AE Lock

Locking of the focus and exposure can be set in [AF/AE LOCK] in the [CUSTOM] menu.

Item	Settings
[AE]	Only the exposure is locked. • [AEL], aperture value, the shutter speed light when the exposure is set.
[AF]	Only the focus is locked. • [AFL], the focus indication, aperture value, the shutter speed light when the subject is focused.
[AF/AE]	Both focus and exposure are locked. • [AFL], [AEL], the focus indication, aperture value and the shutter speed light when the subject is focused and the exposure is set.

Note

- The brightness of the image displayed on the LCD monitor/Optional Live Viewfinder will be also locked when the AE lock is performed.
- AF Lock only is effective when taking pictures in Manual Exposure Mode.
- AE Lock only is effective when taking pictures with Manual Focus.
- AE Lock and AF Lock must be activated before motion picture recording begins. During motion picture recording only cancellation of AE/AF lock can be performed.
- The exposure is set, even if the brightness of the subject changes.
- The subject can be focused again by pressing the shutter button halfway even when AE is locked.
- Program Shift can be set even when AE is locked.

Confirm the Effects of Aperture and Shutter Speed (Preview Mode)

Applicable modes: **iA PASM SCN C**

The effects of aperture and shutter speed can be checked by using the Preview Mode.

- **Confirm the effects of aperture:** You can check the depth of field (effective focus range) before taking a picture by closing the leaf shutter to the aperture value you set.
- **Confirm the effects of shutter speed:** Movement can be confirmed by displaying the actual picture that will be taken with that shutter speed. When the shutter speed is set for high speed, display in the shutter speed preview will be displayed like a time-release film. It is used in cases such as stopping the movement of running water.

1 Set [Fn BUTTON SET] in the [CUSTOM] menu to [PREVIEW]. (P56)

2 Switch to confirmation screen by pressing [Q.MENU/Fn].

- Screen is switched every time [Q.MENU/Fn] is pressed.



Normal recording screen



Effects of Aperture



Effects of Shutter Speed

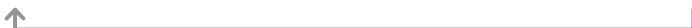
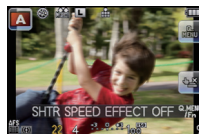

■ Depth of field properties

	Aperture value	Small	Large
*1	Focus length of the lens	Tele	Wide
	Distance to the subject	Near	Distant
	Depth of field (effective focus range)	Shallow (Narrow)*2	Deep (Wide)*3

*1 Recording conditions

*2 Example: When you want to take a picture with a blurred background etc.

*3 Example: When you want to take a picture with everything in focus including the background etc.

Note

- It is possible to record while in Preview Mode.
- Range for shutter speed effect check is 8 seconds to 1/1000th of a second.

[REC] Mode: **SCN**

Taking Pictures that match the Scene being recorded (Scene Mode)

When you select a Scene Mode to match the subject and recording situation, the camera sets the optimal exposure and hue to obtain the desired picture.

1 Set [REC] Mode to [**SCN**].

- For details on setting up [REC] Mode, refer to P30.

2 Touch the Scene Mode to select.

- Description of the selected scene mode is displayed on the screen.



3 Touch [SET].

- The menu screen is switched to the recording screen in the selected Scene Mode.

Note

- The Scene Mode flash setting is reset to the initial setting when the Scene Mode is changed and then used.
- When you take a picture with a Scene Mode that is not adequate for the purpose, the hue of the picture may differ from the actual scene.
- The following items cannot be set in Scene Mode because the camera automatically adjusts them to the optimal setting.
 - [SENSITIVITY]/[METERING MODE]/[I.RESOLUTION]/[I.DYNAMIC]/[ISO LIMIT SET]/[DIGITAL ZOOM]/Items other than [COLOR] and [B/W] in [PICTURE ADJUST]

[PORTRAIT]

When taking pictures of people outdoors during the day, this mode allows you to improve the appearance of the persons concerned and make their skin tones look healthier.

■ Technique for Portrait Mode

To make this mode more effective:

- 1 Rotate the zoom ring as far as possible to Tele. (when a lens with a zoom function is used)
- 2 Move close to the subject to make this mode more effective.

Note

- The initial setting for the AF Mode is [**AF**].

[SOFT SKIN]

When taking pictures of people outdoors during the daytime, this mode enables the texture of their skin to appear even softer than with [PORTRAIT]. (It is effective when taking pictures of people from the chest up.)

■ Technique for Soft Skin Mode

To make this mode more effective:

- ① Rotate the zoom ring as far as possible to Tele. (when a lens with a zoom function is used)
- ② Move close to the subject to make this mode more effective.

Note

- If a part of the background etc. is a color close to skin color, this part is also smoothed.
- This mode may not be effective when there is insufficient brightness.
- The initial setting for the AF Mode is [].

[SCENERY]

This allows you to take pictures of a wide landscape.

Note

- The flash setting is fixed to [].

[ARCHITECTURE]

This setting takes sharp photographs of architecture. The guide lines are displayed. (P67)

Note

- The flash setting is fixed to [].

[SPORTS]

Set here when you want to take pictures of sports scenes or other fast-moving events.

Note

- Intelligent ISO sensitivity control is activated, and maximum ISO sensitivity level becomes [ISO800].
- The initial setting for the AF Mode is [].

[PERIPHERAL DEFOCUS]

This mode makes it easy to pick out the subject on which to focus and blurs the background to make the subject stand out.

■ Setting the AF area

1 Touch the subject to move the AF area.

- AF area can also be moved by pressing the cursor button.

2 Touch [SET].



Note

- It will be a normal motion picture recording during the motion picture recording.
- Quick AF is performed automatically.
- Use the functions that are assigned to the cursor button, such as [WHITE BALANCE] (P93), by assigning them to the menu item of the Quick Menu (P58).
- AF area setting screen is displayed by pressing the cursor button. Press [⏏/↵] to return the AF area to the center of the screen.
- The obtained effects will differ depending on factors such as the distance to the subject and background, and the type of lens used. For best results, we recommend getting as close as possible to the subject when taking pictures. (P92)
- AF Mode will be fixed to a small point.

[FLOWER]

Flowers outdoors are recorded with natural colors in macro settings. The guide lines are displayed. (P67)

■ Technique for Flower Mode

- We recommend using a tripod and the self-timer.
- We recommend setting the flash to [☺] when you take pictures at close range.



Note

- The focus range is different depending on lens used. Refer to "About the focus distance reference mark" on P92 for the focus range.
- When a subject is close to the camera, the effective focus range is significantly narrowed. Therefore, if the distance between the camera and the subject is changed after focusing on the subject, it may become difficult to focus on it again.
- Close-up regions are prioritized when taking pictures, and so time is required to focus if you take a picture of a distant subject.
- When you take pictures at close range, the resolution of the periphery of the picture may decrease slightly. This is not a malfunction.
- If the lens becomes dirty with fingerprints or dust, the lens may not be able to focus on the subject correctly.

[FOOD]

You can take pictures of food with a natural hue without being affected by the ambient light in restaurants etc.

■ Technique for Food Mode

- We recommend using a tripod and the self-timer.
- We recommend setting the flash to [☺] when you take pictures at close range.



Note

- Refer to [FLOWER] for other information about this mode.

[OBJECTS]

You can take clear and vivid pictures of accessories or small objects in a collection.

■ Technique for Object Mode

- We recommend using a tripod and the self-timer.
- We recommend setting the flash to [☺] when you take pictures at close range.



Note

- Refer to [FLOWER] for other information about this mode.

[NIGHT PORTRAIT]

This allows you to take pictures of a person and the background with near real-life brightness.

■ Technique for Night Portrait Mode

- **Open the flash. (You can set to [☺].)**
- We recommend using a tripod and the Self-timer for taking pictures.
- When [NIGHT PORTRAIT] is selected, keep the subject still for about 1 second after taking the picture.



Note

- **During motion picture recording, low light settings [📷] are used, which will provide better pictures in dimly lit rooms or at nightfall.**
- The shutter may remain closed after taking the picture. This is due to signal processing and is not a malfunction.
- Noise may become visible when you take pictures in dark places.
- The initial setting for the AF Mode is [👁️].



[NIGHT SCENERY]

This allows you to take vivid pictures of the nightscape.

■ Technique for Night Scenery Mode

- We recommend using a tripod and the Self-timer for taking pictures.

Note

- **During motion picture recording, low light settings [] are used, which will provide better pictures in dimly lit rooms or at nightfall.**
- **The flash setting is fixed to [].**
- The shutter may remain closed after taking the picture. This is due to signal processing and is not a malfunction.
- Noise may become visible when you take pictures in dark places.
- The initial setting for the AF Mode is [].



[ILLUMINATIONS]

Illuminations are photographed beautifully.

■ Technique for ILLUMINATIONS Mode

- We recommend using a tripod and the self-timer.

Note

- **During Motion Picture Recording, low light settings [] are used, which will provide better pictures in dimly lit rooms or at nightfall.**
- **The flash setting is fixed to [].**
- The shutter may remain closed after taking the picture. This is due to signal processing and is not a malfunction.
- Noise may become visible when you take pictures in dark places.

[BABY1]/[BABY2]

This takes pictures of a baby with a healthy complexion. When you use the flash, the light from it is weaker than usual.

It is possible to set different birthdays and names for [BABY1] and [BABY2]. You can select to have these appear at the time of playback, or have them stamped on the recorded image using [TEXT STAMP] (P153).

■ Birthday/Name setting

- 1 Press **▲/▼** to select [AGE] or [NAME] and then press [MENU/SET].
- 2 Press **▲/▼** to select [SET] and then press [MENU/SET].
- 3 Enter the birthday or name.

Birthday: ◀/▶: Select the items (year/month/day).

▲/▼: Setting.

[MENU/SET]: Exit.

Name: For details on how to enter characters, refer to "Entering Text" on P128.

- When the birthday or name is set, [AGE] or [NAME] is automatically set to [ON].
- If [ON] is selected when the birthday or name has not been registered, the setting screen appears automatically.

- 4 Press **▲/▼** to select [EXIT] and then press [MENU/SET] to finish.

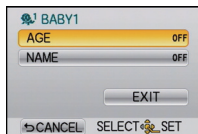

■ To cancel [AGE] and [NAME]

Select the [OFF] setting in step 2 of the "Birthday/Name setting" procedure.

- It can also be set with touch operation.

● Note

- During motion picture recording, settings for [PORTRAIT] are used.
- The age and name can be printed out using the "PHOTOfunSTUDIO 6.0 HD Edition" bundled software on the CD-ROM (supplied).
- If [AGE] or [NAME] is set to [OFF] even when the birthday or name has been set, the age or name will not be displayed. Before taking pictures, set [AGE] or [NAME] to [ON].
- Intelligent ISO sensitivity control is activated, and maximum ISO sensitivity level becomes [ISO400].
- If the camera is turned on with [BABY1]/[BABY2] set, the age and name are displayed at the lower left of the screen for about 5 seconds, along with the current date and time.
- The initial setting for the AF Mode is [AF-ON].

[PET]

Select this when you want to take pictures of a pet such as a dog or a cat. You can set your pet's birthday and name.

For information about [AGE] or [NAME], refer to [BABY1]/[BABY2] on P112.



 **Note**

- **It will be a normal motion picture recording during the motion picture recording.**
- The initial setting for the AF Assist Lamp is [OFF].
- Intelligent ISO sensitivity control is activated, and maximum ISO sensitivity level becomes [ISO800].
- The initial setting for the AF Mode is [].
- Refer to [BABY1]/[BABY2] for other information about this mode.

[PARTY]

Select this when you want to take pictures at a wedding reception, an indoor party etc. This allows you to take pictures of people and the background with near real-life brightness.

 **Technique for Party Mode**

- **Open the flash.** (You can set to [] or [].)
- We recommend using a tripod and the self-timer for taking pictures.



 **Note**

- The initial setting for the AF Mode is [].

[SUNSET]

Select this when you want to take pictures of a sunset view. This allows you to take vivid pictures of the red color of the sun.

 **Note**

- **The flash setting is fixed to [].**
- The initial setting for the AF Mode is [].

[REC] Mode: 

Taking Pictures while Adjusting Color (My Color Mode)

You can take pictures with a desired effect by previewing the subject on the LCD monitor or Optional Live Viewfinder (Live View) (P188) and setting the desired effect.

1 Set [REC] Mode to .

- For details on setting up [REC] Mode, refer to P30.

2 Touch the item.

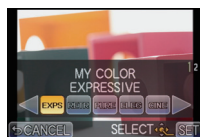

Item	Effect
[EXPRESSIVE]	This is a pop art style image effect that emphasises the color.
[RETRO]	This is a soft image effect that gives the appearance of a tarnished photograph.
[PURE]	This is an image effect that uses a cool, bright light to give a feeling of freshness. (The image will come out bright and slightly bluish.)
[ELEGANT]	This is an image effect that creates a tranquil atmosphere and projects a feeling of stateliness. (The image will come out slightly dark and amberish.)
[CINEMA]	This is an image effect that gives the appearance of cinema film with rich gradation expression.
[MONOCHROME]	This is an image effect that captures the subject using tones characteristic of black and white photography, and with a whisper of color.
[DYNAMIC ART]	This is an impressive image effect that adjusts dark areas and bright areas to appropriate brightness, together with enhancements on colors.
[SILHOUETTE]	This is an image effect that enhances the subject in the shade as a black silhouette by using the background colors of the sky or sunset etc.
[CUSTOM]	The color effects can be set according to your preferences.

3 Touch [SET].

■ Readjust the My Color settings

Return to step 2 on previous page by pressing rear dial.

Note

- During Motion Picture Recording, settings for My Color Mode are used.
- My Color settings are memorized even if the camera is turned off.
- The Auto Bracket is disabled in My Color Mode.
- ISO sensitivity will be fixed to [AUTO], and white balance will be fixed to [AWB].
- [I.DYNAMIC], [COLOR SPACE] can be set only when the My Color Mode is set to [CUSTOM].
- The following items cannot be set in My Color Mode because the camera automatically adjusts them to the optimal setting.
– [FLASH]/[ISO LIMIT SET]/[PICTURE ADJUST]

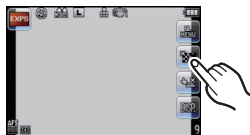

■ Set the preferred blurriness

1 Touch  to display the setting screen.



2 Touch the slide bar to set.

3 Recording of pictures or motion pictures.

- It is also possible to record a picture by touching .
- Defocus Control is canceled by touching .







Note

- Blurriness may change during motion picture recording depending on the recording conditions.
- Aperture is controlled within the range of appropriate exposure during the recording of a motion picture, so the aperture may not actually change even when the slide bar is moved depending on the brightness of the subject, and the blurriness may not change. (For example, blurriness may not change for dark scenes, such as indoors, since the aperture is fixed to fully open.)
- Depending on the lens used, you may hear a sound from the lens when the Defocus Control is used, but this is due to operation of the aperture of the lens and it is not a malfunction.
- Depending on the lens used, operational sound of the Defocus Control may be recorded during the recording of a motion picture when the function is used.
- Depending on the lens used, use of the Defocus Control function may not be possible.

■ Adjusting the custom settings to achieve desired effects

By selecting [CUSTOM], you can take pictures with color, brightness and saturation adjusted to desired levels.

- 1 Touch [CUST].
- 2 Touch [SET].
- 3 Touch the item.

Item	Adjustment contents
 [COLOR]	This will adjust the color of the image from red light to blue light. (11 steps in ± 5)
 [BRIGHTNESS]	This will adjust the brightness of the image. (11 steps in ± 5)
 [SATURATION]	This will adjust the color intensity of the image from black and white to vivid color. (11 steps in ± 5)
 [CONTRAST]	Adjusts the difference between the brightness and the darkness of the picture. (11 steps in ± 5)
 [RESET]	Return all settings to default

- 4 Touch the slide bar.
- 5 Touch [SET].



■ Return [CUSTOM] settings to default

- 1 Touch [] in above step 3.
- 2 Touch [YES].
 - Adjusted value for each item returns to standard (center point).

Note

- [CUSTOM] adjustments made in My Color Mode are only used in that mode.
- Icons for the adjusted items are displayed in the screen when the [CUSTOM] are adjusted. Displayed icon is the one for direction of adjustment.
- For best results when using the AF Tracking mode, use the default [SATURATION] setting.

[REC] Mode: **C**

Taking Pictures in Custom Mode

You can select one of your own custom settings saved with [CUST. SET MEM.] to suit the picture-taking conditions.

Initial setting of the Program AE Mode is registered as the custom settings initially.

1 Set [REC] Mode to **[C]**.

- For details on setting up [REC] Mode, refer to P30.

2 Select and touch the custom settings.



- Settings for the selected custom set are displayed.
- Only some of the menu items are displayed. (Refer to the following for the menu items that are displayed.)

QAF	[QUICK AF]	AF*	[AF ASSIST LAMP]
ISO MAX	[ISO LIMIT SET]	+AF	[AF+MF]
NR	[LONG SHTR NR]	SHOOT	[SHOOT W/O LENS]
Q.MENU	[AUTO REVIEW]	Q.MENU/Fn	[Q.MENU/Fn]
FOCUS	[FOCUS PRIORITY]	Fn	[Fn BUTTON SET]*

* Displayed only when a custom set with [Q.MENU/Fn] set to [Fn] is selected.

3 Touch [SET].

(A) Display custom settings

- Saving of the selected custom settings is displayed on the screen.

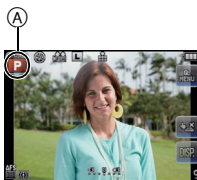

■ Registering Personal Menu Settings (Registering custom settings)

It is possible to register up to 3 sets of current camera settings as custom sets.

- Set in advance the [REC] Mode you wish to save and select the desired menu settings on the camera.

1 Select [CUST. SET MEM.] in the [CUSTOM] menu. (P56)

2 Press ▲/▼ to select the custom set to register and then press [MENU/SET].

3 Press ▲ to select [YES] and then press [MENU/SET].

- When [YES] is selected, the settings that were previously stored are overwritten.

■ When changing the menu settings

Even if the menu settings are changed temporarily with [C1], [C2] or [C3] selected, what has been registered will remain unchanged.

To change what has been registered, overwrite the registered data using [CUST. SET MEM.] on the [CUSTOM] menu.



Note

- The following menu settings are not registered in the custom set since they are reflected to other [REC] modes.

[REC] menu/Recording functions	[SETUP] menu	[CUSTOM] menu
<ul style="list-style-type: none"> • [BABY1]/[BABY2] or [PET] birthday and name settings in Scene Mode • Data registered with [FACE RECOG.] 	<ul style="list-style-type: none"> • [CLOCK SET] • [WORLD TIME] • [TRAVEL DATE] • [LCD MODE] • [LANGUAGE] 	<ul style="list-style-type: none"> • [A] BUTTON SWITCH] • [TOUCH GUIDE] • [TOUCH SCROLL]

[REC] Mode: **IA PASM**  **SCN C**

Taking a Picture with Face Recognition Function

Face Recognition is a function which finds a face resembling a registered face and prioritizes focus and exposure automatically. Even if the person is located towards the back or on the end of a line in a group photo, the camera can still take a clear picture.

[FACE RECOG.] is initially set to [OFF] on the camera.

[FACE RECOG.] will turn [ON] automatically when the face image is registered.

- The following functions will also work with the Face Recognition function.



In Recording Mode

- Display of corresponding name when camera detects a registered face* (if name has been set for the registered face)
- The camera will remember the face that has been photographed many times and display the registration screen automatically (if [AUTO REGISTRATION] is set to [ON])

In Playback Mode

- Display of name and age (if information has been registered)
- Selective playback of pictures chosen from pictures registered with Face Recognition ([CATEGORY PLAY] (P151))

- * Names of up to 3 people are displayed. Precedence for the names displayed when taking pictures is determined according to the order of registration.

Note

- **[FACE RECOG.] only works when the AF Mode is set to [AF].**
- During the Burst Mode, [FACE RECOG.] picture information can be attached to only the first picture.
- After pressing the shutter halfway down, a different person's picture information may be added when the camera is turned to a different subject to photograph.
- You cannot use [FACE RECOG.] in the following scene modes.
 - [PERIPHERAL DEFOCUS]/[FOOD]/[NIGHT SCENERY]/[ILLUMINATIONS]
- Auto face registration is disabled when the [FOCUS MODE] is set to manual [MF].
- Similarity in facial features can result in one person being recognized as another.
- Face Recognition may take more time to select and recognize distinctive facial features than regular Face Detection.
- Even when face recognition information has been registered, pictures taken with [NAME] set to [OFF] will not be categorized by face recognition in [CATEGORY PLAY].
- **Even when Face Recognition information is changed (P123), Face Recognition information for the pictures already taken will not be changed.**

For instance, if the name is changed, pictures recorded before the change will not be categorized by face recognition in [CATEGORY PLAY].
- To change the name information of the pictures taken, perform the [REPLACE] in [FACE REC EDIT] (P164).

Face Settings

You can register information such as names and birthdays for face images of up to 6 people.

Registration can be facilitated by taking multiple face images of each person. (up to 3 pictures/registration)

■ Point of recording when registering the face images

- Face front with eyes open and mouth closed, making sure the outline of the face, the eyes, or the eyebrows are not covered with the hair when registering.
- Make sure there is no extreme shading on the face when registering. (Flash will not flash during registration.)

(Good example for registering)

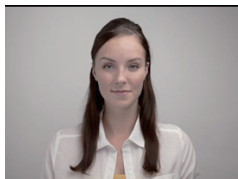

■ When it is not recognising during recording

- Register the face of same person indoors and outdoors, or with different expressions or angles. (P123)
- Additionally register at the location of recording.
- Changing the [SENSITIVITY] setting. (P123)
- When a person who is registered is not recognized, correct by re-registering.

Example of faces that are hard to recognize

Face Recognition may not be possible or may not recognize faces correctly even for registered faces in the following instances, depending on the facial expression and environment.

- Hair is covering the eyes or the eyebrows (A)
- The face is dark/the light is at an angle (B)
- The face is facing in angle or sideways
- The face is facing upward/downward
- The eyes are closed
- When the face is extremely bright or dark
- Hidden by sunglasses, glasses reflecting light, hair, hat, etc.
- When the face appears small on the screen
- The entire face is not in the screen
- When distinctive facial features have changed with age
- When parents and children or siblings closely resemble one another
- Facial expression is very different
- When there is little contrast on the faces
- When there is rapid movement
- When the camera is shaking
- When Digital Zoom is used

(A)

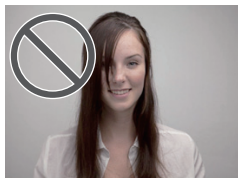

(B)



■ Registering face image of new person

1 Select [FACE RECOG.] on the [REC] Mode menu and then press [MENU/SET]. (P56)

2 Press ▲/▼ to select [MEMORY] and then press [MENU/SET].

3 Press ▲/▼/◀/▶ to select the face recognition frame that is not registered, and then press [MENU/SET].

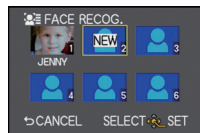

4 Take the picture adjusting the face with the guide.

- The faces of subjects other than people (pets, etc.) cannot be registered.
- When recognition fails, a message will appear and the display will return to the recording screen. In this case, try taking the picture again.

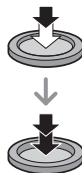

5 Press ▲ to select [YES] and then press [MENU/SET].

6

Select item to edit with ▲/▼, and then press [MENU/SET].

- You can register up to 3 face images.

Item	Description of settings
[NAME]	It is possible to register names. 1 Press ▼ to select [SET] and then press [MENU/SET]. 2 Enter the name. <ul style="list-style-type: none"> • For details on how to enter characters, refer to “Entering Text” section on P128.
[AGE]	It is possible to register the birthday. 1 Press ▼ to select [SET] and then press [MENU/SET]. 2 Press ◀/▶ to select the items (Year/Month/Day), and then press ▲/▼ to set and then press [MENU/SET].
[ADD IMAGES]	To add additional face images. (Add Images) 1 Select the unregistered face recognition frame, and then press [MENU/SET]. 2 Perform steps 4 and 5 in “Registering face image of new person”. 3 Press [⏏/↵].
	To delete one of the face images. (Delete) 1 Press ◀/▶ to select the face image to delete, and then press [MENU/SET]. 2 Press ▲ to select [YES] and then press [MENU/SET]. 3 Press [⏏/↵]. <ul style="list-style-type: none"> • This feature requires that at least one facial image remain, once registered.

7

Press [⏏/↵] a few times to exit the menu.**■ About the information ⓘ**

- When ▶ is pressed on the recording screen described in step 4 on [P121](#), an explanation appears for taking face images. (Press [⏏/↵] to return to the recording screen.)

■ Change or delete the information for a registered person

You can modify the pictures or information of an already registered person. You can also delete the information of the registered person.

- 1 Select [FACE RECOG.] from the [REC] Mode menu, and then press [MENU/SET]. (P56)
- 2 Press ▼ to select [MEMORY] and press [MENU/SET].
- 3 Press ▲/▼/◀/▶ to select the face image to edit or delete and then press [MENU/SET].
- 4 Press ▲/▼ to select the item and then press [MENU/SET].

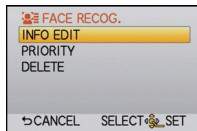

Item	Description of settings
[INFO EDIT]	Changing the information of an already registered person. Perform step 6 in “Registering face image of new person”.
[PRIORITY]	The focus and exposure are preferentially adjusted for higher-priority faces. Press ▲/▼/◀/▶ to select the priority and then press [MENU/SET].
[DELETE]	Deleting information of a registered person. Press ▲ to select [YES] and then press [MENU/SET].

- 5 Press [🗑️/↵] a few times to exit the menu.

Setting Auto Registration/Sensitivity

Setting of Auto Registration and Sensitivity for Face Recognition can be done.

- 1 Select [FACE RECOG.] from the [REC] Mode menu, and then press [MENU/SET]. (P56)
- 2 Press ▼ to select [SET] and then press [MENU/SET].
- 3 Press ▲/▼ to select the item and then press [MENU/SET].

Item	Description of settings
[AUTO REGISTRATION]	[OFF]/[ON] <ul style="list-style-type: none"> • When the [AUTO REGISTRATION] is set to [ON], [FACE RECOG.] will be set to [ON] automatically. • For details, see “Auto Registration” on P124.
[SENSITIVITY]	[HIGH]/[NORMAL]/[LOW] <ul style="list-style-type: none"> • Select [HIGH] when recognition proves to be difficult. The likelihood of recognition increases, but so does the likelihood of mistaken recognition. • Select [LOW] when mistaken recognition happens frequently. • To return to the original settings, select [NORMAL].

- 4 Press [🗑️/↵] a few times to exit the menu.

■ Auto Registration

When [AUTO REGISTRATION] is set to [ON], the registration screen will display automatically after taking a picture of a face that has a high number of appearances.

- Registration screen is displayed after approximately 3 pictures.
- It may be extremely hard to recognize only with [AUTO REGISTRATION], so register the face images with [FACE RECOG.] in the [REC] Mode menu beforehand.

■ Registering from the automatic registration screen

1 Press **▲** to select [YES] and then press [MENU/SET].

- If there are no registered persons, proceed to step 3.
- Selection screen is displayed again when [NO] is selected, and when [YES] is selected with **▲**, [AUTO REGISTRATION] will be set to [OFF].

2 Press **▲/▼** to select [NEW PERSON] or [ADDITIONAL IMAGE] and then press [MENU/SET].

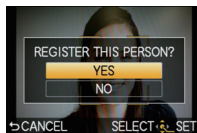

Item	Description of settings
[NEW PERSON]	• A list of registered people is displayed when there are 6 people already registered. Select the person to be replaced.
[ADDITIONAL IMAGE]	To additionally register a face image for a registered person. Press ▲/▼/◀/▶ to select the person to whom you wish add the picture, and then press [MENU/SET]. • If 3 images have already been registered, the picture replacement screen will appear. In this case, select the picture you wish to replace.

- After additionally registering or changing a face image, the screen returns automatically to the recording screen.

3 Perform the operation in Step 6 and following in “Registering face image of new person”.

Note

- If the registration screen will not display, it may display easier by recording in the same conditions or with the same expressions.
- If a face is not recognized even though it is registered, it will make the recognition easier by registering the person again using the [FACE RECOG.] in the [REC] Mode menu in that environment.
- If the registration screen is displayed for a person that is already registered, it will make the recognition easier by additionally registering.
- It may make recognition harder when a picture recorded with flash is registered.

[REC] Mode: **PA** **SM** **SCN** **C**

Useful Functions at Travel Destinations

Recording which Day of the Vacation You Take the Picture

For details on the [SETUP] menu settings, refer to [P56](#).

If you set the departure date or the travel destination of the vacation in advance, the number of days that have passed since the departure date (which day of the vacation it is) is recorded when you take the picture. You can display the number of days that have passed when playing back the pictures and stamp it on the recorded pictures with [TEXT STAMP] ([P153](#)).

- The number of days that have passed since the departure date can be printed out using the "PHOTOfunSTUDIO 6.0 HD Edition" bundled software on the CD-ROM (supplied).
- Select [CLOCK SET] to set the current date and time in advance. ([P28](#))

- 1 Select [TRAVEL DATE] from the [SETUP] menu, and then press [MENU/SET].
- 2 Press **▲** to select [TRAVEL SETUP] and then press [MENU/SET].
- 3 Press **▼** to select [SET] and then press [MENU/SET].
- 4 Press **▲/▼/◀/▶** to set the departure date (year/month/day), and then press [MENU/SET].

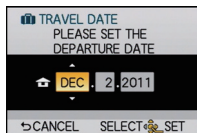

- 5 Press **▲/▼/◀/▶** to set the return date (year/month/day), and then press [MENU/SET].
 - If you do not want to set the return date, press [MENU/SET] while the date bar is displayed.

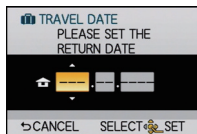

- 6 Press **▼** to select [LOCATION] and then press [MENU/SET].
- 7 Press **▼** to select [SET] and then press [MENU/SET].
- 8 Enter the location.
 - For details on how to enter characters, refer to "Entering Text" on [P128](#).
- 9 Press [**⏏**/**↵**] twice to close the menu.
 - The number of days that have passed since the departure date is displayed for about 5 seconds if this unit is turned on etc. after setting the travel date or when the travel date is set.

■ Canceling the travel date

The travel date is automatically canceled if the current date is after the return date. If you want to cancel the travel date before the end of the vacation, select [OFF] on the screen shown in step **3** and then press [/☞] twice. If the [TRAVEL SETUP] is set to [OFF], [LOCATION] will also be set to [OFF].

Note

- The travel date is calculated using the date in the clock setting and the departure date you set. If you set [WORLD TIME] (P127) to the travel destination, the travel date is calculated using the date in the clock setting and the travel destination setting.
- The travel date setting is memorized even if the camera is turned off.
- In order to record the number of days that have passed since your departure, the [TRAVEL DATE] must be set to [SET]. Which day of the vacation you took them is not displayed.
- If you set a departure date and then take a picture on a date before this departure date, [-] (minus) is displayed in orange and the day of the vacation that you took the picture is not recorded.
- If the travel date is displayed as [-] (minus) in white, there is a time difference that involves date change between the [HOME] and [DESTINATION]. (It will be recorded)
- The [TRAVEL DATE] feature is disabled when recording [AVCHD] motion pictures.
- While recording motion pictures, the [LOCATION] feature is disabled.
- When Intelligent Auto Mode is selected, the [TRAVEL DATE] feature is disabled. Setting of other Recording Mode will be reflected.

Recording Dates/Times at Overseas Travel Destinations (World Time)

For details on the [SETUP] menu settings, refer to P56.

You can display the local times at the travel destinations and record them on the pictures you take.

• Select [CLOCK SET] to set the current date and time in advance. (P60)

1 Select [WORLD TIME] from the [SETUP] menu, and then press [MENU/SET].

- When first using the camera after purchasing it, the [PLEASE SET THE HOME AREA] message appears. Press [MENU/SET], and set the home area on the screen in step **3**.

2 Press ▼ to select [HOME], and then press [MENU/SET].

3 Press ◀/▶ to select the home area, and then press [MENU/SET].

- (A) Current time
- (B) Time difference from GMT (Greenwich Mean Time)
- If daylight saving time [☀/🌙] is used at the home area, press ▲. Press ▲ again to return to the original time.
- The daylight saving time setting only applies to your "home area".

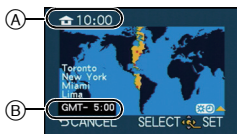

4 Press ▲ to select [DESTINATION] and then press [MENU/SET] to set.

- (C) Depending on the setting, the time at the travel destination area or the home area is displayed.

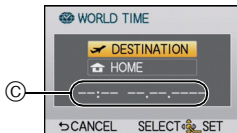

5 Press ◀/▶ to select the area the travel destination is in and then press [MENU/SET] to set.

- (D) Current time of the destination area
- (E) Time difference
- If daylight saving time [☀/🌙] is used at the travel destination, press ▲. (The time advances by one hour.) Press ▲ again to return to the original time.

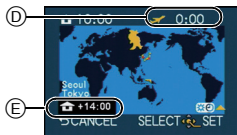

Note

- Return the setting to [HOME] when the vacation is finished by performing steps **1**, **2** and **3**.
- If [HOME] is already set, change only the travel destination, and use.
- If you cannot find the travel destination in the areas displayed on the screen, set by the time difference from the home area.

Entering Text

It is possible to enter babies' and pets' names and the names of travel destinations when recording. (Only alphabetical characters and symbols can be entered.)

1 Display the entry screen.

- You can display the entry screen via the following operations.
 - [NAME] of [BABY1]/[BABY2] or [PET] (P112) in Scene Mode.
 - [NAME] in [FACE RECOG.] (P122)
 - [LOCATION] in [TRAVEL DATE] (P125)
 - [TITLE EDIT] (P152)

2 Press ▲/▼/◀/▶ to select text and then press [MENU/SET] to register.

- The following operations can be performed by selecting the item and pressing [MENU/SET]:
 - []: Enter a blank
 - [A/a]: Text between [A] (capitals), [a] (small case), [1] (numbers) and [&] (special characters).
 - [DELETE]: Delete a character
 - [◀]: Move the entry position cursor to the left
 - [▶]: Move the entry position cursor to the right
- The entry position cursor can be moved left and right with the rear dial.
- A maximum of 30 characters can be entered. (Maximum of 9 characters when setting names in [FACE RECOG.]



3 Press ▲/▼/◀/▶ to move the cursor to [SET] and then press [MENU/SET] to end text input.

- Display will return to the appropriate setting screen.

Note

- Text can be scrolled if all of the entered text does not fit on the screen.
- [NAME] of [BABY1]/[BABY2] or [PET] can also be entered by touch operation.

Using the [REC] Mode Menu

For details on [REC] Mode menu settings, refer to P56.

- [FOCUS MODE], [METERING MODE], [I.DYNAMIC], [EX. TELE CONV.], and [DIGITAL ZOOM] are common to both the [REC] Mode menu and [MOTION PICTURE] Mode menu. Changing these settings in one of these menus is reflected in other menu.

[ASPECT RATIO]

This allows you to select the aspect ratio of the pictures to suit printing or the playback method.

Applicable modes: **[iA]** **[P]** **[ASM]** **[SCN]** **[C]**

[4:3]: [ASPECT RATIO] of a 4:3 TV

[3:2]: [ASPECT RATIO] of a 35 mm film camera

[16:9]: [ASPECT RATIO] of a high-definition TV, etc.

[1:1]: Square aspect ratio

[4:3]

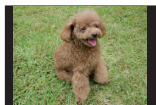

[3:2]



[16:9]

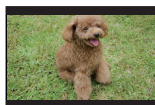

[1:1]

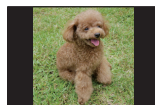

Note

- The ends of the recorded pictures may be cut at printing so check before printing. (P215)

[PICTURE SIZE]

Set the number of pixels. The higher the numbers of pixels, the finer the detail of the pictures will appear even when they are printed onto large sheets.

Applicable modes: **iA PASM**  **SCN C**

■ When the aspect ratio is [**4:3**].

L (12M)	4000×3000 pixels
EX M (6M)	2816×2112 pixels
EX S (3M)	2048×1536 pixels

■ When the aspect ratio is [**3:2**].

L (10.5M)	4000×2672 pixels
EX M (5M)	2816×1880 pixels
EX S (2.5M)	2048×1360 pixels

■ When the aspect ratio is [**16:9**].

L (9M)	4000×2248 pixels
EX M (4.5M)	2816×1584 pixels
EX S (2M)	1920×1080 pixels

■ When the aspect ratio is [**1:1**].

L (9M)	2992×2992 pixels
EX M (4.5M)	2112×2112 pixels
EX S (2M)	1504×1504 pixels

 **Note**



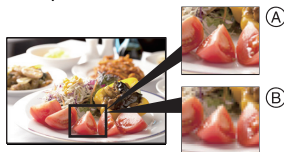

- If you set [EX. TELE CONV.] (P69) to [ON], [**EX**] is displayed on the screen when the picture size is set to a size other than the maximum picture size for each aspect ratio.
- A digital picture is made of numerous dots called pixels. The higher the numbers of pixels, the finer the picture will be when it is printed on a large piece of paper or displayed on a PC monitor.
 - (A) Many pixels (Fine)
 - (B) Few pixels (Rough)
 - * These pictures are examples to show the effect.
- If you change the aspect ratio, set the picture size again.
- Refer to P27 for information about the number of recordable pictures.



[QUALITY]

Set the compression rate at which the pictures are to be stored.



Applicable modes:      

- : Fine (when giving priority to the picture quality)
- : Standard (when using the standard picture quality and increasing the number of pictures to be recorded without changing the number of pixels)
- [RAW]**: RAW+Fine (In addition to the [RAW] settings, a fine-equivalent JPEG image is simultaneously created.)*¹
- [RAW]**: RAW+Standard (In addition to the [RAW] settings, a standard-equivalent JPEG image is simultaneously created.)*¹
- [RAW]**: RAW file (When the image is to be edited with a PC in high quality)*²

*1 If you delete a RAW file from the camera, the corresponding JPEG image will also be deleted.

*2 It is fixed to maximum recordable pixels ([L]) for each image aspect ratio.

 **Note**

- Refer to [P27](#) for information about the number of recordable pictures.
- You can enjoy more advanced picture editing if you use RAW files. You can save RAW files in a file format (JPEG, TIFF etc.) that can be displayed on your PC etc., develop them and edit them using the software "SILKYPIX Developer Studio" by Ichikawa Soft Laboratory on the CD-ROM (supplied).
- The following effects are not reflected in RAW images:
 - [RED-EYE REMOVAL], [I.RESOLUTION], [I.DYNAMIC], [PICTURE ADJUST] and [COLOR SPACE] in [REC] Mode Menu
 - Scene Mode
 - My Color Mode
- [RAW] images are recorded with a smaller data volume than [RAW] or [RAW].
- When the [QUALITY] is set to [RAW], the [PRINT SET] and [FAVORITE] features are disabled.

[FACE RECOG.]

[OFF]/[ON]/[MEMORY]/[SET]

 **Note**

- Refer to [P119](#) for details.

[FOCUS MODE]

Applicable modes: **iA PASM**  **SCN C**

[AFS]/[AFC]/[MF]

- Refer to [P32](#) for details.

[QUICK AF]

As long as the camera is held steady, the camera will automatically adjust the focus and focus adjustment will then be quicker when the shutter is pressed. This is useful when you do not want to miss a picture-taking opportunity.

Applicable modes: **PASM**  **SCN C**

[OFF]/[ON]

**Note**

- The battery will be consumed faster than usual.
- Press the shutter button halfway again when it is difficult to focus on the subject.
- The [QUICK AF] feature is disabled in the following conditions:
 - In Preview Mode
 - In low light situations
 - With lenses that only offer Manual Focus.
 - With some Four Third lenses that do not support contrast AF.

[METERING MODE]

Type of optical measurement to measure brightness can be changed.

Applicable modes: **P A S M *AV* C**

[]: Multiple

This is the method in which the camera measures the most suitable exposure by judging the allocation of brightness on the whole screen automatically. Usually, we recommend using this method.

[]: Center weighted



This is the method used to focus on the subject on the center of the screen and measure the whole screen evenly.

[]: Spot

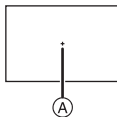
This is the method to measure the subject in the spot metering target (A).



 **Note**

- When the AF Mode is set to [] while [] is selected, exposure is adjusted to the face of a person, and when it is set to [], exposure is adjusted to the locked subject.

[FLASH]

[A]/[A[Ⓢ]]/[]/[[Ⓢ]]/[S]/[S[Ⓢ]] **Note**

- Refer to [P71](#) for details.

[RED-EYE REMOVAL]

[OFF]/[ON]

 **Note**

- Refer to [P73](#) for details.

[I.RESOLUTION]

Pictures with sharp profile and resolution can be taken by utilising the Intelligent Resolution Technology.

Applicable modes: PASM[Ⓢ]C

[OFF]/[LOW]/[STANDARD]/[HIGH]/[EXTENDED]

 **Note**

- [EXTENDED] allows you to take natural pictures with a higher resolution.
- The speed of burst and continuous recording becomes slower when [EXTENDED] is used.
- [EXTENDED] does not work during motion picture recording.

[I.DYNAMIC] (Intelligent dynamic range control)

Contrast and exposure will be adjusted automatically when there is a big difference in brightness between the background and subject, to bring the image close to how you see.

Applicable modes: **P A S M**  **C**

[OFF]/[LOW]/[STANDARD]/[HIGH]

 **Note**

- This feature may be automatically disabled, depending on the lighting conditions.
- **[i]** in the screen turns to yellow when [I.DYNAMIC] is in effect.
- [LOW], [STANDARD], or [HIGH] represents the maximum range of effect.

[ISO LIMIT SET]

It will select optimal ISO sensitivity with set value as limit depending on the brightness of the subject.

Applicable modes: **P A S C**

[OFF]/[200]/[400]/[800]/[1600]

 **Note**

- The upper limit of the ISO sensitivity can be set.
- The higher the value set for the ISO sensitivity, the more the jitter is reduced but the greater the amount of picture noise.
- It will work when the [SENSITIVITY] is set to [AUTO] or **[i]**ISO.

[ISO INCREMENTS]

ISO sensitivity settings between [ISO100] and [ISO6400] are changed for every 1/3 EV.

Applicable modes: **P A S M**  **SCN** **C**

[1/3 EV]: [100]/[125]/[160]/[200]/[250]/[320]/[400]/[500]/[640]/[800]/[1000]/[1250]/[1600]/[2000]/[2500]/[3200]/[4000]/[5000]/[6400]

[1 EV]: [100]/[200]/[400]/[800]/[1600]/[3200]/[6400]

 **Note**

- When the setting is changed from [1/3 EV] to [1 EV], ISO sensitivity will be set to value closest to the value set during the [1/3 EV]. (Set value will not restore when the setting is changed back to [1/3 EV]. It will stay as the setting selected for [1 EV].)

[LONG SHTR NR]

The camera automatically removes noise that appears when the shutter speed becomes slower to take pictures of night scenery etc. so you can take beautiful pictures.

Applicable modes: **P A S M**  **SCN C**

[OFF]/[ON]

 **Note**

- If you set [ON], the countdown screen is displayed when the shutter button is pressed. Do not move the camera at this time. After the countdown is finished, [PLEASE WAIT...] is displayed for the same time as the selected shutter speed for signal processing.
- We recommend using a tripod when the shutter speed is slowed to take pictures.
- [LONG SHTR NR] is disabled during motion picture recording.

[EX. TELE CONV.]

[OFF]/[ON]

 **Note**

- Refer to [P69](#) for details.

[DIGITAL ZOOM]

[OFF]/[2×]/[4×]

 **Note**

- Refer to [P69](#) for details.

[BURST RATE]

[H]/[M]/[L]

 **Note**

- Refer to [P79](#) for details.

[AUTO BRACKET]

[ / ] SETTINGS]/[STEP]/[SEQUENCE]

 **Note**

- Refer to [P81](#) for details.

[SELF-TIMER]

[] / [] / []

**Note**

- Refer to P83 for details.

[PICTURE ADJUST]

Adjusting the picture quality for the recorded pictures.

Applicable modes:

- 1 Press / to select [COLOR] or [B/W].
- 2 Press / to select the items, and then press / to adjust.

Item		Effect
[CONTRAST]	[+]	Increases the difference between the brightness and the darkness in the picture.
	[-]	Decreases the difference between the brightness and the darkness in the picture.
[SHARPNESS]	[+]	The picture is sharply defined.
	[-]	The picture is softly focused.
[SATURATION]	[+]	The colors in the picture become vivid.
	[-]	The colors in the picture become natural.
[NOISE REDUCTION]	[+]	The noise reduction effect is enhanced. Picture resolution may deteriorate slightly.
	[-]	The noise reduction effect is reduced. You can obtain pictures with higher resolution.

- If you adjust the picture quality, [+] is displayed beside the picture quality adjustment icon on the screen.
- [SATURATION] cannot be adjusted when [B/W] is selected.
- Picture quality cannot be adjusted in the Intelligent Auto Mode and the Scene Mode.

- 3 Press [MENU/SET].

**Note**

- Noise may become visible when you take pictures in dark places. To avoid picture noise, we recommend setting [NOISE REDUCTION] towards [+] or setting the items except [NOISE REDUCTION] towards [-] to take pictures.

[COLOR SPACE]

Set this when you want to correct the color reproduction of the recorded pictures on a PC, printer etc.

Applicable modes: **P A S M  SCN C**

[sRGB]: Color space is set to sRGB color space.
This is widely used in computer related equipment.

[AdobeRGB]: Color space is set to AdobeRGB color space.
AdobeRGB is mainly used for business purposes such as professional printing because it has a greater range of reproducible colors than sRGB.

 **Note**

- Depending on the color space setting, the file name of the recorded picture changes as shown.

P1000001.JPG

└─┬─ P: sRGB
└─┬─ _: AdobeRGB

- Set to sRGB if you are not very familiar with AdobeRGB.
- The setting is fixed to [sRGB] when recording motion pictures.

[STABILIZER]

[OFF]/[MODE1]/[MODE2]/[MODE3]

 **Note**

- Refer to [P76](#) for details.

Using the [MOTION PICTURE] Mode Menu

For details on [MOTION PICTURE] Mode menu settings, refer to P56.

- [FOCUS MODE], [METERING MODE], [I.DYNAMIC], [EX. TELE CONV.], and [DIGITAL ZOOM] are common to both the [REC] Mode menu and [MOTION PICTURE] Mode menu. Changing these settings in one of these menus is reflected in other menu.
 - For details, refer to the explanation for the corresponding setting in [REC] Mode menu.

[REC MODE]

This sets up the data format of motion pictures.

Applicable modes:  **P** **A** **S** **M**  **C**

 [AVCHD(1080i)]/[ [AVCHD(720p)]]

- Select this format to record HD (high-definition) video for playback on your HDTV using an HDMI connection.
- It can be played back as is by inserting the card into a device compatible with AVCHD. Refer to the instructions of the device used for details on compatibility.
- Use a card with SD Speed Class with "Class 4" or higher.
- [AVCHD(1080i)] can record motion pictures with even higher definition and picture quality than [AVCHD(720p)].

 [MOTION JPEG]

- Select this format to record standard definition video for playback on your PC. It can be recorded using less storage when there is not much space left on the memory card or when you want to attach the motion picture to an e-mail.
- Use a card with SD Speed Class with "Class 6" or higher.

[REC QUALITY]

This sets up the picture quality of motion pictures.

Applicable modes: **IA PASM SCN C**

When [AVCHD(1080i)] is selected

Item	Quality (bit rate) ^{*1}	fps	Aspect ratio
[FSH]	1920×1080 pixels Approx. 17 Mbps ^{*2}	60i (Sensor output is 30 fps)	16:9
[FH]	1920×1080 pixels Approx. 13 Mbps ^{*2}		

When [AVCHD(720p)] is selected

Item	Quality (bit rate) ^{*1}	fps	Aspect ratio
[SH]	1280×720 pixels Approx. 17 Mbps ^{*2}	60p (Sensor output is 30 fps)	16:9
[H]	1280×720 pixels Approx. 13 Mbps ^{*2}		

*1 What is bit rate

This is the volume of data for definite period of time, and the quality becomes higher when the number gets bigger. This unit is using the "VBR" recording method. "VBR" is an abbreviation of "Variable Bit Rate", and the bit rate (volume of data for definite period of time) is changed automatically depending on the subject to record. Therefore, the recording time is shortened when a subject with fast movement is recorded.

*2 What is Mbps

This is an abbreviation of "Megabit Per Second", and it represents the speed of transmission.

When [MOTION JPEG] is selected

Item	Picture size	fps	Aspect ratio
[HD]	1280×720 pixels	30	16:9
[WVGA] ⁺³	848×480 pixels		
[VGA]	640×480 pixels		4:3
[QVGA]	320×240 pixels		

*3 This item cannot be set in the Intelligent Auto Mode.

- With the [AVCHD] or [HD] for [MOTION JPEG], high quality motion picture can be enjoyed on the TV by using the HDMI mini cable (optional). For details, see "Playing back on the TV with HDMI socket" on P171.

[CONTINUOUS AF]

[OFF]/[ON]

 **Note**

- Refer to [P43](#) for details.

[WIND CUT]

This reduces the wind noise in the audio recording.

Applicable modes: **iA PASM**  **SCN C**

[OFF]/[LOW]/[STANDARD]/[HIGH]

 **Note**

- Sound quality will be different than usual when [WIND CUT] is set.

[MIC LEVEL DISP.]

Set whether or not the mic levels are displayed on the screen.

Applicable modes: **PASM**  **SCN C**

[OFF]/[ON]

[MIC LEVEL ADJ.]

Adjust the sound input level to 4 different levels.

Applicable modes: **PASM**  **SCN C**

[LEVEL1] to [LEVEL4]

[FLICKER RED.]

The shutter speed can be fixed to reduce the flicker or striping in the motion picture.

Applicable modes: **PASMC**

[OFF]/[1/50]/[1/60]/[1/100]/[1/120]

 **Note**

- Shutter speed for recording a motion picture will be fixed to the selected shutter speed when settings other than [OFF] are selected.

Perform these settings if you need to.

Using the [CUSTOM] Menu

For details on how to select the [CUSTOM] menu settings, refer to [P56](#).

[CUST. SET MEM.]	[C1]/[C2]/[C3]
------------------	----------------

- Refer to [P118](#) for details.

[Q.MENU/Fn]	—
-------------	---



- Refer to [P11](#) for details.

[Fn BUTTON SET]	—
-----------------	---

- Refer to [P104](#) for details.

[HISTOGRAM]	[OFF]/[ON]
-------------	------------

- Refer to [P68](#) for details.

[GUIDE LINE]	[OFF]/[  
--------------	---

- Refer to [P67](#) for details.

[HIGHLIGHT]	When the Auto Review function is activated or when playing back, white saturated areas appear blinking in black and white.
	[OFF]/[ON]

- If there are any white saturated areas, we recommend compensating the exposure towards negative ([P78](#)) referring to the histogram ([P68](#)) and then taking the picture again. It may result in a better quality picture.

- There may be white saturated areas if the distance between the camera and the subject is too close when taking pictures with the flash.

If [HIGHLIGHT] is set to [ON] in this case, the area directly illuminated by the photo flash will become white saturated and appear blinking in black and white.

- This does not work while in Multi Playback ([P40](#)), Calendar Playback ([P41](#)), or Playback Zoom ([P42](#)).

[ON]

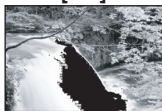

[OFF]



[EXPO.METER]	Select whether or not to display the exposure meter when the [REC] Mode is set to P/A/S/M etc.
	[OFF]/[ON]

- Set to [ON] to display the [EXPO.METER] when correcting exposure, performing program shift, setting aperture, and setting shutter speed.
- Unsuitable areas of the range are displayed in red.
- When [EXPO.METER] is not displayed, switch the display information for LCD monitor by touching **[DISP.]**. (P67)
- The [EXPO.METER] disappears after approximately 4 seconds if no operation is performed.



[AF/AE LOCK]	[AE]/[AF]/[AF/AE]
---------------------	--------------------------

- Refer to P105 for details.

[DIRECT FOCUS AREA]	[OFF]/[ON]
----------------------------	-------------------

- Refer to P90, 91 for details.

[FOCUS PRIORITY]	It will set so no picture can be taken when it is out of focus.
	<p>[OFF]: This gives priority to the best time to take a picture so you can take a picture when the shutter button is pressed fully.</p> <p>[ON]: You cannot take a picture until the subject is brought into focus.</p>

- It is recommended that this feature be left on, to minimize the possibility of pictures with poor focus.
- **[FOCUS PRIORITY]** is disabled during motion picture recording.

[AF ASSIST LAMP]	Illuminating the subject makes it easier for the camera to focus when recording in low light conditions that make focusing difficult.
	<p>[OFF]: The AF Assist Lamp does not turn on.</p> <p>[ON]: When taking pictures in dark places, the AF Assist Lamp lights while the shutter button is pressed halfway. (Larger AF areas are displayed depending on the recording conditions.)</p>

- The effective range of the AF Assist Lamp is different depending on used lens.
 - When the interchangeable lens (H-H014) is attached and at Approx. 1.0 m (3.28 feet) to 3.5 m (11.5 feet)
 - When the interchangeable lens (H-FS014042) is attached and at Wide: Approx. 1.0 m (3.28 feet) to 3.0 m (9.84 feet)
- The AF Assist Lamp is valid only for the subject in the center of the screen. Use it by positioning the subject in the center of the screen.
- Remove the lens hood.
- When you do not want to use the AF Assist Lamp (e.g. when taking pictures of animals in dark places), set the **[AF ASSIST LAMP]** to **[OFF]**. In this case, it will become more difficult to focus on the subject.
- The AF Assist Lamp gets slightly blocked when the interchangeable lens (H-FS014042) is used, but it does not affect the performance.
- The AF Assist Lamp may be greatly blocked, and it may become harder to focus when a lens with large diameter is used.
- The setting for the **[AF ASSIST LAMP]** is fixed to **[OFF]** in **[SCENERY]**, **[ARCHITECTURE]**, **[NIGHT SCENERY]** and **[SUNSET]** in Scene Mode.





[AF+MF]	It is possible to adjust focus manually after it was adjusted automatically.
	<p>[OFF]</p> <p>[ON]: It is possible to finely adjust the focus manually by rotating the focus ring while AF lock ([FOCUS MODE]) is set to [AFS] and shutter button is half-way pressed, or AF lock with [AF/AE LOCK].</p>

[MF ASSIST]	[OFF]/[ON]
-------------	------------



- Refer to P91 for details.

[MF GUIDE]	[OFF]/[ON]
------------	------------



- Refer to P91 for details.

[] BUTTON SWITCH]	It is possible to set how the [] button to toggle to Intelligent Auto Mode will operate.
	<p>[SINGLE PRESS]: It will switch to Intelligent Auto Mode by pressing [].</p> <p>[PRESS AND HOLD]: It will switch to Intelligent Auto Mode by pressing [] for a while.</p>

[] BUTTON]	Enables/disables the motion picture button.
	[OFF]/[ON]



[] REC AREA]	This changes the angle of view during motion picture recording and still picture recording.
	[] (Picture)/[] (Motion picture)



- The recording area indicated is a guide line.

[REMAINING DISP.]	This will switch display between the number of recordable pictures and available recording time.
	<p> [REMAINING SHOTS]: This will display the number of recordable pictures for still pictures.</p> <p> [REMAINING TIME]: This will display the available recording time for motion pictures.</p>







[PLAY ON LCD]	[OFF]/[ON]
---------------	------------

- Refer to P189 for details.

[TOUCH Q.MENU]	Enables/disables the  (Touch Quick Menu icon).
	<p>[OFF]:  is not displayed on the screen, and Quick Menu cannot be displayed by the touch operation.</p> <p>[ON]:  is displayed on the screen, and Quick Menu can be displayed by touch operation.</p>

[DEFOCUS CTRL]	Enables/disables the Touch Defocus Control function.
	<p>[OFF]:  is not displayed on the screen, and Defocus Control cannot be used.</p> <p>[ON]:  is displayed on the screen, and Defocus Control can be used when  is touched.</p>

- [DEFOCUS CTRL] cannot be selected when you use a lens that cannot utilize the Defocus Control function.

[TOUCH SHUTTER]	Enables/disables the Touch Shutter function.
	<p>[OFF]:  or  is not displayed on the screen, and Touch Shutter function cannot be used.</p> <p>[ON]:  or  is displayed on the screen and [ON]/[OFF] of the Touch Shutter function can be switched when  or  is touched.</p>

[TOUCH GUIDE]	When playing back the pictures, this allows you to set either to display or not display the guide screen of the touch panel.
	[OFF]/[ON]

[TOUCH SCROLL]	This allows you to set the speed of continuously forwarding or rewinding pictures using touch operation.
	[H]: High speed
	[L]: Low speed

[DIAL GUIDE]	Select whether or not to display the operation switch guide when the [REC] Mode is set to P/A/S/M etc.
	[OFF]/[ON]

- It will display dial operation guide to the screen that is possible to perform Exposure Compensation, Program Shift, aperture setting, or shutter speed setting when set to [ON].

Ⓐ Dial operation guide



[MENU RESUME]	The last operated menu position is saved even if the camera is turned off.
	[OFF]/[ON]

[PIXEL REFRESH]	It will perform optimization of imaging device and image processing.
------------------------	--

- Imaging device and image processing is optimized when the camera is purchased. Use this function when bright spots not in subject get recorded, and it is bothering you.
- Turn the camera off and on after the pixels are corrected.

[SENSOR CLEANING]	Dust reduction to blow off the debris and dust that have affixed to the front of the imaging device is performed.
--------------------------	---

- Dust reduction function will operate automatically when the camera is turned on, but you can use this function when you see dust. (P197)

[SHOOT W/O LENS]	It is possible to setup so the shutter will not operate when there is no lens on the unit.
	[OFF]: You cannot press the shutter button when a lens is not attached to the camera body or is not attached correctly.
	[ON]: Shutter will operate regardless of the lens on the unit.

- When using a Leica lens mount adaptor (DMW-MA2M, DMW-MA3R; optional), set it to [ON].

Creating Still Pictures from a Motion Picture

You can create a single still picture from a recorded motion picture.

- 1 Touch [] during Motion Picture playback by touch operation.

- Motion picture is paused.



- 2 Touch [].



- 3 Touch [YES].

- 4 Touch [] to finish.

Note

- It will be saved with [PICTURE SIZE] set to [S] (2 M), [ASPECT RATIO] set to [16:9], and [QUALITY] set to [..+].
- Still pictures created from a motion picture may be coarser than with normal picture quality.
- While recording [MOTION JPEG], using [VGA] and [QVGA], the ability to create still pictures is disabled.
- You may not be able to save still pictures from a motion picture taken on other equipment.
- [] is displayed during playback of still pictures created from motion pictures.

Using the [PLAYBACK] Mode Menu

You can use various functions in playback mode to rotate pictures, set protection for them etc.

- With [TEXT STAMP], [RESIZE], [CROPPING] or [ASPECT CONV.], a new edited picture is created. A new picture cannot be created if there is no free space on the card so we recommend checking that there is free space and then editing the picture.

[2D/3D SETTINGS]

Playback methods for the 3D pictures can be switched.

- This is a menu that is only displayed when 3D display is possible. Refer to [P167](#) for details.

[SLIDE SHOW]

You can play back the pictures you have taken in synchronisation with music, and you can do this in sequence while leaving a fixed interval between each of the pictures.

You can also put together a slide show composed of only still pictures, only motion pictures, only 3D pictures, only pictures of a particular category, or only favorites.

We recommend this feature when you view your pictures by connecting the camera to a TV.

1 Select [SLIDE SHOW] on the [PLAYBACK] Mode menu. (P56)

2 Press ▲/▼ to select the item and then press [MENU/SET].

- [FAVORITE] can be selected only when [FAVORITE] on the [PLAYBACK] Mode menu ([P160](#)) is at [ON] and there are pictures already set as favorites.
- During [CATEGORY SELECTION], press ▲/▼/◀/▶ to select a category, and then press [MENU/SET] to proceed to step **3**. For details on categories, refer to [P151](#).
- Refer to [P167](#) for the method to playback [3D] pictures in 3D.

3 Press ▲ to select [START] and then press [MENU/SET].

4 Press ▼ to finish the slide show.

- Normal Playback resumes after the slide show finishes.

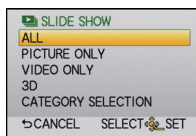

■ Operations performed during slide show

The cursor displayed during playback is the same as ▲/▼/◀/▶.

- The menu screen is restored when [⏏/↵] is pressed.
- When it is setup not to display the display information of the playback screen, the cursor can be displayed by pressing [MENU/SET] during playback of the slide show.

- (A) Play/Pause
- (B) Stop
- (C) Back to previous picture*
- (D) Ahead to next picture*

* These operations can be performed only in the Pause Mode or during motion picture playback.

- (E) Reduce volume level
- (F) Increase volume level

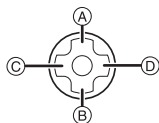

■ Changing the slide show settings

You can change the settings for slide show playback by selecting [EFFECT] or [SETUP] on the slide show menu screen.

[EFFECT]

This allows you to select the screen effects when switching from one picture to the next.

[NATURAL], [SLOW], [SWING], [URBAN], [OFF], [AUTO]

- When [URBAN] has been selected, the picture may appear in black and white as a screen effect.
- [AUTO] can be used only when [CATEGORY SELECTION] has been selected. The pictures are played back with the recommended effects in each category.
- [EFFECT] is set to [OFF] when playing a slide show with motion pictures only.
- While viewing pictures in Portrait Mode (vertical) some selections in the [EFFECT] feature are disabled.

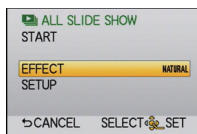

[SETUP]

[DURATION] or [REPEAT] can be set.

Item	Settings
[DURATION]	1SEC./2SEC./3SEC./5SEC.
[REPEAT]	OFF/ON
[SOUND]	<p>[OFF]: There will be no sound.</p> <p>[AUTO]: Music is played when the still pictures are played back, and audio is played when the motion pictures are played back.</p> <p>[MUSIC]: Music is played back.</p> <p>[AUDIO]: Audio (only for motion pictures) is played back.</p>

- [DURATION] can be set only when [OFF] has been selected as the [EFFECT] setting.

Note

- It is not possible to add new music.

[PLAYBACK MODE]

Playback in [NORMAL PLAY], [PICTURE PLAY], [AVCHD PLAY], [MOTION JPEG PLAY], [3D PLAY], [CATEGORY PLAY] or [FAVORITE PLAY] can be selected.

1 Select [PLAYBACK MODE] on the [PLAYBACK] Mode menu. (P56)

2 Press ▲/▼ to select the item and then press [MENU/SET].

- [FAVORITE PLAY] can be selected only when [FAVORITE] on the [PLAYBACK] Mode menu (P160) is at [ON] and there are pictures already set as favorites.
- Refer to P167 for the method to playback [3D PLAY] pictures in 3D.

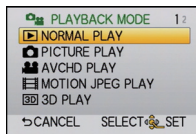

When [CATEGORY PLAY] is selected in above step 2

3 Press ▲/▼/◀/▶ to select the category and then press [MENU/SET] to set.

- If a picture is found in a category, the category icon turns blue.
- It may take time to search the picture files if there are a lot on the card.
- If you press [⏏/▶] while searching, the searching will stop halfway.
- Pictures are sorted into the categories shown below.

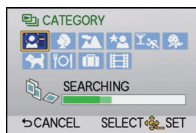

[CATEGORY]	Recording information e.g. Scene Modes
	[FACE RECOG.]*
	[PORTRAIT], [i-PORTRAIT], [SOFT SKIN], [NIGHT PORTRAIT], [i-NIGHT PORTRAIT], [BABY1]/[BABY2], [i-BABY]
	[SCENERY], [i-SCENERY], [ARCHITECTURE], [SUNSET],[i-SUNSET]
	[NIGHT PORTRAIT], [i-NIGHT PORTRAIT], [NIGHT SCENERY], [i-NIGHT SCENERY], [ILLUMINATIONS]

[CATEGORY]	Recording information e.g. Scene Modes
	[SPORTS], [PARTY]
	[BABY1]/[BABY2], [i-BABY]
	[PET]
	[FOOD]
	[TRAVEL DATE]
	Motion pictures

*Press ▲/▼/◀/▶ to select the person to playback and then press [MENU/SET].

Face Recognition may not be possible or may not recognize faces correctly even for registered faces, depending on the facial expression and environment.

Also, if there are multiple faces that are already registered in the picture, it will be categorized only once to the person found first in the registration.

[TITLE EDIT]

You can add text (comments) to pictures. After text has been registered, it can be stamped in prints using [TEXT STAMP] (P153). (Only alphabetic characters and symbols can be entered.)

- 1 Select [TITLE EDIT] on the [PLAYBACK] Mode menu. (P56)
- 2 Press ▲/▼ to select [SINGLE] or [MULTI] and then press [MENU/SET].

- 3 Select the picture, and then press [MENU/SET] to set.

- [✔] is displayed for pictures with titles already registered.

[MULTI] setting

Select the picture with ▲/▼/◀/▶ and set (repeat) by pressing [MENU/SET], then press ◀ a few times to select [OK], and execute by pressing [MENU/SET].

- The setting is canceled when [MENU/SET] is pressed again.

- 4 Enter the text. (P128)

- Press [⏮]/[⏭] to return to the menu screen. (The menu screen is automatically restored when [MULTI] is selected.)

[SINGLE]



Press ◀/▶ to select the picture.

[MULTI]

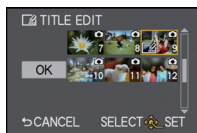

Press ▲/▼/◀/▶ to select the pictures.

Note

- To delete the title, erase all the text in the text input screen.
- Text can be scrolled if all of the registered text does not fit on the screen.
- You can print out texts (comments) using the "PHOTOfunSTUDIO 6.0 HD Edition" bundled software on the CD-ROM (supplied).
- You can set up to 100 pictures at one time with [MULTI].
- Title editing is disabled during the following conditions:
 - Motion pictures
 - Pictures taken with [RAW+], [RAW+.] or [RAW]
 - Pictures recorded with other equipment

[TEXT STAMP]

You can stamp the recording date/time, name, location, travel date or title onto the recorded pictures.

It is suitable for regular size printing. (Pictures with a picture size larger than [S] will be resized when stamping the date etc. on them.)

- 1 Select [TEXT STAMP] on the [PLAYBACK] Mode menu. (P56)
- 2 Press ▲/▼ to select [SINGLE] or [MULTI] and then press [MENU/SET].

- 3 Select the picture, and then press [MENU/SET] to set.

- [☑] appears on screen if the picture is stamped with text.

[MULTI] setting

Select the picture with ▲/▼/◀/▶ and set (repeat) by pressing [MENU/SET], then press ◀ a few times to select [OK], and execute by pressing [MENU/SET].

- The setting is canceled when [MENU/SET] is pressed again.

- 4 Press ▲/▼ to select [SET], and then press [MENU/SET].

[SINGLE]



Press ◀/▶ to select the picture.

[MULTI]

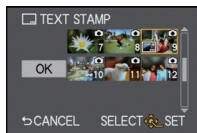

Press ▲/▼/◀/▶ to select the pictures.

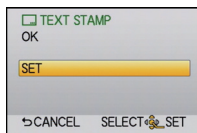

- 5 Press ▲/▼ to select text stamp items, and then press [MENU/SET].

6 Press ▲/▼ to select the settings, and then press [MENU/SET].

Item	Setting item
[SHOOTING DATE]	[OFF] [W/OTIME]: Stamp the year, month and date. [WITHTIME]: Stamp the year, month, day, hour and minutes.
[NAME]	[OFF] []: Name registered in Face Recognition will be stamped. []: Stamps names on pictures that already have registered name settings of [BABY1]/[BABY2] or [PET] in Scene Mode.
[LOCATION]	[OFF] [ON]: Stamps the travel destination name set under [LOCATION].
[TRAVEL DATE]	[OFF] [ON]: Stamps the travel date set under [TRAVEL DATE].
[TITLE]	[OFF] [ON]: Title input in the [TITLE EDIT] will be stamped.

7 Press [/▶] to return to the screen shown in step 4.**8 Press ▲/▼ to select [OK], and then press [MENU/SET].**

- When selecting [] or [], press ▲ to select [YES] for stamping [AGE], and then press [MENU/SET] and proceed to step 9.

9 Press ▲ to select [YES] and then press [MENU/SET].

- Press [/▶] to return to the menu screen. (The menu screen is automatically restored when [MULTI] is selected.)

Note

- When you print pictures stamped with text, the date will be printed over the stamped text if you specify printing of the date at the photo shop or on the printer.
- You can set up to 100 pictures at one time in [MULTI].
- The picture quality may deteriorate when text stamping is carried out.
- Depending on the printer being used, some characters may be cut at printing. Check before printing.
- The [TEXT STAMP] feature is disabled during the following conditions:
 - Motion pictures
 - Pictures recorded without setting the clock and title
 - Pictures that were previously stamped with [TEXT STAMP]
 - Pictures taken with [RAW], [RAW] or [RAW]
 - Pictures recorded with other equipment

[VIDEO DIVIDE]

Recorded motion picture can be divided in two. It is recommended for when you want to divide a part you need with a part you do not need.

Dividing a motion picture is permanent. Decide before you divide!

- 1 Select [VIDEO DIVIDE] on the [PLAYBACK] Mode menu. (P56)**
- 2 Press ◀▶ to select the motion picture to divide, and then press [MENU/SET].**
 - Motion picture is played back.
- 3 Press ▲ at the location to divide.**
 - Motion picture is paused.
Motion picture is played back from the same location when ▲ is pressed again.
 - You can finely adjust the location for division by pressing ◀▶ while the motion picture is paused.
- 4 Press ▼.**
- 5 Press ◀ to select [YES] and then press [MENU/SET].**
 - Motion picture may be lost if the card or battery is removed while processing the dividing.
 - Press [⏏/▶] to return to the menu screen.



 **Note**

- Avoid trying to divide motion picture near the very beginning or end of the motion picture.
- The [VIDEO DIVIDE] feature only works on motion pictures recorded on this camera.
- With [MOTION JPEG] motion pictures, the order of pictures will change if divided.
It is recommended to display these motion pictures by using Calendar Playback (P41) or [MOTION JPEG PLAY] in the [PLAYBACK MODE] (P151).
- With [AVCHD] motion pictures, the order of pictures will not change.
- The [VIDEO DIVIDE] feature will be disabled during the following conditions:
 - Motion pictures with a short recording time

[RESIZE] Reducing the picture size (number of pixels)

To allow easy posting to web pages, attachment to e-mail etc., picture size (number of pixels) is reduced.

- 1 Select **[RESIZE]** on the **[PLAYBACK]** Mode menu. (P56)
- 2 Press **▲/▼** to select **[SINGLE]** or **[MULTI]** and then press **[MENU/SET]**.

3 Select the picture and size.

[SINGLE] setting

① Press **◀/▶** to select the picture, and then press **[MENU/SET]**.

② Press **◀/▶** to select the size*, and then press **[MENU/SET]**.

* Only the sizes to which the pictures can be resized is displayed.

[MULTI] setting

① Press **▲/▼** to select the size, and then press **[MENU/SET]**.

② Select the picture with **▲/▼/◀/▶** and set (repeat) by pressing **[MENU/SET]**, then press **◀** a few times to select **[OK]**, and execute by pressing **[MENU/SET]**.

[SINGLE]

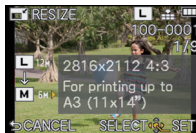
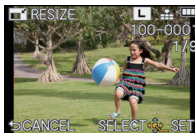

[MULTI]



4 Press **▲** to select **[YES]** and then press **[MENU/SET]**.

- Press **[⏪/⏩]** to return to the menu screen. (The menu screen is automatically restored when **[MULTI]** is selected.)

Note

- You can set up to 100 pictures at one time in **[MULTI]**.
- The picture quality of the resized picture will deteriorate.
- It may not be possible to resize pictures recorded with other equipment.
- The **[RESIZE]** feature is disabled during the following conditions:
 - Motion pictures
 - Pictures stamped with **[TEXT STAMP]**
 - Pictures taken with **[RAW]**, **[RAW]** or **[RAW]**

[CROPPING]

You can enlarge and then clip the important part of the recorded picture.

- 1** Select **[CROPPING]** on the **[PLAYBACK]** Mode menu. (P56)
- 2** Press **◀/▶** to select the picture, and then press **[MENU/SET]**.
- 3** Use the rear dial and press **▲/▼/◀/▶** to select the parts to be cropped.



Rear dial (right): Enlargement

Rear dial (left): Reduction

▲/▼/◀/▶: Move

- 4** Press **[MENU/SET]**.
- 5** Press **▲** to select **[YES]** and then press **[MENU/SET]**.
 - Press **[🗑️/↩️]** to return to the menu screen.

 **Note**

- Depending on the cut size, the picture size of the cropped picture may become smaller than that of the original picture.
- The picture quality of the cropped picture will deteriorate.
- It may not be possible to crop pictures recorded with other equipment.
- The **[CROPPING]** feature is disabled during the following conditions:
 - Motion pictures
 - Pictures stamped with **[TEXT STAMP]**
 - Pictures taken with **[RAW⁺]**, **[RAW₊]** or **[RAW]**
- Information regarding the Face Recognition in the original picture will not be copied to images having undergone **[CROPPING]**.

[ASPECT CONV.]

You can convert pictures taken with a [16:9] aspect ratio to a [3:2], a [4:3] or a [1:1] aspect ratio.

- 1 Select [ASPECT CONV.] on the [PLAYBACK] Mode menu. (P56)
- 2 Press ▲/▼ to select [3:2], [4:3] or [1:1] and then press [MENU/SET].
- 3 Press ◀/▶ to select a picture taken with [16:9] aspect ratio, and then press [MENU/SET].
- 4 Press ◀/▶ to determine the horizontal position, and press [MENU/SET] to set.
 - Use ▲/▼ to set the frame position for pictures rotated vertically.
- 5 Press ▲ to select [YES] and then press [MENU/SET].
 - Press [🗑️/↩️] to return to the menu screen.

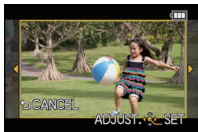

 **Note**

- After converting the aspect ratio, the picture size may become larger than that of the original picture.
- You may not be able to convert pictures taken on other equipment.
- The [ASPECT CONV.] feature is disabled during the following conditions:
 - Motion pictures
 - Pictures stamped with [TEXT STAMP]
 - Pictures taken with [RAW📷], [RAW📷] or [RAW]
- Information regarding the face recognition in the original picture will not be copied to images having undergone [ASPECT CONV.].

[ROTATE]/[ROTATE DISP.]

This mode allows you to automatically display pictures vertically if they were recorded holding the camera vertically or rotate pictures manually in 90° steps.

Rotate (The picture is rotated manually)

- 1 Select **[ROTATE]** on the **[PLAYBACK] Mode menu. (P56)**
 - The **[ROTATE]** function is disabled when **[ROTATE DISP.]** is set to **[OFF]**.
- 2 Press **◀/▶** to select the picture and then press **[MENU/SET]**.
- 3 Press **▲/▼** to select the direction to rotate the picture and then press **[MENU/SET]**.

: The picture rotates clockwise in steps of 90°.

: The picture rotates counter-clockwise in steps of 90°.

- Press **[🗑️/↶]** to return to the menu screen.

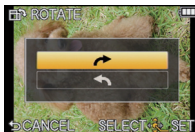

Rotate display (The picture is automatically rotated and displayed)

- 1 Select **[ROTATE DISP.]** on the **[PLAYBACK] Mode menu. (P56)**
- 2 Press **▼** to select **[ON]** and then press **[MENU/SET]**.
 - The pictures are displayed without being rotated when you select **[OFF]**.

 **Note**

- **[ROTATE DISP.]** can only be used with the lens **(P12)** compatible with the Direction Detection Function **(P35)**.
- When you play back pictures on a PC, they cannot be displayed in the rotated direction unless the OS or software is compatible with Exif. Exif is a file format for still pictures which allows recording information etc. to be added. It was established by "JEITA (Japan Electronics and Information Technology Industries Association)".
- It may not be possible to rotate pictures that have been recorded with other equipment.
- During Multi Playback **(P40)** the display rotation feature is disabled.
- Rotation correction is limited to 90 degrees – from horizontal to vertical or vice-versa.

[FAVORITE]

You can do the following if a mark has been added to pictures and they have been set as favorites.

- Play back the pictures set as favorites only as a slide show.
- Play back only the pictures set as favorites. ([FAVORITE PLAY])
- Delete all the pictures not set as favorites. ([ALL DELETE EXCEPT★])

1 Select [FAVORITE] on the [PLAYBACK] Mode menu. (P56)

2 Press ▼ to select [ON] and then press [MENU/SET].

- You cannot set pictures as favorites if [FAVORITE] is set to [OFF]. Also [★] will not appear when [FAVORITE] is set to [OFF] even if it was previously set to [ON].
- When [CANCEL] is selected, see “Canceling all the [FAVORITE] settings”.

3 Press [⏏/↵] to close the menu.

4 Press ◀/▶ to select the picture and then touch [★] to set it during playback.

- [★] is displayed on pictures that are already registered as favorites.
- Repeat the above procedure.
- If [★] is touched again, the favorite setting is canceled.
- You can also set/cancel favorites by pressing ▼.



■ **Canceling all the [FAVORITE] settings**

1 Select [CANCEL] on the screen shown in step 2 and then press [MENU/SET].

2 Press ▲ to select [YES] and then press [MENU/SET].

- At least one picture must be designated as [FAVORITE], otherwise the [CANCEL] feature will be disabled.
- In [PLAYBACK MODE] the [CANCEL] Mode is disabled.



Note

- You can set up to 999 pictures as favorites.
- When printing pictures at a photo printing store, [ALL DELETE EXCEPT★] (P54) is useful so only the pictures you want to be printed remain on the card.
- You may not be able to set pictures taken with other equipment as favorites.
- The [FAVORITE] feature is disabled for pictures taken with the [QUALITY] set to [RAW].

[PRINT SET]

DPOF "Digital Print Order Format" is a system that allows the user to select which pictures to print, how many copies of each picture to print and whether or not to print the recording date on the pictures when using a DPOF compatible photo printer or photo printing store.

For details, ask at your photo printing store.
For more information visit:
http://panasonic.jp/dc/dpof_110/white_e.htm

- 1 Select [PRINT SET] on the [PLAYBACK] Mode menu. (P56)
- 2 Press ▲/▼ to select [SINGLE] or [MULTI] and then press [MENU/SET].
 - When [CANCEL] is selected, see "Canceling all the [PRINT SET] settings".
- 3 Select the picture, and then press [MENU/SET].

[SINGLE]



[MULTI]

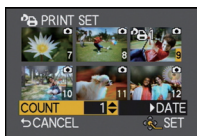

Press ◀/▶ to select the picture. Press ▲/▼/◀/▶ to select the pictures.

- 4 Press ▲/▼ to set the number of prints, and then press [MENU/SET] to set.
 - When [MULTI] has been selected
 - repeat steps 3 and 4 for each picture.
 - Press [⏪/⏩] to return to the menu screen.

■ Canceling all the [PRINT SET] settings

- 1 Select [CANCEL] on the screen shown in step 2 and then press [MENU/SET].
 - 2 Press ▲ to select [YES] and then press [MENU/SET].
- You cannot select [CANCEL] if not even one picture has been set for printing.

■ To print the date

After setting the number of prints, set/cancel printing with the recording date by pressing ►.

- When you go to a photo printing store for digital printing, be sure to order the printing of the date additionally if required.
- Depending on the photo printing store or the printer, the date may not be printed even if you set to print the date. For further information, ask at your photo printing store or refer to the operating instructions for the printer.
- The date print feature is disabled for pictures that are stamped with text.



Note

- The number of prints can be set from 0 to 999.
- With a printer supporting PictBridge, the date print settings of the printer may take precedence so check if this is the case.
- It may not be possible to use the print settings with other equipment. In this case, cancel all the settings, and reset the settings.
- If the file is not based on the DCF standard, the print setting cannot be set.
- The [PRINT SET] feature is disabled for motion pictures and pictures taken with the [QUALITY] set to [RAW].

[PROTECT]

You can set protection for pictures you do not want to be deleted by mistake.

- 1 Select [PROTECT] on the [PLAYBACK] Mode menu. (P56)
- 2 Press ▲/▼ to select [SINGLE] or [MULTI] and then press [MENU/SET].
 - When [CANCEL] is selected, see “Canceling all the [PROTECT] settings”.

- 3 Select the picture, and then press [MENU/SET].

When [MULTI] has been selected

- Repeat these steps for each picture.
- The settings are canceled when [MENU/SET] is pressed again.
- Press [] to return to the menu screen.

[SINGLE]



Press ◀/▶ to select the picture.

[MULTI]

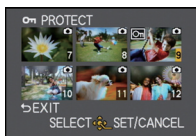

Press ▲/▼/◀/▶ to select the pictures.

■ **Canceling all the [PROTECT] settings**

- 1 Select [CANCEL] on the screen shown in step 2 and then press [MENU/SET].
- 2 Press ▲ to select [YES] and then press [MENU/SET].
 - If you press [MENU/SET] while canceling protection, the canceling will stop halfway.

Note

- The [PROTECT] feature is only designed to work with this camera.
- Even if you protect pictures on a card, they will be deleted if the card is formatted.
- Even if you do not protect pictures on a card, they cannot be deleted when the card's Write-Protect switch is set to [LOCK].

[FACE REC EDIT]

You can clear and replace all information relating to face recognition in selected images.

- 1** Select [FACE REC EDIT] on the [PLAYBACK] Mode menu. (P56)
- 2** Press ▲/▼ to select [REPLACE] or [DELETE] and then press [MENU/SET].
- 3** Press ◀/▶ to select the picture and then press [MENU/SET].
 - You cannot select pictures for which Face Recognition information has not been registered.
- 4** Press ◀/▶ to select the person and then press [MENU/SET].
 - [DELETE] → step 6.
 - You cannot select a person who has not been registered.
- 5** Press ▲/▼/◀/▶ to select the person to replace and then press [MENU/SET].
- 6** Press ▲ to select [YES] and then press [MENU/SET].
 - Press [🗑️/↩️] to return to the menu screen.

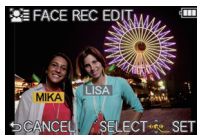

Note

- Cleared information regarding the [FACE RECOG.] cannot be restored.
- When all Face Recognition information in a picture has been canceled, the picture will not be categorised using Face Recognition in [CATEGORY PLAY].

Enjoying 3D pictures

Taking 3D pictures

Attaching the 3D interchangeable lens (H-FT012; optional) to the camera allows you to take 3D pictures for extra impact.

To view 3D pictures, a television that supports 3D is required.

3D picture



The image is an illustration.

- 1 Attach the 3D interchangeable lens to the camera.**
- 2 Bring the subject into the frame and record by pressing the shutter button fully.**
 - Focusing is not required when recording 3D pictures.
 - Still pictures recorded with the 3D interchangeable lens attached are saved in MPO format (3D).

To ensure that the 3D pictures can be safely viewed, pay attention to the following points when recording.

- Where possible, record with the unit in a horizontal state.
- The suggested minimum subject distance is 0.6 m (1.97 feet).
- Be careful not to shake the camera while in a vehicle or walking.

Note

- **You cannot record 3D pictures in vertical orientation.**
- It is recommended to use a tripod or a flash to record steady pictures.
- When a distance to the subject is 0.6 m (1.97 feet) to approximately 1 m (3.28 feet), horizontal disparity becomes too great, and you may not see the 3D effect at the edges of the image.
- Up to approx. 650 3D pictures can be recorded on a 2 GB card. (When the aspect ratio is set to [4:3], and the quality is set to [BD].)
- Read the operating instructions of the 3D interchangeable lens for details.

■ Functions that cannot be used during 3D recording

When recording with the 3D interchangeable lens (H-FT012; optional), the following feature will be disabled:

(Recording functions)





- Auto Focus/Manual Focus operation
- Aperture setting
- Zoom operation
- Recording motion pictures*1
- [DYNAMIC ART] in My Color Mode
- Defocus control function

*1 The motion picture button and the [MOTION PICTURE] Mode menu will be unavailable or unusable.

([REC] Mode menu)

- [PICTURE SIZE]*2/[QUALITY]*3/[QUICK AF]/[RED-EYE REMOVAL]/[I.RESOLUTION]/[I.DYNAMIC]/[EX. TELE CONV.]/[DIGITAL ZOOM]/[STABILIZER]/

*2 The setting is fixed as shown below.

Aspect ratio	Picture size
	1600×1200 pixels
	1600×1064 pixels
	1600×904 pixels
	1440×1440 pixels

*3 When attaching 3D interchangeable lens, the following icons are displayed.

: MPO+Fine (Both MPO images and fine JPEG images are recorded simultaneously.)

: MPO+Standard (Both MPO images and standard JPEG images are recorded simultaneously.)

([CUSTOM] menu)

- [AF/AE LOCK]/[DIRECT FOCUS AREA]/[FOCUS PRIORITY]/[AF ASSIST LAMP]/[AF+MF]/[MF ASSIST]/[MF GUIDE]/[ BUTTON]/[ REC AREA]/[REMAINING DISP.]/[DEFOCUS CTRL]

Playing back 3D pictures

Connecting the camera to a 3D compatible television and playing back pictures taken in 3D allows you to enjoy 3D pictures for extra impact.

It is also possible to play back the recorded 3D pictures by inserting an SD card into the 3D compatible television with an SD card slot.

For the latest information on 3D compatible televisions and recorders that are capable of playing back 3D pictures recorded using the unit, see the support site below.

<http://panasonic.jp/support/global/cs/dsc/> (This Site is English only.)

Preparations: Set the [HDMI MODE] to [AUTO] or [1080i]. (P64)

Set the [3D PLAYBACK] to [3D]. (P65)

Connect the unit to a 3D compatible television using the HDMI mini cable and display the playback screen. (P171)

- When [VIERA Link] (P64) is set to [ON] and the camera is connected to a TV supporting VIERA Link, input of the TV will be switched automatically and playback screen will be displayed. Refer to P173 for details.
- For the pictures recorded in 3D, [3D] will appear on the thumbnail display at playback.

■ Playback in 3D by selecting only the still pictures recorded in 3D

Select [3D PLAY] in [PLAYBACK MODE] in the [PLAYBACK] Mode menu. (P151)

■ Playback as a 3D slide show by selecting only the still pictures recorded in 3D

Select [3D] in [SLIDE SHOW] in the [PLAYBACK] Mode menu. (P149)

■ Switch the playback method for the still pictures recorded in 3D

1 Select the picture recorded in 3D.

2 Select [2D/3D SETTINGS] on the [PLAYBACK] Mode menu and then press ►. (P56)

- Playback method will switch to 3D if it is playing back in 2D (conventional image), or it will switch to 2D if it is playing back in 3D.
- If you feel tired, uncomfortable or otherwise strange when playing back pictures recorded in 3D, set to 2D.

■ Functions that cannot be set/do not work with 3D pictures

- [HIGHLIGHT] in the [CUSTOM] menu*
- Playback Zoom*
- Deleting pictures*
- Editing functions of [PLAYBACK] Mode menu ([TITLE EDIT]/[TEXT STAMP]/[VIDEO DIVIDE]/[RESIZE]/[CROPPING]/[ASPECT CONV.]/[ROTATE]/[ROTATE DISP.]/[FAVORITE]*/[PRINT SET]*/[PROTECT]*/[FACE REC EDIT]*)

* Can be used when displayed in 2D.

Note

- When a picture recorded in 3D is displayed on the LCD monitor of this unit, it is played back in 2D (conventional image).
- A black screen is displayed for a few seconds when switching back and forth playback of 3D pictures and 2D pictures.
- When you select a 3D picture thumbnail, it may take a few seconds for playback to start. After playback, the thumbnail display may take a few seconds to reappear.
- When viewing 3D pictures, your eyes may become tired if you are too close to the television screen.
- If your television does not switch to a 3D picture, make the necessary settings on the TV. (For details, refer to the operating instructions of the TV.)

Saving 3D pictures

You can save 3D pictures using a recorder or a computer.

■ Dubbing with a recorder

3D pictures will be recorded in MPO format when copied with the 3D compatible recorder.

- When the copied pictures do not playback in 3D, perform the necessary setup on the television. (For details, refer to the operating instruction of the television.)
- **Note that the equipment described may not be available in certain countries and regions.**

Copying of the still pictures recorded in 3D

Check the latest information about the equipment that can copy on the following website.

<http://panasonic.jp/support/global/cs/dsc/> (This Site is English only.)

■ Copying to a PC

- For details, refer to "Copying to a PC using "PHOTOfunSTUDIO 6.0 HD Edition"" on P178.

Playing Back Pictures on a TV Screen

Playing back pictures using the AV cable (supplied)

Preparations: Set the [TV ASPECT]. (P63)
Turn this unit and the TV off.

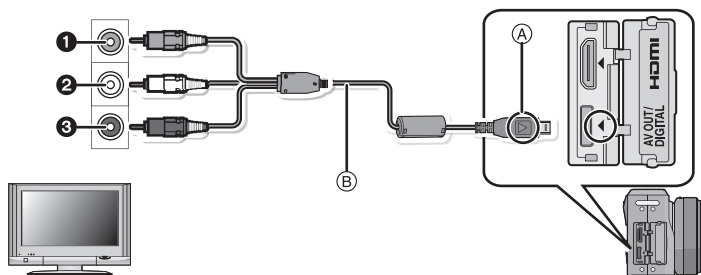

① Yellow: to the video input socket

② White: to the audio input socket

③ Red: to the audio input socket

Ⓐ Align the marks, and insert.

Ⓑ AV cable (supplied)

• Check the directions of the connectors, and plug them straight in or unplug them straight out. (Otherwise the connectors may be bent out of shape which may cause malfunction.)

- 1** Connect the AV cable Ⓑ (supplied) to the video input and the audio input sockets on the TV.
- 2** Connect the AV cable to the [AV OUT] socket on the camera.
- 3** Turn the TV on and select external input.
- 4** Turn the camera on and then press [▶].

 **Note**

- Depending on the [ASPECT RATIO], black bands may be displayed on the top and bottom or the left and right of the pictures.
- Do not use any other AV cables except the supplied one.
- Read the operating instructions for the TV.
- When you play back a picture vertically, it may be blurry.
- Audio will be played back as stereo (2ch).
- If the Optional Live Viewfinder (P188) is installed, pictures will not be displayed when the camera is connected with the AV cable.
- Change the screen mode on your TV if the picture is displayed with the top or bottom cut off.
- AV output is disabled when recording.

Playing back pictures on a TV with an SD Memory Card slot

The recorded still pictures can be played back on a TV with an SD Memory Card slot.

 **Note**

- Proper playback (aspect ratio) will be dependent on the TV used for viewing.
- Motion pictures recorded with [AVCHD] can be played back on Panasonic TVs (VIERA) with the AVCHD logo mark. In all other cases, connect the camera to the TV using the AV cable (supplied) and play back the motion picture.
- If SDHC or SDXC memory cards are used, your TV must also be compatible with this type of media.

Playing back on the TV with HDMI socket

You can enjoy high quality pictures and motion pictures on the TV by connecting the camera with the HDMI compatible high-definition TV using HDMI mini cable (optional).

Preparations: Check the [HDMI MODE]. (P64)
Turn this unit and the TV off.

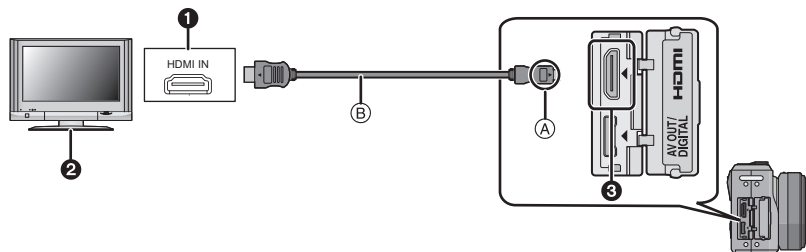

1 HDMI socket

2 TV with HDMI socket

3 HDMI mini (C type)

A Align the marks, and insert.

B HDMI mini cable (optional)

• Check the direction of the terminals and plug in/out straight holding onto the plug. (It may result in malfunction if it is plugged in obliquely or in the wrong direction.)

1 Connect the HDMI mini cable **B** (optional) to the HDMI input socket on the TV.

2 Connect the HDMI mini cable to the [HDMI] socket on the camera.

3 Turn the TV on and switch to HDMI input.

4 Turn the camera on and then press [▶].

• When [VIERA Link] (P64) is set to [ON] and the camera is connected to a TV supporting VIERA Link, input of the TV will be switched automatically and playback screen will be displayed (P173).

 **Note**

- During HDMI output, no picture is displayed on the LCD monitor.
- During HDMI output, [DISP.] is displayed on the LCD monitor of this unit when played back in 1 screen display (image is not displayed). Touch [DISP.] to switch the display information.
- Depending on the [ASPECT RATIO], bands may be displayed on the top and bottom or the left and right of the pictures.
- Always use a genuine Panasonic HDMI mini cable (RP-CDHM15, RP-CDHM30; optional).
Part numbers: RP-CDHM15 (1.5 m) (5 feet), RP-CDHM30 (3.0 m) (10 feet)
- Output from the HDMI mini cable has priority when both AV cable and HDMI mini cable are connected.
- The connection with the USB connection cable will take priority when you connect the USB connection cable simultaneously with the HDMI mini cable.
- Proper playback will be dependent on the TV used for viewing.
- Read the operating instructions for the TV.
- Audio will be played back as stereo (2ch).

Playback using VIERA Link (HDMI) (HDAVI Control™)

What is VIERA Link?

- VIERA Link™ is a new name for EZ Sync™.
- This function allows you to use your remote control for the Panasonic TV for easy operations when this unit has been connected to a VIERA Link compatible device using a HDMI mini cable (optional) for automatic linked operations. (Not all operations are possible.)
- VIERA Link is a unique Panasonic function built on a HDMI control function using the standard HDMI CEC (Consumer Electronics Control) specification. Linked operations with HDMI CEC compatible devices made by other companies are not guaranteed. When using devices made by other companies that are compatible with VIERA Link, refer to the operating instructions for the respective devices.
- This unit is compatible with VIERA Link Ver.5. VIERA Link Ver.5 is the newest Panasonic version and is also compatible with existing Panasonic VIERA Link devices. (As of December 2009)

Preparations: Set the [VIERA Link] to [ON]. (P64)

- 1 Connect this unit to a Panasonic TV compatible with VIERA Link with a HDMI mini cable (optional) (P171).**
- 2 Turn the camera on and then press [▶].**
- 3 Operate with the remote control for the TV.**

Panasonic TV compatible with VIERA Link

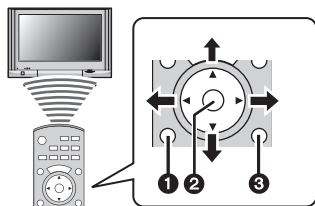



- 1** [SUB MENU]
- 2** [OK]
- 3** [RETURN]

- * The shape of the remote control varies depending on the region. Operate following the TV guide displayed on screen.

■ Usable functions

Operate with the remote control for the TV.

<p>Multi Playback</p> 	<p>This is displayed initially when using the VIERA Link.</p> <p>▲/▼/◀/▶: Select the image. [OK]: Go to one screen display. Red button: Switch the types of data to play back. [SUB MENU]: Display the Playback Mode selection screen.</p> <ul style="list-style-type: none"> • The type of data for playback changes in the order of [ALL] → [IMAGE] → [PERSON] → [EJECT] → [3D] → [ALL]. • Either the [NORMAL PLAY], [SLIDE SHOW], [CATEGORY PLAY], [FAVORITE PLAY] or the [CALENDAR] can be selected in the Playback Mode selection screen when [ALL] is selected.
<p>One screen display</p> 	<p>Select the image while in Multi Playback, and then press [OK].</p> <p>◀/▶: Go to previous/next image. ▲: 2D/3D switch*1 ▼: Return to Multi Playback. [OK]: Playback the motion picture (when motion picture is selected). Red button: Start the Slide Show. [SUB MENU]: Slide show settings*2, display the recording information switch</p> <ul style="list-style-type: none"> • During Motion Picture Playback, use ◀/▶ for back/forward and ▼ to stop playback.
<p>Slide show</p> 	<p>Press Red button during one screen display.</p> <p>◀/▶: Go to previous/next image (when Slide Show is paused/when motion picture is played back). ▼: Finish the Slide Show and return to one screen display. [OK]: Pause. [SUB MENU]: Go to Slide Show setting screen.*2</p> <ul style="list-style-type: none"> • To playback the audio of the motion pictures, set the [SOUND] in the Slide Show setting screen to [AUTO] or [AUDIO].

Ⓐ Operation icon

*1 This is displayed only when 3D playback is possible.

*2 This is not displayed during 3D playback.

 **Note**

- Operation icons are hidden by pressing [RETURN], or if no operation is performed for a while when the operation icons are displayed. Operation icons are displayed when one of the following buttons is pressed while the operation icons are not displayed.
 - ▲/▼/◀/▶, [OK], [SUB MENU], [RETURN], Red button, Green button, Yellow button
- It is recommended to connect this unit to an HDMI terminal other than the HDMI1 if there are 2 or more HDMI input terminals on the TV.
- When the [VIERA Link] (P64) of this unit is set to [ON], operation using the button on this unit will be limited.
- VIERA Link must be activated on the connected TV. (Read the operating instructions of the TV for how to set etc.)
- If you are not using VIERA Link, set [VIERA Link] (P64) to [OFF].

■ Other linked operations**Turning the power off:**

If you use the remote control for the TV to turn off the power, the power on this unit also turns off.

Automatic input switching:

- If you connect with a HDMI mini cable and then turn on the power on this unit, and then press [▶], the input channel on the TV automatically switches to this unit's screen. If the TV's power is in standby status, it will turn on automatically (if [Set] has been selected for the TV's [Power on link] setting).
- Depending on your TV's HDMI connection, on some TV's it may be necessary to manually select the HDMI connection you are using. In this case, use the remote control for the TV to switch the input channel. (For details on how to switch input, please read the operating instructions for the TV.)
- If VIERA Link does not work properly, refer to page 215.

 **Note**

- If you are unsure whether or not the TV you are using are compatible with VIERA Link, read the operating instructions for the TV.
- Available linked operations between this unit and a Panasonic TV is different depending on the types of Panasonic TVs even if they are compatible with VIERA Link. Refer to the operating instructions of the TV for the operations that support on the TV.
- Be sure to use a cable that is HDMI certified.
Always use a genuine Panasonic HDMI mini cable (RP-CDHM15, RP-CDHM30; optional).
Part numbers: RP-CDHM15 (1.5 m) (5 feet), RP-CDHM30 (3.0 m) (10 feet)
- Before attempting to use VIERA Link, be sure the camera is not connected to a PC or Printer.
- [HDMI MODE] (P64) for this unit is determined automatically when the VIERA Link is operating.

Saving the Recorded Still Pictures and Motion Pictures

Methods to export still pictures and motion pictures to other devices will vary depending on the file format. (JPEG, RAW, MPO, AVCHD, or Motion JPEG). Here are a few suggestions.

■ Copy by inserting the SD card into the recorder

File formats that can be used: [JPEG], [AVCHD]

It is possible to copy onto Blu-ray disc, DVD disc, or hard disk by inserting an SD card with still pictures and motion pictures recorded by this unit into a Panasonic Blu-ray Disc Recorder or DVD Recorder.

Check the latest information about the equipment that can copy directly by inserting the SD card recorded by this unit, and equipment that is compatible with high definition (AVCHD) on the following website.

<http://panasonic.jp/support/global/cs/dsc/> (This Site is English only.)

- See the instruction manual for the recorder about the details of copying and playing back.
- **Note that the equipment described may not be available in certain countries and regions.**

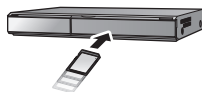

■ Copy the playback image using an AV cable

File formats that can be used: [AVCHD], [Motion JPEG]

Copy images played back with this unit to Blu-ray disc, DVD disc, hard disk, or video using a Blu-ray Disc Recorder, DVD recorder, or video.

This can be played back with equipment that is not compatible with high-definition (AVCHD), so it is convenient for distributing copies. Image will be standard quality instead of high-definition at this time.

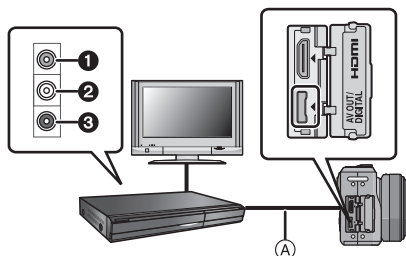

- ① Yellow: to the video input socket
- ② White: to the audio input socket
- ③ Red: to the audio input socket
- Ⓐ AV cable (supplied)

- 1 Connect this unit with the recording equipment with an AV cable (supplied).
- 2 Start the playback of this unit.
- 3 Start the recording on the recording equipment.

- When ending the recording (copying), stop the playback on this unit after stopping the recording in recording equipment.

Note

- When you play back motion pictures on 4:3 aspect ratio TV, you must set [TV ASPECT] (P63) on this unit to [4:3] before starting a copy. The image will be vertically long if you play back motion pictures copied with [16:9] setting on a [4:3] aspect TV.
- Do not use any other AV cables except the supplied one.
- See the instruction manual for the recording equipment about the details of copying and playing back.

■ Copying to a PC using “PHOTOfunSTUDIO 6.0 HD Edition”

File formats that can be used: [JPEG], [RAW], [MPO], [AVCHD], [Motion JPEG]

It is possible to acquire still pictures and motion pictures recorded in [AVCHD] or [MOTION JPEG] formats, or create conventional standard quality DVD video from the motion picture that was recorded as [AVCHD], using “PHOTOfunSTUDIO 6.0 HD Edition” in the CD-ROM (supplied).

Also, you can write images to DVD, combine multiple pictures to create a single panorama picture, or create a slide show by adding audio and/or music. These pictures can then be stored onto a DVD.



1 Install “PHOTOfunSTUDIO 6.0 HD Edition” to the PC.

- Read the separate operating instructions for the supplied software for more information about the software in the CD-ROM (supplied) and how to install it.

2 Connect camera to PC.

- For details on connecting, refer to “Connecting to a PC” (P179).

3 Copy the images to a PC using “PHOTOfunSTUDIO 6.0 HD Edition”.

- For details, refer to the operating instructions of “PHOTOfunSTUDIO 6.0 HD Edition” (PDF).

Note

- You will not be able to playback the acquired [AVCHD] motion pictures when the files or folders related to the motion pictures are deleted, modified, or moved using Windows Explorer or similar, so make sure to acquire the [AVCHD] motion pictures using “PHOTOfunSTUDIO 6.0 HD Edition”.

Connecting to a PC

You can acquire recorded pictures to a PC by connecting the camera and the PC.

- Some PCs can read directly from the card removed from the camera. For details, refer to the operating instructions of your PC.
- **If you are using SDXC memory cards and your PC shows a message prompting you to format the card take notice. Check to be sure your PC supports SDXC memory cards. Formatting the card will cause recorded images to be erased and can reduce the card's capacity.**

If the card is not recognized, please refer to the below support site.

<http://panasonic.net/avc/sdcard/information/SDXC.html>

- You can easily print out or mail the pictures you have imported. Use of the "PHOTOfunSTUDIO 6.0 HD Edition" bundled software on the CD-ROM (supplied) is a convenient way of doing this.
- Read the separate operating instructions for the supplied software for more information about the software in the CD-ROM (supplied) and how to install it.

Acquiring of still pictures and [MOTION JPEG] motion pictures (other than [AVCHD] motion pictures)

Preparations: Turn on the camera and the PC.

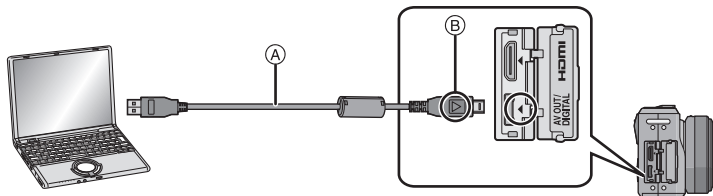

(A) USB connection cable (supplied)

- Check the directions of the connectors, and plug them straight in or unplug them straight out. (Otherwise the connectors may be bent out of shape which may cause malfunction.)

(B) Align the marks, and insert.

- Use a battery with sufficient battery power or the AC adaptor (optional). If the remaining battery power becomes low while the camera and the PC are communicating, the status indicator blinks and the alarm beeps.

Refer to "Disconnecting the USB connection cable safely" (P180) before disconnecting the USB connection cable. Otherwise, data may be destroyed.

1 Connect the camera to a PC via the USB connection cable (supplied). Ⓐ

- Do not use any other USB connection cables except the supplied one. Use of cables other than the supplied USB connection cable may cause malfunction.

2 Press ▲/▼ to select [PC], and then press [MENU/SET].

- If [USB MODE] (P63) is set to [PC] in the [SETUP] menu in advance, the camera will be automatically connected to the PC without displaying the [USB MODE] selection screen. Since there is no need to set this each time you connect to the PC, it is convenient.
- When the camera has been connected to the PC with [USB MODE] set to [PictBridge(PTP)], a message may appear on the PC's screen. Select [Cancel] to close the screen, and disconnect the camera from the PC. Then set [USB MODE] to [PC] again.

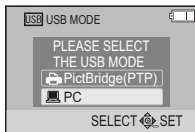

3 Double-click on [Removable Disk] in [My Computer].

- When using a Macintosh, the drive is displayed on the desktop. ("LUMIX", "NO_NAME" or "Untitled" is displayed.)

4 Double-click [DCIM] folder.

5 Using a drag-and-drop operation, move the pictures you want to acquire or the folder storing those pictures to any different folder on the PC.

■ Disconnecting the USB connection cable safely

- Proceed with the hardware removal using "Safely Remove Hardware" on the task tray of the PC. If the icon is not displayed, check that [ACCESS] is not displayed on the LCD monitor of the digital camera before removing the hardware.

Note

- Turn the camera off before connecting or disconnecting the AC adaptor (optional).
- Before inserting or removing a card, turn the camera off and disconnect the USB connection cable. Otherwise, data may be destroyed.

■ Viewing the contents of the card using the PC (folder composition)

This camera is only designed to display pictures taken with this camera. Improper playback can result if you attempt to play pictures or folders edited on a PC.

It is recommended to use the "PHOTOfunSTUDIO 6.0 HD Edition" bundled software on the CD-ROM (supplied) when you write the image from PC to a card.

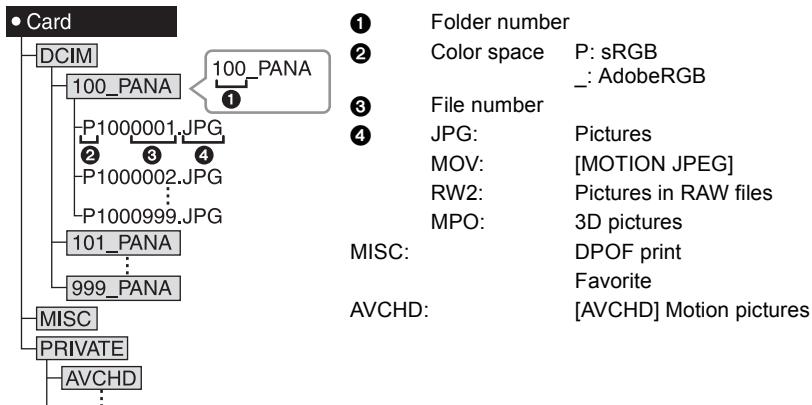

A new folder is created when pictures are taken in the following situations.

- After [NO.RESET] (P66) in the [SETUP] menu has been executed
- When a card containing a folder with the same folder number has been inserted (Such as when pictures were taken using another make of camera)
- When there is a picture with file number 999 inside the folder

■ Connection in the PTP Mode (Windows[®] XP, Windows Vista[®], Windows[®] 7 and Mac OS X only)

Set [USB MODE] to [PictBridge(PTP)].

Data can now be read only from the card into the PC.

- When there are 1000 or more pictures on a card, the pictures may not be imported in the PTP mode.
- If your camera is in PTP (PictBridge) mode, please change it before attempting to play [AVCHD] motion pictures.

Printing the Pictures

If you connect the camera to a printer supporting PictBridge, you can select the pictures to be printed out and instruct that printing be started on the camera's LCD monitor.

- Some printers can print directly from the card removed from the camera. For details, refer to the operating instructions of your printer.

Preparations: Turn on the camera and the printer.

Perform the print quality and other settings at the printer before printing the pictures.

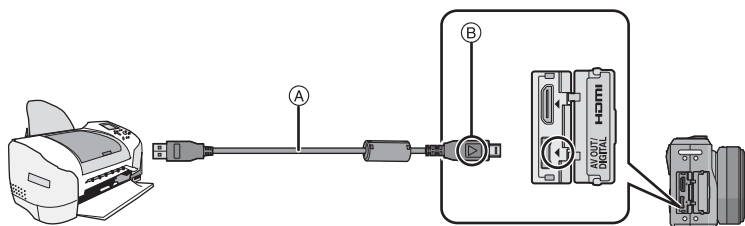

(A) USB connection cable (supplied)

- Check the directions of the connectors, and plug them straight in or unplug them straight out. (Otherwise the connectors may be bent out of shape which may cause malfunction.)

(B) Align the marks, and insert.

- Use a battery with sufficient battery power or the AC adaptor (optional). If the remaining battery power becomes low while the camera and the printer are connected, the status indicator blinks and the alarm beeps. If this happens during printing, stop printing at once. If not printing, disconnect the USB connection cable.

1 Connect the camera to a printer via the USB connection cable (A) (supplied).

- When the camera is connected to the printer, the cable disconnect prohibit icon [⊘] appears. Do not disconnect the USB cable while [⊘] is displayed.

2 Press ▲/▼ to select [PictBridge(PTP)], and then press [MENU/SET].

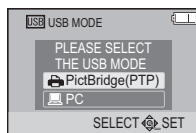

Note

- Do not use any other USB connection cables except the supplied one. Use of cables other than the supplied USB connection cable may cause malfunction.
- Turn the camera off before connecting or disconnecting the AC adaptor (optional).
- Before inserting or removing a card, turn the camera off, and disconnect the USB connection cable.
- Motion pictures recorded cannot be printed out.

Selecting a single picture and printing it

1 Press ◀/▶ to select the picture and then press [MENU/SET].

- The message disappears in about 2 seconds.

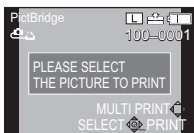

2 Press ▲ to select [PRINT START] and then press [MENU/SET].

- Refer to P185 for the items which can be set before starting to print the pictures.
- Press [MENU/SET] to cancel printing halfway.
- Disconnect the USB connection cable after printing.

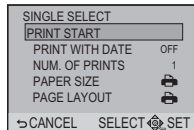

Selecting multiple pictures and printing them

1 Press ▲.

2 Press ▲/▼ to select an item and then press [MENU/SET].

- If the print check screen has appeared, select [YES], and print the pictures.

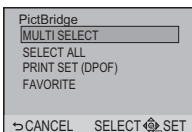

Item	Description of settings
[MULTI SELECT]	Multiple pictures are printed at one time. <ul style="list-style-type: none"> • Press ▲/▼/◀/▶ to select the pictures, and then when [MENU/SET] is pressed, [] appears on the pictures to be printed. (When [MENU/SET] is pressed again, the setting is canceled.) • Once the selection is completed, press ◀ a few times to select [OK], and press [MENU/SET].
[SELECT ALL]	Prints all the stored pictures.
[PRINT SET (DPOF)]	Prints the pictures set in [PRINT SET] only. (P161)
[FAVORITE]*	Prints the pictures set as favorites only. (P160)

* Only when [FAVORITE] is at [ON] and when there are pictures set as favorites. (P160)

3 Press ▲ to select [PRINT START] and then press [MENU/SET].

- Refer to P185 for the items which can be set before starting to print the pictures.
- Press [MENU/SET] to cancel printing.
- Disconnect the USB connection cable after printing.

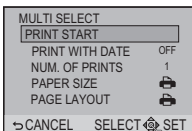

Print Settings

Select and set the items both on the screen in step **2** of the “Selecting a single picture and printing it” and in step **3** of the “Selecting multiple pictures and printing them” procedures.

- When you want to print pictures on a paper size or a layout which is not supported by the camera, set [PAPER SIZE] or [PAGE LAYOUT] to [] and then set the paper size or the layout on the printer. (For details, refer to the operating instructions of the printer.)
- When [PRINT SET (DPOF)] has been selected, the [PRINT WITH DATE] and [NUM. OF PRINTS] items are not displayed.

■ [PRINT WITH DATE]

Item	Description of settings
[OFF]	Date is not printed.
[ON]	Date is printed.

- If the printer does not support date printing, the date cannot be printed on the picture.
- Since the printer's settings may take precedence over the print with date setting, check the printer's print with date setting as well.
- When printing images with a text stamp, please remember to set print with date to [OFF] or the date will print on top.
- In some printers, the picture date for pictures taken with the aspect ratio set to [] will be printed vertically.

Note

When asking the photo shop to print the pictures

- By stamping the date using [TEXT STAMP] (P153) or setting date printing at the time of the [PRINT SET] (P161) setting before going to a photo shop, the dates can be printed at the photo shop.

■ [NUM. OF PRINTS]

You can set the number of prints up to 999.





- You can also use the rear dial to set.

■ [PAPER SIZE]

Item	Description of settings
	Settings on the printer are prioritized.
[L/3.5"×5"]	89 mm×127 mm
[2L/5"×7"]	127 mm×178 mm
[POSTCARD]	100 mm×148 mm
[16:9]	101.6 mm×180.6 mm
[A4]	210 mm×297 mm
[A3]	297 mm×420 mm
[10×15cm]	100 mm×150 mm
[4"×6"]	101.6 mm×152.4 mm
[8"×10"]	203.2 mm×254 mm
[LETTER]	216 mm×279.4 mm
[CARD SIZE]	54 mm×85.6 mm

- Paper sizes not supported by the printer will not be displayed.

■ [PAGE LAYOUT] (Layouts for printing that can be set with this unit)

Item	Description of settings
	Settings on the printer are prioritized.
	1 picture with no frame on 1 page
	1 picture with a frame on 1 page
	2 pictures on 1 page
	4 pictures on 1 page

- An item cannot be selected if the printer does not support the page layout.

■ Layout printing

When printing a picture several times on 1 sheet of paper

For example, if you want to print the same picture 4 times on 1 sheet of paper, set [PAGE LAYOUT] to  and then set [NUM. OF PRINTS] to 4 for the picture that you want to print.

When printing different pictures on 1 sheet of paper

For example, if you want to print 4 different pictures on 1 sheet of paper, set [PAGE LAYOUT] to  and then set [NUM. OF PRINTS] to 1 for each of the 4 pictures.

Note

- The camera is receiving an error message from the printer when the  indication lights orange during printing. After finishing printing, make sure there are no problems with the printer.
- If the number of prints is high, the pictures may be printed several times. In this case, the remaining number of prints indicated may differ from the number set.
- Only pictures taken in JPEG format can be printed. Those taken in RAW will use the JPEG pictures that were simultaneously created. If an equivalent JPEG picture is not available, no print will take place.

Optional accessories

Optional Live Viewfinder

When using the Optional Live Viewfinder (DMW-LVF1; optional), you can view the recording screen even when taking pictures with a low camera angle.

Preparations:

- Turn off the camera.
- Remove the hot shoe cover that is attached to the camera. (P8)

1 Insert the Optional Live Viewfinder fully and securely into the hot shoe.

2 Switch [ON] the camera.

- [] is displayed on the LCD monitor. It may not be connected properly if it does not display.

3 Switch to and from the Optional Live Viewfinder by pressing [LVF/LCD].

- You can switch between LCD (LCD monitor) display and LVF (Live Viewfinder) display.
- Some touch icons such as [] are not displayed in the LVF display. Operate using the cursor button or rear dial.
- Switching via the [LVF/LCD] button will be maintained even when the power of the digital camera is turned [OFF].
- When switching the display information in cases such as the exposure meter not being displayed, switch once to the LCD display and switch the display information there.

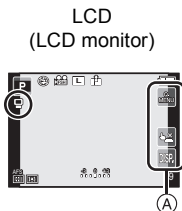

(A) Touch icon

■ Monitor priority

When [PLAY ON LCD] is set to [ON] on the [CUSTOM] menu (P145), the LCD monitor is turned on when switching from Recording Mode to Playback Mode.

You can save the time it would take to switch the display to the LCD monitor even when using the Live Viewfinder to record.

Note

- When attaching and detaching the optional live viewfinder, be sure to do so slowly and carefully.
- The Optional Live Viewfinder cannot be used with the external flash.
- When a strap is fitted, do not allow it to snag on the optional live viewfinder.
- When attaching the optional live viewfinder, do not hold only the optional live viewfinder because it may detach from the camera.
- As the eye cup cannot be removed, gently wipe it with a dry and soft cloth, and be careful not to remove it.
- If you wipe the eye cup too hard and it is removed, consult the dealer or your nearest Service Center.
- For details, refer to the operating instructions of the optional live viewfinder.

External Flash (optional)

After attaching the external flash (DMW-FL220, DMW-FL360, DMW-FL500; optional), the effective range will be increased when compared to the camera's built in flash.

Preparations:

- Turn off the camera and close the built-in flash.
- Remove the hot shoe cover that is attached to the camera. (P8)

■ Using the dedicated flash (DMW-FL220; optional)

1 Attach the dedicated flash to the hot shoe and then turn on the camera and the dedicated flash.

2 Select [FLASH] on the [REC] Mode menu. (P56)

3 Press ▲/▼ to select the mode and then press [MENU/SET].

- While the external flash is connected, the following icons are displayed.

⚡: External flash Forced ON

⚡S: External flash Slow Sync.

■ When using other commercially available external flashes without communication functions with the camera (DMC-GF2)

- It is necessary to set the exposure on the external flash. If you want to use the external flash in Auto Mode, use an external flash that allows you to set the aperture value and the ISO sensitivity to match the settings on the camera.
- Set to Aperture-Priority AE Mode or Manual Exposure Mode on the camera and then set the same aperture value and ISO sensitivity on the external flash. (The exposure cannot be compensated adequately due to the change on the aperture value in Shutter-Priority AE Mode and the external flash cannot control the light adequately in Program AE Mode because the aperture value cannot be fixed.)

Note

- This cannot be used simultaneously with the Optional Live Viewfinder.
- You can set the aperture value, the shutter speed and the ISO sensitivity on the camera even when attaching the external flash.
- Some commercial external flashes have synchro terminals with high-voltage or reversed polarity. Using such extra flashes may cause a malfunction or the camera may not operate normally.
- If you use commercially available external flashes with communication functions other than the dedicated one, they may not operate normally or they may be damaged. Do not use them.
- Even if the external flash is turned off, the camera may enter the external flash mode when the external flash is attached. When you are not using the external flash, detach it.
- Do not open the built-in flash when an external flash is attached.
- The camera will become unstable when attaching the external flash, it is recommended to use a tripod when taking picture.
- Detach the external flash when carrying the camera.
- The built in flash is disabled when an external flash is attached.
- If you use the external flash when the White Balance is set to [$\frac{[\text{Z}]}{[\text{WB}]}$] finely adjust the White Balance depending on the picture quality. (P96)
- If you take pictures close to the subject in Wide, the vignetting effect may appear on the bottom of the recorded picture.
- Read the operating instructions of the external flash for details.

Protector/Filter (optional)

The MC protector (optional) is a transparent filter which affects neither the colors nor the amount of light, so it can always be used to protect the camera's lens.

The ND filter (optional) reduces the amount of light to approximately 1/8th (equal to adjusting the aperture value 3 increments) without affecting the color balance.

PL filter (optional) will suppress the reflected light from a metal or non spherical surfaces (flat non-metallic surfaces, water vapour or invisible particles in the air), making it possible to take a picture with enhanced contrast.

Note

- **MC**="Multi-coated"
- **ND**="Neutral Density"

- Do not attach multiple filters at the same time.
- You can attach the lens cap or the lens hood when the filter is attached.
- Accessories other than filters, such as conversion lenses, cannot be mounted. It may cause malfunction.
- Refer to the instructions for each filter for details.

AC adaptor (optional)/DC coupler (optional)

By connecting the AC adaptor (optional), and then plugging them into an electrical socket, you can connect this unit to a PC or printer and use without worrying about the capacity of the battery. To use the AC adaptor, a DC coupler (optional) is required.

Note

- Always use a genuine Panasonic AC adaptor (optional).
- When using an AC adaptor, use the AC cable supplied with the AC adaptor.
- Also read the operating instructions for the AC adaptor and DC coupler.

Screen Display

■ In recording

Recording in Program AE Mode [P] (Initial setting)

- 1 Recording Mode (P30)
- 2 Flash Mode (P71)
- 3 REC MODE (when recording motion pictures) (P139)/Recording quality (P140)
- 4 Picture size (P130)
- 5 Quality (P131)
- 6 Optical Image Stabilizer*1 (P76)/
((())) : Jitter alert (P77)
- 7 [H]: Burst (P79)
[B]: Auto Bracket (P81)
[10]: Self-timer (P83)
- 8 Battery indication (P21)
- 9 Touch Quick Menu (P58)
● : Recording state (Flashes red.)/
Focus (P32) (Lights green.)
- 10 Touch Shutter (P37)
- 11 Display (P39, 67)
- 12 Number of recordable pictures*2 (P27)
- 13 Dial operation guide (P147)
- 14 Exposure meter (P143)
- 15 Exposure compensation value (P78)/
Manual exposure assistance (P102)
- 16 Shutter speed (P34)
- 17 Aperture value (P34)
- 18 Metering Mode (P133)
- 19 AF Mode (P85)
- 20 Focus Mode (P32)
- 21 AF area (P33, 85)
- 22 Card (P25) (displayed only during recording)/
Elapsed recording time (P44)

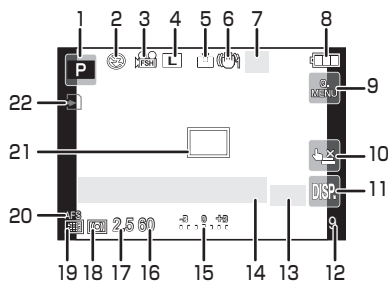

■ In recording (after settings)

- 23 Custom settings (P118)
- 24 WIND CUT (P141)
- 25 Extended Tele Conversion (when recording motion pictures) (P69)
- 26 Extended Tele Conversion (when taking still pictures) (P69)
- 27 Histogram (P68)
- 28 Intelligent Dynamic Range Control (P135)
- 29 Intelligent Resolution (P134)
- 30 Defocus control function (P51)
- 31 AF tracking operation (P50, 87)
- 32 White Balance Bracket (P97)
- 33 Available recording time*2 (P27): R8m30s*3
- 34 White Balance Fine Adjustment (P96)
- 35 White Balance (P93)
- 36 ISO sensitivity (P98)
- 37 My Color Mode adjustment (P116)
- 38 Current date and time/📅: Travel destination setting*4 (P127)
- 39 Program Shift (P36)
- 40 AE lock (P105)
- 41 Face Recognition (P119)
- 42 AF lock (P105)
- 43 Mic level display (P141)
Age*5 (P112)
Location*4 (P125)
- 44 Name*5 (P112)
Number of days that have passed since the departure date*4 (P125)
- 45 Self-timer*6 (P83)
- 46 Spot metering target (P133)
- 47 Digital Zoom (P69)
- 48 Picture quality adjustment (P137)

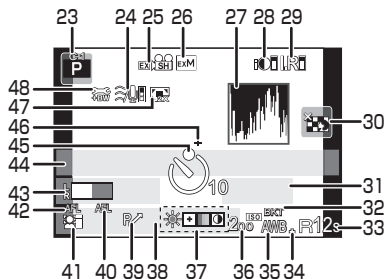

- *1 Only available when a lens that supports the Stabilizer function is attached
- *2 It is possible to switch the display between the number of recordable pictures and available recording time with the [REMAINING DISP.] setting in the [CUSTOM] menu.
- *3 "m" is an abbreviation for minute and "s" for second.
- *4 This is displayed for about 5 seconds when the camera is turned on, after setting the clock and after switching from Playback Mode to Recording Mode.
- *5 This is displayed for about 5 seconds when this unit is turned on in [BABY1]/[BABY2] or [PET] in Scene Mode.
- *6 This is displayed during countdown.

■ In playback

- 1 Playback Mode (P38)
- 2 : Motion picture playback (P46)
- 3 Picture quality adjustment (P137)
- 4 Protected picture (P163)
- 5 Number of prints (P161)
- 6 Picture size (P130)
- REC MODE (when recording motion pictures) (P139)/Recording quality (P140)
- 7 Quality (P131)
- 8 Intelligent Dynamic Range Control (P135)
- 9 Intelligent Resolution (P134)
- 10 Battery indication (P21)
- 11 Picture number/Total pictures
- 12 Motion picture recording time (P46): 8m30s*¹
- 13 Playback (Motion Picture) (P46)
- 14 Delete (P53)
- 15 Multi Playback (P40)
- 16 Display (P39)
- 17 Recording information*²
- 18 Age (P112)
- 19 Favorites settings (P160)
- 20 Name*³ (P112, 122)/Location*³ (P125)/ Title*³ (P152)
- 21 Number of days that have passed since the departure date (P125)
- 22 Stamped with text indication (P153)
- Elapsed playback time (P46): 8m30s*¹
- 23 Favorites (P160)
- Cable disconnection warning icon (P182)
- 24 Folder/File number*² (P181)
- 25 Color space*⁴ (P138)
- 26 Recorded date and time/ World Time (P127)
- 27 Histogram (P39)

*1 "m" is an abbreviation for minute and "s" for second.

*2 This is not displayed for motion pictures recorded in [AVCHD].

*3 It is displayed in order of [TITLE], [LOCATION], [NAME] ([BABY1]/[BABY2], [PET]), [NAME] ([FACE RECOG.]).

*4 This is not displayed for motion pictures recorded in [AVCHD]/[MOTION JPEG].

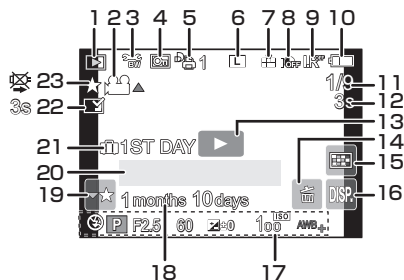

Detailed information display

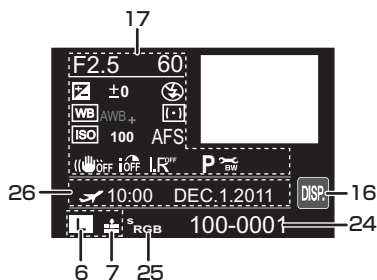

Histogram display

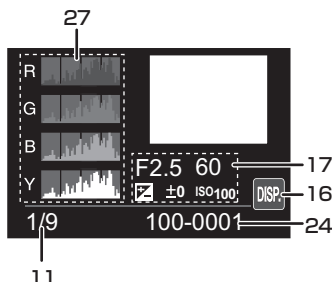

Cautions for Use

Optimal use of the camera

Take care not to drop or knock the unit or put a lot of pressure on it.

- Take care not to knock or drop the bag/case that you inserted the camera in as the shock may cause damage to the camera, lens or LCD monitor.
- Do not use a paper bag as it can easily rip causing the camera to fall and be damaged.
- We strongly recommend you purchase a good camera bag/case from your local dealer to protect your camera.

Keep this unit as far away as possible from electromagnetic equipment (such as microwave ovens, TVs, video games etc.).

- If you use this unit on top of or near a TV, the pictures and/or sound on this unit may be disrupted by electromagnetic wave radiation.
- Do not use this unit near cell phones because doing so may result in noise adversely affecting the pictures and/or sound.
- Recorded data may be damaged, or pictures may be distorted, by strong magnetic fields created by speakers or large motors.
- Electromagnetic wave radiation generated by microprocessors may adversely affect this unit, disturbing the pictures and/or sound.
- If this unit is adversely affected by electromagnetic equipment and stops functioning properly, turn this unit off and remove the battery or disconnect AC adaptor (optional). Then reinsert the battery or reconnect AC adaptor and turn this unit on.

Do not use this unit near radio transmitters or high-voltage lines.

- If you record near radio transmitters or high-voltage lines, the recorded pictures and/or sound may be adversely affected.

Always use the supplied cords and cables. If you use optional accessories, use the cords and the cables supplied with them.**Do not extend the cords or the cables.****Do not spray the camera with insecticides or volatile chemicals.**

- If the camera is sprayed with such chemicals, the body of the camera may be damaged and the surface finish may peel off.
- Do not keep rubber or plastic products in contact with the camera for a long period of time.

Care of the camera

- **Do not strongly shake or bump the camera by dropping or hitting it. Do not subject to strong pressure.**

The camera may malfunction, recording pictures may become impossible, or the lens, the LCD monitor or the external case may be damaged.

- **Be particularly careful in the following places as they may cause this unit to malfunction.**
 - Places with a lot of sand or dust.
 - Places where water can come into contact with this unit such as when using it on a rainy day or on a beach.
- **Do not touch the lens or the sockets with dirty hands. Also, be careful not to allow liquids, sand and other foreign matter to get into the space around the lens, buttons etc.**
- **This camera is not waterproof. If water or seawater splashes on the camera, use a dry cloth to wipe the camera body carefully.**
If the unit does not operate normally, please contact the dealer where you purchased the camera or the repair service center.
- **Do not place your hands inside the mount of the digital camera body. Since the sensor unit is a precision apparatus, it may cause a malfunction or damage.**

About Condensation (When the lens or the LCD monitor is fogged up)

- Condensation occurs when the ambient temperature or humidity changes. Be careful of condensation since it causes lens and LCD monitor stains, fungus and camera malfunction.
- If condensation occurs, turn the camera off and leave it for about 2 hours. The fog will disappear naturally when the temperature of the camera becomes close to the ambient temperature.

Cleaning

Before cleaning the camera, remove the battery or the DC coupler (optional), or disconnect the power plug from the outlet. Then wipe the camera with a dry soft cloth.

- When the camera is soiled badly, it can be cleaned by wiping the dirt off with a wrung wet cloth, and then with a dry cloth.
- Wipe off any dirt or dust on the zoom ring and the focus ring with a dry, dustless cloth.
- Do not use solvents such as benzine, thinner, alcohol, kitchen detergents, etc., to clean the camera, since it may deteriorate the external case or the coating may peel off.
- When using a chemical cloth, be sure to follow the accompanying instructions.

■ About dirt on the image sensor

This camera features an interchangeable lens system so dirt may get inside the camera body when changing lenses. Depending on the recording conditions, dirt on the image sensor may appear on the recorded picture.

Do not change lenses where there is a lot of dust, and always attach the body cap when a lens is not attached to the camera, so that dirt or dust does not get inside the camera body. Remove any dirt on the body cap before attaching it.

Dust reduction function

This unit has a dust reduction function that will blow off the debris and dust that have affixed to the front of the imaging device. This function will function automatically when the camera is turned on, but if you see dust, perform the [SENSOR CLEANING] (P147) in the [CUSTOM] menu.

Removing dirt on the image sensor

The image sensor is very precise and delicate, so be sure to observe the following when you do have to clean it yourself.

- Blow off the dust on the surface of the image sensor with a commercially available blower brush. Be careful not to blow too strongly.
- Do not put the blower brush further inside than the lens mount.
- Do not let the blower brush touch the image sensor as the image sensor may get scratched.
- Do not use any objects except a blower brush to clean the image sensor.
- If you cannot remove the dirt or dust with the blower, consult the dealer or your nearest Service Center.

About the LCD monitor/Optional Live Viewfinder

- Do not press the LCD monitor with excessive force. Uneven colors may appear on the LCD monitor and it may malfunction.
- If the camera is cold when you turn it on, the picture on the LCD monitor/Optional Live Viewfinder will be slightly darker than usual at first. However, the picture will return to normal brightness when the internal temperature of the camera increases.

Extremely high precision technology is employed to produce the LCD monitor/Optional Live Viewfinder screen. However there may be some dark or bright spots (red, blue or green) on the screen. This is not a malfunction. The LCD monitor/Optional Live Viewfinder screen has more than 99.99% effective pixels with a mere 0.01% of the pixels inactive or always lit. The spots will not be recorded on pictures on a card.

About the Lens

- Do not press the lens with excessive force.
- Do not leave the camera with the lens facing the sun as rays of light from the sun may cause it to malfunction. Also, be careful when placing the camera outside or near a window.
- When there is dirt (water, oil, and fingerprints, etc.) on the surface of the lens, the picture may be affected. Lightly wipe the surface of the lens with a soft, dry cloth before and after taking pictures.
- Do not place the lens mount facing downwards. Do not allow the lens mount contacts ① to become dirty.

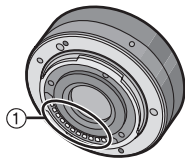

Battery

The battery is a rechargeable lithium ion battery. Its ability to generate power comes from the chemical reaction that takes place inside it. This reaction is susceptible to the surrounding temperature and humidity. If the temperature is too high or too low, the operating time of the battery will become shorter.

Always remove the battery after use.

- Store the removed battery in the battery case (supplied).
- To remove the battery, push it out by putting your finger through the hole in the bottom of the battery case.

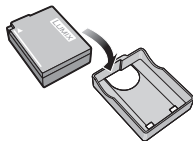

If you drop the battery accidentally, check to see if the body of the battery and the terminals are damaged.

- Inserting a damaged battery in the camera will damage the camera.

Bring charged spare batteries when going out.

- Be aware that the operating time of the battery becomes shorter in low temperature conditions such as at a ski resort.
- When you travel, do not forget to bring the battery charger (supplied) so that you can charge the battery in the country that you are traveling in.

Dispose of unusable battery.

- The battery has a limited life.
- Do not throw the battery into fire because it may cause an explosion.
- The unusable battery should be discarded in accordance with battery recycling laws. Call the RBRC hotline at 1-800-822-8837 for information.

Do not allow battery terminals to come into contact with metal objects (such as necklaces, hairpins etc.).

- This can cause short circuiting or heat generation and you may be badly burned if you touch a battery.

Charger

- If you use the battery charger near a radio, the radio reception may be disturbed.
- Keep the charger 1 m (3.28 feet) or more away from radio.
- The charger may generate whirring sounds when it is being used. This is not a malfunction.
- After use, be sure to disconnect the power supply device from the electrical outlet. (A very small amount of current is consumed if it is left connected.)
- Keep the terminals of the charger and battery clean.

About 3D**■ About 3D recording**

With the 3D interchangeable lens attached, do not record a subject at less than the minimum focus distance.

- The 3D effects may be more pronounced, and therefore cause tiredness or discomfort.
- When the 3D interchangeable lens (H-FT012; optional) is used, the minimum focus distance is 0.6 m (1.97 feet).

When recording with the 3D interchangeable lens attached, be careful not to shake the unit.

- Tiredness or discomfort may result if the shake is pronounced, due to riding in a vehicle or walking etc.
- We recommend using a tripod.

■ About 3D viewing

Anyone who is hyper sensitive to light, suffers from heart disease or is otherwise unwell should avoid viewing 3D pictures.

- Doing may have an adverse affect on such medical conditions.

If you feel tired, uncomfortable or otherwise strange when viewing 3D pictures, stop viewing at once.

- Continuing to view may cause illness.
- Please rest appropriately after stopping the viewing.

When viewing 3D pictures, we recommend taking a break every 30 to 60 minutes.

- Viewing for extended periods may cause eye-fatigue.

Short-sighted or long-sighted persons, those with differences in the sight of their right and left eyes, and those with astigmatism are advised to correct their vision by wearing glasses etc.

Stop viewing if you can clearly see a double image while viewing 3D pictures.

- There are differences in the way that different people experience 3D pictures. Please correct your sight appropriately before viewing 3D pictures.
- You can change the 3D setting of your television or 3D output setting of the unit to 2D.

When viewing 3D pictures on a 3D compatible television, position yourself a distance away that is least 3 times the effective height of the television.

- (Recommended distance): For 42 inch; approx. 1.6 m (5.25 feet), for 46 inch; approx. 1.7 m (5.58 feet), for 50 inch; approx. 1.9 m (6.23 feet), for 54 inch; approx. 2.0 m (6.56 feet).
- Viewing from a distance closer than the recommended distance may lead to eye-fatigue.

Card

Do not leave the card where the temperature is high, where electromagnetic waves or static electricity are easily generated or exposed to direct sunlight.

Do not bend or drop the card.

- The card may be damaged or the recorded content may be damaged or deleted.
- Put the card in the card case or the storage bag after use and when storing or carrying the card.
- Do not allow dirt, dust or water to get into the terminals on the back of the card and do not touch the terminals with your fingers.

Notice for when transferring to another party, or disposing of the memory card

- “Format” or “delete” using the camera or a PC will only modify the file management information, and it will not erase the data in the memory card completely.

It is recommended to physically destroy the memory card or use the commercially available computer data deletion software to completely erase the data in the memory card before transferring to another party or disposing.

Management of data in the memory card is the responsibility of the user.

About the personal information

If a name or birthday is set for [BABY1]/[BABY2]/Face Recognition function, this personal information is kept in the camera and recorded in the image.

Disclaimer

- Information including personal information may be altered or vanish due to erroneous operation, effect of static electricity, accident, malfunction, repair, or other handlings. Please note in advance that Panasonic is not liable in any way for any direct or indirect damage from the alteration or vanishing of information or personal information.

When requesting a repair, transferring to another party or disposing

- Reset the settings to protect the personal information. (P66)
- Remove the memory card from the camera when requesting a repair.
- Settings may return to factory default when camera is repaired.
- Please contact the dealer where you purchased the camera or your nearest Service Center if above operations are not possible due to malfunction.

When transferring to another party, or disposing of the memory card, please refer to “Notice for when transferring to another party, or disposing of the memory card” on

P201.

When not using the camera for a long period of time

- Store the battery in a cool and dry place with a relatively stable temperature: (Recommended temperature: 15 °C to 25 °C (59 °F to 77 °F), Recommended humidity: 40%RH to 60%RH)
- Always remove the battery and the card from the camera.
- If the battery is left inserted in the camera, it will discharge even if the camera is turned off. If the battery continues to be left in the camera, it will discharge excessively and may become unusable even if charged.
- When storing the battery for a long period of time, we recommend charging it once a year. Remove the battery from the camera and store it again after it has completely discharged.
- We recommend storing the camera with a desiccant (silica gel) when you keep it in a closet or a cabinet.
- **Check all the parts before taking pictures when you have not used the camera for a long period of time.**

About the picture data

- Recorded data may be damaged or lost if the camera breaks down due to inappropriate handling. Panasonic will not be liable for any damage suffered due to loss of recorded data.

About tripods or unipods

- When you use a tripod, make sure the tripod is stable when this unit is attached to it.
- You may not be able to remove the card or the battery when using a tripod or unipod.
- Make sure that the screw on the tripod or unipod is not at an angle when attaching or detaching the camera. You may damage the screw on the camera if you use excessive force when turning it. Also, the camera body and the rating label may be damaged or scratched if the camera is attached too tightly to the tripod or unipod.
- When using this unit with a large-diameter lens, the lens may come into contact with the pedestal depending on the tripod/unipod. Tightening the screw with the lens and pedestal in contact with each other may damage this unit or the lens. Therefore it is recommended to attach the tripod adaptor (DMW-TA1; optional) before mounting on the tripod/unipod.
- Read the operating instructions for the tripod or unipod carefully.

About the shoulder strap

- If you attach a heavy interchangeable lens (more than about 1 kg/35.3 oz) to the camera body, do not carry the camera by the shoulder strap. Hold the camera and the lens when carrying them.

Message Display

Confirmation messages or error messages will be displayed on the screen in some cases. The major messages are described below as examples.

[THIS PICTURE IS PROTECTED]

→ Delete the picture after canceling the protect setting. (P163)

[THIS PICTURE CANNOT BE DELETED]/[SOME PICTURES CANNOT BE DELETED]

- This feature is can only be used with pictures that comply with the DCF standard.
 - If you want to delete some pictures, format the card after saving necessary data on a PC etc. (P66)

[NO ADDITIONAL SELECTIONS CAN BE MADE]

- The number of pictures, which can be set at one time when [MULTI] has been selected for [DELETE MULTI] (P54), [FAVORITE] (P160), [TITLE EDIT] (P152), [TEXT STAMP] (P153) or [RESIZE] (P156) has been exceeded.
 - Reduce the number of pictures set, and then repeat the operation.
- More than 999 favorites have been set.

[CANNOT BE SET ON THIS PICTURE]

- [TITLE EDIT], [TEXT STAMP] or [PRINT SET] cannot be set for pictures not based on the DCF standard.

[MEMORY CARD ERROR FORMAT THIS CARD?]

- It is a format that cannot be used with this unit.
 - Format the card again with the camera after saving necessary data on a PC etc. (P66)

[LENS NOT FOUND, OR SHOOT W/O LENS IS SET TO OFF.]/ [THE LENS IS NOT ATTACHED PROPERLY. DO NOT PUSH LENS RELEASE BUTTON WHILE LENS IS ATTACHED.]/ [PLEASE CHECK THAT THE LENS IS ATTACHED CORRECTLY]

- Do not press the lens release button while taking pictures.
- When using a Leica lens mount adaptor (DMW-MA2M, DMW-MA3R; optional), set [SHOOT W/O LENS] (P147) to [ON] in the custom menu.
- Detach the lens once, and then attach it again without pressing the lens release button. (P15)
Turn on the power again, and if it is still displaying, contact the dealer.

[MEMORY CARD PARAMETER ERROR]/[THIS MEMORY CARD CANNOT BE USED]

- Use a card compatible with this unit. (P25)
- SD Memory Card (8 MB to 2 GB)
- SDHC Memory Card (4 GB to 32 GB)
- SDXC Memory Card (48 GB, 64 GB)

[INSERT SD CARD AGAIN]/[TRY ANOTHER CARD]

- An error has occurred accessing the card.
 - Insert the card again.
 - Insert a different card.

[READ ERROR/WRITE ERROR PLEASE CHECK THE CARD]

- It has failed to read or write data.
 - Remove the card after turning the power [OFF]. Insert the card again, turn the power on, and try to read or write the data again.
- The card may be broken.
 - Insert a different card.

[CANNOT RECORD DUE TO INCOMPATIBLE FORMAT (NTSC/PAL) DATA ON THIS CARD.]

- If you want to delete some pictures, format the card after saving necessary data on a PC etc. (P66)
- Insert a different card.

[MOTION RECORDING WAS CANCELLED DUE TO THE LIMITATION OF THE WRITING SPEED OF THE CARD]

- Use a card with SD Speed Class with "Class 4" or higher when recording motion pictures in [AVCHD].
Also, use a card with SD Speed Class with "Class 6" or higher when recording motion pictures in [MOTION JPEG].
- In the event that it stops even after using a "Class 4" card or higher, the data writing speed has deteriorated so it is recommended to make a backup and then format (P66).
- Depending on the type of the card, motion picture recording may stop in the middle.

[THIS CARD IS NOT FORMATTED WITH THIS CAMERA, AND NOT SUITABLE FOR MOVIE RECORDING.]

- The writing speed is lower if the card has been formatted using a PC or other equipment. As a consequence, motion picture recording may stop in the middle. If this happens, make a backup of the data and format (P66) the card in this unit.

[A FOLDER CANNOT BE CREATED]

- A folder cannot be created because there are no remaining folder numbers that can be used. (P181)
 - Format the card after saving necessary data on a PC etc. (P66) If you execute [NO.RESET] in the [SETUP] menu after formatting, the folder number is reset to 100. (P66)

[PICTURE IS DISPLAYED FOR 16:9 TV]/[PICTURE IS DISPLAYED FOR 4:3 TV]

- The AV cable is connected to the camera.
 - Press [MENU/SET] if you want to delete this message at once.
 - Select [TV ASPECT] in the [SETUP] menu if you want to change the TV aspect. (P63)
- This message also appears when the USB connection cable is connected to the camera only. In this case, connect the other end of the USB connection cable to a PC or a printer. (P179, 182)

[THIS BATTERY CANNOT BE USED]

- The battery cannot be recognized by the camera.
 - Use a genuine Panasonic battery. If this message is displayed even when a genuine Panasonic battery is used, contact the dealer or your nearest Service Center.
- The battery cannot be recognized as its terminal is dirty.
 - Remove any dirt etc. from the terminal.

Troubleshooting

First, try out the following procedures (P206–217).

If the problem is not resolved, it may be improved by selecting **[RESET] (P66)** on the **[SETUP]** menu.

Battery and power source

**The camera cannot be operated even when it is turned on.
The camera turns off immediately after it is turned on.**

- The battery is exhausted.
- Charge the battery.
- If you leave the camera on, the battery will be exhausted.
 - Turn the camera off frequently by using the **[ECONOMY]** Mode etc. (P62)

This unit is turned off automatically.

- If you connect to a TV compatible with VIERA Link with a HDMI mini cable (optional) and turn off the power on the TV with the remote control for the TV, the power on this unit also turns off.
 - If you are not using VIERA Link, set **[VIERA Link]** to **[OFF]**. (P64)

The [CHARGE] lamp flashes.

- Is the temperature of the battery excessively high or low? If it is, it will take longer than usual to charge the battery or charging may remain incomplete.
- Are the terminals of the charger or battery dirty?
 - Wipe off the dirt using a dry cloth.

Recording

Taking pictures is not possible.**The shutter will not operate immediately when the shutter button is pressed.**

- Is the subject focused?
 - [FOCUS PRIORITY] is set to [ON] at the time of purchase, and so you cannot take pictures until the subject is in focus. If you want to be able to take a picture when you press the shutter button fully even if the subject is not focused, set [FOCUS PRIORITY] in the [CUSTOM] menu to [OFF]. (P144)
- You may not be able to record for a short while after turning the power [ON] when using a large capacity card.

The recorded picture is whitish.

- Picture might look whitish when lens or image sensor gets dirty with finger print or similar.
 - If the lens is dirty turn the camera off and then gently wipe the lens surface with a soft dry cloth.
 - Refer to P197 when the image sensor gets dirty.

The recorded picture is too bright or dark.

- Check that the exposure is correctly compensated. (P78)
- Is the AE Lock (P105) applied incorrectly?

Multiple pictures are taken at one time.

- Unset the settings of White Balance Bracket (P97).

The subject is not focused properly.

- The subject is beyond the focus range of the camera. (P33)
- There is camera shake (jitter) or the subject is moving slightly. (P77)
- Is [FOCUS PRIORITY] in the [CUSTOM] menu set to [OFF]? (P144)
In this case, the picture may not be properly focused even if [AFS] or [AFC] in [FOCUS MODE] is set.
- Is the AF Lock (P105) applied incorrectly?

The recorded picture is blurred.**The Optical Image Stabilizer is not effective.**

- The shutter speed will become slower and the Optical Image Stabilizer function may not work properly when taking pictures especially in dark places.
 - We recommend holding the camera firmly with both hands when taking pictures. (P35)
 - We recommend using a tripod and the self-timer (P83) when taking pictures with a slow shutter speed.
- Are you using a lens which supports the Stabilizer function? (P76)

Taking pictures using White Balance Bracket is not possible.

- Is there any memory remaining on the card?

The recorded picture looks rough. Noise appears on the picture.

- Is the ISO sensitivity high or the shutter speed slow?
(ISO sensitivity is set to [AUTO] when the camera is shipped. Therefore, when taking pictures indoors etc. noise will appear.)
 - Decrease the ISO sensitivity. (P98)
 - Increase the setting for [NOISE REDUCTION] in [PICTURE ADJUST] or lower the setting for each of the items other than [NOISE REDUCTION]. (P137)
 - Take pictures in bright places.
 - Set the [LONG SHTR NR] to [ON]. (P136)
- Is the [PICTURE SIZE] (P130) or the [QUALITY] (P131) set low?
- Is the [DIGITAL ZOOM] set? (P69)

Under fluorescent lighting, flicker or horizontal bars may be seen.

- This is characteristic of MOS sensors which serve as the camera's pickup sensors.
This is not a malfunction.
- When you see noticeable flicker or striping while recording a motion picture, you can reduce the flicker or striping by setting up [FLICKER RED.] (P141) and fixing the shutter speed. It is possible to select a shutter speed from [1/50], [1/60], [1/100], or [1/120].



The brightness or the hue of the recorded picture is different from the actual scene.

- If recording under fluorescent light, the brightness or the hue may change slightly when the shutter speed becomes fast. This occurs due to the characteristics of fluorescent light. It is not a malfunction.
- Color or brightness of the screen may change or horizontal streaks may appear on the screen when the picture is taken under extremely bright light, or under fluorescent lamps, mercury lamps, or sodium lamps etc.

Reddish horizontal streaks appear on the LCD monitor during recording.

- This is characteristic of MOS sensors which serve as the camera's pickup sensors. It appears when the subject has a bright part. Some unevenness may occur in the surrounding areas, but this is not a malfunction.
It is recorded in motion pictures but is not recorded on still pictures.
- It is recommended that you take pictures while taking care not to expose the screen to sunlight or any other source of strong light.

Bright spot not in subject is recorded.

- This could be an inactive pixel. Perform the [PIXEL REFRESH] (P147) in the [CUSTOM] menu.

You cannot compensate the exposure.

- Are you in Exposure Compensation operation?
→ Press the rear dial to switch to Exposure Compensation operation. (P78)

**Subject cannot be locked.
(AF tracking not possible)**

- Set the AF area to the distinctive color of the subject if there is a part that is different from the surrounding color. (P87)

Motion pictures

Motion picture recording stops in the middle.

- Use a card with SD Speed Class with “Class 4” or higher when recording motion pictures in [AVCHD]. Also, use a card with SD Speed Class with “Class 6” or higher when recording motion pictures in [MOTION JPEG].
- Depending on the type of the card, recording may stop in the middle.
 - If motion picture recording stops during use of a card of at least “Class 4” or if you use a card on which recording and deleting have been repeated many times, or a card that has been formatted on a PC or other equipment, the data-writing speed is lower. In such cases, we recommend that you make a backup of the data and then format (P66) the card in this unit.

When recording a motion picture, the screen may go dark.

- When recording a motion picture, the screen may go dark after a certain period to reduce battery consumption, but this will not affect the recorded motion picture.

The screen may be blacked out momentarily, or the unit may record noise.

- The screen may be blacked out momentarily, or the unit may record noise due to static electricity or electromagnetic waves etc. depending on the environment of the motion picture recording.

Object seems to be warped.

- Object seems to be warped slightly when the object moves across the image very fast, but this is because the unit is using MOS for the image sensor. This is not a malfunction.

In motion pictures, abnormal clicking and buzzing sounds are recorded.

- With recording in a quiet environment, depending on the lenses used, the sound of aperture and focus actions may be recorded in motion pictures. This is not a malfunction. Focus operation while recording motion pictures can be set to [OFF] with [CONTINUOUS AF] (P43).
- Be careful while recording motion pictures because the sounds of the zoom operations, buttons and dial operation etc. may be recorded.

Lens

Recorded image may be warped, or nonexistent color is surrounding the subject.

- Depending on the lens used, picture may be warped slightly or you may see colors along the edge depending on the zoom factor, due to the characteristics of the lens. Also, the peripherals of the image might look warped because the perspective is enhanced when the wide angle is used. This is not a malfunction.

When the lens is attached to another digital camera, stabilizer function cannot be turned off or stabilizer function does not work.

- The Optical Image Stabilizer function of the interchangeable lens (H-FS014042) only works correctly with supported cameras.
 - When older Panasonic digital cameras (DMC-GF1, DMC-GH1, DMC-G1) are used, [STABILIZER] in the [REC] Mode menu (P76) cannot be set to [OFF]. It is recommended to update the firmware of the digital camera at the following website.
<http://panasonic.jp/support/global/cs/dsc/download/>
 - When using this lens with another make of digital cameras, the Optical Image Stabilizer function will not work. (As of December 2010)
For details, contact the respective company.

Flash

The flash is not activated.

- Is the flash closed?
 - Press the [ OPEN] button to open the flash. (P71)

The flash is activated 2 times.

- The flash is activated 2 times. The interval between the first and second flash is longer when Red-eye Reduction (P73) is set so the subject should not move until the second flash is activated.

LCD monitor/Optional Live Viewfinder

The LCD monitor turns off although the camera is turned on.

- The LCD monitor turns off when [AUTO LCD OFF] (P62) is selected for the [ECONOMY] Mode. [This does not happen when using the AC adaptor (optional).]

The LCD monitor/Optional Live Viewfinder is too bright or dark.

- Adjust the brightness of the LCD monitor/Optional Live Viewfinder to a proper level. (P61)
- Check [LCD MODE] setting. (P61)

It may flicker for an instant or the brightness of the screen may change significantly for an instant.

- This occurs due to the aperture of the lens changing when the shutter button is pressed half-way, or when the brightness of the subject changes. This is not a malfunction.
- This may occur more often when a bright lens, such as the interchangeable lens (H-H014), is used for recording in brightly lit outdoor environments.

The picture is not displayed on the LCD monitor.

- Does the picture appear on the Optional Live Viewfinder?
→ Switch to LCD monitor display by pressing [LVF/LCD] on the Optional Live Viewfinder (P188).

The picture does not switch between LCD monitor and Optional Live Viewfinder when [LVF/LCD] is pressed on the Optional Live Viewfinder (P188).

- It is only displayed on the LCD monitor when the camera is connected to a PC or printer.

Black, red, blue and green dots appear on the LCD monitor.

- This is not a malfunction.
These pixels do not affect the recorded pictures.

Noise appears on the LCD monitor.

- In dark places, noise may appear to maintain the brightness of the LCD monitor.

You see red, green, or blue flashes when you move your eyes in the Optional Live Viewfinder (P188), or when the camera is moved rapidly.

- This is a characteristic of the drive system of the Optional Live Viewfinder (P188) of this unit, and it is not a malfunction. There will be no problem with the recorded image.

Playback

The picture being played back is not rotated, or is rotated in an unexpected direction, when displayed.

- You can display the pictures without being rotated when [ROTATE DISP.] (P159) is set to [OFF].
- You can rotate pictures with the [ROTATE] function. (P159)
- You can only display the pictures rotated if you use a lens (P12) that supports the Direction Detection Function (P35) and [ROTATE DISP.] is set to [ON].

The picture is not played back. There are no recorded pictures.

- Did you press [▶]?
- Is the card inserted?
- Is there a picture on the card?
- Is this a picture whose file name has been changed in the PC? If it is, it cannot be played back by this unit.
- Has [PLAYBACK MODE] been set for playback?
→ Change to [NORMAL PLAY]. (P151)

The folder number and the file number are displayed as [—] and the screen turns black.

- Is this a non-standard picture, a picture which has been edited using a PC or a picture which was taken by another make of digital camera?
- Did you remove the battery immediately after picture-taking or did you take the picture using a battery with a low remaining charge?
→ Format the data to delete the pictures mentioned above. (P66)
(Other pictures will be deleted as well and it will not be possible to restore them. Therefore, check well before formatting.)

Images with different date as recorded date are played back in the Calendar Playback.

- Is the clock in the camera set properly? (P60)
- Images edited on a PC or images recorded on other cameras might display a different date to the recorded date during the Calendar Playback.

White round spots like soap bubbles appear on the recorded picture.





- If you take a picture with the flash in a dark place or indoors, white round spots may appear on the picture caused by the flash reflecting of particles of dust in the air. This is not a malfunction. A characteristic of this is that the number of round spots and their position differ in every picture.



[THUMBNAIL IS DISPLAYED] appears on the screen.

- Is it a picture that has been recorded with other equipment? In such cases, these pictures may be displayed with a deteriorated picture quality.

Red part of the recorded image has changed color to black.

- When Digital Red-Eye Correction ([, [, []) is in operation, if you take a picture of subject with red color surrounded by a skin tone color, that red part may be corrected to black by the Digital Red-Eye Correction function.
 - It is recommended to take pictures with the flash closed, Flash Mode set to [] or [, or [RED-EYE REMOVAL] set to [OFF]. (P134)

TV, PC and printer**The picture does not appear on the television.**

- Is the camera connected to the TV correctly?
 - Set the TV input to external input mode.
- Output from the [HDMI] socket is not possible when it is connected to the PC or the printer.
 - Connect it only to the TV.

The display areas on the TV screen and the camera's LCD monitor are different.

- Depending on the TV model, the pictures may be extended horizontally or vertically or they may be displayed with their edges cut off.

The motion pictures cannot be played back on a TV.

- Are you trying to play back the motion pictures by directly inserting the card in the card slot of the TV?
 - Connect the camera to the TV with the AV cable (supplied), or with the HDMI mini cable (optional), and then play back the motion pictures on the camera. (P169, 171)
 - Motion pictures recorded in [AVCHD] can be played back on Panasonic televisions (VIERA) with the AVCHD logo.

The picture is not displayed fully on the TV.

- Check [TV ASPECT] setting. (P63)

VIERA Link does not work.

- Is it connected properly with the HDMI mini cable (optional)? (P171)
 - Confirm that the HDMI mini-cable (optional) is firmly fitted.
 - Press [▶] on this unit.
- Is the [VIERA Link] on this unit set to [ON]? (P64)
 - Depending on HDMI terminal of the TV, the input channel may not switch automatically. In this case, use the remote control for the TV to switch input. (For details on how to switch input, please read the operating instructions for the TV.)
 - Check the VIERA Link setting on the connected device.
 - Turn the power to the unit off and then back on again.
 - Set [VIERA Link] to [Off] on the TV and then turn it back to [On]. (Refer to the operating instructions of the TV for details.)

The picture cannot be transferred when the camera is connected to a PC.

- Is the camera connected to the PC correctly?
- Is the camera recognized by the PC correctly?
 - Set to [PC] in [USB MODE]. (P63, 179)

The card is not recognized by the PC.

- Disconnect the USB connection cable. Connect it again while the card is inserted in the camera.

The card is not recognized by the PC. (SDXC memory card is used)

- Check if your PC is compatible with SDXC memory cards.
<http://panasonic.net/avc/sdcard/information/SDXC.html>
- A message prompting to format the card may be displayed when connecting, but do not format.
- If the [ACCESS] displayed on the LCD monitor does not disappear, disconnect the USB connection cable after turning off the power.

The picture cannot be printed when the camera is connected to a printer.

- Pictures cannot be printed using a printer which does not support PictBridge.
 - Set to [PictBridge(PTP)] in [USB MODE]. (P63, 182)

The ends of the pictures are cut at printing.

- When using a printer with a Cropping or borderless printing function, cancel this function before printing. (For details, refer to the operating instructions for the printer.)
- When you order photo studios to print pictures, ask the photo studio if the pictures can be printed with both ends.

Others

The camera makes a noise when turned [ON].

- This is the noise of the Dust Reduction Function working (P197); it is not a malfunction.

There is a sound from lens unit.

- It is a sound of lens movement or aperture operation when the power is turned [ON] or [OFF], and it is not a malfunction.
- You may hear a sound from the lens and image in the LCD monitor may suddenly change when the brightness has changed by zoom operation or moving the camera, but there is no effect on recording.
The sound is caused by the automatic adjustment of the aperture. This is not a malfunction.

An unreadable language was selected by mistake.

- Press [MENU/SET], select the [SETUP] menu icon [🔍] and then select the [🌐] icon to set the desired language. (P65)

Part of the picture is flashing in black and white.

- This is a highlight function showing the white saturated area. (P142)
- Is the [HIGHLIGHT] set to [ON]?

A red lamp sometimes turns on when the shutter button is pressed halfway.

- In dark places, the AF Assist Lamp (P144) lights red to make it easier to focus on a subject.

The AF Assist Lamp does not turn on.

- Is [AF ASSIST LAMP] on the [CUSTOM] menu set to [ON]? (P144)
- The AF Assist Lamp does not turn on in bright places.

The camera becomes warm.

- The surface of the camera may become warm during use. This does not affect the performance or quality of the camera.

The clock is reset.

- If you do not use the camera for a long time, the clock may be reset.
→ [PLEASE SET THE CLOCK] message will be displayed; please re-set the clock. When taking pictures, it will not be possible to record the correct date without setting the clock. (P60)

The file numbers are not recorded consecutively.

- When you perform an operation after taking a certain action, the pictures may be recorded in folders with different numbers from the ones used prior to the operation. (P181)

The file numbers are recorded in ascending order.

- If the battery was inserted or removed without first turning the camera's power off, the folder and file numbers for the pictures taken will not be stored in the memory. When the power is then turned back on and pictures are taken, they may be stored under file numbers which should have been assigned to previous pictures.

Age is not displayed correctly.

- Check the clock (P28) and birthday settings (P112).

A different thing gets selected from what you touched.

- Perform the calibration (P65).

- G MICRO SYSTEM is a lens exchange type digital camera system of LUMIX based on a Micro Four Thirds System standard.
- Micro Four Thirds™ and Micro Four Thirds Logo marks are trademarks or registered trademarks of Olympus Imaging Corporation, in Japan, the United States, the European Union and other countries.
- Four Thirds™ and Four Thirds Logo marks are trademarks or registered trademarks of Olympus Imaging Corporation, in Japan, the United States, the European Union and other countries.
- SDXC Logo is a trademark of SD-3C, LLC.
- The "AVCHD" and the "AVCHD" logo are trademarks of Panasonic Corporation and Sony Corporation.
- Manufactured under license from Dolby Laboratories. Dolby and the double-D symbol are trademarks of Dolby Laboratories.
- HDMI, the HDMI Logo, and High-Definition Multimedia Interface are trademarks or registered trademarks of HDMI Licensing LLC in the United States and other countries.
- HDAVI Control™ is a trademark of Panasonic Corporation.
- QuickTime and the QuickTime logo are trademarks or registered trademarks of Apple Inc., used under license therefrom.
- Adobe is a trademark or registered trademark of Adobe Systems Incorporated in the United States and/or other countries.
- Microsoft product screen shot(s) reprinted with permission from Microsoft Corporation.
- Other names, company names, and product names printed in these instructions are trademarks or registered trademarks of the companies concerned.

This product is licensed under the AVC patent portfolio license for the personal and non-commercial use of a consumer to (i) encode video in compliance with the AVC Standard ("AVC Video") and/or (ii) decode AVC Video that was encoded by a consumer engaged in a personal and non-commercial activity and/or was obtained from a video provider licensed to provide AVC Video. No license is granted or shall be implied for any other use. Additional information may be obtained from MPEG LA, LLC. See <http://www.mpegla.com>.

