

Panasonic[®]

Owner's Manual for advanced features

Digital Camera

Model No. **DMC-G85**



LUMIX

Please read these instructions carefully before using this product,
and save this manual for future use.

Message Display

P318

Troubleshooting

P320

Finding the information you need

P2

Contents

P4

Contents by Function

P9

Menu list

P185

Register online at <http://shop.panasonic.com/support>
(U.S. customers only)

DVQP1003ZA



F0916HN0



Finding the information you need

In this “Owner’s Manual for advanced features”, you can find the information you need from the following pages.

By clicking a page number, you can jump to the linked page and quickly find the information.

	Search from “Contents”	P4
	Click this icon to jump to “Contents”.	
	Search from the list of function names	P9
	Search from the list of buttons and dials	P14
	Search from the list of screens and icons	P311
	Search from “Message Display”	P318
	Search from “Menu list”	P185
	Click this icon to jump to “Menu list”.	
	Search from “Troubleshooting”	P320



1

Click this icon to jump to “Finding the information you need”.



4

Click this icon to return to the previously displayed page.

For details on how to use this manual, see the next page.

P3

Wi-Fi® function

P249

How to use this manual

About the indication of the applicable mode

Applicable modes: 

The icons indicate the modes available for a function.

- Black icons: Applicable modes
- Gray icons: Unavailable modes

C1 and **C2** will differ depending on the Recording Modes registered under custom settings.

About the symbols in the text

MENU: Indicates that the menu can be set by pressing [MENU/SET] button.

Wi-Fi: Indicates that the Wi-Fi setting can be made by pressing [Wi-Fi] button.

: Tips for skillful use and points for recording.



: Conditions in which a particular function cannot be used.

: Continued to next page.

- Click a cross reference in the text to jump to the corresponding page.

In this owner's manual, steps for setting a menu item are described as follows.

Example: In the [Rec] menu, change [Quality] from  to .

MENU →  [Rec] → [Quality] → .

- Description in this owner's manual is based on the interchangeable lens (H-FS12060).

Contents

Finding the information you need	2
How to use this manual	3
Contents by Function	9

1. Before Use

Care of the camera	12
Standard Accessories	13
Names and Functions of Components	14
About the Lens	17

2. Getting Started/Basic Operations

Attaching the Shoulder Strap	18
Charging the Battery	19
• Charging	19
• Approximate operating time and number of recordable pictures	21
Inserting/Removing the Battery	24
Inserting/Removing the Card (Optional)	25
Card Information	26
• Formatting the card (initialization)	27
• Approximate number of recordable pictures and available recording time	28
Attaching/Removing the Lens	30
Opening the Monitor/Adjusting the Monitor	33
Setting Date/Time (Clock Set)	34
• Re-adjusting the clock	35
Basic Operations	36
• Tips for taking good pictures	36
• Using the Viewfinder	37
• Shutter button (Taking pictures)	39
• Motion picture button (Recording motion pictures)	39
• Mode dial (Selecting a Recording Mode)	40
• Front Dial/Rear Dial	41
• Cursor buttons/[MENU/SET] button	44
• [DISP.] button (Switching the displayed information)	45
• Touch screen (Touch operations)	48
• Taking Pictures Using the Touch Function	49
Setting menu items	51
Calling frequently-used menus instantly (Quick Menu)	53
• Customizing the Quick Menu settings	54
Assigning frequently used functions to the buttons (function buttons)	55
Entering Text	58

3. Recording Modes

Taking Pictures using the Automatic Function (Intelligent Auto Mode).....	59
• Taking handheld shots of night scenes ([iHandheld Night Shot])	62
• Combining pictures into a single picture with rich gradation ([iHDR]).....	63
• Taking a picture with a blurred background (Defocus Control).....	64
• Recording images by changing the brightness or color tone	65
Taking Pictures with Automatically Adjusted Aperture and Shutter Speed (Program AE Mode)	66
Taking Pictures by Specifying the Aperture/Shutter Speed	68
• Aperture-Priority AE Mode	69
• Shutter-Priority AE Mode.....	69
• Manual Exposure Mode	70
• Confirm the Effects of Aperture and Shutter Speed (Preview Mode)	72
• Easily set aperture/shutter speed for suitable exposure (One Push AE)	73
Taking Pictures that match the Scene being recorded (Scene Guide Mode).....	74
• Taking panorama pictures ([iPanorama Shot])	77
Taking Pictures with different image effects (Creative Control Mode).....	79
Recording motion pictures with manually set aperture value/shutter speed (Creative Video Mode)	85
• Minimizing operational sounds during motion picture recording	86
Registering your preferred settings (Custom Mode)	87
• Registering Personal Menu Settings (Registering custom settings)	87
• Recording using registered custom set	88

4. Focus, Brightness (Exposure) and Color tone Settings

Adjusting Focus Automatically	89
• Focus Mode (AFS/AFF/AFC)	91
• Auto Focus Mode	93
• Setting up position of the AF area/changing size of the AF area	98
• Setting the AF area position with the Touch Pad.....	100
• Optimizing the focus and brightness for a touched position	101
Adjusting Focus Manually	102
Fixing the Focus and the Exposure (AF/AE Lock)	105
Compensating the Exposure.....	106
Setting the Light Sensitivity.....	108
Adjusting the White Balance	110

5. 4K Photo and Drive Settings

Select a Drive Mode.....	114
Taking Pictures using Burst Mode.....	115
Recording 4K Photos	118
• Notes on the 4K Photo function.....	122
Selecting pictures from 4K burst file and saving	125

Controlling Focus After Recording (Post Focus/Focus Stacking)	129
• Recording with the Post Focus function	130
• Selecting the desired focus area and saving a picture	132
• Merging multiple pictures to widen the focus range (Focus Stacking).....	133
Taking Pictures with the Self-timer	135
Taking Pictures with Time Lapse Shot/Stop Motion Animation	136
• Taking Pictures Automatically at Set Intervals ([Time Lapse Shot])	136
• Creating Stop Motion Pictures ([Stop Motion Animation])	138
• Creating motion pictures from recorded pictures	140
Taking Pictures While Adjusting a Setting Automatically (Bracket Recording)	141
• Exposure Bracket	142
• Aperture Bracket	143
• Focus Bracket	143

6. Stabilizer, Zoom and Flash

Image Stabilizer.....	144
Taking Pictures with the Zoom	148
• Raising the telescopic effect.....	149
• Zooming using touch operations (Touch zoom)	153
Taking pictures by using the flash	154
Setting the Flash Functions	156
• Changing the firing mode	156
• Changing Flash Mode	157
• Setting to the 2nd Curtain Synchro.....	159
• Adjust the flash output.....	160
• Synchronizing the output of the flash to the Exposure Compensation	160
Taking Pictures with Wireless Flashes.....	161
• Using other settings for wireless flash recording.....	163

7. Recording Motion Pictures

Recording Motion Picture/4K Motion Picture	164
• Setting the format, size and recording frame rate	166
• How to set focus when recording a motion picture ([Continuous AF])	168
Recording Motion Pictures that Pan and Zoom While Maintaining a Fixed Camera Position ([4K Live Cropping]).....	169
Recording still pictures while recording motion pictures	172
Recording Snap Movies	174

8. Playing Back and Editing Images

Playing Back Pictures	177
Playing Back Motion Pictures.....	178
• Creating Still Pictures from a Motion Picture	179
Switching the Playback Method	180
• Using the Playback Zoom	180
• Displaying multiple screens (Multi Playback)	181

• Displaying Pictures by Recording Date (Calendar Playback)	181
Playing Back Group Pictures	182
Deleting Pictures	184

9. Using Menu Functions

Menu list.....	185
• [Rec] menu	185
• [Motion Picture] menu	206
• [Custom] menu	209
• [Setup] menu	219
• [Playback] menu.....	227

10. Using the Wi-Fi function

What you can do with the Wi-Fi® function.....	249
Wi-Fi function	250
Controlling with a Smartphone/Tablet	252
• Installing the smartphone/tablet app “Image App”	252
• Connecting to a smartphone/tablet.....	253
• Taking images via a smartphone/tablet (remote recording).....	257
• Playing back images in the camera.....	258
• Saving images stored in the camera	258
• Sending images in the camera to an SNS	259
• Adding location information to images stored in the camera from a smartphone/tablet	259
• Combining motion pictures recorded with Snap Movie according to your preference on a smartphone/tablet	261
Displaying pictures on a TV	262
Sending images	263
Sending images to a smartphone/tablet.....	267
Printing Wirelessly.....	268
Sending images to AV device	269
Sending images to PC	270
Using Web services	272
• When sending images to web service.....	272
• When sending images to [Cloud Sync. Service]	275
Registering to the “LUMIX CLUB”	276
• About the [LUMIX CLUB]	276
About Connections.....	280
• Connecting via a wireless access point (via the network).....	281
• Connecting the camera and another device directly (direct connection).....	283
• Connecting quickly with the same settings as the previous ones ([Select a destination from History]/[Select a destination from Favorite])	284
[Wi-Fi Setup] Menu	286

11. Connecting to other equipment

Watching 4K motion pictures on a TV/ Saving 4K motion pictures on your PC or recorder	288
• Watching motion pictures in 4K	288
• Storing 4K motion pictures	289
Playing Back Pictures on a TV Screen	290
• Using VIERA Link (HDMI)	293
Saving still pictures and motion pictures on your PC	294
• Downloading software	295
• Transferring images to a PC	297
Saving still pictures and motion pictures on a Recorder	299
Printing the Pictures	300
Enjoying 3D pictures	303

12. Others

Optional accessories	306
Monitor Display/Viewfinder Display	311
Message Display	318
Troubleshooting	320
Cautions for Use	329

Contents by Function



Recording

Recording

Recording Mode	P40
[Preview]	P72
[Panorama Shot]	P77
[Time Lapse Shot]	P136
[Stop Motion Animation]	P138
Aperture Bracket	P143
Focus Bracket	P143
[Multi Exp.]	P196
[Silent Mode]	P209
3D recording	P303

4K photo

[4K PHOTO]	P118
[Post Focus]	P129

Focus (AF/MF)

[Focus Mode]	P91
[AF Mode]	P93
Adjusting the AF area position	P98
Manual Focus	P102
[AF/AE Lock]	P105

Drive

[Drive Mode]	P114
[Burst]	P115
Maximum number of pictures that can be taken continuously	P116
[Self Timer]	P135

Picture Quality and Color Tone

[Sensitivity]	P108
[White Balance]	P110
[Photo Style]	P186
[Filter Settings]	P188
[Picture Size]	P190
[Quality]	P191
[Highlight Shadow]	P193
[i.Dynamic]	P194
[i.Resolution]	P194
[HDR]	P195
[Long Shtr NR]	P200
[Shading Comp.]	P200
[Diffraction Compensation]	P201
[Color Space]	P201

Exposure

[Touch AE]	P50
[One Push AE]	P73
[AF/AE Lock]	P105
Exposure Compensation	P106
Exposure Bracket	P142
[Metering Mode]	P192

Stabilizer

Dual I.S.	P144
5-Axis Hybrid Image Stabilizer	P144

Flash

[Flash Mode]	P157
2nd curtain synchro	P159
[Flash Adjust.]	P160
Wireless flash settings	P161

Monitoring

HDMI output while recording	P291
-----------------------------------	------



Motion Picture

Motion Picture

Creative Video Mode	P85
[Silent Operation]	P86
[Rec Format]	P166
[Rec Quality]	P166
Motion pictures in 4K	P164
[4K Live Cropping]	P169
Recording still pictures while recording motion pictures	P172
[Snap Movie]	P174

Image

[Luminance Level]	P206
-------------------------	------

Audio

[Mic Level Adj.]	P207
[Mic Level Limiter]	P207
[Wind Noise Canceller]	P208
[Lens Noise Cut]	P208
[Wind Cut]	P308

Screen settings

[Mic Level Disp.]	P207
[Center Marker]	P214
[Zebra Pattern]	P215
[Monochrome Live View]	P216



Setup/Custom

Basic settings

[Format]	P27
[Clock Set]	P34
Display switching	P45
How to set menu items	P51
[Q.MENU]	P53
[Beep]	P220
[Economy]	P222

[Reset] (initialization)	P225
[Sensor Cleaning]	P226

Customization

[CUSTOM] in the Quick Menu	P54
Function buttons	P55
Custom Mode	P87
[Custom] menu	P209



Playback

Playback

Picture playback	P177
Motion picture playback	P178
Playback Zoom	P180
Multi Playback	P181
Delete	P184
[Auto Review]	P217

Playback/display settings

[Slide Show]	P229
[Rotate]/[Rotate Disp.]	P244

Edit

Focus Stacking	P133
[RAW Processing]	P233
[4K PHOTO Bulk Saving]	P235
[Light Composition]	P236
[Clear Retouch]	P237
[Resize]	P242
[Cropping]	P243

Adding information

[Location Logging]	P232
[Title Edit]	P238
[Text Stamp]	P239

Image settings

[Favorite]	P245
[Print Set]	P246
[Protect]	P247



Wi-Fi

Connect

- "Image App" P252
- [WPS (Push-Button)] P281, 283
- Direct connection P283

Image App

- Remote recording P257
- Saving images P258
- Sending images P259, 267
- Sending and adding location information P259
- Combining motion pictures recorded with [Snap Movie] P261

In combination with other devices

- Playing back pictures on a TV P262
- Printing images P268
- Sending images to an AV device P269
- Sending images to a PC P270
- Sending images to a web service P272
- Using [Cloud Sync. Service] P275



Connections with other devices

PC

- "PHOTOfunSTUDIO" P295
- "SILKYPIX Developer Studio" P296
- Transferring images to a PC P270

TV

- Playing Back Pictures on a TV Screen P290
- [VIERA Link] P293

Recorder

- Dubbing P299

Printer

- PictBridge P300

Care of the camera

Do not subject to strong vibration, shock, or pressure.

- The lens, monitor, or external case may be damaged if used in the following conditions. It may also malfunction or image may not be recorded if you:
 - Drop or hit the camera.
 - Press hard on the lens or the monitor.

■ Splash Proof

Splash Proof is a term used to describe an extra level of protection this camera offers against exposure to a minimal amount of moisture, water or dust. Splash Proof does not guarantee that damage will not occur if this camera is subjected to direct contact with water.

In order to minimize the possibility of damage please be sure the following precautions are taken:

- The Splash Proof feature works in conjunction with the lenses that were specifically designed to support this feature.
- Make sure the built-in flash is closed.
- Make sure that all doors, socket caps and terminal covers are securely closed.
- Make sure that you are in a dry and secure place when changing the battery, lens or memory card. After changing, make sure their protective doors are securely closed.
- If this camera is exposed to water, sand or any other foreign material clean it as soon as possible, taking the necessary precautions that the foreign substance does not get inside the camera.
- Under no circumstances should you touch or place any foreign objects within the camera or in close proximity of the camera's image sensor.

If sand, dust, or liquids such as water droplets adhere to the monitor, wipe them off with a dry soft cloth.

- Not doing so may cause the monitor to respond incorrectly to touch operations.
- If the monitor is closed when such liquids are present, malfunction may result.

If you shake the camera while it is turned off, its sensors may move or a rattling sound may be heard. The sound is caused by the In-Body Image Stabilizer, and this is not a malfunction.

■ About Condensation (When the lens, the viewfinder or monitor is fogged up)

- Condensation occurs when the ambient temperature or humidity changes. Be careful of condensation since it causes lens, viewfinder and monitor stains, fungus and camera malfunction.
- If condensation occurs, turn the camera off and leave it for about 2 hours. The fog will disappear naturally when the temperature of the camera becomes close to the ambient temperature.

Standard Accessories

Check that all the accessories are supplied before using the camera.

- The accessories and their shape will differ depending on the country or area where the camera was purchased.
For details on the accessories, refer to “Basic Owner’s Manual”.
- Battery Pack is indicated as **battery pack** or **battery** in the text.
- Battery Charger is indicated as **battery charger** or **charger** in the text.
- SD Memory Card, SDHC Memory Card and SDXC Memory Card are indicated as **card** in the text.
- **The card is optional.**





MENU

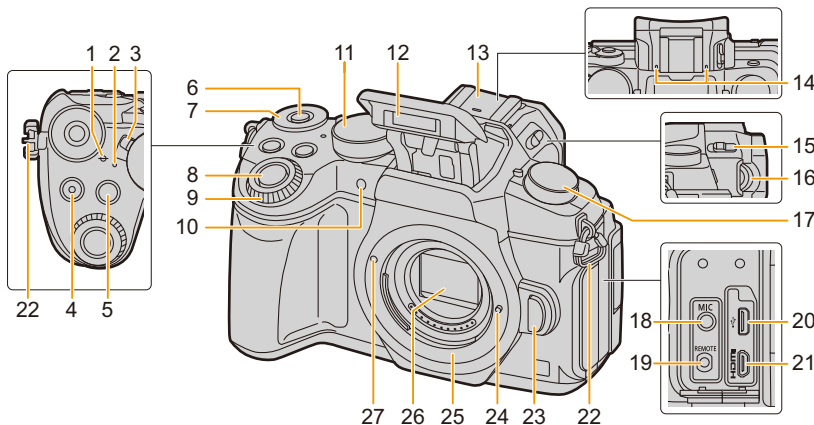

Names and Functions of Components

■ Camera body



1	Focus distance reference mark (P104)	14	Stereo microphone (P207) • Be careful not to cover the microphone with your finger. Doing so may make sound difficult to record.
2	Status indicator (P34)/ Wi-Fi® connection lamp (P250)	15	Flash open lever (P154)
3	Camera ON/OFF switch (P34)	16	Diopter adjustment dial (P37)
4	Motion picture button (P164)	17	Drive mode dial (P114)
5	[] (Exposure Compensation) button (P106)/[Fn1] button (P55)	18	[MIC] socket (P307)
6	Function button (Fn11) (P55)	19	[REMOTE] socket (P309)
7	Rear dial (P41)	20	USB socket (P297, 300)
8	Shutter button (P39)	21	[HDMI] socket (P290)
9	Front dial (P41)	22	Shoulder strap eyelet (P18)
10	Self-timer indicator (P135)/ AF Assist Lamp (P210)	23	Lens release button (P31)
11	Mode dial (P40)	24	Lens lock pin
12	Flash (P154)	25	Mount
13	Hot shoe (Hot shoe cover) (P306) • Keep the Hot Shoe Cover out of reach of children to prevent swallowing.	26	Sensor
		27	Lens fitting mark (P30)



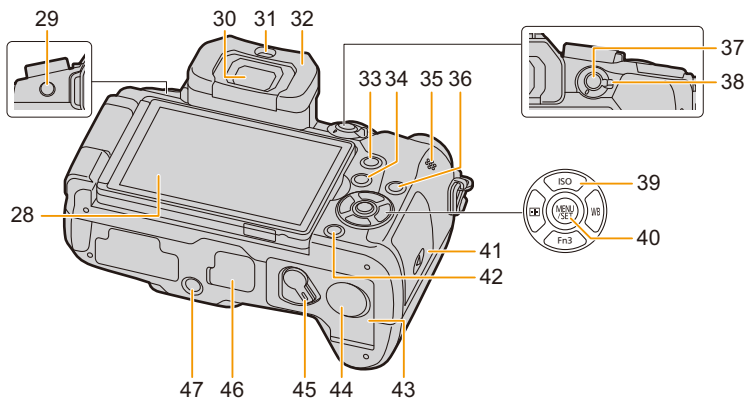

28 Touch screen (P48)/monitor (P311)

29 [LVF] button (P37)/[Fn5] button (P55)

30 Viewfinder (P37)

31 Eye sensor (P38)

32 Eyecup (P330)

33 [Q.MENU] button (P53)/[Fn2] button (P55)

34 [▶] (Playback) button (P177)

35 Speaker (P220)

36 [DISP.] button (P45, 47)

37 [AF/AE LOCK] button (P105)

38 Focus mode lever (P89, 102)

Cursor buttons (P44)

▲/[ISO] (ISO sensitivity) (P108)

39 ▶/[WB] (White Balance) (P110)

◀/[AF] (Auto Focus Mode) (P93)

▼/[Fn3] (P55)

40 [MENU/SET] button (P44, 51)

41 Card door (P25)

42 [⏏/⌫] (Delete/Cancel) button (P184)/
[Fn4] button (P55)

43 Battery door (P24)

DC coupler cover (P310)

- 44** • When using an AC adaptor, ensure that the Panasonic DC coupler (optional) and AC adaptor (optional) are used.

45 Release lever (P24)

Cover for the battery grip connector (P309)

- 46** • Keep the cover for the battery grip connector out of reach of children to prevent swallowing.

Tripod mount (P335)

- 47** • It may not be possible to attach and securely fasten a tripod with a screw length of 5.5 mm (0.22 inch) or more to the camera. Doing so may also damage the camera.

■ About the function button ([Fn6] to [Fn10])

- Function buttons ([Fn6] to [Fn10]) (P55) are touch icons. Touch the [Fn] tab on the recording screen to display them.

■ Lens

H-FS12060

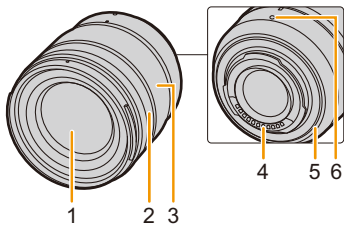

H-FS14140

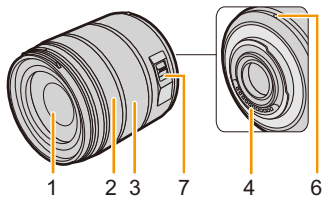

H-FS1442A

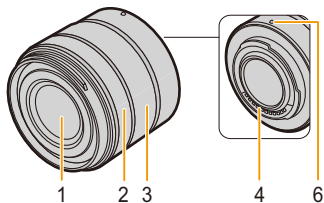

1 Lens surface

2 Focus ring (P102)

3 Zoom ring (P148)

4 Contact point

5 Lens mount rubber (P331)

6 Lens fitting mark (P30)

7 O.I.S. switch (P144)

About the Lens

This unit can use the dedicated lenses compatible with the Micro Four Thirds™ System lens mount specification (Micro Four Thirds mount).

You can also use a lens of any of the following standards by attaching a mount adaptor.



Lens	Mount adaptor
Four Thirds™ mount specification lens	Mount Adaptor (DMW-MA1: optional)
Leica M Mount interchangeable lens	M Mount Adaptor (DMW-MA2M: optional)
Leica R Mount interchangeable lens	R Mount Adaptor (DMW-MA3R: optional)

- When using a Leica lens mount adaptor, set [Shoot w/o Lens] (P218) to [ON].

About the lens and functions

Depending on the lens used, certain functions, such as Auto Focus, Image Stabilizer, and zoom functions, may be disabled or operate differently.

For details on the lens used, refer to the website.

Refer to catalogs/Web pages for most current information regarding compatible lenses.

<http://panasonic.jp/support/global/cs/dsc/>

(This Site is English only.)

- The focal length noted on the lens in use is equivalent to double when converted to the 35 mm film camera.
(It will be equivalent to 100 mm lens when a 50 mm lens is used.)

About the firmware of your interchangeable lens

For smoother recording, we recommend updating the firmware of the interchangeable lens to the latest version.

- **To view the latest information on the firmware or to download the firmware, visit the support site below:**

<http://panasonic.jp/support/global/cs/dsc/>

(This Site is English only.)

- To check the firmware version of the interchangeable lens, attach it to the camera body and select [Version Disp.] in the [Setup] menu.

Attaching the Shoulder Strap

- We recommend attaching the shoulder strap when using the camera to prevent it from dropping.

- 1 Pass the shoulder strap through the shoulder strap eyelet on the camera body.

(A): Shoulder strap eyelet

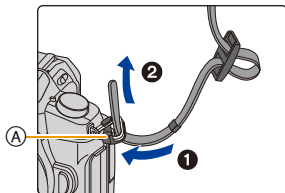

- 2 Pass the end of the shoulder strap through the ring in the direction of the arrow and then pass it through the stopper.

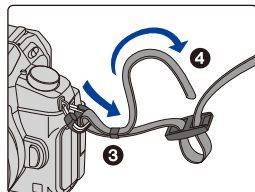

- 3 Pass the end of the shoulder strap through the hole on the other side of the stopper.

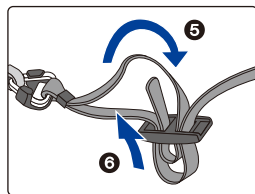

- 4 Pull the shoulder strap and then check that it will not come out.

- Perform steps 1 to 4 and then attach the other side of the shoulder strap.

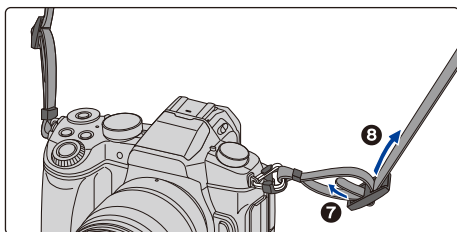

- Use the shoulder strap around your shoulder.
 - Do not wrap the strap around your neck. It may result in injury or accident.
- Do not leave the shoulder strap where an infant can reach it.
 - It may result in an accident by mistakenly wrapping around the neck.

Charging the Battery

About batteries that you can use with this unit

It has been found that counterfeit battery packs which look very similar to the genuine product are made available for purchase in some markets. Some of these battery packs are not adequately protected with internal protection to meet the requirements of appropriate safety standards. There is a possibility that these battery packs may lead to fire or explosion. Please be advised that we are not liable for any accident or failure occurring as a result of use of a counterfeit battery pack. To ensure that safe products are used, we recommend that a genuine Panasonic battery pack is used.

- Use the dedicated charger and battery.

Charging

- The battery is not charged when the camera is shipped. Charge the battery before use.
- Charge the battery with the charger indoors.

- 1 Attach the battery paying attention to the direction of the battery.

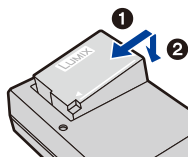

- 2 Connect the charger to the electrical outlet.

- The [CHARGE] indicator (A) lights up and charging begins.

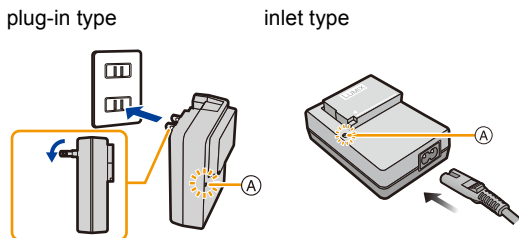

■ About the [CHARGE] indicator

On: Charging.

Off: Charging has completed.
(Disconnect the charger from the electrical socket and detach the battery after charging is completed.)

• When the [CHARGE] indicator flashes

- The battery temperature is too high or too low. It is recommended to charge the battery again in an ambient temperature of between 10 °C and 30 °C (50 °F and 86 °F).
- The terminals of the charger or the battery are dirty. In this case, wipe them with a dry cloth.

■ Charging time

Charging time

Approx. 140 min

- The indicated charging time is for when the battery has been discharged completely. The charging time may vary depending on how the battery has been used. The charging time for the battery in hot/cold environments or a battery that has not been used for a long time may be longer than normal.

■ Battery indication

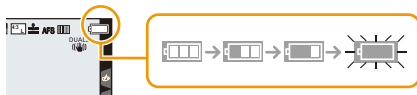

- The indication turns red and blinks if the remaining battery power is exhausted.
(The status indicator also blinks)
Recharge the battery or replace it with a fully charged battery.

• **Do not leave any metal items (such as clips) near the contact areas of the power plug. Otherwise, a fire and/or electric shocks may be caused by short-circuiting or the resulting heat generated.**

- The battery can be recharged even when it still has some charge left, but it is not recommended that the battery charge be frequently topped up while the battery is fully charged.
(Since characteristic swelling may occur.)

Approximate operating time and number of recordable pictures

By CIPA (Camera & Imaging Products Association) standard

When a Panasonic SDHC memory card and the supplied battery are used

■ Recording still pictures (when using the Monitor)

When the interchangeable lens (H-FS12060) is used	
Number of recordable pictures	Approx. 330 pictures
Recording time	Approx. 165 min
When the interchangeable lens (H-FS14140) is used	
Number of recordable pictures	Approx. 320 pictures
Recording time	Approx. 160 min
When the interchangeable lens (H-FS1442A) is used	
Number of recordable pictures	Approx. 330 pictures
Recording time	Approx. 165 min

■ Recording still pictures (when using the Viewfinder)

The numbers in parentheses indicate the values that result when [Power Save LVF Shooting] (P222) is set to [3SEC] and works as intended. (Based on the test conditions derived from the CIPA standard and specified by Panasonic)

When the interchangeable lens (H-FS12060) is used	
Number of recordable pictures	Approx. 320 pictures (Approx. 800 pictures)
Recording time	Approx. 160 min
When the interchangeable lens (H-FS14140) is used	
Number of recordable pictures	Approx. 310 pictures (Approx. 800 pictures)
Recording time	Approx. 155 min
When the interchangeable lens (H-FS1442A) is used	
Number of recordable pictures	Approx. 320 pictures (Approx. 800 pictures)
Recording time	Approx. 160 min

■ **Recording motion pictures (when using the monitor)**

[AVCHD] (Recording with picture quality set to [FHD/17M/60i])

When the interchangeable lens (H-FS12060) is used	
Recordable time	Approx. 120 min
Actual recordable time	Approx. 60 min
When the interchangeable lens (H-FS14140) is used	
Recordable time	Approx. 120 min
Actual recordable time	Approx. 60 min
When the interchangeable lens (H-FS1442A) is used	
Recordable time	Approx. 120 min
Actual recordable time	Approx. 60 min

[MP4] (Recording with picture quality set to [FHD/28M/60p])

When the interchangeable lens (H-FS12060) is used	
Recordable time	Approx. 110 min
Actual recordable time	Approx. 55 min
When the interchangeable lens (H-FS14140) is used	
Recordable time	Approx. 110 min
Actual recordable time	Approx. 55 min
When the interchangeable lens (H-FS1442A) is used	
Recordable time	Approx. 110 min
Actual recordable time	Approx. 55 min



[MP4] (Recording with picture quality set to [4K/100M/30p])

When the interchangeable lens (H-FS12060) is used	
Recordable time	Approx. 90 min
Actual recordable time	Approx. 45 min
When the interchangeable lens (H-FS14140) is used	
Recordable time	Approx. 90 min
Actual recordable time	Approx. 45 min
When the interchangeable lens (H-FS1442A) is used	
Recordable time	Approx. 90 min
Actual recordable time	Approx. 45 min

- Actual recordable time is the time available for recording when repeating actions such as turning this unit on and off, starting/stopping recording, etc.

■ Playback (when using the monitor)

When the interchangeable lens (H-FS12060) is used	
Playback time	Approx. 220 min
When the interchangeable lens (H-FS14140) is used	
Playback time	Approx. 230 min
When the interchangeable lens (H-FS1442A) is used	
Playback time	Approx. 230 min

- **The operating times and number of recordable pictures will differ according to the environment and the operating conditions.**

For example, in the following cases, the operating times shorten and the number of recordable pictures is reduced.

- In low-temperature environments, such as on ski slopes.
- When flash is used repeatedly.
- When the operating time of the camera becomes extremely short even after properly charging the battery, the life of the battery may have expired. Buy a new battery.

Inserting/Removing the Battery

- Check that this unit is turned off.

1 **1:** Slide the release lever in the direction of the arrow (to the OPEN side).

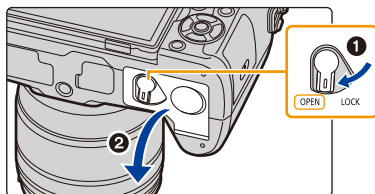

2: Open the battery door.

- Always use genuine Panasonic batteries.
- If you use other batteries, we cannot guarantee the quality of this product.

2 Being careful about the battery orientation, insert all the way until you hear a locking sound and then check that it is locked by lever **A**. Pull the lever **A** in the direction of the arrow to remove the battery.

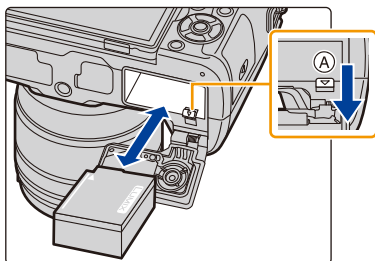

3 **1:** Close the battery door.

2: Slide the release lever in the direction of the arrow.

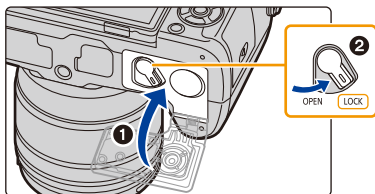

- Confirm that there is no foreign matter adhered on the inner side (rubber seal) of the battery door.
- Remove the battery after use.
(The battery will be exhausted if left for a long period of time after being charged.)
- **The battery becomes warm after using it and during and after charging. The camera also becomes warm during use. This is not a malfunction.**
- Before removing the battery, turn the camera off, and wait until the status indicator has gone off completely.
(Otherwise, this unit may no longer operate normally and the card itself may be damaged or the recorded pictures may be lost.)
- Be careful when removing the battery as the battery will jump out.

Inserting/Removing the Card (Optional)

- Check that this unit is turned off.

1 Slide the card door to open it.

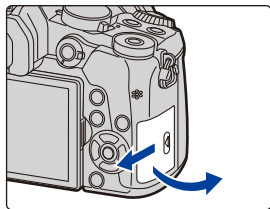

2 Push it securely all the way until you hear a “click” while being careful about the direction in which you insert it.

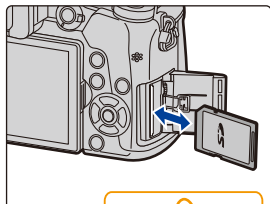

To remove the card, push the card until it clicks, then pull the card out upright.

(A): Do not touch the connection terminals of the card.

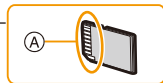

3 **1**: Close the card door.

2: Slide the card door to the end and then close it firmly.

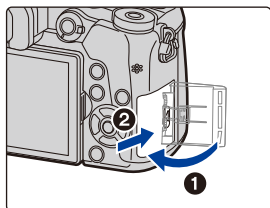

- Before removing the card, turn the camera off, and wait until the status indicator has gone off completely.
(Otherwise, this unit may no longer operate normally and the card itself may be damaged or the recorded pictures may be lost.)

Card Information

The following cards which conform to the SD standard can be used with this unit.
(These cards are indicated as **card** in the text.)

SD Memory Card (512 MB to 2 GB)	<ul style="list-style-type: none"> This unit is compatible with UHS-I/UHS-II UHS Speed Class 3 standard SDHC/SDXC memory cards. Operation of the cards on the left has been confirmed with Panasonic's cards.
SDHC Memory Card (4 GB to 32 GB)	
SDXC Memory Card (48 GB to 128 GB)	

■ About motion picture/4K photo recording and speed class ratings

According to the [Rec Format] (P166) and [Rec Quality] (P166) of a motion picture, the required card differs. To record 4K photos, you need a card with a speed class rating that supports 4K photo recording. Use a card that meets the following ratings of the SD Speed Class or UHS Speed Class.

- SD Speed Class and UHS Speed Class are the speed standards regarding continuous writing. To check the class, see the labeled side, etc. of the card.

[Rec Format]	[Rec Quality]	Speed class	Label example
[AVCHD]	All	Class 4 or higher	CLASS 4 4
[MP4]	FHD/HD		
[MP4]	4K	UHS Speed Class 3	U3
When recording with the 4K Photo/ Post Focus function		UHS Speed Class 3	U3

- Please confirm the latest information on the following website.

<http://panasonic.jp/support/global/cs/dsc/>

(This Site is English only.)



Access to the card

The access indication displays red when pictures are being recorded on the card.



- **During access (image writing, reading and deleting, formatting etc.), do not turn this unit off, remove the battery, card or disconnect the AC adaptor (optional). Furthermore, do not subject the camera to vibration, impact or static electricity.**

The card or the data on the card may be damaged, and this unit may no longer operate normally.

If operation fails due to vibration, impact or static electricity, perform the operation again.

- If you set the Write-Protect switch (A) to "LOCK", you may not be able to write, delete or format the data or display it by recording date.
- The data on the card may be damaged or lost due to electromagnetic waves, static electricity or breakdown of the camera or the card. We recommend storing important data on a PC etc.
- Keep the Memory Card out of reach of children to prevent swallowing.

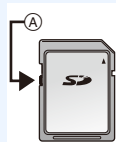
**Formatting the card (initialization)**

Format the card before recording a picture with this unit.

Since data cannot be recovered after formatting, make sure to back up necessary data in advance.

Select the menu. (P51)

MENU → **[Setup]** → **[Format]**

- Use a battery with sufficient battery power or the AC adaptor (optional) when formatting. Do not turn the camera off during formatting.
- If the card has been formatted on a PC or other equipment, format it on the camera again.

Approximate number of recordable pictures and available recording time

■ Number of recordable pictures

- Aspect ratio [4:3], Quality [■]

[Picture Size]	16 GB	32 GB	64 GB	128 GB
L (16M)	1810	3630	7260	14380
M (8M)	3310	6640	13000	25740
S (4M)	5670	11360	21480	42540

- Aspect ratio [4:3], Quality [RAW■]

[Picture Size]	16 GB	32 GB	64 GB	128 GB
L (16M)	550	1110	2230	4420
M (8M)	640	1290	2580	5120
S (4M)	700	1410	2800	5550

■ Available recording time (when recording motion pictures)

- “h” is an abbreviation for hour, “m” for minute and “s” for second.
- The recordable time is the total time of all the motion pictures which have been recorded.

- [AVCHD]

[Rec Quality]	16 GB	32 GB	64 GB	128 GB
[FHD/28M/60p]	1h10m	2h30m	5h00m	9h55m
[FHD/17M/60i]	2h00m	4h5m	8h15m	16h25m
[FHD/24M/30p]/ [FHD/24M/24p]	1h25m	2h55m	5h50m	11h35m

- [MP4]

[Rec Quality]	16 GB	32 GB	64 GB	128 GB
[4K/100M/30p]/ [4K/100M/24p]	20m00s	41m00s	1h20m	2h45m
[FHD/28M/60p]	1h10m	2h25m	5h00m	9h55m
[FHD/20M/30p]	1h35m	3h15m	6h40m	13h15m
[HD/10M/30p]	3h5m	6h20m	12h45m	25h20m



- Depending on the recording conditions and the type of card, the number of recordable pictures and available recording time vary.
- AVCHD motion pictures:
You can continue recording without interruption even if the file size exceeds 4 GB, but the motion picture file will be divided.
- MP4 motion pictures with a [Rec Quality] size of [FHD] or [HD]:
You can continue recording without interruption even if the continuous recording time exceeds 30 minutes or the file size exceeds 4 GB, but the motion picture file will be divided and recorded/played back separately.
- MP4 motion pictures with a [Rec Quality] size of [4K]:
Motion picture file will be recorded and played back in separate files in the following cases. (You can continue recording without interruption.)
 - When using an SDHC memory card: If the file exceeds 4 GB
 - When using an SDXC memory card: If the continuous recording time exceeds 3 hours and 4 minutes or If the file exceeds 96 GB
- **The maximum available continuous recording time is displayed on the screen.**

Attaching/Removing the Lens

By changing the lens, you will increase your picture taking-options and further your enjoyment of the camera.

- Check that the camera is turned off.
- Change lenses where there is not a lot of dirt or dust. Refer to [P330](#) when dirt or dust gets on the lens.

Attaching the lens

- 1 Turn the lens rear cap **(A)** and the body cap **(B)** in the direction of the arrow to detach them.

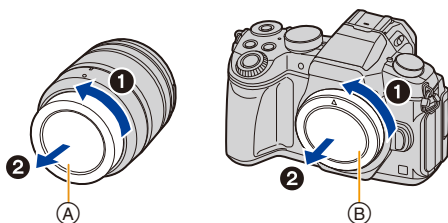

- 2 Align the lens fitting marks **(C)** and then rotate the lens in the direction of the arrow until it clicks.

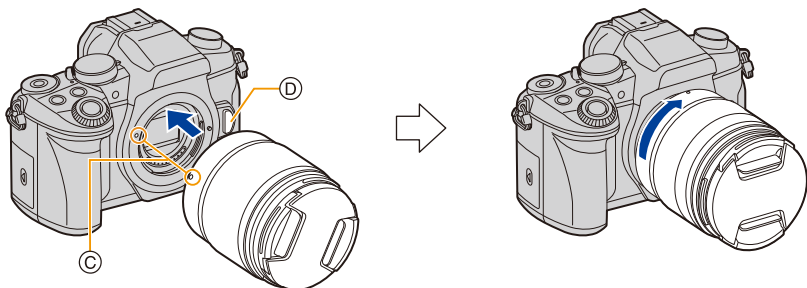

- Do not press the lens release button **(D)** when you attach a lens.
- Do not try to attach the lens when holding it at an angle to the camera body as the lens mount may get scratched.

Detaching the lens

- Attach the lens cap.

While pressing on the lens release button (A), rotate the lens toward the arrow until it stops and then remove.

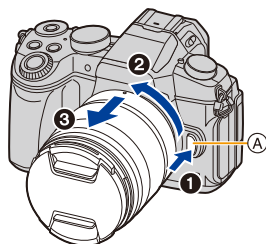

- To prevent dust and other particles from accumulating on or entering the camera or lens, be sure to attach the body cap to the camera and the lens rear cap to the lens after detaching it from the camera.

Zoom operations

When using the interchangeable lens (H-FS12060/H-FS14140/H-FS1442A)

Rotate the zoom ring of the lens.

- T** side: Enlarges distant subject
- W** side: Widens angle of view

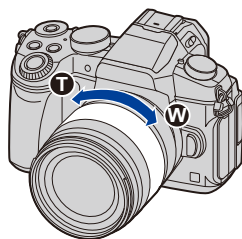

Attaching the Lens Hood

When recording into strong backlight, irregular reflection may occur within the lens. The lens hood reduces the inclusion of unwanted light in the recorded images and lowers the drop in contrast. The lens hood cuts off excess lighting and improves the picture quality.

To attach the lens hood (flower shape) that came with the interchangeable lenses (H-FS12060/H-FS14140/H-FS1442A)

Hold the lens hood by placing your fingers as shown in the figure.

• Do not hold the lens hood in such a way that it will be bent.



- 1 **Align the mark (A) (●) on the lens hood with the mark on the tip of the lens.**

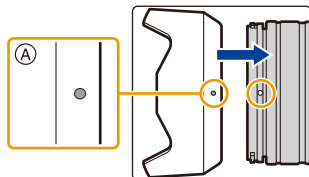

- 2 **Rotate the lens hood in the direction of the arrow until it clicks and then align the mark (B) (◻) on the lens hood with the mark on the tip of the lens.**

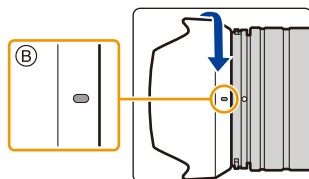

Temporarily Storing the Lens Hood

Example: H-FS12060

- 1 Turn the lens hood in the direction of the arrow to detach it.
- 2 Align the mark (C) (◻) on the lens hood with the mark on the tip of the lens.
- 3 Turn the lens hood in the direction of the arrow until it clicks into place.

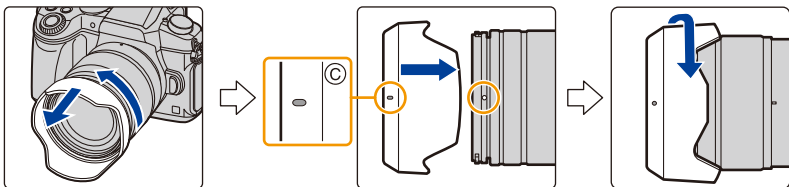

Opening the Monitor/Adjusting the Monitor

At the time when this camera is purchased, the monitor is stowed in the camera body. Bring out the monitor as shown below.

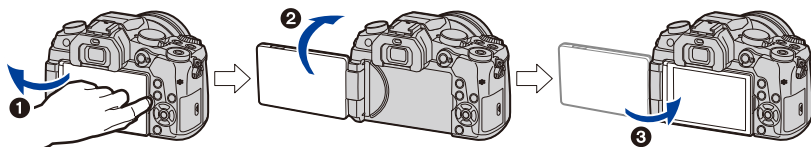

- ❶ Open the monitor. (Maximum 180°)
- ❷ It can be rotated 180° forward.
- ❸ Return the monitor to its original position.

• **Only rotate the monitor after opening it wide enough, and be careful not to use excessive force as it may be damaged.**

■ Free angle shooting

The monitor can be rotated to suit your needs. This is convenient as it allows you to take pictures from various angles by adjusting the monitor.

Taking pictures at a high angle

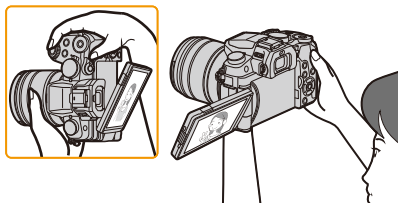

Taking pictures at a low angle

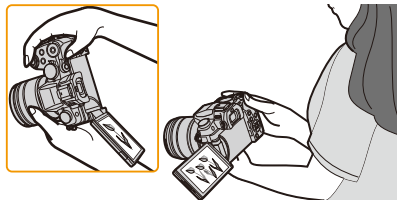

• When not using the monitor it is recommended that you close it with the screen facing inward to prevent dirt and scratches.

Setting Date/Time (Clock Set)

• The clock is not set when the camera is shipped.

1 Turn the camera on.

- When the camera is turned on, the status indicator ❶ lights up green.
- If the language select screen is not displayed, proceed to step 4.

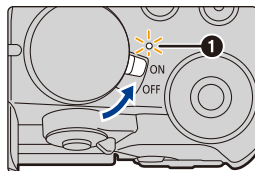

2 Press [MENU/SET].

3 Press ▲/▼ to select the language, and press [MENU/SET].

4 Press [MENU/SET].

5 Press ◀/▶ to select the items (year, month, day, hour, minute), and press ▲/▼ to set.

- Ⓐ: Time at the home area
- Ⓑ: Time at the travel destination

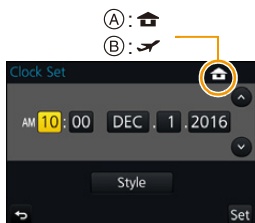

To set the display order and the time display format.

- To display the setting screen of the order/time, select [Style] and then press [MENU/SET].

6 Press [MENU/SET] to set.

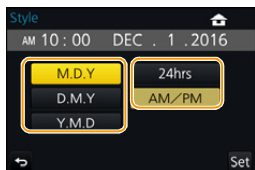

- 7 When [The clock setting has been completed.] is displayed, press [MENU/SET].
- 8 When [Please set the home area] is displayed, press [MENU/SET].
- 9 Press ◀/▶ to select the home area, and then press [MENU/SET].



Re-adjusting the clock

Select [Clock Set] in the [Setup] menu. (P51)

- The clock can be reset as shown in steps 5 and 6 on P34.
- The clock setting is maintained for 3 months using the built-in clock battery even without the battery.
(Leave the charged battery in the unit for 24 hours to charge the built-in battery.)

• If the clock is not set, the correct date cannot be printed when you stamp the date on the pictures with [Text Stamp] or order a photo studio to print the pictures.

Basic Operations

Tips for taking good pictures

Hold the camera gently with both hands, keep your arms still at your side and stand with your feet slightly apart.

- Do not cover the flash, AF Assist lamp (A), microphone (B), or speaker (C) with your fingers or other objects.
- Make sure your footing is stable and there is no danger of colliding with another person or object in the vicinity while taking pictures.

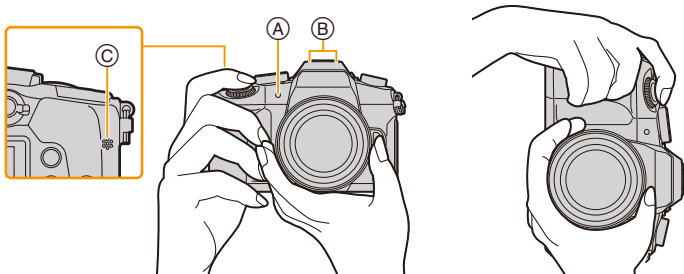

■ Detects orientation of camera (Direction Detection Function)

This function detects the vertical orientation when you record with the camera vertically orientated.

When you play back the recording, the recording is automatically displayed in vertical orientation.

(Only available when [Rotate Disp.] (P244) is set to [ON].)

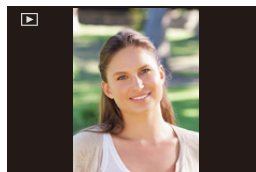

- When the camera is held vertically and tilted significantly up or down to record, the Direction Detection Function may not work correctly.
- Motion pictures, 4K burst files, and images recorded with the Post Focus function cannot be displayed vertically.

Using the Viewfinder

Diopter adjustment

Adjust the diopter to suit your vision so that you can see the characters displayed in the viewfinder clearly.

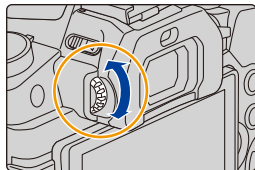

Switching the Monitor/Viewfinder

Press [LVF] to switch between the Monitor and Viewfinder.

- Ⓐ [LVF] button
- Ⓑ Eye sensor

• You can also use the button as a function button. (P55)

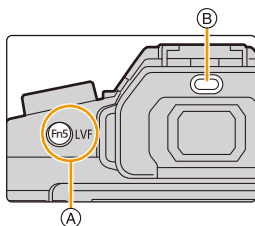

Press [LVF].

Automatic viewfinder/
monitor switching*

Viewfinder display*

Monitor display

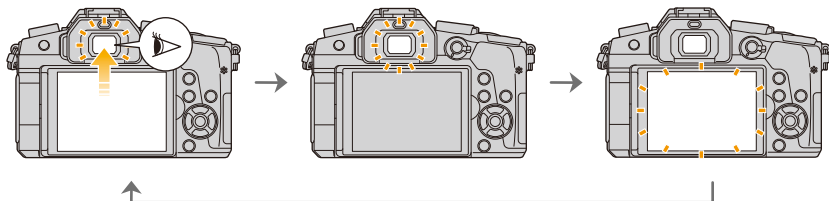

- * If [Eye Sensor AF] in the [Custom] menu is set to [ON], the camera automatically adjusts the focus as the eye sensor is activated. The camera does not beep when focus is achieved with [Eye Sensor AF].

■ Notes on automatic viewfinder/monitor switching

Automatic viewfinder/monitor switching enables the eye sensor to switch the display to the viewfinder automatically when you bring your eye or an object near it.

- If you enable the automatic viewfinder/monitor switching function and display the “On-monitor recording information screen” (P46) on the monitor, [Power Save LVF Shooting] in [Economy] (P222) can be used, allowing you to reduce the battery consumption.
- Eye sensor might not work properly depending on the shape of your eyeglasses, the way you hold the camera, or bright light shining around the eyepiece. In that case, press [LVF] to switch the display.
- During motion picture playback or a slide show, the camera does not automatically switch the display to the Viewfinder with the eye sensor.
- The eye sensor does not work depending on the angle of the monitor.



Setting the eye sensor sensitivity and the automatic switching of the display between the Monitor and Viewfinder

MENU → **f** [Custom] → [Eye Sensor]

[Sensitivity]	This will set the sensitivity of the eye sensor.
[LVF/Monitor Switch]	This will set the method for switching between the monitor and viewfinder. [LVF/MON AUTO] (automatic switching between the monitor and viewfinder)/ [LVF] (viewfinder)/[MON] (monitor) • If you press [LVF] to switch the display, the [LVF/Monitor Switch] setting will also switch.

Shutter button (Taking pictures)

The shutter button works in two steps. To take a picture, press it.

Press the shutter button halfway to focus.

- (A) Aperture value
- (B) Shutter speed
- (C) Focus indication

• Aperture value and shutter speed are displayed.

(It will flash in red if the correct exposure is not achieved, except when set to flash.)

- Once the subject is in focus, the focus indication is displayed.
(When the subject is not in focus, the indication flashes.)

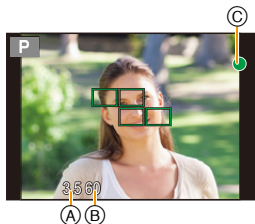
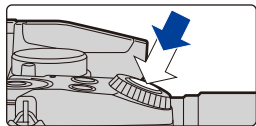

Press the shutter button fully (push it in further), and take the picture.

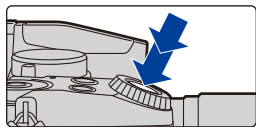

- Pictures cannot be taken until focus is achieved when [Focus/Release Priority] (P211) is set to [FOCUS].
- Even during menu operation or image playback, if you press the shutter button halfway, you can instantly set the camera ready for recording.

Motion picture button (Recording motion pictures)

Start recording by pressing the motion picture button.

- Release the motion picture button right after you press it.

Stop the recording by pressing the motion picture button again.

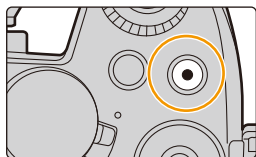

Mode dial (Selecting a Recording Mode)

Select the mode by rotating the mode dial.

- Rotate the mode dial slowly to select the desired mode.

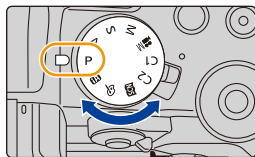

iA	Intelligent Auto Mode (P59)
iA+	Intelligent Auto Plus Mode (P60)
P	Program AE Mode (P66)
A	Aperture-Priority AE Mode (P69)
S	Shutter-Priority AE Mode (P69)
M	Manual Exposure Mode (P70)
M	Creative Video Mode (P85)
C1/C2	Custom Mode (P87)
SCN	Scene Guide Mode (P74)
Ⓢ	Creative Control Mode (P79)

Front Dial/Rear Dial



Rotating:

Selection of items or setting of values is performed during the various settings.

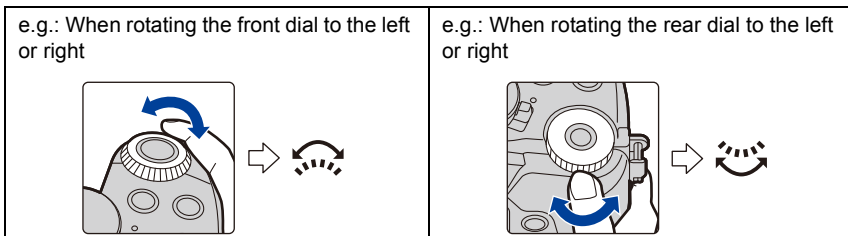
- This owner's manual describe operations of the front dial/rear dial as follows:



Allows you to set the aperture, shutter speed, and other settings when in **P / A / S / M** modes.

Mode dial	 Front dial	 Rear Dial
P (P66)	Program Shift	Program Shift
A (P69)	Aperture value	Aperture value
S (P69)	Shutter speed	Shutter speed
M (P70)	Aperture value	Shutter speed

- In [Dial Set.] in the [Custom] menu, you can change the operation methods of the front dial and rear dial. (P43)





Temporarily changing the items assigned to the front/rear dials ([Dial Operation Switch])

You can temporarily change the items assigned to the front/rear dials using the function button to which [Dial Operation Switch] is assigned.

[Dial Operation Switch] is assigned to [Fn11] at the time of purchase. (P55)

(A) Function button [Fn11]

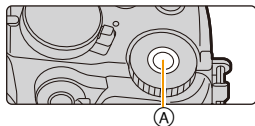

• You can set the items to be assigned temporarily to the front/rear dials in [Dial Operation Switch Setup] in [Dial Set.] in the [Custom] menu. (P43)

1 Press [Fn11].

- A guide will be displayed showing the items temporarily assigned to the front/rear dials.
- If no operations are performed, the guide will disappear in a few seconds.



2 Rotate the front/rear dials while the guide is displayed.

- The settings of the items assigned to the dials will change.















3 Press [MENU/SET] and set.

- You can also complete this step by performing either of the operations below:
 - Press the shutter button halfway
 - Press [Fn11]

• Items that are temporarily assigned to the front/rear dials can be used only while the guide (step 1) or setting screen (step 2) is displayed.

■ Setting the operation methods of the front dial and rear dial

MENU → **fC [Custom]** → **[Dial Set.]**

<p>[Assign Dial (F/SS)]</p>	<p>Assigns the operations of the aperture value and shutter speed in Manual Exposure Mode.</p> <p>[ F  SS]: Assigns the aperture value to the front dial, and the shutter speed to the rear dial.</p> <p>[ SS  F]: Assigns the shutter speed to the front dial, and the aperture value to the rear dial.</p>												
<p>[Rotation (F/SS)]</p>	<p>Changes the rotation direction of the dials for adjusting the aperture value and shutter speed.</p> <p>[  / [ ]</p>												
<p>[Exposure Comp.]</p>	<p>Assigns the Exposure Compensation to the front dial or rear dial so that you can directly adjust it.</p> <p>[] (Front Dial) / [] (Rear Dial) / [OFF]</p>												
<p>[Dial Operation Switch Setup]</p>	<p>Sets the items to be assigned temporarily to the front/rear dials when you press the function button to which [Dial Operation Switch] is assigned.</p> <p>[] ([Front Dial Operation]) / [] ([Rear Dial Operation])</p> <ul style="list-style-type: none"> • Items that can be set are as follows. <table style="width: 100%; border: none;"> <tr> <td style="width: 50%;">– [Photo Style] (P186)</td> <td style="width: 50%;">– [i.Dynamic] (P194)</td> </tr> <tr> <td>– [Filter Effect] (P79, 188)</td> <td>– [i.Resolution] (P194)</td> </tr> <tr> <td>– [Aspect Ratio] (P189)</td> <td>– [Flash Mode] (P157)</td> </tr> <tr> <td>– [AF Mode] (P93)</td> <td>– [Flash Adjust.] (P160)</td> </tr> <tr> <td>– [4K PHOTO] (P118)</td> <td>– [Sensitivity] (P108)</td> </tr> <tr> <td>– [Highlight Shadow] (P193)</td> <td>– [White Balance] (P110)</td> </tr> </table> • [Highlight Shadow] uses the two dials. It will be automatically assigned to both of the dials when you assign it to either of them. 	– [Photo Style] (P186)	– [i.Dynamic] (P194)	– [Filter Effect] (P79, 188)	– [i.Resolution] (P194)	– [Aspect Ratio] (P189)	– [Flash Mode] (P157)	– [AF Mode] (P93)	– [Flash Adjust.] (P160)	– [4K PHOTO] (P118)	– [Sensitivity] (P108)	– [Highlight Shadow] (P193)	– [White Balance] (P110)
– [Photo Style] (P186)	– [i.Dynamic] (P194)												
– [Filter Effect] (P79, 188)	– [i.Resolution] (P194)												
– [Aspect Ratio] (P189)	– [Flash Mode] (P157)												
– [AF Mode] (P93)	– [Flash Adjust.] (P160)												
– [4K PHOTO] (P118)	– [Sensitivity] (P108)												
– [Highlight Shadow] (P193)	– [White Balance] (P110)												

Cursor buttons/[MENU/SET] button

Pressing the cursor button:

Selection of items or setting of values etc., is performed.

Pressing [MENU/SET]:

Confirmation of setting contents, etc., is performed.

- This owner's manual expresses the up, down, left, and right of the cursor button as ▲/▼/◀/▶.

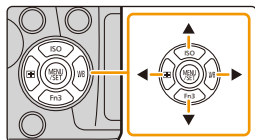

- By assigning [Cursor Button Lock] to a function button, you can disable the cursor buttons and the [MENU/SET] button. (P55)

[DISP.] button (Switching the displayed information)

Press [DISP.] to switch the information displayed on the screen.

- If the information on the screen is not displayed any longer because no operation was performed for some time, press the [DISP.] button or touch the screen to display the information again.



In Recording Mode



Switching the display method of the viewfinder/monitor

MENU → \mathcal{F} [Custom] → [LVF Disp.Style]

MENU → \mathcal{F} [Custom] → [Monitor Disp. Style]

 (viewfinder style): Scales down images slightly so that you can better review the composition of the images.

 (monitor style): Scales images to fill the entire screen so that you can see their details.

■ Live View Finder style display layout (Example of viewfinder style display)

With information
(detailed
information)



With information



With information
(detailed
information, tilt
sensor display)



With information
(tilt sensor
display)

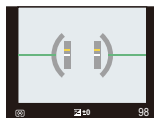

■ [] Monitor style display layout (Example of monitor style display)

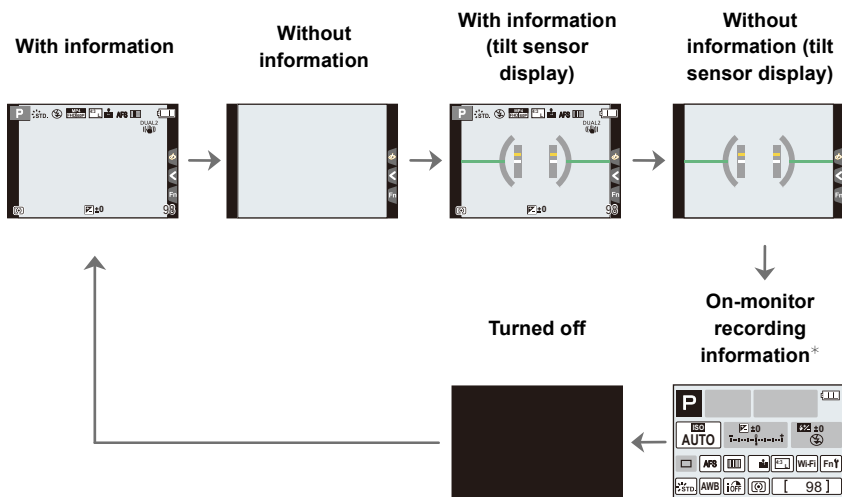

* When the on-monitor recording information screen is displayed, you can touch the desired item and change its setting directly.

- If you assign [LVF/Monitor Disp. Style] to [Fn Button Set] (P55) in the [Custom] menu, each time you press the assigned function button, you can change the display style of the monitor or viewfinder ([]/[]), whichever is currently in use.

■ About the tilt sensor display

With the tilt sensor displayed, it is easy to correct the tilt of the camera etc.

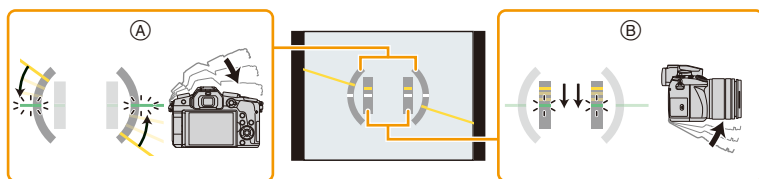

- (A) **Horizontal direction:** Correcting tilt to the left
- (B) **Vertical direction:** Correcting downward tilt

• When the tilt of the camera is little, the indicator changes to green.

- Even after correcting the tilt, there may still be an error of approximately $\pm 1^\circ$.
- When tilted significantly upwards or downwards to record, the tilt sensor display may not be displayed correctly, and the Direction Detection Function (P36) may not work correctly.

In Playback Mode

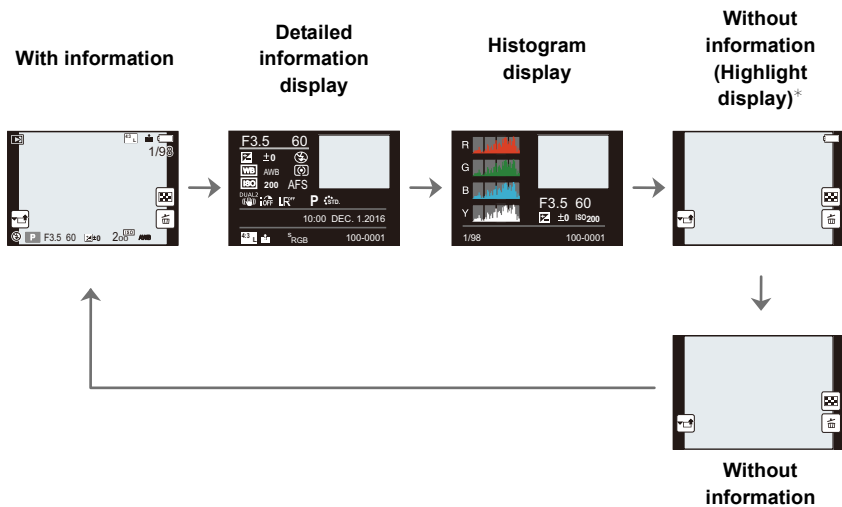

*This is displayed if [Highlight] (P215) in the [Custom] menu is set to [ON].

- Some of the screens cannot be displayed for certain files that you play back, such as motion pictures and 4K burst files.

Touch screen (Touch operations)

Touch screen of this unit is capacitive. Touch the panel directly with your bare finger.

■ Touch

To touch and release the touch screen.



■ Drag

A movement without releasing the touch screen.



■ Pinch (enlarge/reduce)

Pinch the touch screen apart (enlarge) or together (reduce) with two fingers.



- Touch the screen with the clean and dry finger.
- If you use a commercially available monitor protection sheet, please follow the instructions that accompany the sheet.
(Some monitor protection sheets may impair visibility or operability.)

Not available in these cases:

- The touch screen may not function normally in the following cases.
 - When touched by a gloved hand
 - When the touch screen is wet

Taking Pictures Using the Touch Function

Taking pictures using the Touch Shutter function

Applicable modes:   P A S M   

Just by touching the subject you want as your point of focus, the camera will focus on the subject and take the picture automatically.

1 Touch [].



2 Touch [].

- Icon will change to [], and taking a picture with the Touch Shutter function becomes possible.



3 Touch the subject you wish to focus on, and then take a picture.

- The picture is taken when the focus is achieved.



■ To cancel the Touch Shutter function

Touch [].

- If shooting with the touch shutter fails, the AF area turns red and disappears.

Easily Optimizing the Brightness for a Specified Area (Touch AE)

Applicable modes:   P A S M   

You can easily optimize the brightness for a touched position. When the face of the subject appears dark, you can brighten the screen according to the brightness of the face.

1 Touch [].



2 Touch [].

- The setting screen for the brightness optimization position is displayed.
- [Metering Mode] is set to [], which is used exclusively for the Touch AE.



3 Touch the subject you want to optimize the brightness for.

- Touching [Reset] will bring the brightness optimization position back to the center.



4 Touch [Set].

■ Canceling the Touch AE function

Touch [].

- [Metering Mode] returns to the original setting, and the brightness optimization position is canceled.

Not available in these cases:

- This function is not available in the following cases:
 - When using the Digital Zoom
 - When [4K Live Cropping] is set
 - When [Touch AF] in [Touch Settings] of the [Custom] menu has been set to [AF+AE] (P101)

Setting menu items

You can either operate the buttons or touch the monitor to set menu items.

1 Press [MENU/SET].

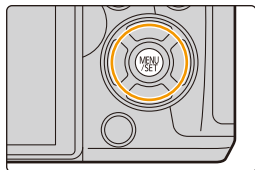

[Rec] (P185)	This menu lets you set the aspect ratio, number of pixels, 4K Photo and other aspects of the pictures you are recording.
[Motion Picture] (P206)	This menu lets you set the [Rec Format], [Rec Quality], and other aspects for motion picture recording.
[Custom] (P209)	Operation of the unit, such as displaying of the screen and button operations, can be set up according to your preferences.
[Setup] (P219)	This menu lets you perform the clock settings, select the operating beep tone settings and set other settings which make it easier for you to operate the camera. You can also configure the settings of Wi-Fi related functions.
[Playback] (P227)	This menu lets you set the Protection, Cropping or Print Settings, etc. of recorded pictures.

- The [Setup] menu contains some important settings relating to the camera's clock and power. Check the settings of this menu before proceeding to use the camera.

2 Press ▲/▼ of the cursor button to select the menu item and press [MENU/SET].

- The menu item can also be selected by rotating the rear dial.
- You can also move to the next screen by pressing [DISP].



(In touch operation)

Touch the menu item.

- The page can be changed by touching [▲]/[▼].



3 Press ▲/▼ of the cursor button to select the setting and press [MENU/SET].

- You can also select the setting by rotating the rear dial.
- Depending on the menu item, its setting may not appear or it may be displayed in a different way.



(In touch operation)

Touch the Setting to set.

- There are functions that cannot be set or used depending on the modes or menu settings being used on the camera.

■ Switching to other menus

- 1 Press ◀.
- 2 Press ▲/▼ to select a menu selector icon, such as [↶].
 - You can also select the menu toggle icons by rotating the front dial.
- 3 Press [MENU/SET].



(In touch operation)

Touch a menu selector icon, such as [↶].

■ Close the menu

Press [⏏/➔] or press the shutter button halfway.



(In touch operation)

Touch [↶].

Calling frequently-used menus instantly

(Quick Menu)

By using the Quick Menu, some of the menu settings can be easily found.

- The features that can be adjusted using Quick Menu are determined by the mode or a display style the camera is in.

1 Press [Q.MENU] to display the Quick Menu.

- You can also use the button as a function button. (P55)

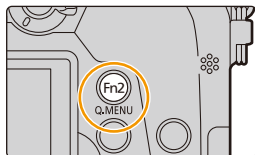

2 Rotate the front dial to select the menu item.

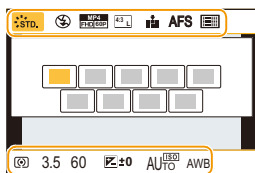

3 Rotate the rear dial to select the setting.

4 Press [Q.MENU] to exit the menu once the setting is complete.

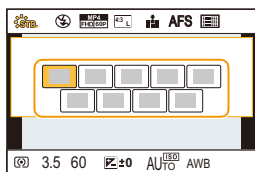

- You can also set items by pressing the cursor buttons ▲/▼/◀/▶.

On-monitor recording information in [] (Monitor style) (P45)

Select the item by pressing the [Q.MENU] button and rotating the rear dial, and then select the setting by rotating the front dial.

- You can also set with ▲/▼/◀/▶ and [MENU/SET].

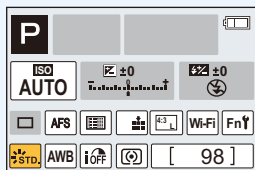

Customizing the Quick Menu settings

When [Q.MENU] (P217) in the [Custom] menu is set to [CUSTOM], the Quick Menu can be changed as desired.

Up to 15 items can be set to the Quick Menu.

- 1 Press **▼** to select [**Q**] and then press [MENU/SET].

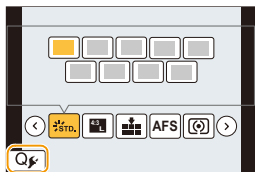

- 2 Press **▲/▼/◀/▶** to select the menu item in the top row and then press [MENU/SET].
- 3 Press **◀/▶** to select the empty space in the bottom row and then press [MENU/SET].

(A) Items that can be set

(B) Set items

- You can also set the menu item by dragging it from the top row to the bottom row.
- If there is no empty space in the bottom row, you can replace an existing item with a new select item by selecting the existing item.
- To cancel the setting, move to the bottom row by pressing **▼** and select an item to cancel, and then press [MENU/SET].

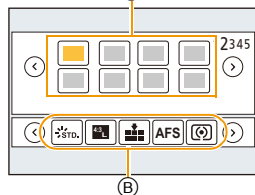

- 4 Press [**⏏/↶**].

- It will return to screen of step 1.
Press [MENU/SET] to switch to the recording screen.

Assigning frequently used functions to the buttons (function buttons)

You can assign recording functions, etc. to specific buttons and icons.

- Some functions cannot be assigned depending on the function button.

1 Select the menu. (P51)

MENU → **fC [Custom]** → **[Fn Button Set]** →
[Setting in REC mode]/[Setting in PLAY mode]

2 Press ▲/▼ to select the function button you want to assign a function to and then press [MENU/SET].

3 Press ▲/▼ to select the function you want to assign and then press [MENU/SET].

- For details on the functions that can be assigned in [Setting in REC mode], refer to [P56](#).
- For details on the functions that can be assigned in [Setting in PLAY mode], refer to [P57](#).
- To restore the default function button settings, select [Restore to Default].

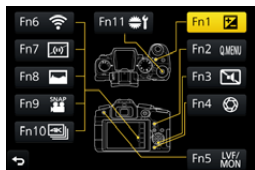

■ Configuring the function button settings from the on-monitor recording information screen

Touching [Fn] on the on-monitor recording information screen ([P45](#)) also allows you to display the screen in step **2**.

■ Rapidly assigning functions

The button assignment screen displayed in step **3** above can be displayed by pressing and holding a function button (any of [Fn1] to [Fn5] or [Fn11]) for 2 seconds.

- In some cases the function assignment screen cannot be displayed depending on the mode or display screen.

Using the function buttons during recording

You can use assigned functions by pressing a function button when recording.

■ Using function buttons with touch operations

- 1 Touch [F1].
- 2 Touch [Fn6], [Fn7], [Fn8], [Fn9] or [Fn10].



■ Functions that can be assigned in [Setting in REC mode]

[Rec] menu/Recording functions	
<ul style="list-style-type: none"> – [Exposure Comp.] (P106): [Fn1]* – [Wi-Fi] (P250): [Fn6]* – [Q.MENU] (P53): [Fn2]* – [LVF/Monitor Switch] (P37): [Fn5]* – [LVF/Monitor Disp. Style] (P46) – [AF/AE LOCK] (P105) – [AF-ON] (P104, 105) – [Preview] (P72): [Fn4]* – [One Push AE] (P73) – [Touch AE] (P50) – [Level Gauge] (P46): [Fn7]* – [Focus Area Set] (P57) – [Zoom Control] (P148) – [Cursor Button Lock] (P57) – [Dial Operation Switch] (P42): [Fn11]* – [Photo Style] (P186) – [Filter Effect] (P79, 188) – [Aspect Ratio] (P189) – [Picture Size] (P190) – [Quality] (P191) – [AFS/AFF] (P92) 	<ul style="list-style-type: none"> – [Metering Mode] (P192) – [Burst Rate] (P115) – [4K PHOTO] (P118): [Fn10]* – [Self Timer] (P135) – [Bracket] (P141) – [Highlight Shadow] (P193) – [i.Dynamic] (P194) – [i.Resolution] (P194) – [HDR] (P195) – [Shutter Type] (P197) – [Flash Mode] (P157) – [Flash Adjust.] (P160) – [Wireless Flash Setup] (P162) – [Ex. Tele Conv.] (still pictures/motion pictures) (P149) – [Digital Zoom] (P151) – [Stabilizer] (P144) – [Sensitivity] (P108) – [White Balance] (P110) – [AF Mode/MF] (P93, 102) – [Restore to Default]
[Motion Picture] menu	
<ul style="list-style-type: none"> – [4K Live Cropping] (P169) – [Snap Movie] (P174): [Fn9]* – [Motion Pic. Set] ([Rec Format] (P166)/[Rec Quality] (P166)) 	<ul style="list-style-type: none"> – [Picture Mode] (P172) – [Mic. Directivity Adjust] (P307)



[Custom] menu

– [Silent Mode] (P209): [Fn3]*	– [Monochrome Live View] (P216)
– [Peaking] (P213)	– [Rec Area] (P217)
– [Histogram] (P214): [Fn8]*	– [Step Zoom] (P152)
– [Guide Line] (P214)	– [Zoom Speed] (P152)
– [Zebra Pattern] (P215)	– [Touch Screen] (P218)

* Function button settings at the time of purchase.

- When set to [Focus Area Set], it is possible to display the position setting screen of either AF area or MF Assist.
- Operations of the cursor button and [MENU/SET] are disabled when [Cursor Button Lock] is set. Press the function button again to enable them.



Not available in these cases:

- [Fn2] cannot be used in the following cases.
 - When recording with [] ([4K Burst(S/S)]) of the 4K Photo function
 - When using [Time Lapse Shot]
- [Fn4] cannot be used in the following cases.
 - Intelligent Auto Plus Mode
 - Creative Control Mode
 - When using [Multi Exp.]
 - When [4K Live Cropping] is set
- [Fn6], [Fn7], [Fn8], [Fn9], and [Fn10] cannot be used when the viewfinder is in use.

Using the function buttons during playback

You can directly set an assigned function to a selected image by pressing the function button during playback.

Example: When [Fn2] is set to [Favorite]

- 1 Press /  to select the picture.
- 2 Press [Fn2], and then set the image as [Favorite].



■ Functions that can be assigned in [Setting in PLAY mode]

- The following functions can be assigned to the button [Fn1], [Fn2], [Fn5] or [Fn11].

[Playback] Menu/Playback functions

– [Wi-Fi] (P250): [Fn1]*	– [Protect] (P247)
– [LVF/Monitor Switch] (P37): [Fn5]*	– [Delete Single] (P184)
– [Favorite] (P245): [Fn2]*	– [Off]: [Fn11]*
– [Print Set] (P246)	– [Restore to Default]

* Function button settings at the time of purchase.

Entering Text

1 Press ▲/▼/◀/▶ to select text and then press [MENU/SET] to register.

- Move the cursor to [Aa] and then press [MENU/SET] to switch text between [A] (capitals), [a] (lower case), [1] (numbers) and [&] (special characters).
- To enter the same characters in a row, move the cursor by rotating the rear dial to the right.
- The following operations can be performed by moving the cursor to the item and pressing [MENU/SET]:
 - []: Enter a blank
 - [Delete]: Delete a character
 - [◀]: Move the entry position cursor to the left
 - [▶]: Move the entry position cursor to the right
- A maximum of 30 characters can be entered.
(Maximum of 9 characters when setting names in [Face Recog.])
- A maximum of 15 characters can be entered for [], [Γ], []], [•] and [—].
(Maximum of 6 characters when setting names in [Face Recog.])



2 Press ▲/▼/◀/▶ to move the cursor to [Set] and then press [MENU/SET] to end text input.

3.

Recording Modes

Taking Pictures using the Automatic Function (Intelligent Auto Mode)

Recording Mode:  

In this mode, the camera makes the optimal settings for the subject and scene, so we recommend it when you wish to leave the settings to the camera and record without thinking about them.

1 Set the mode dial to .

- The camera will switch to either the most recently used of Intelligent Auto Plus Mode or Intelligent Auto Mode. At the time of purchase, the mode is set to Intelligent Auto Plus Mode.

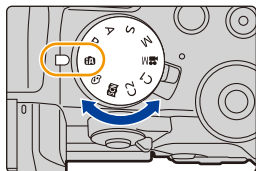

2 Align the screen with the subject.

- When the camera identifies the optimum scene, the icon of the scene concerned is displayed in blue for 2 seconds, after which its color changes to the usual red. (Automatic scene detection)



The camera detects scenes automatically (Scene Detection)

(📷: When taking pictures, 📹: When recording motion pictures)



[i-Portrait]



[i-Scenery]



[i-Macro]



[i-Night Portrait]*1



[i-Night Scenery]



[iHandheld Night Shot]*2



[i-Food]

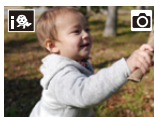

[i-Baby]*3



[i-Sunset]



[i-Low Light]



IA+

*1 Only displayed when the built-in flash is open.

*2 Only displayed when [iHandheld Night Shot] is set to [ON]. (P62)

*3 When [Face Recog.] is set to [ON], [IA+] will be displayed for birthdays of registered faces already set only when the Face/Eye of a person younger than 3 years old is detected.

- [IA+] is set if none of the scenes are applicable, and the standard settings are set.
- When recording is performed with the 4K Photo or Post Focus function, Scene Detection works in the same way as when motion picture is recorded.

Switching between Intelligent Auto Plus Mode and Intelligent Auto Mode

Select the [IA+] or [IA] tab on the menu screen, press ► to select [IA+] or [IA], and press [MENU/SET].



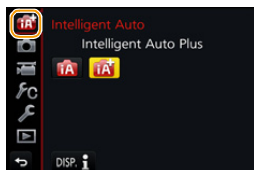

It is also possible to display the selection screen by touching the Recording Mode icon in recording screen.







Intelligent Auto Plus Mode allows you to adjust some settings such as the brightness and color tone while also using Intelligent Auto Mode for other settings so that you can record images more suited to your preferences. To record images with more ease, use Intelligent Auto Mode.

(○: possible, —: not possible)

	 Intelligent Auto Plus Mode	 Intelligent Auto Mode
Setting the brightness	○	—
Setting the color tone	○	—
Defocus Control	○	—
Menus that can be set	Many	Few





■ Auto Focus, Face/Eye Detection, and Face Recognition





The Auto Focus Mode is automatically set to . If you touch the subject, the AF tracking function will work. The AF tracking function (P95) will also work if you press  and then press the shutter button halfway.

- When [Face Recog.] is set to [ON], and the face similar to the registered face is detected, [R] is displayed in the top right of ,  and .



■ About the flash

When the flash is open, the camera automatically sets ,  (AUTO/Red-Eye Reduction),  or  to match the type of subject and brightness.

- **Open the flash when the flash is to be used. (P154)**
- When  or  is set, Red-Eye Removal is enabled.
- Shutter speed will be slower during  or .

■ Scene Detection

- If a tripod is used, for instance, and the camera has judged that camera shake is minimal when the scene detection has been identified as , the shutter speed will be slower than normal. Take care not to move the camera while taking pictures.
- Depending on recording conditions, different scene types may be selected for the same subject.



The Backlight Compensation

- When there is a backlight, the subject appears darker and the camera will automatically attempt to correct it by increasing the brightness of the picture. In Intelligent Auto Plus Mode or Intelligent Auto Mode, backlight compensation works automatically.

Taking handheld shots of night scenes ([iHandheld Night Shot])

Recording Mode:  



When [] is detected while taking handheld night shots, pictures of the night scenery will be taken at a high burst speed and composed into a single picture.

This mode is useful if you want to take stunning night shots with minimal jitter and noise, without using a tripod.

MENU →  **[Rec]** → **[iHandheld Night Shot]** → **[ON]/[OFF]**

- The angle of view will be slightly narrower.
- Do not move the camera during the continuous shooting after pressing the shutter button.
- Flash is fixed to [] (forced flash off).

Not available in these cases:

- [iHandheld Night Shot] does not work for the pictures taken during a motion picture recording.
- This function is not available in the following cases:
 - When recording 4K photos
 - When recording with the Post Focus function
 - When recording in Burst Mode
 - When recording with the Bracket function
 - When [Quality] is set to [RAW, [RAW] or [RAW]
 - When [Ex. Tele Conv.] in the [Rec] menu is set
 - When using [Time Lapse Shot]
 - When using [Stop Motion Animation] (only when [Auto Shooting] is set)

Combining pictures into a single picture with rich gradation ([iHDR])

Recording Mode:  

When there is, for example, strong contrast between the background and the subject, multiple still pictures are recorded with differing exposures and combined to create a single still picture rich in gradation.

[iHDR] works automatically as needed. When it does, [HDR] is displayed on the screen.

MENU →  **[Rec]** → **[iHDR]** → **[ON]/[OFF]**

- The angle of view will be slightly narrower.
- Do not move the camera during the continuous shooting after pressing the shutter button.
- You cannot take the next picture until the combination of pictures is complete.
- A moving subject may be recorded with unnatural blurs.

Not available in these cases:

- [iHDR] does not work for the pictures taken during a motion picture recording.
- This function is not available in the following cases:
 - When recording using the flash
 - When recording in Burst Mode
 - When recording 4K photos
 - When recording with the Post Focus function
 - When recording with the Bracket function
 - When [Quality] is set to [RAW⁺], [RAW₊] or [RAW]
 - When [Ex. Tele Conv.] in the [Rec] menu is set
 - When using [Time Lapse Shot]
 - When using [Stop Motion Animation] (only when [Auto Shooting] is set)

Taking a picture with a blurred background (Defocus Control)

Recording Mode: 

- 1 Press [Fn4] to display the setting screen.
- 2 Set the blurriness by rotating the rear dial.



Strong defocus



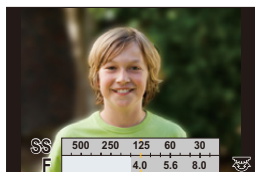

Weak defocus



- If you press [MENU/SET], you can return to the recording screen.
- Pressing [Fn4] on the blurriness setting screen will cancel the setting.

■ When operating the touch screen

- 1 Touch .
- 2 Touch  to display the setting screen.
- 3 Drag the exposure meter to set the blurriness.
 - If you press [MENU/SET], you can return to the recording screen.
 - Pressing [Fn4] on the blurriness setting screen will cancel the setting.





- Auto Focus Mode is set to .

- The position of the AF area can be set by touching the screen. (Its size cannot be changed)
- Depending on the lens used, you may hear a sound from the lens when the Defocus Control is used, but this is due to operation of the aperture of the lens and it is not a malfunction.
- Depending on the lens used, operational sound of the Defocus Control may be recorded during the recording of a motion picture when the function is used.

Recording images by changing the brightness or color tone

Recording Mode: 

■ Setting brightness

- 1 Press [].
- 2 Rotate the rear dial to adjust brightness.
 - You can adjust the Exposure Bracket setting by pressing ▲/▼ while the brightness setting screen is displayed. (P142)
 - Press [] again to return to the recording screen.

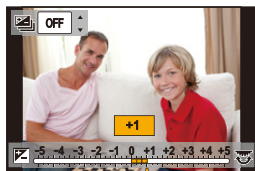



■ Setting color

- 1 Press ► to display the setting screen.
- 2 Rotate the rear dial to adjust color.
 - Press [MENU/SET] to return to the recording screen.



■ Change the settings by using the touch screen

- 1 Touch [].
- 2 Touch the item you want to set.
 - []: Color tone
 - []: Brightness
- 3 Drag the slide bar to set.
 - Press [MENU/SET] to return to the recording screen.

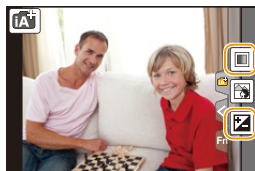

• The color setting will return to the default level (center point) when this unit is turned off or the camera is switched to another Recording Mode.

Taking Pictures with Automatically Adjusted Aperture and Shutter Speed (Program AE Mode)

Recording Mode: **[P]**

The camera automatically sets the shutter speed and the aperture value according to the brightness of the subject.

You can take pictures with greater freedom by changing various settings in the [Rec] menu.

- 1** Set the mode dial to **[P]**.
- 2** Press the shutter button halfway and display the aperture value and shutter speed value on the screen.

- (A) Aperture value
- (B) Shutter speed

- If the exposure is not adequate when the shutter button is pressed halfway, the aperture value and shutter speed turn red and blink.

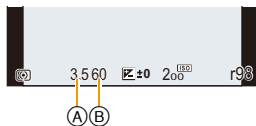

Program Shift

In Program AE Mode, you can change the preset aperture value and shutter speed without changing the exposure. This is called Program Shift.

You can make the background more blurred by decreasing the aperture value or record a moving subject more dynamically by slowing the shutter speed when taking a picture in Program AE Mode.

- 1 Press the shutter button halfway and display the aperture value and shutter speed value on the screen.
- 2 While the values are displayed (about 10 seconds), perform Program Shift by rotating the rear dial or front dial.

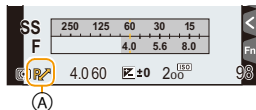

(A) Program Shift indication

- To cancel Program Shift, turn off this unit or rotate the front/rear dial until the Program Shift indication disappears.

Program Shift can easily be canceled by setting a function button to [One Push AE]. (P73)

Not available in these cases:

- Program Shift is not available in the following cases:
 - When recording 4K photos
 - When recording with the Post Focus function
 - When the ISO sensitivity is set to [ISO]



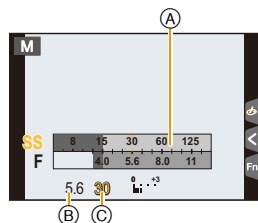

Taking Pictures by Specifying the Aperture/ Shutter Speed

Recording Mode: **A S M**

(Example: In Manual Exposure Mode)



- (A) Exposure meter
- (B) Aperture value
- (C) Shutter speed

<p>Aperture value</p>	 <p>Small It becomes easier to defocus the background.</p>	 <p>Large It becomes easier to maintain focus as far as the background.</p>
<p>Shutter speed</p>	 <p>Slow It becomes easier to express movement.</p>	 <p>Fast It becomes easier to freeze movement.</p>

- The effects of the set aperture value and shutter speed will not be visible on the recording screen. To check on the recording screen, please use [Preview]. (P72)
- The brightness of the screen and the recorded pictures may differ. Check the pictures on the playback screen.
- Rotate the front/rear dial to display the Exposure Meter. Unsuitable areas of the range are displayed in red.
- If the exposure is not adequate, the aperture value and the shutter speed turn red and blink when the shutter button is pressed halfway.

Aperture-Priority AE Mode

When you set the aperture value, the camera automatically optimizes the shutter speed for the brightness of the subject.

- 1 Set the mode dial to [A].
- 2 Set the aperture value by rotating the rear dial or the front dial.

- (A) Aperture value
- (B) Exposure meter

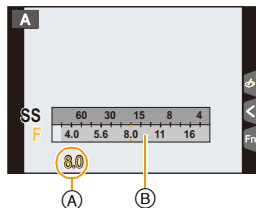

- When using a lens having an aperture ring, set the position of the aperture ring to [A] to activate the front/rear dial settings. At positions other than [A], the ring setting takes priority.

Shutter-Priority AE Mode

When you set the shutter speed, the camera automatically optimizes the aperture value for the brightness of the subject.

- 1 Set the mode dial to [S].
- 2 Set the shutter speed by rotating the rear dial or the front dial.

- (A) Shutter speed
- (B) Exposure meter

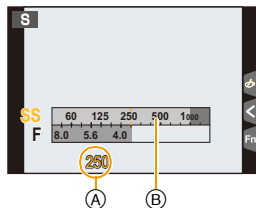

- When the flash is activated, the fastest shutter speed that can be selected is 1/160th of a second. (P159)

Manual Exposure Mode

Determine the exposure by manually setting the aperture value and the shutter speed.

- 1 Set the mode dial to [M].
- 2 Rotate the rear dial to set the shutter speed, and rotate the front dial to set the aperture value.

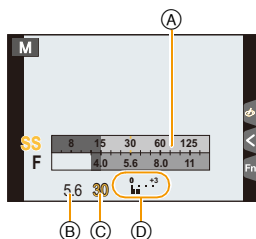

- (A) Exposure meter
- (B) Aperture value
- (C) Shutter speed
- (D) Manual Exposure Assistance

Available Shutter Speed (Sec.)

[B] (Bulb), 60 to 1/4000th (with the mechanical shutter)
 [B] (Bulb), 60 to 1/2000th (with the electronic front curtain)
 1 to 1/16000th (with the electronic shutter)



Optimizing the ISO sensitivity for the shutter speed and aperture value

When the ISO sensitivity is set to [AUTO], the camera sets the ISO sensitivity automatically so that the exposure will be appropriate for the shutter speed and aperture value.

- Depending on recording conditions, an appropriate exposure may not be set or the ISO sensitivity may become higher.



Manual Exposure Assistance

	The exposure is adequate.
	Set to faster shutter speed or larger aperture value.
	Set to slower shutter speed or smaller aperture value.

- The Manual Exposure Assistance is an approximation. We recommend checking the pictures on the playback screen.

- When you use a lens with an aperture ring, the aperture ring setting takes priority.
- When the flash is activated, the fastest shutter speed that can be selected is 1/160th of a second. (P159)

■ About [B] (Bulb)

If you set the shutter speed to [B], the shutter stays open while the shutter button is pressed fully (up to approximately 120 seconds).

The shutter closes if you release the shutter button.

Use this when you want to keep the shutter open for a long time to take pictures of fireworks, a night scene etc.

- It can only be used with Manual Exposure Mode.



- We recommend using a tripod or the shutter remote control (DMW-RSL1: optional) when you take pictures with the shutter speed set to [B]. Refer to [P309](#) for information about the shutter remote control.
- When you take pictures with the shutter speed set to [B], noise may become visible. To avoid picture noise, we recommend setting [Long Shtr NR] in the [Rec] menu to [ON] before taking pictures. ([P200](#))



Not available in these cases:

- This function is not available in the following cases:
 - When recording using the flash (only when [Flash Synchro] is set to [2ND])
 - When recording 4K photos
 - When recording with the Post Focus function
 - When recording with the Bracket function
 - When [HDR] is set to [ON]
 - When using the electronic shutter
 - When [Silent Mode] is set to [ON]
 - When using [Time Lapse Shot]
 - When using [Stop Motion Animation] (only when [Auto Shooting] is set)

Confirm the Effects of Aperture and Shutter Speed (Preview Mode)

Applicable modes: **[Fn]** **[Fn]** **P** **A** **S** **M** **[M]** **[SCN]** **[Fn]**

The effects of aperture and shutter speed can be checked by using the Preview Mode.

- **Confirm the effects of aperture:** You can check the depth of field (effective focus range) before taking a picture by closing the diaphragm blades to the aperture value you set.
- **Confirm the effects of shutter speed:** Movement can be confirmed by displaying the actual picture that will be taken with that shutter speed.

1 Set a function button to [Preview]. (P55)

- The following step is an example in which [Preview] is assigned to [Fn4].

2 Switch to confirmation screen by pressing [Fn4].

- Screen is switched every time [Fn4] is pressed.

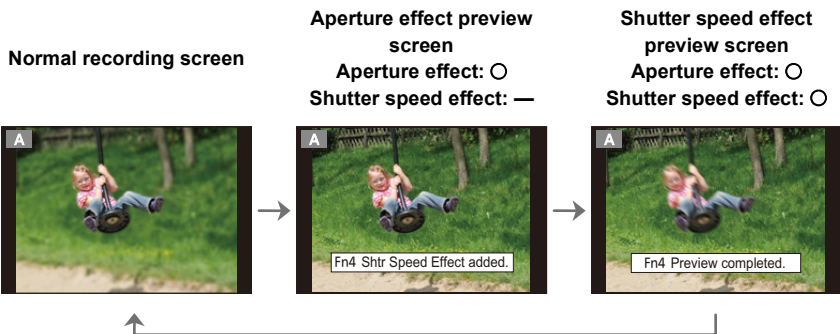

Depth of field properties

	Aperture value	Small	Large
*1	Focus length of the lens	Tele	Wide
	Distance to the subject	Near	Distant
	Depth of field (effective focus range)	Shallow (Narrow)*2	Deep (Wide)*3

*1 Recording conditions

*2 Example: When you want to take a picture with a blurred background etc.

*3 Example: When you want to take a picture with everything in focus including the background etc.

• It is possible to record while in Preview Mode.

• Range for shutter speed effect check is 8 seconds to 1/16000th of a second.

Not available in these cases:

- Preview Mode is not available when recording with [Fn] ([4K Pre-Burst]) of the 4K Photo function.



Easily set aperture/shutter speed for suitable exposure (One Push AE)

Applicable modes:   **P** **A** **S** **M**   

When the exposure setting is too bright or too dark, you can use one push AE to achieve a suitable exposure setting.



How to tell if the exposure is not adequate

- If the aperture values and shutter speed blink red when the shutter button is pressed halfway.
- If the Manual Exposure Assistance (P70) is anything other than   when in Manual Exposure mode.

1 Set a function button to [One Push AE]. (P55)

2 (When exposure is not adequate)

Press function button.



Blink red

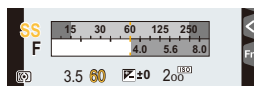

The exposure is changed to give a suitable exposure.

- The exposure meter is displayed, and the aperture and shutter speed are changed to give a suitable exposure.
- In the following cases, suitable exposure cannot be set.
 - When the subject is extremely dark and it is not possible to achieve adequate exposure by changing the aperture value or shutter speed
 - When recording using the flash
 - In Preview Mode (P72)
 - When using a lens that includes an aperture ring

Taking Pictures that match the Scene being recorded (Scene Guide Mode)

Recording Mode: 

If you select a scene to suit the subject and recording conditions with reference to the example images, the camera will set optimal exposure, color, and focus, allowing you to record in a manner appropriate to the scene.

1 Set the mode dial to .

2 Press  to select the scene.

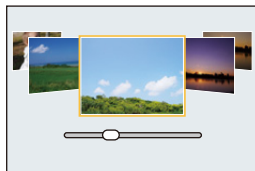

- The scene can also be selected by dragging an example image or the slide bar.

3 Press .



- It is also possible to display the selection screen by touching the Recording Mode icon in recording screen.



- To change the Scene Guide Mode, select the  tab on the menu screen, select [Scene Switch], and then press [MENU/SET]. You can return to step **2** on [P74](#).
- The following items cannot be set in Scene Guide Mode because the camera automatically adjusts them to the optimal setting.
 - Items other than the picture quality adjustment in [Photo Style]
 - [Sensitivity]
 - [Filter Settings]
 - [Metering Mode]
 - [Highlight Shadow]
 - [HDR]
 - [Multi Exp.]
 - [Digital Zoom]
- Although White Balance is fixed to [AWB] for certain types of scene, you can fine tune the White Balance ([P112](#)) or use White Balance bracketing ([P113](#)) by pressing the cursor button  on the recording screen.
- Depending on the scene, the recording screen may seem as if frames are missed.

Types of Scene Guide Mode



Displaying the description of each scene and recording tips

Press [DISP.] while the scene selection screen is displayed.

• When it is set to the guide display, detailed explanations and tips for each scene are displayed.

Normal display

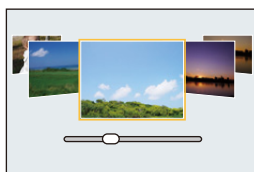

Guide display

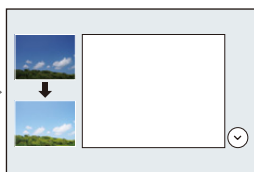

List display

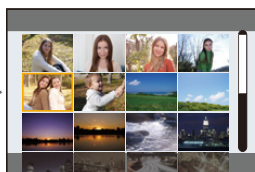
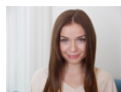
**[Clear Portrait]****[Silky Skin]**

- The smoothing effect is applied to the part that has a similar tone to the complexion of a subject, as well.
- This mode may not be effective under insufficient lighting.

**[Backlit Softness]****[Clear in Backlight]****[Relaxing Tone]****[Sweet Child's Face]**

Touch the face.

- A still picture is recorded with the focus and exposure set for the touched location.

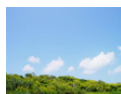
**[Distinct Scenery]****[Bright Blue Sky]****[Romantic Sunset Glow]****[Vivid Sunset Glow]**

**[Glistening Water]**

- Star filter used in this mode may cause glistening effects on the objects other than water surface.

**[Cool Night Sky]****[Artistic Nightscape]****[Handheld Night Shot]**

- Do not move the unit during the continuous shooting after pressing the shutter button.
- The angle of view will be slightly narrower.

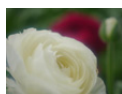
**[Soft Image of a Flower]**

- For close-up recording, we recommend that you close the flash and avoid using it.

**[Cute Dessert]**

- For close-up recording, we recommend that you close the flash and avoid using it.

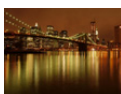
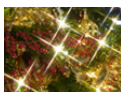
**[Clear Sports Shot]****[Panorama Shot]****[Clear Nightscape]****[Warm Glowing Nightscape]****[Glittering Illuminations]****[Clear Night Portrait]**

- We recommend using a tripod and the self-timer.
- When [Clear Night Portrait] is selected, keep the subject still for about 1 second after taking the picture.

**[Appetizing Food]**

- For close-up recording, we recommend that you close the flash and avoid using it.

**[Freeze Animal Motion]**

- The initial setting for the AF assist lamp is [OFF].

**[Monochrome]**

Taking panorama pictures ([Panorama Shot])

- When [Panorama Shot] is selected, after a screen is displayed asking you to check the recording direction, horizontal/vertical guidelines are displayed.

- Press the shutter button halfway to focus.
- Press the shutter button fully and move the camera in a small circle in the direction of the arrow on the screen.

Recording from left to right



Image size: [STANDARD]

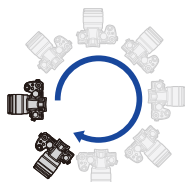

Image size: [WIDE]



Ⓐ Recording direction and panning (Guide)

- Move the camera at a constant speed. Pictures may not be able to be recorded properly if the camera is moved too fast or slow.

- Press the shutter button once again to end the picture recording.
 - Recording can also be ended by keeping the camera still while recording.
 - Recording can also be ended by moving the camera to the end of the guide.

Changing the recording direction and angle of view (image size) of panorama pictures

MENU → [Rec] → [Panorama Settings]

[Direction]	Sets the recording direction.
[Picture Size]	Sets the angle of view (image size). [STANDARD]/[WIDE]

- The number of recording pixels in the horizontal and vertical directions of the panorama picture varies depending on the image size, the recording direction and the number of combined pictures.

The maximum number of pixels is shown below.

Image size	Recording direction	Horizontal Resolution	Vertical Resolution
[STANDARD]	Horizontal	8176 pixels	1920 pixels
	Vertical	2560 pixels	7680 pixels
[WIDE]	Horizontal	8176 pixels	960 pixels
	Vertical	1280 pixels	7680 pixels

■ Technique for Panorama Shot Mode

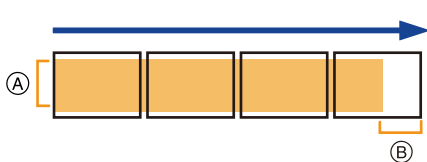

- (A) Move the camera in the recording direction without shaking it. If the camera shakes too much, pictures may not be able to be recorded, or the recorded panorama picture may become narrower (smaller).
- (B) Move the camera towards the edge of the range you wish to record. (The edge of the range will not be recorded in the last frame)

■ About playback

Pressing ▲ will start scrolling playback automatically in the same direction as the recording.

- The following operations can be performed during scrolling playback.

		Start panorama playback/Pause*
		Stop

- * When the playback is paused, you can scroll forwards and backwards by dragging the screen. When the scroll bar is touched, the playback position jumps to the touched position.



- When the focal length is long, such as when a telephoto lens is attached, move the camera slowly.
- The focus, White Balance, and exposure are fixed at the optimum values for the first picture. As a result, if the focus or brightness changes substantially during recording, the entire panorama picture may not be recorded at the suitable focus or brightness.
- When multiple pictures are combined to create a single panorama picture, the subject may appear distorted or the connection points may be noticeable in some cases.

Not available in these cases:

- A panorama picture may not be able to be created, or the pictures may not be combined properly when recording the following subjects or under the recording conditions below.
 - Subjects with a single, uniform color or repetitive pattern (such as the sky or a beach)
 - Moving subjects (person, pet, car, waves, flowers blowing in the breeze, etc.)
 - Subjects where the color or patterns change in a short time (such as an image appearing on a display)
 - Dark places
 - Locations with flickering light sources such as fluorescent lights or candles

Taking Pictures with different image effects

(Creative Control Mode)

Recording Mode: 

This mode records with additional image effects.

You can set the effects to add by selecting example images and checking them on the screen.

1 Set the mode dial to .

2 Press $\blacktriangle/\blacktriangledown$ to select the image effects (filters).

A Preview display

- You can also select the image effects (filters) by touching the example images.

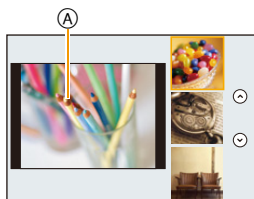

- It is also possible to display the selection screen by touching the Recording Mode icon in recording screen.



3 Press [MENU/SET].

- If you select the  tab on the menu screen, you can select the following menu items:

- [Filter Effect]: Displays the image effect (filter) selection screen.
- [Simultaneous record w/o filter]: Allows you to set the camera to take a picture with and without an image effect simultaneously. (P189)

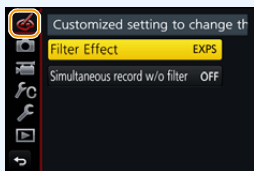

- White Balance will be fixed to [AWB], and [Sensitivity] will be fixed to [AUTO].
- Depending on the image effect, the recording screen may seem as if frames are missed.

Types of image effects



Displaying the description of each image effect

Press **[DISP.]** while the image effect selection screen is displayed.

- When it is set to the guide display, explanations for each picture effect are displayed.

Normal display

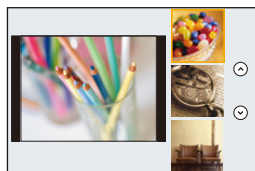

Guide display

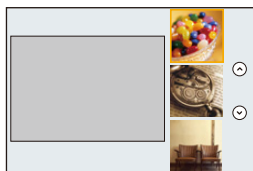

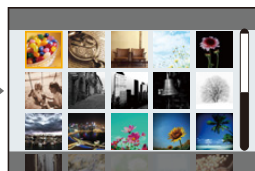

List display

**[Expressive]****[Retro]****[Old Days]****[High Key]****[Low Key]****[Sepia]****[Monochrome]****[Dynamic Monochrome]****[Rough Monochrome]****[Silky Monochrome]****[Impressive Art]****[High Dynamic]****[Cross Process]****[Toy Effect]****[Toy Pop]****[Bleach Bypass]****[Miniature Effect]****[Soft Focus]****[Fantasy]****[Star Filter]****[One Point Color]****[Sunshine]**

■ Setting the type of defocus ([Miniature Effect])

1 Press [Fn3] to display the setting screen.

- Setting screen can also be displayed by touching in order of [] then [].

2 Press ▲/▼ or ◀/▶ to move the in-focus portion.

- You can also move the in-focus portion by touching the screen on the recording screen.
- Touching [] allows you to set the recording orientation (defocus orientation).



3 Rotate the rear dial to change the size of in-focus portion.



- The portion can also be enlarged/reduced by pinching out/pinching in (P48) the screen.
- Pressing [DISP.] will return the in-focus portion setting back to the default setting.

4 Press [MENU/SET] to set.

- No sound is recorded in motion pictures.
- Approximately 1/10 of the time period is recorded.
(If you record for 10 minutes, the resulting motion picture recording will be approximately 1 minute long.)
The displayed available recording time is approximately 10 times.
- If you end motion picture recording after a short time, the camera may go on recording for a certain period.

■ Set the color to leave in ([One Point Color])

1 Press [Fn3] to display the setting screen.

- Setting screen can also be displayed by touching in order of [] then [].

2 Select the color you want to leave by moving the frame with ▲/▼/◀/▶.

- You can also select the color you want to leave by touching the screen.
- Pressing [DISP.] will return the frame back to the center.



3 Press [MENU/SET] to set.

- Depending on the subject, the set color may not be left in.

■ Setting the position and size of the light source ([Sunshine])

1 Press [Fn3] to display the setting screen.

- Setting screen can also be displayed by touching in order of [👉] then [🔍].

2 Press ▲/▼/◀/▶ to move the center position of the light source.

- The position of the light source can also be moved by touching the screen.



Point for when placing the center of the light source

A more natural appearance can be created by placing the center of the light source outside the image.

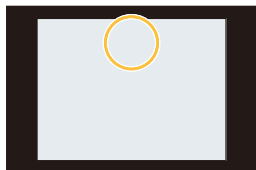

3 Adjust the size of the light source by rotating the rear dial.

- The display can also be enlarged/reduced by pinching out/pinching in.
- Pressing [DISP.] will return the light source setting back to the default setting.

4 Press [MENU/SET] to set.

Adjust the effect to fit your preferences

The strength and colors of the effects can be easily adjusted to fit your preferences.

1 Press ► to display the setting screen.



2 Rotate the rear dial to set.

- Press [MENU/SET] to return to the recording screen.



Image effect	Items that can be set		
[Expressive]	Freshness	Understated colors	↔ Pop colors
[Retro]	Color	Yellowish tinge	↔ Reddish tinge
[Old Days]	Contrast	Low contrast	↔ High contrast
[High Key]	Color	Pinkish tinge	↔ Aquamarinish tinge
[Low Key]	Color	Reddish tinge	↔ Bluish tinge
[Sepia]	Contrast	Low contrast	↔ High contrast



Image effect	Items that can be set		
[Monochrome]	Color	Yellowish tinge ↔	Bluish tinge
[Dynamic Monochrome]	Contrast	Low contrast ↔	High contrast
[Rough Monochrome]	Grittiness	Less gritty ↔	Grittier
[Silky Monochrome]	Extent of defocus	Weak defocus ↔	Strong defocus
[Impressive Art]	Freshness	Black and white ↔	Pop colors
[High Dynamic]	Freshness	Black and white ↔	Pop colors
[Cross Process]	Color	Greenish tinge/Bluish tinge/Yellowish tinge/ Reddish tinge	
[Toy Effect]	Color	Orangish tinge ↔	Bluish tinge
[Toy Pop]	Area with reduced peripheral brightness	Small ↔	Large
[Bleach Bypass]	Contrast	Low contrast ↔	High contrast
[Miniature Effect]	Freshness	Understated colors ↔	Pop colors
[Soft Focus]	Extent of defocus	Weak defocus ↔	Strong defocus
[Fantasy]	Freshness	Understated colors ↔	Pop colors
[Star Filter]		Length of the rays of light Short ↔ Long	
		Number of the rays of light Smaller ↔ Larger	
		Angle of the rays of light Rotate to the left ↔ Rotate to the right	
[One Point Color]	Amount of color left	Small amount of color ↔	Large amount of color
[Sunshine]	Color	Yellowish tinge/Reddish tinge/Bluish tinge/Whitish tinge	

Taking a picture with a blurred background (Defocus Control)

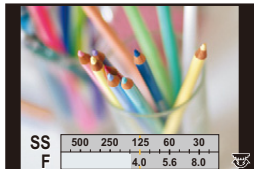

- 1 Press [Fn4] to display the setting screen.
- 2 Rotate the rear dial to set.
 - If you press [MENU/SET], you can return to the recording screen.
 - Pressing [Fn4] on the blurriness setting screen will cancel the setting.



Not available in these cases:



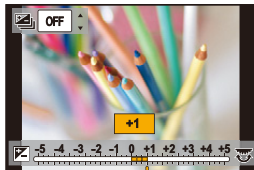

- This function is not available in the following case:
 - [Miniature Effect] (Creative Control Mode)

Setting brightness

- 1 Press [].
- 2 Rotate the rear dial to set.
 - You can adjust the Exposure Bracket setting by pressing ▲/▼ while the brightness setting screen is displayed. (P142)
 - Press [] again to return to the recording screen.



■ Change the settings by using the touch screen

- 1 Touch [].
- 2 Touch the item you want to set.
 - []: Adjusts an image effect
 - []: Defocus level
 - []: Brightness
- 3 Drag the slide bar to set.
 - Press [MENU/SET] to return to the recording screen.

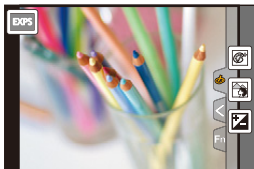

Recording motion pictures with manually set aperture value/shutter speed (Creative Video Mode)

Recording Mode: 

It is possible to manually change the aperture and shutter speed and record motion pictures.

- 1 Set the mode dial to .
- 2 Select the menu. (P51)

MENU →  **[Motion Picture]** → **[Exposure Mode]** → **[P]/[A]/[S]/[M]**

- The operation for changing the aperture value or shutter speed is the same as the operation for setting the mode dial to **P**, **A**, **S** or **M**.

 It is also possible to display the selection screen by touching the Recording Mode icon in recording screen.



- 3 Press the motion picture button (or shutter button) to start recording.
- 4 Press the motion picture button (or shutter button) again to stop recording.

- When [Exposure Mode] is set to [M], [AUTO] of the ISO sensitivity will switch to [200].

Minimizing operational sounds during motion picture recording







The operational sound of the zoom or button operation may be recorded when it is operated during the recording of a motion picture.

Using touch icons allows silent operation while recording motion pictures.

1 Start recording.



2 Touch [].

3 Touch icon.

	Zoom (When an interchangeable lens compatible with power zoom is used)
	Aperture value
	Shutter speed
	Exposure Compensation
	ISO sensitivity
	Mic level adjustment

4 Drag the slide bar to set.

- The speed of the operation varies depending on the position you touch.

	Changes the setting slowly
	Changes the setting quickly

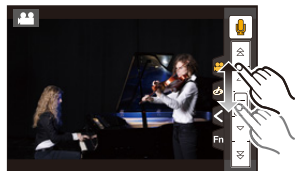

5 Stop recording.

Registering your preferred settings (Custom Mode)

Recording Mode: **C1** **C2**

Registering Personal Menu Settings (Registering custom settings)

Up to 4 sets of current camera settings can be registered using [Cust.Set Mem.]. (C1, C2-1, C2-2, C2-3)

- Initial setting of the Program AE Mode is registered as the custom settings initially.

Preparations:

Set in advance the Recording Mode you wish to save and select the desired menu settings on the camera.

Select the menu. (P51)

MENU → **fC [Custom]** → **[Cust.Set Mem.]** →
Custom set where you want to register settings

- You can register up to three custom sets to **C2** of the mode dial.
- The following menu items are not registered as custom settings.

[Rec] menu	[Setup] menu
<ul style="list-style-type: none"> – Data registered with [Face Recog.] – The [Profile Setup] setting 	<ul style="list-style-type: none"> – All menus
[Custom] menu	[Playback] menu
<ul style="list-style-type: none"> – [Touch Scroll] – [Menu Guide] 	<ul style="list-style-type: none"> – [Rotate Disp.] – [Picture Sort] – [Delete Confirmation]

Recording using registered custom set

You can easily call up the settings you have registered using [Cust.Set Mem.].

Set the mode dial to [C1] or [C2]

- The corresponding custom set will be called up. If you set the mode dial to [C2], the last used custom set will be called up.

■ To change a custom set in [C2]

- 1 Set the mode dial to [C2].
- 2 Press [MENU/SET] to display the menu.
- 3 Press ◀/▶ to select the custom setting you want to use, and then press [MENU/SET].



It is also possible to display the selection screen by touching the Recording Mode icon in recording screen.



- Saving of the selected custom settings is displayed on the screen.



■ Changing the registered content

Registered contents do not change when the menu setting is changed temporarily with the mode dial set to C1 or C2. To change the registered settings, overwrite the registered content using [Cust.Set Mem.] on the custom settings menu.

4.

Focus, Brightness (Exposure) and Color tone Settings

Adjusting Focus Automatically

By setting the optimum Focus Mode or Auto Focus Mode for the subject or recording condition, you can let the camera automatically adjust focus in various scenes.

1 Set the focus mode lever to [AFS/AFF] or [AFC].

- The Focus Mode will be set. (P91)

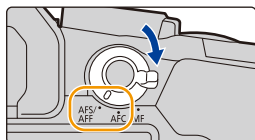

2 Press ◀ ([]).

3 Press ◀/▶ to select AF Mode and then press [MENU/SET].

- The Auto Focus Mode will be set. (P93)

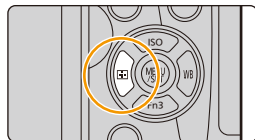

4 Press the shutter button halfway.

- Auto Focus will be activated.

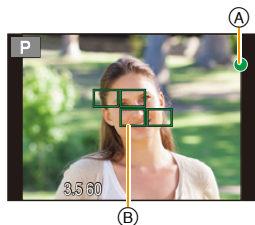

Focus	When the subject is focused	When the subject is not focused
Focus indication (A)	On	Blinks
AF area (B)	Green	—
Sound	Beeps 2 times	—

- The focus indication is displayed as [●_{LOW}] in a dark environment, and focusing may take longer than usual.
- If the camera detects stars in the night sky after displaying [●_{LOW}], Starlight AF will be activated. When focus is achieved, the focus indication [●_{STAR}] and AF areas in focus are displayed. (Detection with Starlight AF works only for approximately 1/3 of the center area of the screen.)



- If you zoom in/out after focusing on a subject, the focus may lose its accuracy. In that case, re-adjust the focus.



Subjects and recording conditions which are difficult to focus

- Fast-moving subjects, extremely bright subjects or subjects without contrast.
- When recording subjects through windows or near shiny objects.
- When it is dark or when jitter occurs.
- When the camera is too close to the subject or when taking a picture of both distant and near subjects.





MENU



Focus Mode (AFS/AFF/AFC)

Applicable modes:        

The method for achieving focus when the shutter button is pressed halfway is set.

Item		Scene (recommended)	
[AFS/ AFF]	[AFS] (Auto Focus Single)	Subject is still (Scenery, anniversary photograph, etc.)	<p>“AFS” is an abbreviation of “Auto Focus Single”. Focus is set automatically when the shutter button is pressed halfway. Focus will be fixed while it is pressed halfway.</p> 
	[AFF] (Auto Focus Flexible)	Movement cannot be predicted (Children, pets, etc.)	<p>“AFF” is an abbreviation of “Auto Focus Flexible”. In this mode, focusing is performed automatically when the shutter button is pressed halfway. If the subject moves while the shutter button is pressed halfway, the focus is corrected to match the movement automatically.</p> 
[AFC] (Auto Focus Continuous)		Subject is moving (Sport, trains, etc.)	<p>“AFC” is an abbreviation of “Auto Focus Continuous”. In this mode, while the shutter button is pressed halfway, focusing is constantly performed to match the movement of the subject. When the subject is moving, the focusing is performed by predicting the subject position at the time of recording. (Movement prediction)</p> 
[MF]		Set the focus manually. (P102)	

■ About [AFS/AFF] of the focus mode lever

In [AFS/AFF] in the [Rec] menu or the [Motion Picture] menu, you can assign [AFS] or [AFF] to [AFS/AFF] of the focus mode lever.



When recording using [AFF], [AFC]

- In [AF Sensitivity] in the [Custom] menu, you can set the focus sensitivity suited for the movement of the subject. (P211)
- It may take time to focus on the subject when you operate the zoom from Wide to Tele or suddenly change the subject from a distant one to a nearby one.
- Press the shutter button halfway again when it is difficult to focus on the subject.
- While the shutter button is pressed halfway, shake may be seen on the screen.

- Focus Mode settings of [AFF] and [AFC] work in the same manner as [AFS] in the following situations:
 - Creative Video Mode
 - When recording with [] ([4K Burst(S/S)]) of the 4K Photo function
 - In low light situations
- When Scene Guide Mode is set to [Panorama Shot], [AFF] and [AFC] are not available.
- [AFF] is not available when recording 4K photos. [Continuous AF] works during recording.
- The Focus Mode setting cannot be changed when recording is performed with the Post Focus function.

Auto Focus Mode

Applicable modes: 

This allows the focusing method that suits the positions and number of the subjects to be selected.

 ([Face/Eye Detection])	<p>The camera automatically detects the person's face and eyes. An eye closer to the camera will be in focus, while the exposure will be optimized for the face. (When [Metering Mode] is set to [☉])</p> <ul style="list-style-type: none"> • Up to 15 faces can be detected. Eyes that can be detected are only those of the face that is in focus. • You can change the eye to be in focus. (P95) • Position and size of the AF area can be changed. (P98) 	
 ([Tracking])	<p>The camera focuses on the subject you specify. The exposure will be optimized for the subject. (When [Metering Mode] is set to [☉].) Focus and exposure will keep on following the subject even if it moves. (Dynamic tracking) (P95)</p>	
 ([49-Area])	<p>Up to 49 AF areas can be focused. This is effective when a subject is not in the center of the screen.</p> <ul style="list-style-type: none"> • You can select areas to be in focus. (P99) 	
 ([Custom Multi])	<p>From among 49 AF areas, you can freely set the optimum shape of the AF area for the subject. (P96)</p>	
 ([1-Area])	<p>The camera focuses on the subject in the AF area on the screen.</p> <ul style="list-style-type: none"> • Position and size of the AF area can be changed. (P98) 	
 ([Pinpoint])	<p>You can achieve a more precise focus on a point that is smaller than [■]. If you press the shutter button halfway, the screen that lets you check the focus will be enlarged.</p> <ul style="list-style-type: none"> • The focus position can be set on an enlarged screen. (P99) 	





Pressing the shutter button halfway to adjust the composition

When the subject is not in the center of the composition in [■], you can bring the subject into the AF area, fix the focus and exposure by pressing the shutter button halfway, move the camera to the composition you want with the shutter button pressed halfway, and then take the picture.

(Only when the focus mode is set to [AFS].)

■ Restrictions on Auto Focus Mode

- The AF Mode is fixed to [■] in the following cases.
 - When using the Digital Zoom
 - [Miniature Effect] (Creative Control Mode)
- The Auto Focus Mode is fixed to [👤] when [4K Live Cropping] is set.
- It cannot be set the Auto Focus Mode in the following cases.
 - When recording with the Post Focus function
 - When [Pull Focus] in [Snap Movie] is set to [ON]

👤 ([Face/Eye Detection])

- It cannot be set to [👤] in the following cases.
 - [Clear Nightscape]/[Cool Night Sky]/[Warm Glowing Nightscape]/[Artistic Nightscape]/[Glittering Illuminations]/[Handheld Night Shot]/[Appetizing Food]/[Cute Dessert] (Scene Guide Mode)

📷 ([Tracking])

- [📷] cannot be used with [Time Lapse Shot].
- In the following cases, [📷] operates as [■].
 - [Glistening Water]/[Glittering Illuminations]/[Soft Image of a Flower]/[Monochrome] (Scene Guide Mode)
 - [Sepia]/[Monochrome]/[Dynamic Monochrome]/[Rough Monochrome]/[Silky Monochrome]/[Soft Focus]/[Star Filter]/[Sunshine] (Creative Control Mode)
 - [Monochrome]/[L.Monochrome] ([Photo Style])

[+] ([Pinpoint])

- In the following case, [+] operates as [■].
 - When recording motion pictures
 - When recording 4K photos
- It cannot be set to [+] in the following cases.
 - [AFF]/[AFC] (Focus Mode)

About [Face/Eye Detection]

When the camera detects a face, the AF area and the mark indicating the eye to be in focus are displayed.

(A) The eye to be in focus

Yellow:

When the shutter button is pressed halfway, the frame turns green when the camera is focused.

White:

Displayed when more than one face is detected. Other faces that are the same distance away as faces within the yellow AF areas are also focused.

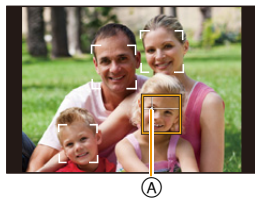

Changing the eye to be in focus

Touch the eye to be in focus.

- Touch the eye in the yellow frame. If you touch any other location, the AF area setting screen will be displayed. (P98)
- If you touch [AF ON/OFF] or press [MENU/SET], the eye focus setting will be canceled.

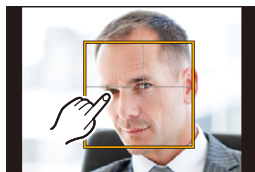

- The Eye Detection cannot be changed when [4K Live Cropping] is set.
- The camera may not detect faces in certain situations, such as when the subjects are moving fast. In such situations, the camera performs the operation of [Tracking].

Locking the subject to be tracked (Tracking)

Button operation

Aim the AF tracking frame over the subject, and press the shutter button halfway.

(A) AF tracking frame

- AF area will turn green when the camera detects the subject.
- The AF area turns yellow when the shutter button is released.
- Lock is canceled when [MENU/SET] is pressed.

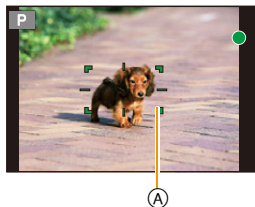

Touch operation

Touch the subject.



- Perform the operation after canceling the touch shutter function.
- The AF area turns yellow while the subject is locked.
- Lock is canceled when [AF ON/OFF] is touched.









- If it fails to lock, AF area will flash in red, and disappear.
- In situations where AF Tracking does not work correctly due to certain recording conditions, such as when the subject is small or the location is dark, the operation of [Tracking] is performed.

Setting the shape of the AF area ([Custom Multi])

Selecting from 49 AF areas, you can freely set the optimum shape of the AF area for the subject.

- 1 Press **◀** ().
- 2 Select a Custom Multi icon (), etc.), and press **▲**.
- 3 Press **◀/▶** to select a setting.

(A) The current shape of the AF area

 ([Horizontal Pattern])	Horizontal line This shape is convenient for taking panning shots or similar shots.	
 ([Vertical Pattern])	Vertical line This shape is convenient for recording objects, such as buildings.	
 ([Central Pattern])	Cluster placed at the center This shape is convenient when you want to bring the center area into focus.	
 ([Custom1]/ [Custom2]/ [Custom3])	You can select a customized setting.	

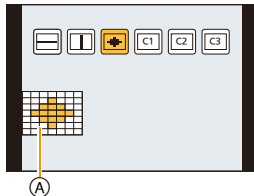

- 4 Press **▼**.
- 5 Select AF areas.
 - The selected AF areas are displayed in yellow.



When selecting [MENU]/[OK]/[+]

Button operation	Touch operation	Description of operation
▲/▼/◀/▶	Touching	Moves the position
	Pinching in/out	Changes the size (3 levels)
[DISP.]	[Reset]	Restores the default setting

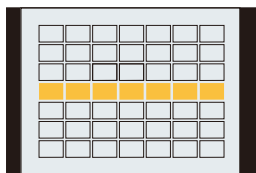

When selecting [C1]/[C2]/[C3]

Touch operation

Drag your finger over the parts you want to set as AF areas.

- If you touch one of the selected AF areas, the selection of the area will be canceled.

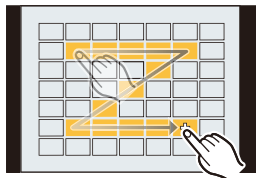

Button operation

Press ▲/▼/◀/▶ to select the AF area, and then press [MENU/SET] to set (repeat).

- The setting is canceled when [MENU/SET] is pressed again.
- If you press [DISP.], all the selections will be canceled.

6 Press [Fn2].





■ Registering the set AF area to [C1], [C2] or [C3]

- 1 On the screen in step 3 on P96, press ▲.
- 2 Press ▲/▼ to select a destination to which the setting will be registered, and press [MENU/SET].

- Turning off this unit will return the setting adjusted with [MENU]/[OK]/[+] back to the default setting.

Setting up position of the AF area/changing size of the AF area

Applicable modes:   **P** **A** **S** **M**   

When [], [], [] or [] in Auto Focus Mode is selected, you can change the position and size of the AF area.

- Perform the operation after canceling the touch shutter function.
- You can also display the AF area setting screen by touching the recording screen. (When [Touch AF] of [Touch Settings] in the [Custom] menu is set to [AF])





- The spot metering target can also be moved to match the AF area when the [Metering Mode] (P192) is set to [].

Not available in these cases:

- This function is not available in the following cases:
 - When using the Digital Zoom
 - When [4K Live Cropping] is set







When selecting [], []

Position and size of the AF area can be changed.



- 1 Press  ().
- 2 Select [] or [] and press .



3 Change the position and size of the AF area.

Button operation	Touch operation	Description of operation
   	Touching	Moves the AF area.
	Pinching out/in	Enlarges/reduces the AF area in small steps.
	—	Enlarges/reduces the AF area in large steps.
[DISP.]	[Reset]	Resets the AF area back to the center. • If you press the button again, the frame size will be reset to the default setting.

4 Press [MENU/SET] to set.

- AF area with the same function as [] is displayed in the touched position, when the [] is selected.

Setting of the AF area is cleared when [MENU/SET] is pressed or [] is touched.

When selecting [AF]

You can set the focus position by selecting the group of AF areas. The 49 AF areas are divided into groups, each consisting of 9 areas (on the edge of the screen, 6 or 4 areas).

Examples of group

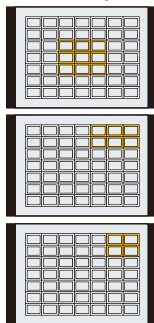

- 1 Press **◀** ([AF]).
- 2 Select [AF] and press **▼**.
- 3 Press **▲/▼/◀/▶** to select an AF area group.
- 4 Press [MENU/SET] to set.
 - Only [+] display (center point of selected group) will remain on the screen.
 - Setting of the AF area frame is cleared when [MENU/SET] is pressed or [AF] is touched.

When selecting [+]

You can set the focus position precisely by enlarging the screen.

- The focus position cannot be set at the edge of the screen.

- 1 Press **◀** ([+]).
- 2 Select [+] and press **▼**.
- 3 Press **▲/▼/◀/▶** to set the focus position and then press [MENU/SET].

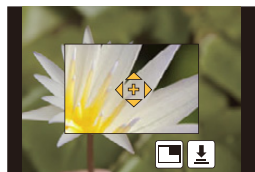

- 4 Move [+] to the position to be in focus.

Button operation	Touch operation	Description of operation
▲/▼/◀/▶	Touching	Moves [+].
	Pinching out/in	Enlarges/reduces the screen in small steps.
	—	Enlarges/reduces the screen in large steps.
—		Switches the enlarged display (windowed/full screen)
[DISP.]	[Reset]	Resets [+] back to the center.

- When the picture is displayed in windowed mode, you can enlarge/reduce the picture by approximately 3× to 6×; when the picture is displayed in full screen, you can enlarge/reduce the picture by approximately 3× to 10×.
- You can also take pictures by touching [].

- 5 Press [MENU/SET] to set.

Setting the AF area position with the Touch Pad

Applicable modes:

You can move the AF area displayed on the viewfinder by touching the monitor.

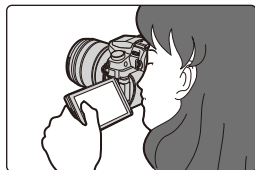

MENU → f_c [Custom] → [Touch Settings] → [Touch Pad AF]

[EXACT]	Moves the AF area of the Viewfinder by touching a desired position on the Touch Pad.	
[OFFSET]	Moves the AF area of the viewfinder according to the distance you drag the touch pad (P48).	
[OFF]	—	—

- Press the shutter button halfway to determine the focus position. If you press [DISP.] before determining the focus position, the AF area frame returns to the center position.
- To cancel the AF area frame when the Auto Focus Mode (P93) is set to [👤] ([Face/Eye Detection]), [👁️] ([Tracking]) or [📏] ([49-Area]), press [MENU/SET].
- The Touch Shutter function (P49) is disabled when using [Touch Pad AF].



Not available in these cases:

- The [Touch Pad AF] does not function in the following cases:
 - When [4K Live Cropping] is set
 - When [Pull Focus] in [Snap Movie] is set to [ON]

Optimizing the focus and brightness for a touched position

Applicable modes:  P A S M  

You can optimize the focus and brightness for the position you have touched.

1 Select the menu. (P51)





MENU → fC [Custom] → [Touch Settings] → [Touch AF] → [AF+AE]

2 Touch the subject you want to optimize the brightness for.

- The brightness optimization position is displayed on the center of the AF area. The position follows the movement of the AF area.
- [Metering Mode] is set to , which is used exclusively for the Touch AE.
- Touching [Reset] returns the brightness optimization position and the AF area to the center.



3 Touch [Set].

- The AF area with the same function as  is displayed on the touched position.
- Touching  (or ) when  is selected) will cancel the [AF+AE] setting.

-  When the background has become too bright, etc., the brightness contrast with the background can be adjusted by compensating the exposure.

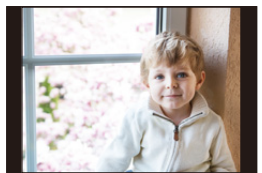

- When recording with the Touch Shutter, the focus and brightness are optimized for the touched position before recording takes place.
- At the edge of the screen, the metering may be affected by the brightness around the touched location.

Not available in these cases:

- [AF+AE], which optimizes the focus and brightness, does not work in the following cases.
 - When using the Digital Zoom
 - When the AF area has been set by using the cursor button
 - When [4K Live Cropping] is set

Adjusting Focus Manually

Applicable modes:   P A S M   

Use this function when you want to fix the focus or when the distance between the lens and the subject is determined and you do not want to activate Auto Focus.

1 Set the focus mode lever to [MF].

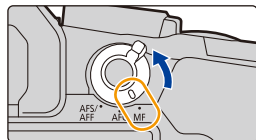

2 Press .

3 Press /// to adjust the focus position, and press [MENU/SET].

- The assist screen is displayed, enlarging the area. (MF Assist)
- You can also enlarge the area by rotating the focus ring, moving the focus lever, or pinching out (P48) the screen or touching the screen twice.
- You can also adjust the focus position by dragging (P48) the screen.
- Pressing [DISP.] resets the focus position back to the center.

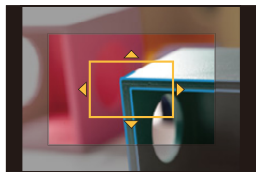

4 Adjust the focus.

The operations used to focus manually differ depending on the lens.

When using an interchangeable lens (H-FS12060/H-FS14140/H-FS1442A) with a focus ring

Rotate to A side:
Focuses on nearby subject

Rotate to B side:
Focuses on distant subjects

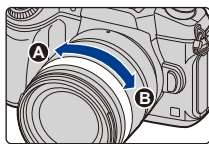

When using the interchangeable lens having a focus lever

Move to C side:
Focuses on nearby subject

Move to D side:
Focuses on distant subjects

- The focusing speed varies depending on how far you move the focus lever.

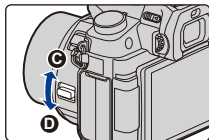

When using an interchangeable lens with no focus ringPress **▶**: Focuses on nearby subjectPress **◀**: Focuses on distant subjects

① Slide bar

- Pressing and holding **◀/▶** will increase the focus speed.
- Focus can also be adjusted by dragging the slide bar.

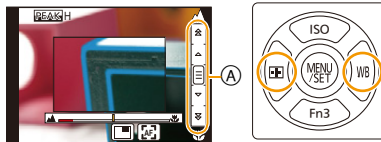

① MF Assist (enlarged screen)



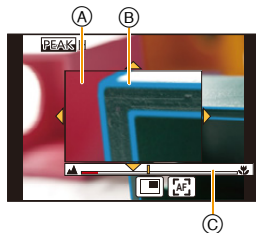

② Peaking

③ MF Guide

- The in-focus portions will be highlighted. (Peaking)
- You can check whether the point of focus is to the near side or to the far side. (MF Guide)



You can perform the following operations:

Button operation	Touch operation	Description of operation
▲/▼/◀/▶*	Dragging	Moves the enlarged area.
	Pinching out/in	Enlarges/reduces the screen in small steps.
	—	Enlarges/reduces the screen in large steps.
—		Switches the enlarged display (windowed/full screen). 
[DISP.]*	[Reset]*	Resets the area to be enlarged back to the center.

* When using an interchangeable lens with no focus ring, you can perform these operations after pressing **▼** to display the screen that lets you set the area to be enlarged.

- When the picture is displayed in windowed mode, you can enlarge/reduce the picture by approximately 3× to 6×; when the picture is displayed in full screen, you can enlarge/reduce the picture by approximately 3× to 10×.



5 Press the shutter button halfway.

- You can also perform the same operation by pressing [MENU/SET].
- If you have enlarged the picture by rotating the focus ring or moving the focus lever, the assist screen will close approximately 10 seconds after the operation.

- MF Assist or MF guide may not display depending on the lens used, but you can display MF Assist by direct operation of the camera, using the touch screen or a button.
- The focus distance reference mark (A) is a mark used to measure the focus distance.
Use this when taking pictures with Manual Focus or taking close-up pictures.

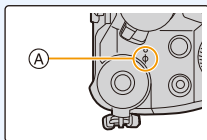

Achieving focus quickly using Auto Focus

MENU → f_c [Custom] → [AF/AE Lock] → [AF-ON]

If [AF/AE LOCK] is pressed in Manual Focus, Auto Focus will work.

- Auto Focus works at the center of the frame.
- Auto Focus also works with the following operations.
 - Pressing the function button to which [AF-ON] is assigned
 - Touching [AF]
 - Dragging the monitor and releasing your finger at the position you want to focus on
- This function is not available when [4K Live Cropping] is set.

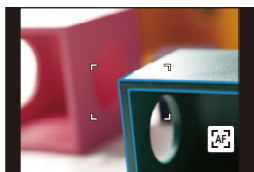

Fixing the Focus and the Exposure (AF/AE Lock)

Applicable modes: P A S M

This is useful when you want to take a picture of a subject outside the AF area or the contrast is too strong and you cannot achieve appropriate exposure.

1 Align the screen with the subject.

2 Press and hold [AF/AE LOCK] to fix the focus or exposure.

- If you release [AF/AE LOCK], AF/AE Lock is canceled.
- Only the exposure is locked in the default setting.

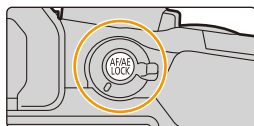

3 While pressing [AF/AE LOCK], move the camera as you compose the picture and then press shutter button fully.

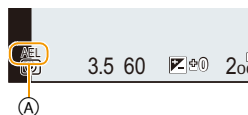

(A) AE Lock indication

■ Setting the functions of [AF/AE LOCK]

MENU → f_c [Custom] → [AF/AE Lock]

[AE LOCK]	Only the exposure is locked. • When the exposure is set, [AEL] is displayed.
[AF LOCK]	Only the focus is locked. • When the subject is focused, [AFL] is displayed.
[AF/AE LOCK]	Both focus and exposure are locked. • [AFL] and [AEL] are displayed when the focus and the exposure are optimized.
[AF-ON]	Auto Focus is performed.

- AF Lock only is effective when taking pictures in Manual Exposure Mode.
- AE Lock only is effective when taking pictures with Manual Focus.
- The subject can be focused again by pressing the shutter button halfway even when AE is locked.
- Program Shift can be set even when AE is locked.

Compensating the Exposure

Applicable modes: **P** **A** **S** **M**

Use this function when you cannot achieve appropriate exposure due to the difference in brightness between the subject and the background.

1 Press [Fn].

- You can also use the button as a function button. (P55)

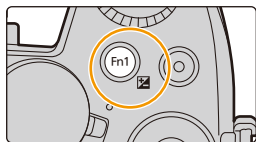

2 Rotate the rear dial to compensate the exposure.

- (A) Exposure Bracket
- (B) Exposure Compensation
- (C) [Flash Adjust.]

- You can perform the operations below while the exposure compensation screen is displayed.

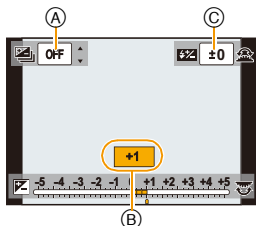

	Compensates the exposure
	Adjusts the flash output (P160)
	Sets the exposure bracket (P142)

- You can switch the functions between the rear dial and the front dial by pressing [DISP].

Underexposed	Properly exposed	Overexposed
Compensate the exposure towards positive.		Compensate the exposure towards negative.

3 Press [Fn] to set.

- You can also press the shutter button halfway to set.



- You can set the exposure compensation value in the range between -5 EV and $+5$ EV. You can set a value between -3 EV and $+3$ EV while recording motion picture or performing recording with the 4K Photo or Post Focus function.
- When [Auto Exposure Comp.] in [Flash] in the [Rec] menu is set to [ON], the brightness of the flash will automatically be set to the level appropriate to the selected Exposure Compensation. (P160)
- When the exposure value is out of the -3 EV to $+3$ EV range, the brightness of the recording screen will no longer change. It is recommended to record by checking the actual brightness of the recorded image in the Auto Review or playback screen.
- The set Exposure Compensation value is stored even if the camera is turned off. (When [Exposure Comp. Reset] (P224) is set to [OFF])

Setting the Light Sensitivity

Applicable modes:  P A S M  

This allows the sensitivity to light (ISO sensitivity) to be set.

Setting to a higher figure enables pictures to be taken even in dark places without the resulting pictures coming out dark.

1 Press ▲ (ISO).

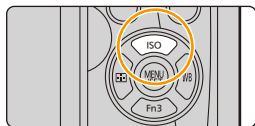

2 Select the ISO sensitivity by rotating the rear dial.

- You can switch the functions between the rear dial and the front dial by pressing [DISP].

(A) ISO Limit Set

(B) ISO sensitivity

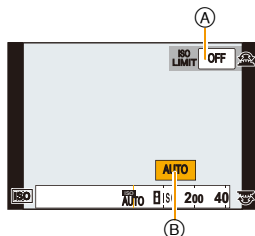

3 Rotate the front dial to set the upper limit of ISO sensitivity.

- It will work when the [Sensitivity] is set to [AUTO] or [ISO].

4 Press [MENU/SET] to set.

- You can also press the shutter button halfway to set.



AUTO	The ISO sensitivity is automatically adjusted according to the brightness. • Maximum [ISO3200] (With the flash on [ISO1600])*1
 (Intelligent)	The camera detects movement of the subject and then automatically sets the optimum ISO sensitivity and shutter speed to suit the movement of the subject and brightness of the scene to minimize the jitter of the subject. • Maximum [ISO3200] (With the flash on [ISO1600])*1 • The shutter speed is not fixed when the shutter button is pressed halfway. It is continuously changing to match the movement of the subject until the shutter button is pressed fully.
L.100 *2, from 200 to 25600	The ISO sensitivity is fixed to various settings.

*1 When the [ISO Limit Set] (P199) of [Rec] menu is set to anything except [OFF], it is set automatically within the value set in [ISO Limit Set].

*2 Only available when [Extended ISO] is set.



Characteristics of the ISO sensitivity

	200 \longleftrightarrow 25600	
Recording location (recommended)	When it is light (outdoors)	When it is dark
Shutter speed	Slow	Fast
Noise	Less	Increased
Jitter of the subject	Increased	Less

- For information on the focus range of flash when [AUTO] is set, refer to P155.
- Cannot select  in the following cases:
 - Shutter-Priority AE Mode
 - Manual Exposure Mode
- When [Multi Exp.] is set, the maximum setting is [ISO3200].
- You can use the following settings in Creative Video Mode or when performing recording with the 4K Photo or Post Focus function: [AUTO], [200] to [6400]
- You can set the ISO sensitivity in Scene Guide Mode only when using [Panorama Shot].

Adjusting the White Balance

Applicable modes:

In sunlight, under incandescent lights or in other such conditions where the color of white takes on a reddish or bluish tinge, this item adjusts to the color of white which is closest to what is seen by the eye in accordance with the light source.

1 Press (WB).

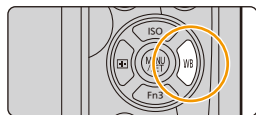

2 Rotate the rear dial or front dial to select the White Balance.

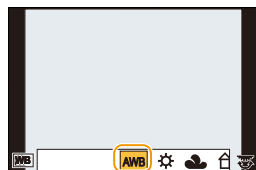

	Automatic adjustment
	When taking pictures outdoors under a clear sky
	When taking pictures outdoors under a cloudy sky
	When taking pictures outdoors in the shade
	When taking pictures under incandescent lights
	When taking pictures with the flash only



Set the White Balance value. Use to match the condition when taking photographs.

- 1 Press .
 - 2 Place a white object such as a piece of paper within the frame at the center of the screen, and press [MENU/SET].
- This will set the White Balance and return you to the recording screen.
 - The same operation can be performed by pressing the shutter button.
 - White Balance may not be set when the subject is too bright or too dark. Set the White Balance again after adjusting to appropriate brightness.

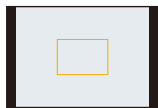

* [AWB] is applied when you record motion picture or perform recording with the 4K Photo or Post Focus function.



[MENU]

You can set the color temperature manually for taking natural pictures in different lighting conditions.

- 1 Press ▲.
 - 2 Press ▲/▼ to select the color temperature and then press [MENU/SET].
- You can set a color temperature from [2500K] to [10000K].

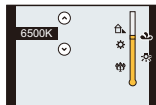

3 Press [MENU/SET] to set.

- You can also press the shutter button halfway to set.



Under fluorescent lighting, LED lighting fixture etc., the appropriate White Balance will vary depending on the lighting type, so use [AWB] or [L1], [L2], [L3], [L4].

- The White Balance is only calculated for subjects within the range of the camera's flash. (P155)
- In Scene Guide Mode, changing the scene or Recording Mode will return White Balance settings (including the White Balance fine adjustment setting) back to [AWB].
- In the Scene Guide Mode, settings suitable for each scene are made.

■ Auto White Balance

Depending on the conditions prevailing when pictures are taken, the pictures may take on a reddish or bluish tinge. Furthermore, when a multiple number of light sources are being used or there is nothing with a color close to white, Auto White Balance may not function properly. In a case like this, set the White Balance to a mode other than [AWB].

- 1 Auto White Balance will work within this range.
 - 2 Blue sky
 - 3 Cloudy sky (Rain)
 - 4 Shade
 - 5 Sunlight
 - 6 White fluorescent light
 - 7 Incandescent light bulb
 - 8 Sunrise and sunset
 - 9 Candlelight
- K=Kelvin Color Temperature

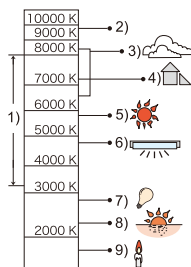

Finely adjusting the White Balance

You can finely adjust the White Balance when you cannot acquire the desired hue by setting the White Balance.

- 1 Select the White Balance and then press ▼.
- 2 Press ▲/▼/◀/▶ to fine-adjust the White Balance.

- ◀ : A (AMBER: ORANGE)
- ▶ : B (BLUE: BLUISH)
- ▲ : G (GREEN: GREENISH)
- ▼ : M (MAGENTA: REDDISH)

- You can also make fine adjustments by touching the White Balance graph.
- Pressing [DISP.] resets the position back to the center.

- 3 Press [MENU/SET].

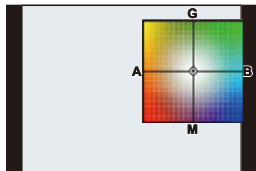

- If you finely adjust the White Balance to [A] (amber), the White Balance icon on the screen will change to orange.
- If you finely adjust the White Balance to [B] (blue), the White Balance icon on the screen will change to blue.
- If you finely adjust the White Balance to [G] (green) or [M] (magenta), [+] (green) or [-] (magenta) appears beside the White Balance icon on the screen.

White Balance Bracket

Bracket setting is performed based on the adjustment values for the White Balance fine adjustment, and 3 pictures with different colors are automatically recorded when the shutter button is pressed once.

1 Fine-adjust the White Balance in step 2 of “Finely adjusting the White Balance” and then perform the bracket setting by rotating the rear dial.

Rotating the rear dial to the right:

Horizontal ([A] to [B])

Rotating the rear dial to the left:

Vertical ([G] to [M])

• You can also set the bracket by touching []/[].

2 Press [MENU/SET].

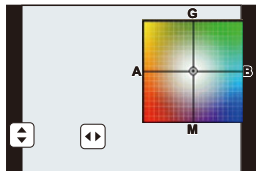



• You can also set the White Balance Bracket in [Bracket] in the [Rec] menu. (P141)



Not available in these cases:

• The White Balance Bracket does not work in the following cases:

- Intelligent Auto Mode
- Intelligent Auto Plus Mode
- [Glistening Water]/[Glittering Illuminations]/[Handheld Night Shot]/[Soft Image of a Flower]/[Panorama Shot] (Scene Guide Mode)
- Creative Control Mode
- When taking pictures while recording a motion picture
- When recording 4K photos
- When recording with the Post Focus function
- When recording in Burst Mode
- When [Quality] is set to [RAW, [RAW] or [RAW]
- When using [Multi Exp.]
- When using [Time Lapse Shot]
- When using [Stop Motion Animation] (only when [Auto Shooting] is set)

5.

4K Photo and Drive Settings





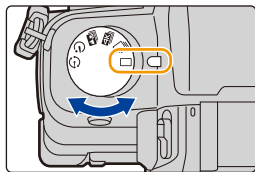

Select a Drive Mode

Applicable modes:   P A S M   

You can change what the camera will do when you press the shutter button.

Rotating the drive mode dial.



 [Single]	When the shutter button is pressed, only one picture is recorded.
 [Burst] (P115)	Recordings are made in succession while the shutter button is pressed.
 [4K PHOTO] (P118)	When the shutter button is pressed, a 4K photo is recorded.
 [Post Focus] (P129)	When the shutter button is pressed, Post Focus recording is performed.
 [Self Timer] (P135)	When the shutter button is pressed, recording takes place after the set time has elapsed.
 [Time Lapse/ Animation] (P136, 138)	Pictures are recorded with Time Lapse Shot or Stop Motion Animation.



Not available in these cases:

- The mode setting is fixed to [Single] when Scene Guide Mode is set to [Panorama Shot].

Taking Pictures using Burst Mode

Applicable modes:   **P** **A** **S** **M**   

Pictures are taken continuously while the shutter button is pressed.

- Pictures taken with a burst speed of [SH] will be recorded as a single burst group (P182).

1 Set the drive mode dial to [Burst].

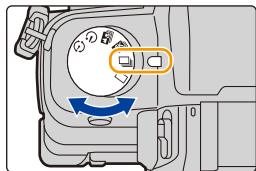

2 Focus on the subject and take a picture.

- Hold down the shutter button fully to activate the Burst Mode.



■ Setting the burst rate

Select the menu. (P51)

MENU →  **[Rec]** → **[Burst Rate]**

		[SH] (Super high speed)	[H] (High speed)	[M] (Middle speed)	[L] (Low speed)
Burst speed (pictures/ second)	Mechanical shutter, Electronic Front Curtain	—	9 (AFS) 6 (AFC)	6	2
	Electronic Shutter	40	10 (AFS) 6 (AFC)	6	2
Live View during Burst Mode		None	None	Available	Available
*1	With RAW files	—	45 or more ⁺²		
	Without RAW files	Max. 120	300 or more ⁺²		

*1 Number of recordable pictures

*2 When recording is performed under the test conditions specified by Panasonic.

The burst speed will become slower halfway. However, pictures can be taken until the capacity of the card becomes full. Depending on recording conditions, the number of burst pictures that can be taken will be reduced.

- The picture size will be fixed to [S] when [Burst Rate] is set to [SH].
- The burst speed may become slower depending on the following settings.
 - [Picture Size] (P190)/[Quality] (P191)/[Sensitivity] (P108)/Focus Mode (P91)/[Focus/Release Priority] (P211)

■ About the maximum number of pictures that can be taken continuously

When you press the shutter button halfway, the maximum number of pictures you can take continuously will appear. You can check the approximate number of pictures that can be taken before the burst speed slows down.



Example: When 20 pictures can be taken: [r20]

- Once recording starts, the maximum number of pictures that can be taken continuously will decrease. When [r0] appears, the burst speed will slow down.
- When [r99+] is displayed, you can take 100 or more pictures continuously.

Focusing in Burst Mode

The way focus is achieved varies according to the focus mode (P91) setting and the [Focus/Release Priority] (P211) setting in the [Custom] menu.

Focus mode	[Focus/Release Priority]	Focus
[AFS]	[AFS/AFF]: [FOCUS]	At the first picture
	[AFS/AFF]: [RELEASE]	
[AFF]*1	[AFS/AFF]: [FOCUS]	Normal focusing*2
	[AFS/AFF]: [RELEASE]	Predicted focusing*3
[AFC]*1	[AFC]: [FOCUS]	Normal focusing*2
	[AFC]: [RELEASE]	Predicted focusing*3
[MF]	—	Focus set with Manual Focus

*1 When the subject is dark or the burst speed is set to [SH], the focus is fixed on the first picture.

*2 The burst speed may become slower because the camera is continuously focusing on the subject.

*3 Burst speed takes priority, and focus is estimated within possible range.



- We recommend using the shutter remote control (DMW-RSL1: optional) when you want to keep the shutter button pressed fully while taking pictures in Burst Mode. Refer to [P309](#) for information about the shutter remote control.
- When the burst speed is set to [SH] or [H] (when focus mode is [AFS] or [MF]), the exposure is fixed at the settings used for the first picture for the subsequent pictures as well. When the burst speed is set to [H] (when focus mode is [AFF] or [AFC]), [M] or [L], the exposure is adjusted each time you take a picture.
- **It may take time to save pictures taken in Burst Mode on the card. If you take pictures continuously while saving, the maximum number of recordable pictures decreases. For continuous shooting, use of a high speed memory card is recommended.**
-  **Not available in these cases:**
 - The Burst Mode is disabled in the following cases.
 - [Glistening Water]/[Glittering Illuminations]/[Handheld Night Shot]/[Soft Image of a Flower]/[Panorama Shot] (Scene Guide Mode)
 - [Rough Monochrome]/[Silky Monochrome]/[Miniature Effect]/[Soft Focus]/[Star Filter]/[Sunshine] (Creative Control Mode)
 - When recording motion pictures
 - When recording using the flash (except for [Burst Rate] is set to [SH])
 - When using [Multi Exp.]

Recording 4K Photos

Applicable modes:   **P** **A** **S** **M**   

You can select the desired moment from a burst of pictures taken at 30 frames/second and save that moment as a picture of 8 million pixels (approx.).



- ❶ Record a 4K photo.
- ❷ Select and save pictures.
- ❸ The picture is complete.
 - Use a UHS Speed Class 3 card to record 4K photos. (P26)
 - When recording 4K photos, the angle of view is narrower.



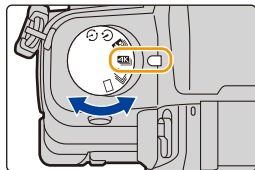



1 Set the drive mode dial to [].

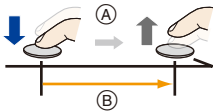

2 Select the menu. (P51)

MENU →  **[Rec]** → **[4K PHOTO]** → **[Rec Method]**

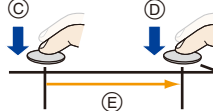

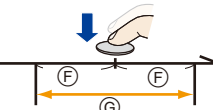
  MENU 	<p>For capturing the best shot of a fast-moving subject (e.g., sports, aeroplanes, trains)</p> <p>Burst recording is performed while the shutter button is pressed and held. The shutter sound will be heard repeatedly.</p> <p>Ⓐ Press and hold Ⓑ Recording is performed</p>	
Audio recording: Not available		
 [4K Burst(S/S)] ^{*1} "S/S" is an abbreviation of "Start/Stop".	<p>For capturing unpredictable photo opportunities (e.g., plants, animals, children)</p> <p>Burst recording starts when the shutter button is pressed and stops when pressed again. Start and stop tones will be heard.</p> <p>Ⓒ Start (First) Ⓓ Stop (Second) Ⓔ Recording is performed</p>	
Audio recording: Available ^{*2}		
 [4K Pre-Burst]	<p>For recording as needed whenever a photo opportunity arises (e.g., the moment when a ball is thrown)</p> <p>Burst recording is performed for approximately 1 second before and after the moment that the shutter button is pressed. The shutter sound will be heard only once.</p> <p>Ⓕ Approximately 1 second Ⓖ Recording is performed</p>	
Recording length: Approximately 2 seconds		Audio recording: Not available

*1 4K burst file will be recorded and played back in separate files in the following cases. (You can continue recording without interruption.)











- When using an SDHC memory card: If the file exceeds 4 GB
- When using an SDXC memory card: If the continuous recording time exceeds 3 hours and 4 minutes or If the file exceeds 96 GB

*2 Audio is not played back when you perform playback with the camera.

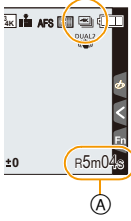
3 Press the shutter button halfway to exit the menu.

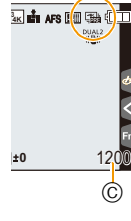

4 Record a 4K photo.

     [4K Burst]	<ol style="list-style-type: none"> Press the shutter button halfway. (A) Available recording time Press and hold the shutter button fully for as long as you want to perform recording. <ul style="list-style-type: none"> Press the button fully slightly in advance. Recording starts approximately 0.5 seconds after it has been pressed fully. If you are using Auto Focus, [Continuous AF] will work during recording. Focus will be adjusted continuously. If you remove your finger from the shutter button immediately after the start of recording, up to a period of approximately 1.5 seconds after the moment that the finger has been removed may be recorded. 	
 [4K Burst(S/S)]	<ol style="list-style-type: none"> Press the shutter button fully to start recording. (B) Available recording time <ul style="list-style-type: none"> If you are using Auto Focus, [Continuous AF] will work during recording. Focus will be adjusted continuously. Press the shutter button fully again to stop recording. <p> Adding markers to select and save pictures You can add markers if you press [Fn2] during recording. (Up to 40 markers per recording) When selecting and saving pictures from a 4K burst file, you can skip to the positions where you added markers.</p>	
 [4K Pre-Burst]	<p>Press the shutter button fully.</p> <p>(C) Number of recordings that can be made</p> <ul style="list-style-type: none"> Auto Focus adjusts focus continuously, and except in Manual Exposure Mode, it also adjusts exposure continuously. When recording with  ([4K Pre-Burst]), images may not be displayed as smoothly as when recording with the normal recording screen. <p> Recording tips In situations where you want to lock focus and exposure, such as when the subject is not at the center, use [AF/AE LOCK]. (P105)</p>	



- The camera will perform burst recording of a 4K photo and saves it as a 4K burst file in MP4 format.
- When [Auto Review] is enabled, the picture selection screen will be displayed automatically. To continue recording, press the shutter button halfway to display the recording screen.
- For information on how to select and save pictures from recorded 4K burst files, refer to [P125](#).
- To reduce camera shake, we recommend that you use a tripod and shutter remote control (DMW-RSL1: optional) ([P309](#)) when using [Light Composition] ([P236](#)).



Battery drainage and camera temperature

- When the ambient temperature is high or 4K photo recording is performed continuously, the camera may display [🔥] and recording may stop. (If [🔋] ([4K Pre-Burst]) is selected, the setting changes to [🔋] ([4K Burst]) before recording stops.) Wait until the camera cools down.
- **When [🔋] ([4K Pre-Burst]) is set, the battery drains faster and the camera temperature rises. Select [🔋] ([4K Pre-Burst]) only when recording.**

■ Setting Loop Recording ([4K Burst(S/S)])

With [🔋] ([4K Burst(S/S)]), you can perform recording while deleting the oldest recorded data, allowing you to keep on recording while waiting for a photo opportunity without replacing the card.

- Once you start recording, the 4K burst file will be recorded and divided approximately every 2 minutes.
Approximately the last 10 minutes (up to approximately 12 minutes) will be saved. The preceding part will be deleted.

Select the menu. ([P51](#))

MENU → **[Rec]** → **[4K PHOTO]** → **[Loop Recording]**

Settings: [ON]/[OFF]

- **We recommend that you use a sufficiently charged battery or an AC adaptor (optional).**
- Up to 12 hours of continuous recording is possible.
- [🔄] is displayed during recording.
- The available recording time and elapsed recording time are not displayed during recording.
- [Loop Recording] is not possible when there is insufficient free space on the card.

Notes on the 4K Photo function

■ To change the aspect ratio

Selecting [Aspect Ratio] in the [Rec] menu allows you to change the aspect ratio for 4K photos.

■ To record the subject with reduced blur

You can reduce the blur of the subject by setting a faster shutter speed.

1 Set the mode dial to [S].

2 Set the shutter speed by rotating the rear dial or the front dial.

- Approximate shutter speed for outdoor recording in fine weather conditions: 1/1000 seconds or faster.
- If you increase the shutter speed, the ISO sensitivity becomes higher, which may increase the noise on the screen.

■ Shutter sound for 4K photo recording

- When using [] ([4K Burst]) or [] ([4K Pre-Burst]), you can change the electronic shutter sound settings in [E-Shutter Vol] and [E-Shutter Tone]. (P220)
When recording with [] ([4K Burst(S/S)]), you can set the start/stop tone volume in [Beep Volume].
- You can perform high speed burst recording quietly using the 4K Photo function in combination with [Silent Mode].

■ Scenes not suitable for the 4K Photo function

Recording in extremely bright locations or indoors

When subjects are recorded in an extremely bright place or under fluorescent/LED lighting, the color tone or brightness of the image may change, or horizontal stripes may appear on the screen.

Lowering the shutter speed may reduce the effect of the horizontal stripes.

Subjects that are moving fast in the horizontal direction

If you record a subject moving fast in the horizontal direction, the subject in the recorded pictures may appear distorted.

■ The camera's setup for the 4K Photo function



The camera's setup is automatically optimized for 4K photo recording.

- The following [Rec] menu items are fixed to the settings below:

[Picture Size]	[4K] (8M)	[Quality]	[■ ■ ■]
	[4:3]: (3328×2496)	[Shutter Type]	[ESHTR]
	[3:2]: (3504×2336)		
	[16:9]: (3840×2160)		
	[1:1]: (2880×2880)		



- 4K burst files are recorded with the settings indicated below:
Settings in the [Motion Picture] menu are not applied to 4K burst files.

[Rec Format]	[MP4]	[Continuous AF]	[ON]
[Rec Quality]	[4K/100M/30p]	[Luminance Level]	[0–255]

- When recording with the 4K Photo function, the ranges for the following functions differ from the ones available for taking pictures:
 - Shutter speed: 1/30th to 1/16000th
 - Exposure Compensation: –3 EV to +3 EV
 - ISO sensitivity: [AUTO], 200 to 6400
- When recording with the 4K Photo function, the following functions are disabled:
 - **Flash** – [AF Mode] ([+])
 - **Bracket Recording** – [MF Assist] ([]) ([4K Pre-Burst] only)
 - Program Shift – White Balance ([])
 - Focus mode (AFF)
- The following menu items are disabled:

[Rec]	[Picture Size]/[Quality]/[AFS/AFF]/[Bracket]/[iHandheld Night Shot]/[iHDR]/[HDR]/[Panorama Settings]/[Shutter Type]/[Shutter Delay]/[Flash]/[Extended ISO]/[Long Shtr NR]/[Shading Comp.]/[Ex. Tele Conv.]/[Color Space]/[Face Recog.]/[Profile Setup]
[Custom]	[Rec Area]
[Setup]	[Economy] ([]) ([4K Pre-Burst] only)



- The following changes occur when recording 4K photos:
 - The [i.Resolution] setting changes from [EXTENDED] to [LOW].
 - [Destination] in [Travel Date] cannot be recorded.
 - [Simultaneous record w/o filter] is not available.
 - It is not possible to use the HDMI output.
- When recording with [] ([4K Pre-Burst]), [Step Zoom] in [Power Zoom Lens] is disabled.
- Scene Detection in Intelligent Auto Mode works the same way as when recording motion pictures.
- When the drive mode is set to 4K Photo, it is not possible to take pictures while recording motion picture. (Only when [] ([Photo Priority]) is set)

 **Not available in these cases:**

- The 4K Photo function is disabled when using the following settings:
 - [Clear in Backlight]/[Glistening Water]/[Artistic Nightscape]/[Glittering Illuminations]/[Handheld Night Shot]/[Clear Night Portrait]/[Soft Image of a Flower]/[Panorama Shot] (Scene Guide Mode)
 - [Rough Monochrome]/[Silky Monochrome]/[Miniature Effect]/[Soft Focus]/[Star Filter]/[Sunshine] (Creative Control Mode)
 - When recording motion pictures
 - When using [Multi Exp.]

Selecting pictures from 4K burst file and saving

This section describes how to select pictures from a 4K burst file and save them. For information on how to record 4K burst files, refer to [P118](#).

1 Select an image with the [▲] icon on the playback screen, and press ▲.

- You can also perform the same operation by touching the icon [▲].
- If the image was recorded with [] ([4K Pre-Burst]), proceed to step 3.



2 Drag the slide bar to make a rough selection of scenes.

- For information on how to use the slide view screen, refer to [P126](#).
- If the image was recorded with [] ([4K Burst]) or [] ([4K Burst(S/S)]), you can select its scenes on the 4K burst playback screen by touching [Fn1] (P127).

Slide view screen

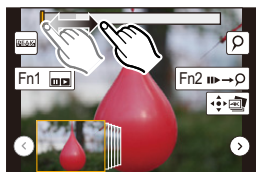

3 Drag the frames to select the frame you want to save as a picture.

- You can also perform the same operation by pressing ◀/▶.



4 Touch [] to save the picture.



You can save pictures taken during a 5 second period at once by using [4K PHOTO Bulk Saving] in the [Playback] menu. ([P235](#))

- The picture will be saved in JPEG format.
- The picture will be saved with recording information (Exif information), including its shutter speed, aperture and ISO sensitivity information.



<Slide view screen>

Position of the displayed frame

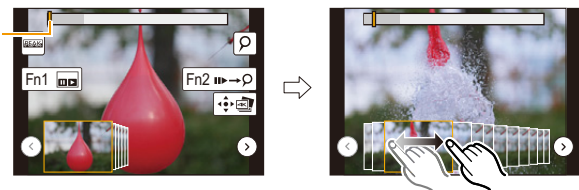

Button operation	Touch operation	Description of operation
	Dragging	Selects a frame you want to save as a picture • You can select a frame from 60 frames (continuous burst time of approximately 2 seconds).
Select → [MENU/SET]		Displays the preceding or following 45 frames in slide view. • Pressing the same button again will display the frames following the next ones or the ones preceding the previous ones.
—	 Touching/ Dragging	Selects the frame to be displayed and displays the frames preceding and following the selected frame in slide view.
	Pinching out/in	Enlarges/reduces the display
	—	Selects a frame while maintaining the enlarged display (during enlarged display)
	Dragging	Moves the enlarged area (during enlarged display)
[Fn1]		Displays the 4K burst playback screen.
[Fn2]		Switches to marker operation
—		Adds/deletes a marker
—		In-focus portions are highlighted with color. ([Peaking]) • Switches in order of [OFF] → [ON] ([LOW]) → [ON] ([HIGH]).
[MENU/SET]		Saves the picture

• During marker operation, you can skip to the markers that you added or the beginning or end of the 4K burst file. Press [Fn2] again to return to the original operation.

Button operation	Touch operation	Description of operation
		Moves to the next marker.
		Moves to the previous marker.

<4K burst playback screen>

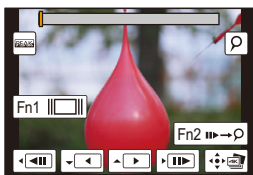

During pause

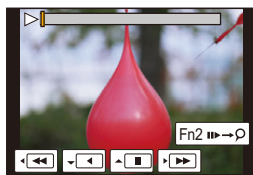

During continuous playback

Button operation	Touch operation	Description of operation
▲		Continuous playback/Pause (during continuous playback)
▼		Continuous rewind/Pause (during continuous rewind)
▶		Fast forward/Frame-by-frame forward (during pause)
◀		Fast rewind/Frame-by-frame rewind (during pause)
—	 Touching/ Dragging	Selects the frames to be displayed (during pause)
	Pinching out/in	Enlarges/reduces the display (during pause)
	—	Selects a frame while maintaining the enlarged display (during enlarged display)
▲/▼/◀/▶	Dragging	Moves the enlarged area (during enlarged display)
[Fn1]		Displays the slide view screen (during pause)
[Fn2]		Switches to marker operation
—		Adds/deletes a marker
—		In-focus portions are highlighted with color. ([Peaking]) • Switches in order of [OFF]→[ON] ([LOW]) → [ON] ([HIGH]).
[MENU/SET]		Saves the picture (during pause)

- Touch the screen twice to enlarge the display. To return to the original display, touch the enlarged screen twice.
 - To select and save pictures from 4K burst files on a PC, use the software “PHOTOfunSTUDIO”. (P295)
- Please note that it is not possible to edit a 4K burst file as a motion picture.

■ Selecting and saving pictures on the TV screen

- Set [HDMI Mode (Play)] (P223) to [AUTO] or [4K].
When connecting to a TV that does not support 4K motion picture, select [AUTO].
- Set [VIERA Link] in [TV Connection] to [OFF].
- If you display 4K burst files on a TV connected to the camera, they will be displayed only on the 4K burst playback screen.
- Even if you insert the SD card to a 4K-compatible TV with an SD card slot, you cannot play back 4K burst files recorded with [Aspect Ratio] set to an option other than [16:9].
(As of September 2016)



MENU



Controlling Focus After Recording

(Post Focus/Focus Stacking)

Applicable modes:   **P** **A** **S** **M**   

The camera can perform Burst recording in the same picture quality as 4K photo recording while automatically shifting the focus to different areas. After the recording, you can select the desired area on the screen and save a picture in which the selected area is in focus. You can also merge multiple pictures with different focus areas to widen the focus range. (Focus Stacking)

This function is suited for recording still objects.



4K burst recording while automatically shifting the focus.



Touch the desired focus point.



A picture with the desired focus point is made.

- We recommend that you use a tripod when recording images to be used for Focus Stacking.
- Use a UHS Speed Class 3 card. ([P26](#))
- The angle of view becomes narrower when the Post Focus function is in use.

Recording with the Post Focus function

- 1 Set the drive mode dial to [📷].

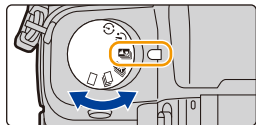

- 2 Decide on the composition, and press the shutter button halfway.

- Auto Focus will detect focus areas on the screen. (Excluding the edges of the screen)
- If no areas on the screen can be brought into focus, the focus display (A) will flash. Recording is not possible in this case.

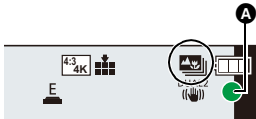

- 3 Press the shutter button fully to start recording.

- The focus point changes automatically while recording. When the icon (B) disappears, recording automatically ends.



From the time you press the shutter button halfway until the end of recording:

- Maintain the same distance to the subject and the same composition.
- Do not operate the zoom.
- A motion picture in MP4 format will be recorded. (Audio will not be recorded.)
- When [Auto Review] is enabled, a screen that lets you select the desired focus area will be displayed. (P132)



About camera temperature

- If the surrounding temperature is high, recording is performed continuously with the Post Focus function, or the temperature of the camera rises, [🚫] may be displayed and recording may stop halfway through to protect the camera. Wait until the camera cools down.

■ Limitations on the Post Focus function

- Since recording is performed in the same image quality as 4K photos, certain limitations apply to recording functions and menu settings. For details, refer to “The camera’s setup for the 4K Photo function” on [P123](#).
- In addition to the limitations of the 4K Photo function, the following limitations apply to the Post Focus function:
 - Focus Mode is fixed to [AFS].
 - Auto Focus Mode is disabled.
 - Motion pictures cannot be recorded.
 - [Digital Zoom] is disabled.
 - The following [Custom] menu items are disabled:
[Shutter AF]/[Focus/Release Priority]/[Remaining Disp.]/[Video Button]

Not available in these cases:

- The Post Focus function is disabled when using the following settings:
 - [Clear in Backlight]/[Glistening Water]/[Artistic Nightscape]/[Glittering Illuminations]/[Handheld Night Shot]/[Clear Night Portrait]/[Soft Image of a Flower]/[Panorama Shot] (Scene Guide Mode)
 - [Rough Monochrome]/[Silky Monochrome]/[Miniature Effect]/[Soft Focus]/[Star Filter]/[Sunshine] (Creative Control Mode)
 - When [Multi Exp.] is set

Selecting the desired focus area and saving a picture

- 1 Select an image with the [▲📷] icon on the playback screen, and press ▲.**

- You can also perform the same operation by touching the icon [▲📷].



- 2 Touch the desired focus area.**

- If a picture that is in focus is not available for the selected area, a red frame will be displayed. You cannot save a picture in this case.
- You cannot select the edges of the screen.



Button operation	Touch operation	Description of operation
▲/▼/◀/▶/↺	Touching	Selects a focus area. • It cannot be selected during enlarged display.
☺	🔍	Enlarges the display.
☺	⏪	Reduces the display (during enlarged display).
[Fn1]	📷	Switches to the Focus Stacking function. (P133)
[Fn2]	PEAK	In-focus portions are highlighted with color. ([Peaking]) • Switches in order of [OFF]→[ON] ([LOW]) → [ON] ([HIGH]).
[MENU/SET]	📷	Saves the picture

- You can fine-adjust the focus by dragging the slide bar during enlarged display. (You can also perform the same operation by pressing ◀/▶.)



- 3 Touch [📷] to save the picture.**

- The picture will be saved in JPEG format.

- You cannot choose and save the picture from a TV screen even if the camera is connected to a TV through an HDMI micro cable.

Merging multiple pictures to widen the focus range (Focus Stacking)

Merge multiple pictures extracted from images recorded with the Post Focus function into a single picture with a wider focus range.

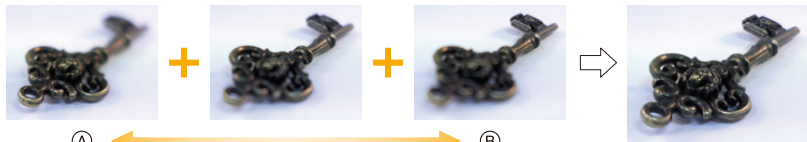

(A) Focus: closer

(B) Focus: farther away

- 1 Touch **[Ⓜ]** in step 2 of “Selecting the desired focus area and saving a picture”.
 - You can also perform the same operation by pressing [Fn1].
- 2 Touch the merging method.

[Auto Merging]	Automatically selects pictures that are suited to be merged, and merges them into a single picture. <ul style="list-style-type: none"> • Priority will be given to pictures with closer focus. • Pictures will be merged into a single picture and the resulting picture will be saved when this item is selected.
[Range Merging]	Merges pictures with specified focus areas into a single picture.



3 (When [Range Merging] is selected)**Touch the desired focus area.**

- Specify at least two areas.
- In-focus areas between the two areas will also be selected, and the combined in-focus area will be indicated.
- Gray areas indicate areas that may, if selected, cause the merged picture to look unnatural and areas that cannot be selected.

- Touch the focus area again to cancel the selection.
- Dragging the screen allows you to select multiple areas.

Button operation	Touch operation	Description of operation
▲/▼/◀/▶	Touching	Selects an area.
[Fn2]	[Set/Cancel]	Specifies/cancels an area.
[DISP.]	[All]	Selects all areas. (Before selecting areas)
	[Reset]	Cancels all selections. (After selecting areas)
[MENU/SET]		Merges pictures and saves the resulting picture.

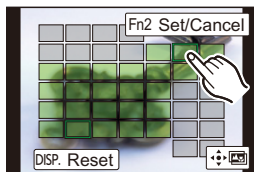
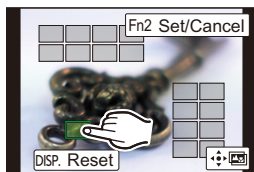
**4 Touch  to merge the pictures and save the resulting picture.**

- The picture will be saved in JPEG format. Recording information (Exif information) of the original picture with the closest focus distance, including the shutter speed, aperture, and ISO sensitivity, will also be recorded to the new picture.
- The camera may automatically correct the misalignments of pictures caused by camera shake. If they are corrected, the angle of view becomes slightly narrower when pictures are merged.
- An unnatural picture may be created if a subject moves during recording or the distance between subjects is great.
- Very defocused pictures, such as those recorded with a macro lens, may be merged into an unnatural picture. If you perform recording with a larger aperture value in Aperture-Priority AE Mode or Manual Exposure Mode, the resulting picture may look less unnatural.
- You may not be able to use Focus Stacking for images recorded with other devices.

Taking Pictures with the Self-timer

Applicable modes: **P** **A** **S** **M**

1 Set the drive mode dial to .

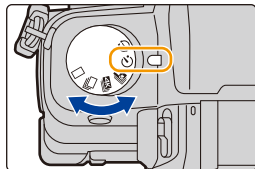

2 Press the shutter button halfway to focus and then press it fully to take the picture.

- Focus and exposure will be set when the shutter button is pressed halfway.
- After the self-timer indicator flashes, recording starts.

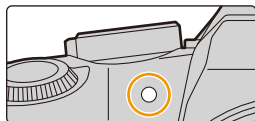

■ Setting the self-timer

Select the menu. (P51)

MENU → [Rec] → [Self Timer]

	Picture is taken 10 seconds after shutter is pressed.
	After 10 seconds the camera takes 3 pictures at about 2 seconds intervals.
	Picture is taken 2 seconds after shutter is pressed. <ul style="list-style-type: none"> • When using a tripod, etc., this setting is a convenient way to avoid the jitter caused by pressing the shutter button.

- We recommend using a tripod when recording with the self-timer.

Not available in these cases:

- It cannot be set to in the following cases.
 - When [Simultaneous record w/o filter] of [Filter Settings] is set to [ON]
 - When recording with the Bracket function
 - When using [Multi Exp.]
- Self-timer is disabled in the following cases.
 - When recording motion pictures

Taking Pictures with Time Lapse Shot/Stop Motion Animation

Applicable modes:   P A S M  

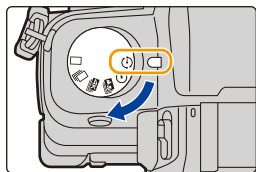

You can take pictures with Time Lapse Shot or Stop Motion Animation. In addition, the pictures taken can be combined into a motion picture.

- Set the date and time settings in advance. (P34)
- Recorded pictures are displayed as group pictures. (P182)



■ To display the setup screen before recording

- 1 Set the drive mode dial to [].
- 2 Display the setup screen.

Button operation	Touch operation
[MENU/SET]* → [MENU/SET]	 / 

* The screen selected with [Time Lapse/Animation] in the recording menu will be displayed. (The screen will be displayed only when you press [MENU/SET] for the first time after switching the drive mode dial to [].)

■ To switch between Time Lapse Shot and Stop Motion Animation

Switch the [Mode] setting in [Time Lapse/Animation] in the [Rec] menu.

Taking Pictures Automatically at Set Intervals ([Time Lapse Shot])

Applicable modes:   P A S M  

The camera can automatically take pictures of subjects such as animals or plants as time elapses and create a motion picture.

- 1 Set the drive mode dial to [].
- 2 Display the setup screen. (P136)
 - Switch to [Time Lapse Shot] if it is not selected. (P136)

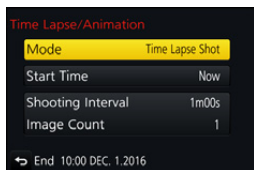

[Start Time]	[Now]	Starts the recording by fully-pressing the shutter button.
	[Start Time Set]	Any time up to 23 hours 59 minutes ahead can be set. Select the item (hour or minute) by pressing </>, set the start time by pressing ▲/▼, and then press [MENU/SET].
[Shooting Interval]/ [Image Count]	The recording interval and the number of pictures can be set. ◀/▶: Select the item (minute/second/number of pictures) ▲/▼: Setting [MENU/SET]: Set	

- Recording may not be consistent with the set recording interval or the set number of pictures depending on recording conditions.

3 Press the shutter button halfway.

- The recording screen will be displayed. You can also perform the same operation by pressing and holding [⏏/⏏] until the recording screen is displayed.



4 Press the shutter button fully.

- The recording starts automatically.
- During recording standby, the power will turn off automatically if no operation is performed for a certain period. The Time Lapse Shot is continued even with the power turned off. When the recording start time arrives, the power turns on automatically. To turn on the power manually, press the shutter button halfway.
- Operations during recording standby (The camera is turned on)

Button operation	Touch operation	Description of operation
[Fn2]		Displays a selection screen that lets you pause or stop the recording
		Displays a selection screen that lets you resume or stop the recording (during pause)

- After the recording stops, a confirmation screen will be displayed, asking whether to proceed to create a motion picture.
To create a motion picture, select [Yes].
For information on creating motion pictures, refer to [P140](#).

■ Changing the Time Lapse Shot settings

You can change the settings in [Time Lapse/Animation] in the [Rec] menu.



- This function is not for use in a security camera.
- [Time Lapse Shot] is paused in the following cases.
 - When the charge on the battery runs out
 - Turning the camera off

During [Time Lapse Shot], you can replace the battery and the card, and then restart by turning on this unit. (Note that pictures taken after the restart will be saved as a separate set of group pictures) Turn off this unit when replacing the battery or the card.

- When [Shooting Interval] is set to a longer value, if the camera turns off automatically while waiting for the next recording, we recommend that you use Time Lapse Shot in Auto Focus Mode.

Not available in these cases:

- This function is not available in the following cases:
 - [Handheld Night Shot]/[Panorama Shot] (Scene Guide Mode)
 - When using [Multi Exp.]





Creating Stop Motion Pictures ([Stop Motion Animation])

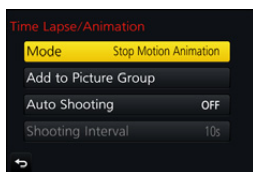

Applicable modes:         

A stop motion picture is created by splicing pictures together.

- 1 Set the drive mode dial to [].
- 2 Display the setup screen. (P136)
 - Switch to [Stop Motion Animation] if it is not selected. (P136)



[Auto Shooting]	[ON]	Takes pictures automatically at a set recording interval.
	[OFF]	This is for taking pictures manually, frame by frame.
[Shooting Interval]	(Only when [Auto Shooting] is set to [ON]) Press  /  to select the recording interval (seconds), press  /  to set it, and press [MENU/SET].	

- 3 Press the shutter button halfway.
 - The recording screen will be displayed. You can also perform the same operation by pressing and holding /  until the recording screen is displayed.



4 Press the shutter button fully.

- Up to 9999 frames can be recorded.

5 Move the subject to decide on the composition.

- Repeat recording in the same way.
- If this unit is turned off while recording, a message for resuming the recording is displayed when the camera is turned on. Selecting [Yes] allows you to continue the recording from the interruption point.

**Recording materials skillfully**

- The recording screen displays up to two pictures taken previously. Use them as reference for the amount of movement.
- Pressing [▶] allows you to check recorded pictures. Unnecessary pictures can be deleted by pressing [🗑️]. Pressing [▶] again will return you to the recording screen.

6 Touch [👉] to end the recording.

- It can also be ended by selecting [Time Lapse/Animation] from the [Rec] menu and then pressing [MENU/SET].
- When [Auto Shooting] is set to [ON], select [End] on the confirmation screen.
(If [Pause] has been selected, press the shutter button fully to resume the recording.)
- After the recording stops, a confirmation screen will be displayed, asking whether to proceed to create a motion picture.
To create a motion picture, select [Yes].
For information on creating motion pictures, refer to [P140](#).

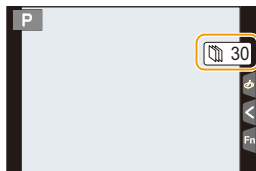
**Changing the settings of Stop Motion Animation**

You can change the settings in [Time Lapse/Animation] in the [Rec] menu.

Adding pictures to the Stop Motion Animation group

Selecting [Add to Picture Group] in step **2** will display group pictures recorded with [Stop Motion Animation].

Select a set of group pictures, and then press [MENU/SET].



- Automatic recording may not take place at set intervals because recording takes time under certain recording conditions, such as when the flash is used for recording.
- A picture cannot be selected from [Add to Picture Group] when it is the only one that was taken.



Not available in these cases:

- This function is not available in the following cases:
 - [Panorama Shot] (Scene Guide Mode)
 - When using [Multi Exp.]
- [Auto Shooting] in [Stop Motion Animation] is not available for the following functions:
 - [Handheld Night Shot] (Scene Guide Mode)

Creating motion pictures from recorded pictures

To create motion pictures after taking pictures, follow the steps below.

1 Select the methods for creating a motion picture.

- The recording format is set to [MP4].

[Rec Quality]	Sets the quality of a motion picture.
[Frame Rate]	Sets the number of frames per second. The larger the number is, the smoother the motion picture will be.
[Sequence]	[NORMAL]: Splices pictures together in recording order. [REVERSE]: Splices pictures together in reverse recording order.

2 Press ▲/▼ to select [OK] and then press [MENU/SET].





- You can also create motion pictures using [Time Lapse Video] (P241) or [Stop Motion Video] (P241) in the [Playback] menu.
- When creating motion pictures with a [Rec Quality] setting of [4K/30p] or [4K/24p], recording times are limited to 29 minutes and 59 seconds.
 - When using an SDHC Memory Card, you cannot create motion pictures with a file size exceeding 4 GB.
 - When using an SDXC Memory Card, you can create motion pictures with a file size exceeding 4 GB.
- A motion picture with a [Rec Quality] setting of [FHD/60p], [FHD/30p], or [HD/30p] cannot be created if the recording time exceeds 29 minutes and 59 seconds or the file size exceeds 4 GB.

Taking Pictures While Adjusting a Setting Automatically (Bracket Recording)

Applicable modes: 

You can take multiple pictures while automatically adjusting a setting by pressing the shutter button.

1 Select the menu. (P51)

MENU →  [Rec] → [Bracket] → [Bracket Type]	
 (Exposure Bracket)	Press the shutter button to perform recording while adjusting the exposure. (P142)
 (Aperture Bracket)*	Press the shutter button to perform recording while adjusting the aperture. (P143)
FOCUS (Focus Bracket)	Press the shutter button to perform recording while adjusting the focus position. (P143)
 (White Balance Bracket)	Press the shutter button once to take three pictures with different white balance settings automatically. (P113)

* Available in Aperture-Priority AE Mode or when the ISO sensitivity is set to [AUTO] in Manual Exposure Mode.

2 Press ▲/▼ to select [More settings] and then press [MENU/SET].

- For information on [More settings], refer to the page that describes each function.
- Press the shutter button halfway to exit the menu.

3 Focus on the subject and take a picture.

- When Exposure Bracket is selected, the bracket display flashes until all of the pictures you have set are taken. If you change the bracket settings or turn off the camera before all of the pictures you have set are taken, the camera restarts recording from the first picture.

■ To cancel [Bracket Type]

Select [OFF] in step 1.



**Not available in these cases:**

- Bracket recording is disabled in the following cases.
 - [Glistening Water]/[Glittering Illuminations]/[Handheld Night Shot]/[Soft Image of a Flower]/[Panorama Shot] (Scene Guide Mode)
 - [Rough Monochrome]/[Silky Monochrome]/[Miniature Effect]/[Soft Focus]/[Star Filter]/[Sunshine] (Creative Control Mode)
 - When recording using the flash (except for White Balance Bracket)
 - When recording motion pictures
 - When recording in Burst Mode (only when [Burst Rate] is set to [SH])
 - When recording 4K photos
 - When recording with the Post Focus function
 - When using [Multi Exp.]
 - When using [Time Lapse Shot]
 - When using [Stop Motion Animation] (only when [Auto Shooting] is set)

Exposure Bracket**About [More settings] (step 2 in P141)**

[Step]	Sets the number of pictures to be taken and the exposure compensation range. [3•1/3] (Takes three pictures with an interval of 1/3 EV) to [7•1] (Takes seven pictures with an interval of 1 EV)
[Sequence]	Sets the order in which pictures are taken.
[Single Shot Setting]*	[□]: Takes one picture each time you press the shutter button. [☑]: Takes all the pictures set to be taken when you press the shutter button once.

- * Not available for burst recording. When using burst recording, if you press and hold the shutter button, recording will be performed continuously until a specified number of pictures are taken.

[Step]: [3•1/3], **[Sequence]:** [0/–/+]

1st picture**± 0 EV****2nd picture****– 1/3 EV****3rd picture****+ 1/3 EV**

- When taking pictures using Exposure Bracket after setting the Exposure Compensation value, the pictures taken are based on the selected Exposure Compensation value.

Aperture Bracket

Recording Mode: **A** **M**

About [More settings] (step 2 in P141)

[Image Count]

[3], [5]: Takes a specified number of pictures with different aperture values within the range based on the initial aperture value.

[ALL]: Takes pictures using all aperture values.

• When using burst recording, if you press and hold the shutter button, recording will be performed until a specified number of pictures are taken.

The available aperture values vary depending on the lens.

Example: when using the interchangeable lens (H-FS12060)



When the initial position is set to F8.0:

① first picture, ② second picture, ③ third picture... ⑦ seventh picture

Focus Bracket

About [More settings] (step 2 in P141)

[Step]

Sets the interval between focus positions.

• The distance by which the focus position moves in each step will be shorter if the initial position is closer to a subject, and conversely if the initial position is farther from a subject, the distance will be longer.

[Image Count]*

Sets the number of pictures to be taken.

[Sequence]

[0/-/+]: Alternately moves the focus position closer and farther away within the range centered on the initial position as you take pictures.
 [0/+]: Moves the focus position farther away from the initial position as you take pictures. If you want to merge pictures to create a picture with a large depth of field by using commercially available software, we recommend that you use this setting.

* Not available for burst recording. When using burst recording, if you press and hold the shutter button, recording will be performed continuously until a specified number of pictures are taken.

[Sequence]: [0/-/+]



[Sequence]: [0/+]



(A) Focus: closer



(B) Focus: farther away

① first picture, ② second picture... ⑤ fifth picture...

















• Pictures taken with Focus Bracket are displayed as a set of group pictures. (P182)

• If you want to merge pictures with commercially available software, we recommend that you adjust the [Step] and [Image Count] settings while taking pictures and checking them. With a lens with smaller maximum aperture, you may need a larger number of pictures.

Image Stabilizer

The camera can activate either the In-Lens Image Stabilizer or In-Body Image Stabilizer, or it can activate both of them and reduce jitter even more effectively. (Dual I.S. Mode) Dual I.S.2 (, , ), which provides more effective correction, is also supported. For motion picture recording, you can use the 5-Axis Hybrid Image Stabilizer, which makes use of the In-Lens Image Stabilizer, In-Body Image Stabilizer, and Electronic Image Stabilizer.

- The image stabilizers to be activated differ depending on your lens. The icon for the currently activated image stabilizer is displayed on the recording screen.

	When taking pictures	When recording motion pictures
Panasonic lenses compatible with Dual I.S. Mode (Based on the Micro Four Thirds System standard) <ul style="list-style-type: none"> For the latest information on compatible lenses, please refer to our website. (P17) If the [DUAL2] or [DUAL] icon is not displayed on the recording screen even when a compatible lens is used, update the lens firmware to the latest version. (P17) 	Lens + Body (Dual I.S.) ( /  /  / )	Lens + Body (Dual I.S.) ( / ), 5-Axis Hybrid ( / )*
Lenses compatible with the image stabilizer function (Based on the Micro Four Thirds System standard/Four Thirds System standard)	Lens or Body ( / )	Lens or Body (), 5-Axis Hybrid ()*
Lenses not compatible with the image stabilizer function (Based on the Micro Four Thirds System standard/Four Thirds System standard)	Body ( / )	Body (), 5-Axis Hybrid ()*
When using a Leica lens mount adaptor (optional) or mount adaptor made by another manufacturer		

* When [E-Stabilization (Video)] is set to [ON]



Setting the focal length of a lens

1 Select the menu. (P51)

MENU → **[Rec]** → **[Stabilizer]** → **[Focal Length Set]**

2 Select the focal length of your lens with ◀/▶.

- A focal length ranging from 8 mm to 1000 mm can be set.
- If the focal length setting for your lens is not found, select a value close to the focal length of your lens.



3 Press **[MENU/SET]**.

■ Registering a focal length

- 1 Perform step 2 in “Setting the focal length of a lens”.
- 2 Press **▼**.
- 3 Press **◀/▶** to select the focal length to be overwritten and then press **[DISP.]**.
 - Up to 3 focal length settings can be registered.



■ Setting a registered focal length

- 1 On the screen in step 2 of “Setting the focal length of a lens”, press **▼**.
- 2 Press **◀/▶** to select the registered focal length and then press **[MENU/SET]**.



• **The Image Stabilizer may produce operational sound or cause vibration during its operation, but these are not malfunctions.**

- It is recommended to disable the Image Stabilizer when using a tripod.

• **The stabilizer function may not be effective in the following cases.**

Be careful of camera jitter when you press the shutter button.

- When there is a lot of jitter
 - When the zoom magnification is high
 - When using the Digital Zoom
 - When taking pictures while following a moving subject
 - When the shutter speed becomes slower to take pictures indoors or in dark places
- **The panning effect in [] is more difficult to achieve in the following cases.**
- In brightly lit places such as in broad daylight on a summer's day
 - When the shutter speed is faster than 1/100th of a second
 - When you move the camera too slowly because the subject is moving slowly (The background will not become a blur)
 - When the camera does not keep up with the subject satisfactorily

 **Not available in these cases:**

- Even when [Stabilizer] is set to [] (Normal), if you set Scene Guide Mode to [Panorama Shot], the setting will change to [] (Panning).
- In the following cases, the [Stabilizer] will switch to [] (Normal), even if it is set to [] (Panning):
 - When recording motion pictures
 - When recording 4K photos
 - When recording with the Post Focus function
- The 5-Axis Hybrid Image Stabilizer function is not available in the following cases:
 - When using the Digital Zoom

Taking Pictures with the Zoom

Optical zoom

Applicable modes:   **P** **A** **S** **M**   

You can zoom-in to make people and objects appear closer or zoom-out to record landscapes, etc.

T side: Enlarges distant subject

W side: Widens angle of view

Interchangeable lens with a zoom ring
(H-FS12060/
H-FS14140/
H-FS1442A)

Rotate the zoom ring.

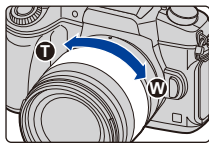

Interchangeable lens that supports the power zoom (electrically operated zoom)

Move the zoom lever.

(The zoom speed varies depending on how far you move the lever.)

- If you assign [Zoom Control] to a function button, you can operate the optical zoom slowly by pressing ◀/▶ or fast by pressing ▲/▼.

For information on how to operate, refer to step **2** and the subsequent steps on [P150](#).

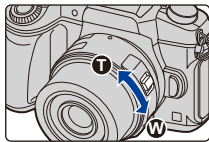

Interchangeable lens that does not support the zoom

The optical zoom is not available.

Raising the telescopic effect

[Ex. Tele Conv.]

Applicable modes:   **P** **A** **S** **M**   

Extended Tele Conversion enables you to take pictures that are further enlarged without deteriorating the picture quality.

When taking pictures	[Ex. Tele Conv.] ([Rec])	1.2×: [EX] M ([16:9]) 1.4×: [EX] M ([4:3]/[3:2]/[1:1]) 2.0×: [EX] S ([4:3]/[3:2]/[16:9]/[1:1])
<p>• Set the picture size to [M] or [S] (picture sizes indicated with [EX]), and set the quality to [iA] or [iM].</p>		
When recording motion pictures	[Ex. Tele Conv.] ([Motion Picture])	2.4× (motion pictures size is set to [FHD] in [Rec Quality]) 3.6× (motion pictures size is set to [HD] in [Rec Quality])

■ Increasing the zoom magnification in steps

- This can be used only when recording pictures.

1 Select the menu. (P51)

MENU → [Rec] → [Ex. Tele Conv.] → [ZOOM]

2 Set a function button to [Zoom Control]. (P55)

3 Press the function button.

4 Press ◀/▶ or ▲/▼.

▲/▶: Tele (Enlarges distant subject)

▼/◀: Wide (Widens angle of view)

- The zoom operation is terminated when the function button is pressed again or a certain amount of time passes.



(A) Optical Zoom range (Focal length)*

(B) Extended Tele Conversion range for still picture recording (Zoom magnification)

* This zoom slider is displayed when using an interchangeable lens that supports the power zoom.



- A constant zoom speed will be set.
- The indicated zoom magnification is an approximation.

■ Fixing the zoom magnification at the maximum level

Select the menu. (P51)

MENU → [Rec] → [Ex. Tele Conv.] → [TELE CONV.]

MENU → [Motion Picture] → [Ex. Tele Conv.] → [ON]

[OFF]



[TELE CONV.]/[ON]

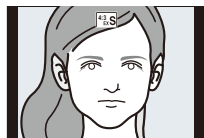

- If you assign [Ex. Tele Conv.] to [Fn Button Set] (P55) in the [Custom] menu, you can display the Extended Tele Conversion setting screen for both pictures and motion pictures by pressing the assigned function button. While this screen is displayed, you can change the [Picture Size] setting by pressing [DISP].

 **Not available in these cases:**

- This function is not available in the following cases:
 - [Handheld Night Shot]/[Panorama Shot] (Scene Guide Mode)
 - [Toy Effect]/[Toy Pop] (Creative Control Mode)
 - When [Quality] is set to [RAW_{III}], [RAW_{II}] or [RAW]
 - When recording in Burst Mode (only when [Burst Rate] is set to [SH])
 - When recording 4K photos
 - When recording with the Post Focus function
 - When [HDR] is set to [ON]
 - When using [Multi Exp.]
 - When the MP4 motion picture size is set to [4K] in [Rec Quality]
 - When [4K Live Cropping] is set
 - When the image of the camera is output through the HDMI connection (except for Creative Video Mode)

[Digital Zoom]

Applicable modes:   **P** **A** **S** **M**   

Although the image quality deteriorates every time you zoom in further, you can zoom in up to four times the original zoom magnification. (Continuous zooming is not possible.)

MENU →  **[Rec]** → **[Digital Zoom]** → **[4×]/[2×]**

- When using the Digital Zoom, we recommend using a tripod and the self-timer (P135) for taking pictures.

 **Not available in these cases:**

- This function is not available in the following cases:
 - [Toy Effect]/[Toy Pop]/[Miniature Effect] (Creative Control Mode)
 - When recording with the Post Focus function
 - When using [Multi Exp.]



Changing the settings for a power zoom lens

Applicable modes:   **P** **A** **S** **M**   

Sets the screen display and lens operations when using an interchangeable lens that is compatible with power zoom (electrically operated zoom).

- This may only be selected when using a lens that is compatible with power zoom (electrically operated zoom).

MENU → f_c [Custom] → **[Power Zoom Lens]**

<p>[Disp Focal Length]</p>	<p>When you zoom, the focal distance is displayed and you can confirm the zoom position.</p> <p>Ⓐ Focal distance indication Ⓑ Current focal distance</p>	
<p>[Step Zoom]</p>	<p>When you operate the zoom with this setting [ON], the zoom will stop at positions corresponding to predetermined distances.</p> <p>Ⓒ Step zoom indication</p> <ul style="list-style-type: none"> • This setting does not work when recording motion pictures or 4K photos with [] ([4K Pre-Burst]). 	
<p>[Zoom Speed]</p>	<p>You can set the zoom speed for zoom operations.</p> <ul style="list-style-type: none"> • If you set [Step Zoom] to [ON], the zoom speed will not change. <p>[Photo]: [H] (High speed)/[M] (Middle speed)/[L] (Low speed) [Video]: [H] (High speed)/[M] (Middle speed)/[L] (Low speed)</p>	
<p>[Zoom Ring]</p>	<p>This may only be selected when a power zoom-compatible lens with a zoom lever and zoom ring is attached.</p> <p>When set to [OFF], the operations controlled by the zoom ring are disabled to prevent accidental operation.</p>	

Zooming using touch operations (Touch zoom)

(Optical Zoom and Extended Tele Conversion for still picture recording are operable)

• If you are using an interchangeable lens not supporting power zoom (H-FS12060/H-FS14140/H-FS1442A), you can only operate Extended Tele Conversion for pictures by setting [Ex. Tele Conv.] (P149) to [ZOOM].

1 Touch [].



2 Touch [].

- The slide bar is displayed.



3 Perform zoom operations by dragging the slide bar.

- The zoom speed varies depending on the touched position.

	Zooms slowly
	Zooms quickly

- Touch [] again to end touch zoom operations.



 **Not available in these cases:**

- This function is not available in the following cases:
 - When recording 4K photos

Taking pictures by using the flash

Applicable modes: **[A]** **[Av]** **[P]** **[A]** **[S]** **[M]** **[M]** **[SCN]** **[i]**

■ Open/Close the built-in flash

Taking a picture using the flash becomes possible by opening the built-in flash.

(A) To open the flash

Slide the flash open lever.

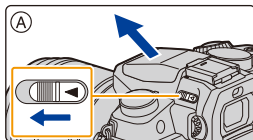

(B) To close the flash

Press the flash until it clicks.

- Forcibly closing the flash can damage the camera.
- Be sure to close the built-in flash when not in use.
- The flash setting is fixed to **[☺]** while the flash is closed.

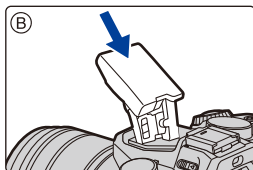

- **Be careful when opening the flash as the flash will jump out.**
- **Be careful not to catch a finger when closing the flash bulb.**



In the following cases, the flash is fixed to **[☺] (forced flash off).**

- When recording motion pictures
- When recording in Burst Mode (only when [Burst Rate] is set to [SH])
- When recording 4K photos
- When recording with the Post Focus function
- When using the electronic shutter
- When [HDR] is set to [ON]
- When [Silent Mode] is set to [ON]
- When an image effect in [Filter Effect] of [Filter Settings] is set



Using the flash skillfully

- When taking pictures with flash with the lens hood attached, the lower portion of the photo may turn dark and the control of the flash may be disabled because the photo flash may be obscured by the lens hood. We recommend detaching the lens hood.

■ The available flash range (approximation)

When you use certain lenses, light from the flash may be blocked or fail to cover the lens field of view, causing dark areas to appear in the resulting pictures.

The distance at which light from the flash is blocked by lens, and the distance to which light from the flash is delivered vary depending on the lens used. Check the distance to the subject when taking a picture.



When the interchangeable lens (H-FS12060) is used

Wide	Tele
0.5 m (1.6 feet) to 7.3 m (24 feet)	0.3 m (0.98 feet) to 4.5 m (15 feet)

When the interchangeable lens (H-FS14140) is used

Wide	Tele
0.5 m (1.6 feet) to 7.3 m (24 feet)	0.5 m (1.6 feet) to 4.5 m (15 feet)

When the interchangeable lens (H-FS1442A) is used

Wide	Tele
0.5 m (1.6 feet) to 7.3 m (24 feet)	0.3 m (0.98 feet) to 4.5 m (15 feet)

- These are the ranges when the ISO sensitivity is set to [AUTO] and [ISO Limit Set] (P199) is set to [OFF].
- Do not bring the flash too close to objects or close the flash while it is activated. The objects may be discolored by its heat or lighting.
- Do not close the flash soon after the flash is activated prior to taking pictures due to Forced ON/ Red-Eye Reduction etc. It causes a malfunction.
- It may take time to charge the flash if you repeatedly take pictures. You must wait a moment to take the next picture while the flash icon is blinking red indicating the flash is charging.
- When you attach an external flash, it takes priority over the built-in flash. Refer to P306 for the external flash.

Setting the Flash Functions

Changing the firing mode

Applicable modes:          

Select whether to set the flash output automatically or manually.

1 Select the menu. (P51)

MENU →  **[Rec]** → **[Flash]** → **[Firing Mode]**

[TTL]	The camera automatically sets the flash output.
[MANUAL]	Set the luminosity ratio of the flash manually. In [TTL] you can shoot the photograph you want even when shooting dark scenes that may otherwise be too brightly lit by the flash. <ul style="list-style-type: none"> • When [MANUAL] is set, the luminosity ratio ([1/1], etc.) is displayed on the flash icon on the screen.

2 (When [MANUAL] is selected)

Select the menu.

MENU →  **[Rec]** → **[Flash]** → **[Manual Flash Adjust.]**

3 Press ◀/▶ to select an item and then press [MENU/SET].

- You can set from [1/1] (full brightness) to [1/128] in steps of [1/3].

• This item is not available when an external flash is being used.

Changing Flash Mode

Applicable modes:

Set the flash to match the recording.

Select the menu. (P51)

MENU → **[Rec]** → **[Flash]** → **[Flash Mode]**

((Forced Flash On)) ((Forced On/Red-Eye))*	<p>The flash is activated every time regardless of the recording conditions.</p> <ul style="list-style-type: none"> • Use this when your subject is back-lit or under fluorescent light. 	
((Slow Sync.)) ((Slow Sync./Red-Eye))*	<p>When taking pictures against a dark background landscape, this feature will slow the shutter speed when the flash is activated. Dark background landscape will appear brighter.</p> <ul style="list-style-type: none"> • Use this when you take pictures of people in front of a dark background. • Using a slower speed can cause motion blur. Using a tripod can enhance your photos. 	
((Forced Flash Off))	<p>The flash is not activated in any recording conditions.</p> <ul style="list-style-type: none"> • Use this when you take pictures in places where the use of flash is not permitted. • This item is available only when using an external flash. 	

- * It can be set only when [Wireless] in [Flash] is set to [OFF] and [Firing Mode] is set to [TTL].
- Some flash modes may not be available depending on the external flash's settings.

The flash is activated twice.

The interval between the first and second flash is longer when [] or [] is set. The subject should not move until the second flash is activated.





- The Red-Eye Reduction effect differs between people. Also, if the subject was far away from the camera or was not looking at the first flash, the effect may not be evident.

■ Available flash settings by Recording Mode

The available flash settings depend on the Recording Mode.

(○: Available, —: Not available, ●: Initial setting of Scene Guide Mode)

Recording Mode		⚡	⚡Ⓢ	⚡S	⚡SⓈ	Ⓢ
P A	Program AE Mode	○	○	○	○	○
	Aperture-Priority AE Mode	○	○	○	○	○
S M	Shutter-Priority AE Mode	○	○	—	—	○
	Manual Exposure Mode	○	○	—	—	○
SCN Scene Guide Mode	[Clear Portrait]	○	●	—	—	○
	[Silky Skin]	○	●	—	—	○
	[Backlit Softness]	—	—	—	—	●
	[Clear in Backlight]	●	—	—	—	○
	[Relaxing Tone]	—	—	—	—	●
	[Sweet Child's Face]	○	●	—	—	○
	[Distinct Scenery]	—	—	—	—	●
	[Bright Blue Sky]	—	—	—	—	●
	[Romantic Sunset Glow]	—	—	—	—	●
	[Vivid Sunset Glow]	—	—	—	—	●
	[Glistening Water]	—	—	—	—	●
	[Clear Nightscape]	—	—	—	—	●
	[Cool Night Sky]	—	—	—	—	●
	[Warm Glowing Nightscape]	—	—	—	—	●
	[Artistic Nightscape]	—	—	—	—	●
	[Glittering Illuminations]	—	—	—	—	●
	[Handheld Night Shot]	—	—	—	—	●
	[Clear Night Portrait]	—	—	—	●	○
	[Soft Image of a Flower]	●	—	—	—	○
	[Appetizing Food]	●	—	—	—	○
	[Cute Dessert]	●	—	—	—	○
	[Freeze Animal Motion]	●	—	—	—	○
	[Clear Sports Shot]	●	—	—	—	○
	[Monochrome]	●	○	○	○	○
[Panorama Shot]	—	—	—	—	●	

- In Intelligent Auto Mode ( or ), the flash will be set to [A] or [S]. (P61)
- The Scene Guide Mode flash setting is returned to the initial value with each change of scene.

■ Shutter speed for each flash setting

Flash setting	Shutter speed (Sec.)	Flash setting	Shutter speed (Sec.)
⚡	1/60th* to 1/160th	⚡S	1 to 1/4000th
⚡Ⓜ		⚡SⓂ	

* This becomes 60 seconds in Shutter-Priority AE Mode and B (Bulb) in the Manual Exposure Mode.

- When the flash is activated the fastest shutter speed that can be selected is 1/160th of a second.
- In Intelligent Auto (IA or IA+) Mode, shutter speed changes depending on the identified scene.



Setting to the 2nd Curtain Synchro

Applicable modes: IA IA+ P A S M   

2nd curtain synchro activates the flash just before the shutter closes when taking pictures of moving objects such as cars using a slow shutter speed.

Select the menu. (P51)

MENU →  [Rec] → [Flash] → [Flash Synchro]

[1ST]	1st curtain synchro The normal method when taking pictures with the flash.	
[2ND]	2nd curtain synchro The light source appears behind the subject and picture becomes dynamic.	

- [2nd] is displayed in the flash icon on the screen if you set [Flash Synchro] to [2ND].
- Only available when [Wireless] in [Flash] is set to [OFF]. (P162)
- The [Flash Synchro] settings also apply to an external flash. (P306)
- When a fast shutter speed is set, the effect of [Flash Synchro] may deteriorate.
- You cannot set [⚡Ⓜ] or [⚡SⓂ] when [Flash Synchro] is set to [2ND].

Adjust the flash output

Applicable modes:   **P** **A** **S** **M**   

Adjust the flash brightness when pictures taken with the flash are over or underexposed.

1 Select the menu. (P51)

MENU →  **[Rec]** → **[Flash]** → **[Flash Adjust.]**

2 Press **◀/▶** to set the flash output and then press **[MENU/SET]**.

- You can adjust from [−3 EV] to [+3 EV] in steps of 1/3 EV.
- Select [±0] to return to the original flash output.

- [+] or [−] is displayed on the flash icon in the screen when the flash level is adjusted.
- It can be set only when [Wireless] in [Flash] is set to [OFF] and [Firing Mode] is set to [TTL]. (P156, 162)
- The [Flash Adjust.] setting also applies to an external flash. (P306)

Synchronizing the output of the flash to the Exposure Compensation

Applicable modes:   **P** **A** **S** **M**   

Select the menu. (P51)

MENU →  **[Rec]** → **[Flash]** → **[Auto Exposure Comp.]**

Settings: **[ON]/[OFF]**

- For details on Exposure Compensation, refer to P106.
- The [Auto Exposure Comp.] setting also applies to an external flash. (P306)

Taking Pictures with Wireless Flashes

Applicable modes:  P A S M

By using flashes that support the wireless control (DMW-FL200L, DMW-FL360L, DMW-FL580L: optional), you can control firing of the built-in flash (or a flash attached to the hot shoe of this unit) and three flash groups separately.

■ Placing wireless flashes

Place the wireless flash with its wireless sensor facing toward the camera.

The following figure shows the estimated controllable range when you take pictures by holding the camera horizontally. Controllable range differs depending on the surrounding environment.

Placement range

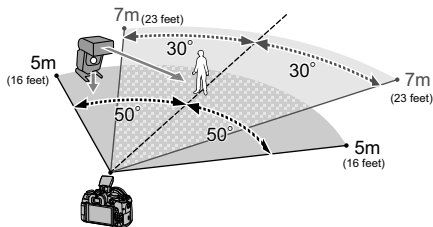

Placement example

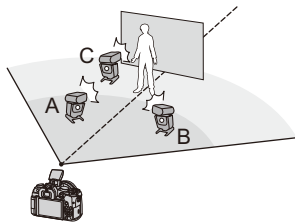

- In this placement example, flash C is placed to erase the shadow of the subject that flashes A and B will create.
- The recommended number of wireless flashes for each group is three or less.
- If the subject is too close, signal flashing may affect the exposure.

If you set [Communication Light] to [LOW] or lower the output with a diffuser or similar product, the effect will be reduced.

Preparations:

Open the flash by sliding the flash open lever of this unit.

Alternatively, attach a flash (DMW-FL200L, DMW-FL360L, DMW-FL580L: optional) to this unit.

1 Set the wireless flashes to RC Mode and then place them.

- Set a channel and groups for the wireless flash.



2 Select the menu. (P51)

MENU → [Rec] → [Flash]	
[Wireless]	Select [ON].
[Wireless Channel]	Select the channel you have set for the wireless flashes in step 1.
[Wireless Setup]	Proceed to step 3.

3 Press ▲/▼ to select an item and then press [MENU/SET].

• Press [DISP.] to fire a test-flash.

- (A) Firing Mode
- (B) Flash output
- (C) Luminosity ratio



[Built-in Flash]*1/ [External Flash]*1	[Firing Mode]
	<p>[TTL]: The camera automatically sets the output.</p> <p>[AUTO]*2,3: Flash output is set by the external flash.</p> <p>[MANUAL]*3: Set the luminosity ratio of the external flash manually.</p> <p>[OFF]: The flash on the camera side emits only communication light.</p>
	<p>[Flash Adjust.] Set the flash output of the camera manually when [Firing Mode] is set to [TTL].</p> <p>[Manual Flash Adjust.] Set the luminosity ratio of the external flash when [Firing Mode] is set to [MANUAL].</p> <p>• You can set from [1/1] (full brightness) to [1/128] in steps of 1/3.</p>
[A Group]/ [B Group]/ [C Group]	[Firing Mode]
	<p>[TTL]: The camera automatically sets the output.</p> <p>[AUTO]*1: The wireless flashes automatically set the output.</p> <p>[MANUAL]: Set the luminosity ratio of the wireless flashes manually.</p> <p>[OFF]: The wireless flashes of the specified group will not fire.</p>
	<p>[Flash Adjust.] Adjust the output of the wireless flashes manually when [Firing Mode] is set to [TTL].</p> <p>[Manual Flash Adjust.] Set the luminosity ratio of the wireless flashes when [Firing Mode] is set to [MANUAL].</p> <p>• You can set from [1/1] (full brightness) to [1/128] in steps of 1/3.</p>

*1 Not available when [Wireless FP] is set to [ON].

*2 This option is not displayed when the flash (DMW-FL200L: optional) is attached to the camera.

*3 You can select these options only when the external flash is attached to the camera.

Using other settings for wireless flash recording

Enabling FP firing for the wireless flashes

During wireless recording, an external flash fires an FP flash (high speed repetition of flash firing). This firing allows recording with the flash at a fast shutter speed.

Select the menu. (P51)

MENU →  **[Rec]** → **[Flash]** → **[Wireless FP]**

Settings: **[ON]/[OFF]**

Setting the output of communication light

Select the menu. (P51)

MENU →  **[Rec]** → **[Flash]** → **[Communication Light]**

Settings: **[HIGH]/[STANDARD]/[LOW]**

Recording Motion Picture/4K Motion Picture

Applicable modes:   P A S M   

This camera can record full high definition motion pictures compatible with the AVCHD format or motion pictures recorded in MP4.

In addition, the camera can record 4K motion pictures in MP4. (P166)

Audio will be recorded in stereo.

1 Start recording by pressing the motion picture button.

- (A) Elapsed recording time
- (B) Available recording time

- Recording of motion picture appropriate for each mode is possible.
- The recording state indicator (red) (C) will flash while recording motion pictures.
- Release the motion picture button right after you press it.
- h: hour, m: minute, s: second

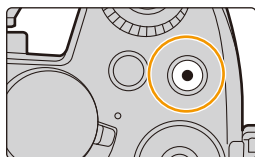

2 Stop the recording by pressing the motion picture button again.

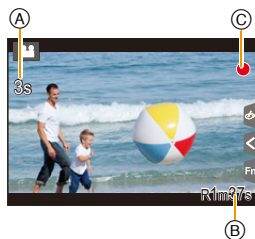

About the operation sound that is produced when you stop recording

If the operation sound of the motion picture button pressed to end recording bothers you, try the following:

- Record the motion picture about three seconds longer, and then divide the last part of the motion picture using [Video Divide] (P240) in the [Playback] menu.
- Set the camera to Creative Video Mode, and use a shutter remote control (optional) to record motion pictures. (P309)



- When the ambient temperature is high or motion picture is recorded continuously, the camera may display [] and stop the recording to protect itself. Wait until the camera cools down.
- The operational sound of the zoom or button operation may be recorded when it is operated during the recording of a motion picture.
- Depending on the type of the card, the card access indication may appear for a while after recording motion pictures. This is not a malfunction.
- When the aspect ratio setting is different in still and motion pictures, the angle of view changes at the start of motion picture recording.
When [Rec Area] is set to [], angle of view during motion picture recording is displayed.
- The [Sensitivity] will be set to [AUTO] (for motion pictures) when recording motion pictures.
- The functions available when recording motion pictures differ according to the lens you are using, and the operational sound of the lens may be recorded.
- It will be recorded in the following categories for certain Recording Modes.

Selected Recording Mode	Recording Mode while recording motion picture
– [Clear in Backlight] (Scene Guide Mode)	Portrait Mode
– [Clear Nightscape]/[Artistic Nightscape]/[Handheld Night Shot]/[Clear Night Portrait] (Scene Guide Mode)	Low Light Mode

Not available in these cases:

- Motion pictures cannot be recorded in the following cases.
 - [Glistening Water]/[Glittering Illuminations]/[Soft Image of a Flower]/[Panorama Shot] (Scene Guide Mode)
 - [Rough Monochrome]/[Silky Monochrome]/[Soft Focus]/[Star Filter]/[Sunshine] (Creative Control Mode)
 - When recording with the Post Focus function
 - When using [Time Lapse Shot]
 - When using [Stop Motion Animation]

Setting the format, size and recording frame rate

1 Select the menu. (P51)

MENU →  **[Motion Picture]** → **[Rec Format]**

[AVCHD]	This data format is suitable for when playing back on a high-definition TV, etc.
[MP4]	This data format is suitable for when playing back on a PC, etc.

2 Press ▲/▼ to select **[Rec Quality]** and then press **[MENU/SET]**.

When **[AVCHD]** is selected

Item	Size	Recording frame rate	Sensor output	Bit rate
[FHD/28M/60p]*1	1920×1080	60p	60 frames/second	28 Mbps
[FHD/17M/60i]	1920×1080	60i	60 frames/second	17 Mbps
[FHD/24M/30p]	1920×1080	60i	30 frames/second	24 Mbps
[FHD/24M/24p]	1920×1080	24p	24 frames/second	24 Mbps

*1 AVCHD Progressive

When **[MP4]** is selected

Item	Size	Recording frame rate	Sensor output	Bit rate
[4K/100M/30p]*2	3840×2160	30p	30 frames/second	100 Mbps
[4K/100M/24p]*2	3840×2160	24p	24 frames/second	100 Mbps
[FHD/28M/60p]	1920×1080	60p	60 frames/second	28 Mbps
[FHD/20M/30p]	1920×1080	30p	30 frames/second	20 Mbps
[HD/10M/30p]	1280×720	30p	30 frames/second	10 Mbps

*2 4K motion picture



- The higher the “Bit rate” value is, the higher the picture quality becomes. Since the camera employs the “VBR” recording method, the bit rate is changed automatically depending on the subject to record. As a result, the recording time is shortened when a fast-moving subject is recorded.
- When [Miniature Effect] is selected for Creative Control Mode, you cannot select the items used for 4K motion pictures.
- When recording motion pictures in 4K, use a card rated as UHS Speed Class 3. (P26)
- The angle of view of motion pictures in 4K is narrower than those of motion pictures in other sizes.
- To ensure highly accurate focus, 4K motion pictures are recorded at reduced Auto Focus speeds. It may be difficult to focus on the subject with Auto Focus, but this is not a malfunction.

■ About the compatibility of the recorded motion pictures

Even when a compatible device is used, recorded motion pictures may be played back with reduced picture and sound quality, or they may not be played back.

Also, recording information may not be displayed correctly. Use this unit to playback in such case.

- To play back motion pictures recorded with [FHD/28M/60p], [FHD/24M/30p] or [FHD/24M/24p] in [AVCHD] with another device, or to transfer them to another device, you need a compatible Blu-ray disc recorder or a PC on which the software “PHOTOfunSTUDIO” (P295) is installed.
- For motion pictures recorded with [MP4] set to [4K/100M/30p] or [4K/100M/24p], refer to “Watching 4K motion pictures on a TV/ Saving 4K motion pictures on your PC or recorder” on P288.

How to set focus when recording a motion picture ([Continuous AF])

Applicable modes:   **P** **A** **S** **M**   

Focusing changes depending on the Focus Mode setting (P91) and the [Continuous AF] setting in the [Motion Picture] menu.

Focus mode	[Continuous AF]	Description of settings
[AFS]/[AFF]/ [AFC]	[ON]	The camera automatically keeps focusing on subjects during recording.
	[OFF]	The camera maintains the focus position at the start of recording.
[MF]	[ON]/[OFF]	You can focus manually. (P102)

- When the focus mode is set to [AFS], [AFF] or [AFC], if you press the shutter button halfway while recording a motion picture, the camera will re-adjust the focus.
- Depending on the recording conditions or lens used, operational sound may be recorded when the Auto Focus is operated while recording a motion picture.
It is recommended to record with [Continuous AF] in the [Motion Picture] menu set to [OFF], if the sound of operation bothers you to avoid recording the lens noise.
- When operating the zoom while recording motion pictures, it may take time to come into focus.

Recording Motion Pictures that Pan and Zoom While Maintaining a Fixed Camera Position

([4K Live Cropping])

Recording Mode: 

By cropping your motion picture down from the 4K angle of view to Full High Definition, you can record a motion picture that pans and zooms in/out while leaving the camera in a fixed position.

- Hold the camera firmly in place while recording.
- A motion picture will be recorded at [FHD/20M/30p] under [MP4].



Pan

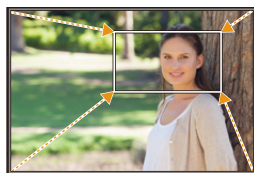

Zoom in

- When you want to zoom in/out, set different angles of view for the cropping start and end frames. For example, to zoom in, set a larger angle of view for the start frame and a smaller angle of view for the end frame.

1 Set mode dial to [].

2 Select the menu. (P51)

MENU →  **[Motion Picture]** → **[4K Live Cropping]** → **[40SEC]/[20SEC]**

- The angle of view narrows.



3 Set the cropping start frame.

Ⓐ Cropping start frame

- When making settings for the first time, a cropping start frame of size 1920×1080 is displayed. (After setting the cropping start frame and end frame, the start frame and end frame that you set immediately before will be displayed.)
- The camera will remember the frame position and size even when the camera is turned off.



Button operation	Touch operation	Description of operation
▲/▼/◀/▶	Touching	Moves the frame
	Pinching out/in	Enlarges/reduces the frame (The range of settings allowed is from 1920×1080 to 3840×2160.)
[DISP.]	[Reset]	Returns the position of the frame to the center and its size to the default setting.
[MENU/SET]	[Set]	Decides the position and size of the frame

4 Repeat step 3, and then set the cropping end frame.

Ⓑ Cropping end frame

- The setting of the Auto Focus Mode switches to [AF].
(The eye to be in focus is not indicated.)

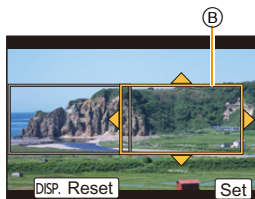

5 Press the motion picture button (or shutter button) to start recording.

- (A) Elapsed recording time
 - (B) Set operating time
 - Immediately release the motion picture button (or the shutter button) after pressing it.
 - When the set operating time has elapsed, recording automatically ends.
- To end recording midway, press the motion picture button (or the shutter button) again.

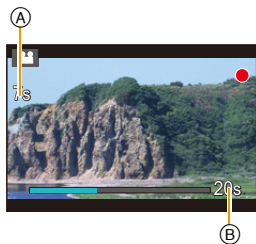

■ Changing the position and size of a crop frame

Press [Fn4] while the recording screen is displayed, and perform steps 3 and 4.

■ To cancel [4K Live Cropping] recording

Set [OFF] in step 2.

- Brightness is measured and focus is done in the cropping start frame. During motion picture recording, they are done in the crop frame. To lock the focus position, set [Continuous AF] to [OFF], or set the Focus Mode to [MF].
- [Metering Mode] will be [☉] (Multiple).

Recording still pictures while recording motion pictures

Applicable modes:   **P** **A** **S** **M**  

You can record still pictures while recording a motion picture. (Simultaneous recording)

During motion picture recording, press the shutter button fully to record a still picture.

- Simultaneous recording indicator is displayed while recording still pictures.
- Recording with the Touch Shutter function (P49) is also available.







■ Setting the motion picture priority or still picture priority mode

Applicable modes:   **P** **A** **S** **M**  

Select the menu. (P51)

MENU →  **[Motion Picture]** → **[Picture Mode]**

<p> [Video Priority]</p>	<ul style="list-style-type: none"> • Pictures will be recorded with a picture size determined by the [Rec Quality] setting for motion pictures. • Only JPEG images are recorded when [Quality] is set to [RAW , [RAW ] or [RAW]. (When set to [RAW], still pictures will be recorded in [Quality] of .) • Up to 40 still pictures can be recorded during recording of the motion picture. (An MP4 motion picture with a [Rec Quality] size of [4K]: up to 10 pictures)
<p> [Photo Priority]</p>	<ul style="list-style-type: none"> • Pictures will be recorded with the set picture size and quality. • The screen will go dark while recording pictures. A still picture will be recorded in the motion picture during that period, and audio is not recorded. • Up to 10 still pictures can be recorded during recording of the motion picture. (An MP4 motion picture with a [Rec Quality] size of [4K]: up to 5 pictures)



- The picture aspect ratio will be fixed to [16:9].



Not available in these cases:

- This function is not available in the following cases:
 - When [Rec Quality] is set to [4K/100M/24p] for MP4 motion picture or [FHD/24M/24p] for AVCHD motion pictures (only when [Photo Priority] is selected)
 - When the drive mode is set to 4K Photo (only when [Photo Priority] is set)
 - When using [Ex. Tele Conv.] in the [Motion Picture] menu (only when [Photo Priority] is set)
 - When [Snap Movie] is set to [ON]



MENU



Recording Snap Movies

Applicable modes:   **P** **A** **S** **M**   

You can specify the recording time in advance and record motion pictures casually like you take snapshots. The function also allows you to shift a focus at the start of recording and add fade in/out effects in advance.

- Motion pictures will be recorded with [FHD/20M/30p] in [MP4].
- Using the smartphone/tablet app "Panasonic Image App", you can combine motion pictures recorded with the camera. Music can be added and various editing operations can be performed when you combine them. In addition, you can send the combined motion picture to a web service. (P261)

1 Select the menu. (P51)

MENU →  **[Motion Picture]** → **[Snap Movie]** → **[ON]**

- Press the shutter button halfway to exit the menu.

2 Start recording by pressing the motion picture button.

- (A) Elapsed recording time
- (B) Set recording time
- Release the motion picture button right after you press it.
- You cannot stop motion picture recording in the middle. The recording will stop automatically when the set recording time has elapsed.



■ To deactivate Snap Movie

Select [OFF] in step 1.

■ Changing the Snap Movie settings

Select the menu. (P51)

MENU →  **[Motion Picture]** → **[Snap Movie]** → **[SET]**

[Record time]	Sets the recording time of motion pictures.
[Pull Focus]	Allows dramatic imaging expression by shifting focus gradually at the start of recording. (P176)
[Fade]	<p>Adds a fade-in (gradual appearance) effect to an image and audio as recording starts or adds a fade-out (gradual disappearance) effect to them as recording ends.</p> <p>[WHITE-IN]/[WHITE-OUT]: Adds a fade-in or fade-out effect that uses a white screen.</p> <p>[BLACK-IN]/[BLACK-OUT]: Adds a fade-in or fade-out effect that uses a black screen.</p> <p>[COLOR-IN]/[COLOR-OUT]: Adds an effect that fades in from black-and-white to color or an effect that fades out from color to black-and-white. Audio will be recorded normally.</p> <p>[OFF]</p>

- Motion pictures recorded with [WHITE-IN] or [BLACK-IN] are displayed as all-white or all-black thumbnails in Playback Mode.
- If you assign [Snap Movie] to [Fn Button Set] (P55), you can display a screen that lets you switch [Snap Movie] between [ON]/[OFF] by pressing the assigned function button. If you press [DISP.] while the screen is displayed, you can change the settings for Snap Movie.
- [Snap Movie] will be set to [OFF] when you connect to Wi-Fi with [Remote Shooting & View].
- This function is not available in the following cases:
 - [Miniature Effect] (Creative Control Mode)
 - When the drive mode is set to 4K Photo
 - When [4K Live Cropping] is set

Setting up [Pull Focus]

Set the frames that specify the positions where the [Pull Focus] starts (first position) and stops (second position).

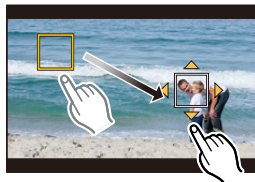

Button operation

- 1 Press **◀**.
- 2 Press **▲/▼/◀/▶** to move the AF area frame, and press **[MENU/SET]**. (First position)

- If you press **[DISP.]** before pressing **[MENU/SET]**, the frame will return to the center.

- 3 Repeat step 2. (Second position)

- If you press **[MENU/SET]**, the frame settings will be canceled.



Touch operation

Touch a subject (first position), drag your finger to the desired location (second position), and release the finger.

- If you touch **[, the frame settings will be canceled.**



- A greater effect can be achieved by creating a striking contrast of focus between the start and end positions, for example by shifting focus from the background to foreground, or vice versa.
- After setting focus, try to keep the distance between the subject and the camera constant.

- When the camera fails to set the frame, it returns to the first position.
- When [Pull Focus] is set to [ON]:
 - Auto Focus Mode will be switched to **[, a setting specially designed for [Pull Focus].**
 - If you take a picture, the Auto Focus operation **[ will take place at the first frame position.**
- Even when [Metering Mode] (P192) is set to **[, the spot metering target does not move with focus. The target is fixed at the start position (first position) of Pull Focus.**



Not available in these cases:

- This function is not available in the following cases:
 - In Manual Focus
 - When using the Digital Zoom

Playing Back Pictures

1 Press [▶].

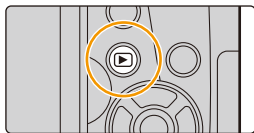

2 Press ◀/▶.

◀: Play back the previous picture

▶: Play back the next picture

- If you press and hold ◀/▶, you can play back the pictures in succession.
- Pictures can also be forwarded or rewound by rotating the front dial or dragging the screen horizontally. (P48)
- You can forward or rewind pictures continuously by keeping your finger on the left or right sides of the screen after forwarding/rewinding a picture.



Sending an image to a web service

If you press ▼ when displaying images one by one, you can easily send an image to a web service. (P274)

■ To finish playback

Press [▶] again or press the shutter button halfway.

Not available in these cases:

- This camera complies with the DCF standard “Design rule for Camera File system” established by JEITA “Japan Electronics and Information Technology Industries Association” and with Exif “Exchangeable Image File Format”.
This camera can only display pictures that comply with the DCF standard.
- The camera may not play back images recorded on other devices correctly, and the functions of the camera may not be available for the images.

Playing Back Motion Pictures

This unit was designed to play motion pictures using the AVCHD and MP4 formats.

- Motion pictures are displayed with the motion picture icon (🎬).

Press ▲ to play back.

- Ⓐ Motion picture recording time

- After playback starts, the elapsed playback time is displayed on the screen.

For example, 8 minutes and 30 seconds is displayed as [8m30s].

- Some information (recording information, etc.) is not displayed for motion pictures recorded in [AVCHD].
- Touching [▶] in the middle of the screen allows you to play back motion pictures.
- Motion pictures recorded with [Snap Movie] are played back automatically.

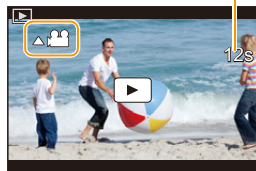

■ Operations during Motion Picture Playback

Button operation	Touch operation	Description of operation	Button operation	Touch operation	Description of operation
▲	▶/	Play/Pause	▼	■	Stop
◀	◀◀	Fast rewind*1	▶	▶▶	Fast forward*1
	◀	Frame-by-frame rewind (while pausing)*2		▶	Frame-by-frame forward (while pausing)
🔊	−	Reduce volume level	🔊	+	Increase volume level

*1 The fast forward/rewind speed increases if you press ▶/◀ again.

*2 When a motion picture recorded with [AVCHD] is rewound frame-by-frame, its frames will be shown in intervals of approximately 0.5 seconds.

■ Operations during automatic Snap Movie playback

▲	Playback from the beginning
◀	Back to previous picture
▶	Ahead to next picture

- If you touch the screen, automatic playback will stop.

- You can play back motion pictures on a PC with "PHOTOfunSTUDIO" (P295).

Creating Still Pictures from a Motion Picture

You can save a scene of a motion picture as a picture.



1 Press ▲ to pause motion picture playback.

- You can finely adjust the location for division by pressing ◀▶ while the motion picture is paused.

2 Press [MENU/SET].

- The same operation can be performed by touching [].



- Still pictures will be saved with [Aspect Ratio] set to [16:9] and [Quality] set to []. The number of pixels will differ according to the motion picture you play back.
 - When the motion picture size is set to [4K] in [Rec Quality]: [M] (8 M)
 - When the motion picture size is set to [FHD], [HD] in [Rec Quality]: [S] (2 M)
- Still pictures created from a motion picture may be coarser than with normal picture quality.
- [] is displayed during playback of still pictures created from motion pictures.
- To create still pictures from motion pictures when the camera is connected to a TV with an HDMI micro cable, set [VIERA Link] in [TV Connection] in the [Setup] menu to [OFF].

Switching the Playback Method

Using the Playback Zoom

Rotate the rear dial right.

1× → 2× → 4× → 8× → 16×

- If the rear dial is rotated to the left after the image is enlarged, the magnification will be reduced.
- You can also enlarge/reduce the image by pinching out/pinching in (P48) on the part you want to enlarge/reduce.
- You can move the enlarged part by pressing ▲/▼/◀/▶ or dragging the screen. (P48)
- You can also enlarge (2×) the image by double-touching the part you want to enlarge. If you double-touch the enlarged image, the magnification is reset to 1×.
- You can forward or rewind the image while maintaining the same zoom magnification and zoom position for the Playback Zoom by rotating the front dial during Playback Zoom.



Playing Back Group Pictures

A picture group consists of multiple pictures. You can play back pictures in a group either continuously or one by one.

- You can edit or delete all pictures in a group at once.
(For example, if you delete a picture group, all pictures in the group are deleted.)



A picture group consisting of pictures taken in the Burst Mode with the burst speed [SH]. (P115)
A picture group saved at once with [4K PHOTO Bulk Saving] (P235)



A picture group consisting of pictures taken with Focus Bracket. (P143)



A picture group consisting of pictures taken in a Time Lapse Shot. (P136)



A picture group consisting of pictures taken in the Stop Motion Animation. (P138)

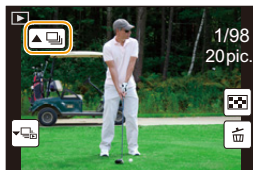

- Pictures will not be grouped if recorded without setting the clock.

Continuously playing back Group Pictures

Press ▲.

- The same operation can be performed by touching the group picture icon ([▲▶], [▲⌚], [▲📷]).
- When playing back group pictures one at a time, options are displayed. After selecting [Burst Play] (or [Sequential Play]), select either of the following playback methods:

[From the first picture]:

Pictures are played back continuously from the first picture of the group.

[From the current picture]:





Pictures are played back continuously from the picture being played back.

Operations during Group Pictures playback

▲	▶/	Continuous playback/Pause	▼	■	Stop
◀	◀◀	Fast rewind	▶	▶▶	Fast forward
	◀◀	Rewind (while pausing)		▶▶	Forward (while pausing)

Playing back group pictures one by one

1 Press ▼.

- The same operation can be performed by touching [], [], [], or [].

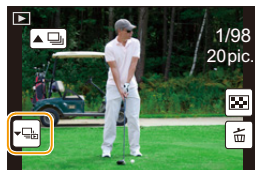

2 Press ◀/▶ to flip through images.

- Pressing ▼ again or touching [] will return you to the normal playback screen.
- Each picture in a group can be treated same as normal pictures when they are played back. (Such as Multi Playback, Playback Zoom and deleting images)



MENU



Deleting Pictures

Once deleted, pictures cannot be recovered.

To delete a single picture

- 1 In Playback Mode, select the picture to delete and then press [].**

- The same operation can be performed by touching [].

- 2 Press \blacktriangle to select [Delete Single] and then press [MENU/SET].**

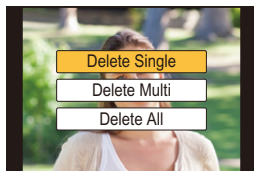
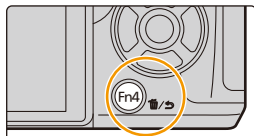

To delete multiple pictures (up to 100*) or all the pictures

- * Picture groups are treated as a single picture.
(All the pictures in the selected picture group will be deleted.)

- 1 In Playback Mode, press [].**
- 2 Press \blacktriangle / \blacktriangledown to select [Delete Multi] or [Delete All] and then press [MENU/SET].**

- It is possible to delete all pictures except the ones set as favorite when [All Delete Except Favorite] is selected with the [Delete All] set.

- 3 (When [Delete Multi] is selected)**

Press \blacktriangle / \blacktriangledown / \blacktriangleleft / \blacktriangleright to select the picture, and then press [MENU/SET] to set. (Repeat this step.)

- [] appears on the selected pictures.
If [MENU/SET] is pressed again, the setting is canceled.

- 4 (When [Delete Multi] is selected)**

Press \blacktriangleleft to select [OK], and then press [MENU/SET] to execute.

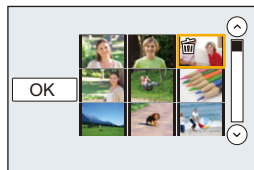

- Depending on the number of pictures to be deleted, it may take some time to delete them.

Menu list

[Rec] P185

[Motion Picture] P206

[Custom] P209

[Setup] P219

[Playback] P227

• [Photo Style], [Filter Settings], [AFS/AFF], [Metering Mode], [Highlight Shadow], [i.Dynamic], [i.Resolution], [Diffraction Compensation], [Digital Zoom] and [Stabilizer] are common to both the [Rec] menu and [Motion Picture] menu. Changing these settings in one of these menus is reflected in other menu.

: [Rec] menu

- [Photo Style] (P186)
- [Filter Settings] (P188)
- [Aspect Ratio] (P189)
- [Picture Size] (P190)
- [Quality] (P191)
- [AFS/AFF] (P92)
- [Metering Mode] (P192)
- [Burst Rate] (P115)
- [4K PHOTO] (P118)
- [Bracket] (P141)
- [Self Timer] (P135)
- [Time Lapse/Animation] (P136, 138)
- [Highlight Shadow] (P193)
- [i.Dynamic] (Intelligent dynamic range control) (P194)
- [i.Resolution] (P194)
- [i.Handheld Night Shot] (P62)
- [i.HDR] (P63)
- [HDR] (P195)
- [Multi Exp.] (P196)
- [Panorama Settings] (P77)
- [Shutter Type] (P197)
- [Shutter Delay] (P198)
- [Flash] (P157)
- [Red-Eye Removal] (P198)
- [ISO Limit Set] (P199)
- [ISO Increments] (P199)
- [Extended ISO] (P199)
- [Long Shtr NR] (P200)
- [Shading Comp.] (P200)
- [Diffraction Compensation] (P201)
- [Ex. Tele Conv.] (P149)
- [Digital Zoom] (P151)
- [Color Space] (P201)
- [Stabilizer] (P144)
- [Face Recog.] (P202)
- [Profile Setup] (P205)











[Photo Style]

Applicable modes:   **P** **A** **S** **M**   

You can select effects to match the type of image you wish to record.

It is possible to adjust the items such as color or picture quality of the effect to your desire.

MENU →  **[Rec]** → **[Photo Style]**

 [Standard]	This is the standard setting.
 [Vivid] ^{*1}	Brilliant effect with high saturation and contrast.
 [Natural] ^{*1}	Soft effect with low contrast.
 [Monochrome]	Monochrome effect with no color shades.
 [L.Monochrome] ^{*1}	Black-and-white effect with rich gradation and crisp black accents
 [Scenery] ^{*1}	An effect appropriate for sceneries with vivid blue skies and greens.
 [Portrait] ^{*1}	An effect appropriate for portraits with a healthy and beautiful skin tone.
 [Custom] ^{*1}	Use the setting registered in advance.
 [Cinelike D] ^{*2}	Gives priority to the dynamic range by using a gamma curve ^{*3} designed to create film-like images. Suited for editing.
 [Cinelike V] ^{*2}	Gives priority to the contrast by using a gamma curve ^{*3} designed to create film-like images.

*1 This is disabled when Intelligent Auto Plus Mode is selected.

*2 These can be set only in Creative Video Mode.

*3 When the actual brightness and the brightness to be captured are adjusted at each brightness level, the relationship between these two kinds of brightness is plotted as a nonlinear curve. This is called the gamma curve.

- In Intelligent Auto Plus Mode, the setting will be reset to [Standard] when the camera is switched to another Recording Mode or this unit is turned on and off.
- Only picture quality adjustment can be set in the Scene Guide Mode.

■ Adjusting the picture quality

- Picture quality cannot be adjusted in the Intelligent Auto Plus Mode.

- 1 Press ◀/▶ to select the type of Photo Style.
- 2 Press ▲/▼ to select the items, and then press ◀/▶ to adjust.

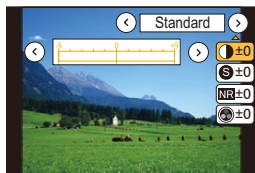

☾ [Contrast]	[+]	Increases the difference between the brightness and the darkness in the picture.
	[-]	Decreases the difference between the brightness and the darkness in the picture.
Ⓢ [Sharpness]	[+]	The picture is sharply defined.
	[-]	The picture is softly focused.
NR [Noise Reduction]	[+]	The noise reduction effect is enhanced. Picture resolution may deteriorate slightly.
	[-]	The noise reduction effect is reduced. You can obtain pictures with higher resolution.
⊗ [Saturation]* ¹	[+]	The colors in the picture become vivid.
	[-]	The colors in the picture become natural.
⊗ [Color Tone]* ¹	[+]	Adds a bluish tone.
	[-]	Adds a yellowish tone.
⊗ [Filter Effect]* ²	[Yellow]	Enhances the contrast of an subject. (Effect: Weak) The blue sky can be recorded clearly.
	[Orange]	Enhances the contrast of an subject. (Effect: Medium) The blue sky can be recorded in darker blue.
	[Red]	Enhances the contrast of an subject. (Effect: Strong) The blue sky can be recorded in much darker blue.
	[Green]	The skin and lips of people appear in natural tones. Green leaves appear brighter and more enhanced.
	[Off]	—

*1 [Color Tone] is displayed only when [Monochrome] or [L.Monochrome] is selected. In other cases, [Saturation] will be displayed.

*2 Displayed only when [Monochrome] or [L.Monochrome] is selected.

- If you adjust the picture quality, [+] is displayed beside the Photo Style icon on the screen.

- 3 Press [MENU/SET].

■ Registering settings to [Custom]

Adjust the picture quality following step 2 of “Adjusting the picture quality”, and then press [DISP].

[Filter Settings]

Applicable modes:   **P** **A** **S** **M**   



You can apply the image effects (filters) of Creative Control Mode in a mode such as Aperture-Priority AE Mode. (P79)

MENU →  **[Rec]** → **[Filter Settings]** → **[Filter Effect]**

Settings: **[ON]/[OFF]/[SET]**

■ Change the settings by using the touch screen

- 1 Touch .
- 2 Touch the item you want to set.

- : Image effect ON/OFF
- : Selects an image effect (filter)
- : Adjusts an image effect

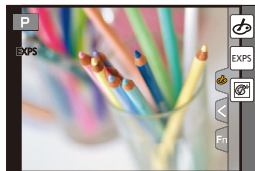

- [Rough Monochrome]/[Silky Monochrome]/[Toy Effect]*/[Toy Pop]*/[Miniature Effect]*/[Soft Focus]/[Star Filter]/[Sunshine] are not available in the following cases.
 - Creative Video Mode
 - When recording motion pictures
 - * When [4K Live Cropping] is set to [ON].
- [Filter Settings] is available in Scene Guide Mode only when [Panorama Shot] is selected. When Scene Guide Mode is set to [Panorama Shot], the following limitations apply:
 - [Toy Effect]/[Toy Pop]/[Miniature Effect]/[Sunshine] are not available.
 - The image effects of [Rough Monochrome]/[Silky Monochrome]/[Soft Focus]/[Star Filter] are not visible on the screen.
 - Using [High Key] may not be effective in dimly-lit conditions.
- The available ISO sensitivity settings will be limited up to [ISO 3200]. The ISO sensitivity for [High Dynamic] will be fixed to [AUTO].
- When using [Filter Effect], you cannot use menus or recording functions not available in Creative Control Mode.

For example, White Balance will be fixed to [AWB] and the flash will be set to  (forced flash off).

■ Taking a picture with and without an image effect simultaneously ([Simultaneous record w/o filter])

You can press the shutter button once and take two pictures simultaneously, one with an image effect and the other one without it.

MENU →  **[Rec]** → **[Filter Settings]** → **[Simultaneous record w/o filter]**

Settings: [ON]/[OFF]

- A picture with an image effect will be taken first, followed by a picture without it.
- Only an image with an image effect is displayed for Auto Review.

Not available in these cases:

- In the following case, [Simultaneous record w/o filter] does not work:
 - Scene Guide Mode
 - Recording still pictures while recording a motion picture (only when set to [] ([Video Priority]))
 - When recording 4K photos
 - When recording with the Post Focus function
 - When recording in Burst Mode
 - When [Quality] is set to [RAW₁], [RAW₂] or [RAW]
 - When recording with the Bracket function
 - When using [Time Lapse Shot]
 - When using [Stop Motion Animation]

[Aspect Ratio]

Applicable modes:   **P** **A** **S** **M**   

This allows you to select the aspect ratio of the pictures to suit printing or the playback method.

MENU →  **[Rec]** → **[Aspect Ratio]**

[4:3]	[Aspect Ratio] of a 4:3 TV
[3:2]	[Aspect Ratio] of a 35 mm film camera
[16:9]	[Aspect Ratio] of a high-definition TV, etc.
[1:1]	Square aspect ratio

Not available in these cases:

- This function is not available in the following cases:
 - [Panorama Shot] (Scene Guide Mode)

[Picture Size]

Applicable modes:   **P** **A** **S** **M**   

Set the number of pixels.

The higher the numbers of pixels, the finer the detail of the pictures will appear even when they are printed onto large sheets.

MENU →  **[Rec]** → **[Picture Size]**

When the aspect ratio is [4:3].

Settings	Image size
[L] (16M)	4592×3448
[EXM] (8M)	3232×2424
[EXS] (4M)	2272×1704

When the aspect ratio is [3:2].

Settings	Image size
[L] (14M)	4592×3064
[EXM] (7M)	3232×2160
[EXS] (3.5M)	2272×1520

When the aspect ratio is [16:9].

Settings	Image size
[L] (12M)	4592×2584
[EXM] (8M)	3840×2160
[EXS] (2M)	1920×1080

When the aspect ratio is [1:1].

Settings	Image size
[L] (11.5M)	3424×3424
[EXM] (6M)	2416×2416
[EXS] (3M)	1712×1712

- When [Ex. Tele Conv.] (P149) is set, **[EX]** is displayed on the picture sizes of each aspect ratio except for **[L]**.
- The picture size is fixed to [4K] ([4:3]: 3328×2496; [3:2]: 3504×2336; [16:9]: 3840×2160; [1:1]: 2880×2880) when recording is performed with the 4K Photo or Post Focus function.

 **Not available in these cases:**

- This function is not available in the following cases:
 - [Panorama Shot] (Scene Guide Mode)

[Quality]

Applicable modes:

Set the compression rate at which the pictures are to be stored.

MENU → **[Rec]** → **[Quality]**

Settings	File format	Description of settings
	JPEG	A JPEG image in which image quality was given priority.
		A standard image quality JPEG image. This is useful for increasing the number of shots without changing the number of pixels.
	RAW+JPEG	You can record a RAW image and a JPEG image (or) simultaneously.
	RAW	You can only record RAW images.

**About RAW**

RAW format refers to a data format of images that have not been processed. Playback and editing of RAW images require the camera or the dedicated software.

- You can process RAW images in [RAW Processing] in the [Playback] menu. (P233)
- Use software ("SILKYPIX Developer Studio" (P296) by Ichikawa Soft Laboratory) to process and edit RAW files on a PC.

- RAW images are always recorded in the [4:3] (4592×3448) aspect ratio.
- When you delete an image recorded with or , both the RAW and JPEG images will be deleted simultaneously.
- When you play back an image recorded with , gray areas corresponding to the aspect ratio at the time of recording are displayed.
- The setting is fixed to when recording is performed with the 4K Photo or Post Focus function.

**Not available in these cases:**





- In the following cases, , , and cannot be set.
 - [Handheld Night Shot]/[Panorama Shot] (Scene Guide Mode)
 - When recording in Burst Mode (only when [Burst Rate] is set to [SH])

[Metering Mode]

Applicable modes:          

Type of optical measurement to measure brightness can be changed.

MENU →  **[Rec]** → **[Metering Mode]**

 (Multiple)	<p>This is the method in which the camera measures the most suitable exposure by judging the allocation of brightness on the whole screen automatically. Usually, we recommend using this method.</p>
 (Center weighted)	<p>This is the method used to focus on the subject on the center of the screen and measure the whole screen evenly.</p>
 (Spot)	<p>This is the method to measure the subject in the spot metering target .</p> <ul style="list-style-type: none"> • If you set the spot metering target on the edge of the screen, the metering may be affected by the brightness around the location.





[Highlight Shadow]

Applicable modes:

You can adjust the brightness of bright and dark portions on an image while checking the brightness on the screen.

MENU → **[Rec]** → **[Highlight Shadow]**

<input checked="" type="checkbox"/> (Standard)	A state with no adjustments is set.
<input checked="" type="checkbox"/> (Raise the contrast)	Bright areas are brightened, and dark areas are darkened.
<input checked="" type="checkbox"/> (Lower the contrast)	Bright areas are darkened, and dark areas are brightened.
<input checked="" type="checkbox"/> (Brighten dark areas)	Dark areas are brightened.
/ / (Custom)	Registered custom settings can be applied.

1 Rotate the front/rear dial to adjust the brightness of bright/dark portions.

(A) Bright portion

(B) Dark portion

- The rear dial is for adjusting dark areas, and the front dial is for adjusting bright areas.
- To register a preferred setting, press , and select the destination where the custom setting will be registered to ([Custom1] ()/[Custom2] ()/[Custom3] ()).
- Adjustments can also be made by dragging the graph.

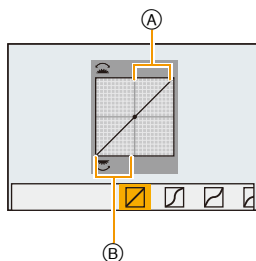

2 Press [MENU/SET].

- The screen display can be switched by pressing [DISP.] on the brightness adjustment screen.

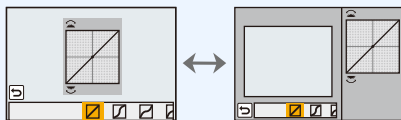

- Turning off this unit will return the setting adjusted with / / / back to the default setting.

[i.Dynamic]

Applicable modes:   **P** **A** **S** **M**   

Contrast and exposure are compensated when the brightness difference between the background and subject is great, etc.

MENU →  **[Rec]** → **[i.Dynamic]**

Settings: **[AUTO]/[HIGH]/[STANDARD]/[LOW]/[OFF]**

 **Not available in these cases:**

- Compensation effect may not be achieved depending on the recording conditions.
- This function is not available in the following cases:
 - [Panorama Shot] (Scene Guide Mode)
 - When [HDR] is set to [ON]

[i.Resolution]

Applicable modes:   **P** **A** **S** **M**   

Pictures with sharp profile and resolution can be taken by using the Intelligent Resolution Technology.

MENU →  **[Rec]** → **[i.Resolution]**

Settings: **[HIGH]/[STANDARD]/[LOW]/[EXTENDED]/[OFF]**

- [EXTENDED] allows you to take natural pictures with a higher resolution.
- The setting will be automatically switched from [EXTENDED] to [LOW] when you record motion picture or perform recording with the 4K Photo or Post Focus function.

[HDR]

Applicable modes:         

You can combine 3 pictures with different levels of exposure into a single picture with rich gradation.

You can minimize the loss of gradations in bright areas and dark areas when, for example, the contrast between the background and the subject is large.

An image combined by HDR is recorded in JPEG.

MENU →  **[Rec]** → **[HDR]**

Settings: **[ON]/[OFF]/[SET]**

■ Changing settings

[Dynamic Range]	<p>[AUTO]: Automatically adjusts the exposure range according to the differences between the bright and dark areas.</p> <p>[±1 EV]/[±2 EV]/[±3 EV]: Adjusts the exposure within the selected exposure parameters.</p>
[Auto Align]	<p>[ON]: Automatically corrects camera shake (jitter) and other problems that can cause the images to misalign. Recommended for use during hand-held shooting.</p> <p>[OFF]: Image misalignment not adjusted. Recommended when a tripod is used.</p>

- Do not move the unit during the continuous shooting after pressing the shutter button.
- You cannot take the next picture until the combination of pictures is complete.
- A moving subject may be recorded with unnatural blurs.
- The angle of view becomes narrow slightly when [Auto Align] is set to [ON].
- Flash is fixed to  (forced flash off).

Not available in these cases:

- [HDR] does not work for the pictures taken during a motion picture recording.
- This function is not available in the following cases:
 - When recording 4K photos
 - When recording with the Post Focus function
 - When recording in Burst Mode
 - When recording with the Bracket function
 - When [Quality] is set to **[RAW₁]**, **[RAW₂]** or **[RAW]**
 - When using [Time Lapse Shot]
 - When using [Stop Motion Animation] (only when [Auto Shooting] is set)

[Multi Exp.]

Applicable modes:   **P** **A** **S** **M**   

Gives an effect like multi exposure. (up to 4 times equivalent per a single image)

MENU →  **[Rec]** → **[Multi Exp.]**

1 Press ▲/▼ to select [Start] and then press [MENU/SET].

2 Decide on the composition, and take the first picture.

- After taking the picture, press the shutter button halfway down to take the next picture.
- Press ▲/▼ to select the item and then press [MENU/SET] for one of the following operations.

- [Next]: Advance to the next picture.
- [Retake]: Return to the first picture.
- [Exit]: Record the image of the first picture, and finish the multiple exposure picture-taking session.

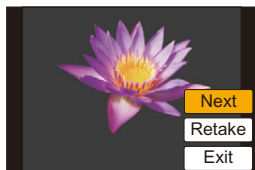

3 Shooting the second, third, and fourth exposures.

- If [Fn4] is pressed while taking pictures, the photographed images are recorded, and the multiple exposure picture-taking session will be completed.

4 Press ▼ to select [Exit] and then press [MENU/SET].

- You can also press the shutter button halfway to finish.

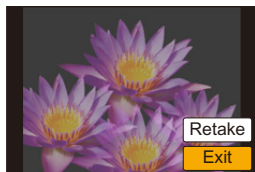

■ Changing settings

[Auto Gain]	If you select [OFF], all exposure results are superimposed as they are. Compensate the exposure as necessary, depending on the subject.
[Overlay]	If you select [ON], you can apply Multi Exposure to previously recorded images. After [Start] is selected, images on the card will be displayed. Select a RAW image, and press [MENU/SET] to proceed to recording.

- The recording information displayed for pictures taken with multiple exposures is the recording information for the last picture taken.
- Items shown in gray on the menu screen cannot be set during multiple exposures.
- [Overlay] is available only for RAW images taken with this unit.

Not available in these cases:

- This function is not available in the following cases:
 - When using [Time Lapse Shot]
 - When using [Stop Motion Animation]

[Shutter Type]

Applicable modes:   **P** **A** **S** **M**   

Select the shutter to be used for taking pictures.

MENU →  **[Rec]** → **[Shutter Type]**

[AUTO]	Switches the shutter type automatically depending on the recording condition and shutter speed.
[MSHTR]	Takes pictures in Mechanical Shutter Mode.
[EFC]	Takes pictures in Electronic Front Curtain Mode.
[ESHTR]	Takes pictures in Electronic Shutter Mode.

	Mechanical shutter	Electronic Front Curtain	Electronic Shutter
Description	The camera starts and ends an exposure with the mechanical shutter.	The camera starts an exposure electronically, and ends it with the mechanical shutter.	The camera starts and ends an exposure electronically.
Flash	○	○	—
Shutter Speed (Sec.)	B (Bulb) ^{*1} /60 to 1/4000th	B (Bulb) ^{*1} /60 to 1/2000th	1 ^{*2} to 1/16000th
Shutter sound	Mechanical shutter sound	Mechanical shutter sound	Electronic shutter sound ^{*3}

*1 This setting is available only in Manual Exposure Mode. (P70)

*2 Up to an ISO sensitivity of [ISO3200]. When the setting is higher than [ISO3200], the shutter speed will be faster than 1 second.

*3 Electronic shutter sound settings can be changed in [E-Shutter Vol] and [E-Shutter Tone]. (P220)

- Compared to Mechanical Shutter Mode, Electronic Front Curtain Mode results in less shutter noise and vibration. Use the latter when you want to suppress subtle noise and vibration.
- Electronic Shutter Mode allows you to take pictures without causing shutter vibration.

- When [] is displayed on the screen, pictures will be taken with the electronic shutter.
- **When a moving subject is recorded with the electronic shutter, the subject may appear distorted on the picture.**
- **When the electronic shutter is used under fluorescent or LED lighting, etc., horizontal stripes may appear on the picture. In such cases, lowering the shutter speed may reduce the effect of the horizontal stripes. (P69)**

[Shutter Delay]

Applicable modes:   **P** **A** **S** **M**   

To reduce the influence of hand shake or shutter vibration, shutter is released after the specified time has passed.

MENU →  **[Rec]** → **[Shutter Delay]**



Settings: **[8SEC]/[4SEC]/[2SEC]/[1SEC]/[OFF]**

 **Not available in these cases:**

- This function is not available in the following cases:
 - [Panorama Shot] (Scene Guide Mode)
 - When recording motion pictures
 - When recording in Burst Mode (only when [Burst Rate] is set to [SH])
 - When recording 4K photos
 - When recording with the Bracket function
 - When [HDR] is set to [ON]

[Red-Eye Removal]

Applicable modes:   **P** **A** **S** **M**   

When Red-Eye Reduction ([], []) is selected, Red-Eye Removal is performed whenever the flash is used. The camera automatically detects red-eye and corrects the picture.

MENU →  **[Rec]** → **[Red-Eye Removal]**

Settings: **[ON]/[OFF]**

- [] is displayed on the icon when it is set to [ON].
- Under certain circumstances, red-eye cannot be corrected.

[ISO Limit Set]

Applicable modes:   **P A S M**   

It will select optimal ISO sensitivity with set value as limit depending on the brightness of the subject.

- It will work when the [Sensitivity] is set to [AUTO] or [iISO].

MENU →  **[Rec]** → **[ISO Limit Set]**

Settings: **[400]/[800]/[1600]/[3200]/[6400]/[12800]/[25600]/[OFF]**

 **Not available in these cases:**

- This function is not available in the following cases:
 - [Clear Nightscape]/[Cool Night Sky]/[Warm Glowing Nightscape]/[Handheld Night Shot] (Scene Guide Mode)
 - When recording motion pictures

[ISO Increments]

Applicable modes:   **P A S M**   

You can adjust the ISO sensitivity settings for every 1/3 EV.

MENU →  **[Rec]** → **[ISO Increments]**

Settings: **[1/3 EV]/[1 EV]**

[Extended ISO]

Applicable modes:   **P A S M**   

ISO sensitivity can be set up to minimum [ISO100].

MENU →  **[Rec]** → **[Extended ISO]**

Settings: **[ON]/[OFF]**

 **Not available in these cases:**

- This function is not available in the following cases:
 - When recording 4K photos
 - When recording with the Post Focus function

[Long Shtr NR]**Applicable modes:**   **P** **A** **S** **M**   

The camera automatically removes noise that appears when the shutter speed becomes slower to take pictures of night scenery etc. so you can take beautiful pictures.

MENU →  **[Rec]** → **[Long Shtr NR]****Settings: [ON]/[OFF]**

- [Long shutter noise reduction ongoing] is displayed for the same time as the shutter speed for signal processing.

 **Not available in these cases:**

- This function is not available in the following cases:
 - [Panorama Shot] (Scene Guide Mode)
 - When recording motion pictures
 - When recording in Burst Mode (only when [Burst Rate] is set to [SH])
 - When recording 4K photos
 - When recording with the Post Focus function
 - When using the electronic shutter

[Shading Comp.]**Applicable modes:**   **P** **A** **S** **M**   

When the screen periphery darkens as a result of the lens characteristics, you can record pictures with the brightness of the screen periphery corrected.

MENU →  **[Rec]** → **[Shading Comp.]****Settings: [ON]/[OFF]**

- Compensation effect may not be achieved depending on the recording conditions.
- Noise in the periphery of the picture may stand out with higher ISO sensitivity.

 **Not available in these cases:**

- Correction is not possible in the following cases:
 - When recording motion pictures
 - Recording still pictures while recording a motion picture (only when set to [] ([Video Priority]))
 - When recording in Burst Mode (only when [Burst Rate] is set to [SH])
 - When recording 4K photos
 - When recording with the Post Focus function

[Diffraction Compensation]

Applicable modes: **P** **A** **S** **M**

The camera raises the resolution by correcting the blurriness caused by diffraction when the aperture is closed.

MENU → **[Rec]** → **[Diffraction Compensation]**

Settings: **[AUTO]/[OFF]**

- Compensation effect may not be achieved depending on the recording conditions.
- Noise may stand out with higher ISO sensitivity.

[Color Space]

Applicable modes: **P** **A** **S** **M**

Set this when you want to correct the color reproduction of the recorded pictures on a PC, printer etc.

MENU → **[Rec]** → **[Color Space]**

[sRGB]	Color space is set to sRGB color space. This is widely used in computer related equipment.
[AdobeRGB]	Color space is set to AdobeRGB color space. AdobeRGB is mainly used for business purposes such as professional printing because it has a greater range of reproducible colors than sRGB.

- Set to [sRGB] if you are not very familiar with AdobeRGB.
- The setting is fixed to [sRGB] in the following cases.
 - When recording motion pictures
 - When recording 4K photos
 - When recording with the Post Focus function

[Face Recog.]

Applicable modes:   **P** **A** **S** **M**  

Face Recognition is a function which finds a face resembling a registered face and priorities focus and exposure automatically. Even if the person is located towards the back or on the end of a line in a group photo, the camera can still take a clear picture.



MENU →  **[Rec]** → **[Face Recog.]**

Settings: **[ON]/[OFF]/[MEMORY]**

- **The following functions will also work with the Face Recognition function.**

In Recording Mode

- Display of corresponding name when camera detects a registered face*

In Playback Mode

- Display of name and age
- Selective playback of pictures chosen from pictures registered with Face Recognition (([Category Play] (P231))

* Names of up to 3 people are displayed.

Precedence for the names displayed when taking pictures is determined according to the order of registration.

- **[Face Recog.] only works when the AF Mode is set to [AF].**

- During the Burst Mode, [Face Recog.] picture information can be attached to only the first picture.
- When group pictures are played back, the name of the first picture of the set is displayed.
- Even when face recognition information has been registered, pictures taken with [Name] set to [OFF] will not be categorized by face recognition in [Category Play].
- If you rename a registered person, images recorded before the renaming operation will no longer be categorized by the Face Recognition function for [Category Play]. You can rename the person in these images in [REPLACE] in [Face Rec Edit] (P247).

 **Not available in these cases:**

- This function is not available in the following cases:
 - [Panorama Shot] (Scene Guide Mode)
 - [Miniature Effect] (Creative Control Mode)
 - When recording motion pictures
 - When recording 4K photos
 - When recording with the Post Focus function
 - When using [Time Lapse Shot]

■ Face Settings

You can register information such as names and birthdays for face images of up to 6 people.

Point of recording when registering the face images

- Face front with eyes open and mouth closed, making sure the outline of the face, the eyes, or the eyebrows are not covered with hair when registering.
- Make sure there is no extreme shading on the face when registering.
(Flash will not flash during registration.)

(Good example for registering)



When face is not recognized during recording

- Register the face of same person indoors and outdoors, or with different expressions or angles. (P204)
- Additionally register at the location of recording.
- When a person who is registered is not recognized, correct by re-registering.
- Face Recognition may not be possible or may not recognize faces correctly even for registered faces, depending on the facial expression and environment.

- 1 Press ▲/▼ to select [MEMORY] and then press [MENU/SET].
- 2 Press ▲/▼/◀/▶ to select the Face Recognition frame that is not registered, and then press [MENU/SET].
- 3 Take the picture adjusting the face with the guide.
 - The faces of subjects other than people (pets, etc.) cannot be registered.
 - To display the description of the face registration, press ▶ or touch [i].

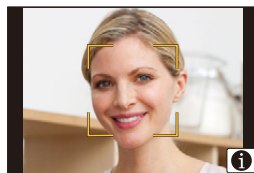
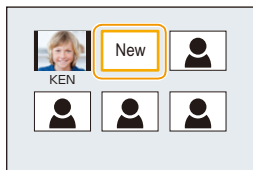

4 Set the item.

- You can register up to 3 face images.

[Name]	It is possible to register names. • For information on how to enter characters, refer to P58 .
[Age]	It is possible to register the birthday.
[Add Images]	<p>(Add Images) To add additional face images.</p> <p>❶ Select the unregistered face recognition frame, and then press [MENU/SET].</p> <p>❷ Perform step 3 in “Face Settings”.</p> <p>(Delete) To delete one of the face images.</p> <p>Press ◀/▶ to select the face image to delete, and then press [MENU/SET].</p>

■ Change or delete the information for a registered person

- Press ▲/▼ to select [MEMORY] and then press [MENU/SET].
- Press ▲/▼/◀/▶ to select the face image to edit or delete and then press [MENU/SET].
- Press ▲/▼ to select the item and then press [MENU/SET].

[Info Edit]	Changing the information of an already registered person. Perform step 4 in “Face Settings”.
[Priority]	The focus and exposure are preferentially adjusted for higher-priority faces. Press ▲/▼/◀/▶ to select the priority and then press [MENU/SET].
[Delete]	Deleting information of a registered person.

[Profile Setup]



Applicable modes:       

If you set the name and birthday of your baby or pet in advance, you can record their name and age in months and years in the images.

You can display these at playback or stamp the recorded images using [Text Stamp] (P239).



MENU →  [Rec] → [Profile Setup]

Settings: [] ([Baby1])/[] ([Baby2])/[] ([Pet])/[OFF]/[SET]

■ Setting [Age] or [Name]

- 1 Press **▲/▼** to select [SET] and then press [MENU/SET].
- 2 Press **▲/▼** to select [Baby1], [Baby2] or [Pet] and then press [MENU/SET].
- 3 Press **▲/▼** to select [Age] or [Name] and then press [MENU/SET].
- 4 Press **▲/▼** to select [SET] and then press [MENU/SET].

Enter [Age] (birthday)
Enter [Name]

• For information on how to enter characters, refer to P58.

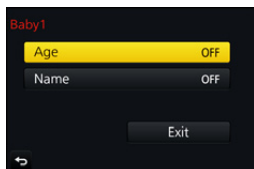

- 5 Press **▼** to select [Exit] and then press [MENU/SET] to finish.

■ To cancel [Age] and [Name]

Select the [OFF] setting in step 1.

• You can print out ages and names with “PHOTOfunSTUDIO” (P295).

Not available in these cases:

- [Profile Setup] is not available when recording is performed with the 4K Photo or Post Focus function.
- Ages and names are not recorded in the following cases:
 - When recording motion pictures
 - Still pictures recorded during motion picture recording ( ([Video Priority])) (P172)

 : **[Motion Picture] menu**

- [Photo Style] (P186)
- [Filter Settings] (P188)
- [4K Live Cropping] (P169)
- [Snap Movie] (P174)
- [Rec Format] (P166)
- [Rec Quality] (P166)
- [Exposure Mode] (P85)
- [AFS/AFF] (P92)
- [Picture Mode] (P172)
- [Continuous AF] (P168)
- [Metering Mode] (P192)
- [Highlight Shadow] (P193)
- [i.Dynamic] (Intelligent dynamic range control) (P194)
- [i.Resolution] (P194)
- [Diffraction Compensation] (P201)
- [Luminance Level] (P206)
- [Ex. Tele Conv.] (P149)
- [Digital Zoom] (P151)
- [Stabilizer] (P144)
- [Flkr Decrease] (P206)
- [Silent Operation] (P86)
- [Mic Level Disp.] (P207)
- [Mic Level Adj.] (P207)
- [Special Mic.] (P307)
- [Mic Level Limiter] (P207)
- [Wind Noise Canceller] (P208)
- [Wind Cut] (P308)
- [Lens Noise Cut] (P208)

[Luminance Level]

Applicable modes:   **P** **A** **S** **M**   

Select the luminance range to match the use of video.

- [Luminance Level] can be set only when [MP4] has been selected as the [Rec Format] setting.

MENU →  **[Motion Picture]** → **[Luminance Level]**

Settings: [0-255]/[16-255]

- [0-255] is suitable for creating still pictures from recorded motion pictures.
- [16-255] is suitable for normal motion picture recording.

[Flkr Decrease]

Applicable modes:   **P** **A** **S** **M**   

The shutter speed can be fixed to reduce the flicker or striping in the motion picture.

MENU →  **[Motion Picture]** → **[Flkr Decrease]**

Settings: [1/50]/[1/60]/[1/100]/[1/120]/[OFF]

[Mic Level Disp.]

Applicable modes:   **P** **A** **S** **M**   

Display the microphone level on the recording screen.

MENU →  **[Motion Picture]** → **[Mic Level Disp.]**

Settings: [ON]/[OFF]

• When [Mic Level Limiter] is set to [OFF], [Mic Level Disp.] is fixed to [ON].

[Mic Level Adj.]

Applicable modes:   **P** **A** **S** **M**   

Adjust the sound input level to 19 different levels (−12 dB ~ +6 dB).

MENU →  **[Motion Picture]** → **[Mic Level Adj.]**

• Displayed dB values are approximate.

[Mic Level Limiter]

Applicable modes:   **P** **A** **S** **M**   

The camera adjusts the sound input level automatically, minimizing the sound distortion (crackling noise) when the volume is too high.

MENU →  **[Motion Picture]** → **[Mic Level Limiter]**

Settings: [ON]/[OFF]

[Wind Noise Canceller]

Applicable modes:   **P** **A** **S** **M**   

This will reduce the wind noise coming into the built-in microphone while maintaining sound quality.

MENU →  **[Motion Picture]** → **[Wind Noise Canceller]**

Settings: [HIGH]/[STANDARD]/[OFF]

- [HIGH] effectively reduces the wind noise by minimizing the low-pitched sound when a strong wind is detected.
- [STANDARD] extracts and reduces only the wind noise without deteriorating the sound quality.
- You may not see the full effect depending on the recording conditions.
- This function works only with the built-in microphone.
When an external microphone is connected, [Wind Cut] is displayed.

[Lens Noise Cut]

Applicable modes:   **P** **A** **S** **M**   

You can reduce the zoom sound of an interchangeable lens compatible with power zoom that is produced during motion picture recording.

MENU →  **[Motion Picture]** → **[Lens Noise Cut]**

Settings: [ON]/[OFF]

- This function works only when an interchangeable lens that supports power zoom is used.
- When this function is used, the sound quality may differ from that during normal operation.

f_c : [Custom] menu

MENU → f_c [Custom]

[Cust.Set Mem.]	Registers the current camera settings as custom set.	P87
[Silent Mode]	<p>Disables operational sounds and output of light at once.</p> <ul style="list-style-type: none"> • Audio from the speaker will be muted and the flash and the AF Assist lamp will be disabled. <p>The following settings are fixed.</p> <ul style="list-style-type: none"> – [Shutter Type]: [ESHTR] – [Flash Mode]: [☹] (forced flash off) – [AF Assist Lamp]: [OFF] – [Beep Volume]: [OFF] (OFF) – [E-Shutter Vol]: [X] (OFF) <hr/> <ul style="list-style-type: none"> • Even when [ON] is set, the following functions light up/flash. <ul style="list-style-type: none"> – Status indicator – Self-timer indicator – Wi-Fi connection lamp • Sounds that are produced by the camera regardless of your operations, such as the lens aperture sound, cannot be muted. • Be sure to pay special attention to the privacy, the likeness rights, etc. of the subject when you use this function. Use at your own risk. 	–
[AF/AE Lock]	Sets the fixed content for focusing and exposure when the AF/AE lock is on.	P105
[AF/AE Lock Hold]	When [ON] is selected, focus and exposure stays locked even if you press and release [AF/AE LOCK]. Press the button again to cancel the lock.	–
[Shutter AF]	Set whether or not the focus is adjusted automatically when the shutter button is pressed halfway.	–
[Half Press Release]	The shutter will immediately fire when the shutter button is pressed halfway.	–















MENU → **f_c** [Custom]

[Quick AF]	<p>As long as the camera is held steady, the camera will automatically adjust the focus and focus adjustment will then be quicker when the shutter is pressed.</p> <hr/> <ul style="list-style-type: none"> • The battery will be consumed faster than usual. • This function is not available in the following cases: <ul style="list-style-type: none"> – In Preview Mode – In low light situations 	–
[Eye Sensor AF]	<p>The camera automatically adjusts the focus when the eye sensor is active.</p> <hr/> <ul style="list-style-type: none"> • [Eye Sensor AF] may not work in dimly lit conditions. 	–
[Pinpoint AF Time]	<p>Sets the time for which the screen is enlarged when the shutter button is pressed halfway with Auto Focus Mode set to [+].</p>	–
[Pinpoint AF Display]	<p>Sets whether to display the assist screen that appears when Auto Focus Mode is set to [+] in a window or full screen.</p>	–
[AF Assist Lamp]	<p>AF assist lamp will illuminate the subject when the shutter button is pressed half-way making it easier for the camera to focus when recording in low light conditions.</p> <hr/> <ul style="list-style-type: none"> • The effective range of the AF Assist Lamp is different depending on the lens used. <ul style="list-style-type: none"> – When the interchangeable lens (H-FS12060) is attached and at Wide: Approx. 1.0 m (3.3 feet) to 3.0 m (9.8 feet) – When the interchangeable lens (H-FS14140) is attached and at Wide: Approx. 1.0 m (3.3 feet) to 3.0 m (9.8 feet) – When the interchangeable lens (H-FS1442A) is attached and at Wide: Approx. 1.0 m (3.3 feet) to 3.0 m (9.8 feet) • Remove the lens hood. 	–

MENU → f_c [Custom]

    [AF Assist Lamp] (continued)	<ul style="list-style-type: none"> • The AF Assist Lamp gets slightly blocked when the interchangeable lens (H-FS12060/H-FS14140/H-FS1442A) is used, but it does not affect the performance. • The AF Assist Lamp may be greatly blocked, and it may become harder to focus when a lens with large diameter is used. • The setting is fixed to [OFF] in the following cases. <ul style="list-style-type: none"> – [Distinct Scenery]/[Bright Blue Sky]/[Romantic Sunset Glow]/[Vivid Sunset Glow]/[Glistening Water]/[Clear Nightscape]/[Cool Night Sky]/[Warm Glowing Nightscape]/[Artistic Nightscape]/[Handheld Night Shot] (Scene Guide Mode) – When [Silent Mode] is set to [ON] 	—
[Direct Focus Area]	<p>Moves the AF area or MF assist using the cursor button when recording.</p> <hr/> <ul style="list-style-type: none"> • When [👤], [📏], [⏏], or [📐] is selected, the AF area can be moved; when [➕] is selected, the enlarged position can be moved. • To set the items that use the cursor buttons like [White Balance] or [Sensitivity], use the Quick Menu (P53) instead. • [Direct Focus Area] is fixed to [OFF] in the following cases: <ul style="list-style-type: none"> – [Glistening Water] (Scene Guide Mode) – Creative Control Mode – When [4K Live Cropping] is set 	—
[Focus/Release Priority]	<p>It will set so no picture can be taken when it is out of focus.</p> <ul style="list-style-type: none"> • Different settings can be applied to different Focus Mode settings ([AFS/AFF], [AFC]). 	—
[AF Sensitivity]	<p>Sets the sensitivity to be applied when adjusting the focus according to the movement of the subject.</p> <ul style="list-style-type: none"> • When the distance to the subject changes drastically: <ul style="list-style-type: none"> – [➕] side: The camera re-adjusts the focus immediately. You can bring different subjects into focus one after another. – [➖] side: The camera waits for a short period of time before re-adjusting the focus. This allows you to prevent the focus from being accidentally re-adjusted when, for example, an object moves across the image. • This item works only when the Focus Mode is set to [AFF] or [AFC]. 	—

MENU → f_c [Custom]

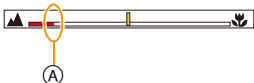
[AF+MF]	When AF Lock is ON (press the shutter button halfway with the focus mode set to [AFS] or set AF Lock using [AF/AE LOCK]), you can make fine adjustments to the focus manually.	—
[MF Assist]	<p>Sets the display method of MF Assist (enlarged screen).</p> <ul style="list-style-type: none"> • Available settings vary depending on the lens used. <hr/> <p>When an interchangeable lens having a focus ring (H-FS12060/H-FS14140/H-FS1442A) is used</p> <p>[]: The screen is enlarged by operating the focus ring or the focus lever of the lens or by pressing .</p> <p>[]FOCUS: The screen is enlarged by operating the focus ring or the focus lever of the lens.</p> <p>[]: The screen is enlarged by pressing .</p> <p>[OFF]: The screen is not be enlarged.</p> <hr/> <p>When an interchangeable lens with no focus ring is used</p> <p>[ON]/[OFF]</p> <ul style="list-style-type: none"> • MF Assist is not displayed in the following cases: <ul style="list-style-type: none"> – When recording motion pictures – When recording with [] ([4K Pre-Burst]) of the 4K Photo function – When using the Digital Zoom 	—
[MF Assist Display]	Sets whether MF Assist (enlarged screen) will appear in a windowed screen display or in a full screen display.	—
[MF Guide]	<p>When you set the focus manually, an MF guide that allows you to check the direction to achieve focus is displayed.</p>  <p>A Indicator for ∞ (infinity)</p>	—

MENU → f_c [Custom]

[Peaking]

In-focus portions (portions on the screen with clear outlines) are highlighted when focus is being adjusted manually.

- When [Detect Level] in [SET] is set to [HIGH], portions to be highlighted are reduced, allowing you to achieve a more precise focus.
- Changing the [Detect Level] setting also changes the [Display Color] setting as follows.

[Detect Level]

[HIGH]



[LOW]

[Display Color]

[] (Light blue)

[] (Blue)

[] (Yellow)

[] (Orange)

[] (Yellow-green)

[] (Green)

[] (Pink)





[] (Red)

[] (White)





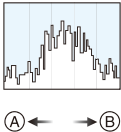

[] (Gray)

- Each time [] in [] is touched, the setting is switched in order of [ON] ([Detect Level]: [LOW]) → [ON] ([Detect Level]: [HIGH]) → [OFF].
- [Peaking] does not work with [Rough Monochrome] in Creative Control Mode.



MENU → fC [Custom]

    <p>[Histogram]</p>	<p>This allows you to set either to display or not display the histogram.</p> <p>You can set the position by pressing ▲/▼/◀/▶.</p> <ul style="list-style-type: none"> • Direct touch operation is also possible from the recording screen. <hr/> <ul style="list-style-type: none"> • A histogram is a graph that displays brightness along the horizontal axis (black to white) and the number of pixels at each brightness level on the vertical axis.  <p>It allows you to easily check a picture's exposure.</p> <p>Ⓐ dark Ⓑ bright</p> <ul style="list-style-type: none"> • When the recorded picture and the histogram do not match each other under the following conditions, the histogram is displayed in orange. <ul style="list-style-type: none"> – During Exposure Compensation – When the flash is activated – When the correct exposure is not achieved, such as when the lighting is low. • The histogram is an approximation in the Recording Mode. 	—
<p>[Guide Line]</p>	<p>This will set the pattern of guide lines displayed when taking a picture.</p> <p>When [] is set, guideline positions can be set by pressing ▲/▼/◀/▶.</p> <ul style="list-style-type: none"> • You can also set the position directly by touching [] on the guideline of the recording screen. <hr/> <ul style="list-style-type: none"> • The guide lines are not displayed in [Panorama Shot] in Scene Guide Mode. 	—
<p>[Center Marker]</p>	<p>The center of the recording screen will be displayed as [+]. This is convenient for operating the zoom while keeping the subject at the center of the screen.</p>	—

MENU → f_c [Custom]

    <p>[Highlight]</p>	<p>When the Auto Review function is activated or when playing back, white saturated areas appear blinking in black and white.</p>  <ul style="list-style-type: none"> • If there are any white saturated areas, we recommend compensating the exposure towards negative (P106) referring to the histogram (P214) and then taking the picture again. It may result in a better quality picture. • This function is disabled during 4K photo playback, playback of images recorded with the Post Focus function, Multi Playback, Calendar Playback, or Playback Zoom. 	—
<p>[Zebra Pattern]</p>	<p>Indicates parts that may become white saturated through overexposure in a zebra pattern.</p>  <p>[ZEBRA1] [ZEBRA2]</p> <p>Select [SET] to set the brightness to be processed as a zebra pattern.</p> <ul style="list-style-type: none"> • You can select a brightness value between [50%] and [105%]. In [Zebra 2], you can select [OFF]. If you select [100%] or [105%], only the areas that are already white saturated are displayed in a zebra pattern. The smaller the value is, the wider the brightness range to be processed as a zebra pattern will be. • If there are any white saturated areas, we recommend compensating the exposure towards negative (P106) referring to the histogram (P214) and then taking the picture. • Displayed zebra patterns will not be recorded. • If you assign [Zebra Pattern] to [Fn Button Set] (P55) in the [Custom] menu, each time you press the function button to which the setting is assigned, the zebra pattern toggles as follows: [Zebra 1] → [Zebra 2] → [OFF]. When [Zebra 2] is set to [OFF], the setting toggles in the order of [Zebra 1] → [OFF], allowing you to switch the setting quickly. 	—

MENU → fC [Custom]

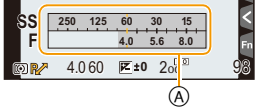
  [Monochrome Live View]	<p>You can display the recording screen in black and white. This function is convenient when a black and white screen will make it easier to set focus with Manual Focus.</p> <hr/> <ul style="list-style-type: none"> • Even if you use the HDMI output during recording, this function will not work for the connected device. • Recorded images will not be affected. 	—
[Constant Preview]	<p>You can check the effects of the chosen aperture and shutter speed on the recording screen in Manual Exposure Mode.</p> <hr/> <ul style="list-style-type: none"> • This function does not work when using the flash. 	—
[Expo.Meter]	<p>Set whether or not to display the exposure meter.</p> <p>(A) Exposure meter</p>  <hr/> <ul style="list-style-type: none"> • Set to [ON] to display the Exposure meter when performing Program Shift, setting aperture, and setting shutter speed. • Unsuitable areas of the range are displayed in red. • When the Exposure meter is not displayed, switch the display information for screen by pressing [DISP.]. • If no operations are performed for approximately 4 seconds, the Exposure meter disappears. 	—
[LVF Disp.Style]	This will set the display style of the viewfinder.	P45
[Monitor Disp. Style]	This will set the display style of the monitor.	P46
[Monitor Info. Disp.]	Display the recording information screen. (P46)	—



MENU → **f_C** [Custom]





[Rec Area]	<p>This changes the angle of view during motion picture recording and still picture recording.</p> <hr/> <ul style="list-style-type: none"> • The recording area indicated is an approximation. • [Rec Area] is not available when recording is performed with the 4K Photo or Post Focus function. 	—
[Remaining Disp.]	<p>This will switch display between the number of recordable pictures and available recording time.</p> <hr/> <ul style="list-style-type: none"> • [9999+] is displayed if there are 10000 or more pictures remaining. 	—
[Auto Review]	<p>Displays a picture immediately after it is taken. If you set [Duration Time] to [HOLD], the picture is displayed until you press the shutter button halfway. If you set [Playback Operation Priority] to [ON], you can perform certain playback operations during Auto Review. For example, you can switch between different types of playback screens or delete pictures.</p> <hr/> <ul style="list-style-type: none"> • When [Duration Time] is set to [HOLD], [Playback Operation Priority] is fixed to [ON]. • When recording is performed with the 4K Photo or Post Focus function, the settings available in [Duration Time] in [Auto Review] change to [ON] and [OFF]. [Playback Operation Priority] is fixed to [ON]. 	—
[Fn Button Set]	You can assign various recording and other functions to the function buttons.	P55
[Lens Position Resume]	Saves the focus position when you turn off the camera. When an interchangeable lens that is compatible with power zoom is in use, the zoom position is also saved.	—
[Q.MENU]	If you select [CUSTOM], you can customize the Quick Menu settings.	P54
[Dial Set.]	Changes the operation methods of the front dial and rear dial.	P43
[Video Button]	Enables/disables the motion picture button.	—
[Power Zoom Lens]	Sets the screen display and lens operations when using an interchangeable lens that is compatible with power zoom (electrically operated zoom).	P152

MENU → **f_C** [Custom]

[Eye Sensor]	Setting the eye sensor sensitivity and the method for switching between the monitor and viewfinder.	P38
[Touch Settings]	<p>Enables/disables the Touch operation.</p> <p>[Touch Screen]: All touch operations.</p> <p>[Touch Tab]: Operations of tabs, such as [◀] on the right side of the screen.</p> <p>[Touch AF]: Operation to bring the subject you touch into focus ([AF]) or adjust the focus and brightness ([AF+AE]).</p> <p>[Touch Pad AF]: Operation to move the AF area by touching the monitor when the viewfinder is in use. (P100)</p>	—
[Touch Scroll]	This allows you to set the speed of continuously forwarding or rewinding pictures using touch operation.	—
[Menu Guide]	Sets whether or not to display a selection screen when you set the mode dial to [SCN]/[📷].	—
[Shoot w/o Lens]	Sets whether or not the shutter can be released when no lens is attached to the main body.	—

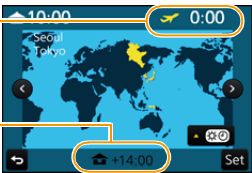
 : [Setup] menu

 →  [Setup]





[Online Manual]	[URL display]/[QR Code display]	—
[Clock Set]	Setting Date/Time.	P34
[World Time]	<p>Sets the times for the region where you live and your holiday destination.</p> <ul style="list-style-type: none"> • [Destination] can be set after setting up [Home]. • After selecting [Destination] or [Home], press ◀▶ to select an area, and press [MENU/SET] to set. <p> [Destination]:</p> <p>Travel destination area</p> <p>(A) Current time of the destination area</p> <p>(B) Time difference from home area</p>  <p> [Home]:</p> <p>Your home area</p> <p>(C) Current time</p> <p>(D) Time difference from GMT (Greenwich Mean Time)</p>  <ul style="list-style-type: none"> • Press ▲ if you are using Daylight Savings []. (The time will move forward by 1 hour.) Press ▲ once more to return to the normal time. • If you cannot find the travel destination in the areas displayed on the screen, set by the time difference from the home area. 	—
[Travel Date]	<p>If you set [Travel Setup], elapsed days of your trip (i.e. which day of the trip) based on its departure and return dates will be recorded.</p> <ul style="list-style-type: none"> • The travel date is automatically canceled if the current date is after the return date. • If the [Travel Setup] is set to [OFF], [Location] will also be set to [OFF]. <p>If you set [Location], the name of the travel destination that you enter will be recorded.</p> <ul style="list-style-type: none"> • For information on how to enter characters, refer to P58. 	—



MENU →  **[Setup]**

[Travel Date] (continued)	<ul style="list-style-type: none"> • You can display the elapsed days and travel destination during playback or stamp them on recorded pictures in [Text Stamp] (P239). • The elapsed days and travel destination can be printed out using the software “PHOTOfunSTUDIO” (P295). • The travel date is calculated using the date in the clock setting and the departure date you set. If you set [World Time] to the travel destination, the travel date is calculated using the date in the clock setting and the travel destination setting. • The [Travel Date] feature is disabled when recording [AVCHD] motion pictures. • [Location] cannot be recorded in the following cases: <ul style="list-style-type: none"> – When recording motion pictures – When recording 4K photos – When recording with the Post Focus function 	—
[Wi-Fi]	[Wi-Fi Function]	P249
	[Wi-Fi Setup]	P286
[Beep]	<p>This allows you to set the electronic sound and the electronic shutter sound.</p> <p>[Beep Volume]/[E-Shutter Vol]/[E-Shutter Tone]</p> <ul style="list-style-type: none"> • When [Silent Mode] is set to [ON], [Beep Volume] and [E-Shutter Vol] are set to [OFF]. 	—
[Live View Mode]	<p>Set the frame rate of the recording screen (Live View screen).</p> <p>[30fps]: Reduces the power consumption, extending the operating time.</p> <p>[60fps]: Displays movements smoother.</p> <ul style="list-style-type: none"> • When [Live View Mode] is set to [30fps] the image quality on the recording screen may be worse than when it is set to [60fps], but this does not affect the recorded image. • The viewfinder is fixed to [60fps]. 	—

MENU →  **[Setup]**

    <p>[Monitor Display]/ [Viewfinder]</p>	<p>Brightness, color, or red or blue tint of the Monitor/ viewfinder is adjusted.</p> <ol style="list-style-type: none"> Select the settings by pressing ▲/▼, and adjust with ◀/▶. <ul style="list-style-type: none"> Adjusting can also be performed by rotating the rear dial. Press [MENU/SET] to set. <hr/> <ul style="list-style-type: none"> It will adjust the monitor when the monitor is in use, and the viewfinder when the viewfinder is in use. Some subjects may appear differently from actuality on the monitor. However, this does not affect the recorded pictures. 	—
<p>[Monitor Luminance]</p>	<p>[A]* [AUTO]: The brightness is adjusted automatically depending on how bright it is around the camera.</p> <p>[1]* [MODE1]: Make the monitor brighter.</p> <p>[2]* [MODE2]: Set the monitor to the standard brightness.</p> <p>[3]* [MODE3]: Make the monitor darker.</p> <hr/> <ul style="list-style-type: none"> Some subjects may appear differently from actuality on the monitor. However, this does not affect the recorded pictures. The monitor automatically returns to standard brightness if no operations are performed for 30 seconds when recording in [MODE1]. It will light up brightly again with button or touch operation. When [AUTO] or [MODE1] is set, the usage time is reduced. [AUTO] is only available in the Recording Mode. The initial setting when using the AC adaptor (optional) is [MODE2]. 	—







MENU →  **[Setup]**

<p>[Economy]</p>	<p>[Sleep Mode]: The camera is automatically turned off if the camera has not been used for the time selected on the setting.</p> <p>[Sleep Mode(Wi-Fi)]: The camera is automatically turned off if it is not connected to a Wi-Fi network and has not been used for 15 minutes (approx.).</p> <p>[Auto LVF/Monitor Off]: The monitor/viewfinder is automatically turned off if the camera has not been used for the time selected on the setting.</p> <p>[Power Save LVF Shooting]: If you enable the automatic viewfinder/monitor switching function (P38) and display the “On-monitor recording information screen” (P46) on the monitor, the camera is automatically turned off when the camera has not been used for the time selected on the setting.</p> <hr/> <ul style="list-style-type: none"> • Press the shutter button halfway or turn the camera off and on to cancel [Sleep Mode], [Sleep Mode(Wi-Fi)] and [Power Save LVF Shooting]. • To turn the monitor/viewfinder on again, press any button or touch the monitor. • [Economy] does not work in the following cases. <ul style="list-style-type: none"> – When connecting to a PC or a printer – When recording or playing back motion pictures – During a slide show – When recording with [] ([4K Pre-Burst]) of the 4K Photo function – When using [Multi Exp.] – When using [Time Lapse Shot] – When using [Stop Motion Animation] (only when [Auto Shooting] is set) – When using the HDMI output during recording • When using the AC adaptor (optional), [Sleep Mode], [Sleep Mode(Wi-Fi)] and [Power Save LVF Shooting] are disabled. • When using the AC adaptor (optional), [Auto LVF/Monitor Off] is fixed to [5MIN.]. 	
<p>[Battery Use Priority]</p>	<p>[BODY]/[BG]</p>	<p>P309</p>





MENU →  **[Setup]**

<p>[USB Mode]</p>	<p>Sets the communication method when connecting using the USB connection cable (supplied).</p> <p> [Select on connection]: Select this setting to select the USB communication system when connecting to another device.</p> <p> [PictBridge(PTP)]: Select this setting when connecting to a printer supporting PictBridge.</p> <p> [PC]: Select this setting to export images to a connected PC.</p>	<p>—</p>
<p>[TV Connection]</p>	<p>[HDMI Mode (Play)]: Set the format for the HDMI output when playing back on the HDMI compatible high-definition TV connected with this unit using the HDMI micro cable.</p> <p>[AUTO]: The output resolution is automatically set based on the information from the connected TV.</p> <p>[4K]: The progressive method with 2160 available scan lines and an output resolution of 3840×2160 are used for output.</p> <p>[1080p]: The progressive method with 1080 available scan lines is used for output.</p> <p>[1080i]: The interlace method with 1080 available scan lines is used for output.</p> <p>[720p]: The progressive method with 720 available scan lines is used for output.</p> <p>[480p]: The progressive method with 480 available scan lines is used for output.</p> <hr/> <ul style="list-style-type: none"> • This will work only during playback. • If no image appears on the TV with [AUTO], switch the setting to a constant setting other than [AUTO] to set a format supported by your TV. (Read the operating instructions for the TV.) 	<p>P290</p>



MENU →  [Setup]

[TV Connection] (continued)	[HDMI Info Display (Rec)]: Sets whether or not to display information when you take pictures while monitoring the camera image on a device (TV, etc.) connected with an HDMI micro cable.	P291
	<ul style="list-style-type: none"> • When the camera is connected to a TV, lower the volume of the TV. 	
	[3D Playback]: Set the output method for 3D pictures. [3D]: Set when connecting to a 3D compatible television. [2D]: Set when connecting to a television not compatible with 3D. Set this when you would like to view pictures in 2D (conventional image) on a 3D compatible television.	P304
	[VIERA Link]: If you select [ON], operations of the camera and the VIERA Link compatible equipment connected to the camera with an HDMI micro cable are automatically linked, enabling you to control the camera with the remote control of the VIERA Link compatible equipment.	P293
[Menu Resume]	Stores the location of the last-used menu item for each menu.	—
[Menu Background]	Set the background color for the menu screen.	—
[Menu Information]	Descriptions of menu items or their settings are displayed on the menu screen.	—
[Language]	Set the language displayed on the screen. <ul style="list-style-type: none"> • If you set a different language by mistake, select [] from the menu icons to set the desired language. 	—
[Version Disp.]	This enables the firmware versions of the camera and lens to be checked. <ul style="list-style-type: none"> • Press [MENU/SET] on the version display screen to display information about the software on the unit. 	—
[Exposure Comp. Reset]	An exposure value can be reset when the Recording Mode is changed or the camera is turned off.	—





MENU →  **[Setup]**

[No.Reset]	<p>Reset the file number of the next recording to 0001.</p> <ul style="list-style-type: none"> • The folder number is updated and the file number starts from 0001. • A folder number between 100 and 999 can be assigned. The folder number should be reset before it reaches 999. We recommend formatting the card (P27) after saving the data on a PC or elsewhere. • To reset the folder number to 100, format the card first and then use this function to reset the file number. A reset screen for the folder number will then appear. Select [Yes] to reset the folder number. 	—
[Reset]	<p>The following settings are reset to the default:</p> <ul style="list-style-type: none"> – Recording settings (except for [Face Recog.] and [Profile Setup]) – Recording settings ([Face Recog.] and [Profile Setup] settings) – Setup/custom settings <p>• When the setup/custom settings are reset, the following settings are also reset.</p> <ul style="list-style-type: none"> – The [World Time] setting – The settings of [Travel Date] (departure date, return date, location) – The settings of [Rotate Disp.], [Picture Sort] and [Delete Confirmation] in the [Playback] menu <p>• The folder number and the clock setting are not changed.</p>	—
[Reset Wi-Fi Settings]	<p>Reset all settings in the [Wi-Fi] menu to factory default settings. (Excluding [LUMIX CLUB])</p> <ul style="list-style-type: none"> • Always reset the camera when disposing or selling it to prevent personal information saved within the camera from being misused. • Always reset the camera after making a copy of personal information when sending the camera in to be repaired. 	—

MENU →  **[Setup]**

[Pixel Refresh]	<p>It will perform optimization of imaging device and image processing.</p> <ul style="list-style-type: none"> • Imaging device and image processing is optimized when the camera is purchased. Use this function when bright spots that do not exist in the subject get recorded. • Turn the camera off and on after the pixels are corrected. 	—
[Sensor Cleaning]	<p>Dust reduction to blow off the debris and dust that have affixed to the front of the imaging device is performed.</p> <ul style="list-style-type: none"> • Dust Reduction Function will operate automatically when the camera is turned on, but you can use this function when you see dust. 	—
[Level Gauge Adjust.]	<p>[Adjust.]: Hold the camera in a horizontal position, and press [MENU/SET]. The level gauge will be adjusted.</p> <p>[Level Gauge Value Reset]: Restores the default level gauge setting.</p>	—
[Demo Mode]	You can try focusing, peaking, etc. for the Post Focus function (P132) by using an example image.	—
[Format]	The card is formatted.	P27

: **[Playback] menu**

- [2D/3D Settings] (P229)
- [Slide Show] (P229)
- [Playback Mode] (P231)
- [Location Logging] (P232)
- [RAW Processing] (P233)
- [4K PHOTO Bulk Saving] (P235)
- [Light Composition] (P236)
- [Clear Retouch] (P237)
- [Title Edit] (P238)
- [Text Stamp] (P239)
- [Video Divide] (P240)
- [Time Lapse Video] (P241)
- [Stop Motion Video] (P241)
- [Resize] (P242)
- [Cropping] (P243)
- [Rotate] (P244)
- [Rotate Disp.] (P244)
- [Favorite] (P245)
- [Print Set] (P246)
- [Protect] (P247)
- [Face Rec Edit] (P247)
- [Picture Sort] (P248)
- [Delete Confirmation] (P248)

- The [Playback] menu items below save edited images as new files. If the card is full, new images cannot be created. We recommend that you check the card capacity in advance.
 - [RAW Processing]/[4K PHOTO Bulk Saving]/[Light Composition]/[Clear Retouch]/[Text Stamp]/[Time Lapse Video]/[Stop Motion Video]/[Resize]/[Cropping]
- The camera may not play back images recorded on other devices correctly, and the functions of the camera may not be available for the images.

■ How to select an image(s) after selecting [Single] or [Multi]

- When [Single] and [Multi] are not available, select an image in the same way as when [Single] is selected.

[Single] setting

- 1 Press **◀/▶** to select the picture.
- 2 Press **[MENU/SET]**.
 - If [Set/Cancel] is displayed at the right bottom of the screen, the setting is canceled when [MENU/SET] is pressed again.



[Multi] setting

When a screen similar to the one on the right is displayed:

- 1 Press **▲/▼/◀/▶** to select the picture and then press **[MENU/SET]** (repeat).
 - The setting is canceled when [MENU/SET] is pressed again.
- 2 Press **◀** to select [OK], and then press **[MENU/SET]** to execute.

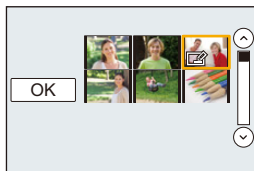

When a screen similar to the one on the right is displayed:

Press **▲/▼/◀/▶** to select the picture, and then press **[MENU/SET]** to set (repeat).

- The setting is canceled when [MENU/SET] is pressed again.



[2D/3D Settings]

Playback methods for the 3D pictures can be switched.

MENU →  **[Playback]** → **[2D/3D Settings]**

- This is a menu that is only displayed when 3D playback is possible. (P304)

[Slide Show]

You can play back the pictures you have taken in synchronization with music, and you can do this in sequence while leaving a fixed interval between each of the pictures.





You can also put together a slide show composed of only still pictures, only motion pictures, etc.





We recommend this feature when you view your pictures by connecting the camera to a TV.

MENU →  **[Playback]** → **[Slide Show]**

- Select the group to play back by pressing ▲/▼, and then press [MENU/SET].**
 - If you select [Video Only], 4K burst files and images recorded with the Post Focus function will also be played back.
 - For images recorded with the Post Focus function, only an in-focus representative image will be chosen and played back.
 - For details on categories, refer to P231.
- Press ▲ to select [Start] and then press [MENU/SET].**

■ Operations during a slide show

Button operation	Touch operation	Description of operation
▲		Play/Pause
◀		Back to previous picture
		Reduce volume level

Button operation	Touch operation	Description of operation
▼		Exit slide show
▶		Ahead to next picture
		Increase volume level

■ Changing the slide show settings

You can change the settings for slide show playback by selecting [Effect] or [Setup] on the slide show menu screen.

[Effect]	<p>This allows you to select the screen effects when switching from one picture to the next.</p> <ul style="list-style-type: none"> • [AUTO] can be used only when [Category Selection] has been selected. The pictures are played back with the recommended effects in each category. 	
[Setup]	[Duration]	<ul style="list-style-type: none"> • [Duration] can be set only when [OFF] has been selected as the [Effect] setting.
	[Repeat]	[ON]/[OFF]
	[Sound]	<p>[AUTO]: Music is played when the still pictures are played back, and audio is played when the motion pictures are played back.</p> <p>[Music]: Music is played back.</p> <p>[Audio]: Audio (only for motion pictures) is played back.</p> <p>[OFF]: There will be no sound.</p>











- Even if you select [Effect], it does not work during slide shows of 4K burst files, images recorded with the Post Focus function, or group pictures.
- When playing back the following pictures, the [Duration] setting is disabled.
 - Motion pictures
 - 4K burst files
 - Images recorded with the Post Focus function
 - Panorama pictures
 - Group Pictures

[Playback Mode]

Playback in [Normal Play], [Picture Only], [Video Only], [4K PHOTO], [Post Focus], [3D Play], [Category Play] or [Favorite Play] can be selected.

MENU →  **[Playback]** → **[Playback Mode]**

- Select the group to play back by pressing ▲/▼, and then press [MENU/SET].**
 - If you select [Video Only], 4K burst files and images recorded with the Post Focus function will also be played back.
- (When [Category Play] is selected)**
Press ▲/▼/◀/▶ to select the category and then press [MENU/SET] to set.
 - Pictures are sorted into the categories shown below.

	– [Face Recog.]
	– [i-Portrait]/[i-Night Portrait]/[i-Baby] (Scene Detection) – [Clear Portrait]/[Silky Skin]/[Backlit Softness]/[Clear in Backlight]/[Relaxing Tone]/[Sweet Child's Face]/[Clear Night Portrait] (Scene Guide Mode)
	– [i-Scenery]/[i-Sunset] (Scene Detection) – [Distinct Scenery]/[Bright Blue Sky]/[Romantic Sunset Glow]/[Vivid Sunset Glow]/[Glistening Water] (Scene Guide Mode)
	– [i-Night Portrait]/[i-Night Scenery]/[i-Handheld Night Shot] (Scene Detection) – [Clear Nightscape]/[Cool Night Sky]/[Warm Glowing Nightscape]/[Artistic Nightscape]/[Glittering Illuminations]/[Handheld Night Shot]/[Clear Night Portrait] (Scene Guide Mode)
	– [Clear Sports Shot] (Scene Guide Mode)
	– [i-Food] (Scene Detection) – [Appetizing Food]/[Cute Dessert] (Scene Guide Mode)
	– [Travel Date]
	– Still pictures recorded continuously with burst speed set to [SH] – Pictures saved at once with [4K PHOTO Bulk Saving]
	– [Time Lapse Shot]/[Time Lapse Video]
	– [Stop Motion Animation]/[Stop Motion Video]

[Location Logging]

You can write location information sent from a smartphone (latitude and longitude) on images.

- You can send location information and write it on images using a smartphone. (P259)
- You need to install “Panasonic Image App” on your smartphone. (P252)
- Read the [Help] in the “Image App” menu for further details on how to operate.

Preparation:

Sending location information to the camera from the smartphone.

MENU →  **[Playback]** → **[Location Logging]**

- 1 Press **▲/▼** to select **[Add Location Data]**, then press **[MENU/SET]**.
- 2 Press **▲/▼** to select the period you intend to record location information on images, then press **[MENU/SET]**.
 - Images with location information are indicated with **[GPS]**.

■ To pause the recording of location information

Press **[MENU/SET]** while recording of the location information onto images is taking place.

- During a suspended period, **[O]** is displayed.
Select the period with **[O]** to restart the recording process from the picture you left off.

■ To delete the received location information

- 1 Press **▲/▼** to select **[Delete Location Data]**, then press **[MENU/SET]**.
- 2 Press **▲/▼** to select the period you want to delete, then press **[MENU/SET]**.

Not available in these cases:

- Location information cannot be written to the following images or in the following situations:
 - Images recorded after location information was sent to the camera (P259)
 - Motion pictures recorded in **[AVCHD]**
 - Images with location information already written to them

[RAW Processing]

You can process the pictures taken in RAW format. The processed pictures will be saved in JPEG format.

[MENU] → **[Playback]** → **[RAW Processing]**

- 1 Select RAW images with ◀/▶, and then press [MENU/SET].**
- 2 Press ▲/▼ to select an item.**
 - You can set the following items. The settings you used for the recording are selected when you start setting these items.



[White Balance]	Allows you to select a White Balance preset and adjust it. If you select an item with [Q] , you can process the image with the setting at the time of recording.
[Exposure Comp.]	Allows you to correct the exposure within the range between -1 EV and +1 EV.
[Photo Style]	Allows you to select a photo style effect ([Standard]/[Vivid]/[Natural]/[Monochrome]/[L.Monochrome]/[Scenery]/[Portrait]).
[i.Dynamic]	Allows you to select an [i.Dynamic] setting ([HIGH]/[STANDARD]/[LOW]/[OFF]).
[Contrast]	Allows you to adjust the contrast.
[Highlight]	Allows you to adjust the brightness of bright portions.
[Shadow]	Allows you to adjust the brightness of dark portions.
[Saturation]/[Color Tone]	Allows you to adjust the saturation. (When [Monochrome] or [L.Monochrome] is selected in [Photo Style], you can adjust the color tone.)
[Filter Effect]	Allows you to select a filter effect. (Only when [Monochrome] or [L.Monochrome] is selected in [Photo Style])
[Noise Reduction]	Allows you to adjust the noise reduction setting.
[i.Resolution]	Allows you to select an [i.Resolution] setting ([HIGH]/[STANDARD]/[LOW]/[EXTENDED]/[OFF]).
[Sharpness]	Allows you to adjust the resolution effect.
[Setup]	<p>You can set the following items:</p> <p>[Reinstate Adjustments]: Returns the settings to the ones you used during the recording.</p> <p>[Color Space]: Allows you to select a [Color Space] setting from [sRGB] or [Adobe RGB].</p> <p>[Picture Size]: Allows you to select the size in which the image will be saved in JPEG format ([L]/[M]/[S]).</p>





3 Press [MENU/SET] and set.

- Refer to “How to set each item” on P234.

4 Press [MENU/SET].

- This operation returns you to the screen in step 2. To set other items, repeat steps 2 through 4.

5 Select [Begin Processing] with ▲/▼, and then press [MENU/SET].**How to set each item**

Button operation	Touch operation	Description of operation
	Dragging	Selects a setting.
	[WB K Set]	Displays the screen that lets you set the color temperature. (P111) (only when [White Balance] is set to [K])
	[Adjust.]	Displays the screen that lets you fine-adjust the White Balance. (P112) (only when [White Balance] is set)
[DISP.]	[DISP.]	Displays the comparison screen.
[MENU/SET]	[Set]	Sets the adjusted level and returns you to the item selection screen.



- When [Noise Reduction], [i.Resolution] or [Sharpness] is selected, the comparison screen cannot be displayed.

- If you touch the picture twice, the picture will be enlarged. If you touch the picture twice when it is enlarged, it will be reduced to the original size.

On the comparison screen, you can use the following operations to make adjustments:

(A) Current setting

Button operation	Touch operation	Description of operation
	Dragging	Selects a setting.
[DISP.]	[DISP.]	Returns you to the setting screen.
[MENU/SET]	[Set]	Sets the adjusted level and returns you to the item selection screen.

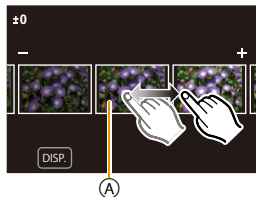

- If you touch the picture at the center, it will be enlarged. If you touch , the picture will be reduced to the original size.



[Setup] setting

When you select an item, the screen that asks you to select [Reinstate Adjustments], [Color Space], or [Picture Size] will be displayed.

- 1 Press ▲/▼ to select an item, and press [MENU/SET].
 - If you select [Reinstate Adjustments], a confirmation screen will be displayed. Selecting [Yes] will execute the operation and return you to the item selection screen.
- 2 Press ▲/▼ to select a setting, and press [MENU/SET].

- The effects applied through the RAW processing on the camera and those applied through the RAW processing on the software “SILKYPIX Developer Studio” (P296) are not completely identical.
- RAW images are always recorded in the [4:3] (4592×3448) aspect ratio regardless of the aspect ratio at the time of recording, but when you perform [RAW Processing] in the [Playback] menu, they are processed in the aspect ratio at the time of recording.
- The [White Balance] setting of pictures taken with multiple exposures is fixed to the setting at the time of recording.

**Not available in these cases:**

- [RAW Processing] is not available when an HDMI micro cable is connected.
- You can process only the RAW images you recorded with the camera.

[4K PHOTO Bulk Saving]

You can save pictures of a 4K burst file that were extracted from any 5 second period at once.

MENU → **[Playback]** → **[4K PHOTO Bulk Saving]**

- 1 Press ◀/▶ to select the 4K photo burst files and press [MENU/SET].
 - If the burst time is 5 seconds or less, all frames will be saved as pictures.
- 2 **Select the first frame of the pictures to be saved at once.**
 - Select the frame in the same way as you select pictures from a 4K burst file. Refer to P125 for details.
 - Pictures will be saved as a groups of Burst Mode pictures in JPEG format. (P182)

[Light Composition]

Select multiple frames from 4K burst files that you wish to combine. Parts of the image that are brighter than the preceding frame will be superimposed on the preceding frame to combine the frames into one picture.

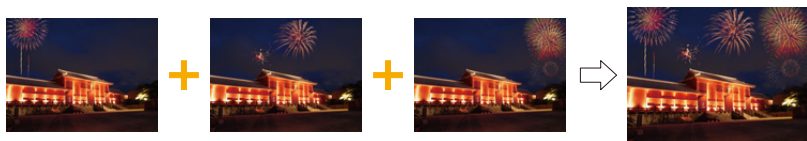

[MENU] → **[Playback]** → **[Light Composition]**

- 1 Press **◀/▶** to select the 4K photo burst files and press **[MENU/SET]**.
- 2 Choose the combining method, and then press **[MENU/SET]**.

[Composite Merging] setting

Select the frames you want to combine to superimpose brighter parts.

- 1 Select the frames.

For information on button and touch operation, refer to [P127](#).

- Images displayed cannot be enlarged or shrunk or shown as in slide view.
- **[◀▶]** in touch operation becomes **[◀▶OK]**.

- 2 Press **[MENU/SET]**.

The selected frames are remembered, and the display goes to the preview screen.

Press **▲/▼** to select items and press **[MENU/SET]** to perform the following operations.

- **[Next]**: Lets you select more frames for combining. Goes back to step 1.
- **[Reselect]**: Discards the frame selected immediately before and lets you select a different image.
- **[Save]**: Ends frame selection

- 3 Repeat steps 1 and 2 to select more frames to combine.
 - You can select up to 40 frames.
- 4 Press **▼** to select **[Save]**, and then press **[MENU/SET]**.

[Range Merging] setting

Select the first and last frames to superimpose the brighter parts of the frames between them.

- 1 Select the frame of the first picture, and press **[MENU/SET]**.
The selection method is the same as in step 1 of **[Composite Merging]** setting.
 - 2 Select the frame of the last picture, and press **[MENU/SET]**.
- 3 **Select [Yes] at the confirmation screen, and then press [MENU/SET].**
The combined picture is displayed.
 - Pictures are saved in JPEG format. Recording information (Exif information) of the first frame such as shutter speed, aperture, and ISO sensitivity are also registered.

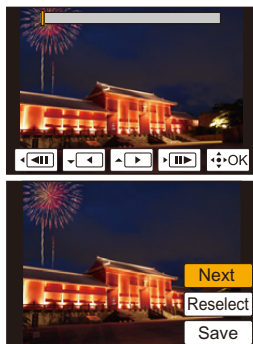

[Clear Retouch]

- The erasure operation can only be performed by touching. [Clear Retouch] automatically enables the touch operation.

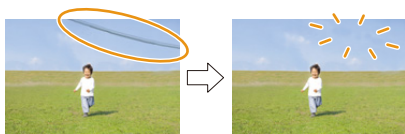

MENU → **[Playback]** → **[Clear Retouch]**

- 1 Press **◀/▶** to select a picture, and then press **[MENU/SET]**.
- 2 Drag your finger over the part you want to delete.
 - The parts to be erased are colored.
 - Touching [Undo] will return the colored part back to its previous state.

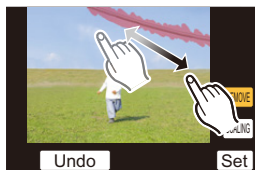

💡 Erasing details (enlarging the display)

- 1 Touch **[SCALING]**.
 - Pinching out/pinching in (**P48**) the screen allows you to enlarge/reduce it.
 - Dragging the screen allows you to move the enlarged part.
- 2 Touch **[REMOVE]**.
 - This will bring you back to the operation of dragging your finger over the part you want to delete. The part you want to delete can be dragged even while the picture is enlarged.



- 3 Touch **[Set]**.
- 4 Touch **[Save]** or press **[MENU/SET]**.

- Pictures may appear unnatural because the background of deleted parts is artificially created.
- For group pictures, perform [Clear Retouch] on each picture. (They cannot be edited at once.)
- When [Clear Retouch] is performed on group pictures, they are saved as new pictures separate from the original ones.

🚫 Not available in these cases:

- Not available when the viewfinder is in use.
- This function is not available in the following cases:
 - Motion pictures
 - 4K burst files
 - Images recorded with the Post Focus function
 - Pictures taken with [Panorama Shot] in Scene Guide Mode
 - Pictures taken with [RAW]

[Title Edit]

You can add text (comments) to pictures. After text has been registered, it can be stamped in prints using [Text Stamp] (P239).

MENU →  **[Playback]** → **[Title Edit]**

1 Select the picture. (P228)

-  is displayed for pictures with titles already registered.

2 Enter the text. (P58)

- To delete the title, erase all the text in the text input screen.
- You can print out texts (comments) using the software “PHOTOfunSTUDIO” (P295).
- You can set up to 100 pictures at one time with [Multi].

 **Not available in these cases:**

- This function is not available in the following cases:
 - Motion pictures
 - 4K burst files
 - Images recorded with the Post Focus function
 - Images recorded with [Quality] set to [RAW⁺], [RAW₊] or [RAW]

[Text Stamp]

You can stamp recording information on recorded images.



MENU → **[Playback]** → **[Text Stamp]**

1 Select the picture. (P228)

- appears on screen if the picture is stamped with text.

2 Press ▲/▼ to select [Set], and then press [MENU/SET].

[Shooting Date]	Stamps the recording date.
[Name]	([Face Recognition]): Name registered in [Face Recog.] will be stamped. ([Baby/Pet]): Name registered in [Profile Setup] will be stamped.
[Location]	Stamps the travel destination name set under [Location].
[Travel Date]	Stamps the travel date set under [Travel Date].
[Title]	Title input in the [Title Edit] will be stamped.

3 Press /⏪ to return to the previous screen.

4 Press ▲ to select [OK], and then press [MENU/SET].

- When you print pictures stamped with text, the date will be printed over the stamped text if you specify printing of the date at the photo shop or on the printer.
- You can set up to 100 pictures at one time in [Multi].
- The picture quality may deteriorate when text stamping is carried out.
- When you stamp pictures in a group, the stamped ones are saved separately from the original ones in the group.

Not available in these cases:

- This function is not available in the following cases:
 - Motion pictures
 - 4K burst files
 - Images recorded with the Post Focus function
 - Pictures taken with [Panorama Shot] in Scene Guide Mode
 - Pictures recorded without setting the clock and title
 - Pictures stamped with [Text Stamp]
 - Pictures taken with [RAW]

[Video Divide]

Recorded motion picture can be divided in two. It is recommended for when you want to divide a part you need with a part you do not need.

Dividing a motion picture is permanent. Decide before you divide!



MENU → **[Playback]** → **[Video Divide]**

- 1 Press to select the motion picture to divide, and then press **[MENU/SET]**.
- 2 Press at the location to divide.
 - You can finely adjust the location for division by pressing while the motion picture is paused.
- 3 Press .
 - Motion picture may be lost if the card or battery is removed while processing the dividing.

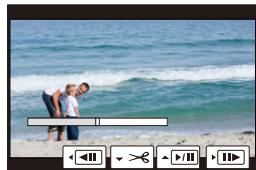

Not available in these cases:

- Avoid trying to divide motion picture near the very beginning or end of the motion picture.
- This function is not available in the following cases:
 - Motion pictures with a short recording time

[Time Lapse Video]

This function allows you to create a motion picture from a picture group recorded with [Time Lapse Shot].

The created motion picture is saved in MP4 recording format.

MENU →  **[Playback]** → **[Time Lapse Video]**

- 1 Select the [Time Lapse Shot] picture group with ◀/▶, and then press [MENU/SET].**
- 2 Create a motion picture by selecting the methods for creating it.**
 - Refer to [P140](#) for details.Also refer to the notes on [P140](#) for created motion pictures.

[Stop Motion Video]

A Motion picture is created from group pictures taken with [Stop Motion Animation].

Created motion pictures are saved in MP4 recording format.

MENU →  **[Playback]** → **[Stop Motion Video]**

- 1 Select the Stop Motion Animation group with ◀/▶, and then press [MENU/SET].**
- 2 Create a motion picture by selecting the methods for creating it.**
 - Refer to [P140](#) for details.Also refer to the notes on [P140](#) for created motion pictures.

[Resize]

To allow easy posting to web pages, attachment to e-mail etc., picture size (number of pixels) is reduced.



MENU → **[Playback]** → **[Resize]**

Select the picture and size.

[Single] setting

- 1 Press / to select the picture, and then press [MENU/SET].
- 2 Press / to select the size, and then press [MENU/SET].

**[Multi] setting**

- 1 Press / to select the size, and then press [MENU/SET].
- 2 Press /// to select the picture, and then press [MENU/SET] to set (repeat).
 - The setting is canceled when [MENU/SET] is pressed again.
- 3 Press to select [OK], and then press [MENU/SET] to execute.

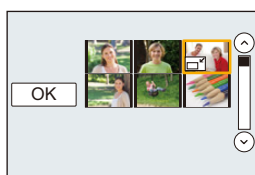

- You can set up to 100 pictures at one time in [Multi].
- The picture quality of the resized picture will deteriorate.

**Not available in these cases:**

- This function is not available in the following cases:
 - Motion pictures
 - 4K burst files
 - Images recorded with the Post Focus function
 - Pictures taken with [Panorama Shot] in Scene Guide Mode
 - Group Pictures
 - Pictures stamped with [Text Stamp]
 - Pictures taken with [RAW]

[Cropping]

You can enlarge and then clip the important part of the recorded picture.



MENU → **[Playback]** → **[Cropping]**

- 1 Press **◀/▶** to select the picture, and then press **[MENU/SET]**.
- 2 Use the rear dial and press **▲/▼/◀/▶** to select the parts to be cropped.

Rear dial (right): Enlargement

Rear dial (left): Reduction

▲/▼/◀/▶: Move

• You can also touch []/[] to enlarge/reduce.

• You can also move by dragging on the screen.

- 3 Press **[MENU/SET]**.

- The picture quality of the cropped picture will deteriorate.
- Crop one picture at a time when you want to crop the pictures in a picture group. (You cannot edit all pictures in a group at once.)
- When you crop pictures in a group, the cropped ones are saved separately from the original ones in the group.
- Information regarding the Face Recognition in the original picture will not be copied to images having undergone [Cropping].

Not available in these cases:



- This function is not available in the following cases:
 - Motion pictures
 - 4K burst files
 - Images recorded with the Post Focus function
 - Pictures taken with [Panorama Shot] in Scene Guide Mode
 - Pictures stamped with [Text Stamp]
 - Pictures taken with [RAW]

[Rotate] (The picture is rotated manually.)

Rotate pictures manually in 90° steps.

- The [Rotate] function is disabled when [Rotate Disp.] is set to [OFF].

MENU →  **[Playback]** → **[Rotate]**

- 1 Press /  to select the picture and then press **[MENU/SET]**.
- 2 Select the rotation direction.

:

The picture rotates clockwise in steps of 90°.

:

The picture rotates counter-clockwise in steps of 90°.

**[Rotate Disp.] (The picture is automatically rotated and displayed.)**

This mode allows you to display pictures vertically if they were recorded holding the camera vertically.

MENU →  **[Playback]** → **[Rotate Disp.]** → **[ON]**

 **Not available in these cases:**

- When you play back pictures on a PC, they cannot be displayed in the rotated direction unless the OS or software is compatible with Exif.

Exif is a file format for still pictures which allows recording information etc. to be added. It was established by "JEITA (Japan Electronics and Information Technology Industries Association)".

[Favorite]

You can do the following if a mark has been added to pictures and they have been set as favorites.

- Play back the pictures set as favorites only as a slide show.
- Play back only the pictures set as favorites. ([Favorite Play])
- Delete all the pictures not set as favorites. ([All Delete Except Favorite])

MENU →  **[Playback]** → **[Favorite]**

Select the picture. (P228)

■ Canceling all the [Favorite] settings

Press ▲/▼ to select [Cancel], and then press [MENU/SET].

- In [Playback Mode], the [Cancel] is disabled.

- You can set up to 999 pictures as favorites.



Not available in these cases:

- This function is not available in the following case:
 - Pictures taken with [RAW]

[Print Set]

DPOF "Digital Print Order Format" is a system that allows the user to select which pictures to print, how many copies of each picture to print and whether or not to print the recording date on the pictures when using a DPOF compatible photo printer or photo printing store. For details, ask at your photo printing store.

- When you set [Print Set] for a group pictures, the print setting for the number of prints will be applied to every picture in the group.

For more information visit:

http://panasonic.jp/dc/dpof_110/white_e.htm

MENU →  **[Playback]** → **[Print Set]**

1 Select the picture. (P228)**2 Press ▲/▼ to set the number of prints, and then press [MENU/SET] to set.**

- When [Multi] has been selected, repeat steps **1** and **2** for each picture.
(It is not possible to use the same setting for a multiple number of pictures.)
- [999+] is displayed on the screen, if the total number of prints you set for a group pictures is more than 1000 pictures.

■ Canceling all the [Print Set] settings

Press ▲/▼ to select [Cancel], and then press [MENU/SET].

■ To print the date

After setting the number of prints, set/cancel printing with the recording date by pressing .

- Depending on the photo printing store or the printer, the date may not be printed even if you set to print the date. For further information, ask at your photo printing store or refer to the operating instructions for the printer.
- The date print feature is disabled for pictures that are stamped with text.

- The number of prints can be set from 0 to 999.

- Depending on the printer, the date print settings of the printer may take precedence so check if this is the case.

**Not available in these cases:**

- This function is not available in the following cases:
 - Motion pictures
 - 4K burst files
 - Images recorded with the Post Focus function
 - Pictures taken with [RAW]

[Protect]

You can set protection for pictures you do not want to delete by mistake.

MENU →  **[Playback]** → **[Protect]**

Select the picture. (P228)

■ Canceling all the [Protect] settings

Press **▲/▼** to select **[Cancel]**, and then press **[MENU/SET]**.



Even if you do not protect pictures on a card, they cannot be deleted when the card's Write-Protect switch is set to **[LOCK]**.

- The **[Protect]** feature is only designed to work with this camera.
- Even if you protect pictures on a card, they will be deleted if the card is formatted.

[Face Rec Edit]

You can clear and replace all information relating to face recognition in selected images.

MENU →  **[Playback]** → **[Face Rec Edit]**

- 1 Press **▲/▼** to select **[REPLACE]** or **[DELETE]**, and then press **[MENU/SET]**.
- 2 Press **◀/▶** to select the picture and then press **[MENU/SET]**.
- 3 Press **◀/▶** to select the person and then press **[MENU/SET]**.
- 4 (When **[REPLACE]** is selected)
Press **▲/▼/◀/▶** to select the person to replace and then press **[MENU/SET]**.

- Cleared information regarding the **[Face Recog.]** cannot be restored.
- When all Face Recognition information in a picture has been canceled, the picture will not be categorized using Face Recognition in **[Category Play]**.
- The Face Recognition information of pictures in a group has to be edited at once. (You cannot edit one picture at a time.)
- Editing of group pictures can be performed only on the first picture of each set.

[Picture Sort]

You can set the order in which the camera displays images during playback.

MENU →  **[Playback]** → **[Picture Sort]**

[FILE NAME]	Displays images by folder name/file name. This display format allows you to locate images in the card easily.
[DATE/TIME]	Displays images by recording date. If the card contains pictures taken with more than one camera, this display format is convenient for looking for images.

- When you insert another card, images may not be displayed by **[DATE/TIME]** first. The images will be displayed by **[DATE/TIME]** if you wait for a while.

[Delete Confirmation]

This sets which option, **[Yes]** or **[No]**, will be highlighted first when the confirmation screen for deleting a picture is displayed.

It is set to **[“No” first]** at the time of purchase.

MENU →  **[Playback]** → **[Delete Confirmation]**

[“Yes” first]	[Yes] is highlighted first, so deletion can be done quickly.
[“No” first]	[No] is highlighted first. Accidental deletion of pictures is avoided.

10. Using the Wi-Fi function

What you can do with the Wi-Fi® function

Controlling with a Smartphone/Tablet (P252)

Recording with a smartphone (P257)

Playing back images in the camera (P258)

Saving images stored in the camera (P258)

Sending images in the camera to an SNS (P259)

Writing location information on images stored in the camera (P259)

Combining motion pictures recorded with Snap Movie according to your preference on a smartphone (P261)



Easy connection

You can easily set up a direct connection to your smartphone without entering a password.



Displaying pictures on a TV (P262)



Printing Wirelessly (P268)



Sending images to AV device (P269)

You can send pictures and motion pictures to AV devices in your house (home AV devices).



Sending images to PC (P270)



Using Web services (P272)

You can send pictures and motion pictures to an SNS, etc. via "LUMIX CLUB".

By using [Cloud Sync. Service], you can receive pictures and motion pictures on a PC or smartphone.

This owner's manual refer to both smartphones and tablets as "smartphones" from this point on unless noted otherwise.

Wi-Fi function

■ Before Use

- Set the date and time settings in advance. (P34)
- To use the Wi-Fi function on this unit, a wireless access point or a destination device equipped with the wireless LAN function is required.

■ About the Wi-Fi connection lamp

Lit blue: When the Wi-Fi function is ON or connected by Wi-Fi

Blinking blue: When sending picture data



■ About the [Wi-Fi] button

In this owner's manual, a function button to which [Wi-Fi] is assigned is referred to as the [Wi-Fi] button.

(By default, [Wi-Fi] is assigned to [Fn6] when the camera is in Recording Mode, while it is assigned to [Fn1] when the camera is in Playback Mode.)

- For information about the function button, refer to P55.

Steps for pressing [Wi-Fi] (in Recording Mode)

1 Touch [Fn6].



2 Touch [Wi-Fi].



When the camera is not connected to Wi-Fi, press [Wi-Fi]. The camera will then be ready to be connected to the smartphone. You can connect the camera directly to the smartphone. (P253)

- When the camera is ready to be connected, you can press [DISP.] to connect with the same settings as used previously. This is a convenient and quick way to establish a connection. (P284)



After connecting to a Wi-Fi network, you can perform the following operations by pressing [Wi-Fi]:

[Terminate the Connection]	Terminates the Wi-Fi connection.
[Change the Destination]* ¹	Terminates the Wi-Fi connection, and allows you to select a different Wi-Fi connection.
[Change Settings for Sending Images]* ²	Refer to P266 for details.
[Register the Current Destination to Favorite]* ¹	Registering the current connection destination or the connection method, you can easily connect with the same connection method next time.
[Network Address]	Displays the MAC address and IP address of this unit.

*1 These items are not displayed when you send the displayed image to a web service by pressing ▼. (P274)

*2 This is not displayed when the destination of [Remote Shooting & View], [Playback on TV] or [Send Images Stored in the Camera] is set to [Printer].

■ Describing method

When “select [Select a destination from History]”, etc. is described in a step, perform any of the following operations.

Button operation: Select [Select a destination from History] with the cursor button, and then press [MENU/SET].

Touch operation: Touch [Select a destination from History].

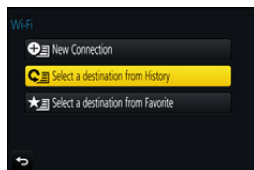

- The camera cannot be used to connect to a public wireless LAN connection.
- Use a IEEE802.11b, IEEE802.11g or IEEE802.11n compatible device when using a wireless access point.
- We strongly recommend that you set an encryption to maintain information security.
- It is recommended to use a fully charged battery when sending images.
- When the battery indicator is flashing red, the connection with other equipment may not start or the connection may be disrupted.
(A message such as [Communication error] is displayed.)
- When sending images on a mobile network, high packet communication fees may be incurred depending on the details of your contract.
- Pictures may not be completely sent depending on radio wave conditions. If the connection is terminated while sending pictures, pictures with missing sections may be sent.
- **Do not remove the memory card or battery or move to an area without any reception while sending images.**

Controlling with a Smartphone/Tablet

With a smartphone, you can record images remotely, play back images on the camera or save them to the smartphone.

- You need to install “Panasonic Image App” (referred to as “Image App” from this point on) on your smartphone.



Installing the smartphone/tablet app “Image App”

The “Image App” is an application provided by Panasonic.

• OS

App for Android™: Android 4.0 or higher

App for iOS: iOS 7.0 or higher

- 1 **Connect the smartphone to a network.**
- 2 **(Android) Select “Google Play™ Store”.**
(iOS) Select “App Store”.
- 3 **Enter “Panasonic Image App” or “LUMIX” into the search box.**
- 4 **Select “Panasonic Image App”**  **and install it.**

- Use the latest version.
- Supported OSs are current as of September 2016 and are subject to change.
- Read the [Help] in the “Image App” menu for further details on how to operate.
- When you operate the “Image App” on the smartphone that is connected to the camera via Wi-Fi, [Help] in the “Image App” may not be displayed depending on the smartphone. In this case, after terminating the connection to the camera, reconnect the smartphone to a mobile phone network such as the 3G or LTE network or to a Wi-Fi router, and then display [Help] in the “Image App”.
- Some of the screens and information provided in this owner’s manual may differ from your device depending on the supported OS and “Image App” version.
- The service may not be able to be used properly depending on the type of smartphone being used.

For information on the “Image App”, refer to the support site below.

<http://panasonic.jp/support/global/cs/dsc/>

(This Site is English only.)

- When downloading the app on a mobile network, high packet communication fees may be incurred depending on the details of your contract.

Connecting to a smartphone/tablet

Connecting without using the password

You can easily set up a direct connection to your smartphone without entering a password.

On the camera

Select the menu. (P51)

MENU → **[Setup]** → **[Wi-Fi]** → **[Wi-Fi Function]** → **[New Connection]** → **[Remote Shooting & View]**

(A) SSID

- When the camera is ready to be connected to the smartphone, the SSID is displayed.
- You can also display the information by pressing [Wi-Fi] on the camera.



On your smartphone

- 1 Turn on the Wi-Fi function in the setting menu.**
- 2 On the Wi-Fi setting screen, select the SSID displayed on the camera.**
- 3 Start "Image App".**
 - When the connection confirmation screen is displayed on the camera, select [Yes] to connect. (For first time connection only)

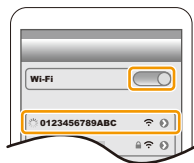

At the time of purchase, [Wi-Fi Password] is set to [OFF].

Before connecting to a Wi-Fi network, ensure that the device displayed on the connection confirmation screen is the one you actually want to connect to. When a wrong device is displayed, if you select [Yes], the camera will automatically connect to that device. We recommend that you set [Wi-Fi Password] to [ON] if, for example, there is another Wi-Fi device nearby. (P254)

Using a password to set up a connection

Connecting with a password further enhances security. You can scan a QR code or manually enter a password to set up a connection.

Preparations:

(On the camera) Set the [Wi-Fi Password] to [ON]. (P286)

■ Using the QR code to set up a connection

On the camera

Select the menu. (P51)

MENU →  [Setup] → [Wi-Fi] → [Wi-Fi Function] → [New Connection] → [Remote Shooting & View]

- (A) SSID and password
- (B) QR code

- When the camera is ready to be connected to the smartphone, the QR code, SSID and password are displayed.
- You can also display the information by pressing [Wi-Fi] on the camera.

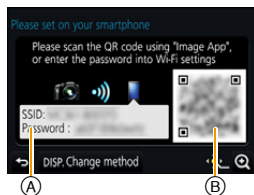

On your smartphone

- 1 Start "Image App".
- 2 Select [QR code].
 - When the smartphone is connected to a wireless access point, it may take time to display [QR code].
 - (For iOS devices) A confirmation screen will be displayed. Select [OK] to proceed.
- 3 Use the "Image App" to scan the QR code displayed on the screen of the camera.
 - If you press [MENU/SET] on the camera, the QR code will be enlarged.

For iOS devices only (iPhone/iPod touch/iPad)

- 4 Install the profile.
 - If a pass code is set on the smartphone, you need to enter it.
- 5 Press the home button to close the browser.
- 6 Turn on the Wi-Fi function in the setting menu.
- 7 On the Wi-Fi setting screen, select the SSID displayed on the camera.
- 8 Start "Image App".

- (iOS devices) Steps 1 through 5 are not required from the second time on.



Manually entering a password to set up a connection

On the camera

Select the menu. (P51)

MENU → [Setup] → [Wi-Fi] → [Wi-Fi Function] → [New Connection] → [Remote Shooting & View]

- (A) SSID and password
- (B) QR code

- When the camera is ready to be connected to the smartphone, the QR code, SSID and password are displayed.
- You can also display the information by pressing [Wi-Fi] on the camera.



On your smartphone

- 1 Turn on the Wi-Fi function in the setting menu.
- 2 On the Wi-Fi setting screen, select the SSID displayed on the camera.
- 3 Enter the password displayed on the camera into the smartphone. (For first time connection only)
 - If you are using an Android device, marking the box for password display will allow the device to display the password as you enter it.
- 4 Start “Image App”.



Changing the connection method

To change the connection method, follow the steps below:

Select the menu. (P51)

MENU → [Setup] → [Wi-Fi] → [Wi-Fi Function] → [New Connection] → [Remote Shooting & View] → [DISP.] button

or

Wi-Fi → [DISP.] button → [New Connection] → [Remote Shooting & View] → [DISP.] button

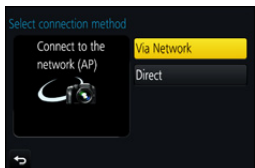

When connecting via a wireless access point ([Via Network]):

On the camera

1 Select [Via Network].

- Follow the connection procedure described on [P281](#) to connect the camera to a wireless access point.

On your smartphone

2 Turn on the Wi-Fi function.

3 Connect the smartphone to the wireless access point to which the camera is connected.

4 Start “Image App”. ([P252](#))

When directly connecting the camera and smartphone ([Direct]):

On the camera

1 Select [Direct].

- Select [Wi-Fi Direct] or [WPS Connection]*, and follow the connection procedure described on [P283](#) to connect the camera to the smartphone.

- * WPS is a function that allows you to easily set up a connection with a wireless LAN device and make security-related settings. To check whether your smartphone supports the function, refer to the operating instructions of the smartphone.

On your smartphone

2 Start “Image App”. ([P252](#))

Terminating the connection

1 Set the camera to Recording Mode.

2 Select the camera’s menu items to terminate the Wi-Fi connection.

MENU → **⌘** [Setup] → [Wi-Fi] → [Wi-Fi Function] → [Yes]

- You can also terminate the connection by pressing [Wi-Fi] on the camera. ([P251](#))

3 On the smartphone, close “Image App”.

(If you are using an iOS device)

On the screen of “Image App”, press the home button to close the app.

(If you are using an Android device)

On the screen of “Image App”, press the return button twice to close the app.

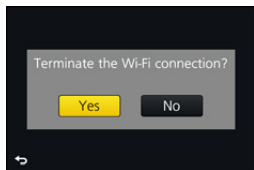



Taking images via a smartphone/tablet (remote recording)

1 Connect to a smartphone. (P253)

2 Operate the smartphone.

- 1 Select [].
- 2 Record an image.
 - The recorded images are saved in the camera.
 - Some settings are not available.

- When recording with 4K Pre-Burst with the smartphone, terminate the connection only after switching to 4K Burst recording by pressing [ / ] on the camera.



Not available in these cases:

- In the following case, remote recording does not work:
 - [Panorama Shot] (Scene Guide Mode)
 - When using [Time Lapse Shot]

■ Taking a picture while jumping

When you hold your smartphone and jump, the camera's shutter can be released automatically as the smartphone detects the peak of the jump. This function is convenient for taking a picture while jumping.

Operate the smartphone.

[] → [] → **Select the sensitivity.**

- [] will be displayed on the remote recording screen of the smartphone.
- We recommend that you take test pictures to determine the camera's angle and how hard you jump and to make any desired adjustments.
- For details, refer to the help section in the "Image App" menu.

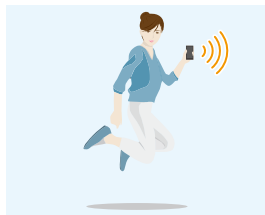

Playing back images in the camera

1 Connect to a smartphone. (P253)

2 Operate the smartphone.

- 1 Select [].
 - You can switch the images to be displayed by selecting the icon (A) on the top left of the screen. To display images stored in the camera, select [LUMIX].
- 2 Touch the image to enlarge it.

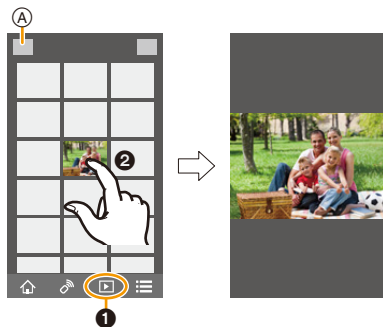

- When you play a motion picture, the camera transmits it to the “Image App” at a reduced data size. As a result, its image quality differs from that of the actual recorded motion picture. In addition, depending on the smartphone or conditions of use, the image quality may deteriorate or the sound may skip during motion picture or picture playback.

Saving images stored in the camera

1 Connect to a smartphone. (P253)

2 Operate the smartphone.

- 1 Select [].
 - You can switch the images to be displayed by selecting the icon (A) on the top left of the screen. To display images stored in the camera, select [LUMIX].
- 2 Touch and hold an image, and drag it to save it.

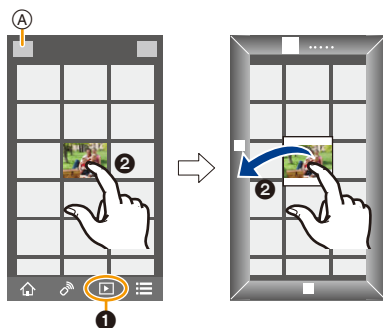

- Pictures in RAW format, AVCHD motion pictures, MP4 motion pictures with a [Rec Quality] size of [4K], 4K burst files, and images recorded with the Post Focus function cannot be saved.
- 3D pictures (MPO format) will be saved as 2D pictures (JPEG format).

Sending images in the camera to an SNS

1 Connect to a smartphone. (P253)

2 Operate the smartphone.

- 1 Select [▶].
 - You can switch the images to be displayed by selecting the icon (A) on the top left of the screen. To display images stored in the camera, select [LUMIX].
- 2 Touch and hold an image, and drag it to send it to an SNS, etc.
 - The image is sent to a web service such as an SNS.

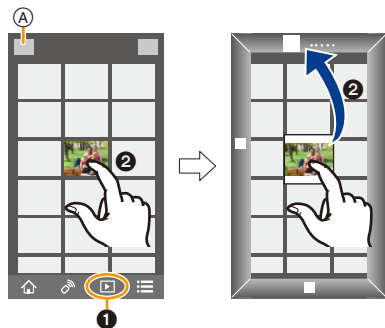

Adding location information to images stored in the camera from a smartphone/tablet

You can send location information acquired with a smartphone to the camera. **After sending the information, you can also write it on images stored in the camera.**

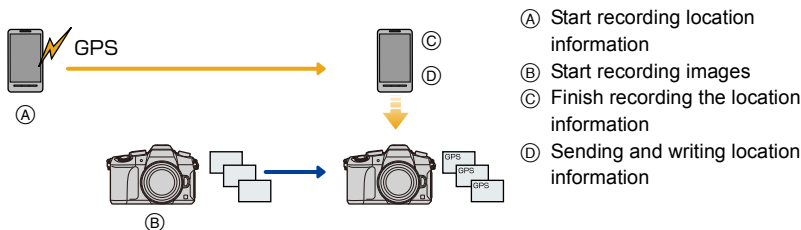

- Once the location information is sent to the camera, you can also write it on images by performing [Location Logging] (P232) in the [Playback] menu.



- Location information different from that at the time of recording may be written. Keep the following points in mind:
 - Set the camera's [Home] setting in [World Time] to your region.
 - Once you start recording location information with your smartphone, do not change the camera's [Home] setting in [World Time].
- Location information cannot be written on images that were recorded when the clock was not set.

■ Recording location information and images

1 Start recording location information with the smartphone.

- ① Start "Image App". (P252)
- ② Select [].
- ③ Select [Geotagging].
- ④ Select [] to start recording location information.



2 Record images with the camera.

3 Stop recording the location information with the smartphone.



- ① Select [] to stop recording the location information.

■ Writing the location information to the images

(Preparation on the camera)

Connect to a smartphone. (P253)

Operate the smartphone.

- ① Start "Image App". (P252)
- ② Select [].
- ③ Select [Geotagging].
- ④ Select [] to send and write the location information.



- Follow the on-screen messages to operate the smartphone.
- Images with location information are indicated with [GPS].

• Cautions for Use:

Be sure to pay special attention to the privacy, the likeness rights, etc. of the subject when you use this function. Use at your own risk.

- The smartphone battery drains faster while location information is being recorded. When recording of location information is not necessary, stop it.
- On the smartphone, you can set the acquisition interval of location information and check the transfer status of location information. Refer to [Help] in the "Image App" menu for details.



Not available in these cases:

- Location information cannot be written to the following images or in the following situations:
 - Images recorded after location information was sent to the camera
 - Motion pictures recorded in [AVCHD]
 - Images with location information already written to them

Combining motion pictures recorded with Snap Movie according to your preference on a smartphone/tablet

Using a smartphone, you can combine motion pictures recorded with the camera's [Snap Movie] function (P174). Music can be added to motion pictures to be combined. In addition, you can save the combined motion picture or upload it on a web service.

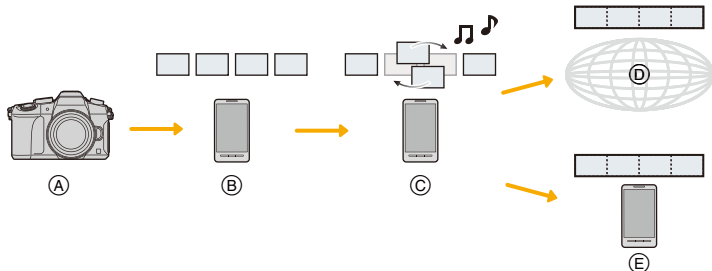

- (A) Record motion pictures with [Snap Movie].
- (B) Send the recorded motion pictures.
- (C) Edit the motion pictures.
- (D) Combine the motion pictures, save the combined motion picture, and send it to a web service.
- (E) Combine the motion pictures, and save the combined motion picture.

■ Combining motion pictures by operating a smartphone

- 1 Connect to a smartphone. (P253)
- 2 Operate the smartphone.

1 Select [].

2 Select [Snap Movie].



- [Snap Movie] motion pictures with recent recording dates will be selected and automatically sent to the smartphone.
- When motion pictures with recent recording dates are not available, a screen that lets you select motion pictures will be displayed. Select motion pictures and send them.

3 Edit the motion pictures.

- Operate the smartphone to edit the motion pictures, such as rearranging them, deleting those that are unnecessary or adding music to them.
- You can combine the edited motion pictures and save the combined file on the smartphone or upload it on a web service.
- Read the [Help] in the "Image App" menu for further details on how to operate.

- [Snap Movie] of the "Image App" requires a smartphone that supports Android OS 4.3 or higher.
- The iPhone 4 does not support [Snap Movie] of the "Image App".

Displaying pictures on a TV

You can display pictures on a TV that supports the Digital Media Renderer (DMR) function of the DLNA standard.



Preparations

Set the TV to DLNA waiting mode.

- Read the operating instructions for your TV.

1 Select the menu. (P51)

MENU → [Setup] → [Wi-Fi] → [Wi-Fi Function] → [New Connection] → [Playback on TV]

2 Select [Via Network] or [Direct], and connect. (P280)

3 Select a device you want to connect.

- When the connection is established, the screen is displayed.

4 Take or play back pictures on this unit.

- To terminate the connection, follow the steps below:

MENU → [Setup] → [Wi-Fi] → [Wi-Fi Function] → [Yes]

(You can also terminate the connection by pressing [Wi-Fi]. (P251))

- If you display pictures using the Wi-Fi function, they cannot be output in 4K resolution. To output them in 4K resolution, connect the camera and the TV with an HDMI micro cable. (P290)
- When a TV is connected to this unit, the TV screen may temporarily return to the status before the connection. Pictures are displayed again when you take or play back pictures.
- [Effect] and [Sound] of the Slide Show are disabled.



Not available in these cases:

- Motion pictures and 4K burst files cannot be played back.
- During Multi Playback, Calendar Playback or when you select the focus area of an image recorded with the Post Focus function, the image displayed on the camera is not displayed on the TV.

Sending images

When sending images, select the method for sending them after selecting [New Connection].

After the connection has been completed, settings for sending, such as the image size for sending, can also be changed.

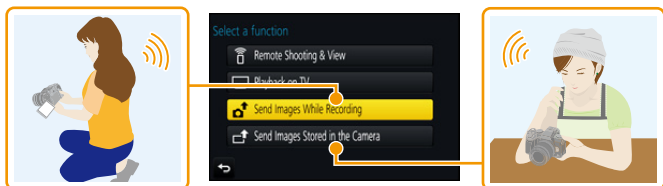

■ Images that can be sent

Destination	JPEG	RAW	MP4 ^{*1}	AVCHD ^{*1, 2}	4K Burst File ^{*1} Images recorded with the Post Focus function ^{*1}	3D
[Smartphone] (P267)	○	—	○ ^{*3}	—	—	—
[PC] (P270)	○	○	○	○	○	○
[Cloud Sync. Service] (P275)	○	—	○ ^{*3}	—	—	○
[Web service] (P272)	○	—	○ ^{*3}	—	—	○
[AV device] (P269)	○	—	—	—	—	○
[Printer] ^{*1} (P268)	○	—	—	—	—	—

*1 Sending by [Send Images While Recording] is not available.

*2 A motion picture recorded in [AVCHD] can be sent to [PC] if the file size is 4 GB or smaller. It cannot be sent if the size is greater than 4 GB.

*3 Excluding motion pictures recorded with their size set to [4K] in [Rec Quality]

• Some images may not be played back or sent depending on the device.

• Refer to the manual of the destination equipment or the web service for more information on how to playback pictures.

Send Images While Recording

A picture can be automatically sent to a specified device every time you take it.

- When connected with [Send Images While Recording], [Wi-Fi] is displayed on the recording screen, and [Send] is displayed while sending a file.
- To terminate the connection, follow the steps below:
MENU → [Setup] → [Wi-Fi] → [Wi-Fi Function] → [Yes]
- You can terminate the connection or change the send settings by pressing [Wi-Fi]. (P251)

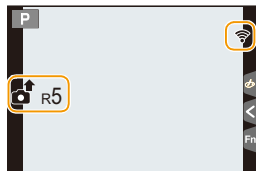

You cannot change the settings while sending pictures. Wait until sending is complete.

- Since the camera gives priority to recording, sending may take longer during the recording.
- If you turn off this unit or the Wi-Fi connection before sending is complete, unsent pictures will not be resent.
- You may not be able to delete files or use the playback menu while sending.



Not available in these cases:

- You cannot send motion pictures, 4K burst files and images recorded with the Post Focus function.

Send Images Stored in the Camera

Images can be selected and sent after recording.

■ How to select an image(s) after selecting [Single Select] or [Multi Select]

[Single Select] setting

- 1 Select the picture.
- 2 Select [Set].



[Multi Select] setting

- 1 Select the picture. (repeat)
 - The setting is canceled when the picture is selected again.
- 2 Select [OK].
 - The number of pictures that can be sent by [Multi Select] is limited.

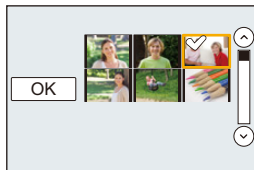

- To change the send settings on a screen that is displayed after the image has been sent, press [DISP.]. To terminate the connection, select [Exit].

- Details of the playback menu [Favorite] or [Print Set] settings will not be sent.

Not available in these cases:

- Some images taken with a different camera may not be able to be sent.
- Images that have been modified or edited with a computer may not be able to be sent.

Changing the settings for sending images

Pressing [DISP.] after completing a connection allows you to change the settings for sending such as the image size for sending.

[Size]	<p>Resize the image to send. [Original]/[Auto]^{*1}/[Change]</p> <ul style="list-style-type: none"> • If you select [Auto], the image size is determined by the circumstances at the destination. • You can select the image size for [Change] from [M], [S] or [VGA]. The aspect ratio does not change.
[File Format]^{*2}	[JPG]/[RAW+JPG]/[RAW]
[Delete Location Data]^{*3}	<p>Select whether to delete the location information from images before sending them.</p> <p>[ON]: Delete the location information, then send. [OFF]: Keep the location information and send.</p> <ul style="list-style-type: none"> • This operation only deletes the location information from the images that are set to be sent. (The location information will not be deleted from the original images stored in this unit.)
[Cloud Limit]^{*4}	<p>You can select whether to send images when the Cloud Folder runs out of free space.</p> <p>[ON]: Do not send images. [OFF]: Delete images from the oldest ones, then send new images.</p>

*1 Only available when the destination is set to [Web service].

*2 Only available when the destination is set to [PC].

*3 Only available when the destination is set to [Cloud Sync. Service] or [Web service].

*4 Only available when the destination is set to [Cloud Sync. Service].

Sending images to a smartphone/tablet

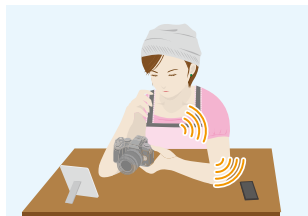

Preparations

- Install the “Image App” in advance. (P252)

1 Select the menu. (P51)

MENU → **⌂** [Setup] → [Wi-Fi] → [Wi-Fi Function] → [New Connection] → [Send Images While Recording] or [Send Images Stored in the Camera] → [Smartphone]

2 Select [Via Network] or [Direct], and connect. (P280)

On your smartphone

When connecting with [Via Network]:

- 1 Turn on the Wi-Fi function.
- 2 Select the wireless access point you want to connect to, and set.
- 3 Start “Image App”. (P252)

When connecting with [Wi-Fi Direct] or [WPS Connection] in [Direct]:

- 1 Start “Image App”. (P252)

When connecting with [Manual Connection] in [Direct]:

- 1 Turn on the Wi-Fi function.
- 2 Select the SSID that matches the one displayed on the screen of this unit.
- 3 Start “Image App”. (P252)

3 Select a device you want to connect.

4 Check the send settings, and select [Set].

- To change the send setting, press [DISP.]. (P266)

5 When [Send Images While Recording] has been selected

Take pictures. (P264)

When [Send Images Stored in the Camera] has been selected

Select the picture. (P265)

Printing Wirelessly

You can send images to a compatible printer, and print them wirelessly.



Preparations

To print out recorded pictures wirelessly, you must use a printer that supports PictBridge (wireless LAN)*.

* Compliant with the DPS over IP standards.

• For details on the PictBridge (wireless LAN-compatible) printer, contact the respective company.

1 Select the menu. (P51)

MENU → [Setup] → [Wi-Fi] → [Wi-Fi Function] → [New Connection] → [Send Images Stored in the Camera] → [Printer]

2 Select [Via Network] or [Direct], and connect. (P280)

3 Select a printer you want to connect.

4 Select pictures, and then print.

- The procedure for selecting pictures is the same as the one for when the USB connection cable is connected. (P301)
- To terminate the connection, press [/].
(You can also terminate the connection by pressing [Wi-Fi]. (P251))

Not available in these cases:

- Motion pictures, 4K burst files, and images recorded with the Post Focus function cannot be printed.

Sending images to AV device

You can send pictures and motion pictures to AV devices in your house (home AV devices).

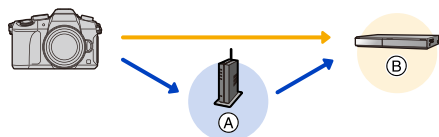

(A) Wireless access point

(B) Home AV device

Preparations

When sending a picture to AV devices, set your device to DLNA waiting mode.

- Read the operating instructions of your device for details.

1 Select the menu. (P51)

MENU → **⌂** [Setup] → [Wi-Fi] → [Wi-Fi Function] → [New Connection] → [Send Images While Recording] or [Send Images Stored in the Camera] → [AV device]

2 Select [Via Network] or [Direct], and connect. (P280)

3 Select a device you want to connect.

4 Check the send settings, and select [Set].

- To change the send setting, press [DISP]. (P266)

5 When [Send Images While Recording] has been selected

Take pictures. (P264)

When [Send Images Stored in the Camera] has been selected

Select the picture. (P265)

- Sending may fail depending on the operational status of the AV device. Also, sending may take a while.

Sending images to PC

You can send pictures and motion pictures recorded with this unit to a PC.



Preparations

(On the camera)

- If the workgroup of the destination PC has been changed from the standard setting, you also need to change the setting of this unit in [PC Connection]. (P286)

(On your PC)

- Turn the computer on.
- Prepare folders for receiving images on the PC before sending a picture to the PC. (P270)

To create a folder that receives images

- Create a PC user account [account name (up to 254 characters) and password (up to 32 characters)] consisting of alphanumeric characters. An attempt to create a receive folder may fail if the account includes non-alphanumeric characters.

■ When using “PHOTOfunSTUDIO”

- 1 Install “PHOTOfunSTUDIO” to the PC. (P295)
- 2 Create a folder that receives images with “PHOTOfunSTUDIO”.
 - To create the folder automatically, select [Auto-create]. To specify a folder, create a new folder, or set a password to the folder, select [Create manually].
 - For details, refer to the operating instructions of “PHOTOfunSTUDIO” (PDF).

■ When not using “PHOTOfunSTUDIO”

(For Windows)

Supported OS: Windows 7/Windows 8/Windows 8.1/Windows 10

Example: Windows 7

- 1 Select a folder you intend to use for receiving, then right-click.
- 2 Select [Properties], then enable sharing of the folder.
 - For details, refer to the operating instructions of your PC or Help on the OS.



(For Mac)

Supported OS: OS X v10.5 to v10.11

Example: OS X v10.8

- 1 **Select a folder you intend to use for receiving, then click on the items in the following order.**
[File] → [Get Info]
- 2 **Enable sharing of the folder.**
 - For details, refer to the operating instructions of your PC or Help on the OS.

Sending images to the PC

- 1 **Select the menu. (P51)**

MENU → ⌘ [Setup] → [Wi-Fi] → [Wi-Fi Function] → [New Connection] → [Send Images While Recording] or [Send Images Stored in the Camera] → [PC]

- 2 **Select [Via Network] or [Direct], and connect. (P280)**
- 3 **Select the PC you want to connect to.**
 - When the PC you want to connect to is not displayed, select [Manual Input], and enter the computer name of the PC (NetBIOS name for Apple Mac computers).
- 4 **Select the folder you want to send.**
- 5 **Check the send settings, and select [Set].**
 - To change the send setting, press [DISP.]. (P266)

- 6 **When [Send Images While Recording] has been selected**

Take pictures. (P264)

When [Send Images Stored in the Camera] has been selected

Select the picture. (P265)

- Folders sorted by the sent date are created in the specified folder, and pictures are saved in those folders.
- If the screen for a user account and password entry appears, enter the one you set on your PC.
- When the computer name (NetBIOS name for Apple Mac computers) contains a space (blank character), etc., it may not be recognized correctly.
If a connection attempt fails, we recommend that you change the computer name (or NetBIOS name) to the one consisting of only alphanumeric characters, with a maximum of 15 characters.
- When the firewall of the OS, security software, etc. is enabled, connecting to the PC may not be possible.

Using Web services

You can send pictures and motion pictures to an SNS, etc. via “LUMIX CLUB”. By setting up automatic transfers of pictures and motion pictures to the Cloud Sync Service, you can receive the transferred pictures or motion pictures on a PC or smartphone.

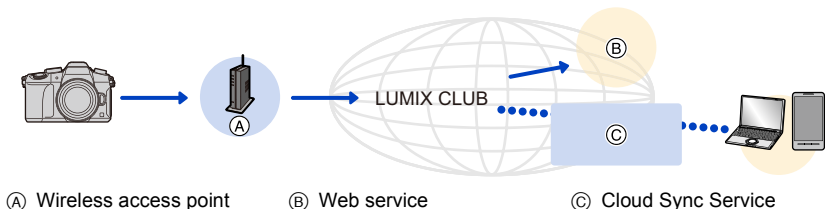

Preparations

To send images to a web service or a cloud folder, you need to register to “LUMIX CLUB” (P276).

To send images to a web service, you need to register the web service. (P273)

When sending images to web service

P272

When sending images to [Cloud Sync. Service]

P275

When sending images to web service

- Images uploaded to the web service cannot be displayed or deleted with this camera. Check images by accessing the web service with your smartphone or computer.
- If sending images fails, a report email outlining the failure will be sent to the email address registered with “LUMIX CLUB”.
- **Images may contain personal information that can be used to identify the user, such as a title, the time and date when the images was taken, and the location where the image was taken. Check this information before uploading images to web services.**

- Panasonic assumes no responsibility for the damages resulting from the leakage, loss, etc. of images uploaded on web services.
- When uploading images to the web service, do not delete images from this camera, even after they have finished sending, until you have checked that they have been properly uploaded to the web service. Panasonic assumes no responsibility for the damages resulting from the deletion of images stored in this unit.

Registering web services

When sending images to web services, the web service being used must be registered with the "LUMIX CLUB". (P276)

- Check the "FAQ/Contact us" on the following site for compatible web services.
http://lumixclub.panasonic.net/eng/c/lumix_faqs/

Preparation:

Make sure that you have created an account on the web service you want to use, and have the login information available.

- 1 **Connect to the "LUMIX CLUB" site using a smartphone or computer.**
<http://lumixclub.panasonic.net/eng/c/>
- 2 **Enter your "LUMIX CLUB" login ID and password and log in to the service.**
(P276)
- 3 **Register your email address.**
- 4 **Select the web service to be used and register it.**
 - Follow the instructions on the screen to register the service.

Sending images

- 1 **Select the menu.** (P51)

MENU → ⌂ [Setup] → [Wi-Fi] → [Wi-Fi Function] → [New Connection] → [Send Images While Recording] or [Send Images Stored in the Camera] → [Web service]

- 2 **Select [Via Network], and connect.** (P280)
- 3 **Select a web service.**
- 4 **Check the send settings, and select [Set].**
 - To change the send setting, press [DISP]. (P266)
- 5 **When [Send Images While Recording] has been selected**

Take pictures. (P264)

When [Send Images Stored in the Camera] has been selected

Select the picture. (P265)

■ Sending images in the camera to a web service with simple operations

Once you send an image, you can send other images to a web service with simple, smartphone-like operations in an environment where a wireless access point connection is available.





(The instructions below assume that you are already registered to “LUMIX CLUB” and the camera has a record of a connection to a wireless access point.)

1 Display an image.

2 Press ▼.

(When group pictures are selected, press ▲, and select [Upload(Wi-Fi)] or [Upload All(Wi-Fi)].)

- The same operation can be performed by touching [].

(When group pictures are selected, select [Upload(Wi-Fi)] or [Upload All(Wi-Fi)] after touch [], [], [], or [], and then touch [].)



3 Select [Yes] on the confirmation screen.

4 Select a web service.

5 Check the send settings, and select [Set].

- The camera will connect to a previously connected wireless access point and sends the image to a web service.
- To change the send setting, press [DISP]. (P266)
- Step 4, 5 are not necessary when you continue to send another image. The image will be sent to the same web service with the same send settings.
- To terminate the connection, press [MENU/SET] or operate other controls to exit the playback screen. You can also terminate the connection by pressing [Wi-Fi]. (P251)

To change the settings for sending images or web service

Terminate the Wi-Fi connection, and follow step 1 and onwards again.

- You can also change the send settings by pressing [Wi-Fi] while using a Wi-Fi connection. (P251)

- If the camera has no records of connections to wireless access points that are available, a screen that asks you to select a connection method is displayed. Select a connection method, and connect the camera to a wireless access point. (P281)
- When you are not registered to “LUMIX CLUB”, a screen that asks you to acquire a new login ID is displayed. Acquire a login ID and set a password. (P276)
- When group pictures are displayed continuously, all pictures in the group will be sent. When group pictures are displayed one by one, the currently displayed picture will be sent.

When sending images to [Cloud Sync. Service]

■ Using [Cloud Sync. Service] (As of September 2016)

Preparations

You need to register to “LUMIX CLUB” (P276) and configure the Cloud Sync. setting to send a picture to a Cloud Folder.

For a PC, use “PHOTOfunSTUDIO” (P295) to set up Cloud Sync settings. For a smartphone, use “Image App” to set them up.

- If you set the picture destination to [Cloud Sync. Service], sent pictures are temporarily saved in the cloud folder, and they can be synchronized with the device in use, such as the PC or smartphone.
- A Cloud Folder stores transferred images for 30 days (up to 1000 pictures). Transferred images are deleted automatically 30 days after the transfer. Furthermore, when the number of stored images exceeds 1000, some images may be deleted depending on the [Cloud Limit] (P266) setting even within 30 days after the transfer.
- When the download of images from a Cloud Folder to all specified devices is complete, images may be deleted from the Cloud Folder even within 30 days after the transfer.

1 Select the menu. (P51)

MENU → ⚙ [Setup] → [Wi-Fi] → [Wi-Fi Function] → [New Connection] → [Send Images While Recording] or [Send Images Stored in the Camera] → [Cloud Sync. Service]

2 Select [Via Network], and connect. (P280)

3 Check the send settings, and select [Set].

- To change the send setting, press [DISP.]. (P266)

4 When [Send Images While Recording] has been selected

Take pictures. (P264)

When [Send Images Stored in the Camera] has been selected

Select the picture. (P265)

Registering to the “LUMIX CLUB”

If you register this unit to the “LUMIX CLUB”, you can synchronize images between the devices you are using, or transfer these images to web services.
Use the “LUMIX CLUB” when uploading pictures to web services.

About the [LUMIX CLUB]

Acquire a “LUMIX CLUB” login ID (free).

- You can set the same “LUMIX CLUB” login ID for this unit and a smartphone. (P278)

Refer to the “LUMIX CLUB” site for details.

<http://lumixclub.panasonic.net/eng/c/>

Please note:

- The service may be suspended due to regular maintenance or unexpected troubles, and the service contents may be changed or added, without prior notice to the users.
- The service may be stopped in whole or in part with a reasonable period of advance notice.

Acquiring a new login ID ([New account])

1 Select the menu. (P51)

MENU →  [Setup] → [Wi-Fi] → [Wi-Fi Setup] → [LUMIX CLUB] → [Set/Add Account] → [New account]

- Connect to the network.

Proceed to the next page by selecting [Next].

- A confirmation screen will be displayed if a login ID has already been acquired for the camera. Select [Yes] to acquire a new login ID, or [No] if you do not need to acquire a new login ID.

2 Select the method for connecting to a wireless access point, and set. (P281)

- A setting screen will be displayed only when connecting for the first time.

Once you set the connection method, it will be saved on this unit and used when connecting the next time. To change the wireless access point you want to connect to, press [DISP.], and change the connection destination.

- Proceed to the next page by selecting [Next].

3 Read through the “LUMIX CLUB” terms of use and select [Agree].

- You can switch pages by ▲/▼.
- You can enlarge (2×) the display by rotating the rear dial to the right.
- You can reset the enlarged display to its original size (1×) by rotating the rear dial to the left.
- You can move the position of the enlarged display with ▲/▼/◀/▶.
- Press  to cancel the process without acquiring a login ID.



4 Enter a password.

- Enter any combination of 8 to 16 characters and numbers for the password.
- For information on how to enter characters, refer to [P58](#).

5 Check the login ID and select [OK].

- **Be sure to make a note of the login ID and password.**
- The login ID (12-digit number) will be displayed automatically.
When logging in to the “LUMIX CLUB” with a computer, you only need to enter the numbers.
- A message is displayed when the connection is complete. Select [OK].

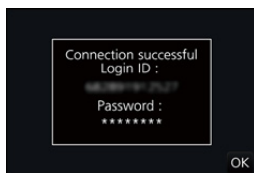

Using the acquired login ID/Checking or changing the login ID or password ([Set Login ID])

Preparation:

When using the acquired login ID, check the ID and password.

To change the “LUMIX CLUB” password on the camera, access the “LUMIX CLUB” website from your smartphone or PC and change the “LUMIX CLUB” password in advance.

- The login ID and password registered to the “LUMIX CLUB” cannot be changed on this unit.

1 Select the menu. (P51)

MENU → **[Setup]** → **[Wi-Fi]** → **[Wi-Fi Setup]** → **[LUMIX CLUB]** → **[Set/Add Account]** → **[Set Login ID]**

- The login ID and password are displayed.
- The password is displayed as “*”.
- Close the menu if only checking the login ID.

2 Select the item to change.**3 Enter the login ID or password.**

- For information on how to enter characters, refer to [P58](#).
- Enter the new password you have created on your smartphone or PC into the camera. If the password differs from the one you created on your smartphone or PC, you will not be able to upload images.

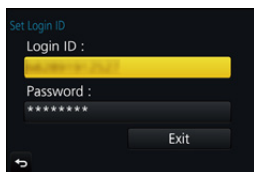

To set the same login ID for the camera and the smartphone/tablet

Setting the same login ID on this unit and your smartphone is convenient for sending images on this unit to other devices or web services.

When either this unit or the smartphone/tablet has acquired the login ID:

- 1 **Connect this unit to the smartphone. (P253)**
 - 2 **From the “Image App” menu, set the common login ID.**
 - The login IDs for this unit and the smartphone become the same.
- After connecting this unit to the smartphone, the setup screen for a common login ID may appear when you display the playback screen. You can also set a common login ID by following the on-screen instructions.
 - This operation is not available for [Wi-Fi Direct] connection.

When this unit and the smartphone/tablet have acquired different login IDs:

(When you want to use the smartphone’s login ID for this unit)

Change the login ID and password for this unit to those acquired by the smartphone.

(When you want to use this unit’s login ID for the smartphone)

Change the login ID and password for the smartphone to those acquired by this unit.

Check the “LUMIX CLUB” terms of use

Check the details if the terms of use have been updated.

Select the menu. (P51)

MENU →  **[Setup]** → **[Wi-Fi]** → **[Wi-Fi Setup]** → **[LUMIX CLUB]** → **[Terms of use]**

- The camera will connect to the network and the terms of use will be displayed. Close the menu after checking the terms of use.

Delete your login ID and account from the “LUMIX CLUB”

Delete the login ID from the camera when transferring it to another party or disposing of it. You can also delete your “LUMIX CLUB” account.

1 Select the menu. (P51)

MENU →  **[Setup]** → **[Wi-Fi]** → **[Wi-Fi Setup]** → **[LUMIX CLUB]** → **[Delete account]**

- The message is displayed. Select [Next].

2 Select [Yes] in the login ID delete confirmation screen.

- The message is displayed. Select [Next].

3 Select [Yes] on the confirmation screen for deleting the “LUMIX CLUB” account.

- If you want to continue using the service, selecting [No] will only delete the login ID. Exit the menu after it is executed.

4 Select [Next].

- The login ID is deleted, and then the message notifying the deletion of your account is displayed. Select [OK].

- Changes and other actions to login IDs can only be made to the login ID acquired with the camera.

About Connections

If you have selected [New Connection], select a Wi-Fi function and destination first, and then select a connection method.

If you have selected [Select a destination from History] or [Select a destination from Favorite], you can connect with the same Wi-Fi connection settings as used previously.

This section describes connection methods.

- When connecting with the same settings as used previously, refer to [P284](#).

When a screen similar to the one below is displayed, select a connection method.

• Example of operation for displaying a screen:

MENU →  **[Setup]** → **[Wi-Fi]** → **[Wi-Fi Function]** → **[New Connection]** → **[Send Images While Recording]** → **[Smartphone]**

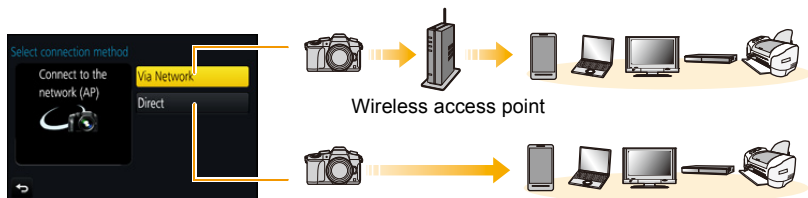

[Via Network]	Connects via a wireless access point.	P281
[Direct]	Your device connects directly to this unit.	P283

Performing a direct connection is convenient for when you are in a place away from home where wireless access points are not available or for when connecting temporarily to a device you do not usually use.

Connecting via a wireless access point (via the network)

You can select the method for connecting to a wireless access point.

* WPS refers to a function that allows you to easily configure the settings related to the connection and security of wireless LAN devices.

To check if the wireless access point you are using is compatible with WPS, refer to the manual of the wireless access point.

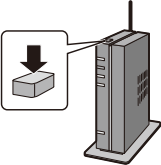

<p>[WPS (Push-Button)]</p>	<p>Save push button type wireless access point that is compatible with Wi-Fi Protected Setup™ with a WPS mark.</p> <p>Press the wireless access point WPS button until it switches to WPS mode. e.g.:</p> <ul style="list-style-type: none"> • Refer to the wireless access point instruction manual for details. 
<p>[WPS (PIN code)]</p>	<p>Save PIN code type wireless access point that is compatible with Wi-Fi Protected Setup with a WPS mark.</p> <ol style="list-style-type: none"> 1 On the camera screen, select the wireless access point you are connecting to. 2 Enter the PIN code displayed on the camera screen into the wireless access point. 3 Press [MENU/SET] of the camera. <ul style="list-style-type: none"> • Refer to the wireless access point instruction manual for details.
<p>[From List]</p>	<p>Select this option when you are not sure about the WPS compatibility, or when you want to search for and connect to a wireless access point. (P282)</p>

If you are not sure about the WPS compatibility (connecting by [From List])

Search for available wireless access points.

- Confirm encryption key of the selected wireless access point if the network authentication is encrypted.
- When connecting by [Manual Input], confirm SSID, encryption type, encryption key of the wireless access point you are using.

1 Select the wireless access point you are connecting to.

- Pressing [DISP.] will search for a wireless access point again.
- If no wireless access point is found, refer to “When connecting with [Manual Input]” on P282.

2 (If network authentication is encrypted)

Enter the encryption key.

- For information on how to enter characters, refer to P58.

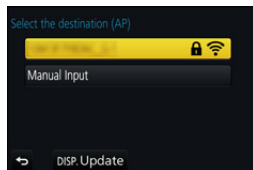
**■ When connecting with [Manual Input]**

- 1 On the screen displayed in step 1 of “If you are not sure about the WPS compatibility (connecting by [From List])”, select [Manual Input].**
- 2 Enter the SSID of the wireless access point you are connecting to, then select [Set].**
 - For information on how to enter characters, refer to P58.
- 3 Select the network authentication type.**
 - For information on network authentication, see the manual of the wireless access point.
- 4 Select the encryption type.**
 - The type of settings that can be changed may vary depending on the details of network authentication settings.

Network authentication type	Encryption types that can be set
[WPA2-PSK]	[TKIP]/[AES]
[WPA-PSK]	[TKIP]/[AES]
[Common Key]	[WEP]
[Open]	[No Encryption]/[WEP]

- 5 (When an option other than [No Encryption] is selected)
Enter the encryption key.**



- Check the wireless access points instruction manual and settings when saving a wireless access point.
- If no connection can be established, the wireless access point's radio waves may be too weak. Refer to "Message Display" (P318) and "Troubleshooting" (P320) for details.
- Depending on your environment, transmission speed between the camera and wireless access point may decrease. In addition, the wireless access point may not be available for use.

Connecting the camera and another device directly (direct connection)

You can select the method for connecting to the device you are using.

Select the connection method supported by your device.



[Wi-Fi Direct]	<ol style="list-style-type: none"> 1 Set the device to Wi-Fi Direct® mode. 2 On the camera screen, select [Wi-Fi Direct]. 3 On the camera screen, select the device to connect to.
[WPS Connection]	<p>[WPS (Push-Button)]</p> <ol style="list-style-type: none"> 1 On the camera, select [WPS (Push-Button)]. 2 Set the device to WPS mode. <ul style="list-style-type: none"> • You can wait longer for a connection by pressing [DISP.] on this unit.
	<p>[WPS (PIN code)]</p> <ol style="list-style-type: none"> 1 On the camera, select [WPS (PIN code)]. 2 Enter the PIN code of the device into this camera.
[Manual Connection]	<p>Enter the SSID and password into the device. The SSID and password are displayed on the connection waiting screen of this unit.</p> <ul style="list-style-type: none"> • If the destination is set to [Smartphone], the password is not displayed. Select the SSID to establish a connection. (P253)

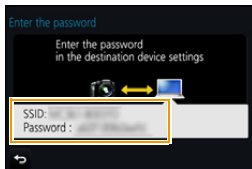

- Please also refer to the operating instructions of the device to be connected.

Connecting quickly with the same settings as the previous ones ([Select a destination from History])/([Select a destination from Favorite])

When the Wi-Fi function is used, a record is saved in the history. You can register records as favorites. Using the history or favorites list, you can easily connect with the same settings as used previously.

Check to see if the Wi-Fi settings of the device to connect to are the same as used previously.

- If the settings of the device to connect to have been changed, it may not be possible to connect to the device.

1 Select the menu. (P51)

MENU → ⚙ [Setup] → [Wi-Fi] → [Wi-Fi Function]

2 Select [Select a destination from History] or [Select a destination from Favorite].

[Select a destination from History]	Connects with the same settings as the previous ones.
[Select a destination from Favorite]	Connects with settings registered as favorites.

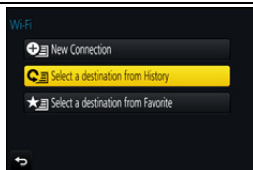

3 Select item.

- If the device you want to connect to (smartphone, etc.) is connected to a wireless access point other than the camera, you cannot connect the device to the camera using [Direct]. Change the Wi-Fi settings of the device you want to connect to so that the access point to be used is set to the camera.

You can also select [New Connection] and reconnect the devices. (P253)

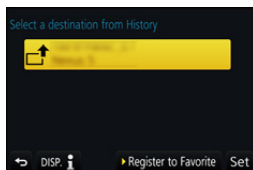

Registering records as favorites

1 Select the menu. (P51)

MENU → ⚙ [Setup] → [Wi-Fi] → [Wi-Fi Function] → [Select a destination from History]

2 Select the history you want to register to favorites, and then press ►.

3 Enter a registration name.

- For information on how to enter characters, refer to P58.
- A maximum of 30 characters can be entered. A two-byte character is treated as two characters.

Editing the history registered to favorites

1 Select the menu. (P51)

MENU → ⌂ [Setup] → [Wi-Fi] → [Wi-Fi Function] →
[Select a destination from Favorite]

2 Select the favorite history you want to edit, and then press ►.

[Remove from Favorite]	—
[Change the Order in Favorite]	Select the destination.
[Change the Registered Name]	<ul style="list-style-type: none"> • For information on how to enter characters, refer to P58. • A maximum of 30 characters can be entered. A two-byte character is treated as two characters.



Save frequently-used Wi-Fi connection settings as favorites

The number that can be saved in the history is limited.

We recommend that you save frequently-used Wi-Fi connection settings by registering them as favorites. (P284)



Checking the connection detail of a record or favorite

If [DISP.] is pressed when selecting an item in the history or favorites, the detail of the connection can be displayed.





- Performing [Reset Wi-Fi Settings] clears the history and the contents saved in [Select a destination from Favorite].
- When connecting to a network to which many PCs are connected by using [Select a destination from History] or [Select a destination from Favorite], a connection attempt may fail because the previously-connected device will be identified from among many devices.
If a connection attempt fails, reconnect by using [New Connection].

[Wi-Fi Setup] Menu

Configure the settings required for the Wi-Fi function.
The settings cannot be changed when connected to Wi-Fi.

Select the menu. (P51)

MENU → ⚙ [Setup] → [Wi-Fi] → [Wi-Fi Setup]	
[Wi-Fi Password]	<p>You can improve security by enabling password entry for a direct connection to a smartphone.</p> <p>[ON]: Connects the camera and a smartphone using an SSID and password. (P254)</p> <p>[OFF]: Connects the camera and a smartphone using an SSID. (P253)</p>
<ul style="list-style-type: none"> • When [ON] is selected, you can also set up a connection by scanning a QR code. (P254) 	
[LUMIX CLUB]	Acquires or changes the “LUMIX CLUB” login ID. (P276)
[PC Connection]	<p>You can set the workgroup. To send images to a PC, a connection to the same workgroup as the destination PC is required. (The default setting is “WORKGROUP”.)</p> <p>[Change Workgroup Name]: Enter the workgroup of the connecting PC.</p> <p>[Restore to Default]: Restores the default state.</p>
<ul style="list-style-type: none"> • For information on how to enter characters, refer to P58. • If you are using the PC with standard settings, you do not need to change the workgroup. 	
[Device Name]	<p>You can change the name (SSID) of this unit.</p> <ol style="list-style-type: none"> 1 Press [DISP]. 2 Enter the desired device name. <ul style="list-style-type: none"> • For information on how to enter characters, refer to P58. • A maximum of 32 characters can be entered.

    [Wi-Fi Function Lock]	<p>To prevent incorrect operation or use of the Wi-Fi function by a third party and to protect saved personal information, it is recommended that you protect the Wi-Fi function with a password.</p> <p>Setting a password will automatically display the password input screen when the Wi-Fi function is used.</p> <hr/> <p>[Setup]: Enter any 4-digit numbers as the password.</p> <p>[Cancel]</p>
<ul style="list-style-type: none"> • For information on how to enter characters, refer to P58. • Make a copy of password. If you forget the password, you can reset it with [Reset Wi-Fi Settings] in the [Setup] menu, however other settings will also be reset. (excluding [LUMIX CLUB]) 	
[Network Address]	<p>Displays the MAC address and IP address of this unit.</p> <ul style="list-style-type: none"> • A “MAC Address” is a unique address that is used to identify network equipment. • “IP address” refers to a number that identifies a PC connected to a network such as the Internet. Usually, the addresses for homes are automatically assigned by the DHCP function such as a wireless access point. (Example: 192.168.0.87)
[Approved Regulations]	<p>Displays the certification number for radio regulations.</p>

Watching 4K motion pictures on a TV/ Saving 4K motion pictures on your PC or recorder

Watching motion pictures in 4K

■ Playing Back on a TV Screen

By connecting the camera to a TV that supports motion pictures in 4K and playing back motion pictures recorded with their size set to [4K] in [Rec Quality], you can enjoy finely-detailed motion pictures in 4K. Even though the output resolution will be lower, you can also play them back by connecting the camera to a TV that does not support motion pictures in 4K.



Preparation: Set [HDMI Mode (Play)] (P223) to [AUTO] or [4K].

- When connecting to a TV that does not support 4K motion picture, select [AUTO].

Connect the camera and a 4K-compatible TV with an HDMI micro cable, and display the playback screen. (P290)

- When [VIERA Link] is set to [ON] and the camera is connected to a TV supporting VIERA Link, input of the TV will be switched automatically and playback screen will be displayed. (P293)
- You can also play back MP4 motion pictures with a [Rec Quality] size of [4K] by inserting the card into the SD card slot of a TV that supports 4K motion picture.
- Read the operating instructions for the TV.



■ Watching on a PC

- To play back motion pictures recorded with [Rec Quality] of [4K] on a PC, use the software "PHOTOfunSTUDIO" (P295).
- To play back and edit motion pictures in 4K, you need a high-performance PC environment.
- Refer to the operating instructions of "PHOTOfunSTUDIO" (PDF).



Storing 4K motion pictures

■ Storing on a PC

Refer to [P294](#) for details.

■ Storing on a Hard Disk or DVD

You cannot dub motion pictures recorded with their size set to [4K] in [Rec Quality] to Blu-ray discs and DVDs with Panasonic recorders. (As of September 2016)

You can use the software "PHOTOfunSTUDIO" ([P295](#)) to convert the file size of a motion picture to a smaller size or copy it to a DVD.

- Refer to the operating instructions of "PHOTOfunSTUDIO" (PDF).



MENU



Playing Back Pictures on a TV Screen

You can view pictures on a TV screen by connecting your camera to your TV with the HDMI micro cable.

Preparations: Turn this unit and the TV off.

1 Connect the camera and a TV.

- Check the direction of the terminals and plug in/out straight holding onto the plug. (It may result in malfunction by the deforming of the terminal if it is plugged in obliquely or in wrong direction.)
Do not connect devices to incorrect terminals. Doing so may cause malfunction.

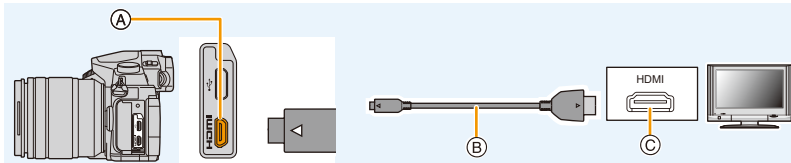

A [HDMI] socket (on the camera)

C HDMI socket (on the TV)

B HDMI micro cable

- Use a “High Speed HDMI micro cable” with the HDMI logo. Cables that do not comply with the HDMI standards will not work.
“High Speed HDMI micro cable” (Type D–Type A plug, up to 2 m (6.6 feet) long)
- Check the [HDMI Mode (Play)]. (P223)
- During 24p motion picture playback, please set [HDMI Mode (Play)] to [AUTO]. For settings other than [AUTO], it cannot output at 24 frames/second.
- No picture is displayed on the screen of this unit.

2 Turn on the TV and select the input to match the connector in use.

3 Turn the camera on and then press [▶].

- Depending on the [Aspect Ratio], black bands may be displayed on the top and bottom or the left and right of the pictures.
- Change the screen mode on your TV if the picture is displayed with the top or bottom cut off.
- HDMI output will be canceled if a USB connection cable (supplied) is connected simultaneously.
- No sound is output from the camera speakers.
- Read the operating instructions for the TV.





The recorded pictures can be played back on a TV with an SD Memory Card slot

- Depending on the TV model, pictures may not be displayed on the full screen.
- The file format of the motion pictures that can be played back differs depending on the TV model.
- In some cases, panorama pictures cannot be played back. Also, auto-scroll playback of panorama pictures may not work.
- For cards compatible with playback, refer to the operating instructions of the TV.

Recording while monitoring camera images

When using the HDMI output, you can record pictures and motion pictures while monitoring the camera image on an external monitor, TV or similar device.

■ Switching the information displayed

You can change the display shown during HDMI output using [HDMI Info Display (Rec)] (P224) in [TV Connection] on the [Setup] menu.

[ON]: The camera display is output as is.

[OFF]: Only images are output.

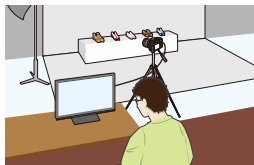

- When you perform recording during HDMI output, the [Rec Quality] setting in the [Motion Picture] menu is applied to images. If the connected device does not support the setting, the optimal setting for the device will be automatically selected for the HDMI output image quality.
- When the camera is connected to an external monitor or a TV that supports 4K motion picture, if you use one of the following settings, the angle of view becomes even narrower than normal:
 - [4K/100M/30p]/[4K/100M/24p] in [Rec Quality]
 - [4K Live Cropping]
- When using the Auto Focus Mode [\oplus] or MF assist, the screen cannot be enlarged in windowed mode.
- Ex. Tele Conv. (motion picture) does not work (excluding Creative Motion Picture Mode).
- [Aspect Ratio] in the [Rec] menu is fixed to [16:9].
- Electronic sounds and electronic shutter sounds are muted.
- When you check the image and sound from the TV connected to the camera, the microphone of the camera may pick up the sound from the speakers of the TV, producing an abnormal sound (audio feedback). If this occurs, move the camera away from the TV or lower the volume on the TV.
- If you set up a Wi-Fi connection while using the HDMI output, no image will be displayed on the camera monitor.
- The scene selection screen in Scene Guide Mode is not output through the HDMI connection.
- This function is not available in the following cases:
 - During panorama picture recording
 - When recording 4K photos
 - When recording with the Post Focus function

Using VIERA Link (HDMI)

What is the VIERA Link (HDMI) (HDAVI Control™)?

- This function allows you to use your remote control for the Panasonic TV for easy operations when this unit has been connected to a VIERA Link compatible device using an HDMI micro cable for automatic linked operations.
(Not all operations are possible.)
- VIERA Link is a unique Panasonic function built on an HDMI control function using the standard HDMI CEC (Consumer Electronics Control) specification.
Linked operations with HDMI CEC compatible devices made by other companies are not guaranteed. When using devices made by other companies that are compatible with VIERA Link, refer to the operating instructions for the respective devices.
- This unit supports "VIERA Link Ver.5" function. "VIERA Link Ver.5" is the standard for Panasonic's VIERA Link compatible equipment. This standard is compatible with Panasonic's conventional VIERA Link equipment.

Preparations:

Set the [VIERA Link] to [ON]. (P224)

- 1 Connect this unit to a Panasonic TV compatible with VIERA Link with an HDMI micro cable (P290).**
- 2 Turn the camera on and then press [▶].**
- 3 Operate with the remote control for the TV.**

Turning this unit off:

If you use the remote control for the TV to turn the TV off, this unit is also turned off.

Automatic input switching:

- If you connect with an HDMI micro cable and then turn this unit on, and then press [▶], the input channel on the TV automatically switches to this unit's screen. If the TV's power is in standby status, it will turn on automatically (if [Set] has been selected for the TV's [Power on link] setting).
- Operation using the buttons on this unit will be limited.
- To play back the sound of a film during a slide show, set [Sound] to [AUTO] or [Audio] on the Slide Show setting screen.
- Use a "High Speed HDMI micro cable" with the HDMI logo.
Cables that do not comply with the HDMI standards will not work.
"High Speed HDMI micro cable" (Type D–Type A plug, up to 2 m (6.6 feet) long)
- If VIERA Link does not work properly, refer to P327.

Saving still pictures and motion pictures on your PC

You can acquire recorded pictures to a PC by connecting the camera and the PC.

- Some PCs can read directly from the card removed from the camera. For details, refer to the operating instructions of your PC.

■ PC that can be used

The unit can be connected to any PC capable of recognizing a mass storage device.

- Windows support: Windows 7/Windows 8/Windows 8.1/Windows 10
- Mac support: OS X v10.5 to v10.11



AVCHD motion pictures may not be imported correctly when copied as files or folder

- When using Windows, import AVCHD motion pictures with “PHOTOfunSTUDIO” (P295).
- With a Mac, AVCHD motion pictures can be imported using “iMovie”.
Please note that importing is not possible depending on the picture quality.
(For details about iMovie, please contact Apple Inc.)

Downloading software

Download and install software to edit and play back images with a PC.

PHOTOfunSTUDIO 9.9 PE

This software allows you to manage images. For example, you can send pictures and motion pictures to a PC and sort them by recording date or model name. You can also perform operations such as writing images to a DVD, processing and correcting images, and editing motion pictures.

Check the site below to download and install the software.

Download the software while it is available for download.

http://panasonic.jp/support/global/cs/soft/download/d_pfs99pe.html

(This Site is English only.)

- Download expiration: September 2021

- Operating environment

OS	Windows [®] 7 (32bit/64bit) SP1, Windows [®] 8 (32bit/64bit), Windows [®] 8.1 (32bit/64bit), Windows [®] 10 (32bit/64bit)	
CPU	Windows [®] 7	Pentium [®] 4 (2.8 GHz or higher)
	Windows [®] 8	
	Windows [®] 8.1	
	Windows [®] 10	
Display	1024×768 pixels or more (1920×1080 pixels or more recommended)	
RAM	Windows [®] 7	1 GB or more (32bit) 2 GB or more (64bit)
	Windows [®] 8	
	Windows [®] 8.1	
	Windows [®] 10	
Free hard disk space	450 MB or more for installing software	

- Refer to the operating instructions of “PHOTOfunSTUDIO” (PDF file) for further operating environment.
- “PHOTOfunSTUDIO” is not compatible with Mac.

SILKYPIX Developer Studio SE

This is software to edit RAW format images.

Edited images can be saved in a format (JPEG, TIFF, etc.) that can be displayed on a personal computer.

Check the site below to download and install the software.

<http://www.isl.co.jp/SILKYPIX/english/p/>

- Operating environment

OS	Windows	Windows [®] 7, Windows [®] 8, Windows [®] 8.1, Windows [®] 10
	Mac	Mac OS X v10.6 to v10.11

- For details on how to use the “SILKYPIX Developer Studio”, refer to the “Help” or the Ichikawa Soft Laboratory’s support website.

**LoiLoScope 30 day full trial version
(Windows 7/Windows 8/Windows 8.1/Windows 10)**

This software allows you to edit motion pictures with ease.

Check the site below to download and install the software.

<http://loilo.tv/product/20>

- Only the trial version will be installed.
 - For more information on how to use LoiLoScope, read the LoiLoScope manual available for download at the site.
 - “LoiLoScope” is not compatible with Mac.
- To download the software, you need to connect the PC to the Internet.
 - It may take some time to download the software depending on the communication environment.

Transferring images to a PC

Preparations:

Install "PHOTOfunSTUDIO" to the PC. (P295)

1 Connect the computer and camera with the USB connection cable (supplied).

- Please turn this unit on and your PC before connecting.
- Check the direction of the terminals and plug in/out straight holding onto the plug. (It may result in malfunction by the deforming of the terminal if it is plugged in obliquely or in wrong direction.)
Do not connect devices to incorrect terminals. Doing so may cause malfunction.
- Do not use any other USB connection cables except the supplied one.

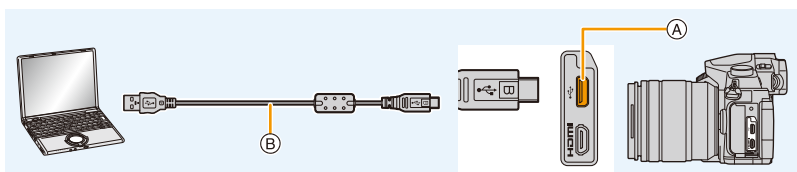

- (A) USB socket
- (B) USB connection cable (supplied)

2 Press ▲/▼ to select [PC], and then press [MENU/SET].

- If [USB Mode] (P223) is set to [PC] in the [Setup] menu in advance, the camera will be automatically connected to the PC without displaying the [USB Mode] selection screen.

3 Copy the images to a PC using "PHOTOfunSTUDIO".

- Do not delete or move copied files or folders in Windows Explorer.
When viewing in "PHOTOfunSTUDIO", you will not be able to play back or edit.

• Use a battery with sufficient battery power or the AC adaptor (optional). If the remaining battery power becomes low while the camera and the PC are communicating, the status indicator blinks and the alarm beeps.

Disconnect the USB connection cable safely. Otherwise, data may be destroyed.

• Before inserting or removing a card, turn the camera off and disconnect the USB connection cable. Otherwise, data may be destroyed.

■ Copying to a PC without using “PHOTOfunSTUDIO” (For Mac)

Even if you are using a Mac, or in any situation where “PHOTOfunSTUDIO” cannot be installed, you can still copy files and folders by connecting the camera to the computer and then dragging and dropping them to it.

• The content (folder structure) on the card of this unit is as follows.

For Windows: A drive ([LUMIX]) is displayed in [Computer]

For Mac: A drive ([LUMIX]) is displayed on the desktop

• Card

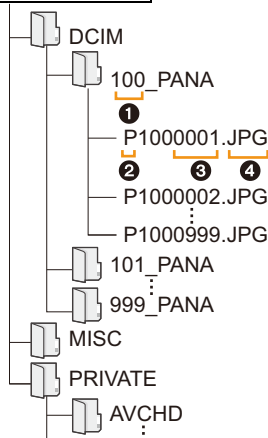

DCIM:	Images
① Folder number	
② Color space	P: sRGB _: AdobeRGB
③ File number	
④ JPG:	Still pictures
MP4:	[MP4] Motion pictures
RW2:	Pictures in RAW files
MPO:	3D pictures
MISC:	DPOF print Favorite
AVCHD:	[AVCHD] Motion pictures

- A new folder is created when pictures are taken in the following situations.
 - After [No.Reset] (P225) in the [Setup] menu has been executed
 - When a card containing a folder with the same folder number has been inserted (such as when pictures were taken using another maker of camera)
 - When there is a picture with file number 999 inside the folder

Saving still pictures and motion pictures on a Recorder

If you insert card holding content recorded with this unit into a Panasonic recorder, you can dub the content to a Blu-ray Disc or DVD etc.

Methods to export still pictures and motion pictures to other devices will vary depending on the file format. (JPEG, RAW, MPO, AVCHD, or MP4).

- See the operating instructions for the recorder about the details about copying and playing back.

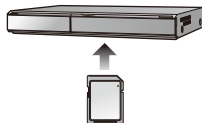

MENU



Printing the Pictures

If you connect the camera to a printer supporting PictBridge, you can select the pictures to be printed out and instruct that printing be started on the camera's monitor.

- Group pictures will not be displayed as group pictures but as single pictures.
- Some printers can print directly from the card removed from the camera. For details, refer to the operating instructions of your printer.

Preparations:

Turn on the camera and the printer.

Perform the print quality and other settings at the printer before printing the pictures.

1 Connect the printer and camera with the USB connection cable (supplied).

- Check the direction of the terminals and plug in/out straight holding onto the plug. (It may result in malfunction by the deforming of the terminal if it is plugged in obliquely or in wrong direction.)
Do not connect devices to incorrect terminals. Doing so may cause malfunction.
- Do not use any other USB connection cables except the supplied one.

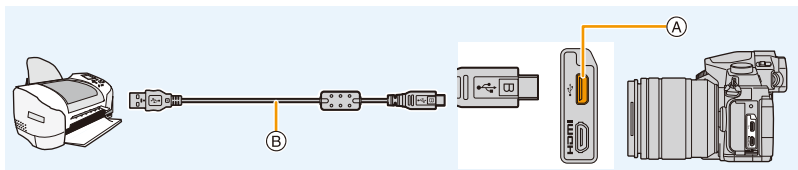

- (A) USB socket
- (B) USB connection cable (supplied)

2 Press ▲/▼ to select [PictBridge(PTP)], and then press [MENU/SET].



- Disconnect the USB connection cable after printing.
- Use a battery with sufficient battery power or the AC adaptor (optional). If the remaining battery power becomes low while the camera and the printer are connected, the status indicator blinks and the alarm beeps. If this happens during printing, stop printing at once. If not printing, disconnect the USB connection cable.
- Do not disconnect the USB connection cable while [🚫] (Cable disconnect prohibit icon) is displayed.
(May not be displayed depending on the type of printer used.)
- Before inserting or removing a card, turn the camera off, and disconnect the USB connection cable.



Not available in these cases:

- Motion pictures, 4K burst files, and images recorded with the Post Focus function cannot be printed.

Selecting a single picture and printing it

- 1 Press ◀/▶ to select the picture and then press [MENU/SET].
- 2 Press ▲ to select [Print start] and then press [MENU/SET].



Selecting multiple pictures and printing them

- 1 Press ▲.
- 2 Press ▲/▼ to select an item and then press [MENU/SET].

[Multi Select]	<p>Multiple pictures are printed at one time.</p> <ul style="list-style-type: none"> • Press ▲/▼/◀/▶ to select the pictures and then press [MENU/SET]. (When [MENU/SET] is pressed again, the setting is canceled.) • After the pictures have been selected, press ◀ to select [OK], and then press [MENU/SET].
[Select All]	Prints all the stored pictures.
[Print Set (DPOF)]	Prints the pictures set in [Print Set] only. (P246)
[Favorite]	Prints the pictures set as favorites only. (P245)

- 3 Press ▲ to select [Print start] and then press [MENU/SET].

■ Print Settings

Select and set the items both on the screen in step **2** of the “Selecting a single picture and printing it” and in step **3** of the “Selecting multiple pictures and printing them” procedures.

[Print with Date]	Sets date printing.
[Num.of prints]	Sets the number of pictures to be printed (up to 999 pictures).
[Paper Size]	Sets the paper size.
[Page Layout]	Sets whether or not to add borders and how many pictures to be printed on each sheet of paper.

- When you want to print pictures on a paper size or a layout which is not supported by the camera, set [Paper Size] or [Page Layout] to  and then set the paper size or the layout on the printer.
(For details, refer to the operating instructions of the printer.)
- If the printer does not support date printing, the date cannot be printed on the picture.
- Depending on the printer, the date print settings of the printer may take precedence so check if this is the case.

- The camera is receiving an error message from the printer when the  indication lights orange during printing. After finishing printing, make sure there are no problems with the printer.
- If the number of prints is high, the pictures may be printed several times. In this case, the remaining number of prints indicated may differ from the number set.
- Only pictures taken in JPEG format can be printed. Those taken in RAW will use the JPEG pictures that were simultaneously created. If an equivalent JPEG picture is not available, no print will take place.

Enjoying 3D pictures

Taking 3D pictures

Attaching the 3D interchangeable lens (H-FT012: optional) to the camera allows you to take 3D pictures for extra impact.

- 1 Attach the 3D interchangeable lens to the camera.**
- 2 Bring the subject into the frame and record by pressing the shutter button fully.**

- Focusing is not required when recording 3D pictures.
- Still pictures recorded with the 3D interchangeable lens attached are saved in MPO format (3D).

To ensure that the 3D pictures can be safely viewed, pay attention to the following points when recording.

- Where possible, record with the unit in a horizontal state.
- The suggested minimum subject distance is 0.6 m (2.0 feet).
- Be careful not to shake the camera while in a vehicle or walking.

- It is recommended to use a tripod or a flash to record steady pictures.
- Up to approx. 3990 3D pictures can be recorded on a 16 GB card.
(When the aspect ratio is set to [4:3], and the quality is set to [HD 3D].)
- Read the operating instructions of the 3D interchangeable lens for details.
- **You cannot record 3D pictures in vertical orientation.**
- When a distance to the subject is 0.6 m (2.0 feet) to approximately 1 m (3.3 feet), horizontal disparity becomes too great, and you may not see the 3D effect at the edges of the image.

Playing back 3D pictures

Connecting the camera to a 3D compatible television and playing back pictures taken in 3D allows you to enjoy 3D pictures for extra impact.

Preparations: Set the [HDMI Mode (Play)] to [AUTO], [1080p] or [1080i]. (P223)
Set the [3D Playback] to [3D]. (P224)

Connect the unit to a 3D compatible television using the HDMI micro cable and display the playback screen. (P290)

- When [VIERA Link] is set to [ON] and the camera is connected to a TV supporting VIERA Link, input of the TV will be switched automatically and playback screen will be displayed. (P293)
- For the pictures recorded in 3D, [3D] will appear on the thumbnail display at playback.

■ Switch the playback method for the still pictures recorded in 3D

- 1 Select the picture recorded in 3D.
- 2 Select [2D/3D Settings] on the [Playback] menu. (P51)
 - Playback method will switch to 3D if it is playing back in 2D (conventional image), or it will switch to 2D if it is playing back in 3D.
 - If you feel tired, uncomfortable or otherwise strange when playing back pictures recorded in 3D, set to 2D.

- It is also possible to play back the recorded 3D pictures by inserting an SD card into the 3D compatible television with an SD card slot.
- A black screen is displayed for a few seconds when switching playback back and forth from 3D to 2D pictures.
- When you select a 3D picture thumbnail, it may take a few seconds for playback to start. After playback, the thumbnail display may take a few seconds to reappear.
- When viewing 3D pictures, your eyes may become tired if you are too close to the television screen.
- If your television does not switch to a 3D picture, make the necessary settings on the TV. (For details, refer to the operating instructions of the TV.)
- 3D pictures can be saved to your computer or Panasonic devices. (P294, 299)

Functions that cannot be used on 3D pictures

■ Functions that cannot be used during 3D recording

When recording with the 3D interchangeable lens (H-FT012: optional), the following feature will be disabled:

(Recording functions)

- Auto Focus/Manual Focus operation
- Zoom operation
- 4K Photo recording
- [Glistening Water]/[Glittering Illuminations]/[Handheld Night Shot]/[Panorama Shot] (Scene Guide Mode)
- [Rough Monochrome]/[Impressive Art]/[High Dynamic]/[Toy Effect]/[Toy Pop]/[Star Filter]/[One Point Color]/[Sunshine] (Creative Control Mode)
- Defocus control function
- Post Focus recording
- Aperture setting
- Recording motion pictures*1

*1 The motion picture button, Creative Video Mode and the [Motion Picture] menu will be unavailable or unusable.



([Rec] menu)

- [Simultaneous record w/o filter] in [Filter Settings]/[Picture Size]*2/[Quality]*3/[AFS/AFF]/[SH] of [Burst Rate]/Aperture Bracket, Focus Bracket, and White Balance Bracket in [Bracket]/[i.Dynamic]/[i.Resolution]/[i.Handheld Night Shot]/[iHDR]/[HDR]/[Multi Exp.]/[Panorama Settings]/[Red-Eye Removal]/[Shading Comp.]/[Ex. Tele Conv.]/[Digital Zoom]

*2 The setting is fixed as shown below.

Aspect ratio	Picture size	Aspect ratio	Picture size
[4:3]	1824×1368	[16:9]	1824×1024
[3:2]	1824×1216	[1:1]	1712×1712

*3 When attaching 3D interchangeable lens, the following icons are displayed.

[ ([3D+Fine])	Both MPO images and fine JPEG images are recorded simultaneously.
[ ([3D+Standard])	Both MPO images and standard JPEG images are recorded simultaneously.

([Custom] menu)

- [AF/AE Lock]/[Shutter AF]/[Quick AF]/[Eye Sensor AF]/[Pinpoint AF Time]/[Pinpoint AF Display]/[AF Assist Lamp]/[Direct Focus Area]/[Focus/Release Priority]/[AF Sensitivity]/[AF+MF]/[MF Assist]/[MF Assist Display]/[MF Guide]/[Rec Area]/[Remaining Disp.]/[Video Button]/[Power Zoom Lens]/[Touch AF] ([Touch Settings])/[Touch Pad AF] ([Touch Settings])

■ Functions that cannot be used during 3D picture playback

During the 3D playback of 3D pictures on a 3D-compatible TV, the following functions are disabled.

- [Highlight] ([Custom] menu)
- Playback Zoom
- Editing functions in the [Playback] menu (menu functions other than [Slide Show]/[Playback Mode])

12. Others

Optional accessories

- Some optional accessories may not be available in some countries.

External Flash (optional)

After attaching the flash (DMW-FL200L, DMW-FL360L, DMW-FL580L: optional), the effective range will be increased when compared to the camera's built-in flash.

Preparations:

- Turn off the camera and close the built-in flash.

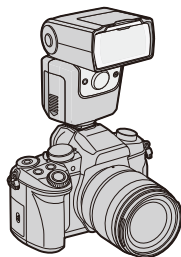

Removing the Hot Shoe Cover

The camera comes with a hot shoe cover attached to the hot shoe.

Remove the hot shoe cover by pulling it in the direction indicated by arrow ② while pressing it in the direction indicated by arrow ①.

- Keep the Hot Shoe Cover out of reach of children to prevent swallowing.

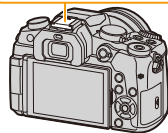
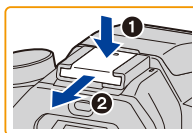

- To change the settings for external flashes on the camera, refer to [P156](#).
- Refer to [P161](#) about the settings for the wireless flash.



When using other commercially available external flashes without communication functions with the camera

- It is necessary to set the exposure on the external flash. If you want to use the external flash in Auto Mode, use an external flash that allows you to set the aperture value and the ISO sensitivity to match the settings on the camera.
- Set to Aperture-Priority AE Mode or Manual Exposure Mode on the camera and then set the same aperture value and ISO sensitivity on the external flash. (The exposure cannot be compensated adequately due to the change on the aperture value in Shutter-Priority AE Mode and the external flash cannot control the light adequately in Program AE Mode because the aperture value cannot be fixed.)



- When an external flash is attached, the following functions are available in addition to the functions available with the built-in flash.
 - Burst recording (when a setting other than [SH] is selected for [Burst Rate])
 - Aperture Bracket
 - Focus Bracket
- You can set the aperture value, the shutter speed and the ISO sensitivity on the camera even when attaching the external flash.
- If you record at close range with a wide angle, light from the flash may be blocked by the lens, darkening the lower part of the screen.
- Do not use commercially available external flashes with high-voltage synchro terminals, reverse polarity or functions that enable them to communicate with the camera. Doing so may cause the camera to malfunction or operate incorrectly.
- When attaching the external flash, do not hold only the external flash because it may detach from the camera.
- Read the operating instructions of the external flash for details.

External Microphone (optional)

Using a stereo shotgun microphone (DMW-MS2: optional) or stereo microphone (VW-VMS10: optional), you can record sounds with quality superior to those recorded with the built-in microphone. Using the stereo shotgun microphone (DMW-MS2: optional), you can switch between the gun (ultra-directional) recording and the wide range stereo recording.

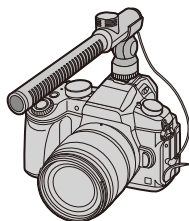

Preparations:

- Close the built-in flash, and then turn this unit off.
- Remove the hot shoe cover that is attached to the camera. (P306)

■ Setting the range within which the stereo shotgun microphone (DMW-MS2: optional) will record sounds

- 1 Attach the dedicated stereo shotgun microphone to this unit, and then turn this unit on.



2 Select the menu. (P51)

MENU →  **[Motion Picture]** → **[Special Mic.]**

- The menu items are displayed only when the stereo shotgun microphone is connected.

[STEREO]	Allows stereo recording of sound over a wide area.
[LENS AUTO]	Allows recording within the range that is set automatically according to the angle of view of the lens.
[SHOTGUN]	Allows recording from one direction by shutting out background and surrounding noise.
[S.SHOTGUN]	Allows recording within the range even narrower than that of [SHOTGUN].
[MANUAL]	Allows recording within the range you set manually.

3 (When **[MANUAL]** is selected)

Press **◀/▶** to select a range, and press **[MENU/SET]**.

■ Reducing the wind noise when using an external microphone

The camera will effectively reduce the wind noise when recording sound with an external microphone.

MENU →  **[Motion Picture]** → **[Wind Cut]**

Settings: **[HIGH]/[STANDARD]/[LOW]/[OFF]**

- This item is available only when using an external microphone.
 - Setting [Wind Cut] may alter the usual sound quality.
- While the external microphone is connected,  is displayed on the screen.
 - When the external microphone is connected, [Mic Level Disp.] (P207) is automatically set to [ON], and the mic level is displayed on the screen.
 - When an external microphone is attached to the camera, do not hold only the external microphone to prevent the camera from falling.
 - When an external microphone is attached to the camera, do not open the built-in flash.
 - If the noises are recorded when you use an AC adaptor (optional), use a battery.
 - When a stereo microphone (VW-VMS10: optional) is used, [Special Mic.] is fixed to [STEREO].
 - If you press the function button to which [Mic. Directivity Adjust] in [Fn Button Set] (P55) in the [Custom] menu is assigned when [Special Mic.] is set to [MANUAL], the screen that lets you set the range will be displayed.
 - For details, refer to the operating instructions of the external microphone.

Battery Grip (optional)

Using a battery grip (DMW-BGG1: optional) improves ease of operation and grip when held vertically. Installing a spare battery will allow you to record for a longer time.

A battery grip (DMW-BGG1: optional) is supplied with a battery pack (DMW-BLC12).

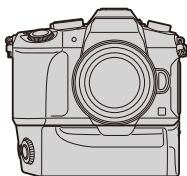

■ Setting a priority for the use of spare batteries

You can set which battery should be used when the battery is inserted to both this unit and the battery grip.

Preparations:

- Turn this unit off, and then remove the terminal cover.

- 1 **Attach the battery grip to this unit, and then turn this unit on.**
- 2 **Select the menu. (P51)**

MENU → **f** [Setup] → [Battery Use Priority]

[BODY]: The battery in this unit is used first.

[BG]: The battery in the battery grip is used first.

- When the battery in the battery grip is used, **[BG]** is displayed on the screen.
- If the terminal cover is hard to remove, flip the cover's corner by the camera's recess toward the center.
- Read the operating instructions of the battery grip for details.

Shutter Remote Control (optional)

If you use the shutter remote control (DMW-RSL1: optional), you can avoid jitter (camera shake) when using a tripod and you can keep the shutter pressed fully when taking pictures with [B] (Bulb) or Burst Mode. The shutter remote control works similar to the shutter button on the camera.



- Always use a genuine Panasonic shutter remote control (DMW-RSL1: optional).
- Record with Creative Video Mode (P85) when using for motion picture recording. Motion picture recording can be started/stopped with the shutter remote control.
- Read the operating instructions of the shutter remote control for details.

Not available in these cases:

- You cannot use the shutter remote control for the following operation.
 - Canceling [Sleep Mode], [Sleep Mode(Wi-Fi)] or [Power Save LVF Shooting]

AC adaptor (optional)/DC coupler (optional)

By using the AC adaptor (optional) and DC coupler (optional), you can record and play back without worrying about the remaining battery charge.

The optional DC coupler can only be used with the designated Panasonic AC adaptor (optional).

- Always use a genuine Panasonic AC adaptor (optional).
- When using an AC adaptor (optional), use the AC cable supplied with the AC adaptor.
- When the DC coupler is being mounted, the DC coupler cover opens, so the structure ceases to be dust-proof and splash-proof. Be careful not to allow sand, dust and water etc. to adhere to or enter the structure. After use, check that there is no foreign matter attached to the coupler cover, and close it firmly.
- Also read the operating instructions for the AC adaptor (optional) and DC coupler.

Filters (optional)

The MC protector is a transparent filter which affects neither the colors nor the amount of light, so it can always be used to protect the camera's lens.

The ND filter reduces the amount of light to approximately 1/8th (equal to adjusting the aperture value 3 increments) without affecting the color balance.

PL filter will suppress the reflected light from a metal or non spherical surfaces (flat non-metallic surfaces, water vapour or invisible particles in the air), making it possible to take a picture with enhanced contrast.

- Do not attach multiple filters at the same time.
- You can attach the lens cap or the lens hood when the filter is attached.
- Refer to the instructions for each filter for details.

Monitor Display/Viewfinder Display

- The following images are examples of when the display screen is set to [] (monitor style) in the monitor.

In recording

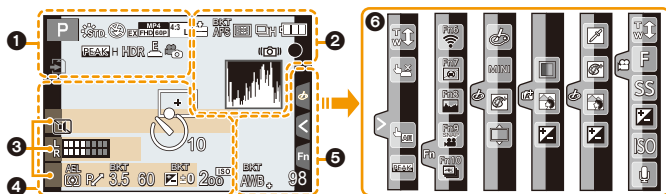

1

	Recording Mode (P40)
C 1	Custom settings (P87)
	Photo Style (P186)
	Flash Mode (P157)
	Flash (P159, 162)
	Extended Tele Conversion (when recording motion pictures) (P149)
	Recording format/Recording quality (P166)
	Snap Movie (P174)
	Picture size/Aspect Ratio (P189)
	Extended Tele Conversion (when taking still pictures) (P149)

	Image size ([Panorama Shot]) (P77)
	Image effect (filter) adjustment display (P82, 188)
EXPS	Image effect (filter) setting (P188)
	Card (displayed only during recording) (P26)
8m30s	Elapsed recording time*1 (P164)
	Simultaneous recording indicator (P172)
	Automatic viewfinder/monitor switching (P37)
	Peaking (P213)
	Highlight Shadow (P193)
HDR	HDR (P195)/iHDR (P63)
	Multi exposure (P196)
	Digital Zoom (P151)
	Electronic shutter (P197)
	Picture Mode (Photo Priority) (P172)
	Overheat indicator (P322, 323)

2

	RAW	Quality (P191)
	AFS AFF AFC MF	Focus Mode (P91, 102)
	AFS	Focus Bracket (P143)
		Post Focus (P129)
		AF Mode (P93)
		Pull Focus (P176)
		Face Recognition (P202)
	AFL	AF Lock (P105)
		Burst (P115)
		4K Photo (P118)
		Self-timer (P135)
		Battery indication (P20)
		Battery Grip (P309)
		Image Stabilizer (P144)
		Jitter alert (P145)
		Recording state (Flashes red.)/ Focus (Lights green.) (P39)
		Focus (Under low illumination) (P89)
		Focus (Starlight AF) (P89)
		Connected to Wi-Fi
		Histogram (P214)

3

Name ^{*2}	(P204)
Number of days that have passed since the departure date ^{*3}	(P219)
Age ^{*2}	(P204)
Location ^{*3}	(P219)
Current date and time/Travel destination setting ^{*3} .	(P219)
Exposure meter	(P216)
Focal distance display	(P152)
Step zoom	(P152)

4

		AF area (P89, 98)
		Spot metering target (P192)
		Center marker display (P214)
		Self-timer (P135)
		Mic level display (P207)
		Mic Level Limiter (OFF) (P207)
		Silent Mode (P209)
		External Microphone (P307)
		AE Lock (P105)
		Metering Mode (P50, 192)
		Program Shift (P67)
	3.5	Aperture value (P39)
	BKT 3.5	Aperture Bracket (P143)
	60	Shutter speed (P39)
		Exposure compensation value (P106)
	BKT ±0	Exposure Bracket (P142)
		Brightness (P65, 84)
		Manual Exposure Assistance (P70)
	200	ISO sensitivity (P108)

5

	BKT AWB ±	White Balance Bracket (P113)
		White Balance Fine Adjustment (P112)
		White Balance (P110)
		Color (P65)
	98	Number of recordable pictures (P28)
	r20	Maximum number of pictures that can be taken continuously (P116)
	R8m30s	Available recording time ^{*1} (P28)

6

Touch tab (P218)

		Touch zoom (P153)
		Touch Shutter (P49)
		Touch AE (P50)
		Peaking (P213)
	 	Function button (P56)
		Color (P65)
		Defocus control function (P64, 84)
		Brightness (P65, 84)
		Type of defocus ([Miniature Effect]) (P81)
		One point color (P81)
		Position of the light source (P82)
		Image effect (filter) adjustment (P84, 188)
		Image effect ON/OFF (P188)
		Image effect (filter) (P188)
		Aperture value (P39)
		Shutter speed (P39)
		ISO sensitivity (P108)
		Microphone level adjustment (P207)

*1 h: hour, m: minute, s: second

*2 This is displayed for about 5 seconds when the camera is turned on if the [Profile Setup] setting is set.

*3 This is displayed for about 5 seconds when the camera is turned on, after setting the clock and after switching from Playback Mode to Recording Mode.

In recording

On-monitor recording information

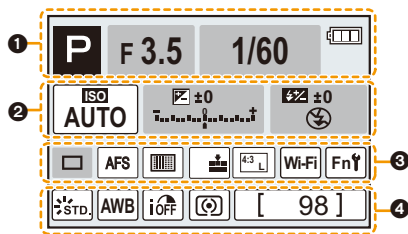

1		Recording Mode (P40)
	F3.5	Aperture value (P39)
	1/60	Shutter speed (P39)
		Battery indication (P20)
2	ISO AUTO	ISO sensitivity (P108)
		Exposure compensation value (P106)
		Brightness (P65)
		Manual Exposure Assistance (P70)
		Flash Mode (P157)
		Flash (P159, 161)

3		Single (P114)
		Burst (P115)
		4K Photo (P118)
		Self-timer (P135)
	AFS AFF AFC MF	Focus Mode (P91, 102)
		AF Mode (P93)
		Quality (P191)
		Picture size/Aspect Ratio (P190)
	Wi-Fi	Wi-Fi (P250)
	Fn	Function button setting (P55)
4		Photo Style (P186)
	AWB	White Balance (P110)
		Intelligent Dynamic Range Control (P194)
		Metering Mode (P192)
	98	Number of recordable pictures (P28)
	r20	Maximum number of pictures that can be taken continuously (P116)
	R8m30s	Available recording time (P28)



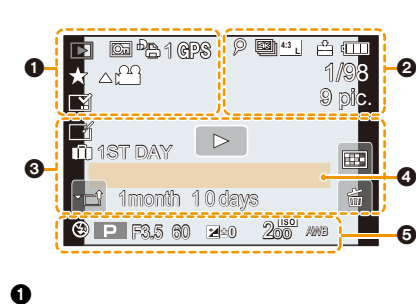





In playback







	Playback Mode (P231)
	Protected picture (P247)
	Number of prints (P246)
	Location Information display (P232)
	Favorites (P245)
	Cable disconnect prohibit icon (P301)
	Motion picture playback (P178)
	Play panorama (P78)
	Continuous Burst Picture Group Playback (P182)
	Save pictures from the 4K burst file (P125)
	Create pictures from an image recorded with the Post Focus function (P132)
	Continuous [Time Lapse Shot] Picture Group Playback (P182)
	Continuous playback of the Stop Motion Animation Group (P182)
	Focus Bracket (P182)
	Stamped with text indication (P239)
8m30s	Elapsed playback time*1 (P178)

	Icon indicating the presence of a marker (P126)
	4K Photo (4K burst file) (P118)
	Post Focus (P129)
	Focus Stacking (P133)
	Picture size/Aspect Ratio (P190)
	Recording format/Recording quality (P166)
	Snap Movie (P174)
	RAW Quality (P191)
	Battery indication (P20)
	Battery Grip (P309)
1/98	Picture number/Total pictures
	Connected to Wi-Fi
9 pic.	Number of group pictures
8m30s	Motion picture recording time*1 (P178)

3

	Clear Retouch completed icon (P237)
	Currently retrieving information icon
	Playback (Motion Pictures) (P178)
	1ST DAY Number of days that have passed since the departure date (P219)
	Upload (Wi-Fi) (P274)
	Burst Picture Group Display (P183)
	Focus Bracket Group Display (P183)
	[Time Lapse Shot] Picture Group Display (P183)
	Display for the Stop Motion Animation Group (P183)

	Sub Menu (P274)
	Silent Mode (P209)
1 month 10days	Age (P204, 205)
	Multi Playback (P181)
	Delete (P184)

4

Name* ²	(P204, 205)
Location* ²	(P219)
Title* ²	(P238)

5

Recording information



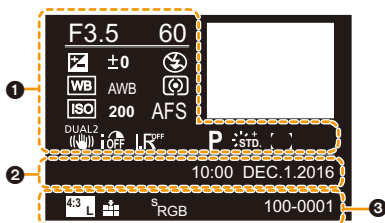

In playback

Detailed information display



1







Recording information

	Intelligent Dynamic Range Control (P194)
	HDR (P195)/iHDR (P63)
	Intelligent Resolution (P194)
	Shading Compensation (P200)

2

Recorded date and time/World Time (P219)

3

	Picture size/Aspect Ratio (P190)
	Recording format/Recording quality (P166)
	Quality (P191)
	Color space (P201)
	4K Photo (4K burst file) (P118)
	Post Focus (P129)
	Focus Stacking (P133)
100-0001	Folder/File number (P298)

In playback

Histogram display

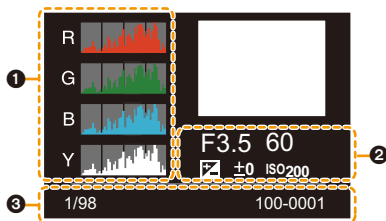

①

Histogram (P47)

②

Recording information

③

1/98 Picture number/Total pictures

100-0001 Folder/File number (P298)

*1 h: hour, m: minute, s: second

*2 It is displayed in order of [Title], [Location], [Name] ([Baby1]/[Baby2], [Pet]), [Name] ([Face Recog.]).

Message Display

Confirmation messages or error messages will be displayed on the screen in some cases. The major messages are described below as examples.

[Some pictures cannot be deleted]/[This picture cannot be deleted]

- This feature can only be used with pictures that comply with the DCF standard. Perform formatting (P27) on this unit after saving necessary data on a PC, etc.

[Cannot be set on this picture]

- [Title Edit], [Text Stamp], [Print Set], etc. cannot be set for pictures not based on the DCF standard.

[Memory Card Error Format this card?]

- It is a format that cannot be used with this unit.
 - Insert a different card.
 - Format the card again with the camera after saving necessary data on a PC etc. (P27)
Data will be deleted.

[The lens is not attached properly. Do not push lens release button while lens is attached.]

- Detach the lens once, and then attach it again without pressing the lens release button. (P30)
Turn this unit on again, and if it is still displaying, contact the dealer.

[Lens attachment failed. Please make sure the lens is attached correctly.]

- Detach the lens from the camera body and gently wipe the contacts on the lens and the camera body using a dry cotton swab.
Attach the lens, turn this unit on again, and if it is still displaying, contact the dealer.

[Memory Card Error]/[This memory card cannot be used]

- Use a card compatible with this unit. (P26)

[Insert SD card again]/[Try another card]

- An error has occurred accessing the card.
Insert the card again.
- Insert a different card.

[Read Error/Write Error Please check the card]

- It has failed to read or write data.
Remove the card after turning this unit off. Insert the card again, turn this unit on, and try to read or write the data again.
- The card may be broken.
- Insert a different card.

[Motion recording was cancelled due to the limitation of the writing speed of the card]

- Depending on the [Rec Format] and [Rec Quality] of a motion picture, the speed class rating required for the card differs. 4K photo recording requires a card that meets a particular speed class rating. Use a card that meets the rating. For details, refer to “About motion picture/4K photo recording and speed class ratings” on [P26](#).
- If the recording stops even when you are using a card that meets the speed class rating, the data writing speed is too slow. We recommend making a backup and then format the card ([P27](#)).
Depending on the type of the card, recording may stop in the middle.

[This battery cannot be used]

- Use a genuine Panasonic battery. If this message is displayed even when a genuine Panasonic battery is used, contact the dealer or Panasonic.
- If the battery terminal is dirty, clean it and remove any objects.

[Failed to connect wireless access point]/[Connection failed]/[No destination found]

- The wireless access point information set on this unit is wrong.
Check the authentication type, encryption type, and encryption key. ([P282](#))
- Radio waves from other devices may block the connection to a wireless access point.
Check other devices that are connected to the wireless access point and devices that use the 2.4 GHz band.

[Connection failed. Please retry in a few minutes.]/[Network disconnected. Transfer stopped.]

- Radio waves from the wireless access point are getting weak.
Perform the connection closer to the wireless access point.
- Depending on the wireless access point, connection may be automatically disconnected after specific time has passed.
Reconnect the connection again.

[Connection failed]

- Change the access point to connect to in the smartphone Wi-Fi settings to this camera.

[Cannot connect to server]

- If a message is displaying asking to update the root certificate, agree to update the root certificate.

Troubleshooting

First, try out the following procedures ([P320](#) to [P328](#)).

If the problem is not resolved, it may be improved by selecting [Reset] ([P225](#)) on the [Setup] menu.

Battery and power source

When I shake the camera, I hear a rattling sound from the camera.

- The sound is caused by the In-Body Image Stabilizer. This is not a malfunction.



**The camera cannot be operated even when it is turned on.
The camera turns off immediately after it is turned on.**

- The battery is exhausted. Charge the battery. ([P19](#))

This unit is turned off automatically.

- [Economy] is enabled. ([P222](#))

The battery becomes flat too quickly.

- When [] ([4K Pre-Burst]) is set, the battery drains faster.
→ Select [] ([4K Pre-Burst]) only when recording.
- Is a Wi-Fi connection being used for a long period of time?
The battery can become flat quickly when connected to Wi-Fi.
→ Turn the camera off frequently by using the [Economy] etc. ([P222](#))

Recording

Taking pictures is not possible.

The shutter will not operate immediately when the shutter button is pressed.

- Is [Focus/Release Priority] in the [Custom] menu set to [FOCUS]? ([P211](#))
You cannot take a picture until the subject is brought into focus.

The recorded picture is whitish.

- Picture might look whitish when lens or image sensor gets dirty with fingerprints or similar.
 - If the lens is dirty turn the camera off and then gently wipe the lens surface with a soft, dry cloth.
 - Refer to [P330](#) when the image sensor gets dirty.

The recorded picture is too bright or dark.

- Is the AE Lock ([P105](#)) applied incorrectly?

Multiple pictures are taken at one time.

- Check the drive mode setting. ([P114](#))
- Are you using the bracket function? ([P141](#))

The subject is not focused properly.

- The subject is beyond the focus range of the camera.
- Is [Focus/Release Priority] in the [Custom] menu set to [RELEASE]? ([P211](#))
- Is [Shutter AF] in the [Custom] menu set to [OFF]? ([P209](#))
- Is the AF Lock ([P105](#)) applied incorrectly?

The recorded picture is blurred.**The Image Stabilizer is not effective.**

- The shutter speed will become slower and the Image Stabilizer function may not work properly when taking pictures especially in dark places.
 - We recommend using a tripod and the self-timer ([P135](#)) when taking pictures with a slow shutter speed.

The recorded picture looks rough.**Noise appears on the picture.**

- Try the following:
 - Decrease the ISO sensitivity. ([P108](#))
 - Increase the setting for [Noise Reduction] in [Photo Style] or lower the setting for each of the items other than [Noise Reduction]. ([P187](#))
 - Set the [Long Shtr NR] to [ON]. ([P200](#))

The subject appears distorted on the picture.

- If you record a moving subject when using the electronic shutter or recording motion picture or a 4K photo, the subject may appear distorted on the picture. This is characteristic of MOS sensors which serve as the camera's pickup sensors. This is not a malfunction.

Striping or flicker may appear under lighting such as fluorescent lighting and LED lighting fixture.

- This is characteristic of MOS sensors which serve as the camera's pickup sensors.
This is not a malfunction.
- When using the electronic shutter (P197), lowering the shutter speed may reduce the effect of the horizontal stripes.
- If noticeable flicker or striping is seen under lighting such as a fluorescent or LED lighting fixture when recording motion pictures, you can reduce the flicker or striping by setting up [Flkr Decrease] (P206) and fixing the shutter speed. It is possible to select a shutter speed from [1/50], [1/60], [1/100], or [1/120]. You can set the shutter speed manually in the Creative Video Mode. (P85)



Stripes appear in high ISO sensitivity.

- Stripes may appear in high ISO sensitivity or depending on the lens you use.
→ Decrease the ISO sensitivity. (P108)

The brightness or the hue of the recorded picture is different from the actual scene.

- When recording under fluorescent or LED lighting fixture, etc., increasing the shutter speed may introduce slight changes to brightness and color. These are a result of the characteristics of the light source and do not indicate a malfunction.
- When recording subjects in extremely bright locations or recording under fluorescent lighting, LED lighting fixture, mercury lamp, sodium lighting, etc., the colors and screen brightness may change or horizontal striping may appear on the screen.

Bright spot not in subject is recorded.

- There may be defective pixels in the image sensor.
→ Perform [Pixel Refresh] (P226).

4K photo recording stops before finishing.

- When the ambient temperature is high or 4K photo recording is performed continuously, the camera may display [⚠] and recording may stop. (If [🔥] ([4K Pre-Burst]) is selected, the setting changes to [🔥] ([4K Burst]) before recording stops.) Wait until the camera cools down.

Motion pictures

Recording motion pictures is not possible.

- You may not be able to record for a short while after turning this unit on when using a large capacity card.

Motion picture recording stops in the middle.

- When the ambient temperature is high or motion picture is recorded continuously, the camera may display [] and stop the recording to protect itself. Wait until the camera cools down.
- Depending on the [Rec Format] and [Rec Quality] of a motion picture, the speed class rating required for the card differs. Use a card that meets the rating. (“About motion picture/4K photo recording and speed class ratings” on [P26](#))

Sometimes it is difficult to focus with Auto Focus when recording 4K motion pictures.

- This phenomenon occurs when the camera is trying to record with highly accurate focus at a reduced Auto Focus speed, and is not a malfunction.

In motion pictures, abnormal clicking and buzzing sounds are recorded. The recorded sound is very quiet.

- With recording in a quiet environment, depending on the lenses used, the sound of aperture and focus actions may be recorded in motion pictures. Focus operation can be set to [OFF] in [Continuous AF] ([P168](#)).
- While recording motion pictures, plugging the aperture of the microphone with a finger may reduce the level of audio recording or audio may not record at all. Also be careful because the operation sound of lenses can easily be recorded at this time.

An operation sound is recorded in a motion picture.

- Use of [Silent Operation] is recommended if you are concerned about operational sounds. ([P86](#))

Flash

The flash is not activated.

- Is the flash closed? Open the flash. ([P154](#))
- When the electronic shutter is used, the flash is not activated. ([P197](#))
- When [Silent Mode] is set to [ON], the flash is not activated. ([P209](#))

Monitor/Viewfinder

The Monitor/Viewfinder turns off although the camera is turned on.

- If no operations are performed during the set time period, [Auto LVF/Monitor Off] (P222) is activated, and the Monitor/Viewfinder turns off.
- When an object or your hand is positioned near the eye sensor, the Monitor display may switch to the Viewfinder display. (P38)

It may flicker for an instant or the brightness of the screen may change significantly for an instant.

- This occurs due to the aperture of the lens changing when the shutter button is pressed halfway, or when the brightness of the subject changes. This is not a malfunction.

Monitor and viewfinder do not switch when [LVF] is pressed.

- It is only displayed on the monitor when the camera is connected to a PC or printer.

Unevenly bright parts or irregular colors appear on the Viewfinder.

- Viewfinder of this unit adopts OLED. Screen burn-in may occur on the screen/viewfinder when a same image is displayed for a long period of time, but it does not affect the recorded images.

The color tone of the viewfinder differs from the actual tone.



- Being a characteristic of the viewfinder of this unit, this phenomenon is not a problem. Recorded images are not affected.

Playback

The picture is not played back. There are no recorded pictures.

- Is the card inserted?
- Is this a folder or picture which was processed in the PC?
If it is, it cannot be played back by this unit.
→ It is recommended to use the software "PHOTOfunSTUDIO" (P295) to write pictures from PC to card.
- Has [Playback Mode] been set for playback?
→ Change to [Normal Play]. (P231)

Red part of the recorded image has changed color to black.

- When Red-Eye Removal ([] or []) is performed, red parts may be corrected to black.
→ It is recommended to take a pictures with the flash closed, Flash Mode set to [, or [Red-Eye Removal] set to [OFF]. (P198)

Wi-Fi function

**A Wi-Fi connection cannot be established.
Radio waves get disconnected.
Wireless access point is not displayed.**

■ General tips for using a Wi-Fi connection

- Use within the communication range of the device to be connected.
- Is any device, such as microwave oven, cordless phone, etc., that uses 2.4 GHz frequency operated nearby?
 - Radio waves may get interrupted when used simultaneously. Use them sufficiently away from the device.
- When the battery indicator is flashing red, the connection with other equipment may not start or the connection may be disrupted.
(A message such as [Communication error] is displayed.)
- If you place the camera on a metal table or shelf, the radio waves may be adversely affected. In such cases, you may not be able to establish a connection. Move the camera away from the metal surface.

■ About a wireless access point

- Check if the wireless access point to connect is in operating state.
- Check the radio wave condition of the wireless access point.
 - Move this unit closer to the wireless access point.
 - Change the location and orientation of the wireless access point.
- It may not display even if the radio waves exist depending on the setting of the wireless access point.
 - Turn off and on the wireless access point.
 - Check the settings of the wireless access point.
 - When the network SSID of the wireless access point is set not to broadcast, the wireless access point may not be detected. Enter the network SSID to start the connection (P282) or enable the SSID broadcast of the wireless access point.

This unit is not displayed in the Wi-Fi setting screen of the smartphone.

- From the Wi-Fi setting menu on the smartphone, turn off and then on the Wi-Fi function.

When I try to set up a Wi-Fi connection with a Windows 8 PC, my user name and password are not recognized, so I cannot connect to the PC.

- Some OS versions, including Windows 8, use two types of accounts: a local account and a Microsoft account.
Be sure to use the user name and password for the local account.

The PC is not recognized when I use a Wi-Fi connection. The camera cannot be connected to PC via Wi-Fi connection.

- The default workgroup name is set to "WORKGROUP". If you changed the workgroup name, the PC will not be recognized.
In [Change Workgroup Name] in [PC Connection] of the [Wi-Fi Setup] menu, change the workgroup name to that of the PC you are connecting to. (P286)
- Please confirm login name and password are correctly typed.
- When the system time of Mac computer or Windows PC connected to a camera differs severely from that of the camera, the camera cannot be connected to the computer or PC in some OSs.
→ Please confirm [Clock Set] and [World Time] of the camera matches with time, date and time zone in Windows PC or Mac computer. When both settings do not match severely, please match them.

Images cannot be transmitted to the web service.

- Confirm that the login information (login ID/user name/email address/password) is correct.

It takes time to transmit an image to the web service.**Transmission of the image fails midway. Some images cannot be transmitted.**

- Is the size of the image too large?
→ Reduce the image size at [Size] (P266), and then send.
→ Transmit after dividing the motion picture with [Video Divide] (P240).
- It may take longer time to transmit when distance to the wireless access point is far.
→ Transmit closer to the wireless access point.
- File format of the motion picture that can be sent differs depending on the destination. (P263)

I have forgotten the password for the Wi-Fi.

- Execute the [Reset Wi-Fi Settings] in the [Setup] menu. (P225)
However, all the information you have set on the [Wi-Fi Setup] menu will be reset. (excluding [LUMIX CLUB])

TV, PC and printer

The picture does not appear on the television.

- Is the camera connected to the TV correctly? (P290)
→ Set the TV input to external input mode.

VIERA Link does not work.

- Is the [VIERA Link] on this unit set to [ON]? (P224)
→ Check the VIERA Link setting on the connected device.
→ Turn this unit off and on.

Cannot communicate with the PC.

- Set to [PC] in [USB Mode]. (P223, 297)
- Turn this unit off and on.

The card is not recognized by the PC. (SDXC memory card is used.)

- Check if your PC is compatible with SDXC memory cards.
<http://panasonic.net/avc/sdcard/information/SDXC.html>
- A message prompting to format the card may be displayed when connecting, but do not format.
- If the [Access] displayed on the monitor does not disappear, disconnect the USB connection cable after turning this unit off.

The picture cannot be printed when the camera is connected to a printer.

- Pictures cannot be printed using a printer that does not support PictBridge.
→ Set to [PictBridge(PTP)] in [USB Mode]. (P223, 300)

The ends of the pictures are cut at printing.

- When using a printer with a Cropping or borderless printing function, cancel this function before printing.
(For details, refer to the operating instructions for the printer.)
- When you order photo studios to print pictures, ask the photo studio if the 16:9 pictures can be printed.

Others

When I shake the camera, I hear a rattling sound from the attached lens.

- Depending on the lens you attach, it may move inside and create a sound. This is not a malfunction.

The camera makes a noise when this unit is turned on.

- This is the noise of the Dust Reduction Function working (P330); it is not a malfunction.

There is a sound from lens unit.

- It is a sound of lens movement or aperture operation when this unit is turned on or off, and it is not a malfunction.
- The sound, which is caused by the automatic adjustment of the aperture, is heard when the brightness has changed due to, for example, zooming or the movement of the camera. This is not a malfunction.

An unreadable language was selected by mistake.

- Press [MENU/SET], select the [Setup] menu icon [🔧] and then select the [30] icon to set the desired language. (P224)

A red lamp sometimes turns on when the shutter button is pressed halfway.

- In dark places, the AF Assist Lamp (P210) lights red to make it easier to focus on a subject.

The camera becomes warm.

- The surface of the camera and the reverse side of the monitor may become warm during use. This does not affect the performance or quality of the camera.

The clock is reset.

- If you do not use the camera for a long time, the clock may be reset.
→ [Please set the clock] message will be displayed; please reset the clock. (P34)

Cautions for Use

Optimal use of the camera

Keep this unit as far away as possible from electromagnetic equipment (such as microwave ovens, TVs, video games etc.).

- If you use this unit on top of or near a TV, the pictures and/or sound on this unit may be disrupted by electromagnetic wave radiation.
- Do not use this unit near cell phones because doing so may result in noise adversely affecting the pictures and/or sound.
- Recorded data may be damaged, or pictures may be distorted, by strong magnetic fields created by speakers or large motors.
- Electromagnetic wave radiation may adversely affect this unit, disturbing the pictures and/or sound.
- If this unit is adversely affected by electromagnetic equipment and stops functioning properly, turn this unit off and remove the battery or disconnect AC adaptor (optional). Then reinsert the battery or reconnect AC adaptor and turn this unit on.

Do not use this unit near radio transmitters or high-voltage lines.

- If you record near radio transmitters or high-voltage lines, the recorded pictures and/or sound may be adversely affected.

Always use the supplied cords and cables.

**If you use optional accessories, use the cords and the cables supplied with them.
Do not extend the cords or the cables.**

Do not spray the camera with insecticides or volatile chemicals.

- If the camera is sprayed with such chemicals, the body of the camera may be damaged and the surface finish may peel off.

Do not keep rubber or plastic products in contact with the camera for a long period of time.

Cleaning

Before cleaning the camera, remove the battery or the DC coupler (optional), or disconnect the power plug from the outlet. Then wipe the camera with a dry, soft cloth.

- When the camera is soiled badly, it can be cleaned by wiping the dirt off with a wrung wet cloth, and then with a dry cloth.
- Do not use solvents such as benzene, thinner, alcohol, kitchen detergents, etc., to clean the camera, since it may deteriorate the external case or the coating may peel off.
- When using a chemical cloth, be sure to follow the accompanying instructions.

■ About dirt on the image sensor

This camera features an interchangeable lens system so dirt may get inside the camera body when changing lenses. Depending on the recording conditions, dirt on the image sensor may appear on the recorded picture.

To prevent debris or dust adhering to internal parts of the body, avoid changing the lens in a dusty environment and always fit the body cap or a lens when storing the camera. Remove any dirt on the body cap before attaching it.

Dust reduction function

This unit has a dust reduction function that will blow off the debris and dust that have affixed to the front of the imaging device.

This function will function automatically when the camera is turned on, but if you see dust, perform the [Sensor Cleaning] (P226) in the [Setup] menu.

Removing dirt on the image sensor

The image sensor is very precise and delicate, so be sure to observe the following when you do have to clean it yourself.

- Blow off the dust on the surface of the image sensor with a commercially available blower brush. Be careful not to blow too strongly.
- Do not put the blower brush further inside than the lens mount.
- Do not let the blower brush touch the image sensor as the image sensor may get scratched.
- Do not use any objects except a blower brush to clean the image sensor.
- If you cannot remove the dirt or dust with the blower, consult the dealer or Panasonic.

■ For care of the viewfinder/Eyecup

- As the eye cup cannot be removed, blow away the dust on the viewfinder surface with a blower (commercially available), gently wipe it with a dry and soft cloth, and be careful not to remove it.
- If you wipe the eye cup too hard and it is removed, consult the dealer or Panasonic.

About the Monitor/Viewfinder

- Do not press the monitor with excessive force. Uneven colors may appear on the monitor and it may malfunction.
- If the camera is cold when you turn it on, the picture on the Monitor/Viewfinder will be slightly darker than usual at first. However, the picture will return to normal brightness when the internal temperature of the camera increases.

Extremely high precision technology is employed to produce the Monitor/Viewfinder screen. However there may be some dark or bright spots (red, blue or green) on the screen. This is not a malfunction. Though the Monitor/Viewfinder screen parts are produced with highly controlled precision technology, some pixels may be inactive or always lit. The spots will not be recorded on pictures on a card.

About the Lens

- Do not press the lens with excessive force.
- Do not leave the camera with the lens facing the sun as rays of light from the sun may cause it to malfunction. Also, be careful when placing the camera outside or near a window.
- When there is dirt (water, oil, and fingerprints, etc.) on the surface of the lens, the picture may be affected. Lightly wipe the surface of the lens with a soft, dry cloth before and after taking pictures.
- To prevent dust and other particles from accumulating on or entering the lens, attach the lens rear cap when the lens is not in use.
- To protect the lens contact points (A), do not place the lens with its mount surface facing down. In addition, do not allow the lens contact points to become dirty.
- To improve the dust- and splash-proof performance, the mount of the interchangeable lens (H-FS12060) is embedded with the lens mount rubber. If you change the lens repeatedly, friction with the lens mount rubber may leave scratches on the camera's mount. However, those scratches do not affect the performance of this unit. For the replacement of the lens mount rubber, contact Panasonic.

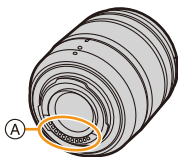

Battery

The battery is a rechargeable lithium ion battery. Its ability to generate power comes from the chemical reaction that takes place inside it. This reaction is susceptible to the surrounding temperature and humidity. If the temperature is too high or too low, the operating time of the battery will become shorter.

Always remove the battery after use.

- Place the removed battery in a plastic bag, and store or keep away from metallic objects (clips, etc.).

If you drop the battery accidentally, check to see if the body of the battery and the terminals are damaged.

- Inserting a damaged battery in the camera will damage the camera.

Bring charged spare batteries when going out.

- Be aware that the operating time of the battery becomes shorter in low temperature conditions such as at a ski resort.
- When you travel, do not forget to bring the battery charger (supplied) so that you can charge the battery in the country that you are traveling in.

Dispose of unusable battery.

- The battery has a limited life.
- Do not throw the battery into fire because it may cause an explosion.
- The unusable battery should be discarded in accordance with battery recycling laws. Call the RBRC hotline at 1-800-822-8837 for information.

Do not allow battery terminals to come into contact with metal objects (such as necklaces, hairpins, etc.).

- This can cause short-circuiting or heat generation and you may be badly burned if you touch a battery.

Charger

- The [CHARGE] indicator may blink under the influence of static electricity or electromagnetic wave. This phenomenon has no effects on charging.
- If you use the battery charger near a radio, the radio reception may be disturbed. Keep the charger 1 m (3.3 feet) or more away from radio.
- The charger may generate whirring sounds when it is being used. This is not a malfunction.
- After use, be sure to disconnect the power supply device from the electrical outlet. (A very small amount of current is consumed if it is left connected.)
- Keep the terminals of the charger and battery clean.

About 3D

■ About 3D recording

With the 3D interchangeable lens attached, do not record a subject at less than the minimum focus distance.

- The 3D effects may be more pronounced, and therefore cause tiredness or discomfort.
- When the 3D interchangeable lens (H-FT012: optional) is used, the minimum focus distance is 0.6 m (2.0 feet).

When recording with the 3D interchangeable lens attached, be careful not to shake the unit.

- Tiredness or discomfort may result if the shake is pronounced, due to riding in a vehicle or walking etc.
- We recommend using a tripod.

Card

Do not leave the card where the temperature is high, where electromagnetic waves or static electricity are easily generated or exposed to direct sunlight.

Do not bend or drop the card.

- The card may be damaged or the recorded content may be damaged or deleted.
- Put the card in the card case or the storage bag after use and when storing or carrying the card.
- Do not allow dirt, dust, or water to get into the terminals on the back of the card and do not touch the terminals with your fingers.

Notice for when transferring to another party, or disposing of the memory card
“Format” or “delete” using the camera or a PC will only modify the file management information, it will not erase the data in the memory card completely.
It is recommended to physically destroy the memory card or use the commercially available computer data deletion software to completely erase the data in the memory card before transferring to another party or disposing.
Management of data in the memory card is the responsibility of the user.

About the personal information

If a name or birthday is set for [Profile Setup]/Face Recognition function, this personal information is kept in the camera and recorded in the image.

We recommend that you enable [Wi-Fi Password] and [Wi-Fi Function Lock] to protect personal information. (P286 , 287)

Disclaimer

- Information including personal information may be altered or vanish due to erroneous operation, effect of static electricity, accident, malfunction, repair, or other handlings. Please note in advance that Panasonic is not liable in any way for any direct or indirect damage from the alteration or vanishing of information or personal information.

When requesting a repair, transferring to another party, or disposing.

- After making a copy of personal information, always delete information such as personal information and wireless LAN connection settings that you have saved within the camera with [Reset Wi-Fi Settings]/[Delete account] (P225, 279).
- Reset the settings to protect the personal information. (P225)
- Remove the memory card from the camera when requesting a repair.
- Settings may return to factory default when camera is repaired.
- Please contact the dealer where you purchased the camera or Panasonic if above operations are not possible due to malfunction.

When transferring to another party, or disposing of the memory card, please refer to “Notice for when transferring to another party, or disposing of the memory card”.
(P333)

When uploading images on web services

- Images may contain information that can be used for identifying individuals such as titles, recording dates, and location information. When uploading images on web services, check carefully, and then upload.

When not using the camera for a long period of time

- Store the battery in a cool and dry place with a relatively stable temperature: [Recommended temperature: 15 °C to 25 °C (59 °F to 77 °F), Recommended humidity: 40%RH to 60%RH]
- Always remove the battery and the card from the camera.
- If the battery is left inserted in the camera, it will discharge even if the camera is turned off. If the battery continues to be left in the camera, it will discharge excessively and may become unusable even if charged.
- When storing the battery for a long period of time, we recommend charging it once a year. Remove the battery from the camera and store it again after it has completely discharged.
- We recommend storing the camera with a desiccant (silica gel) when you keep it in a closet or a cabinet.
- Check all the parts before taking pictures when you have not used the camera for a long period of time.

About the picture data

- Recorded data may be damaged or lost if the camera breaks down due to inappropriate handling. Panasonic will not be liable for any damage caused due to loss of recorded data.

About tripods or unipods

- When you use a tripod, make sure the tripod is stable when this unit is attached to it.
- You may not be able to remove the card or the battery when using a tripod or unipod.
- Make sure that the screw on the tripod or unipod is not at an angle when attaching or detaching the camera. You may damage the screw on the camera if you use excessive force when turning it. Also, the camera body and the rating label may be damaged or scratched if the camera is attached too tightly to the tripod or unipod.
- When using this unit with a large-diameter lens, the lens may come into contact with the pedestal depending on the tripod/unipod. Tightening the screw with the lens and pedestal in contact with each other may damage this unit or the lens. Therefore it is recommended to attach the tripod adaptor (DMW-TA1: optional) before mounting on the tripod/unipod.
- Read the operating instructions for the tripod or unipod carefully.

About the shoulder strap

- If you attach a heavy interchangeable lens (more than about 1 kg/35.3 oz) to the camera body, do not carry the camera by the shoulder strap.
Hold the camera and the lens when carrying them.

Wi-Fi function

■ Use the camera as a wireless LAN device

When using equipment or computer systems that require more reliable security than wireless LAN devices, ensure that the appropriate measures are taken for safety designs and defects for the systems used. Panasonic will not take any responsibility for any damage that arises when using the camera for any purpose other than as a wireless LAN device.

■ Use of the Wi-Fi function of this camera is presumed to be in countries where this camera is sold

There is the risk that the camera violates the radiowave regulations if used in countries other than those where this camera is sold, and Panasonic takes no responsibility for any violations.

■ There is the risk that data sent and received via radio waves may be intercepted

Please note that there is the risk that data sent and received via radio waves may be intercepted by a third party.

■ **Do not use the camera in areas with magnetic fields, static electricity or interference**

- Do not use the camera in areas with magnetic fields, static electricity or interference, such as near microwave ovens. These may cause the interruption of the radio waves.
- Using the camera near devices such as microwave ovens or cordless telephones that use the 2.4 GHz radio wave band may cause a decrease in performance in both devices.

■ **Do not connect to the wireless network you are not authorized to use**

When the camera utilizes its Wi-Fi function, wireless networks will be searched automatically. When this happens, wireless networks that you are not authorized to use (SSID*) may be displayed, however do not attempt to connect to the network as it may be considered as unauthorized access.

- * SSID refers to the name that is used to identify a network over a wireless LAN connection. If the SSID matches for both devices, transmission is possible.



MENU



- G MICRO SYSTEM is a lens exchange type digital camera system of LUMIX based on a Micro Four Thirds System standard.
- Micro Four Thirds™ and Micro Four Thirds Logo marks are trademarks or registered trademarks of Olympus Imaging Corporation, in Japan, the United States, the European Union and other countries.
- Four Thirds™ and Four Thirds Logo marks are trademarks or registered trademarks of Olympus Imaging Corporation, in Japan, the United States, the European Union and other countries.
- SDXC Logo is a trademark of SD-3C, LLC.
- "AVCHD", "AVCHD Progressive" and the "AVCHD Progressive" logo are trademarks of Panasonic Corporation and Sony Corporation.
- Manufactured under license from Dolby Laboratories. Dolby and the double-D symbol are trademarks of Dolby Laboratories.
- The terms HDMI and HDMI High-Definition Multimedia Interface, and the HDMI Logo are trademarks or registered trademarks of HDMI Licensing, LLC in the United States and other countries.
- HDAVI Control™ is a trademark of Panasonic Corporation.
- Adobe is a trademark or registered trademark of Adobe Systems Incorporated in the United States and/or other countries.
- Pentium is a trademark of Intel Corporation in the U.S. and/or other countries.
- iMovie, Mac and Mac OS are trademarks of Apple Inc., registered in the U.S. and other countries.
- iPad, iPhone, iPod, and iPod touch are trademarks of Apple Inc., registered in the U.S. and other countries.
- App Store is a service mark of Apple Inc.
- Windows is a registered trademark or trademark of Microsoft Corporation in the United States and/or other countries.



- Android and Google Play are trademarks or registered trademarks of Google Inc.
- The Wi-Fi CERTIFIED™ Logo is a certification mark of Wi-Fi Alliance®.
- The Wi-Fi Protected Setup™ Identifier mark is a certification mark of Wi-Fi Alliance®.
- “Wi-Fi®” and “Wi-Fi Direct®” are registered trademarks of Wi-Fi Alliance®.
- “Wi-Fi Protected Setup™”, “WPA™”, and “WPA2™” are trademarks of Wi-Fi Alliance®.
- DLNA, the DLNA Logo and DLNA CERTIFIED are trademarks, service marks, or certification marks of the Digital Living Network Alliance.
- This product uses “DynaFont” from DynaComware Corporation. DynaFont is a registered trademark of DynaComware Taiwan Inc.
- QR Code is a registered trademark of DENSO WAVE INCORPORATED.
- Other names of systems and products mentioned in these instructions are usually the registered trademarks or trademarks of the manufacturers who developed the system or product concerned.



This product is licensed under the AVC Patent Portfolio License for the personal use of a consumer or other uses in which it does not receive remuneration to (i) encode video in compliance with the AVC Standard (“AVC Video”) and/or (ii) decode AVC Video that was encoded by a consumer engaged in a personal activity and/or was obtained from a video provider licensed to provide AVC Video. No license is granted or shall be implied for any other use. Additional information may be obtained from MPEG LA, L.L.C.

See <http://www.mpegla.com>