

Panasonic®

Basic Owner's Manual

Digital Camera/
Lens Kit/Body

Model No. **DMC-G5X/DMC-G5K**
DMC-G5

LUMIX



Before connecting, operating or adjusting this product,
please read the instructions completely.



More detailed instructions
on the operation of this
camera are contained in
“Owner’s Manual for advanced features
(PDF format)” in the supplied CD-ROM.
Install it on your PC to read it.



Register online at www.panasonic.com/register (U.S. customers only)

For USA and Puerto Rico assistance, please call: 1-800-211-PANA(7262) or,
contact us via the web at: <http://www.panasonic.com/contactinfo>

VQT4G94

F0612SM0

Dear Customer,

Thank you for choosing Panasonic!

You have purchased one of the most sophisticated and reliable products on the market today. Used properly, we're sure it will bring you and your family years of enjoyment. Please take time to fill in the information below. The serial number is on the tag located on the underside of your camera. Be sure to **retain this manual** as your convenient camera information source.

Date of Purchase

Dealer Phone No.

Dealer Purchased From

Model No.

Dealer Address

Serial No.

Please note that the actual controls and components, menu items, etc. of your Digital Camera may look somewhat different from those shown in the illustrations in this Owner's Manual.

Carefully observe copyright laws.

- Recording of pre-recorded tapes or discs or other published or broadcast material for purposes other than your own private use may infringe copyright laws. Even for the purpose of private use, recording of certain material may be restricted.



A lithium ion battery that is recyclable powers the product you have purchased. Please call 1-800-8-BATTERY for information on how to recycle this battery.

Information for Your Safety

WARNING:

To reduce the risk of fire, electric shock or product damage,

- Do not expose this unit to rain, moisture, dripping or splashing.
- Use only the recommended accessories.
- Do not remove covers.
- Do not repair this unit by yourself. Refer servicing to qualified service personnel.

The socket outlet shall be installed near the equipment and shall be easily accessible.

■ Product identification marking

Product	Location
Digital Camera	Bottom
Battery charger	Bottom

THE FOLLOWING APPLIES ONLY IN THE U.S.A.

FCC Note:

This equipment has been tested and found to comply with the limits for a Class B digital device, pursuant to Part 15 of the FCC Rules. These limits are designed to provide reasonable protection against harmful interference in a residential installation. This equipment generates, uses, and can radiate radio frequency energy and, if not installed and used in accordance with the instructions, may cause harmful interference to radio communications. However, there is no guarantee that interference will not occur in a particular installation. If this equipment does cause harmful interference to radio or television reception, which can be determined by turning the equipment off and on, the user is encouraged to try to correct the interference by one or more of the following measures:

- Reorient or relocate the receiving antenna.
- Increase the separation between the equipment and receiver.
- Connect the equipment into an outlet on a circuit different from that to which the receiver is connected.
- Consult the dealer or an experienced radio/TV technician for help.

FCC Caution: To assure continued compliance, follow the attached installation instructions and use only shielded interface cables with ferrite core when connecting to computer or peripheral devices.

Any changes or modifications not expressly approved by the party responsible for compliance could void the user's authority to operate this equipment.

Declaration of Conformity

Trade Name: Panasonic

Model No.: DMC-G5

Responsible party: Panasonic Corporation of North America
One Panasonic Way, Secaucus, NJ 07094

Support Contact: Panasonic Consumer Marketing Company of North America
1-800-211-PANA (7262)

This device complies with Part 15 of the FCC Rules. Operation is subject to the following two conditions: (1) This device may not cause harmful interference, and (2) this device must accept any interference received, including interference that may cause undesired operation.



■ About the battery pack

CAUTION

Battery pack (Lithium ion battery pack)

- Use the specified unit to recharge the battery pack.
- Do not use the battery pack with equipment other than the specified unit.
- Do not get dirt, sand, liquids, or other foreign matter on the terminals.
- Do not touch the plug terminals (+ and -) with metal objects.
- Do not disassemble, remodel, heat or throw into fire.

If any electrolyte should come into contact with your hands or clothes, wash it off thoroughly with water.

If any electrolyte should come into contact with your eyes, never rub the eyes. Rinse eyes thoroughly with water, and then consult a doctor.

CAUTION

- Danger of explosion if battery is incorrectly replaced. Replace only with the type recommended by the manufacturer.
- When disposing the batteries, please contact your local authorities or dealer and ask for the correct method of disposal.

- Do not heat or expose to flame.
- Do not leave the battery(ies) in a car exposed to direct sunlight for a long period of time with doors and windows closed.

Warning

Risk of fire, explosion and burns. Do not disassemble, heat above 60 °C (140 °F) or incinerate.

■ About the battery charger

CAUTION!

To reduce the risk of fire, electric shock or product damage,

- **Do not install or place this unit in a bookcase, built-in cabinet or in another confined space. Ensure this unit is well ventilated.**

Battery charger

This battery charger operates on AC between 110 V and 240 V.

But

- In the U.S.A. and Canada, the battery charger must be connected to a 120 V AC power supply only.
- When connecting to an AC supply outside of the U.S.A. or Canada, use a plug adaptor to suit the AC outlet configuration.

■ Cautions for Use

- Do not use any other USB connection cables except the supplied one or a genuine Panasonic USB connection cable (DMW-USBC1: optional).
- Always use a genuine Panasonic HDMI mini cable (RP-CDHM15, RP-CDHM30: optional).
Part numbers: RP-CDHM15 (1.5 m) (5 feet), RP-CDHM30 (3.0 m) (10 feet)
- Always use a genuine Panasonic AV cable (DMW-AVC1: optional).
- Always use a genuine Panasonic remote shutter (DMW-RSL1: optional).

Keep this unit as far away as possible from electromagnetic equipment (such as microwave ovens, TVs, video games etc.).

- If you use this unit on top of or near a TV, the pictures and/or sound on this unit may be disrupted by electromagnetic wave radiation.
- Do not use this unit near cell phones because doing so may result in noise adversely affecting the pictures and/or sound.
- Recorded data may be damaged, or pictures may be distorted, by strong magnetic fields created by speakers or large motors.
- Electromagnetic wave radiation generated by microprocessors may adversely affect this unit, disturbing the pictures and/or sound.
- If this unit is adversely affected by electromagnetic equipment and stops functioning properly, turn this unit off and remove the battery or disconnect AC adaptor (DMW-AC8PP: optional). Then reinsert the battery or reconnect AC adaptor and turn this unit on.

Do not use this unit near radio transmitters or high-voltage lines.

- If you record near radio transmitters or high-voltage lines, the recorded pictures and/or sound may be adversely affected.

Information about the software used by this product can be viewed by pressing [MENU/SET], selecting [Setup] → [Version Disp.], and then pressing [MENU/SET].

-If you see this symbol-

Information on Disposal in other Countries outside the European Union

This symbol is only valid in the European Union.
If you wish to discard this product, please contact your local authorities or dealer and ask for the correct method of disposal.



Contents

Information for Your Safety	2
Care of the camera	7
Standard Accessories	8
Names and Functions of Components	10
Changing the Lens	13
Attaching the Shoulder Strap	14
Charging the Battery	15
• Charging	15
Inserting and Removing the Card (optional)/the Battery	16
About the Card	17
• About cards that can be used with this unit	17
Setting Date/Time (Clock Set)	18
• Changing the Clock Setting	18
Selecting the Recording Mode	19
Taking a Still picture	20
• Taking pictures using the Touch Shutter function	20
Taking Pictures using the Automatic Function (Intelligent Auto Mode)	21
Recording using Intelligent Auto Plus Mode	22
Taking Pictures with Defocus Control Function	23
Recording Motion Picture	24
• Recording still pictures while recording motion pictures	24
Compensating the Exposure	25
Using the function button	26
Taking Pictures that match the Scene being recorded (Scene Guide Mode)	27
Taking Pictures with different image effects (Creative Control Mode)	28
Playing Back Pictures/Motion Pictures	29
• Playing Back Pictures	29
• Playing Back Motion Pictures	29
Deleting Pictures	30
Switching the display of the LCD Monitor	31
Setting the Menu	32
Setting the Quick Menu	33
Types of menus	34
Reading the Owner's Manual (PDF format)	40
About the supplied software	41
• Installing supplied software	42
Specifications	43
Digital Camera Accessory System	49
Digital Camera Accessory Order Form (For USA and Puerto Rico Customers)	51
Limited Warranty (ONLY FOR U.S.A. AND PUERTO RICO)	52
Useful Information (For Latin American Countries Only)	55

Care of the camera

Do not subject to strong vibration, shock, or pressure.

- The lens, LCD monitor, or external case may be damaged if used in the following conditions.

It may also malfunction or image may not record if you:

- Drop or hit the camera.
- Press hard on the lens or the LCD monitor.

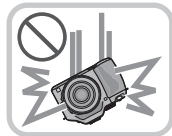

This camera is not dust/drip/water proof.

Avoid using the camera in places with a lot of dust, water, sand, etc.

- Liquid, sand and other foreign material may get into the space around the lens, buttons, etc. Be particularly careful since it may not just cause malfunctions, but it may also become irreparable.
 - Places with a lot of sand or dust.
 - Places where water can come into contact with this unit, such as when using it on a rainy day or at the beach.



Do not place your hands inside the mount of the digital camera body. Since the sensor unit is a precision apparatus, it may cause a malfunction or damage.

■ About Condensation (When the lens, the viewfinder or LCD Monitor is fogged up)

- Condensation occurs when the ambient temperature or humidity changes. Be careful of condensation since it causes lens and LCD monitor stains, fungus and camera malfunction.
- If condensation occurs, turn the camera off and leave it for about 2 hours. The fog will disappear naturally when the temperature of the camera becomes close to the ambient temperature.

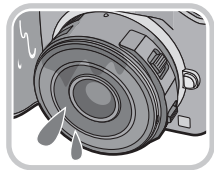

Standard Accessories

Check that all the accessories are supplied before using the camera.
Product numbers correct as of August 2012. These may be subject to change.

Digital Camera Body

(This is referred to as **camera body** in this Owner's Manual.)

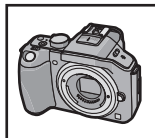

(○: Included, —: Not included)

	DMC-G5X	DMC-G5K	DMC-G5
1 Interchangeable Lens*1	○ (H-PS14042)	○ (H-FS014042)	—
2 Lens Hood	—	○	—
3 Lens Cap	○*2	○*2	—
4 Lens Rear Cap	○*2	○*2	—
5 Body Cap	○*3	○*3	○*3

6 Battery Pack

(Indicated as **battery pack** or **battery** in the text)

Charge the battery before use.

7 Battery Charger

(Indicated as **battery charger** or **charger** in the text)

8 USB Connection Cable

9 CD-ROM

- Software:

Use it to install the software to your PC.

10 CD-ROM

- Owner's Manual for advanced features:

Use it to install to your PC.

11 Shoulder Strap

*1 This is referred to as **lens** in this Owner's Manual.

*2 This is attached to the interchangeable lens at the time of purchase.











*3 This is attached to the camera body at the time of purchase.







- SD Memory Card, SDHC Memory Card and SDXC Memory Card are indicated as **card** in the text.

- **The card is optional.**

- Description in this Owner's Manual is based on the interchangeable lens (H-PS14042).

- If any accessories are lost, customers in the USA and Puerto Rico should contact Panasonic's parts department at 1-800-833-9626 for further information about obtaining replacement parts.

	DMC-G5X	DMC-G5K	DMC-G5
1	 H-PS14042	 H-FS014042	—
2	—	 VYC1009	—
3	 VYF3443	 VYF3201	—
4	 VFC4605	 VFC4315	—
5	 VKF4971	 VKF4971	 VKF4971

6	 DMW-BLC12PP	11	 VFC4765
7	 DE-A79B		
8	 K1HY08YY0025		
9			
10	 VFF1026		

Names and Functions of Components

■ Camera body

- 1 Self-timer indicator/
AF Assist Lamp
- 2 Sensor
- 3 Flash
- 4 Lens fitting mark
- 5 Mount
- 6 Lens lock pin
- 7 Lens release button

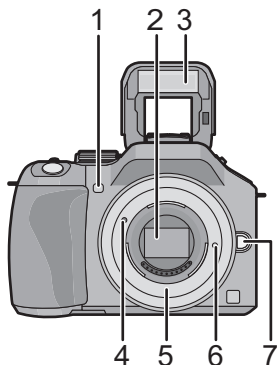

- 8 [LVF/LCD] button/
[Fn3] button
- 9 Diopter adjustment dial
- 10 Viewfinder
- 11 Eye Cup
- 12 Eye sensor
 - When [LVF/LCD Auto] of [Eye Sensor] in the [Custom] menu is set to [ON] and your eye or an object is brought close to the viewfinder, the display automatically switches to the viewfinder display.

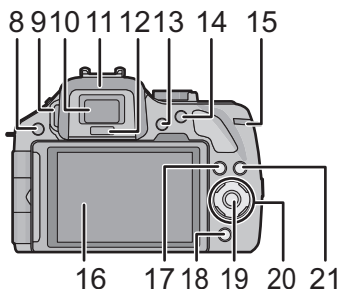

- 13 [Q.MENU] button
- 14 [AF/AE LOCK] button/
[Fn1] button
- 15 Rear dial
- 16 Touch screen/LCD monitor
- 17 Playback button
- 18 / button/
[Fn2] button
- 19 [MENU/SET] button
- 20 Cursor buttons
 - ▲/ISO button
 - ▶/WB (White Balance)
 - ◀/AF Mode button
 - ▼/[Drive Mode] button

This button in picture record mode will allow the user to select between the following options.

Single/Burst/Auto bracket/Self-timer

- 21 [DISP.] button

- 22 Focus distance reference mark
- 23 Flash open lever
- 24 Stereo microphone
 - Be careful not to cover the microphone with your finger. Doing so may make sound difficult to record.
- 25 Hot shoe
- 26 Mode dial
- 27 Shutter button
- 28 Function lever
- 29 Speaker
 - Be careful not to cover the speaker with your finger. Doing so may make sound difficult to hear.

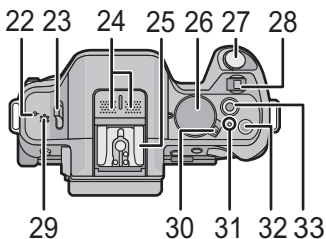

- 30 Camera ON/OFF switch
- 31 Status indicator
- 32 Intelligent Auto button
- 33 Motion picture button
- 34 Tripod mount
 - A tripod with a screw length of 5.5 mm (0.22 inch) or more may damage this unit if attached.
- 35 Card/Battery door
- 36 Release lever

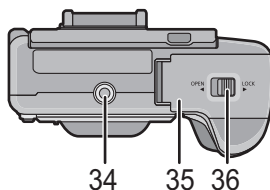

- 37 Shoulder strap eyelet
 - Be sure to attach the shoulder strap when using the camera to ensure that you will not drop it.
- 38 [REMOTE] socket
- 39 [HDMI] socket
- 40 [AV OUT/DIGITAL] socket
- 41 DC coupler cover

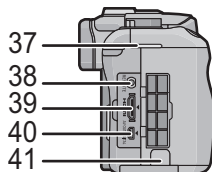

- When using an AC adaptor, ensure that the Panasonic DC coupler (DMW-DCC8: optional) and AC adaptor (DMW-AC8PP: optional) are used.
- Always use a genuine Panasonic AC adaptor (DMW-AC8PP: optional).
- It is recommended to use a fully charged battery or AC adaptor when recording motion pictures.
- If while recording motion pictures using the AC adaptor and the power supply is cut off due to a power outage or if the AC adaptor is disconnected etc., the motion picture will not be recorded.

■ Lens

H-PS14042

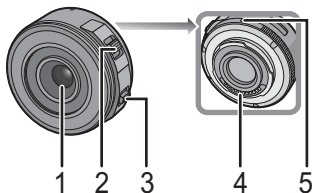

H-FS014042

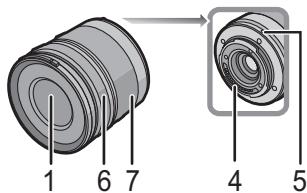

- 1 Lens surface
- 2 Zoom lever
- 3 Focus lever
- 4 Contact point
- 5 Lens fitting mark
- 6 Focus ring
- 7 Zoom ring

Touch screen

This touch screen is a type that detects pressure.

Touch the screen

To touch and release the touch screen.

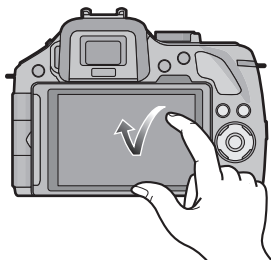

Use this to perform tasks such as selecting icons or images displayed on the touch screen.

- When selecting features using the touch screen, be sure to touch the center of the desired icon.

Drag

A movement without releasing the touch screen.

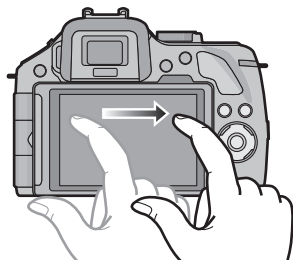

This is used to move the AF area, operate the slide bar, etc.

This can also be used to move to the next image during playback, etc.

Changing the Lens

- Check that the camera is turned off.

Attaching the lens

Preparations: Remove the lens rear cap from the lens, and the body cap from the camera.

Align the lens fitting marks (A) (red marks) and then rotate the lens in the direction of the arrow until it clicks.

- Do not press the lens release button (B) when you attach a lens.

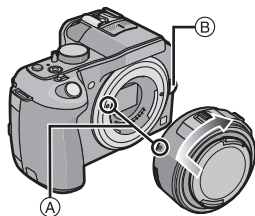

Detaching the lens

Preparations: Attach the lens cap.

While pressing on the lens release button (B), rotate the lens toward the arrow until it stops and then remove.

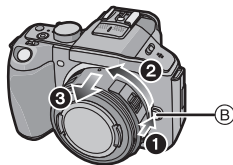

Attaching the Shoulder Strap

- We recommend attaching the shoulder strap when using the camera to prevent it from dropping.

- 1** Pass the shoulder strap through the shoulder strap eyelet on the camera body.

(A): Shoulder strap eyelet

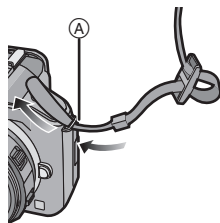

- 2** Pass the end of the shoulder strap through the ring in the direction of the arrow and then pass it through the stopper.

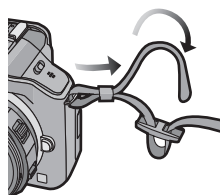

- 3** Pass the end of the shoulder strap through the hole on the other side of the stopper.

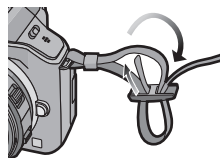

- 4** Pull the other side of the shoulder strap and then check that it will not come out.

- Perform steps **1** to **4** and then attach the other side of the shoulder strap.

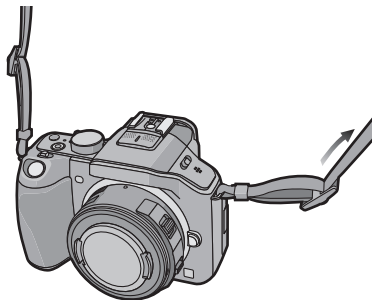

Charging the Battery

■ About batteries that you can use with this unit

The battery that can be used with this unit is DMW-BLC12PP.

Charging

- The battery is not charged when the camera is shipped. Charge the battery before use.
- Charge the battery with the charger indoors.

- 1 Attach the battery paying attention to the direction of the battery.**

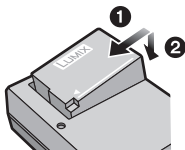

- 2 Connect the charger to the electrical outlet.**

- The [CHARGE] indicator (A) lights up and charging begins.

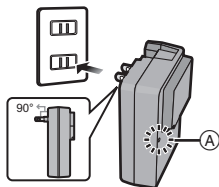

■ About the [CHARGE] indicator

The [CHARGE] indicator turns on:

The [CHARGE] indicator is turned on during charging.

The [CHARGE] indicator turns off:

The [CHARGE] indicator will turn off once the charging has completed without any problem. (Disconnect the charger from the electrical socket and detach the battery after charging is completed.)

■ Charging time

Charging time	Approx. 140 min
• The indicated charging time is for when the battery has been discharged completely. The charging time may vary depending on how the battery has been used. The charging time for the battery in hot/cold environments or a battery that has not been used for a long time may be longer than normal.	

Inserting and Removing the Card (optional)/ the Battery

- Check that this unit is turned off.
- We recommend using a Panasonic card.

1 Slide the release lever in the direction of the arrow and open the card/battery door.

- Always use genuine Panasonic batteries (DMW-BLC12PP).
- If you use other batteries, we cannot guarantee the quality of this product.

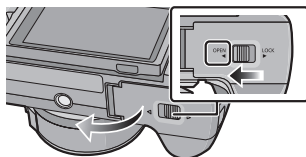

2 **Battery:** Being careful about the battery orientation, insert all the way until you hear a locking sound and then check that it is locked by lever (A).

Card: Push it securely all the way until you hear a “click” while being careful about the direction in which you insert it.

To remove the card, push the card until it clicks, then pull the card out upright.

To remove the battery, push the battery until it clicks, then pull the battery out upright.

(A): Do not touch the connection terminals of the card.

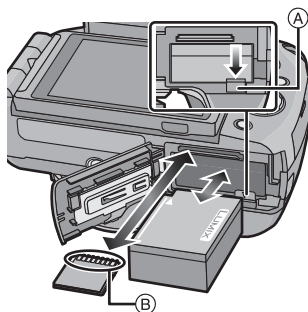

3 **1:** Close the card/battery door.

2: Slide the release lever in the direction of the arrow.

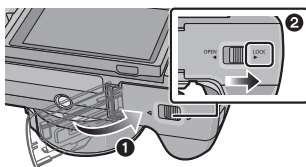

About the Card

About cards that can be used with this unit

The following cards which conform to the SD video standard can be used with this unit. (These cards are indicated as **card** in the text.)

	Remarks
SD Memory Card (8 MB to 2 GB)	<ul style="list-style-type: none">• Use a card with SD Speed Class* with “Class 4” or higher when recording motion pictures.• SDHC Memory Card can be used with SDHC Memory Card or SDXC Memory Card compatible equipment.• SDXC Memory Card can only be used with SDXC Memory Card compatible equipment.• Check that the PC and other equipment are compatible when using the SDXC Memory Cards. http://panasonic.net/avc/sdcard/information/SDXC.html• This unit is compatible with UHS-I standard SDHC/SDXC memory cards.• Only the cards with capacity listed left can be used.
SDHC Memory Card (4 GB to 32 GB)	
SDXC Memory Card (48 GB, 64 GB)	

* SD Speed Class is the speed standard regarding continuous writing. Check via the label on the card, etc.

e.g.:

CLASS 



• Please confirm the latest information on the following website.

<http://panasonic.jp/support/global/cs/dsc/>

(This Site is English only.)

Note

• Keep the Memory Card out of reach of children to prevent swallowing.

Setting Date/Time (Clock Set)

- The clock is not set when the camera is shipped.

1 Turn the camera on.

- The status indicator **1** lights when you turn this unit on.

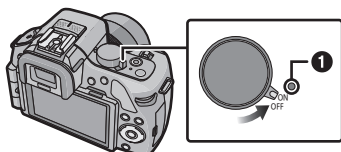

2 Touch [Clock Set].



3 Touch the items you wish to set (Year/Month/Day/Hours/Minutes), and set using [▲]/[▼].

- You can continue to switch the settings by continuously touching [▲]/[▼].
- Touch [] to cancel the date and time settings without setting a date and time.



To set the display order and the time display format.

- Touch [Style] to display the settings screen for setting display order/time display format.



4 Touch [Set] to set.

5 Touch [Set] in the confirmation screen.

- When the clock setting is complete, the confirmation screen for the function lever setting is displayed. Select [Change] or [Exit]. (You can check/uncheck the check box each time you touch [Don't show this again].)

Changing the Clock Setting

Select [Clock Set] in the [Setup] menu.

- The clock can be reset as shown in steps 3 and 4.

Selecting the Recording Mode

■ To select a Recording Mode with the mode dial

Select the mode by rotating the mode dial.

- Rotate the mode dial slowly to select the desired mode (A).

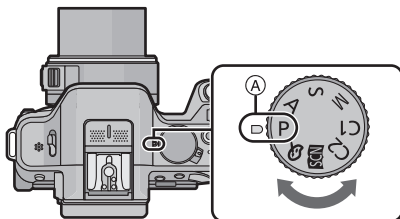

■ To select Intelligent Auto Mode

Press **[iA]**.

- **[iA]** button will light up when it is switched to Intelligent Auto Mode.
- The Recording Mode selected by the mode dial is disabled while the **[iA]** button is lit.

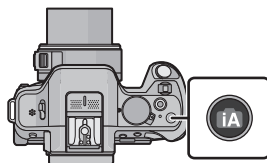

[iA] Intelligent Auto Mode
The subjects are recorded using settings automatically selected by the camera.
[iA+] Intelligent Auto Plus Mode
The subjects are recorded using settings automatically selected by the camera, and defocus, color and brightness can be controlled.
P Program AE Mode
The subjects are recorded using your own settings.
A Aperture-Priority AE Mode
The shutter speed is automatically determined by the aperture value you set.
S Shutter-Priority AE Mode
The aperture value is automatically determined by the shutter speed you set.
M Manual Exposure Mode
The exposure is adjusted by the aperture value and the shutter speed which are manually adjusted.
C1 C2 Custom Mode
Use this mode to take pictures with previously registered settings.
[SCN] Scene Guide Mode
This allows you to take pictures that match the scene being recorded.
[b] Creative Control Mode
Record while checking the image effect.

Taking a Still picture

Applicable modes:        

1 Select the Recording Mode.

2 Press the shutter button halfway to focus.

- (A) Aperture value
- (B) Shutter speed

- Aperture value and shutter speed are displayed. (It will flash in red if the correct exposure is not achieved, except when set to flash.)
- **When the image is correctly focused, the picture will be taken, since the [Focus Priority] is set initially to [ON].**

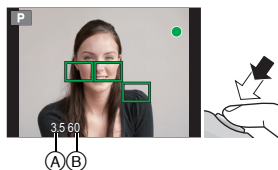

3 Press the shutter button fully (push it in further), and take the picture.



Taking pictures using the Touch Shutter function

Just by touching the subject to focus, it will focus on the subject and take the picture automatically.

1 Touch .

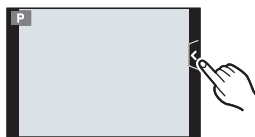



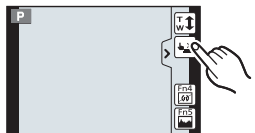

2 Touch .

- Icon will change to , and taking a picture with the Touch Shutter function becomes possible.



3 Touch the subject you wish to focus on, and then take a picture.

- AF area with same function as  in AF mode is displayed at the position you touch, and picture is taken when it is focused when the AF mode is set to , ,  or .

■ To cancel the Touch Shutter function

Touch .



Taking Pictures using the Automatic Function

(Intelligent Auto Mode)

Recording Mode:

In this mode, the camera makes the optimal settings for the subject and scene, so we recommend it when you wish to leave the settings to the camera and record without thinking about them.

Press .

-  button will light up when it is switched to Intelligent Auto Mode. (Light turns off during recording)
-  button is turned off when it is pressed again, and it will be set to the [Rec] Modes selected by the mode dial.
- When the subject is touched, AF Tracking function works. It is also possible by pressing the cursor button towards , and then pressing the shutter button halfway.

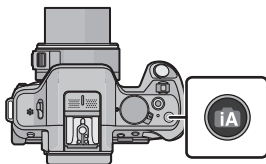

■ Scene Detection

When the camera identifies the optimum scene, the icon of the scene concerned is displayed in blue for 2 seconds, after which its color changes to the usual red.

Depending on the identified scene, the camera may display , which allows you to select the camera-recommended effects.

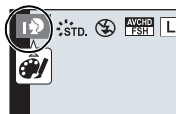

Recording using Intelligent Auto Plus Mode

Recording Mode:

The brightness and color optimally set by the camera can be easily matched to your preferences. This mode is useful if you do not like dealing with detailed settings but like the settings made automatically by the camera to match your preferences.

- 1 Press [MENU/SET] when in Intelligent Auto Mode.

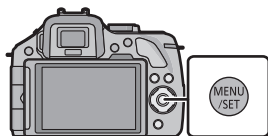

- 2 Touch [iA MODE].

- 3 Select [] and then touch [Set].



■ Adjusting brightness

- 1 Touch [].

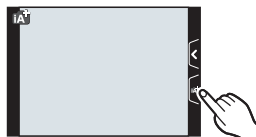

- 2 Touch [] to display the setting screen.

- The setting screen can also be displayed from the recording screen by pressing rear dial. Each press of the rear dial switches among brightness setting, Defocus Control and end operation.

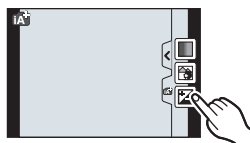

- 3 Drag the slide bar to set.

- This will adjust the brightness of the image.
- Setting can also be performed by rotating the rear dial.
- Touch [] again to return to the recording screen. You can also return to the recording screen by pressing the rear dial.

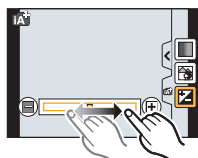

■ Adjusting color



1 Touch [].

2 Touch [] to display the setting screen.

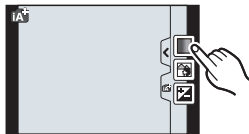
- The settings screen can also be displayed from the recording screen by pressing cursor button .



3 Drag the slide bar to set.

- This will adjust the color of the image from a reddish color to a bluish color.
- Setting can also be performed by rotating the rear dial.
- Touch [] again to return to the recording screen. You can also return to the recording screen by pressing the cursor button .

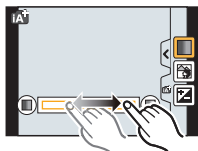

Taking Pictures with Defocus Control Function

Applicable modes:   P A S M    

You can easily set the blurriness of the background while checking the screen.

1 Touch [].

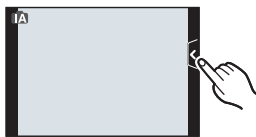

2 Touch [] to display the setting screen.

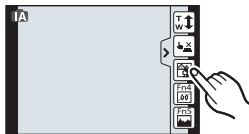

- Defocus Control setting screen can also be displayed by pressing the rear dial.



3 Drag the slide bar to set.

- Setting can also be performed by rotating the rear dial.

4 Record pictures or motion pictures.

- Defocus Control operation can be ended by touching [].
- Defocus Control operation can also be ended by pressing the rear dial.
- It is also possible to record a picture by touching [].

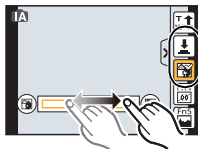

Recording Motion Picture

Applicable modes:

1 Start recording by pressing the motion picture button.

- (A) Elapsed recording time
- (B) Available recording time

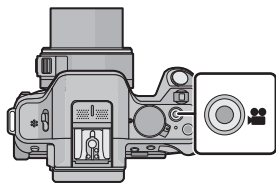

- Recording of motion picture appropriate for each mode is possible.
- The recording state indicator (red) (C) will flash while recording motion pictures.

2 Stop the recording by pressing the motion picture button again.

- Maximum time to record motion pictures continuously with [PSH] in [AVCHD] is 29 minutes 59 seconds.
- Maximum time to record motion pictures continuously with [MP4] is 29 minutes 59 seconds or up to 4 GB.
(For [FHD] in [MP4] format, the file size is large and so the recordable time will drop below 29 minutes 59 seconds.)

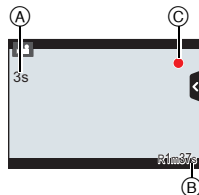

Recording still pictures while recording motion pictures

Still pictures can be recorded even while recording a motion picture. (Simultaneous recording)

During motion picture recording, press the shutter button fully to record a still picture.

- Simultaneous recording indicator (A) is displayed while recording still pictures.
- You can also take pictures using the Touch Shutter function.

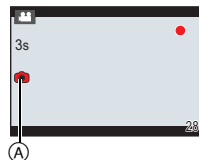

Compensating the Exposure

Applicable modes:        

Use this function when you cannot achieve appropriate exposure due to the difference in brightness between the subject and the background. Look at the following examples.

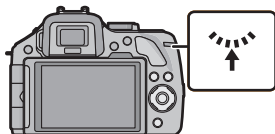

- 1 Press the rear dial to switch to Exposure Compensation operation.**

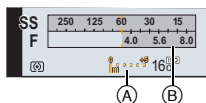

- 2 Rotate the rear dial to compensate the exposure.**

- (A) Exposure Compensation value
- (B) [Expo.Meter]



Underexposed	Properly exposed	Overexposed
		
Compensate the exposure towards positive.		Compensate the exposure towards negative.

- Select [0] to return to the original exposure.
- Rotate the rear dial to display the [Expo.Meter].

Using the function button

You can assign recording functions, etc. to specific buttons and icons.

To use those functions, press [Fn1], [Fn2] or [Fn3] or touch [Fn4] or [Fn5].

- To use [Fn1], set the [AF/AE LOCK / Fn1] of the [Custom] menu to [Fn1].
- To use [Fn3], set the [LVF/LCD / Fn3] of the [Custom] menu to [Fn3].

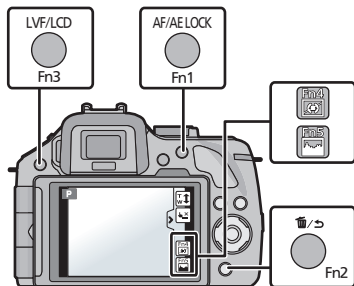

- 1 Touch [Fn1], [Fn2], [Fn3], [Fn4] or [Fn5] from the [Fn Button Set] in the [Custom] menu.**
- 2 Touch the function you want to assign.**
 - Assign your favorite functions to each of the function buttons.
 - Exit the menu after it is set.

Taking Pictures that match the Scene being recorded (Scene Guide Mode)

Recording Mode:

If you select a scene to suit the subject and recording conditions with reference to the example images, the camera will set optimal exposure, color, and focus, allowing you to record in a manner appropriate to the scene.

1 Set the mode dial to .

2 Drag the example images to select a screen.

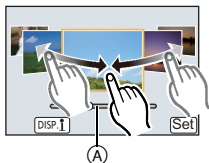

- You can also select the scene by dragging the slide bar .



3 Touch [Set].

■ To enjoy a variety of picture effects

Touch  on the scene selection screen to display explanations etc. for picture effects to suit the scene. To take full advantage of the picture effects, we recommend that you read the explanations and try recording pictures.

- The page can be changed by touching /.



Taking Pictures with different image effects

(Creative Control Mode)

Recording Mode: 

This mode records with additional image effects. You can set the effects to add by selecting example images and checking them on the screen.

1 Set the mode dial to [📷].

2 Touch the example image to select image effects (filters).

- The image effect of the selected example image will be applied in a preview display **A**.
- The image effect can be switched by touching [^]/[v].
- Touch [] to display the explanation for the selected image effect.
- The explanation can also be displayed by pressing cursor button ▶.

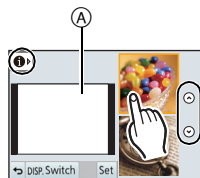

3 Touch [Set].

Playing Back Pictures/Motion Pictures

Playing Back Pictures

1 Press [▶].

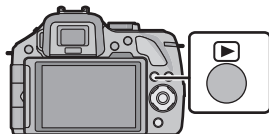

2 Forward or rewind the image by dragging the screen horizontally.

Forward: drag from right to left

Rewind: drag from left to right



Playing Back Motion Pictures

This unit was designed to play motion pictures using the AVCHD, MP4 and QuickTime Motion JPEG formats.

In Playback Mode, select a picture with the motion picture icon ([📹]) and touch [▶] in the middle of the screen.

(A) Motion picture icon

(B) The motion picture recording time

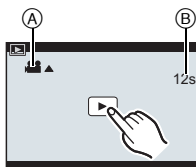

■ Operations performed during Motion Picture Playback

	Play/Pause		Stop
	Fast rewind		Fast forward
	Frame-by-frame rewind (while pausing)		Frame-by-frame forward (while pausing)
	Reduce volume level		Increase volume level

Deleting Pictures

Once deleted, pictures cannot be recovered.

To delete a single picture

- 1 In Playback Mode, select the picture to delete and touch [].**

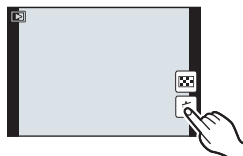

- 2 Touch [Delete Single].**

- Confirmation screen is displayed.
Pictures are deleted by selecting [Yes].

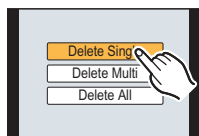

To delete multiple pictures (up to 100) or all the pictures

- 1 In Playback Mode, touch [].**

- 2 Touch [Delete Multi] or [Delete All].**

- [Delete All] → Confirmation screen is displayed.
Pictures are deleted by selecting [Yes].
- It is possible to delete all pictures except the ones set as favorite when [All Delete Except Favorite] is selected with the [Delete All] set.

- 3 (When [Delete Multi] is selected) Touch the picture to be deleted.**
(repeat this step)

-  appears on the selected pictures. Touching again cancels the setting.

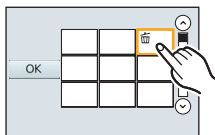

- 4 (When [Delete Multi] is selected) Touch [OK].**

- Confirmation screen is displayed.
Pictures are deleted by selecting [Yes].

Switching the display of the LCD Monitor

Press [DISP.] to change.

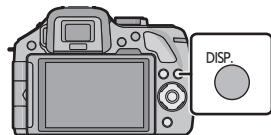

(In Recording Mode)

- Screen will switch as follows:
(Example of LCD monitor display)

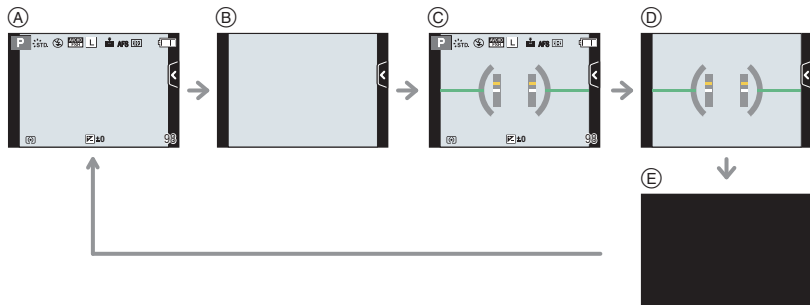

- Ⓐ With information*
- Ⓑ Without information*
- Ⓒ With information (tilt sensor display)*
- Ⓓ Without information (tilt sensor display)*
- Ⓔ Turned off

(In Playback Mode)

- Screen will switch as follows:
(Example of LCD monitor display)

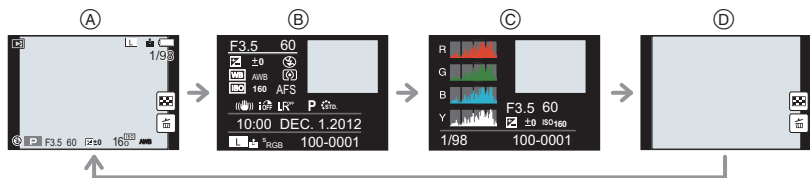

- Ⓐ With information*
- Ⓑ Detailed information display
- Ⓒ Histogram display
- Ⓓ Without information

* If approximately 1 minute elapses without an operation being performed, part of the display will disappear. Press [DISP.] or touch the LCD monitor to make the display reappear.

Setting the Menu

1 Press [MENU/SET].

- The top menu screen is displayed.

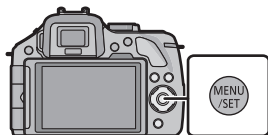

2 Touch the menu icon.



3 Touch the menu item.

- The page can be changed by touching [△]/[▽].



4 Touch the Setting to set.

- Depending on the menu item, its setting may not appear or it may be displayed in a different way.

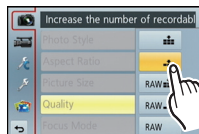

A brief description appears when you touch a menu item/option in steps **3** and **4**.

- It will be set when you release your finger.
- You can avoid selecting an item by dragging your finger to a vacant area and releasing the finger there.

■ Close the menu

Touch [] or press the shutter button halfway.

■ Switching to other menus

e.g.: Switching to the [Setup] menu from [Rec] menu

Touch [] or another of the menu toggle icons **A**.

- Select a menu item next and set it.

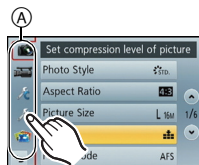



Types of menus

■ [Rec] Menu

This menu lets you set the aspect ratio, number of pixels and other aspects of the pictures you are recording.

• [Photo Style], [Focus Mode], [Metering Mode], [i.Dynamic], [i.Resolution] and [Digital Zoom] are common to both the [Rec] menu and [Motion Picture] menu. Changing these settings in one of these menus is reflected in other menu.

[Photo Style]	You can select effects to match the type of image you wish to record. You can adjust the color and image quality of the effects.
[Aspect Ratio]	Sets the aspect ratio of the image.
[Picture Size]	Set the number of pixels.
[Quality]	Set the compression rate at which the pictures are to be stored.
[Focus Mode]	Sets [Focus Mode] according to the movement of the subject and the scene you are recording.
[Metering Mode]	Sets the light metering method for measuring brightness.
[HDR]	You can combine 3 pictures with different levels of exposure into a single picture with rich gradation.
[i.Dynamic] (Intelligent dynamic range control)	Automatically corrects contrast and exposure.
[Flash]	Sets the manner in which the flash works.
[Red-Eye Removal]	Automatically detects red-eye caused by the flash and corrects the image data accordingly.
[Flash Synchro]	Sets the flash synchronisation method.
[Flash Adjust.]	Adjusts the amount of light released by the flash.
[i.Resolution]	Records pictures with more defined outlines and sense of clarity.
[ISO Limit Set]	When the ISO sensitivity is set to [AUTO] or [ISO], an optimal ISO sensitivity is set with the selected value as an upper limit.
[ISO Increments]	The ISO sensitivity settings values changes in steps of 1/3 EV or 1 EV.
[Long Shtr NR]	You can eliminate the generated noise by recording with a slower shutter speed.
[Shading Comp.]	If the screen periphery darkens as a result of lens characteristics, the brightness in this region will be corrected.

[Digital Zoom]	Increases the Tele effect. The higher the level of magnification, the greater the degradation in image quality.
[Electronic Shutter]	The electronic shutter can reduce the picture blur.
[Burst Rate]	Sets the burst speed for burst recording.
[Auto Bracket]	Sets single/burst recording, correction width and recording sequence for Auto Bracket recording.
[Self Timer]	Sets the time until recording for self-timer recording.
[Color Space]	Set this when you want to correct the color reproduction of the recorded pictures on a PC, printer etc.
[Stabilizer]	When camera shake is sensed during recording, the camera corrects it automatically.
[Face Recog.]	Sets the focus and exposure automatically prioritising registered faces.
[Profile Setup]	If you set the name and birthday of your baby or pet in advance, you can record their name and age in months and years in the images.
[Recommended Filter]	This sets whether to display the camera-recommended effects in Intelligent Auto ( or ) Mode.

■ [Motion Picture] Menu

This menu lets you set the [Rec Mode], [Rec Quality], and other aspects for motion picture recording.

- [Photo Style], [Focus Mode], [Metering Mode], [i.Dynamic], [i.Resolution] and [Digital Zoom] are common to both the [Rec] menu and [Motion Picture] menu. Changing these settings in one of these menus is reflected in other menu.

– For details, refer to the explanation for the corresponding setting in [Rec] menu.

[Rec Mode]	Sets the file format for the motion pictures you record.
[Rec Quality]	This sets up the picture quality of motion pictures.
[Picture Mode]	Sets the recording method for still pictures during motion picture recording.
[Continuous AF]	Continues to focus on the subject for which focus has been achieved.
[Ex. Tele Conv.]	Increases the Tele effect.
[Wind Cut]	This prevents the recording of wind-noise automatically.
[Mic Level Disp.]	Set whether or not the mic levels are displayed on the screen.
[Mic Level Adj.]	Adjust the sound input level to 4 different levels.

[Flkr Decrease]	The shutter speed can be fixed to reduce the flicker or striping in the motion picture.
------------------------	---

■ [Custom] Menu

Operation of the unit, such as displaying of the screen and button operations, can be set up according to your preferences. Also, it is possible to register the modified settings.

[Cust.Set Mem.]	Registers the current camera settings as custom set.
[AF/AE LOCK / Fn1]	Assigns AF/AE lock or Fn1 (function button) to the [AF/AE LOCK]/[Fn1] button.
[LVF/LCD / Fn3]	Assign the LVF/LCD switching function or Fn3 (function button) to the [LVF/LCD]/[Fn3] button.
[Fn Button Set]	You can assign various recording and other functions to the function button.
[Function Lever]	You can set the function to assign to the function lever.
[Q.MENU]	Switch the setting method of Quick Menu.
[Histogram]	This allows you to set either to display or not display the histogram.
[Guide Line]	This will set the pattern of guide lines displayed when taking a picture.
[Auto Review]	Set the length of time that the picture is displayed after taking the still picture.
[Highlight]	When the Auto Review function is activated or when playing back, white saturated areas appear blinking in black and white.
[Expo.Meter]	Set whether or not to display the exposure meter.
[AF/AE Lock]	Sets the fixed content for focusing and exposure when the AF/AE lock is on.
[AF/AE Lock Hold]	This will set the operation of [AF/AE LOCK] button when taking a picture with fixed focus or exposure.
[Quick AF]	Speeds up the focusing that takes place when you press the shutter button.
[Eye Sensor AF]	The camera automatically adjusts the focus when the eye sensor is active.
[Direct Focus Area]	Moves the AF area or MF assist using the cursor button when recording.
[Focus Priority]	It will set so no picture can be taken when it is out of focus.
[Shutter AF]	Set whether or not the focus is adjusted automatically when the shutter button is pressed halfway.

[Pinpoint AF Time]	Sets the time for which the screen is enlarged when the shutter button is pressed halfway with Auto Focus Mode set to [+] .
[AF Assist Lamp]	AF assist lamp will illuminate the subject when the shutter button is pressed half-way making it easier for the camera to focus when recording in low light conditions.
[AF+MF]	You can set the focus manually after the automatic focus has finished.
[MF Assist]	When you set the focus manually, the display is enlarged.
[MF Guide]	When you set the focus manually, an MF guide that allows you to check the direction to achieve focus is displayed.
[Power Zoom Lens]	Sets the screen display and lens operations when using an interchangeable lens that is compatible with power zoom (electrically operated zoom).
[LVF Disp.Style]	This will set the display style of the Live Viewfinder.
[LCD Disp.Style]	This will set the display style of the LCD monitor.
[Eye Sensor]	Enable or disable the eye sensor. You can also set the sensitivity of the eye sensor.
[iA Button Switch]	It is possible to set how the [iA] button activates the Intelligent Auto Mode.
[Video Button]	Enables/disables the motion picture button.
[Rec Area]	This changes the angle of view during motion picture recording and still picture recording.
[Remaining Disp.]	This will switch display between the number of recordable pictures and available recording time.
[Touch Settings]	Enables/disables the Touch operation.
[Touch Scroll]	This allows you to set the speed of continuously forwarding or rewinding pictures using touch operation.
[Dial Guide]	Set whether or not to display the dial operation guide.
[Menu Guide]	Set the screen that is displayed when the mode dial is set to [SCN] and ☺ .
[Shoot w/o Lens]	Sets whether or not the shutter can be released when no lens is attached to the main body.

■ Setup Menu

This menu lets you perform the clock settings, select the operating beep tone settings and set other settings which make it easier for you to operate the camera.

[Clock Set]	Setting Date/Time.
[World Time]	Sets the times for the region where you live and your holiday destination.
[Travel Date]	Departure date and return date of the trip as well as the name of the travel destination can be set.
[Beep]	Set the volume for electronic noises and the electronic shutter noise.
[Volume]	Adjust the volume of the speaker to any of 7 levels.
[LCD Display]/ [Viewfinder]	Brightness, color, or red or blue tint of the LCD monitor/Live Viewfinder is adjusted.
[LCD Mode]	The brightness of the LCD monitor can be adjusted depending on how bright it is around the camera.
[Economy]	Suppresses the unit's power consumption to prevent the battery from being run down.
[USB Mode]	Sets the communication method when connecting using the USB connection cable (supplied).
[Output]	This sets how the unit connects to a television etc.
[VIERA Link]	Equipment that supports the VIERA Link will connect automatically.
[3D Playback]	Set the output method for 3D pictures.
[Menu Resume]	Stores the location of the last-used menu item for each menu.
[Rotate Disp.]	This mode allows you to display pictures vertically if they were recorded holding the camera vertically.
[Menu Background]	Set the background color for the menu screen.
[Language]	Set the language displayed on the screen.
[Version Disp.]	This enables the firmware versions of the camera and lens to be checked.
[No.Reset]	Returns the image file number to 0001.
[Reset]	The [Rec] or [Setup]/[Custom] menu settings are reset to the initial settings.
[Pixel Refresh]	It will perform optimization of imaging device and image processing.

[Sensor Cleaning]	Dust reduction to blow off the debris and dust that have affixed to the front of the imaging device is performed.
[Format]	The card is formatted.

■ [Playback] Menu

This menu lets you set the Protection, Cropping or Print Settings, etc. of recorded pictures.

[2D/3D Settings]	Switches the playback method for 3D images.
[Slide Show]	Selects the type etc. of the images and plays back in order.
[Playback Mode]	Selects the type etc. of the images and plays back only particular images.
[Title Edit]	Input texts (comments) on the recorded pictures.
[Text Stamp]	Stamps the recorded pictures with recording date and time, names, travel destination, travel date, etc.
[Video Divide]	Splits the recorded motion picture in two.
[Resize]	Reduces the image size (number of pixels).
[Cropping]	Crops the recorded image.
[Rotate]	Rotate pictures manually in 90° steps.
[Favorite]	Marks can be added to images, and images can be set as favorites.
[Print Set]	Sets the images for printing and the number of prints.
[Protect]	Protects images to prevent deletion by mistake.
[Face Rec Edit]	Removes or changes information relating to personal identity.

Reading the Owner's Manual (PDF format)

More detailed instructions on the operation of this camera are contained in "Owner's Manual for advanced features (PDF format)" in the supplied CD-ROM. Install it on your PC to read it.

■ For Windows

- 1 Turn the PC on and insert the CD-ROM containing the Owner's Manual (supplied).
- 2 Select the desired language and then click [Owner's Manual] to install.
- 3 Double click the "Owner's Manual" shortcut icon on the desktop.

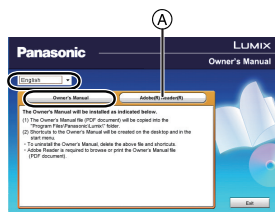

■ When the Owner's Manual (PDF format) will not open

You will need Adobe Acrobat Reader 5.0 or later or Adobe Reader 7.0 or later to browse or print the Owner's Manual (PDF format).

Insert the CD-ROM containing the Owner's Manual (supplied), click (A) and then follow the messages on the screen to install.

(Compatible OS: Windows XP SP3/Windows Vista SP2/Windows 7)

- You can download and install a version of Adobe Reader that you can use with your OS from the following Web Site.

<http://get.adobe.com/reader/otherversions>

■ To uninstall the Owner's Manual (PDF format)

Delete the PDF file from the "Program Files\Panasonic\Lumix\" folder.

■ For Mac

- 1 Turn the PC on and insert the CD-ROM containing the Owner's Manual (supplied).
- 2 Open the "Manual" folder in the CD-ROM and then copy the PDF file with the desired language inside the folder.
- 3 Double click the PDF file to open it.

About the supplied software

The supplied CD-ROM includes the following software.
Install the software on to your computer before use.

• **PHOTOfunSTUDIO 8.2 PE (Windows XP/Vista/7)**

This software allows you to acquire pictures to the PC, and also categorize these acquired pictures by their recording date or the model name of the camera used. You can resize pictures and add effects to the pictures. Various printing functions, such as layout printing, and writing function to CD-R* are supported too. If you forgot to set the date on the digital camera, you can add the date of recording to pictures with this software.

Also, [AVCHD] motion pictures can be loaded and written to DVD.

* This can be used only if the [Recording] tab is displayed on the [Properties] of the CD/DVD drive on the PC.

• **SILKYPIX Developer Studio (Windows XP/Vista/7, Mac OS X v10.4/v10.5/v10.6/v10.7)**

This is software to edit RAW format images.

Using RAW files recorded on this camera allows images to be edited with a higher quality. Edited images can be saved in a format (JPEG, TIFF, etc.) that can be displayed on a personal computer.

**For details on how to use the SILKYPIX Developer Studio, refer to the “Help” or the Ichikawa Soft Laboratory’s support website:
<http://www.isl.co.jp/SILKYPIX/english/p/support/>**

• **LoiLoScope 30 day full trial version (Windows XP/Vista/7)**

LoiLoScope is a video editing software where that draws out the full power of your PC. Creating videos is as easy as organizing cards on top of a desk. Use your music, picture and video files to create videos to share with your friends and family by burning it to a DVD, uploading it to websites, or simply share your videos with your friends via e-mail.

– This will only install a shortcut to the trial version download site.

**For more information on how to use LoiLoScope, read the LoiLoScope manual available for download at the link below.
Manual URL: <http://loilo.tv/product/20>**

- Before inserting the CD-ROM, close all running applications.

1 Check the environment of your PC.

- **Operating environment of “PHOTOfunSTUDIO 8.2 PE”**

- OS:

- Windows[®] XP (32bit) SP3,

- Windows Vista[®] (32bit) SP2,

- Windows[®] 7 (32bit/64bit) or SP1

- CPU:

- Pentium[®] III 500 MHz or higher (Windows[®] XP),

- Pentium[®] III 800 MHz or higher (Windows Vista[®]),

- Pentium[®] III 1 GHz or higher (Windows[®] 7)

- Display:

- 1024×768 pixels or more (1920×1080 pixels or more recommended)

- RAM:

- 512 MB or more (Windows[®] XP/Windows Vista[®]),

- 1 GB or more (Windows[®] 7 32bit),

- 2 GB or more (Windows[®] 7 64bit)

- Free hard disk space:

- 450 MB or more for installing software

- Refer to the operating instructions of “PHOTOfunSTUDIO” (PDF) for further operating environment details.
- For details on SILKYPIX Developer Studio 3.1 SE, please read the details on the support site given on P41.

2 Insert the CD-ROM with the supplied software.

- When you insert the supplied CD-ROM, the install menu will start.

3 Click on the [Recommended Installation].

- Proceed with installation according to messages appearing on the screen.

Note

- The software compatible with your PC will be installed.
- “PHOTOfunSTUDIO” is not compatible with Mac.
- On the Mac, SILKYPIX can be installed manually.

❶ Insert the CD-ROM with the supplied software.

❷ Double-click on the automatically displayed folder.

❸ Double-click the icon in the application folder.

Specifications

Specifications are subject to change without notice.

Digital Camera Body (DMC-G5):

Information for your safety

Power Source:	DC 8.4 V
Power Consumption:	2.9 W (When recording with LCD Monitor) [When the Interchangeable lens (H-PS14042) is used] 3.0 W (When recording with LCD Monitor) [When the Interchangeable lens (H-FS014042) is used] 2.5 W (When playing back with LCD Monitor) [When the Interchangeable lens (H-PS14042) is used] 2.6 W (When playing back with LCD Monitor) [When the Interchangeable lens (H-FS014042) is used]

Camera effective pixels	16,050,000 pixels
Image sensor	4/3" Live MOS sensor, total pixel number 18,310,000 pixels, Primary color filter
Digital Zoom	Max. 4×
Extra Tele Conversion	When taking still pictures: Max. 2× (When a picture size of [S] (4 M), aspect ratio of [4:3] is selected.) When recording motion pictures: ON/OFF simple enlargement (compatible with lenses from other manufacturers)
Focus	Auto Focus/Manual Focus, Face Detection/AF Tracking/23-area-focusing/ 1-area-focusing/Pinpoint (Touch focus area selection possible)
Shutter system	Focal-plane shutter
Burst recording	
Burst speed	20 pictures/second (Super high speed), 6 pictures/second (High speed), 3.7 pictures/second (Middle speed), 2 pictures/second (Low speed)
Number of recordable pictures	Max. 9 pictures (when there are RAW files) Depends on the capacity of the card (when there are no RAW files)
ISO sensitivity (Standard Output Sensitivity)	AUTO/ $\frac{1}{2}$ ISO/160/200/400/800/1600/3200/6400/12800 (1/3 EV step change possible)

Minimum Illumination	Approx. 9 lx (when i-Low light is used, the shutter speed is 1/30th of a second) [When the Interchangeable lens (H-PS14042) is used] Approx. 9 lx (when i-Low light is used, the shutter speed is 1/30th of a second) [When the Interchangeable lens (H-FS014042) is used]
Shutter speed	B (Bulb) (Max. approx. 120 seconds), 60 seconds to 1/4000th of a second Taking still pictures during motion picture recording Motion picture priorities: 1/30th of a second to 1/16000th of a second Still picture priorities: B (Bulb) (Max. approx. 120 seconds), 60 seconds to 1/4000th of a second
Metering range	EV 0 to EV 18
White Balance	Auto White Balance/Daylight/Cloudy/Shade/Incandescent lights/Flash/White set1/White set2/White Balance K set
Exposure (AE)	Program AE (P)/Aperture-priority AE (A)/Shutter-priority AE (S)/Manual exposure (M)/AUTO Exposure Compensation (1/3 EV Step, -5 EV to +5 EV)
Metering Mode	Multiple/Center weighted/Spot
LCD monitor	3.0" TFT LCD (3:2) (Approx. 920,000 dots) (field of view ratio about 100%) Touch screen
Viewfinder	Color LCD Viewfinder (Approx. 1,440,000 dots) (field of view ratio about 100%) (with diopter adjustment -4 to +4 diopter)
Flash	Built-in pop up flash GN 10.5 equivalent (ISO160·m) Flash range: Approx. 30 cm (0.99 feet) to 9.4 m (30.8 feet) [When the Interchangeable lens (H-PS14042) is mounted, WIDE, [ISO AUTO] is set] Flash range: Approx. 50 cm (1.65 feet) to 9.4 m (30.8 feet) [When the Interchangeable lens (H-FS014042) is mounted, WIDE, [ISO AUTO] is set] AUTO, AUTO/Red-Eye Reduction, Forced ON, Forced ON/Red-Eye Reduction, Slow Sync., Slow Sync./Red-Eye Reduction, Forced OFF
Flash synchronization speed	Equal to or smaller than 1/160th of a second
Microphone	Stereo
Speaker	Monaural
Recording media	SD Memory Card/SDHC Memory Card/SDXC Memory Card

Picture size		
Still picture	<p>When the aspect ratio setting is [4:3] 4608×3456 pixels, 3264×2448 pixels, 2336×1752 pixels</p> <p>When the aspect ratio setting is [3:2] 4608×3072 pixels, 3264×2176 pixels, 2336×1560 pixels</p> <p>When the aspect ratio setting is [16:9] 4608×2592 pixels, 3264×1840 pixels, 1920×1080 pixels</p> <p>When the aspect ratio setting is [1:1] 3456×3456 pixels, 2448×2448 pixels, 1744×1744 pixels</p>	
Recording quality		
Motion pictures	<p>[AVCHD] When set to [PSH]: 1920×1080 pixels (60p recording/ Approx. 28 Mbps/ When set to [FSH]: 1920×1080 pixels (60i recording/ Approx. 17 Mbps/ When set to [FPH]: 1920×1080 pixels (30p recording/ Approx. 17 Mbps/ When set to [SH]: 1280×720 pixels (60p recording/ Approx. 17 Mbps)</p> <p>[MP4] When set to [FHD]: 1920×1080 pixels (30 frames/sec., Approx. 20 Mbps/ When set to [HD]: 1280×720 pixels (30 frames/sec., Approx. 10 Mbps/ When set to [VGA]: 640×480 pixels (30 frames/sec., Approx. 4 Mbps)</p>	
Quality	RAW/RAW+Fine/RAW+Standard/Fine/Standard/MPO+Fine/ MPO+Standard	
Recording file format		
Still Picture	RAW/JPEG (based on "Design rule for Camera File system", based on "Exif 2.3" standard, DPOF corresponding)/MPO	
Motion pictures	AVCHD/MP4	
Audio compression	AVCHD	Dolby® Digital (2 ch)
	MP4	AAC (2 ch)
Interface		
Digital	"USB 2.0" (High Speed)	
Analog video/audio	NTSC Audio line output (monaural)	
Terminal		
[REMOTE]	φ 2.5 mm jack	
[AV OUT/DIGITAL]	Dedicated jack (8 pin)	
[HDMI]	MiniHDMI TypeC	

Dimensions	Approx. 119.9 mm (W)×83.2 mm (H)×70.8 mm (D) [4.72" (W)×3.28"(H)×2.79" (D)] (excluding the projecting parts)
Mass (weight)	Approx. 396 g/0.87 lb [with the card and battery] Approx. 346 g/0.76 lb (camera body) Approx. 491 g/1.08 lb [with the Interchangeable lens (H-PS14042), card and battery] Approx. 561 g/1.24 lb [with the Interchangeable lens (H-FS014042), card and battery]
Operating temperature	0 °C to 40 °C (32 °F to 104 °F)
Operating humidity	10%RH to 80%RH
Language select	[ENGLISH]/[ESPAÑOL]/[PORTUGUÊS]

Battery Charger (Panasonic DE-A79B):

Information for your safety

Input:	~ 110 V to 240 V, 50/60 Hz, 0.2 A
Output:	=== 8.4 V, 0.65 A

Equipment mobility: Movable

Battery Pack (lithium-ion) (Panasonic DMW-BLC12PP):

Information for your safety

Voltage/capacity:	7.2 V/1200 mAh
--------------------------	----------------

Interchangeable Lens (H-PS14042)**“LUMIX G X VARIO PZ 14–42 mm/F3.5–5.6 ASPH./POWER O.I.S.”**

Focal length	f=14 mm to 42 mm (35 mm film camera equivalent: 28 mm to 84 mm)
Aperture type	7 diaphragm blades/circular aperture diaphragm
Aperture range	F3.5 (Wide) to F5.6 (Tele)
Minimum aperture value	F22
Lens construction	9 elements in 8 groups (4 aspherical lenses, 2 ED Lens)
Nano surface coating	Yes
In focus distance	0.2 m (0.66 feet) (Wide to focal length 20 mm) to ∞ (from the focus distance reference line), 0.3 m (0.99 feet) (focal length 21 mm to Tele) to ∞ (from the focus distance reference line)
Maximum image magnification	0.17 \times (35 mm film camera equivalent: 0.34 \times)
Optical Image Stabiliser	Available
[O.I.S.] switch	None (Setting of the [Stabilizer] is done in [Rec] menu.)
Mount	“Micro Four Thirds Mount”
Angle of view	75° (Wide) to 29° (Tele)
Filter diameter	37 mm (1.46 inch)
Max. diameter	Approx. 61 mm (2.40 inch)
Overall length	Approx. 26.8 mm (1.06 inch) (from the tip of the lens to the base side of the lens mount when the lens barrel is recessed)
Mass (weight)	Approx. 95 g/0.21 lb

Interchangeable Lens (H-FS014042)**“LUMIX G VARIO 14–42 mm/F3.5–5.6 ASPH./MEGA O.I.S.”**

Focal length	f=14 mm to 42 mm (35 mm film camera equivalent: 28 mm to 84 mm)
Aperture type	7 diaphragm blades/circular aperture diaphragm
Aperture range	F3.5 (Wide) to F5.6 (Tele)
Minimum aperture value	F22
Lens construction	12 elements in 9 groups (1 aspherical lens)
In focus distance	0.3 m (0.99 feet) to ∞ (from the focus distance reference line)
Maximum image magnification	0.16 \times (35 mm film camera equivalent: 0.32 \times)
Optical Image Stabiliser	Available
[O.I.S.] switch	None (Setting of the [Stabilizer] is done in [Rec] menu.)
Mount	“Micro Four Thirds Mount”
Angle of view	75° (Wide) to 29° (Tele)
Filter diameter	52 mm (2.05 inch)
Max. diameter	Approx. 60.6 mm (2.39 inch)
Overall length	Approx. 63.6 mm (2.50 inch) (from the tip of the lens to the base side of the lens mount)
Mass (weight)	Approx. 165 g/0.36 lb

Digital Camera Accessory System

Description	Accessory#
Lithium Ion Battery	DMW-BLC12
AC Adaptor*1	DMW-AC8
DC Coupler*1	DMW-DCC8
Flash	DMW-FL220, DMW-FL360, DMW-FL500
Remote Shutter	DMW-RSL1
MC Protector	DMW-LMCH37*2, DMW-LMC52*3
ND Filter	DMW-LND37*2, DMW-LND52*3
PL Filter (Circular Type)	DMW-LPL37*2, DMW-LPL52*3
Lens Cap	DMW-LFC37*2, DMW-LFC52*3
Lens Rear Cap	DMW-LRC1
Body Cap	DMW-BDC1
Zoom Lever	DMW-ZL1*3
Tripod Adaptor*4	DMW-TA1
USB connection Cable	DMW-USBC1
AV Cable	DMW-AVC1
HDMI mini Cable	RP-CDHM15, RP-CDHM30
Wide conversion lens (0.79×)	DMW-GWC1*2
Tele conversion lens (2.0×)	DMW-GTC1*2
Macro conversion lens	DMW-GMC1*2
Fisheye conversion lens	DMW-GFC1*2
Conversion lens kit	DMW-GCK1*2
Interchangeable Lens	H-PS45175, H-PS14042, H-VS014140, H-HS12035, H-FS100300, H-FS045200, H-FS014042, H-FS014045, H-F007014, H-F008, H-ES045, H-X025, H-H020, H-H014 H-FT012
Mount Adaptor	DMW-MA1, DMW-MA2M, DMW-MA3R

*1 The AC Adaptor (optional) can only be used with the designated Panasonic DC Coupler (optional). The AC adaptor (optional) cannot be used by itself.

*2 When the interchangeable lens (H-PS14042) is used

*3 When the interchangeable lens (H-FS014042) is used

*4 Use if the attached lens is in contact with the tripod pedestal.

Description	Accessory#
Class 10 64 GB SDXC Memory Card	RP-SDU64GG1K
Class 10 32 GB SDHC Memory Card	RP-SDU32GG1K
Class 10 16 GB SDHC Memory Card	RP-SDU16GG1K
Class 10 8 GB SDHC Memory Card	RP-SDU08GG1K
Class 10 4 GB SDHC Memory Card	RP-SDU04GG1K
Class 6 32 GB SDHC Memory Card	RP-SDQA32GUK
Class 6 16 GB SDHC Memory Card	RP-SDQA16GUK
Class 6 8 GB SDHC Memory Card	RP-SDQA08GUK
Class 6 4 GB SDHC Memory Card	RP-SDQA04GUK
Class 4 32 GB SDHC Memory Card	RP-SDLA32GUK
Class 4 16 GB SDHC Memory Card	RP-SDLA16GUK
Class 4 8 GB SDHC Memory Card	RP-SDLA08GUK
Class 4 4 GB SDHC Memory Card	RP-SDLA04GUK
Class 4 2 GB SD Memory Card	RP-SDLA02GUK
<ul style="list-style-type: none"> • This unit is compatible with UHS-I standard SDHC/SDXC memory cards. 	

Product numbers correct as of August 2012. These may be subject to change.

- Refer to P15 for information about the battery charging time.
- NOTE: Accessories and/or model numbers may vary between countries. Consult your local dealer.
- Refer to catalogs/Web pages for most current information regarding optional accessories.
<http://panasonic.jp/support/global/cs/dsc/>
 (This Site is English only.)

Digital Camera Accessory Order Form

(For USA and Puerto Rico Customers)

Please photocopy this form when placing an order.

1. Digital Camera Model # _____

2. Items Ordered

Accessory #	Description	Price Each	Quantity	Total Price
Shipping & Handling				\$6.95
Subtotal				
Your State & Local Sales Tax				
Total				

3. Method of payment (check one)

- American Express
- VISA Credit Card # _____
- MasterCard Expiration Date _____
- Discover Customer Signature _____

(Please do not send cash)

4. Shipping information (UPS delivery requires complete street address)

Ship To:

Mr.

Mrs.

Ms. _____

First Last

Phone#:

Day () _____

Street Address _____

Night () _____

City State Zip

TO OBTAIN ANY OF OUR DIGITAL CAMERA ACCESSORIES YOU CAN DO ANY OF THE FOLLOWING:

VISIT YOUR LOCAL PANASONIC DEALER

OR

CALL PANASONIC'S ACCESSORY ORDER LINE AT 1-800-332-5368
[6 AM-6 PM M-F, PACIFIC TIME]

OR

MAIL THIS ORDER TO: PANASONIC NATIONAL PARTS CENTER
20421 84th Ave S., Kent, WA 98032

Limited Warranty

(ONLY FOR U.S.A. AND PUERTO RICO)

**Panasonic Consumer Marketing Company of North America,
Division of Panasonic Corporation of North America**
One Panasonic Way, Secaucus, New Jersey 07094

Panasonic Digital Still Camera Products Limited Warranty

Limited Warranty Coverage (For USA and Puerto Rico Only)

If your product does not work properly because of a defect in materials or workmanship, Panasonic Consumer Marketing Company of North America (referred to as “the warrantor”) will, for the length of the period indicated on the chart below, which starts with the date of original purchase (“warranty period”), at its option either (a) repair your product with new or refurbished parts, (b) replace it with a new or a refurbished equivalent value product, or (c) refund your purchase price. The decision to repair, replace or refund will be made by the warrantor.

Product or Part Name	Parts	Labor
Digital Still Camera	1 year	1 year
SD Memory Cards, Rechargeable Battery Pack (defective exchange)	90 days	Not Applicable

During the “Labor” warranty period there will be no charge for labor. During the “Parts” warranty period, there will be no charge for parts. This Limited Warranty excludes both parts and labor for non-rechargeable batteries, antennas, and cosmetic parts (cabinet). This warranty only applies to products purchased and serviced in the United States or Puerto Rico. This warranty is extended only to the original purchaser of a new product which was not sold “as is”.

Mail-In Service

For assistance in the U.S.A. and Puerto Rico in obtaining repairs, please ship the product prepaid to:

Panasonic Exchange Center
4900 George McVay Drive
Suite B
McAllen, TX 78503
panacare@us.panasonic.com

When shipping the unit, carefully pack, include all supplied accessories listed in the Owner's Manual, and send it prepaid, adequately insured and packed well in a carton box. When shipping Lithium Ion batteries please visit our Web Site at www.panasonic.com/BatteryHandling as Panasonic is committed to providing the most up to date information. Include a letter detailing the complaint, a return address and provide a daytime phone number where you can be reached. A valid registered receipt is required under the Limited Warranty.

IF REPAIR IS NEEDED DURING THE WARRANTY PERIOD. THE PURCHASER WILL BE REQUIRED TO FURNISH A SALES RECEIPT/PROOF OF PURCHASE INDICATING DATE OF PURCHASE, AMOUNT PAID AND PLACE OF PURCHASE. CUSTOMER WILL BE CHARGED FOR THE REPAIR OF ANY UNIT RECEIVED WITHOUT SUCH PROOF OF PURCHASE.

Limited Warranty Limits And Exclusions

This warranty ONLY COVERS failures due to defects in materials or workmanship, and DOES NOT COVER normal wear and tear or cosmetic damage. The warranty ALSO DOES NOT COVER damages which occurred in shipment, or failures which are caused by products not supplied by the warrantor, or failures which result from accidents, misuse, abuse, neglect, mishandling, misapplication, alteration, faulty installation, set-up adjustments, misadjustment of consumer controls, improper maintenance, power line surge, lightning damage, modification, introduction of sand, humidity or liquids, commercial use such as hotel, office, restaurant, or other business or rental use of the product, or service by anyone other than a Factory Service Center or other Authorized Servicer, or damage that is attributable to acts of God.

THERE ARE NO EXPRESS WARRANTIES EXCEPT AS LISTED UNDER "LIMITED WARRANTY COVERAGE".

THE WARRANTOR IS NOT LIABLE FOR INCIDENTAL OR CONSEQUENTIAL DAMAGES RESULTING FROM THE USE OF THIS PRODUCT, OR ARISING OUT OF ANY BREACH OF THIS WARRANTY.

(As examples, this excludes damages for lost time, travel to and from the servicer, loss of or damage to media or images, data or other memory or recorded content. The items listed are not exclusive, but for illustration only.)

ALL EXPRESS AND IMPLIED WARRANTIES, INCLUDING THE WARRANTY OF MERCHANTABILITY, ARE LIMITED TO THE PERIOD OF THE LIMITED WARRANTY.

Some states do not allow the exclusion or limitation of incidental or consequential damages, or limitations on how long an implied warranty lasts, so the exclusions may not apply to you. This warranty gives you specific legal rights and you may also have other rights which vary from state to state. If a problem with this product develops during or after the warranty period, you may contact your dealer or Service Center. If the problem is not handled to your satisfaction, then write to the warrantor's Consumer Affairs Department at the addresses listed for the warrantor.

PARTS AND SERVICE, WHICH ARE NOT COVERED BY THIS LIMITED WARRANTY, ARE YOUR RESPONSIBILITY.

Customer Services Directory (United States and Puerto Rico)

Obtain Product Information and Operating Assistance; locate your nearest Dealer or Service Center; purchase Parts and Accessories; or make Customer Service and Literature requests by visiting our Web Site at:

<http://www.panasonic.com/help>

or, contact us via the web at:

<http://www.panasonic.com/contactinfo>

You may also contact us directly at:

1-800-211-PANA (7262)

Monday-Friday 9am-9pm, Saturday-Sunday 10am-7pm EST

For hearing or speech impaired TTY users, TTY: 1-877-833-8855

Accessory Purchases (United States and Puerto Rico)

Purchase Parts, Accessories and Instruction Books online for all Panasonic Products by visiting our Web Site at:

<http://www.pstc.panasonic.com>

Or, send your request by E-mail to:

npcparts@us.panasonic.com

You may also contact us directly at:

1-800-332-5368 (Phone) 1-800-237-9080 (Fax Only)

(Monday-Friday 9am-9pm EST)

Panasonic National Parts Center

20421 84th Ave S., Kent, WA 98032

(We accept Visa, MasterCard, Discover Card, American Express)

For hearing or speech impaired TTY users, TTY: 1-866-605-1277

As of January 2012

Customer Service

Customer Service Directory

Obtain product information and operative assistant; localize the closer distributor or Service Center; buy spare parts and accessories by our web site to Latin American:

<http://www.lar.panasonic.com>

Also you may contact us directly by our Contact Center:

Panama	800-PANA (800-7262)
Colombia	01-8000-94PANA (01-8000-947262)
Ecuador	1800-PANASONIC (1800-726276)
Costa Rica	800-PANA737 (800-7262737)
El Salvador	800-PANA (800-7262)
Guatemala	1-801-811-PANA (1-801-811-7262)
Chile	800-390-602 From a cell phone: 797-5000
Venezuela	800-PANA-800 (800-7262-800)
Uruguay	0-800-PANA (0-800-7262)
Peru	0800-00726
Argentina	0800-333-PANA (0800-333-7262) 0810-321-PANA (0810-321-7262)
Paraguay	0800-11-PANA (0800-11-7262)

Mexico Service

To obtain information in the Republic of Mexico contact us at:

[email: atencion.clientes@mx.panasonic.com](mailto:atencion.clientes@mx.panasonic.com)

Or you may contact us in the next following phones numbers:

01800-VIP-PANA (01800-847-7262) - Interior
(55) 5000-1200 - Mexico D.F. and Metropolitan Area

• G MICRO SYSTEM is a lens exchange type digital camera system of LUMIX based on a Micro Four Thirds System standard.

• Micro Four Thirds™ and Micro Four Thirds Logo marks are trademarks or registered trademarks of Olympus Imaging Corporation, in Japan, the United States, the European Union and other countries.

• Four Thirds™ and Four Thirds Logo marks are trademarks or registered trademarks of Olympus Imaging Corporation, in Japan, the United States, the European Union and other countries.

• SDXC Logo is a trademark of SD-3C, LLC.

• “AVCHD”, “AVCHD Progressive” and the “AVCHD Progressive” logo are trademarks of Panasonic Corporation and Sony Corporation.

• Manufactured under license from Dolby Laboratories. Dolby and the double-D symbol are trademarks of Dolby Laboratories.

• HDMI, the HDMI Logo, and High-Definition Multimedia Interface are trademarks or registered trademarks of HDMI Licensing LLC in the United States and other countries.

• VIERA Link™ is a trademark of Panasonic Corporation.

• EZ Sync™ is a trademark of Panasonic Corporation.

• HDAVI Control™ is a trademark of Panasonic Corporation.

• QuickTime and the QuickTime logo are trademarks or registered trademarks of Apple Inc., used under license therefrom.

• Adobe is a trademark or registered trademark of Adobe Systems Incorporated in the United States and/or other countries.

• Mac and Mac OS are trademarks of Apple Inc., registered in the U.S. and other countries.

• Windows and Windows Vista are either registered trademarks or trademarks of Microsoft Corporation in the United States and/or other countries.

• This product uses “DynaFont” from DynaComware Corporation. DynaFont is a registered trademark of DynaComware Taiwan Inc.

• Other names of systems and products mentioned in these instructions are usually the registered trademarks or trademarks of the manufacturers who developed the system or product concerned.

This product is licensed under the AVC patent portfolio license for the personal and non-commercial use of a consumer to (i) encode video in compliance with the AVC Standard (“AVC Video”) and/or (ii) decode AVC Video that was encoded by a consumer engaged in a personal and non-commercial activity and/or was obtained from a video provider licensed to provide AVC Video. No license is granted or shall be implied for any other use. Additional information may be obtained from MPEG LA, LLC. See <http://www.mpegla.com>.

AVCHD™
Progressive

DOLBY
DIGITAL

HDMI



VIERA Link™

For USA

Panasonic Consumer Marketing Company of North America,
Division of Panasonic Corporation of North America

One Panasonic Way, Secaucus, NJ 07094

© Panasonic Corporation 2012

Printed in China