

Panasonic[®]

LUMIX

S1H

Owner's Manual

Digital Camera

DC-S1H

A firmware update has been made available to improve camera capabilities and to add functionality.

- For information about functions that have been added or modified, refer to the pages for "Firmware Update".



[Click here to move to "Firmware Update".](#)

DVQP2021ZE
F0919AJ4031

Please read these instructions carefully before using this product, and save this manual for future use.

Register online at <http://shop.panasonic.com/support>
(U.S. customers only)

Dear Customer,

Thank you for choosing Panasonic!

You have purchased one of the most sophisticated and reliable products on the market today. Used properly, we're sure it will bring you and your family years of enjoyment. Please take time to fill in the information below. The serial number is on the tag located on the underside of your camera. Be sure to **retain this manual** as your convenient camera information source.

Date of Purchase	Dealer Phone No.
Dealer Purchased From	Model No.
Dealer Address	Serial No.

Please note that the actual controls and components, menu items, etc. of your Digital Camera may look somewhat different from those shown in the illustrations in this Owner's Manual.

Carefully observe copyright laws.

Recording of pre-recorded tapes or discs or other published or broadcast material for purposes other than your own private use may infringe copyright laws. Even for the purpose of private use, recording of certain material may be restricted.

❖ Finding the Information You Need

You can find the information you need by looking at the following pages in this document.

Contents	→ 6
Contents by Function	→ 15
Names of Parts	→ 28
Menu Guide	→ 390
Index	→ 615

About Owner's Manual

❖ Symbols Used in This Document

Symbols for recording modes, pictures, and videos that can be used













In this document, symbols are placed at the start of functional explanations (recording modes, pictures, and videos) showing conditions in which these functions can be used.

Black icons show conditions in which these can be used, and gray icons show conditions in which these cannot be used.



Example:   

Operating symbols

In this document, camera operation is explained using the following symbols:

	(A)		Front dial
	(B)		Rear dial
	(C)		Cursor button up/down/left/right or Joystick up/down/left/right
	(D)		Press the center of the joystick
	(E)		[MENU/SET] button
	(F)		Control dial





- For information about operation methods of the operation part, refer to page [64](#).
- Other symbols, such as icons shown on the camera screen, are also used in explanations.
- This document describes the procedure for selecting menu items as follows:
Example) Set [Picture Quality] of the [Photo] ([Image Quality]) menu to [STD.]

 ⇒  ⇒  ⇒ [Picture Quality] ⇒ Select [STD.]

For information about menu operation methods, refer to page [77](#).

Notification classification symbols

In this document, notifications are classified and described using the following symbols:

	To confirm prior to using the function
	Hints for better use of the camera and tips for recording
	Notifications and supplementary items regarding specifications
	Related information and page number

-
- This document provides an explanation with the assumption that menu settings are in the default settings.
Furthermore, illustrations of screens used assume the following settings.
– [Style] ([Clock Set]): [Y.M.D]/[24hrs]
 - Description in this document is based on the interchangeable lens (S-R24105: optional).

Chapters

1. Introduction	19
2. Getting Started	34
3. Basic Operations	59
4. Image Recording	87
5. Focus/Zoom	96
6. Drive/Shutter/Image Stabilizer	131
7. Metering/Exposure/ISO Sensitivity	185
8. White Balance/Image Quality	204
9. Flash	228
10. Recording Videos	242
11. Special Video Recording	297
12. Connections with External Devices (Video)	329
13. Playing Back and Editing of Images	347
14. Camera Customization	366
15. Menu Guide	390
16. Wi-Fi/Bluetooth	465
17. Connecting to Other Devices	522
18. Materials	539

Contents

About Owner's Manual	3
Chapters	5
Contents by Function	15

1. Introduction **19**

Before Use	19
Standard Accessories	22
Lenses That Can Be Used	23
Memory Cards That Can Be Used	25
Names of Parts	28
Camera	28
Viewfinder/Monitor Displays	32
Status LCD Display	33

2. Getting Started **34**

Attaching a Shoulder Strap	34
Charging the Battery	36
Charging with the Charger	36
Battery Insertion	39
Inserting a Battery into the Camera for Charging	41
Using the Camera While Supplying It with Power (Supplying Power/Charging)	43
Notifications Regarding Charging/Power Supply	44
[Power Save Mode]	46
Inserting Cards (Optional)	48
Formatting Cards (Initialization)	50
Attaching a Lens	51
Adjusting the Monitor Direction and Angle	54
Setting the Clock (When Turning On for the First Time)	56

3. Basic Operations **59**

Basic Recording Operations	59
How to Hold the Camera	59
Taking Pictures	61
Recording Videos	62
Selecting the Recording Mode	63
Camera Setting Operations	64
Display Settings	68
Setting the Viewfinder	68
Switching Between the Monitor and Viewfinder	69
Switching the Display Information	70
Turning On the Status LCD Backlight	72
Quick Menu	73
Control Panel	75
Menu Operation Methods	77
[Reset]	80
Intelligent Auto Mode	81
Recording Using Touch Functions	84
Touch AF/Touch Shutter	84
Touch AE	85

4. Image Recording **87**

[Aspect Ratio]	87
[Picture Size]	88
[Picture Quality]	90
[Double Card Slot Function]	92
[Folder / File Settings]	93
[File Number Reset]	95

5. Focus/Zoom 96

Selecting the Focus Mode	96
Using AF	97
[AF Custom Setting(Photo)]	101
Selecting the AF Mode	103
[Face/Eye/Body/Animal Detect.].....	105
[Tracking].....	108
[225-Area].....	110
[Zone (Vert./ Horz.)]/ [Zone (Square)]/ [Zone (Oval)].....	111
[1-Area+]/ [1-Area].....	113
[Pinpoint]	114
[Custom1] to [Custom3].....	116
AF Area Movement Operation	118
Moving the AF Area by Touch	119
Moving the AF Area Position with the Touch Pad	121
[Focus Switching for Vert / Hor].....	122
Record Using MF	123
Recording with Zoom.....	127
Extended Tele Conversion	128

6. Drive/Shutter/Image Stabilizer 131

Selecting the Drive Mode.....	131
Taking Burst Pictures.....	132
6K/4K Photo Recording	136
Selecting Pictures from a 6K/4K Burst File	142
Correcting Pictures After Recording (Post-Recording Refinement).....	143
Picture Selection Operations	144
Recording with Time Lapse Shot.....	149
Recording with Stop Motion Animation.....	153
Time Lapse Shot/Stop Motion Animation Videos	156
Recording Using the Self-timer.....	158
Bracket Recording	160
Post-Focus Recording	166

Selecting the Focus Point for the Picture to Save.....	169
Focus Stacking	171
[Silent Mode].....	174
[Shutter Type].....	175
Image Stabilizer.....	177
Image Stabilizer Settings	179

7. Metering/Exposure/ISO Sensitivity **185**

[Metering Mode].....	185
Program AE Mode	186
Aperture-Priority AE Mode.....	188
Shutter-Priority AE Mode.....	191
Manual Exposure Mode.....	193
Preview Mode.....	196
Exposure Compensation	197
Locking Focus and Exposure (AF/AE Lock).....	199
ISO Sensitivity	200
[Dual Native ISO Setting].....	203

8. White Balance/Image Quality **204**

White Balance (WB)	204
Adjusting the White Balance	208
[Photo Style]	210
[Filter Settings].....	216
[Simultaneous Record w/o Filter]	221
[High Resolution Mode]	222
[HLG Photo].....	226

9. Flash 228

Using an External Flash (Optional).....	228
Removing the Hot Shoe Cover.....	228
Setting Flash.....	231
[Flash Mode].....	231
[Red-Eye Removal].....	233
[Firing Mode]/[Manual Flash Adjust.].....	234
[Flash Adjust.].....	235
[Flash Synchro].....	236
[Auto Exposure Comp.].....	237
Recording Using a Wireless Flash.....	238

10. Recording Videos 242

Recording Videos.....	242
Creative Video Mode.....	247
Displays Suited to Video Recording.....	247
Recording with Creative Video.....	249
[CreativeVideo Combined Set.].....	252
Recording Video.....	253
[System Frequency].....	253
[Rec. File Format].....	255
[Rec Quality].....	255
[Image Area of Video].....	266
Time Code.....	268
Setting the Time Code.....	268
Synchronizing the Time Code with an External Device.....	270
Synchronize the Time Code of the External Device with That of the Camera (TC OUT).....	271
Synchronize the Time Code of the Camera with That of the External Device (TC IN).....	273
Using AF (Video).....	275
[Continuous AF].....	275
[AF Custom Setting(Video)].....	277
Video Brightness and Coloring.....	278
[Luminance Level].....	278

[Master Pedestal Level]	279
Recording While Controlling Overexposure (Knee)	280
[ISO Sensitivity (video)]	282
Audio Settings	283
[Sound Rec Level Disp.]	283
[Mute Sound Input]	283
[Sound Rec Gain Level]	284
[Sound Rec Level Adj.]	284
[Sound Rec Level Limiter]	285
[Wind Noise Canceller]	285
Main Assist Functions	286
[SS/Gain Operation]	286
[WFM/Vector Scope]	288
[Luminance Spot Meter]	292
[Zebra Pattern]	293
[Video Frame Marker]	295
Color bars/Test Tone	296

11. Special Video Recording 297

Variable Frame Rate	297
High Frame Rate Video	300
[Focus Transition]	301
[Live Cropping]	304
Log Recording	308
[V-Log View Assist]	310
HLG Videos	312
[HLG View Assist]	314
Anamorphic Recording	315
[Anamorphic Desqueeze Display]	316
[Synchro Scan]	318
[Loop Recording (video)]	320
[Segmented File Recording]	322
List of Recording Qualities That Enable Special Videos to be Recorded	323

12. Connections with External Devices (Video) 329

HDMI Devices (HDMI Output)	329
Attaching the Cable Holder	330
Images Output via HDMI	333
HDMI Output Image Quality (Resolution/Frame Rate)	335
Settings for Down-Converting.....	335
HDMI Output Settings.....	338
Outputting the Camera Information Display via HDMI.....	338
Outputting Control Information to an External Recorder	338
Outputting Down-converted Audio to an HDMI Device	339
Outputting Audio via HDMI.....	339
External Microphones (Optional)	340
XLR Microphone Adaptor (Optional).....	343
Headphones	345

13. Playing Back and Editing of Images 347

Playing Back Pictures.....	347
Playing Back Videos.....	349
Extracting a Picture	351
Switching the Display Mode.....	352
Enlarged Display	352
Thumbnail Screen	354
Calendar Playback	355
Group Images	356
Deleting Images.....	357
[RAW Processing].....	359
[Video Divide].....	364

14. Camera Customization **366**

Fn Buttons	367
[Dial Operation Switch]	376
Quick Menu Customization.....	378
Custom Mode	383
My Menu.....	387
[Save/Restore Camera Setting].....	389

15. Menu Guide **390**

List of Menu	391
[Photo] Menu	396
[Video] Menu	410
[Custom] Menu	418
[Setup] Menu	444
[Playback] Menu	456
Entering Characters.....	464

16. Wi-Fi/Bluetooth **465**

Connecting to a Smartphone.....	467
Operating the Camera with a Smartphone	479
Sending Images from the Camera.....	492
Wi-Fi Connections	508
Send Settings and Selecting Images.....	515
[Wi-Fi Setup] Menu.....	517

17. Connecting to Other Devices **522**

Viewing on a TV.....	524
Importing Images to a PC.....	527
Copying Images to a PC.....	527
Installing Software.....	529
Storing on a Recorder.....	532
Tethered Recording.....	533
Installing Software.....	533
Operating the Camera from a PC.....	534
Printing.....	535

18. Materials **539**

Using Optional Accessories.....	539
Battery Grip (Optional).....	539
Shutter Remote Control (Optional).....	540
AC Adaptor (Optional)/DC Coupler (Optional).....	541
Monitor/Viewfinder Displays.....	542
Recording Screen.....	542
Playback Screen.....	550
Message Displays.....	553
Troubleshooting.....	557
Cautions for Use.....	569
Number of Pictures That Can Be Taken and Available Recording Time with the Battery.....	579
Number of Still Images That Can Be Taken and Video Recording Time with Cards.....	582
List of Default Settings/Custom Saving/Settings Available for Copying.....	587
List of Functions That Can Be Set in Each Recording Mode.....	601
Specifications.....	606
Index.....	615
Trademarks and Licences.....	623

Contents by Function

Power Source

Charging	→ 36
Charging error	→ 38
	→ 42
Battery indication	→ 44
Power supply	→ 43
[Battery Information]	→ 450
Power save function	→ 46
Number of pictures that can be taken, available recording time	→ 579

Card

Cards that can be used	→ 25
[Card Format]	→ 50
[Double Card Slot Function]	→ 92
[Destination Card Slot]	→ 92
Switching the playback card	→ 348
	→ 354
Folder structure	→ 528
[Folder / File Settings]	→ 93
[File Number Reset]	→ 95
Entering characters	→ 464
Number of pictures, length of recording time	→ 582

Lens

Attaching	→ 51
[Lens Information]	→ 183

Basic Settings

[Language]	→ 455
[Clock Set]	→ 56
[Time Zone]	→ 454
[Beep]	→ 448
[Copyright Information]	→ 444
[Reset]	→ 80

Viewfinder

Diopter adjustment	→ 68
Display magnification	→ 68
Eye sensor	→ 69
[Eye Sensor AF]	→ 424

Display

Recording screen	→ 542
Playback screen	→ 550
Viewfinder	→ 32
Status LCD	→ 33
Control panel	→ 75
	→ 546
Switching display	→ 70
Monitor/viewfinder adjustment	→ 446
Monitor/viewfinder luminance	→ 446
Display speed	→ 445
Level gauge	→ 438
Grid lines	→ 433
[Histogram]	→ 432
[Sheer Overlay]	→ 437
Checking overexposure	→ 436
[V-Log View Assist]	→ 310
[HLG View Assist]	→ 314

AF/MF

Focus mode	→ 96
[Continuous AF]	→ 275
Selecting the AF mode	→ 103
	→ 423
Face/eye/human detection	→ 105
Animal detection	→ 106
Movement tracking	→ 108
[AF ON]	→ 98
Moving the AF area	→ 118
Enlarged display	→ 100
	→ 125
Setting the AF sensitivity	→ 101
	→ 277

AF/AE Lock	→ 199
Touch AF	→ 84
[Touch Pad AF]	→ 120
[Touch Pad AF]	→ 121
[AF Assist Light]	→ 401
MF	→ 123
[MF Guide]	→ 422
[MF Assist]	→ 422
[Focus Peaking]	→ 402

Image Stabilizer

[Image Stabilizer]	→ 177
[E-Stabilization (Video)]	→ 179
[Boost I.S. (Video)]	→ 182
[Anamorphic (Video)]	→ 182
[Lens Information]	→ 183

Drive

Drive mode	→ 131
Burst	→ 132
[6K/4K PHOTO]	→ 136
[Time Lapse Shot]	→ 149
Recording with Stop Motion Animation	→ 153
[Self Timer]	→ 158
[Post-Focus]	→ 166

Image Quality

[Picture Size]	→ 88
[Picture Quality]	→ 90
RAW	→ 90
JPEG	→ 90
Aspect ratio	→ 87
[White Balance]	→ 204
[Photo Style]	→ 210
[Filter Settings]	→ 216
[Color Space]	→ 420
[6K/4K PHOTO Noise Reduction]	→ 144
[Flicker Decrease (Photo)]	→ 407

[Long Exposure NR]	→ 397
[i.Dynamic Range]	→ 399
[Vignetting Comp.]	→ 400
[Diffraction Compensation]	→ 400

Taking Pictures

Recording mode	→ 63
Quick menu	→ 73
Zoom	→ 127
[Ex. Tele Conv.]	→ 128
Bracket recording	→ 160
Bulb recording	→ 195
[High Resolution Mode]	→ 222
[Multiple Exposure]	→ 408
[HLG Photo]	→ 226
[Shutter Type]	→ 175
[Silent Mode]	→ 174
Remote control recording	→ 540
Screen display	→ 542

Exposure

[Exposure Comp.]	→ 197
Program Shift	→ 187
Preview mode	→ 196
[Metering Mode]	→ 185
AE Lock	→ 199
[One Push AE]	→ 371
[Touch AE]	→ 85
[Sensitivity]	→ 200
[Extended ISO]	→ 419
[Dual Native ISO Setting]	→ 203

Flash

External flash	→ 228
[Firing Mode]	→ 234
[Flash Mode]	→ 231
[Flash Adjust.]	→ 235
[Flash Synchro]	→ 236
[Wireless Flash Setup]	→ 238

Video Recording

Video recording	→ 242
[System Frequency]	→ 253
[Image Area of Video]	→ 266
Creative Video mode	→ 247
[Variable Frame Rate]	→ 297
High frame rate video	→ 300
[Focus Transition]	→ 301
[Live Cropping]	→ 304
Log recording (V-Log)	→ 308
HLG video	→ 312
Anamorphic Recording	→ 315
[Loop Recording (video)]	→ 320
[Segmented File Recording]	→ 322
[Tally Lamp]	→ 242
[Down Convert]	→ 335
[Time Code]	→ 268
Remote control recording	→ 540

Display (Video)

SS/Gain Operation	→ 286
[WFM/Vector Scope]	→ 288
[Luminance Spot Meter]	→ 292
[Zebra Pattern]	→ 293
[Video Frame Marker]	→ 295
[Color Bars]	→ 296

Image Quality (Video)

[Rec. File Format]	→ 255
[Rec Quality]	→ 255
Resolution	→ 255
Recording frame rate	→ 255
Bit rate	→ 255
[Flicker Decrease (Video)]	→ 411
[Synchro Scan]	→ 318

Exposure (Video)

Exposure settings	→ 243
	→ 252
[Dual Native ISO Setting]	→ 203
Luminance level	→ 278
[Master Pedestal Level]	→ 279
Knee	→ 280
Gain	→ 286

Audio

External microphone	→ 340
XLR Microphone Adaptor	→ 343
Headphones	→ 345
[Sound Output]	→ 345
[Sound Rec Level Disp.]	→ 283
[Mute Sound Input]	→ 283
[Sound Rec Gain Level]	→ 284
[Sound Rec Level Adj.]	→ 284
Wind noise reduction	→ 285
Attenuator	→ 285
Test tone	→ 296

Playback

[Auto Review]	→ 430
Playing back pictures	→ 347
Playing back videos	→ 349
Thumbnail display	→ 354
Calendar display	→ 355
Enlarged display	→ 352
Group images	→ 356
Saving 6K/4K photos	→ 142
Viewing on a TV	→ 524
Deleting	→ 357
Screen display	→ 550
[Slide Show]	→ 457

Editing of Images

[RAW Processing]	→ 359
[Protect]	→ 460
[Rating]	→ 460
[Resize]	→ 461
[Rotate]	→ 461
[Video Divide]	→ 364
[Copy]	→ 462

Customization

[Custom] menu	→ 418
Function button	→ 367
Custom recording mode	→ 383
My Menu	→ 387
Quick menu	→ 378
Dial operation	→ 376
Saving camera settings	→ 389

Connecting with Other

Devices

Sending images (PC)	→ 527
Printing	→ 535
Viewing on a TV	→ 524
HDMI output	→ 329
	→ 525
Tethered recording	→ 533
Cable holder	→ 330

Wi-Fi/Bluetooth

Bluetooth connection	→ 469
[Wi-Fi connection]	→ 473
	→ 508
[Wi-Fi Setup]	→ 517
Smartphone app “LUMIX Sync”	→ 467
[Remote shooting]	→ 480
Location information	→ 488
Sending images ([Smartphone])	→ 484
	→ 496
Sending images ([PC])	→ 499
Sending images ([Printer])	→ 502
Sending images ([Web service])	→ 504
Sending images ([Cloud Sync. Service])	→ 506
Saving camera settings	→ 491
“LUMIX CLUB”	→ 518

Software

“PHOTOfunSTUDIO”	→ 530
“SILKYPIX”	→ 531
“LUMIX Tether”	→ 533

Maintenance

[Sensor Cleaning]	→ 454
[Pixel Refresh]	→ 454

1. Introduction

Before Use

❖ Firmware of Your Camera/Lens

Firmware updates may be provided in order to improve camera capabilities or to add functionality. For smoother recording, we recommend updating the firmware of the camera/lens to the latest version.

- **For the latest information on the firmware or to download/update the firmware, visit the following support site:**
<https://panasonic.jp/support/global/cs/dsc/>
(English only)
- To check the firmware version of the camera/lens, attach the lens to the camera and select [Firmware Version] in the [Setup] ([Others]) menu. You can also update the firmware in [Firmware Version]. (→ 455)
- This document provides explanations for camera firmware version 1.0.

❖ Handling of the Camera

When using the camera, take care not to drop it, bump it, or apply undue force. These may cause malfunction or damage to the camera and lens.

If sand, dust, or liquid gets on the monitor, wipe it off with a dry soft cloth.

- Touch operations may be incorrectly recognized.

When using in low temperatures (–10 °C to 0 °C (14 °F to 32 °F))

- Before use, attach a Panasonic lens with a minimum recommended operating temperature of –10 °C (14 °F).

Do not place a hand inside the camera mount.

This may cause a failure or damage because the sensor is a precision device.

If you shake the camera while turning the camera off, a sensor may operate or a rattling sound may be heard. This is caused by the image stabilizer mechanism in the body. It is not a malfunction.

❖ Splash Resistant

Splash Resistant is a term used to describe an extra level of protection this camera offers against exposure to a minimal amount of moisture, water or dust. Splash Resistant does not guarantee that damage will not occur if this camera is subjected to direct contact with water.

In order to minimize the possibility of damage please be sure the following precautions are taken:

- Splash Resistant works in conjunction with the lenses that were specifically designed to support this feature.
- Securely close the doors, socket caps, contact points cover, etc.
- When the lens or cap is removed or a door is open, do not allow sand, dust, and moisture to enter inside.
- If liquid gets on the camera, wipe it off with a dry soft cloth.

❖ Condensation (When the Lens, the Viewfinder or Monitor is Fogged Up)

- Condensation occurs when there are temperature or humidity differences. Take care as this may lead to soiling, mold, and malfunctions in the lens, viewfinder, and monitor.
- If condensation occurs, turn off the camera and leave it for approx. 2 hours. The fog will disappear naturally when the temperature of the camera becomes close to the ambient temperature.

❖ **Be Sure to Perform Trial Recording in Advance**

Perform trial recording in advance of an important event (wedding, etc.) to check that recording can be performed normally.

❖ **No Compensation Regarding Recording**

Please note that compensation cannot be provided in the event that recording could not be performed due to a problem with the camera or a card.

❖ **Be Careful with Regard to Copyrights**

Under copyright law, you may not use the images and audio you have recorded for other than personal enjoyment without the permission of the copyright holder. Be careful because there are cases where restrictions apply to recording even for the purpose of personal enjoyment.

❖ **Also Read “Cautions for Use” (→ [569](#))**

Standard Accessories

Check that all the accessories are supplied before using the camera.

- The accessories and their shape will differ depending on the country or area where the camera was purchased.

For details on the accessories, refer to "Owner's Manual <Basic>" (supplied).

- **Digital camera body** is referred to as **camera** in this document.
- **Battery pack** is referred to as **battery pack** or **battery** in this document.
- **Battery charger** is referred to as **battery charger** or **charger** in this document.
- **The memory card is optional.**
- The interchangeable lens is optional.



Lenses That Can Be Used

The lens mount of this camera is compliant with the L-Mount standard of Leica Camera AG. It can be used with 35 mm full-frame compatible interchangeable lenses and APS-C size interchangeable lenses of this standard. This camera is capable of sensor read out suited to the image circles of 35 mm full-frame interchangeable lenses and Super 35 mm interchangeable lenses.

- When using an APS-C size interchangeable lens, sensor read out is possible across the same range as a Super 35 mm interchangeable lens.
- The interchangeable lenses used in the explanations are designated as follows in this document.

Types of interchangeable lens	Designation in this document
35 mm full-frame interchangeable lens	full-frame lens
Super 35 mm interchangeable lens	Super 35 mm lens
APS-C-size interchangeable lens	APS-C lens

- When there is no distinguishing the type of lens, the explanation will use **lens**.
- When using a lens that cannot communicate with this camera, you can register the lens information using the following menu item. The settings on this camera enable you to switch settings to suit full-frame or Super 35 mm/APS-C lenses. (→ 183)

[] → [] → [Image Stabilizer] → [Lens Information] → [Lens1] to [Lens12] → [Image Circle]

[] → [] → [Lens Information] → [Lens1] to [Lens12] → [Image Circle]

❖ Notes on the Use of Super 35 mm/APS-C Lenses

As the image area is narrowed when using Super 35 mm/APS-C lenses, the following functions may not be available or their behaviour may be different.

[Aspect Ratio]	→ 87	[Filter Settings]	→ 216
[Picture Size]	→ 88	[High Resolution Mode]	→ 222
[Ex. Tele Conv.]	→ 128	[HLG Photo]	→ 226
[6K/4K PHOTO]	→ 136	[Rec Quality]	→ 263
[Post-Focus]	→ 166	[Image Area of Video]	→ 266
[Shutter Type]	→ 175	[Multiple Exposure]	→ 408

- Refer to catalogs/websites for most current information regarding supported lenses.

<https://panasonic.jp/support/global/cs/dsc/>

(English only)

Memory Cards That Can Be Used

You can use the following memory cards with this camera.

- SD memory card, SDHC memory card, and SDXC memory card are referred to by the generic name of **card** in this document.

SD memory card (512 MB to 2 GB)	<ul style="list-style-type: none"> • The camera supports SDHC/SDXC memory cards compliant with UHS Speed Class 3 of the UHS-I/ UHS-II standard. 	
SDHC memory card (4 GB to 32 GB)	<ul style="list-style-type: none"> • The camera supports SDHC/SDXC memory cards compliant with Video Speed Class 90 of the UHS-II standard. 	
SDXC memory card (48 GB to 128 GB)	<ul style="list-style-type: none"> • Operation with the Panasonic cards on the left has been verified. 	

- For the latest information, check the following support site:
<https://panasonic.jp/support/global/cs/dsc/>
 (English only)

❖ Cards That Can Be Used Stably with This Camera

When using the following functions, use cards that have the correct SD Speed Class, UHS Speed Class, and Video Speed Class.

- Speed classes are standards to guarantee the minimum speed necessary for continuous writing.

[Video Record]

Bit rate of the recording quality	Speed Class	Example of indication
72 Mbps	Class 10	CLASS 10 10
	UHS Speed Class 1 or higher	U1
	Video Speed Class 10 or higher	V10
100 Mbps to 200 Mbps	UHS Speed Class 3	U3
	Video Speed Class 30 or higher	V30
400 Mbps	Video Speed Class 60 or higher	V60 V90

[6K/4K PHOTO]/[Post-Focus]

Speed Class	Example of indication
UHS Speed Class 3	U3
Video Speed Class 30 or higher	V30



- You can prevent the writing and deleting of data by setting the write-protect switch (A) on the card to "LOCK".
- The data stored on a card may be damaged due to electromagnetic waves, static electricity or a failure of the camera or card. We recommend backing up important data.
- Keep the memory card out of reach of children to prevent swallowing.



Names of Parts

Camera

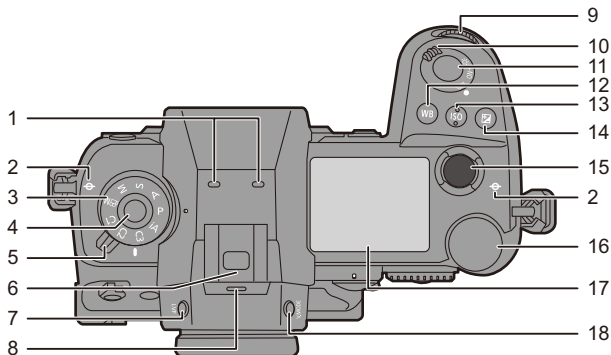

1	Stereo microphone (→ 284) • Do not block the microphone with a finger. Audio will be difficult to record.
2	[] (Recording distance reference mark) (→ 126)
3	Mode dial (→ 63)
4	Mode dial lock button (→ 63)
5	Drive mode dial (→ 131)
6	Hot shoe (hot shoe cover) (→ 228) • Keep the hot shoe cover out of reach of children to prevent swallowing.
7	[LVF] button (→ 69)
8	Speaker (→ 448)
9	Front dial (→ 65)

10	Camera on/off switch (→ 56)/ [::] (Status LCD backlight) (→ 72, 447)
11	Shutter button (→ 61)
12	[WB] (White balance) button (→ 204)
13	[ISO] (ISO sensitivity) button (→ 200)
14	[] (Exposure compensation) button (→ 197)
15	Video rec. button (→ 62, 242)
16	Rear dial (→ 65)
17	Status LCD (→ 33, 248, 447)
18	[V.MODE] button (→ 68)

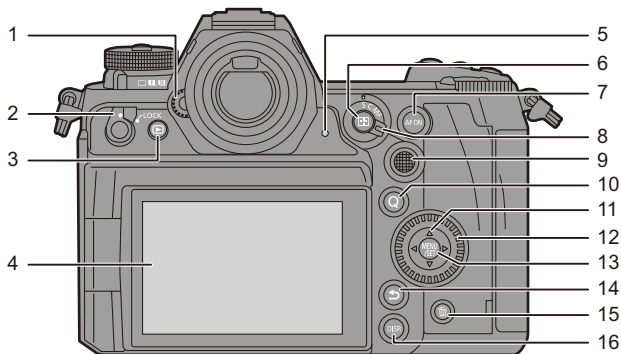

1	Diopter adjustment dial (→ 68)
2	Operation lock lever (→ 67)
3	[▶] (Playback) button (→ 347)
4	Monitor (→ 32, 542)/ Touch screen (→ 66)
5	Rear tally lamp (→ 242)
6	[] (AF mode) button (→ 97)
7	[AF ON] button (→ 98)
8	Focus mode lever (→ 96, 97, 123)
9	Joystick (→ 66)/ Fn buttons (→ 367) Center: Fn8, ▲: Fn9, ►: Fn10, ▼: Fn11, ◀: Fn12

10	[Q] (Quick menu) button (→ 73)
11	Cursor buttons (→ 65)/ Fn buttons (→ 367) ▲: Fn13, ►: Fn14, ▼: Fn15, ◀: Fn16
12	Control dial (→ 65)
13	[MENU/SET] button (→ 65, 77)
14	[↵] (Cancel) button (→ 79)
15	[] (Delete) button (→ 357)
16	[DISP.] button (→ 70)



- The following buttons light when the camera on/off switch is set to [: :]. The lighting timing can be changed in [Illuminated Button] in the [Custom] ([Operation]) menu. (→ 429)
 - [▶] button/[Q] button/[↵] button/[] button/[DISP.] button

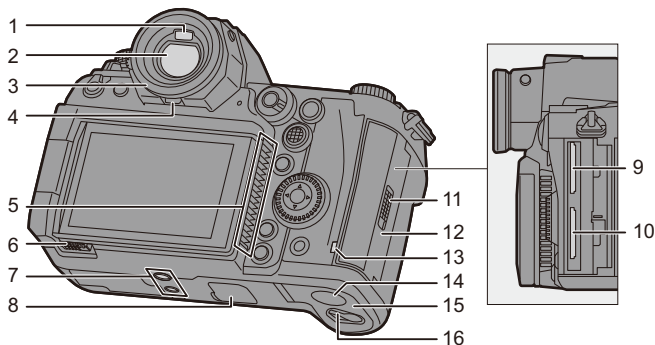

1	Eye sensor (→ 69)		
2	Viewfinder (→ 32, 69, 542)		
3	Eye cup (→ 572)		
4	Eye cup lock lever (→ 572)		
5	Fan inlet <ul style="list-style-type: none"> • The fan inlet for the cooling fan. • Do not obstruct this unit's ventilation openings with newspapers, tablecloths, curtains, and similar items. 		
6	Monitor lock lever (→ 55)		
7	Tripod mount (→ 576) <ul style="list-style-type: none"> • If you attempt to attach a tripod with a screw length of 5.5 mm (0.22 inch) or more, you may not be able to securely fix it in place or it may damage the camera. 		
8	Battery grip connector (cover for the battery grip connector) (→ 539) <ul style="list-style-type: none"> • Keep the cover for the battery grip connector out of reach of children to prevent swallowing. 		
9	Card slot 1 (→ 48)		
10	Card slot 2 (→ 48)		
11	Card door lock lever (→ 48)		
12	Card door (→ 48)		
13	Card access light (→ 49)		
14	DC Coupler cover (→ 541) <ul style="list-style-type: none"> • When using an AC adaptor, ensure that the Panasonic DC Coupler (DMW-DCC16: optional) and AC Adaptor (DMW-AC10: optional) are used. 		
15	Battery door (→ 39)		
16	Battery door release lever (→ 39)		

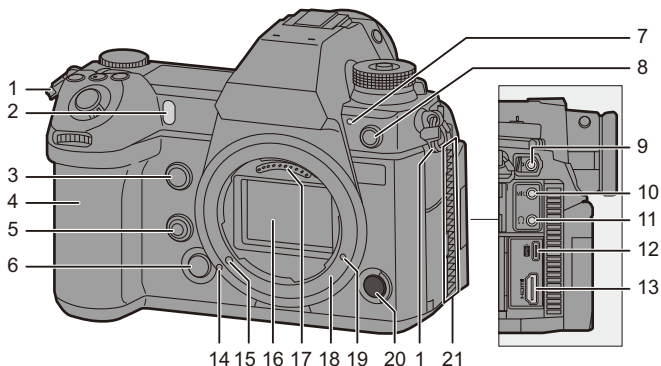

1	Shoulder strap eyelet (→ 34)	10	[MIC] socket (→ 340)
2	Self-timer light (→ 158)/ AF assist light (→ 401)	11	Headphone socket (→ 345) • Excessive sound pressure from earphones and headphones can cause hearing loss.
3	Fn button (Fn1) (→ 367)	12	USB port (→ 41, 522)
4	Grip	13	[HDMI] socket (→ 329, 522)
5	Preview button (→ 196)/ Fn button (Fn2) (→ 367)	14	Lens fitting mark (→ 52)
6	Lens release button (→ 53)	15	Lens lock pin
7	Front tally lamp (→ 242)	16	Sensor
8	Flash synchro socket (flash synchro socket cap) (→ 229) • Use the flash with a synchronization voltage of 250 V or less. • Connect the supplied BNC conversion cable (for TC IN/OUT) when synchronizing the time code with an external device. (→ 268) • Keep the flash synchro socket cap out of reach of children to prevent swallowing.	17	Contact points
9	[REMOTE] socket (→ 540)	18	Mount
		19	Screw hole for function expansion • This is a hole that will be used in a future function expansion.
		20	Sub video rec. button (→ 62, 242)
		21	Fan outlet • The fan outlet for the cooling fan. • Do not obstruct this unit's ventilation openings with newspapers, tablecloths, curtains, and similar items.

Viewfinder/Monitor Displays

At the time of purchase, the viewfinder/monitor displays the following icons.

- For information about the icons other than those described here, refer to page 542.

Viewfinder

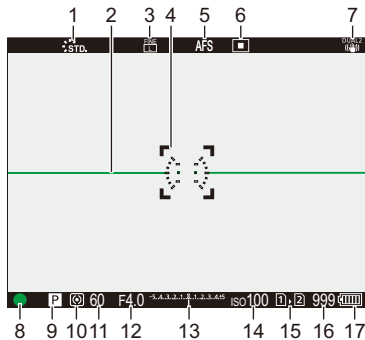

Monitor

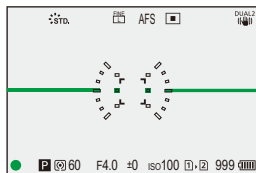

1	Photo Style (→ 210)
2	Level gauge (→ 438)
3	Picture quality (→ 90)/ Picture size (→ 88)
4	AF area (→ 118)
5	Focus mode (→ 96, 123)
6	AF mode (→ 103)
7	Image stabilizer (→ 177)
8	Focus (green) (→ 61, 98)/ Recording state (red) (→ 223, 242)
9	Recording mode (→ 63)

10	Metering mode (→ 185)
11	Shutter speed (→ 61)
12	Aperture value (→ 61)
13	Exposure compensation value (→ 197)/ Manual Exposure Assist (→ 194)
14	ISO sensitivity (→ 200)
15	Card slot (→ 48)/ Double card slot function (→ 92)
16	Number of still images that can be taken (→ 582)/ Number of pictures that can be taken continuously (→ 134)
17	Battery indication (→ 44)



- Press [] to switch between display/hide of the level gauge.

Status LCD Display

The following recording settings are displayed when recording pictures.

- Refer to page 248 for information on the [CM] mode (Creative Video mode) display.

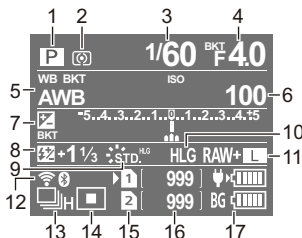

1	Recording mode (→ 63)	10	HLG photo (→ 226)
2	Metering mode (→ 185)	11	Picture quality (→ 90)/ Picture size (→ 88)
3	Shutter speed (→ 61)	12	Wi-Fi/Bluetooth connection state (→ 466)
4	Aperture value (→ 61)/ Aperture Bracket (→ 163)	13	Drive mode (→ 131)/Post-Focus (→ 166)/High Resolution mode (→ 222)
5	White balance (→ 204)/ White Balance Bracket (→ 165)	14	AF mode (→ 103)
6	ISO sensitivity (→ 200)/ Dual Native ISO setting (→ 203)	15	Card slot (→ 48)/ Double card slot function (→ 92)
7	Exposure compensation (→ 197)/ Exposure Bracket (→ 163)	16	Number of still images that can be taken (→ 582)/ Number of pictures that can be taken continuously (→ 134)
8	Flash output adjustment (→ 235)	17	Battery indication (→ 44)/ Power supply (→ 43)
9	Photo Style (→ 210)/ Filter settings (→ 216)		



- Turning on the status LCD backlight. (→ 72)
- You can change the color of text, the background color, and how the backlight turns on for the status LCD:

[] → [] → [Status-LCD] (→ 447)

2. Getting Started

Attaching a Shoulder Strap

Attach a shoulder strap to the camera with the following procedure to prevent it from dropping.

- 1 Pass the shoulder strap through the shoulder strap eyelet (A).**
- 2 Pass the end of the shoulder strap through the ring and then pass it through the fastener.**
- 3 Pass the end of the shoulder strap through the other hole of the fastener.**
- 4 Pull the shoulder strap and check that it will not come out.**
 - Attach the opposite end of the shoulder strap with the same procedure.

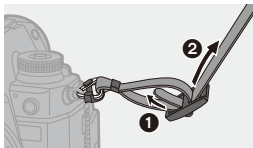
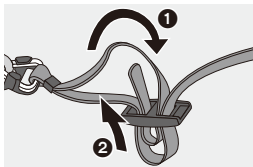
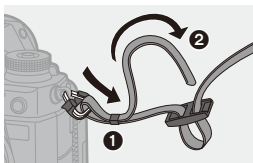
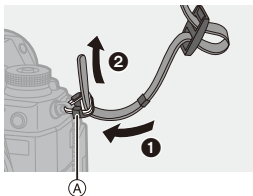



- Use the shoulder strap around your shoulder.
 - Do not wrap the strap around your neck.
It may result in injury or accident.
- Do not leave the shoulder strap where an infant can reach it.
 - It may result in an accident by mistakenly wrapping around the neck.

Charging the Battery

You can charge the battery either using the supplied charger, or in the camera body.

You can also charge by connecting to a USB PD (USB Power Delivery) compatible device using the supplied USB connection cable (C–C).

Furthermore, you can turn the camera on while it is charging and record.

- The battery that can be used with the camera is DMW-BLJ31. (As of August 2019)



- The battery is not charged at the time of purchase. Charge the battery before use.

Charging with the Charger

Charging time	Approx. 130 min
----------------------	-----------------

- Use the supplied charger and AC adaptor.
- The indicated charging time is for when the battery has been discharged completely. The charging time may vary depending on how the battery has been used. The charging time for the battery in hot/cold environments or a battery that has not been used for a long time may be longer than normal.



- **Use the products supplied with the camera for charging.**
- Use the charger indoors.

1 Connect the charger and the AC adaptor with the USB connection cable (C-C).

- Hold the plugs and insert them straight in or pull them straight out.
(Inserting these at an angle may cause deformation or malfunction)

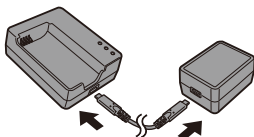

2 Connect the AC cable to the AC adaptor and then insert into the electrical outlet.

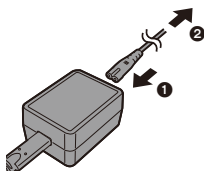

3 Insert the battery.

- Insert the terminal end of the battery and push.
- The [CHARGE] light (A) blinks and charging begins.

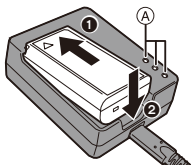

- Do not use any other USB connection cables except the supplied USB connection cable (C-C).
This may cause malfunction.
- Do not use any other AC adaptors except the supplied one.
This may cause malfunction.
- Do not use any other AC cables except the supplied one.
This may cause malfunction.

❖ [CHARGE] Light Indications

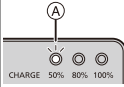
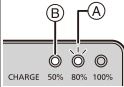
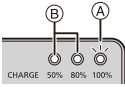
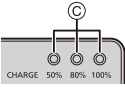
Charging status	0% to 49%	50% to 79%	80% to 99%	100%
[CHARGE] light				

(A) Blinking

(B) On

(C) Off



- After charging, disconnect the power source connection and remove the battery.
- If the [50%] light is blinking quickly, then charging is not occurring.
 - The temperature of the battery or surroundings is either too high or too low. Try charging at an ambient temperature between 10 °C and 30 °C (50 °F and 86 °F).
 - The terminals of the charger or the battery are dirty. Remove the connection to the power source, and wipe with a dry cloth.

Battery Insertion

- Always use genuine Panasonic batteries (DMW-BLJ31).
- If you use other batteries, we cannot guarantee the quality of this product.

1 Set the camera on/off switch to [OFF].

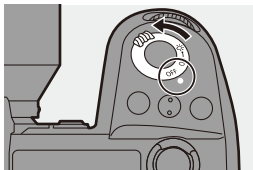

2 Open the battery door.

- Move the battery door release lever to the [OPEN] position.

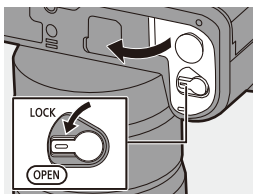

3 Insert the battery.

- Insert the terminal end of the battery and push until a locking sound is heard.
- Check that the lever (A) is holding the battery in place.

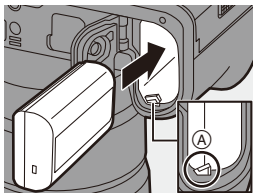

4 Close the battery door.

- Close the battery door, and move the battery door release lever to the [LOCK] position.

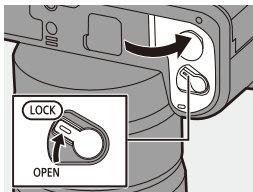

❖ Removing the Battery

- 1 Set the camera on/off switch to [OFF].
- 2 Open the battery door.
 - Check that the card access light (A) is turned off and then open the battery door.
- 3 Push the lever (B) in the direction of the arrow and then remove the battery.

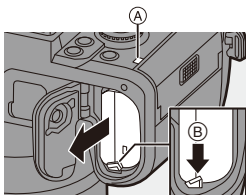

- Ensure that no foreign objects are adhering to the inner side (rubber seal) of the battery door.
- Remove the battery after use.
(The battery will drain if left inserted in the camera for a long period of time.)
- The battery becomes warm after use, during charging, and immediately after charging.
The camera also becomes warm during use. This is not a malfunction.
- Be careful when removing the battery as the battery will jump out.

Inserting a Battery into the Camera for Charging

Charging time	Approx. 140 min
----------------------	-----------------

- Using the camera body and the supplied AC adaptor.
The camera is turned off.
- The indicated charging time is for when the battery has been discharged completely.
The charging time may vary depending on how the battery has been used.
The charging time for the battery in hot/cold environments or a battery that has not been used for a long time may be longer than normal.

- Use the products supplied with the camera for charging.

- 1** Set the camera on/off switch to [OFF].
- 2** Insert the battery into the camera.
- 3** Connect the camera USB port and the AC adaptor using the USB connection cable (C-C).

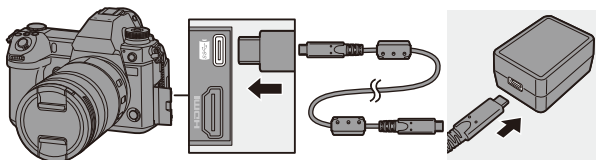

- Hold the plugs and insert them straight in or pull them straight out.
(Inserting these at an angle may cause deformation or malfunction)

4 Connect the AC cable to the AC adaptor and then insert into the electrical outlet.

- [CHARGE] is displayed on the status LCD and charging starts.
[FULL] is displayed when charging is complete.

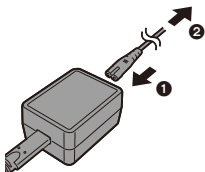

- You can also charge the battery by connecting a USB device (PC, etc.) and the camera with the USB connection cable (C–C or A–C).
In that case, charging may take a while.
- When using the Battery Grip (DMW-BGS1: optional), the battery within the Battery Grip will also be charged.



- Do not use any other USB connection cables except the supplied USB connection cables (C–C and A–C).
This may cause malfunction.
- Do not use any other AC adaptors except the supplied one.
This may cause malfunction.
- Do not use any other AC cables except the supplied one.
This may cause malfunction.
- After charging, disconnect the connection to the power source.
- When an [ERROR] is displayed on the status LCD, charging is not possible.
 - The temperature of the battery or surroundings is either too high or too low.
Try charging at an ambient temperature between 10 °C and 30 °C (50 °F and 86 °F).
 - The terminals of the battery are dirty.
Remove the battery and wipe off the dirt with a dry cloth.
- Even when the camera on/off switch is set to [OFF] thus turning the camera off, it consumes power.
When the camera will not be used for a long time, remove the power plug from the electrical outlet in order to save power.

Using the Camera While Supplying It with Power (Supplying Power/Charging)

When charging with both the camera body and the supplied AC adaptor (→ 41), you can charge while the camera is being supplied with power by turning the camera on. You can record while charging.

This is also possible by connecting devices that support USB PD (USB Power Delivery) to the camera.

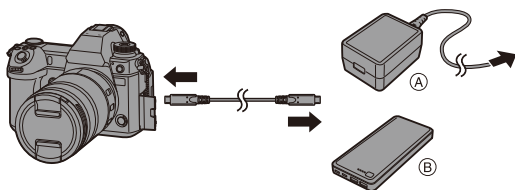

(A) AC adaptor



(B) Devices that support USB PD (mobile battery, etc.)

- Insert the battery into the camera.
- Connect using the supplied USB connection cable (C–C).
- Use a device (mobile battery, etc.) with an output of 9 V/3 A (27 W or more) that supports USB PD.
- When the camera is on, charging will take longer than when the camera is off.



- Even when connecting with devices that support USB PD, you may not be able to charge while using the camera.
- If connecting with devices (PC, etc.) that do not support USB PD and turning the camera on, then this will supply power only.
- Turn off the camera before connecting or disconnecting the power plug.
- Remaining charge in the battery may decrease depending on usage conditions. When the battery level is depleted, the camera will turn off.
- Depending on the power supply capabilities of the connected device, it may not be possible to supply power.



- USB power supply can be turned off:
[] → [] → [USB] → [USB Power Supply] (→ 449)

Notifications Regarding Charging/Power Supply

❖ Power Indications

Indication on status LCD

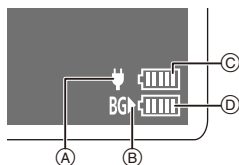

Indication on monitor

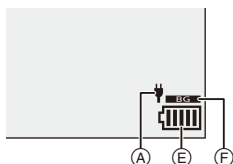

- Ⓐ USB connection cable supplying power
- Ⓑ Power source
- Ⓒ The battery level of the battery in the camera
- Ⓓ The battery level of the battery in the Battery Grip
- Ⓔ Battery indication
- Ⓕ Using the battery in the Battery Grip

	80% or higher
	60% to 79%
	40% to 59%
	20% to 39%
	19% or below
 Blinking	Low battery • Charge or replace the battery.

- The battery level indicated on the screen is approximate.
The exact level varies depending on the environment and the operating conditions.
- The highest battery level reading of Ⓒ or Ⓓ blinks during charging.
- When a charging error occurs, the status LCD display icon Ⓐ blinks.



• It has been found that counterfeit battery packs which look very similar to the genuine product are made available for purchase in some markets. Some of these battery packs are not adequately protected with internal protection to meet the requirements of appropriate safety standards. There is a possibility that these battery packs may lead to fire or explosion. Please be advised that we are not liable for any accident or failure occurring as a result of use of a counterfeit battery pack. To ensure that safe products are used, we recommend that a genuine **Panasonic battery pack is used.**

• Do not leave any metal items (such as clips) near the contact areas of the power plug.

Otherwise, a fire and/or electric shocks may be caused by short-circuiting or the resulting heat generated.

• Do not use the AC adaptor, AC cable, or USB connection cables (C–C and A–C) on other devices.

This may cause a malfunction.

• Do not use USB extension cables or USB conversion adaptors.

• The battery can be charged even when it still has some charge left, but it is not recommended that the battery charge be frequently topped up while the battery is fully charged.

(Since characteristic swelling may occur.)

• If there is a power outage or other problem with the electrical outlet, then charging may not complete successfully.



Reconnect the power plug.

• Do not connect to keyboard or printer USB ports, or to USB hubs.



• If the connected PC enters sleep status, then charging/power supply may stop.



• The battery level display on the monitor can be changed to a percentage:



[] ⇒ [] ⇒ [Remaining Battery Level] (→ 446)

• You can confirm the degree of deterioration of the battery:

[] ⇒ [] ⇒ [Battery Information] (→ 450)

[Power Save Mode]

This is a function to automatically turn the camera to sleep (power save) status or turn off the viewfinder/monitor if no operation is performed for a set time. Reduces battery consumption.

 → [] → [] → Select [Power Save Mode]

[Sleep Mode]	Sets the amount of time until the camera is put to sleep.	
[Sleep Mode(Wi-Fi)]	Sets the camera to sleep 15 minutes after being disconnected from Wi-Fi.	
[Auto LVF/Monitor Off]	Sets the amount of time it takes for the viewfinder/monitor to turn off. (The camera is not turned off.)	
[Power Save LVF Shooting]	Puts the camera to sleep when the recording screen is being displayed on the monitor when automatic viewfinder/monitor switching is active. <ul style="list-style-type: none"> • [Power Save LVF Shooting] does not work when [Time to Sleep] is set to [OFF]. 	
	[Time to Sleep]	Sets the amount of time until the camera is put to sleep.
	[Method of Activation]	Sets the screen where the camera is put to sleep. [Only Control Panel]: Puts the camera to sleep only when the control panel (→ 70) is displayed. [While Recording Standby]: Puts the camera to sleep from any screen during recording standby.

- To recover from [Sleep Mode], [Sleep Mode(Wi-Fi)], or [Power Save LVF Shooting], perform one of the following operations:
 - Press the shutter button halfway.
 - Set the camera on/off switch to [OFF] and then [ON] again.
- To recover from [Auto LVF/Monitor Off], press any button.



- [Power Save Mode] is not available in the following cases:
 - While connected to a PC or printer
 - During video recording/video playback
 - When recording with [6K/4K Pre-Burst]
 - During a [Time Lapse Shot]
 - When recording with [Stop Motion Animation] (when [Auto Shooting] is set)
 - When recording with [Multiple Exposure]
 - When recording with [Focus Transition]
 - During a [Slide Show]
 - During HDMI output for recording

Inserting Cards (Optional)

This camera supports the double card slot function.

When two cards are used, relay recording, backup recording, and allocation recording are available.

For information about the cards that can be used, refer to page 25.

1 Open the card door.

- Slide the card door in the direction of the arrow while pushing down the card door lock lever.

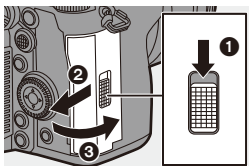

2 Insert the cards.

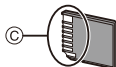
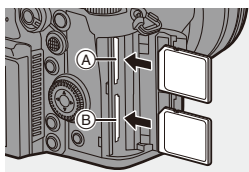

- (A) Card slot 1
- (B) Card slot 2
- Match the orientation of the cards as shown in the figure and then insert them firmly until they click.
- Do not touch the card connection contacts (C).

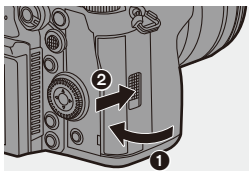

3 Close the card door.

- Close the card door and slide it firmly in the direction of the arrow until it clicks.
- The cards are displayed on the status LCD.



- ➔ • You can set the way to record to card slots 1 and 2:
[] ➔ [] ➔ [Double Card Slot Function] (➔ 92)

❖ Card Access Indications

The card access light turns on while the card is being accessed.

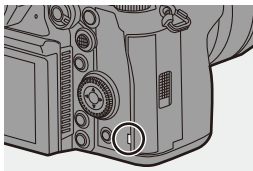

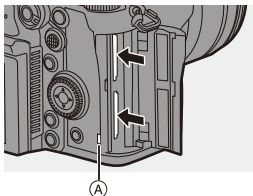

❖ Removing a Card

- 1 Open the card door.
 - Check that the card access light (A) is turned off and then open the card door.
- 2 Push the card until it clicks and then pull the card out straight.



-  • The card may be warm just after the camera has been used. Be careful when removing.
- **Do not perform the following operations during access. The camera may operate incorrectly or the card and recorded images may be damaged.**
 - Turn off the camera.
 - Remove the battery or card or disconnect the power plug.
 - Subject the camera to vibration, impacts, or static electricity.

- ➔ • You can set so that the card access light does not turn on:
[] ➔ [] ➔ [Card Access Light] (➔ 452)

Formatting Cards (Initialization)

Format the cards with the camera before use in order to ensure optimal card performance.



- **When a card is formatted, all of the data stored in the card is erased and cannot be restored.**

Save a backup of necessary data before formatting the card.



⇒ [] ⇒ [] ⇒ Select [Card Format]



Settings: [Card Slot 1]/[Card Slot 2]



- Do not turn off the camera or perform another operation during formatting.
- Take care not to turn off the camera while formatting is in progress.
- Cards that have not been formatted after purchase should be formatted on the camera.
- If the card has been formatted with a PC or other device, format it again with the camera.



- You can format the card while keeping the camera settings information stored on the card:

[] ⇒ [] ⇒ [Save/Restore Camera Setting] ⇒ [Keep Settings While Format] (→ [389](#))

Attaching a Lens

You can attach the Leica Camera AG L-Mount standard lens to this camera.

For information about the lens that can be used, refer to page 24.

-  • Change the lens in a location where there is not a lot of dirt and dust. If dirt or dust gets on the lens, refer to page 571.
- Change the lens while the lens cap is attached.

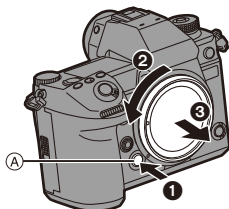
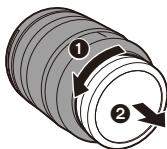

- 1** Set the camera on/off switch to [OFF].
- 2** Turn the lens rear cap and the body cap in the direction of the arrow to remove them.
 - When removing the body cap, rotate it while pressing the lens release button (A).

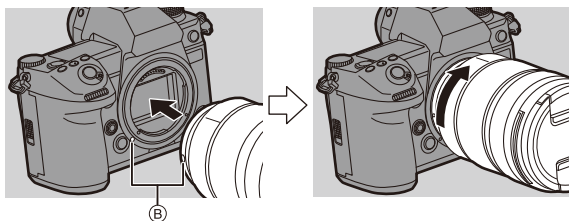

3 Align the lens fitting marks **(B)** on the lens and camera and then rotate the lens in the direction of the arrow.

- Attach the lens by rotating it until it clicks.



- When you have attached a lens that does not have a communication function with this camera, after turning on the camera, a message asking for confirmation of the lens information is displayed. You can register items such as the image circle and focal length for the lens when you select [Yes].
(→ 183)
- You can change the settings so that the confirmation message is not displayed:
[] ⇒ [] ⇒ [Lens Info. Confirmation] (→ 443)
- Insert the lens straight in.
Inserting this at an angle to attach it may damage the camera lens mount.

❖ Removing a Lens

- 1 Set the camera on/off switch to [OFF].
- 2 While pressing the lens release button (A), rotate the lens in the direction of the arrow until it stops and then remove it.

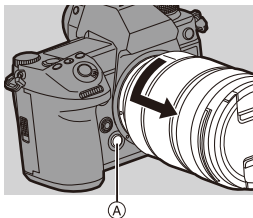

- After removing the lens, be sure to attach the body cap and the lens rear cap.

Adjusting the Monitor Direction and Angle

The monitor on this camera has angling and tilting that you can adjust in combinations to freely change the orientation and angle.

At the time of purchase, the monitor is stowed in the camera body. Turn the monitor surface out before use.

1 Open the monitor.

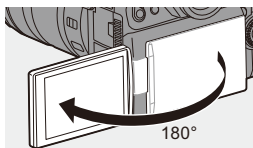

2 Rotate the monitor.

- You can rotate 180° towards the lens and 90° down.

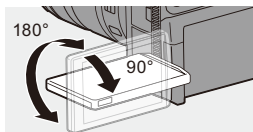

3 Return the monitor to the original position.

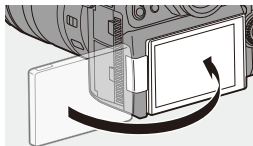

❖ Tilt

While sliding the monitor lock lever in the direction of the arrow, push the monitor up.

- The monitor of this camera can be tilted in two stages.
- The monitor can still be opened when tilted to 30°.

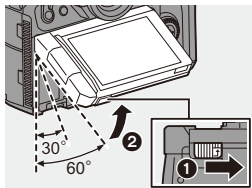

- The angles of adjustment are guides only.
- Take care not to trap a finger in the monitor.
- Do not apply an excessive force to the monitor. This may cause damage or malfunction.
- When not using the camera, close the monitor with the monitor surface facing in.

Setting the Clock (When Turning On for the First Time)

When you turn the camera on for the first time, a screen to set the time zone and clock appears.

Be sure to set these settings before use to ensure images are recorded with the correct date and time information.

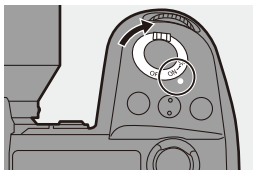

1 Set the camera on/off switch to [ON].

- If the language select screen is not displayed, proceed to Step 4.









2 When [Please set the language] appears, press or .

3 Set the language.

- Press   to select the language and then press  or .

4 When [Please set the time zone] appears, press or .

5 Set the time zone.

- Press   to select the time zone and then press  or .
- If you are using Daylight Savings , press . (The time will move forward by 1 hour.)
To return to the normal time, press  again.



- (A) Time difference from GMT (Greenwich Mean Time)



6 When [Please set the clock] appears, press  or .

7 Set the clock.

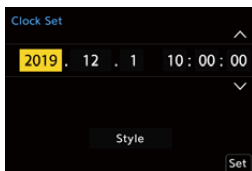
- ◀▶: Select an item (year, month, day, hour, minute, or second).
- ▲▼: Select a value.



To set the display order  and time display format 

- Press ▶◀ to select the time zone [Style] and then press  or , the screen for setting the display order and time display format appears.

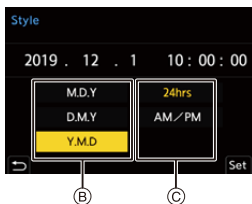

8 Confirm your selection.

- Press  or .

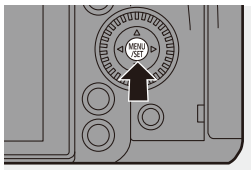





9 When [The clock setting has been completed.] appears, press  or .



- If the camera is used without setting the clock, it will be set to 0:00:00, January 1st 2019.
- Clock settings are maintained for approx. 3 months using the built-in clock battery even without the battery.
(Leave the fully-charged battery in the camera for approx. 24 hours to charge the built-in battery.)



- [Time Zone] and [Clock Set] can be changed from the menu:
 - [] ⇒ [] ⇒ [Time Zone] (→ [454](#))
 - [] ⇒ [] ⇒ [Clock Set]

3. Basic Operations

Basic Recording Operations

How to Hold the Camera

To minimize camera shake, hold the camera so that it will not move during recording.

Hold the camera with both hands, keep your arms still at your side, and stand with your feet shoulder width apart.

- Hold the camera firmly by wrapping your right hand around the camera grip.
- Support the lens from below with your left hand.
- Do not cover the AF assist light (A) or microphone (B) with your fingers or other objects.
- Do not cover the fan inlet (C) and fan outlet (D) of the cooling fan with your hand, etc.

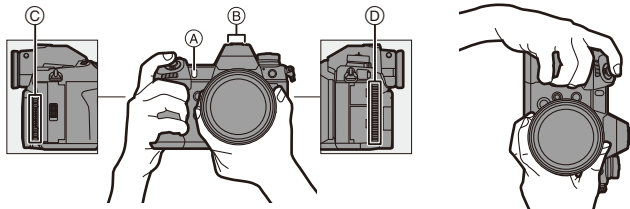

❖ Vertical Orientation Detection Function

This function detects when pictures were recorded with the camera held vertically orientated.

With the default settings, pictures are automatically played back vertically orientated.

- If you set [Rotate Disp.] to [OFF], pictures will be played back without being rotated. (→ [457](#))



- When the camera is tilted significantly up or down, the vertical orientation detection function may not work correctly.
- Images recorded using the following functions cannot be displayed vertically orientated:
 - Video recording/[6K/4K PHOTO]/[Post-Focus]

Taking Pictures

1 Adjust the focus.

- Press the shutter button halfway (press it gently).
- The aperture value (A) and shutter speed (B) are displayed. (When the correct exposure cannot be obtained, the indications blink in red.)
- Once the subject is in focus, the focus indication (C) lights. (When the subject is not in focus, the indication blinks.)
- You can also perform the same operation by pressing [AF ON].

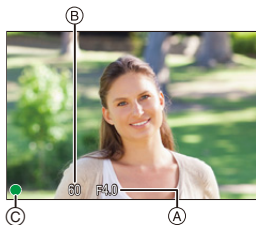
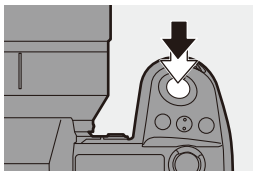

2 Start recording.

- Press the shutter button fully (press it further).

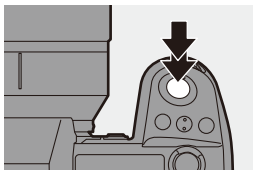



Recorded pictures can be displayed automatically by setting [Auto Review] of the [Custom] ([Monitor / Display (Photo)]) menu. You can also change the picture display duration to your preferred setting. (→ 430)



With the default settings, you cannot take a picture until the subject is brought into focus.

If you set [Focus/Shutter Priority] in the [Custom] ([Focus/Shutter]) menu to [BALANCE] or [RELEASE], you will be able to take a picture even when the subject is not in focus. (→ 421)

Recording Videos

1 Start recording.

- Press the video rec. button (A).
- You can also perform the same operation by pressing the sub video rec. button (B).
- Release the video rec. button right after you press it.

2 Stop recording.

- Press the video rec. button again.
- You can also perform the same operation by pressing the sub video rec. button (B).

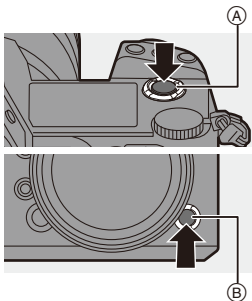

Selecting the Recording Mode

While pressing the mode dial lock button **1**, rotate the mode dial **2**.

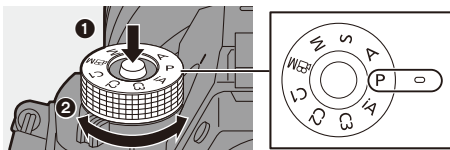

[iA]	Intelligent Auto mode (→ 81)
[P]	Program AE mode (→ 186)
[A]	Aperture-Priority AE mode (→ 188)
[S]	Shutter-Priority AE mode (→ 191)
[M]	Manual Exposure mode (→ 193)
[iA]	Creative Video mode (→ 247)
[C1]/[C2]/[C3]	Custom mode (→ 383)

Camera Setting Operations

When changing the camera settings, operate the camera using the following operation parts.

To prevent accidental operation, you can disable operation with the operation lock lever.

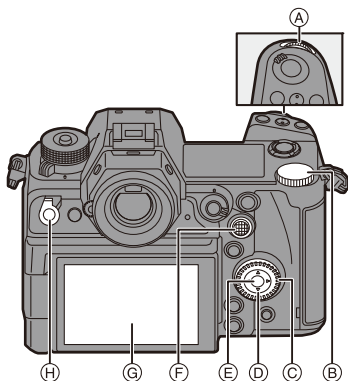

(A)	Front dial (→ 65)
(B)	Rear dial (→ 65)
(C)	Control dial (→ 65)
(D)	Cursor buttons (→ 65)
(E)	[MENU/SET] button (→ 65)
(F)	Joystick (→ 66)
(G)	Touch screen (→ 66)
(H)	Operation lock lever (→ 67)

❖ Front Dial ()/Rear Dial ()

Rotate:

Selects an item or numeric value.

- Sets the aperture, shutter speed, and other settings when you are recording in the [P]/[A]/[S]/[M] modes.

The operation method can be changed in [Dial Set.]. (→ 428)

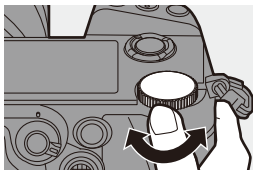

❖ Control Dial ()

Rotate:

Selects an item or numeric value.

- Adjusts the headphone volume during recording.

The function can be changed in [Control Dial Assignment] of [Dial Set.]. (→ 428)

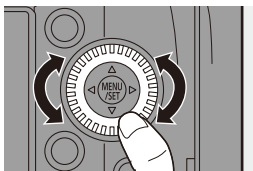

❖ Cursor Buttons ()

Press:

Selects an item or numeric value.

❖ [MENU/SET] Button ()

Press:

Confirms a setting.

- Displays the menu during recording and playback.

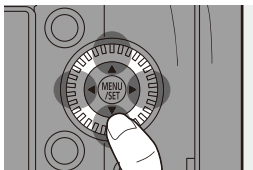

❖ Joystick (▲▼◀▶/🌀)

The joystick can be operated in 8 directions by tilting it up, down, left, right and diagonally and by pressing the center part.

(A) **Tilt:** Selects an item or numeric value, or moves a position.

- Place your finger on the center of the joystick before tilting. The joystick may not work as expected when the sides are pressed.

(B) **Press:** Confirms a setting.

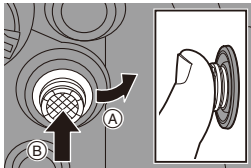

- When recording, this moves the AF area and MF Assist.

The joystick functions for recording can be changed in [Joystick Setting]. (→ 429)

❖ Touch Screen

Operations can be performed by touching the icons, slide bars, menus, and other items displayed on the screen.

(A) **Touch**

Operation of touching and then lifting your finger from the touch screen.

(B) **Drag**

Operation of moving a finger while it touches the touch screen.

(C) **Pinch (widen/narrow)**

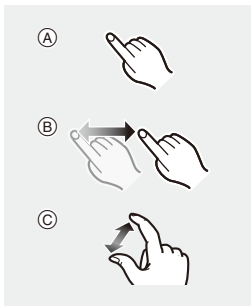

Operations of widening the distance between two fingers (pinch out) and narrowing the distance between two fingers (pinch in) while they are touching the touch screen.





- Touch the screen with clean and dry fingers.
- If you will use a commercially available monitor protection sheet, observe the precautions for the sheet.
(Visibility and operability may be impaired depending on the type of monitor protection sheet.)
- The touch screen may not operate correctly in the following cases:
 - When you are wearing gloves
 - When the touch screen is wet



- Touch operations can be disabled:
[] ⇒ [] ⇒ [Touch Settings] (→ 425)

❖ Operation Lock Lever

Aligning the operation lock lever with the [LOCK] position disables the following operation parts.

The operation parts to disable can be set in [Lock Lever Setting] of the [Custom] ([Operation]) menu. (→ 426)

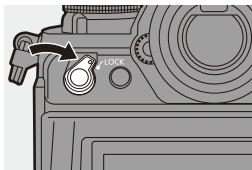

- Cursor buttons
- [MENU/SET] button
- Joystick
- Touch screen
- Front dial
- Rear dial
- Control dial

Display Settings

Setting the Viewfinder

❖ Adjusting the Viewfinder Diopter

Rotate the diopter adjustment dial while looking through the viewfinder.

- Adjust until you can clearly see the text on the viewfinder.

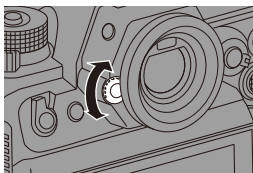

❖ Switching the Viewfinder Display Magnification

Press [V.MODE].

- The display magnification of the viewfinder can be switched between 3 levels.

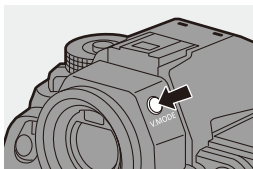

Switching Between the Monitor and Viewfinder

With the default settings, automatic viewfinder/monitor switching is set. When you look through the viewfinder, the eye sensor (A) works and the camera switches from monitor display to viewfinder display. You can switch to viewfinder display or monitor display with [LVF] button (B).

Press [LVF].

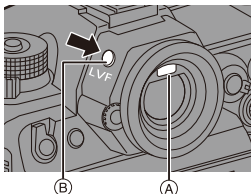

Automatic viewfinder/
monitor switching

Viewfinder display

Monitor display



- The eye sensor does not work while the monitor is tilted.
- The eye sensor may not work correctly due to the shape of eyeglasses, the way the camera is held, or bright light shining around the eyepiece.
- During video playback or slide show, automatic viewfinder/monitor switching does not work.

- ➔ To focus when looking through the viewfinder:
[⚙️] → [AF] → [Eye Sensor AF] (→ 424)
- The sensitivity of the eye sensor can be changed:
[🔧] → [📷] → [Eye Sensor] (→ 447)

Switching the Display Information

The recording information (icons) on the recording screen and playback screen can be hidden.

The monitor on the back can display the control panel, be turned off, etc.

Press [DISP.].

- The display information is switched.

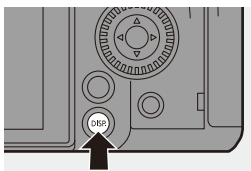

❖ Recording Screen

Monitor

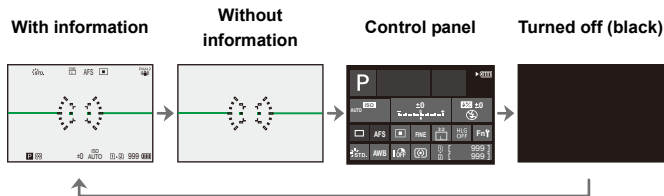



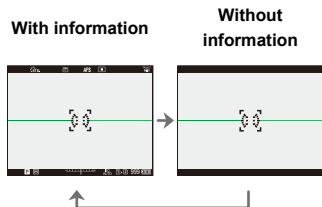

Viewfinder





- Press [] to switch between display/hide of the level gauge.
This can also be set by using [Level Gauge]. (→ 438)



- Control panel operation (→ 75)
- You can hide the control panel and black screen:
[] → [] → [Show/Hide Monitor Layout] (→ 439)
- The display can be changed so that live view and display information do not overlap:
[] → [] → [LVF/Monitor Disp. Set] (→ 435)

❖ Playback Screen

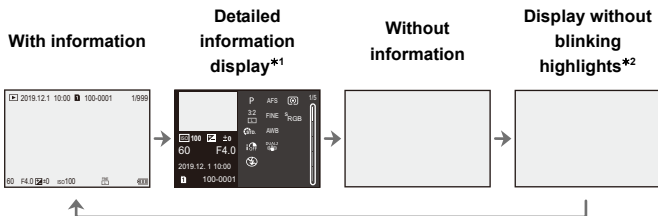

*1 Pressing ▲▼ switches the display information. (→ 552)

- Detailed information display
- Histogram display
- Photo Style display
- White balance display
- Lens information display

*2 This is a screen without blinking highlights display that is shown when [Blinking Highlights] of the [Custom] ([Monitor / Display (Photo)]) is set to [ON].

In other than this screen, overexposed parts of the screen will blink. (→ 436)

Turning On the Status LCD Backlight

Set the camera on/off switch to

[].

- The backlight will turn on.
- When you release the camera on/off switch, it returns to the [ON] position.
- If the camera is left without any operations for a certain period of time, the backlight turns off.
- With the default settings, the illuminated buttons turn on.
- Set the camera on/off switch to [] again or press the shutter button fully to turn off the backlight.
- The status LCD backlight and illuminated buttons do not turn on while you are using the following functions:
 - Video recording/[6K/4K PHOTO]/[Post-Focus]
 - Burst recording
 - Playback
 - Menu
 - Quick menu

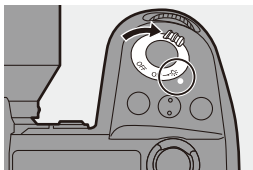

- You can change the color of text, the background color, and how the backlight turns on for the status LCD:

[] → [] → [Status-LCD] (→ [447](#))

Quick Menu

This menu enables you to quickly set functions that are frequently used during recording without calling up the menu screen. You can also change the Quick menu display method and the items to display.

1 Display the Quick menu.

- Press [Q].

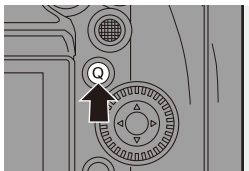

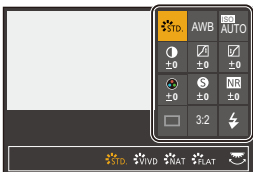

2 Select a menu item.

- Press ▲▼◀▶.
- Directions on the diagonal can also be selected using the joystick.
- Selection is also possible by rotating .
- Selection is also possible by touching a menu item.



3 Select a setting item.

- Rotate  or .
- Selection is also possible by touching a setting item.

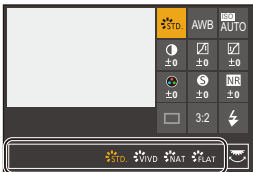

4 Close the Quick menu.

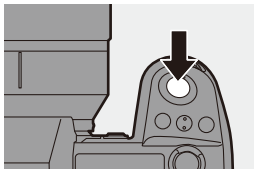

- Press the shutter button halfway.
- You can also close the menu by pressing [Q].





- Some items cannot be set depending on the recording mode or camera settings.



- The Quick menu can be customized:
[] ⇒ [] ⇒ [Q.MENU Settings] (→ [378](#))

Control Panel

This screen allows you to view the current recording settings on the monitor. You can also touch the screen to change the settings.

In the [CAM] mode (Creative Video mode), the display changes to one especially for video. (→ 548)

1 Display the control panel.

- Press [DISP.] several times.



2 Touch the items.

- The setting screens for each of the items are displayed.

3 Change the setting.

Example) Changing the AF mode



- Touch the setting item.
- Refer to the pages explaining each item for information on how to change the settings.



4 Touch [Set].

❖ Changing Directly Using the Dial

Steps **2** to **4** can also be changed using the following operations.

- 1 Press one of ▲▼◀▶ to enable selection of items.
 - Selected items are displayed in yellow.
- 2 Press ▲▼◀▶ to select an item.
 - Selection is also possible by rotating  or .
- 3 Rotate  to change the settings values.

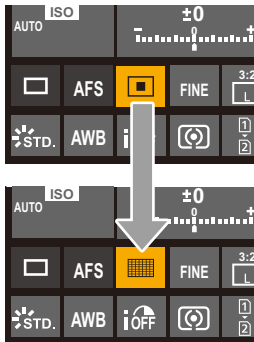

- Some items cannot be set depending on the recording mode or camera settings.

Menu Operation Methods



In this camera, the menu is used for setting a wide variety of functions and performing camera customizations.

Menu operations can be performed using the cursors, joystick, dial, or by touch.

Configuration and operation parts of the menu

The menu can be operated by pressing ◀▶ to move between menu screens. Use the operation parts indicated below to operate the main tab, the sub tab, the page tab, and menu items without moving to the corresponding menu levels.

• You can also operate by touching the icons, menu items, and setting items.

- (A) Main tab ([Q] button)
- (B) Sub tab ()
- (C) Menu item ()
- (D) Page tab ()
- (E) Setting item

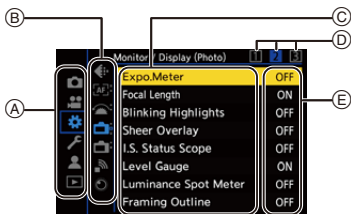

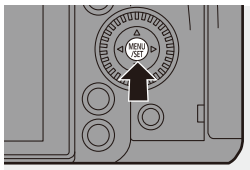

1 Display the menu.

- Press .







2 Select a main tab.

- Press ▲▼ to select a main tab and then press ►.
- You can also perform the same operation by rotating  to select the main tab and then pressing  or .





3 Select a sub tab.

- Press ▲▼ to select a sub tab and then press ►.
- You can also perform the same operation by rotating  to select the sub tab and then pressing  or .
- If there are page tabs  (A), then after the page tabs have finished switching, the next sub tab is switched to.





4 Select a menu item.

- Press ▲▼ to select a menu item and then press ►.
- You can also perform the same operation by rotating  to select the menu item and then pressing  or .



5 Select a setting item and then confirm your selection.

- Press ▲▼ to select a setting item and then press **MENU/SET** or .
- You can also perform the same operation by rotating  to select the setting item and then pressing **MENU/SET** or .



- The display and selection methods of setting items differ depending on the menu item.

6 Close the menu.

- Press the shutter button halfway.
- You can also close the menu by pressing **[DISP.]** several times.

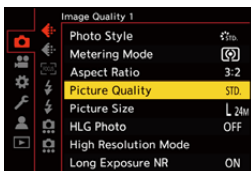

 • For details about menu items, refer to Menu Guide. (→ 390)

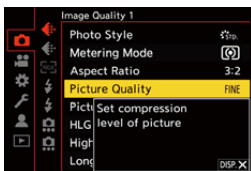

❖ Displaying Descriptions About Menu Items and Settings

If you press **[DISP.]** while a menu item or setting item is selected, a description about the item is displayed on the screen.



❖ Grayed Out Menu Items

Menu items that cannot be set are displayed grayed out.

If you press  or  while a grayed out menu item is selected, the reason why it cannot be set is displayed.

- The reason why a menu item cannot be set may not be displayed depending on the menu item.

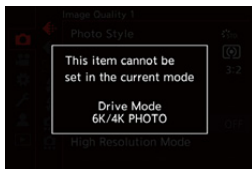



[Reset]

Return each of the following settings to the default setting:

- Recording settings
- Network settings (settings of [Wi-Fi Setup] and [Bluetooth])
- Setup and custom settings (other than [Wi-Fi Setup] and [Bluetooth])

 ⇒ [] ⇒ [] ⇒ Select [Reset]

-  • If the setup and custom settings are reset, the [Playback] menu is also reset.
- If the setup and custom settings are reset, [Lens Information] in [Image Stabilizer] in the [Photo] ([Others (Photo)]) menu/[Video] ([Others (Video)]) menu is also returned to the default setting.
- The folder numbers and clock settings are not reset.
-  • List of default settings and settings that can be reset (→ [587](#))

Intelligent Auto Mode

iA P A S M



The [iA] mode (Intelligent Auto mode) can record images using settings automatically selected by the camera.

The camera detects the scene to set the optimal recording settings automatically to match the subject and recording conditions.

1 Set the mode dial to [iA].

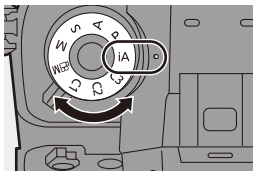

2 Aim the camera at the subject.

- When the camera detects the scene, the recording mode icon changes.
(Automatic Scene Detection)



3 Adjust the focus.

- Press the shutter button halfway.
- Once the subject is in focus, the focus indication lights.
(When the subject is not in focus, the indication blinks.)

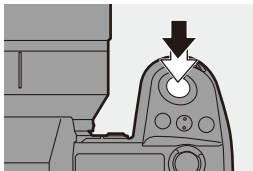

- [AF-ON] of the AF mode works and the AF area is displayed aligned to any humans or animals.

4 Start recording.

- Press the shutter button fully.

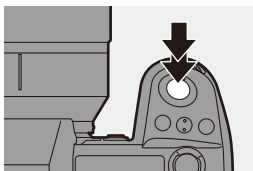

- Backlight compensation operates automatically to prevent subjects from appearing dark when there is a backlight.

❖ Types of Automatic Scene Detection

 : Scenes detected during picture taking

 : Scenes detected during video recording



 :
i-Portrait & Animal



 :
i-Portrait*¹



 :
i-Scenery



 :
i-Macro



 :
i-Night Portrait*²



 :
i-Night Scenery



 :
i-Food



 :
i-Sunset



 :
i-Low Light



 :
iA

*1 Detected when animal detection is disabled.



*2 Detected when using an external flash.

- If none of the scenes are applicable, recording is with [iA] (standard setting).
- Different scene types may be selected for the same subject depending on the recording conditions.

❖ AF Mode

Changing the AF mode.

- Each press of [] changes the AF mode.

<p>[] ([Face/Eye/ Body/Animal Detect.])</p>	<p>The camera detects a person's face, eyes, and body (entire body or upper half of the body) and the body of animals, and adjusts the focus.</p> <ul style="list-style-type: none"> • Each press of [] switches the person, animal or eye to be brought into focus. It cannot be switched by touching. • Animal detection will maintain the enable/disable setting selected during other than [iA] mode. 	
<p>[] ([Tracking])</p>	<p>When the focus mode is set to [AFC], the AF area follows the movement of the subject, maintaining focusing.</p> <p>Aim the AF area over the subject and then press and hold the shutter button halfway.</p> <ul style="list-style-type: none"> • The camera will track the subject while the shutter button is pressed halfway or fully. 	

- ➔ • For information about AF modes, refer to page 105 and 108.

❖ Flash

When recording using a flash, the camera switches to the appropriate flash mode for the recording conditions.

When Slow Sync. ([iS], [iS^s]), be careful with regard to camera shake because the shutter speed becomes slow.

- When [iS] or [iS^s], Red-Eye Removal works.
- ➔ • For information about external flashes, refer to page 228.

Recording Using Touch Functions

Touch AF/Touch Shutter



Touch functions allow you to focus on the point that you touch, release the shutter, etc.



- With the default settings, the Touch Tab is not displayed.
Set [Touch Tab] to [ON] in [Touch Settings] in the [Custom] ([Operation]) menu. (→ 425)

1 Touch [**<**].

2 Touch the icon.





- The icon switches each time you touch it.



AF (Touch AF)	Focus on the Touched Position.
(Touch Shutter)	Record with focus on the point touched.
(OFF)	—

3 (When set to anything other than OFF)
Touch the subject.



-  • When the Touch Shutter fails, the AF area first turns red and then disappears.
-  • Refer to “Operations on the AF area movement screen” on page 107 for information about operations to move the AF area.
- It is also possible to optimize the focus and brightness on the touched position:
 [] → [] → [Touch Settings] → [Touch AF] → [AF+AE] (→ 119)

Touch AE



This function adjusts the brightness according to a touched position. When a subject's face appears dark, you can make the screen brighter to match the face.

-  • With the default settings, the Touch Tab is not displayed. Set [Touch Tab] to [ON] in [Touch Settings] in the [Custom] ([Operation]) menu. (→ 425)

1 Touch [].

2 Touch [].

- The Touch AE settings screen appears.

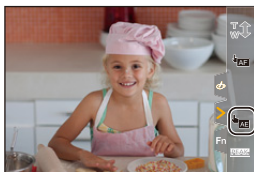

3 Touch the subject to which you wish to adjust the brightness.

- To return the position to which to adjust the brightness to the center, touch [Reset].



4 Touch [Set].

❖ How to Disable Touch AE



Touch [].



- When the following function is being used, Touch AE is not available:
– [Live Cropping]



- You can also adjust both the focus and brightness to those of the position you touch. (At this time, Touch AE is not available):

[] ⇒ [] ⇒ [Touch Settings] ⇒ [Touch AF] ⇒ [AF+AE] (→ 119)

4. Image Recording

[Aspect Ratio]

iA P A S M 



You can select the image aspect ratio.



 → [] → [] → Select [Aspect Ratio]

[4:3]	Aspect ratio of a 4:3 monitor
[3:2]	Aspect ratio of a standard film camera
[16:9]	Aspect ratio of a 16:9 TV
[1:1]	Square aspect ratio
[65:24]	Panoramic aspect ratio
[2:1]	



- [16:9] and [1:1] aspect ratios are not available when using the following functions:
 - 6K photo
 - [Post-Focus] (when set to [6K 18M])
- [65:24] and [2:1] aspect ratios are not available when using the following functions:
 - [iA] mode
 - Taking burst pictures
 - [6K/4K PHOTO]/[Post-Focus]
 - [Time Lapse Shot]
 - [Stop Motion Animation]
 - [HLG Photo]
 - [High Resolution Mode]
 - [Filter Settings]
 - [Multiple Exposure]
- When using Super 35 mm/APS-C lenses, [65:24] and [2:1] are not available.



- You can register functions to Fn buttons:
[] → [] → [Fn Button Set] → [Setting in REC mode] → [Aspect Ratio]
(→ 367)

[Picture Size]

iA P A S M 



Sets the picture's image size. The image size varies depending on the [Aspect Ratio] or the lens used.

When a Super 35 mm/APS-C lens is used, the image area switches to the one for Super 35 mm/APS-C, thereby narrowing the angle of view.

 → [] → [] → Select [Picture Size]

[Aspect Ratio]	Picture size			
	When using full-frame lenses		When using Super 35 mm/APS-C lenses	
[4:3]	[L] (21.5M)	5328×4000	[L] (9.5M)	3536×2656
	[M] (10.5M)	3792×2848	[M] (5M)	2560×1920
	[S] (5.5M)	2688×2016	[S] (2.5M)	1840×1376
[3:2]	[L] (24M)	6000×4000	[L] (10M)	3888×2592
	[M] (12M)	4272×2848	[M] (5M)	2784×1856
	[S] (6M)	3024×2016	[S] (2.5M)	1968×1312
[16:9]	[L] (20M)	6000×3368	[L] (9M)	4064×2288
	[M] (10M)	4272×2400	[M] (4.5M)	2816×1584
	[S] (5M)	3024×1704	[S] (2M)	1920×1080
[1:1]	[L] (16M)	4000×4000	[L] (7M)	2656×2656
	[M] (8M)	2848×2848	[M] (3.5M)	1920×1920
	[S] (4M)	2016×2016	[S] (2M)	1376×1376
[65:24]	[L] (13M)	6000×2208	—	
[2:1]	[L] (18M)	6000×3000	—	



- When [Ex. Tele Conv.] is set, the [M] and [S] image sizes are indicated with [EX].



- When the following functions are being used, [Picture Size] is not available:
 - [6K/4K PHOTO]/[Post-Focus]
 - [RAW] ([Picture Quality])
 - [High Resolution Mode]
 - [Multiple Exposure]



- You can register functions to Fn buttons:



[] ⇒ [] ⇒ [Fn Button Set] ⇒ [Setting in REC mode] ⇒ [Picture Size]
(→ [367](#))

[Picture Quality]

iA P A S M 



Set the compression rate used for storing pictures.

 → [] → [] → Select [Picture Quality]

Setting	File format	Settings details
[FINE]	JPEG	JPEG images that give priority to image quality.
[STD.]		JPEG images of standard image quality. This is useful for increasing the number of recordable pictures without changing the picture size.
[RAW+ FINE]	RAW+ JPEG	This records RAW and JPEG images ([FINE] or [STD.]) simultaneously.
[RAW+ STD.]		
[RAW]	RAW	This records RAW images.

**Note on RAW**

RAW format refers to a data format of images that have not been processed on the camera.

Playback and editing of RAW images require the camera or the dedicated software.



- You can process RAW images on the camera. (→ 359)
- Use software (“SILKYPIX Developer Studio” by Ichikawa Soft Laboratory) to process and edit RAW files on a PC. (→ 531)
- Pictures taken with [RAW] cannot be displayed enlarged to the maximum magnification during playback.
Take pictures with [RAW+FINE] or [RAW+STD.] if you want to check their focus on the camera after recording.



- RAW images are always recorded in the [L] size of the [3:2] aspect ratio.
- When you delete an image recorded with [RAW+FINE] or [RAW+STD.] on the camera, both the RAW and JPEG images will be deleted simultaneously.
- When the following functions are being used, [Picture Quality] is not available:
 - [6K/4K PHOTO]/[Post-Focus]
 - [High Resolution Mode]
 - [Multiple Exposure]









- You can register functions to Fn buttons:

[] ⇒ [] ⇒ [Fn Button Set] ⇒ [Setting in REC mode] ⇒ [Picture Quality]
(→ 367)

[Double Card Slot Function]

This sets the way recording to the card slots 1 and 2 is performed.

 ⇒  ⇒ [] ⇒ Select [Double Card Slot Function]

[Recording Method]	 [Relay Rec]	Selects the priority of card slots for recording. [Destination Card Slot]: [1 → 2]/[2 → 1] Relays recording to the card in the other card slot after the first card runs out of free space.
	 [Backup Rec]	Records the same images to both cards simultaneously.
	 [Allocation Rec]	Allows you to specify the card slot to be used for recording for different image formats. [JPEG/HLG Photo Destn.]/[RAW Destination]/[6K/4K Photo Destination]/[Video Destination]





Notes about relay recording

- The following video cannot be continued to be recorded on another card:
 - [AVCHD] videos
 - [Loop Recording (video)]

Notes about Backup Recording

- We recommend using cards with the same Speed Class rating and capacity. If the card Speed Class or capacity is insufficient when video recording, recording to both cards stops.
- Backup recording is not available with the following video. They can only be recorded on a single card:
 - [AVCHD] videos
 - [Loop Recording (video)]
- When using the following combinations of cards, recording videos, 6K/4K photos, and recording with [Post-Focus] are not available:
 - SD memory card or SDHC memory card, and SDXC memory card



- You can register [Destination Card Slot] in an Fn button and switch the recording destination slot:
 ⇒  ⇒ [Fn Button Set] ⇒ [Setting in REC mode] ⇒ [Destination Card Slot] (→ 367)

[Folder / File Settings]

Set the folder and file name where to save the images.

Folder name		File name	
100ABCDE 		PABC0001.JPG 	
1	Folder number (3 digits, 100 to 999)	3	Color space ([P]: sRGB, [_]: AdobeRGB)
2	5-character user-defined segment	4	3-character user-defined segment
		5	File number (4 digits, 0001 to 9999)
		6	Extension

⇒ [] ⇒ [[^]] ⇒ Select [Folder / File Settings]

[Select Folder]*	Selects a folder for storing images. <ul style="list-style-type: none"> The folder name and the number of files that can be stored will be indicated. 	
[Create a New Folder]	Creates a new folder with an incremented folder number. <ul style="list-style-type: none"> If there are no recordable folders in the card, a screen for resetting the folder number is displayed. 	
	[OK]	Increments the folder number without changing the 5-character user-defined segment (2 above).
	[Change]	Changes the 5-character user-defined segment (2 above). This will also increment the folder number.
[File Name Setting]	[Folder Number Link]	Uses the 3-character user-defined segment (4 above) to set the folder number (1 above).
	[User Setting]	Changes the 3-character user-defined segment (4 above).

- * When [Double Card Slot Function] is set to [Allocation Rec], [Select Folder (Slot 1)] and [Select Folder (Slot 2)] will be displayed.
- Follow the steps on page 464 when the character entry screen is displayed.
Available characters: alphabetic characters (upper-case), numerals, [_]



- Each folder can store up to 1000 files.
- File numbers are assigned sequentially from 0001 to 9999 in the order of recording.

If you change the storage folder, a number continuing on from the last file number will be assigned.



- In the following cases, a new folder with an incremented folder number will be created automatically when the next file is saved:
 - The number of files in the current folder reaches 1000.
 - The file number reaches 9999.
- New folders cannot be created when there are folders numbered from 100 all the way up to 999.

We recommend backing up your data and formatting the card.

- [Select Folder] is not available when [Backup Rec] in [Double Card Slot Function] is being used.

[File Number Reset]

Refresh the folder number to reset the file number to 0001.

 ⇒ [] ⇒ [] ⇒ Select [File Number Reset]
Settings: [Card Slot 1]/[Card Slot 2]



- When the folder number reaches 999, the file number cannot be reset. We recommend backing up your data and formatting the card.
- **To reset the folder number to 100:**
 - ① Perform [Card Format] to format the card. (→ 50)
 - ② Perform [File Number Reset] to reset the file number.
 - ③ Select [Yes] on the folder number reset screen.

5. Focus/Zoom

Selecting the Focus Mode



Select the focusing method (focus mode) to match subject movement.

Set the focus mode lever.

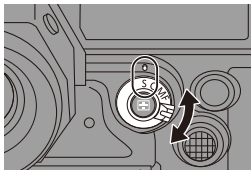

[S] ([AFS])	<p>This is suitable for recording still subjects.</p> <p>When the shutter button is pressed halfway, the camera focuses once.</p> <p>The focus stays locked while the shutter button is pressed halfway.</p>
[C] ([AFC])	<p>This is suitable for recording moving subjects.</p> <p>While the shutter button is pressed halfway, the focus is constantly adjusted according to the movement of the subject.</p> <ul style="list-style-type: none">• This predicts the movement of the subject, maintaining focusing. (Movement prediction)
[MF]	<p>Manual focusing. Use this when you want to fix the focus or avoid activating AF. (→ 123)</p>



- In the following cases, [AFC] works the same as [AFS] when the shutter button is pressed halfway:
 - [M] mode
 - In low light situations
- When the following functions are being used, [AFC] switches to [AFS]:
 - [65:24]/[2:1] ([Aspect Ratio])
 - [High Resolution Mode]
- This function is not available for Post-Focus recording.

Using AF

iA P A S M 



AF (Auto Focus) refers to automatic focusing.



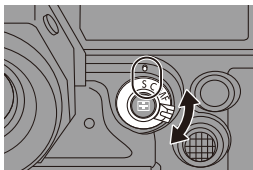

Select the focus mode and the AF mode appropriate for the subject and scene.

1 Set the focus mode to [S] or [C].



- Set the focus mode lever. (→ 96)



2 Select the AF mode.

- Press [] to display the AF mode selection screen, and set using  or . (→ 103)
- Selection is also possible by pressing [].



- In [iA] mode, each press of [] switches between [] and []. (→ 83)

3 Press the shutter button halfway.

- The AF operates.

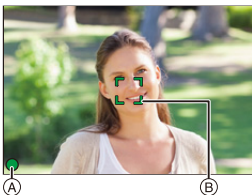

	Focus	
	In focus	Not in focus
Focus icon (A)	Lights	Blinking
AF area (B)	Green	Red
AF beep	Two beeps	—

Low illumination AF

- In dark environments, low illumination AF automatically operates, and the focus icon is indicated as [LOW].
- Achieving focus may take more time than usual.

Starlight AF

- If the camera detects stars in the night sky after determining low illumination AF, then Starlight AF will be activated.
When focus is achieved, the focus icon will display [STAR], and the AF area will be displayed on the area in focus.
- Edges of the screen cannot detect Starlight AF.

❖ [AF ON] button

You can also activate AF by pressing [AF ON].

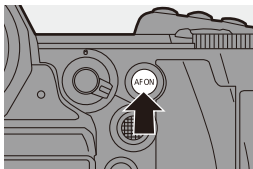



Subjects and recording conditions that make focusing difficult with AF mode



- Fast-moving subjects
- Extremely bright subjects
- Subjects without contrast
- Subjects recorded through windows
- Subjects near shiny objects
- Subjects in very dark locations
- When recording subjects both distant and near
- You can change the operation of AF-ON so that AF prioritizes subjects close by.

This function is useful when the camera mistakenly focuses on the background:

[] ⇒ [] ⇒ [Fn Button Set] ⇒ [Setting in REC mode] ⇒ [AF-ON : Near Shift] (→ 367)

- You can change the operation of AF-ON so that AF prioritizes subjects far away.

This function is useful when taking pictures through fences or nets:

[] ⇒ [] ⇒ [Fn Button Set] ⇒ [Setting in REC mode] ⇒ [AF-ON : Far Shift] (→ 367)



- When the following operations are performed while recording with [AFC], it may take some time for the camera to focus.
 - When zooming from the wide-angle end to the telephoto end
 - When the subject is suddenly changed from one far away to one close by
- If using the zoom after achieving focus, the focus may be erroneous. In that case, re-adjust the focus.



- When camera shake reduces, it is possible to focus automatically:

[] ⇒ [] ⇒ [Quick AF] (→ 424)

- You can change the settings so that AF does not function when the shutter button is pressed halfway:

[] ⇒ [] ⇒ [Half-Press Shutter] (→ 424)



- The AF beep volume and sound can be changed:

[] ⇒ [] ⇒ [Beep] ⇒ [AF Beep Volume]/[AF Beep Tone] (→ 448)



❖ Magnify the AF Area Position ([AF-Point Scope])

iA P A S M 





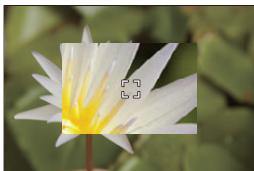

This magnifies the focus point when the AF mode is [], [], or []. (In other AF modes, the center of the screen is magnified.)

You can check focus and observe an enlarged subject as with a telephoto lens.

- ① Register [AF-Point Scope] to the Fn button. (→ [367](#))
- ② Enlarge the AF area position by pressing and holding the Fn button.
 - When the screen is enlarged, pressing the shutter button halfway re-acquires focus in a small central AF area.
 - When the screen is enlarged, turn  or  to adjust the magnification. Use  for more detailed adjustments.



-  • When the screen is enlarged, [AFC] changes to [AFS].
- When the following functions are being used, AF-Point Scope cannot be used:
 - Video recording/[Post-Focus]
 - [6K/4K Pre-Burst]
 - [65:24]/[2:1] ([Aspect Ratio])
 - [Miniature Effect] ([Filter Settings])
 - [Multiple Exposure]
 - [Live Cropping]
 - [Video-Priority Display]
-  • You can change the display method of the magnified screen:
 - [] → [] → [AF-Point Scope Setting] (→ [424](#))

[AF Custom Setting(Photo)]



Select features of AF operation when recording using [AFC] that are appropriate for the subject and scene.

Each of these features can be further customized.

1 Set the focus mode to [AFC]. (→ 96)

2 Set [AF Custom Setting(Photo)].

- → [CAMERA] → [FOCUS] → [AF Custom Setting(Photo)]

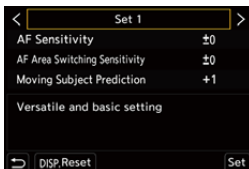

[Set 1]	Basic general-purpose setting.
[Set 2]	Suggested for situations where the subject moves at a constant speed in one direction.
[Set 3]	Suggested when the subject moves randomly, and other objects may be in the scene.
[Set 4]	Suggested for situations where the speed of the subject changes significantly.



- When the following function is being used, [AF Custom Setting(Photo)] is not available:

– [6K/4K PHOTO]

- You can register functions to Fn buttons:

[] → [] → [Fn Button Set] → [Setting in REC mode] → [AF Custom Setting(Photo)] (→ 367)

❖ Adjusting AF Custom Settings

- 1 Press ◀▶ to select the AF Custom setting type.
- 2 Press ▲▼ to select items and press ◀▶ to adjust.
 - To reset settings to the default, press [DISP.].
- 3 Press  or .

[AF Sensitivity]	Sets the tracking sensitivity for the movement of subjects.	
	[+]	When the distance to the subject changes drastically, the camera re-adjusts the focus immediately. You can bring different subjects into focus one after another.
	[-]	When the distance to the subject changes drastically, the camera waits for a short period of time before re-adjusting the focus. This allows you to prevent the focus from being accidentally re-adjusted when, for example, an object moves across the image.
[AF Area Switching Sensitivity]	Sets the sensitivity for switching the AF area to match subject movement. (When in an AF mode where the AF area uses 225-area focusing)	
	[+]	When the subject moves out of the AF area, the camera immediately switches the AF area to keep the subject in focus.
	[-]	The camera switches the AF area at a gradual pace. Effects caused by a slight movement of the subject or by obstacles in front of the camera will be minimized.
[Moving Subject Prediction]	Sets the level of movement prediction for changes in the speed of subject movement.	
	<ul style="list-style-type: none"> • At larger setting values, the camera tries to maintain focus by responding even to sudden movements of the subject. However, the camera becomes more sensitive to slight movements of the subject, so focusing may become unstable. 	
	[0]	This is suited to a subject with minimal changes in speed.
	[+1]	These are suited to a subject that changes its speed.
[+2]		

Selecting the AF Mode

iA P A S M 





Select the focusing method to match the position and number of subjects.

1 Press [].

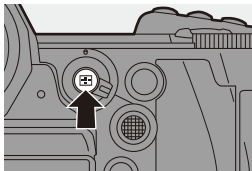







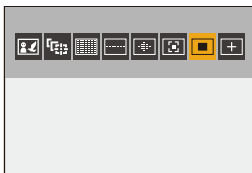



- The AF mode selection screen appears.



2 Select the AF mode.





- Press ◀▶ to select an item and then press  or .
- Selection is also possible by pressing [].



	[Face/Eye/Body/ Animal Detect.]	→ 105
	[Tracking]	→ 108
	[225-Area]	→ 110
	[Zone (Vert./ Horz.)]	→ 111
	[Zone (Square)]*	→ 111
	[Zone (Oval)]	→ 111
	[1-Area+]	→ 113
	[1-Area]	→ 113
	[Pinpoint]	→ 114
	[Custom1]*,	
	[Custom2]*,	→ 116
	[Custom3]*	

- * This is not displayed with the default settings. From [Show/Hide AF Mode] in the [Custom] ([Focus/Shutter]) menu, you can set the items to display on the selection screen. (→ 423)



- In [Time Lapse Shot], [] cannot be used.
- When the focus mode is set to [AFC], [] is not available.
- When the following function is being used, the AF mode is fixed to [] (face detection):
 - [Live Cropping]
- When the following functions are being used, the AF mode is fixed to []:
 - [65:24]/[2:1] ([Aspect Ratio])
 - [Miniature Effect] ([Filter Settings])
- The AF mode cannot be set when using Post-Focus.

[Face/Eye/Body/Animal Detect.]

The camera detects a person's face, eyes, and body (entire body or upper half of the body) and adjusts the focus.

With the default settings, animal detection will also operate, enabling detection of animals, such as birds, canines (including wolves), and felines (including lions).

When the camera detects a person's face (A)/(B) or body or an animal's body (C), an AF area is displayed.

Yellow	AF area to be brought into focus. The camera selects this automatically.
White	Displayed when multiple subjects are detected.

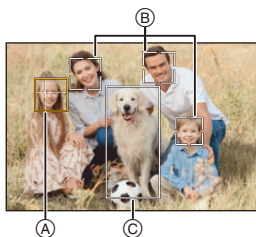

- Eye detection works only for the eyes inside the yellow frame (A).



- When a person's eyes are detected, the eye closer to the camera will be brought into focus.
The exposure will be adjusted to the face. (When [Metering Mode] is set to [☉])
- The camera can detect the faces of up to 15 people.
- The camera can detect a combined total of up to 3 human and animal bodies.
- If any humans or animals are not detected, the camera operates as [📏].

❖ Specify the Person, Animal, or Eye to Bring into Focus

When the person or animal to be brought into focus is shown using the white AF area, you can change this to a yellow AF area.

● Touch operation

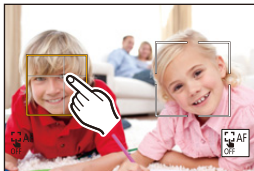

Touch the person, animal or eye indicated with the white AF area.

- The AF area will change to yellow.
- Touching outside the AF area displays the AF area setting screen. Touch [Set] to set the [] AF area at the position touched.
- To cancel the setting, touch [].



● Button operation

Press .

- Each press of  switches the person, animal or eye to be brought into focus.
- To cancel the settings specified, press  again.







❖ Enable/Disable Animal Detection

- 1 Press [] to display the AF mode selection screen.
- 2 Select [] and then press ▲.
 - This disables animal detection, and the icon changes to [].
 - Press ▲ again to enable animal detection.

❖ Move and Change the Size of the Yellow AF Area



You can move the yellow AF area to the position of the white AF area and replace the white AF area with the yellow AF area.

If moving to a position outside an AF area, then the [■] AF area will be set.

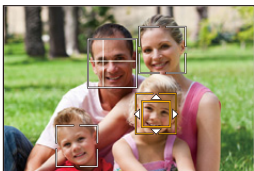
- 1 Press [] to display the AF mode selection screen.
- 2 Select [] and then press ▼.
- 3 Press ▲▼◀▶ to move the position of the AF area.
- 4 Rotate  or  to change the size of the AF area.
- 5 Press  .
 - On the recording screen, press  , or touch [] to cancel the AF area setting.



Operations on the AF area movement screen

Button operation	Touch operation	Description of operation
▲▼◀▶	Touch	Moves the AF area. <ul style="list-style-type: none"> • Positions can be moved to the diagonal directions using the joystick.
	Pinch out/ pinch in	Enlarges/reduces the AF area in small steps.
	—	Enlarges/reduces the AF area.
[DISP.]	[Reset]	First time: Returns the AF area position to the center. Second time: Returns the AF area size to the default setting.



[Tracking]

When the focus mode is set to [AFC], the AF area follows the movement of the subject, maintaining focusing.



Start tracking.

- Aim the AF area over the subject, and press the shutter button halfway. The camera will track the subject while the shutter button is pressed halfway or pressed fully.
- If tracking fails, the AF area blinks red.
- When set to [AFS], the focus will be on the AF area position. Tracking will not work.





- In [M] mode, while recording video, and while recording with [6K/4K Burst(S/S)], tracking will continue even if the shutter button is released. To cancel tracking, press  or , or touch . Tracking is also available with [AFS].



- Set [Metering Mode] to [] to continue to adjust the exposure as well.
- In the following, [] operates as []:
 - [Monochrome]/[L.Monochrome]/[L.Monochrome D]/[Monochrome(HLG)] ([Photo Style])
 - [Sepia]/[Monochrome]/[Dynamic Monochrome]/[Rough Monochrome]/[Silky Monochrome]/[Soft Focus]/[Star Filter]/[Sunshine] ([Filter Settings])
 - When the subject is small

❖ Move the Position of the AF Area

- 1 Press [] to display the AF mode selection screen.
- 2 Select [] and then press ▼.
- 3 Press ▲▼◀▶ to move the position of the AF area.
 - Positions can be moved to the diagonal directions using the joystick.
 - You can also move the AF area by touching.
 - To return the position back to the center, press [DISP].
- 4 Press  .

[225-Area]

The camera selects the most optimal AF area to focus from 225 areas.





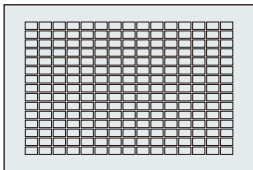



When multiple AF areas are selected, all selected AF areas will be brought into focus.

When the focus mode is set to [AFC], ensuring that the subject stays within the 225 areas during recording will ensure the subject stays in focus.



❖ Specify the [AFC] Start Point

When the focus mode is set to [AFC], you can specify at which area to start [AFC].

- ❶ Set the focus mode to [AFC]. (→ 96)
- ❷ Set [AFC Start Point (225-Area)] to [ON].
 -  →  → [] → [AFC Start Point (225-Area)] → [ON]
- ❸ Press [] to display the AF mode selection screen.
- ❹ Select [] and then press ▼.
 - After performing Steps ❶ and ❷, the icon changes from [] to [].
- ❺ Press ▲▼◀▶ to move the AF area to the start point.
 - Positions can be moved to the diagonal directions using the joystick.
 - You can also move the AF area by touching.
 - To return the position back to the center, press [DISP.].
- ❻ Press .

[Zone (Vert./ Horz.)] / [Zone (Square)] / [Zone (Oval)]

[Zone (Vert./ Horz.)]

Within the 225 AF areas, vertical and horizontal zones can be focused.

Horizontal pattern

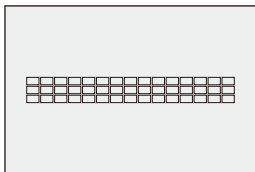

Vertical pattern

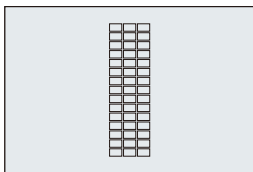

[Zone (Square)]

Within the 225 AF areas, a central square zone can be focused.

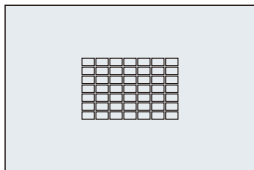





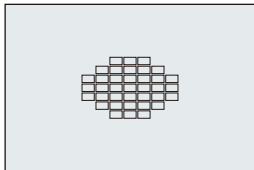





[Zone (Oval)]

Within the 225 AF areas, a central oval zone can be focused.





-  is not displayed with default settings. Set [Zone (Square)] to [ON] in [Show/Hide AF Mode] in the [Custom] ([Focus/Shutter]) menu. (→ 423)

❖ Move and Change the Size of the AF Area

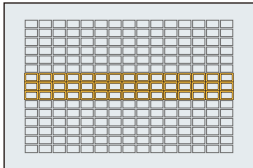
- ❶ Press [] to display the AF mode selection screen.
- ❷ Select [], [] or [] and then press ▼.
- ❸ Press ▲▼◀▶ to move the position of the AF area.
 - You can also move the AF area by touching.
 - When [] is selected
 - Press ▲▼ to switch to a horizontal pattern AF area.
 - Press ◀▶ to switch to a vertical pattern AF area.
 - When []/[] are selected
 - Positions can be moved to the diagonal directions using the joystick.
- ❹ Rotate  or  to change the size of the AF area.
 - You can also pinch out/pinch in the AF area to change the size.
 - The first press of [DISP.] returns the AF area position to the center. The second press returns the size of the AF area to the default.
- ❺ Press .



- The display method for the AF area using 225-area focusing can be changed: [] → [] → [AF Area Display] (→ 433)

[1-Area+]/ [1-Area]

[1-Area+]

Emphasis within a single AF area can be focused.

Even when the subject moves out of the single AF area, the subject remains focused in a supplementary AF area (A).

- Effective when recording moving subjects that are difficult to track with [].

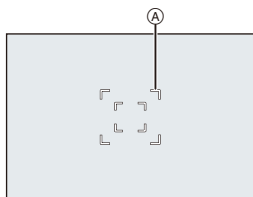





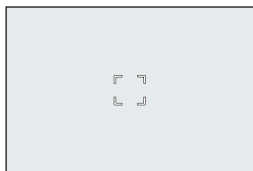

[1-Area]

Specify the point to be brought into focus.





❖ Move and Change the Size of the AF Area

- 1 Press [] to display the AF mode selection screen.
- 2 Select [] or [] and then press ▼.
- 3 Press ▲▼◀▶ to move the position of the AF area.
- 4 Rotate  or  to change the size of the AF area.
- 5 Press .



- Refer to “Operations on the AF area movement screen” on page 107 for information about detailed operations to move the AF area.

- Change the movement speed of a single AF area:
[] ⇒ [] ⇒ [1-Area AF Moving Speed] (→ 403)

[Pinpoint]





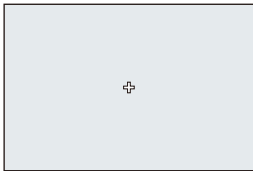



You can achieve a more precise focus on a small point.

If you press the shutter button halfway, the screen that lets you check the focus will be enlarged.





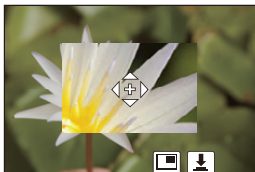

- When the focus mode is set to [AFC], [] is not available.

❖ Move the Position of the AF Area

- 1 Press [] to display the AF mode selection screen.
- 2 Select [] and then press ▼.
- 3 Press ▲▼◀▶ to set the position of [] and then press  or  .
 - Positions can be moved to the diagonal directions using the joystick.
 - The selected position on the screen will be enlarged.
 - The AF area cannot be moved to the edge of the screen.
- 4 Press ▲▼◀▶ to fine-adjust the position of [].
- 5 Press  or  .



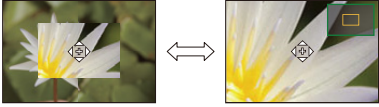

Operations on the Magnification Window



Button operation	Touch operation	Description of operation
▲▼◀▶	Touch	Moves []. <ul style="list-style-type: none"> • Positions can be moved to the diagonal directions using the joystick.
	Pinch out/ pinch in	Enlarges/reduces the screen in small steps.
	—	Enlarges/reduces the screen.
		Switches magnification window (windowed mode/full screen mode). <div style="text-align: center;">  </div>
[DISP.]	[Reset]	First time: Returns to the screen in Step 3. Second time: Returns the AF area position to the center.

- When the picture is displayed in windowed mode, you can enlarge the picture by approx. 3× to 6×; when the picture is displayed in full screen, you can enlarge the picture by approx. 3× to 10×.
- You can also take a picture by touching .



- When the following functions are being used,  switches to :
– Video recording/[6K/4K PHOTO]



- You can change the display method of the magnified screen:
 →  → [Pinpoint AF Setting] (→ 423)

[Custom1] to [Custom3]

The shape of the AF area can be set freely in the 225 AF areas.



The set AF area can be registered using  to .

The AF area can also be moved while maintaining the set shape.



- This is not displayed with default settings. In [Show/Hide AF Mode] in the [Custom] ([Focus/Shutter]) menu, set [Custom1] to [Custom3] to [ON].
(→ 423)

❖ Register the AF Area Shape

- 1 Press  to display the AF mode selection screen.
- 2 Select one of  to  and then press ▲.

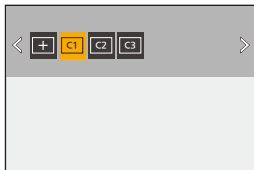

3 Select the AF area.



● Touch operation

Touch the area to make the AF area.

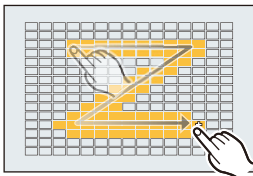

- To select consecutive points, drag the screen.
- To cancel selection of the selected AF area, touch it again.



● Button operation

Press ▲▼◀▶ to select the AF area and then set with  or .

(Repeat this)

- Positions can be moved to the diagonal directions using the joystick.
- To cancel selection of the selected AF area, press  or  again.
- To cancel all selections, press [DISP.].

4 Press [Q].

❖ Move the Position of the AF Area

1 Press [] to display the AF mode selection screen.

2 Select a registered AF mode shape ([C1] to [C3]) and then press ▼.

3 Press ▲▼◀▶ to move the position of the AF area and then press



- Positions can be moved to the diagonal directions using the joystick.
- Press [DISP.] to return the [+] position to the center.

AF Area Movement Operation

iA P A S M 





In default settings, you can use the joystick to directly move and change the size of the AF area when recording.

1 Move the position of the AF area.

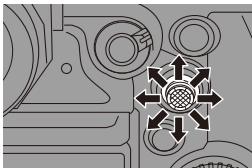

- On the recording screen, tilt the joystick.

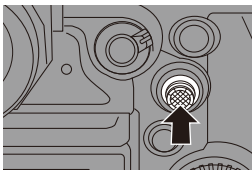

- Pressing  enables switching between the default and set AF area positions.
In [], this operation switches the person, animal or eye to be brought into focus.
In [], this operation displays the enlarged screen.



2 Change the size of the AF area.

- Rotate  or .
- Use  for more detailed adjustments.
- The first press of [DISP.] returns the AF area position to the center. The second press returns the size of the AF area to the default.

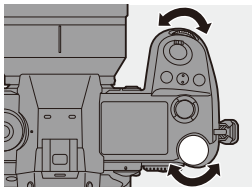

3 Confirm your selection.

- Press the shutter button halfway.
- This will return you to the recording screen.

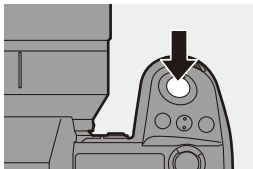

- When [Metering Mode] is [], the metering target also moves together with the AF area.
- In [], [], [], and [] to [], the size of the AF area cannot be changed.
- In [], it is not possible to move the AF area or change its size.
- In the [iA] mode, the [] AF area cannot be moved.



- You can set the AF area to loop when moved:
[] → [] → [Looped Focus Frame] (→ [425](#))

Moving the AF Area by Touch

You can move the AF area to a touched position on the monitor.
You can also change the size of the AF area.

[MENU/SET] → [] → [] → [Touch Settings] →
Select [Touch AF]

[AF]	This focuses on the touched subject.
[AF+AE]	This focuses on and adjusts brightness for the touched subject.

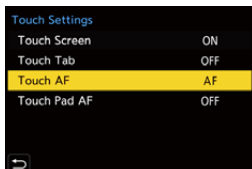

- The default setting is [AF].

❖ Focus on the Touched Position ([AF])

- ❶ Touch the subject.
 - The AF area moves to the touched position.
- ❷ Pinch out/pinch in to change the AF area size.
 - The first touch of [Reset] returns the AF area position to the center. The second touch returns the size of the AF area to the default.
- ❸ Touch [Set].
 - In [+], touch [Exit].
 - For [AF], the AF area setting is canceled if you touch [AF OFF] on the recording screen.

❖ Focus on and Adjust Brightness for the Touched Position ([AF+AE])

- ❶ Touch the subject to which you wish to adjust the brightness.
 - At the touched position, an AF area that works in the same way as [AF] is displayed. This places a point to adjust brightness at the center of the AF area.
- ❷ Pinch out/pinch in to change the AF area size.
 - The first touch of [Reset] returns the AF area position to the center. The second touch returns the size of the AF area to the default.
- ❸ Touch [Set].
 - The [AF+AE] area setting is canceled if you touch [AF OFF/AE] (when [AF] or [AE] is set: [AF/AE OFF]) on the recording screen.



Moving the AF Area Position with the Touch Pad

During viewfinder display, you can touch the monitor to change the position and size of the AF area.

1 Set [Touch Pad AF].

-  → [] → [] → [Touch Settings] → [Touch Pad AF] → [EXACT]/[OFFSET1] to [OFFSET7]

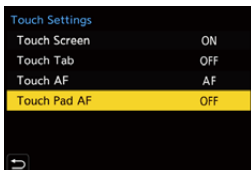

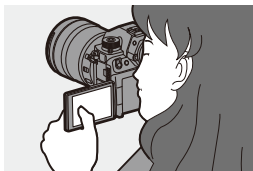

2 Move the position of the AF area.

- During viewfinder display, touch the monitor.



3 Change the size of the AF area.

- Rotate  or .
- Use  for more detailed adjustments.
- The first press of [DISP.] returns the AF area position to the center. The second press returns the size of the AF area to the default.

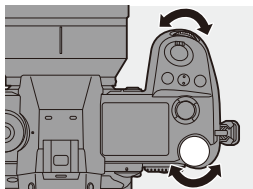

4 Confirm your selection.

- Press the shutter button halfway.

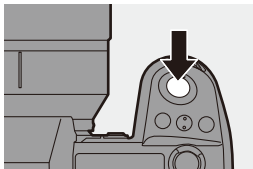

❖ Setting Items ([Touch Pad AF])

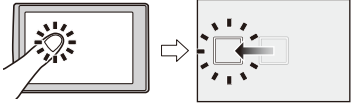
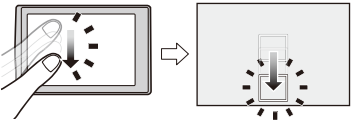

[EXACT]	<p>Moves the AF area of the viewfinder by touching a desired position on the touch pad.</p>	
[OFFSET1] to [OFFSET7]	<p>Moves the AF area of the viewfinder according to the distance you drag your finger on the touch pad.</p> <p>Select the range to be detected with the drag operation. [OFFSET1] (entire area)/[OFFSET2] (right half)/[OFFSET3] (upper right)/[OFFSET4] (lower right)/[OFFSET5] (left half)/[OFFSET6] (upper left)/[OFFSET7] (lower left)</p>	
[OFF]	—	—

[Focus Switching for Vert / Hor]

Memorizes separate positions for AF areas for when the camera is vertically aligned and for when it is horizontally aligned.



Two vertical orientations, left and right, are available.



 ⇒  ⇒  ⇒ Select [Focus Switching for Vert / Hor]

[ON]	Memorizes separate positions for vertical and horizontal orientations.
[OFF]	Sets the same position for vertical and horizontal orientations.



- In MF, this memorizes the MF Assist position.
- This does not work in the  and  to  AF modes.

Record Using MF

iA P A S M 



MF (Manual Focus) refers to manual focusing.

Use this function when you want to fix the focus or when the distance between the lens and the subject is determined and you do not want to activate AF.

1 Set the focus mode lever to [MF].

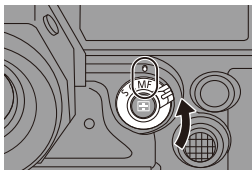

2 Select the focus point.

- Tilt the joystick to select the focus point.
- To return the point to be brought into focus to the center, press [DISP].

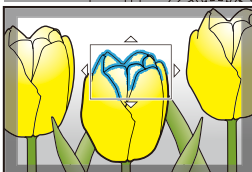
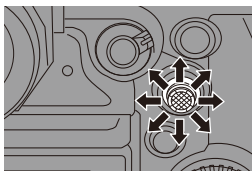

3 Confirm your selection.

- Press .
- This switches to the MF Assist screen, and shows an enlarged display.

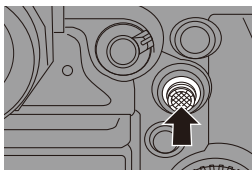

4 Adjust the focus.

- Rotate the focus ring.
- Ⓐ MF Assist (enlarged screen)
- This will display the in-focus portion highlighted with color. (Focus Peaking Ⓑ)
- A recording distance guideline is displayed. (MF Guide Ⓒ)
- Ⓓ Indicator for ∞ (infinity)

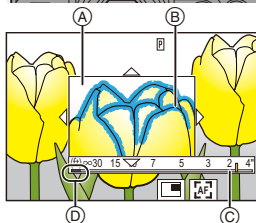
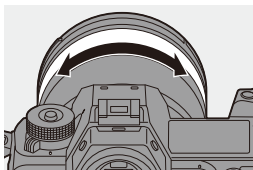

5 Close the MF Assist screen.





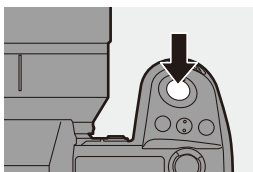

- Press the shutter button halfway.
- This operation can also be performed by pressing .

6 Start recording.

- Press the shutter button fully.

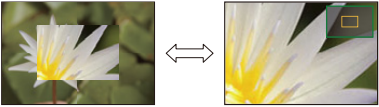

❖ Operations on the MF Assist Screen

















Button operation	Touch operation	Description of operation
	Drag	Moves the enlarged display position. <ul style="list-style-type: none"> Positions can be moved to the diagonal directions using the joystick.
	Pinch out/ pinch in	Enlarges/reduces the screen in small steps.
	—	Enlarges/reduces the screen.
		Switches magnification window (windowed mode/full screen mode). 
[DISP.]	[Reset]	First time: Returns the MF Assist position to the center. Second time: Returns the MF Assist magnification to the default setting.
[AF ON]		The AF operates.

- When the picture is displayed in windowed mode, you can enlarge the picture by approx. 3× to 6×; when the picture is displayed in full screen, you can enlarge the picture by approx. 3× to 20×.



- On the recording screen, you can rotate the focus ring to display the MF Assist screen. If the focus ring has been rotated to enlarge the display, the assist screen will be exited a short time after you cease the operation.
- You can also display the MF Assist screen by pressing the [].
- During MF, pressing [AF ON] will activate AF.
- The recording distance reference mark is a mark used to measure the recording distance.
Use this when taking pictures with MF or taking close-up pictures.



- You can change the Focus Peaking sensitivity and the display method:
[] ⇒ [] ⇒ [Focus Peaking] (→ 402)
- You can memorize the MF Assist position separately for vertical and horizontal orientations:
[] ⇒ [] ⇒ [Focus Switching for Vert / Hor] (→ 122)
- You can change the display method of the magnified screen:
[] ⇒ [] ⇒ [MF Assist] (→ 422)
- You can change the MF Guide display units:
[] ⇒ [] ⇒ [MF Guide] (→ 422)
- You can disable focus ring operation:
[] ⇒ [] ⇒ [Focus Ring Lock] (→ 422)
- You can set the movement of the MF Assist position to loop:
[] ⇒ [] ⇒ [Looped Focus Frame] (→ 425)
- The camera memorizes the focus point when you turn it off:
[] ⇒ [] ⇒ [Lens Focus Resume] (→ 443)
- The amount of focus movement can be set:
[] ⇒ [] ⇒ [Focus Ring Control] (→ 443)

Recording with Zoom

iA P A S M 



Use the optical zoom of the lens to zoom to telephoto or wide-angle.

When taking pictures, use [Ex. Tele Conv.] to increase a telescopic effect without image deterioration.

When recording videos, use [Image Area of Video] to obtain the same telescopic effect as [Ex. Tele Conv.].



- For details about [Image Area of Video], refer to page [266](#).

Rotate the zoom ring.

- T**: Telephoto
- W**: Wide-angle

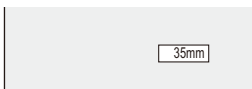
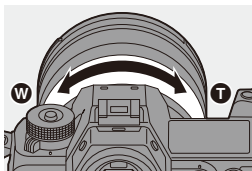
- Rotating the zoom ring displays the focal length on the recording screen.



- The focal length display can be hidden:
[] → [] → [Focal Length] (→ [436](#))

Extended Tele Conversion



[Ex. Tele Conv.] enables you to take pictures that are further enlarged beyond what is available with the optical zoom, without any deterioration in image quality.

- The [Ex. Tele Conv.] maximum magnification ratio differs depending on the [Picture Size] set in the [Photo] ([Image Quality]) menu.
 - Set to [EX]M: 1.4×
 - Set to [EX]S: 2.0× (1.9× when using Super 35 mm/APS-C lenses)

1 Set [Picture Size] to [M] or [S].

- → [📷] → [🔍] → [Picture Size] → [M]/[S]



2 Set [Ex. Tele Conv.].

- → [📷] → [🔍] → [Ex. Tele Conv.]

[ZOOM]	Changes the zoom magnification.
[TELE CONV.]	Fixes the zoom magnification at the maximum.
[OFF]	—

❖ Changing the Zoom Magnification

Button operation





- 1 Set [Ex. Tele Conv.] to [ZOOM].
 -  ⇒ [] ⇒ [] ⇒ [Ex. Tele Conv.] ⇒ [ZOOM]
- 2 Set the Fn button to [Zoom Control]. (→ 367)
- 3 Press the Fn button.
- 4 Press the cursor buttons to operate the zoom.
 - ▲▶: T (telephoto)
 - ◀▼: W (wide-angle)
 - Press the Fn button again, or wait a specified time to end zoom operation.
 - Displayed zoom magnifications (A) are approximate.



Touch operation



- With the default settings, the Touch Tab is not displayed. Set [Touch Tab] to [ON] in [Touch Settings] in the [Custom] ([Operation]) menu. (→ 425)

- 1 Set [Ex. Tele Conv.] to [ZOOM].
 -  ⇒ [] ⇒ [] ⇒ [Ex. Tele Conv.] ⇒ [ZOOM]
- 2 Touch [].
- 3 Touch [].





- 4 Drag the slide bar to operate the zoom.

- T: Telephoto
- W: Wide-angle

- To end Touch Zoom operations, touch [] again.



- You can register functions to Fn buttons:

[] ⇒ [] ⇒ [Fn Button Set] ⇒ [Setting in REC mode] ⇒ [Ex. Tele Conv.] (→ 367)

- When displaying the [Ex. Tele Conv.] setting screen using the Fn button, pressing [DISP.] allows you to change the [Picture Size] setting.



- When the following functions are being used, [Ex. Tele Conv.] is not available:

- [6K/4K PHOTO]
- [65:24]/[2:1] ([Aspect Ratio])
- [RAW] ([Picture Quality])
- [HLG Photo]
- [High Resolution Mode]
- [Toy Effect]/[Toy Pop] ([Filter Settings])
- [Post-Focus]
- [Multiple Exposure]

6. Drive/Shutter/Image Stabilizer

Selecting the Drive Mode



You can switch the drive mode to Single, Burst, etc. to match the recording conditions.

Rotating the drive mode dial.

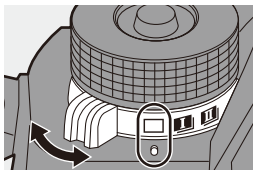

[□]	Single	Takes one picture each time the shutter button is pressed.
[I]/[II]	Burst (→ 132, 136)	Takes pictures continuously while the shutter button is pressed and held. 6K/4K photo recording is also possible.
[⌚]	Time Lapse Shot/ Stop Motion Animation (→ 149, 153)	Takes pictures with Time Lapse Shot or Stop Motion Animation.
[⌚]	Self-timer (→ 158)	Takes pictures when the set time elapses after the shutter button is pressed.



- The detailed setting screens for each drive mode can be called up with an Fn button:

[⚙️] → [🌅] → [Fn Button Set] → [Setting in REC mode] → [Drive Mode] → [More Settings]

- The 6K/4K photo setting screens can be called up with an Fn button:

[⚙️] → [🌅] → [Fn Button Set] → [Setting in REC mode] → [Drive Mode] → [6K/4K PHOTO]



Taking Burst Pictures

iA P A S M 







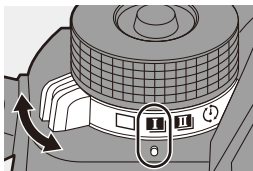

Takes pictures continuously while the shutter button is pressed and held. You can choose a burst setting which enables burst recording in high image quality, [H], [M] or [L], or one which enables high-speed burst recording, [] (6K/4K photo), to suit the recording conditions.

1 Set the drive mode dial to [] (Burst Shot 1) or [] (Burst Shot 2).

- Configure the burst settings for each of [] and [].



2 Select the burst rate.

-  →  →  → [Burst Shot 1 Setting]/[Burst Shot 2 Setting]
- With the default settings, [H] is set for [] and [] is set for [].



	For information about 6K/4K photo recording, refer to “6K/4K Photo Recording”. (→ 136)
[H]	Takes high-speed burst pictures.
[M]	Takes medium-speed burst pictures.
[L]	Takes low-speed burst pictures.

3 Close the menu.

- Press the shutter button halfway.

4 Start recording.

- Takes burst pictures while the shutter button is pressed fully.

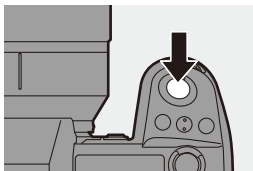

❖ Burst Rate

	Mechanical shutter, electronic front curtain	Electronic shutter	Live View when taking burst pictures
[H] (High speed)	9 frames/second ([AFS]/[MF]) 6 frames/second ([AFC])	9 frames/second ([AFS]/[MF]) 5 frames/second ([AFC])	None ([AFS]/[MF]) Available ([AFC])
[M] (Medium speed)	5 frames/second	5 frames/second	Available
[L] (Low speed)	2 frames/second	2 frames/second	Available

- The burst rate may be lower depending on the settings for recording such as [Picture Size] and focus mode.

❖ Maximum Number of Frames Recordable

	[Picture Quality]	
	[FINE]/[STD.]	[RAW+FINE]/ [RAW+STD.]/ [RAW]
[H] (High speed)	999 frames or more	60 frames or more
[M] (Medium speed)		
[L] (Low speed)		

- When recording under the test conditions specified by Panasonic. Recording conditions may reduce the maximum number of frames recordable.
- The burst rate will become lower during recording but pictures can continue to be taken until the card becomes full.

❖ Number of Pictures That Can Be Taken Continuously

When you press the shutter button halfway, the number of pictures that can be taken continuously will appear on the recording screen and the status LCD.

Example) When 20 frames: [r20]

- Once recording starts, the number of pictures that can be taken continuously will decrease. When [r0] appears, the burst rate decreases.
- When [r99+] is displayed on the recording screen, you can take 100 or more burst pictures.

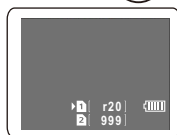

❖ Focus when Taking Burst Pictures

Focus mode	[Focus/Shutter Priority] (→ 421)	[H]	[M]/[L]
[AFS]	[FOCUS]	Fixed to the focus of the first frame	
	[BALANCE]		
	[RELEASE]		
[AFC]	[FOCUS]	Estimated focus	Normal focus
	[BALANCE]	Estimated focus	
	[RELEASE]		
[MF]	—	Focus set with manual focus	

- When the subject is dark with [AFC], the focus is fixed to that of the first frame.
- With estimated focus, the burst rate takes priority and the focus is estimated to the extent possible.
- With normal focus, the burst rate may become slow.

❖ Exposure when Taking Burst Pictures

Focus mode	[H]	[M]/[L]
[AFS]	Fixed to the exposure of the first frame	The exposure is adjusted for each frame
[AFC]	The exposure is adjusted for each frame	
[MF]	Fixed to the exposure of the first frame	



- It may take a while to save burst pictures.
If you continue to take burst pictures while saving is in progress, the maximum number of frames recordable will be reduced.
When taking burst pictures, we recommend using a high-speed card.
- We recommend using the Shutter Remote Control (DMW-RS2: optional) when taking burst pictures with the shutter button pressed.
- Taking burst pictures does not work while you are using the following functions:
 - [High Resolution Mode]
 - [Rough Monochrome]/[Silky Monochrome]/[Miniature Effect]/[Soft Focus]/[Star Filter]/[Sunshine] ([Filter Settings])
 - [Post-Focus]
 - [Multiple Exposure]

6K/4K Photo Recording

iA P A S M 



With 6K Photo, you can take high-speed burst pictures at 30 frames/second and save the desired pictures, each made up of approx. 18 million pixels, extracted from their burst file.

With 4K photo, you can take high-speed burst pictures at 60 frames/second and save the desired pictures, each made up of approx. 8 million pixels.

- “6K PHOTO” is a high-speed burst picture function to extract and save the desired pictures from images with an aspect ratio for pictures of 4:3 or 3:2 and an effective picture size equivalent to the number of pixels (approx. 18 megapixels) for images of 6K size (around 6,000 wide×3,000 high).





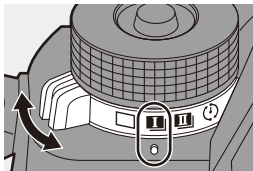

- Use a UHS Speed Class 3 or higher card when recording.
- The angle of view becomes narrower (when using a full-frame lens).

1 Set the drive mode dial to [**I**] (Burst Shot 1) or [**II**] (Burst Shot 2).

- Configure the burst settings for each of [**I**] and [**II**].



2 Select [6K/4K PHOTO].

-  → [] → [] → [Burst Shot 1 Setting]/[Burst Shot 2 Setting] → []
- With the default settings, [] is set for [**II**].

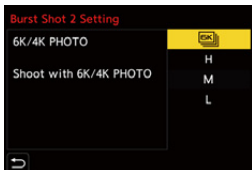

3 Select [Picture Size / Burst Speed].

-  →  →  → [6K/4K PHOTO] → [Picture Size / Burst Speed]

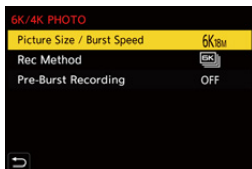

	Picture size	Burst rate	[Rec Quality]*
[6K 18M]	[4:3]: 4992×3744 [3:2]: 5184×3456	30 frames/ second	[6K/200M/30p]
[4K H 8M]	[4:3]: 3328×2496 [3:2]: 3504×2336	60 frames/ second	[4K/150M/60p]
[4K 8M]	[16:9]: 3840×2160 [1:1]: 2880×2880	30 frames/ second	[4K/100M/30p]

* Saved as 6K/4K burst files whose [Rec. File Format] is [MP4].

4 Select [Rec Method].

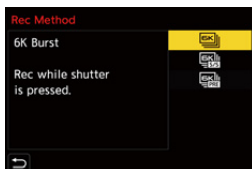

  
([6K/4K Burst])

When you wish to capture the best moments of a fast-moving subject

Takes burst pictures while the shutter button is pressed.

Audio recording: None

<p>[$\frac{6K}{S/S}$] [$\frac{4K}{S/S}$] [$\frac{4K}{S/S}$] ([6K/4K Burst(S/S)])</p> <p>"S/S" is an abbreviation for start/stop.</p>	<p>When you wish to capture an unpredictable photo opportunity</p> <p>Starts taking burst pictures when the shutter button is pressed. Pressing the button again stops taking burst pictures.</p> <p>The start tone and stop tone are output.</p> <p>Audio recording: Available*</p>		
<p>[$\frac{6K}{PRE}$] [$\frac{4K}{PRE}$] [$\frac{4K}{PRE}$] ([6K/4K Pre-Burst])</p>	<p>When you wish to capture at the moment of a photo opportunity</p> <p>Takes burst pictures for approx. 1 second before and after the moment the shutter button is pressed. The shutter sound is output once only.</p> <table border="1" data-bbox="407 582 970 651"> <tr> <td data-bbox="407 582 689 651">Recording duration: Approx. 2 seconds</td> <td data-bbox="689 582 970 651">Audio recording: None</td> </tr> </table>	Recording duration: Approx. 2 seconds	Audio recording: None
Recording duration: Approx. 2 seconds	Audio recording: None		

* Audio is not played back during playback with the camera.

5 Close the menu.

- Press the shutter button halfway.

6 Start recording.

- [Continuous AF] works and the focus is adjusted continuously during recording with AF.

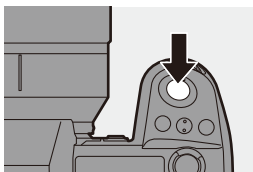

[6K/4K Burst]

- 1 Press the shutter button halfway.
- 2 Press the shutter button fully and keep it pressed during recording.

- (A) Press and hold
 (B) Recording is performed

- Press the shutter button fully early because recording will take approx. 0.5 second to start after it is pressed fully.

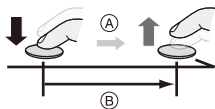

[6K/4K Burst(S/S)]

- 1 Press the shutter button fully to start recording.
- 2 Press the shutter button fully again to stop recording.

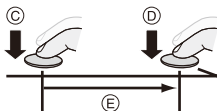

- Ⓒ Start (First)
- Ⓓ Stop (Second)
- Ⓔ Recording is performed

- You can add markers by pressing [Q] during recording. (Up to 40 markers per recording)

This allows you to skip to the positions where you added markers when selecting pictures from a 6K/4K burst file.

[6K/4K Pre-Burst]

Press the shutter button fully.

- Ⓕ Approx. 1 second
- Ⓖ Recording is performed

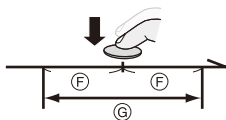

- While the recording screen is displayed, the AF will operate constantly to continue focusing.

The exposure is also adjusted continuously, except in [M] mode.

- When the subject is not at the center, use AF/AE Lock if you wish to lock the focus and exposure. (→ 199)

- In default settings, Auto Review operates, and a screen that lets you select pictures from a burst file will be displayed.

To continue recording, press the shutter button halfway to return to the recording screen.

For how to select and save pictures from a recorded 6K/4K burst file, refer to page 142.

❖ [Pre-Burst Recording] ([6K/4K Burst]/[6K/4K Burst(S/S)])

The camera starts recording approx. 1 second before the shutter button is pressed fully, so you will not miss a photo opportunity.

 → [] → [] → [6K/4K PHOTO] → Select [Pre-Burst Recording] Settings: [ON]/[OFF]

- When [Pre-Burst Recording] is being used, [PRE] is displayed on the recording screen.
- The AF behaviour and functionality restrictions when using [Pre-Burst Recording] are the same as for [6K/4K Pre-Burst].



- Setting ranges become the following with 6K/4K photo recording:
 - Shutter speed: 1/30 (1/60 when [4K H 8M] is set) to 1/8000
 - [Min. Shutter Speed]: [1/500] to [1/30] ([1/60] when [4K H 8M] is set)
 - Exposure compensation: ± 3 EV
- The file save method differs depending on the type of card.
 - SDHC memory card:
A new file will be created to continue recording if the file size exceeds 4 GB.
 - SDXC memory card:
Files are not divided for recording.
- When [6K/4K Pre-Burst] or [Pre-Burst Recording] is set, the battery drains faster and the camera temperature rises. Set these settings only when recording.
- For 6K/4K photo, the menu items below are fixed to the following settings:
 - [Shutter Type]: [ELEC.]
 - [Picture Quality]: [FINE]
- With 6K/4K photo recording, the following functions are not available:
 - Flash
 - [Bracketing]
 - Program Shift
 - AF mode ()
 - [MF Assist] ([6K/4K Pre-Burst] only)
- When you record in an extremely bright location or under lighting such as fluorescent or LED lighting, the coloring or brightness of the image may change or horizontal stripes may appear on the screen.
Lowering the shutter speed may reduce the effect of horizontal stripes.





- The following functions are restricted when recording 6K/4K photos when connected to an external device (TV, etc.) via HDMI:
 - HDMI output is not possible during recording.
 - [6K/4K Pre-Burst] changes to [6K/4K Burst].
 - [Pre-Burst Recording] is not available.
- 6K/4K photo recording does not work while you are using the following functions:
 - [High Resolution Mode]
 - [Rough Monochrome]/[Silky Monochrome]/[Miniature Effect]/[Soft Focus]/[Star Filter]/[Sunshine] ([Filter Settings])
 - [Post-Focus]
 - [Multiple Exposure]
- When using Super 35 mm/APS-C lenses, 6K photo is not available.

Selecting Pictures from a 6K/4K Burst File

You can select pictures from the 6K/4K burst files and save them.

- When continuing to select pictures from the Auto Review after recording 6K/4K photos, start the operation from either Step **2** or **3**.

1 Select a 6K/4K burst file on the playback screen. (→ 347)

- Select an image with the  or  icon and then press **▲**.
- You can also perform the same operation by touching  or .



- If the images were recorded with [6K/4K Pre-Burst], proceed to Step **3**.

2 Roughly select the scene.

- Drag the slide bar **(A)**.
- For information about how to use the picture selection slide view screen, refer to page 144.
- If the images were recorded with [6K/4K Burst] or [6K/4K Burst(S/S)], touching  allows you to select the scene in the 6K/4K burst playback screen. (→ 146)

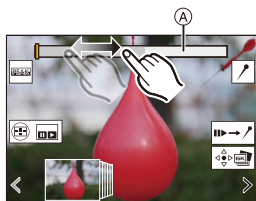

Picture selection slide view screen

3 Select the frame to save.

- Drag the picture selection slide view **(B)**.
- You can also perform the same operation by pressing **◀▶**.
- To continuously rewind or forward frame-by-frame, touch and hold [**<**] [**>**].

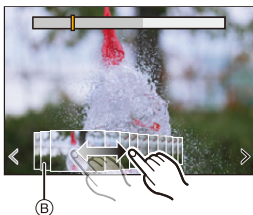

4 Save the picture.

- Touch [] or [].
- A confirmation screen appears.

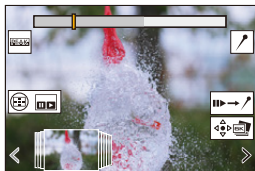

- The picture is saved in JPEG format ([FINE] picture quality).
- The recording information (Exif information), such as the shutter speed, aperture, and ISO sensitivity, is also saved with the picture that is saved.

Correcting Pictures After Recording (Post-Recording Refinement)

❖ Correcting Distortion in Pictures ([Reduce Rolling Shutter])

When saving pictures, correct any distortion caused by the electronic shutter (rolling shutter effect).



- 1 On the save confirmation screen in Step 4 on page 143, touch [Reduce Rolling Shutter].
 - If there is no effect even after using correction, after a message is displayed advising that there is no effect, the confirmation screen returns.
- 2 Check the correction result and then touch [Save].
 - To check the corrected and uncorrected versions of the picture, touch [Set/Cancel].



- The angle of view may become narrower if correction is performed.
- The correction may appear unnatural due to the movement of subjects.

❖ Reducing Noise Caused by High Sensitivity ([6K/4K PHOTO Noise Reduction])

When saving pictures, reduce the noise that occurs due to high ISO sensitivity.

 →  →  → Select [6K/4K PHOTO Noise Reduction]
Settings: [AUTO]/[OFF]









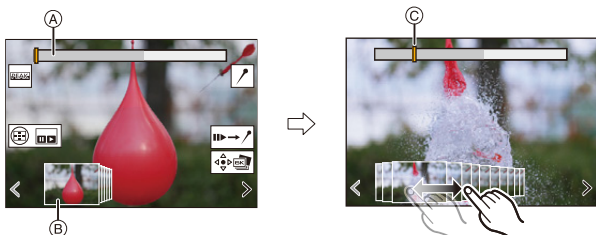





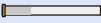

• This is not applied to pictures saved with [6K/4K PHOTO Bulk Saving].

Picture Selection Operations





❖ Picture Selection Slide View Screen Operations



- (A) Slide bar
- (B) Picture selection slide view
- (C) Position of displayed frame

Button operation	Touch operation	Description of operation
	Drag/ < >	Selects a frame. • To change the frames displayed in the picture selection slide view, select the frame at the left/right end and then touch [<] or [>].
Press and hold 	< > Touch and hold	Continuously rewinds or forwards frame-by-frame.
—	 Touch/drag	Selects the frame to display.
	Pinch out/ pinch in	Enlarges or reduces the display.
	—	Selects a frame while maintaining the enlarged display (during enlarged display).
	Drag	Moves the enlarged display position (during enlarged display).
[]		Displays the 6K/4K burst playback screen.
—		Switches to marker operation.
—	 / 	Adds or deletes a marker.
—		Displays the in-focus portion highlighted with color ([Focus Peaking]). • [ON]/[OFF] are switched.
	 / 	Saves the picture.

- During marker operation, you can skip to set markers or the beginning or end of the 6K/4K burst file. Touch [] to return to the previous operation.

Button operation	Touch operation	Description of operation
		Moves to the next marker.
		Moves to the previous marker.

❖ 6K/4K Burst Playback Screen Operations

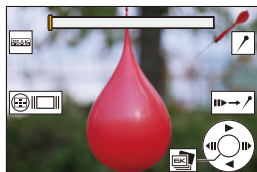







While paused





During continuous playback

Button operation	Touch operation	Description of operation
▲	—	Performs continuous playback or pauses (during continuous playback).
▼	—	Performs continuous rewind playback or pauses (during continuous rewind playback).
▶ / [Sawtooth] / [Gear]	—	Performs fast-forward playback or performs frame-by-frame forwarding (while paused).
◀ / [Sawtooth] / [Gear]	—	Performs fast-rewind playback or performs frame-by-frame rewinding (while paused).
—	Touch/drag	Selects the frame to display (while paused).
	Pinch out/ pinch in	Enlarges or reduces the display (while paused).
/ [Gear]	—	Selects a frame while maintaining the enlarged display (during enlarged display).
▲▼◀▶	Drag	Moves the enlarged display position (during enlarged display).
[[Grid]]		Displays the picture selection slide view screen (while paused).
—		Switches to marker operation.
—	/	Adds or deletes a marker.

—		Displays the in-focus portion highlighted with color ([Focus Peaking]). • [ON]/[OFF] switches.
 / 	 / 	Saves the picture (while paused).



- During marker operation, you can skip to set markers or the beginning or end of the 6K/4K burst file. Touch [] to return to the previous operation.

Button operation	Touch operation	Description of operation
	—	Moves to the next marker.
	—	Moves to the previous marker.











- To select and save pictures from a 6K/4K burst file on a PC, use the “PHOTOfunSTUDIO” software.
However, it is not possible to treat 6K/4K burst files as videos in “PHOTOfunSTUDIO”.
- To play and edit 6K burst files on a PC, you need a high-performance PC environment.
We recommend selecting and saving pictures with the camera.

❖ Selecting and Saving Pictures Using a TV Screen

- 6K burst files are output to a TV connected via HDMI at a resolution of [4K].
- Set [HDMI Mode (Playback)] to either [AUTO] or [4K] resolution.
[] ⇒ [] ⇒ [TV Connection] ⇒ [HDMI Mode (Playback)]
When connecting to a TV that does not support 4K videos, select [AUTO].
- Only the 6K/4K burst playback screen will be displayed on the TV.
- Depending on the connected TV, 6K/4K burst files may not be played back correctly.



❖ [6K/4K PHOTO Bulk Saving]

You can save any 5 second period of pictures from a 6K/4K burst file all at once.

- 1 Select [6K/4K PHOTO Bulk Saving].
 -  ⇒ [] ⇒ [] ⇒ [6K/4K PHOTO Bulk Saving]
- 2 Press   to select a 6K/4K burst file and then press  or  .
 - If the burst time is 5 seconds or less, all frames are saved as pictures.
- 3 Select the first frame of the pictures to be saved all at once and then press  or  .
 - The selection method is the same as that for selecting pictures from a 6K/4K burst file.
 - The pictures are saved as a group of burst pictures in JPEG format.



- You can register functions to Fn buttons:

[] ⇒ [] ⇒ [Fn Button Set] ⇒ [Setting in PLAY mode] ⇒ [6K/4K PHOTO Bulk Saving] (→ [367](#))

Recording with Time Lapse Shot

iA P A S M 



Pictures are taken automatically at a set recording interval.

This feature is ideal for keeping track of changes over time in subjects such as animals and plants.



The pictures taken will be saved as a set of group images that can also be combined into a video.

-  Check that the clock is set correctly. (→ 56)
- For long recording intervals, we recommend setting [Lens Focus Resume] to [ON] in the [Custom] ([Lens / Others]) menu.

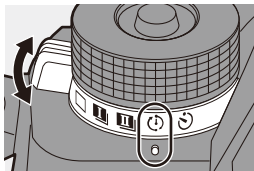
1 Set the drive mode dial to [].



2 Set [Mode] to [Time Lapse Shot].

-  → [] → [] → [Time Lapse/Animation] → [Mode] → [Time Lapse Shot]

Time Lapse/Animation	
Mode	Time Lapse Shot
Shooting Interval Setting	ON
Start Time	Now
Image Count	1
Shooting Interval	1m00s
Exposure Leveling	OFF
End	2019.12.1 10:00

3 Set the recording settings.

[Mode]	Switches between Time Lapse Shot and Stop Motion Animation.	
[Shooting Interval Setting]	[ON]	Sets the interval before the next recording takes place.
	[OFF]	Takes pictures without leaving recording intervals.
[Start Time]	[Now]	Starts recording when the shutter button is pressed fully.
	[Start Time Set]	Starts recording at the set time.
[Image Count]/ [Shooting Interval]	Sets the number of pictures and the recording interval to be taken. <ul style="list-style-type: none"> • [Shooting Interval] is not displayed when [Shooting Interval Setting] is set to [OFF]. 	
[Exposure Leveling]	Adjusts the exposure automatically to prevent large changes in brightness between adjacent frames.	

4 Close the menu.

- Press the shutter button halfway.

5 Start recording.

- Press the shutter button fully.
- When [Start Time Set] is set, the camera will enter into sleep status until the start time is reached.
- During recording standby, the camera enters into sleep status when no operation is performed for a certain period of time.
- The recording will stop automatically.

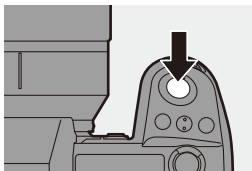

6 Create a video. (→ 156)

- After the recording has stopped, select [Yes] on the confirmation screen to proceed to create a video.
Even if you select [No], you can still create a video with [Time Lapse Video] in the [Playback] ([Process Image]) menu. (→ 459)

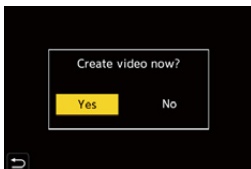

❖ Operations during Time Lapse Shot Recording

Pressing the shutter button halfway during sleep status will turn on the camera.

- You can perform the following operations by pressing [Q] during Time Lapse Shot recording.

[Continue]	Returns to the recording. (Only during recording)
[Pause]	Pauses the recording. (Only during recording)
[Resume]	Resumes the recording. (Only while paused) <ul style="list-style-type: none"> • You can also press the shutter button to resume.
[End]	Stops the Time Lapse Shot recording.



- Pictures recorded to more than one card cannot be combined into a single video.
- Pictures taken with [HLG Photo] cannot be converted to videos.
- The camera gives priority to achieving the correct exposure, so it may not take pictures at the set interval or take the set number of pictures. Furthermore, it may not end at the end time displayed on the screen.
- Time Lapse Shot is paused in the following cases.
 - When the charge on the battery runs out
 - When you set the camera on/off switch to [OFF]
You can set the camera on/off switch to [OFF] and replace the battery or card.
Set the camera on/off switch to [ON] and then press the shutter button fully to resume recording.
(Note that the images recorded after replacing the card will be saved as a separate set of group images.)
- [Exposure Leveling] is not available if ISO sensitivity is set to other than [AUTO] in [M] mode.
- [Time Lapse Shot] is not available when using the following functions:
 - [High Resolution Mode]
 - [Post-Focus]
 - [Multiple Exposure]

Recording with Stop Motion Animation

iA P A S M 





Take pictures while moving the subject little by little.

The pictures taken will be saved as a set of group images that can be combined into a stop motion video.

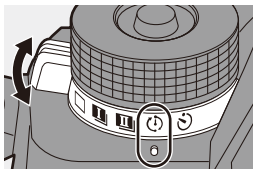
1 Set the drive mode dial to [].



2 Set [Mode] to [Stop Motion Animation].

-  → [] → [] → [Time Lapse/Animation] → [Mode] → [Stop Motion Animation]

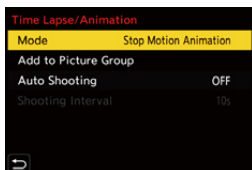

3 Set the recording settings.

[Mode]	Switches between Time Lapse Shot and Stop Motion Animation.	
[Add to Picture Group]	Allows you to continue recording for a set of stop motion images that have already been recorded. <ul style="list-style-type: none"> • Select an image and proceed to Step 5. 	
[Auto Shooting]	[ON]	Takes pictures automatically at a set recording interval.
	[OFF]	This is for taking pictures manually, frame by frame.
[Shooting Interval]	Sets the recording interval for [Auto Shooting].	

4 Close the menu.

- Press the shutter button halfway.

5 Start recording.

- Press the shutter button fully.
- Take pictures repeatedly while moving the subject little by little.
- The recording screen displays up to two pictures taken previously. Use them as reference for the amount of movement.
- You can play back the recorded stop motion images by pressing [▶] during recording.

Press [🗑️] to delete unnecessary images.

To return to the recording screen, press [▶] again.

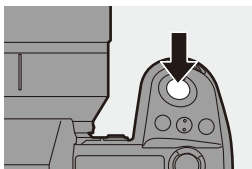

6 Stop recording.

- Press [MENU/SET] and then select [Time Lapse/Animation] from the [Photo] menu to stop recording.

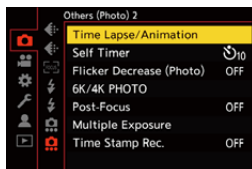

7 Create a video. (→ 156)

- After the recording has stopped, select [Yes] on the confirmation screen to proceed to create a video. Even if you select [No], you can still create a video with [Stop Motion Video] in the [Playback] ([Process Image]) menu. (→ 459)





- Pictures taken with [HLG Photo] cannot be converted to videos.
- Up to 9999 frames can be recorded.
- If the camera is turned off while recording, a message for resuming the recording is displayed when it is turned on. Selecting [Yes] allows you to continue the recording from the interruption point.
- The camera gives priority to achieving the correct exposure, so it may not take pictures at the set interval when the flash, etc. is used for recording.
- A picture cannot be selected from [Add to Picture Group] when it is the only one that was taken.
- [Stop Motion Animation] is not available when using the following functions:
 - [High Resolution Mode]
 - [Post-Focus]
 - [Multiple Exposure]

Time Lapse Shot/Stop Motion Animation Videos

After performing Time Lapse Shot or stop motion recording, you can proceed to create a video.

- Refer to the sections below about these recording functions.
 - Time Lapse Shot recording: → 149
 - Stop motion recording: → 153
- You can also create videos with [Time Lapse Video] (→ 459) or [Stop Motion Video] (→ 459) in the [Playback] menu.

1 Select **[Yes]** on the confirmation screen that appears after recording.

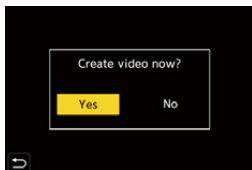

2 Set the options for creating a video.

3 Select **[OK]**.

- A video will be created in the [MP4] recording file format.

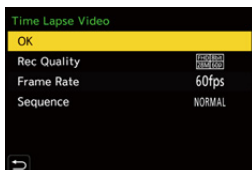

[OK]	Creates a video.	
[Rec Quality]	Sets the video image quality.	
[Frame Rate]	Sets the number of frames per second. The larger the number is, the smoother the video will be.	
[Sequence]	[NORMAL]	Splices pictures together in recording order.
	[REVERSE]	Splices pictures together in reverse recording order.



- Videos cannot be created when the [System Frequency] is set to [24.00Hz (CINEMA)].
- Videos cannot be created if the recording time exceeds 29 minutes and 59 seconds.
- In the following cases, videos cannot be created if the file size exceeds 4 GB:
 - When an SDHC memory card is being used and a 4K [Rec Quality] is set
 - When an FHD [Rec Quality] is set

Recording Using the Self-timer

iA P A S M 



1 Set the drive mode dial to [⏸].

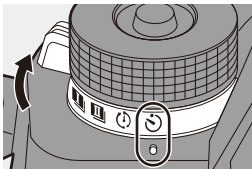

2 Decide on the composition and then adjust the focus.

- Press the shutter button halfway.
- The focus and exposure are fixed when the shutter button is pressed halfway.







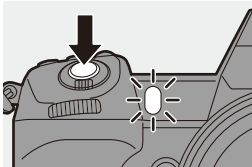

3 Start recording.

- Press the shutter button fully.
- The self-timer light blinks and then the shutter is released.



❖ Setting the Self-timer Time

 →  →  → Select [Self Timer]

	Takes a picture after 10 seconds.
	Takes 3 pictures at approx. 2 second intervals after 10 seconds.
	Takes a picture after 2 seconds. <ul style="list-style-type: none"> • This setting is a convenient way to avoid camera shake caused by pressing the shutter button.



- We recommend using a tripod when recording with the self-timer.



- When the following functions are being used,  is not available:
 - [Simultaneous Record w/o Filter] ([Filter Settings])
 - [Bracketing]
 - [Multiple Exposure]
- The self-timer does not work while you are using the following functions:
 - [High Resolution Mode]
 - [Post-Focus]

Bracket Recording

iA P A S M 



When the shutter button is pressed, the camera can record multiple images while automatically changing the setting value for exposure, aperture, focus or white balance (adjustment value or color temperature).



- Aperture Bracket can be selected in the following modes:
 - [A] mode
 - [M] mode (when ISO sensitivity is set to [AUTO])
- White Balance Bracket (Color Temperature) can be selected when the white balance is set to [K1], [K2], [K3], or [K4].

1 Set [Bracketing Type].

-  →  →  →
[Bracketing] → [Bracketing Type]

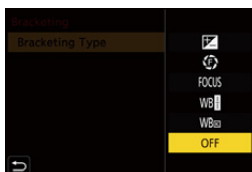

2 Set [More Settings].

- For information about [More Settings], refer to page for each bracketing method.

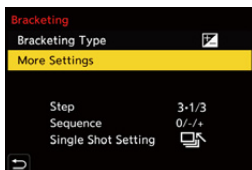



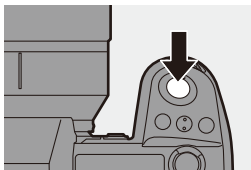

3 Close the menu.

- Press the shutter button halfway.

4 Focus on the subject and then take pictures.



❖ Setting Items ([Bracketing Type])

[] Exposure Bracket	When the shutter button is pressed, the camera records while changing the exposure. (→ 163)
[] Aperture Bracket	When the shutter button is pressed, the camera records while changing the aperture value. (→ 163)
[FOCUS] Focus Bracket	When the shutter button is pressed, the camera records while changing the focus point. (→ 164)
[WB ] White Balance Bracket	When the shutter button is pressed once, the camera automatically records three images with the different white balance adjustment values. (→ 165)
[WB ] White Balance Bracket (Color Temperature)	When the shutter button is pressed once, the camera automatically records three images with the different white balance color temperatures. (→ 165)
[OFF]	—



❖ How to Cancel Bracketing

Select [OFF] in Step 1.



- When [Aspect Ratio] is set to [65:24]/[2:1], only the Exposure Bracket can be used.
- White Balance Bracket and White Balance Bracket (Color Temperature) are not available when using the following functions:
 - [iA] mode
 - Taking burst pictures
 - [RAW+FINE]/[RAW+STD.]/[RAW] ([Picture Quality])
 - [HLG Photo]
 - [Filter Settings]
- Bracket recording is not available while you are using the following functions:
 - [6K/4K PHOTO]/[Post-Focus]
 - [Time Lapse Shot]
 - [Stop Motion Animation] (when [Auto Shooting] is set)
 - [High Resolution Mode]
 - [Rough Monochrome]/[Silky Monochrome]/[Miniature Effect]/[Soft Focus]/[Star Filter]/[Sunshine] ([Filter Settings])
 - [Multiple Exposure]



- You can register functions to Fn buttons:
[] ⇒ [] ⇒ [Fn Button Set] ⇒ [Setting in REC mode] ⇒ [Bracketing]
(→ [367](#))

❖ [More Settings] (Exposure Bracket)

[Step]	Sets the image count and exposure compensation step. [3•1/3] (record 3 images in 1/3 EV steps) to [7•1] (record 7 images in 1 EV steps)
[Sequence]	Sets the order in which images are recorded.
[Single Shot Setting]	<p>[□]: Takes only one image each time the shutter button is pressed.</p> <p>[□/□]: Takes all of the set number of images when the shutter button is pressed once.</p> <ul style="list-style-type: none"> • The [BKT] icon blinks until all of the set number of pictures is taken. • This cannot be set when taking burst pictures. <p>If you press and hold the shutter button, burst pictures are taken until the set number of images is recorded.</p>



- When you record images with Exposure Bracket after setting the exposure compensation value, the images recorded are based on the selected exposure compensation value.

❖ [More Settings] (Aperture Bracket)

[Image Count]	<p>[3]/[5]: Records the set number of images while alternately setting the aperture value in the sequence of one before and then one after using the initial aperture value as the reference.</p> <p>[ALL]: Records images using all aperture values.</p>
----------------------	---

Example when the initial position is set to F8.0

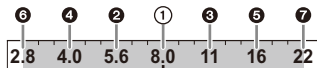

- ① 1st image, ② 2nd image, ③ 3rd image ... ⑦ 7th image

❖ [More Settings] (Focus Bracket)

[Step]	Sets the focus adjustment step. <ul style="list-style-type: none"> The distance that the focus point is moved becomes shorter if the initial focus point is close, and longer if it is far away.
[Image Count]	Sets the image count. <ul style="list-style-type: none"> This cannot be set when taking burst pictures. Burst pictures are taken while the shutter button is pressed.
[Sequence]	<p>[0/-/+]: Records while alternately moving the focus point in the sequence of forward and then backward using the initial focus point as the reference.</p> <p>[0/+]: Records while moving the focus point toward the far side using the initial focus point as the reference.</p>

Example when [Sequence]: [0/-/+] is set

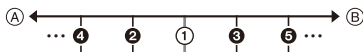

Example when [Sequence]: [0/+] is set



(A) Focus: closer





(B) Focus: more distant

① 1st image, ② 2nd image ... ⑤ 5th image ...



• Pictures recorded with Focus Bracket are displayed as images of one group.

❖ [More Settings] (White Balance Bracket)

Rotate ,  or  to set the correction step and then press  or .





Rotate to the right:

Horizontal direction ([A] - [B])

Rotate to the left:



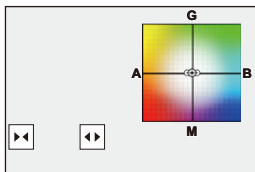

Vertical direction ([G] - [M])

- The correction step can also be set by touching

[] / [] / [] / [].



❖ [More Settings] (White Balance Bracket (Color Temperature))

Rotate ,  or  to set the correction step and then press  or .

- The correction step can also be set by touching

[] / [].

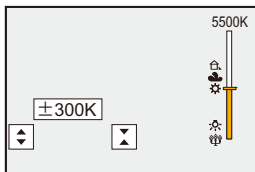

Post-Focus Recording

iA P A S M 



Taking burst pictures with the same image quality as 6K/4K photos while automatically changing the focus point.

You can select the focus point for the picture to save after recording.

Also Focus Stacking lets you combine images with multiple focus points.

This function is suitable for subjects that do not move.

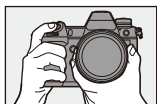

Perform burst 6K/4K photo recording while automatically shifting the focus.

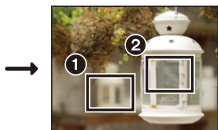

Touch the desired focus point.



A picture with the desired focus point is made.



- Use a UHS Speed Class 3 or higher card when recording.
- The angle of view during recording becomes narrower. (when using a full-frame lens)
- If you are going to perform Focus Stacking after recording, we recommend using a tripod during recording.

1 Set the image quality for [Post-Focus].

-  →  →  → [Post-Focus] → [6K 18M]/[4K 8M]

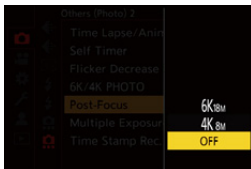

2 Close the menu.

- Press the shutter button halfway.

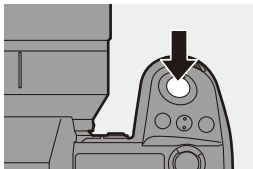

3 Decide on the composition and then adjust the focus.

- Press the shutter button halfway.
- AF detects the focus point on the screen. (Excluding the edges of the screen)

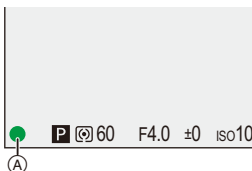

- If no areas on the screen can be brought into focus, the focus indication (A) blinks and recording is not possible.
- Maintain the same distance to the subject and the same composition until recording finishes.

4 Start recording.

- Press the shutter button fully.
- Recording is performed while automatically changing the focus point. When the icon (B) disappears, recording ends automatically.
- A video will be recorded with [Rec. File Format] set to [MP4]. (Audio will not be recorded.)
- In default settings, Auto Review operates, and a screen that lets you select the focus point will be displayed. (→ 169)







- Since recording is performed with the same image quality as 6K/4K photos, limitations apply to recording functions and menus.
- Focus settings cannot be changed during Post-Focus recording.
- When using Super 35 mm/APS-C lenses, [6K 18M] is not available.
- When the following functions are being used, [Post-Focus] is not available:
 - [Time Lapse Shot]
 - [Stop Motion Animation]
 - [High Resolution Mode]
 - [Rough Monochrome]/[Silky Monochrome]/[Miniature Effect]/[Soft Focus]/[Star Filter]/[Sunshine] ([Filter Settings])
 - [Multiple Exposure]





- You can register functions to Fn buttons:

[] ⇒ [] ⇒ [Fn Button Set] ⇒ [Setting in REC mode] ⇒ [Post-Focus]
(→ [367](#))

Selecting the Focus Point for the Picture to Save

1 Select a Post-Focus image on the playback screen. (→ 347)

- Select an image with the [] icon and then press ▲.
- You can also perform the same operation by touching the [] icon.



2 Touch the focus point.











- When the point is in focus, a green frame appears.
- If there is no picture with the selected point in focus, a red frame appears. A picture cannot be saved.
- The edge of the screen cannot be selected.

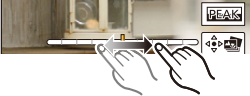

3 Save the picture.

- Touch [].
- The picture is saved in JPEG format.

❖ Focus Point Selection Operations

Button operation	Touch operation	Description of operation
	Touch	<p>Selects a focus position.</p> <ul style="list-style-type: none"> • Selection is not possible during enlarged display.
		<p>Enlarges the display.</p> <ul style="list-style-type: none"> • During enlarged display, you can fine-adjust the focus by dragging the slide bar. (You can also perform the same operation by pressing ◀▶.) 
		Reduces the display (during enlarged display).
		Switches to Focus Stacking operation. (→ 171)
—		<p>Displays the in-focus portion highlighted with color ([Focus Peaking]).</p> <ul style="list-style-type: none"> • [ON]/[OFF] switches.
		Saves the picture.



 • You cannot display an image on a TV screen and then select the focus point.

Focus Stacking

By merging multiple focus points, you can save pictures that are focused from the foreground through to the background.



- (A) Focus: closer
 (B) Focus: more distant

- 1 On the screen for selecting the focus point in Step 2 on page 169, touch [ ].

- You can also perform the same operation by pressing [].

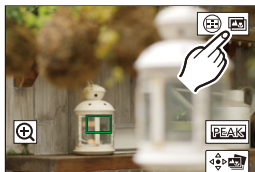

- 2 Select the merging method.

[Auto Merging]	Automatically selects pictures suitable for merging and then merges them into a single picture.
[Range Merging]	Merges pictures with selected focus points into a single picture.

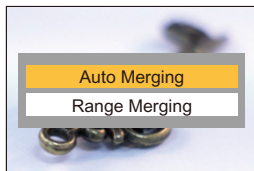

3 (When [Range Merging] is selected)

Touch the focus points.



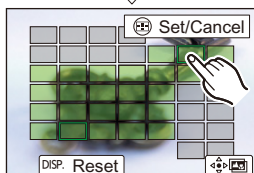
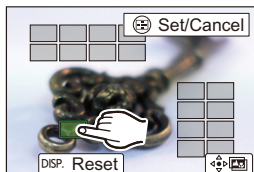

- Select at least two points.
Selected points are indicated with a green frame.
- The in-focus range between the two selected points is displayed in green.
- Ranges that cannot be selected are displayed in gray.
- To cancel the selection, touch a point with a green frame again.
- To select consecutive points, drag the screen.



4 Save the picture.

- Touch [].

❖ Operations when [Range Merging] Is Selected

Button operation	Touch operation	Description of operation
	Touch	Selects a point.
[]	[Set/Cancel]	Sets or cancels a point.
[DISP.]	[All]	Selects all points. (Before selecting points)
	[Reset]	Cancel all selections. (After selecting points)
		Merges the pictures and saves the resulting picture.

-  The picture is saved in JPEG format ([FINE] picture quality), and the recording information (Exif information), such as the shutter speed, aperture, and ISO sensitivity, of the picture with the closest point is also saved with the picture that is saved.
- Image misalignment due to camera shake will be adjusted automatically. If adjustments are made, the angle of view will become slightly narrower when the pictures are merged.
- If the subject moves during recording or the distance between subjects is great, merging may create an unnatural picture.





[Silent Mode]

iA P A S M 



This disables all operation sounds and light output at once.

The audio from the speaker will be muted and the flash and the AF assist light will be set to forced off mode.

- The following settings are fixed:
 - [Flash Mode]: [] (Forced Flash Off)
 - [AF Assist Light]: [OFF]
 - [Shutter Type]: [ELEC.]
 - [Tally Lamp]: [OFF]
 - [Beep Volume]: [] (OFF)
 - [AF Beep Volume]: [] (OFF)
 - [E-Shutter Vol]: [] (OFF)
 - [Card Access Light]: [OFF]

 ⇒ [] ⇒ [] ⇒ Select [Silent Mode]



Settings: [ON]/[OFF]



- Even when [ON] is set, the following functions light/blink:
 - Self-timer light
 - Status LCD Backlight
 - Illuminated buttons
- Use this function at your own responsibility sufficiently considering the privacy, portrait, and other rights of subjects.



- You can register functions to Fn buttons:

[] ⇒ [] ⇒ [Fn Button Set] ⇒ [Setting in REC mode] ⇒ [Silent Mode]
(→ 367)

[Shutter Type]

iA P A S M 



Selects the shutter type to use for taking pictures.

 → [] → [] → Select [Shutter Type]

[AUTO]	Switches the shutter type automatically depending on the recording conditions and shutter speed.
[MECH.]	Records with the mechanical shutter type.
[EFC]	Records with the electronic front curtain type.
[ELEC.]	Records with the electronic shutter type.
[ELEC.+NR]	Records with the electronic shutter type. When pictures are taken at slower shutter speeds, the shutter is closed after recording to perform long shutter noise reduction. <ul style="list-style-type: none"> • The next picture cannot be taken during long shutter noise removal.

	Mechanical shutter type	Electronic front curtain type	Electronic shutter type
Mechanism	This type starts and ends exposure with the mechanical shutter.	This type starts exposure electronically and ends it with the mechanical shutter.	This type starts and ends exposure electronically.
Flash	✓	✓	—
Shutter speed (sec.)	[B] (Bulb, max. approx. 30 minutes) ^{*1} , 60 to 1/8000	[B] (Bulb, max. approx. 30 minutes) ^{*1} , 60 to 1/2000	[B] (Bulb, max. approx. 60 seconds) ^{*1} , 60 to 1/8000
Shutter sound	Mechanical shutter sound	Mechanical shutter sound	Electronic shutter sound ^{*2}



*1 This setting is available only in [M] mode.

*2 The electronic shutter sound can be set in [E-Shutter Vol] and [E-Shutter Tone] in [Beep] of the [Setup] ([IN/OUT]) menu. (→ 448)

- The electronic front curtain type reduces blur caused by the shutter because the amount of vibration from the shutter is small compared to the mechanical shutter type.
- The electronic shutter type allows you to record without vibration from the shutter.



- To reduce shutter-induced blur, you can set the shutter to release a few seconds after the shutter button is pressed:

[] ⇒ [] ⇒ [Shutter Delay] (→ [406](#))



- When [] is displayed on the screen, recording will be with the electronic shutter type.
- When a moving subject is recorded using the electronic shutter, the subject may appear distorted in the picture.
- When you record using the electronic shutter under lighting such as fluorescent or LED lighting, horizontal stripes may be recorded. In such a case, lowering the shutter speed may reduce the effect of horizontal stripes.
- When [Silent Mode] is being used, [Shutter Type] is fixed to [ELEC.].
- When using Super 35 mm/APS-C lenses, the electronic front curtain is not available.



- You can register functions to Fn buttons:

[] ⇒ [] ⇒ [Fn Button Set] ⇒ [Setting in REC mode] ⇒ [Shutter Type] (→ [367](#))

Image Stabilizer

iA P A S M 







This camera can use both the in-body image stabilizer and the in-lens image stabilizer.

Of the Dual I.S. modes that effectively combine two image stabilizers, this supports Dual I.S.2 with high correction efficiency.

Furthermore, during video recording, you can use the 5-Axis Hybrid Image Stabilizer that incorporates electronic stabilization.

Combinations of lenses and image stabilizers (As of August 2019)

Image stabilizers that can be used will differ depending on the attached lens.

Attached lens	Available image stabilizer	Example of icon
Panasonic lenses with image stabilization function	Body+Lens (Dual I.S.2)	DUAL2 
Other manufacturer's lenses with image stabilization function	Body or Lens	BODY / LENS 
Lenses without image stabilizer	Body	BODY 
Lenses without communication function	Body	BODY 

- The 5-Axis Hybrid Image Stabilizer (→ [179](#)) can be used with any lenses.

❖ Using the Image Stabilizer

- When using a lens with an O.I.S. switch, set the switch on the lens to [ON].
- When using a lens that does not have a communication function with this camera, after turning on the camera, a message asking for confirmation of the lens information is displayed.

For the image stabilizer function to operate correctly, it is necessary to set the image circle, focal length, and image stabilizer range to suit the lens. Follow the message to make the settings.

This can also be set using the menu. (→ [183](#))



- When the shutter button is pressed halfway, the camera shake alert icon [([📷])] may be displayed on the recording screen.
If this is displayed, we recommend using a tripod, the self timer or the Shutter Remote Control (DMW-RS2: optional).
- We recommend turning off the image stabilizer function when using a tripod.



- The image stabilizer may cause vibration or produce operational sound during operation, but these are not malfunctions.
- When the following function is being used, the image stabilizer function is not available:
 - [High Resolution Mode]







- When using a lens that does not have a communication function with this camera, you can hide the message asking for confirmation of the lens information that is displayed after turning on the camera:
[⚙️] → [📷] → [Lens Info. Confirmation] (→ [443](#))
- You can display the reference point and check the camera shake status:
[⚙️] → [📷] → [I.S. Status Scope] (→ [437](#))



Image Stabilizer Settings

Set the image stabilizer operation to match the recording situation.



 →  →  → Select [Image Stabilizer]

[Operation Mode]	Sets the stabilization movement (blur) to match the recording method (normal, panning). (→ 181)	
[Body(B.I.S.) / Lens(O.I.S.)]	[^{BODY}] ([Body])	Uses the in-body image stabilizer.
	[^{LENS}] ([Lens])	Uses the in-lens image stabilizer.
	<ul style="list-style-type: none"> • This can be set when using other manufacturer's lenses with an image stabilization function. 	
[When to Activate]	[ALWAYS]	The image stabilizer is always operating.
	[HALF-SHUTTER]	The image stabilizer operates when the shutter button is pressed halfway.
[E-Stabilization (Video)]	<p>Camera shake during video recording is corrected along the vertical, horizontal, roll, pitch, and yaw axes through the combined use of the in-lens, in-body, and electronic image stabilizers. (5-Axis Hybrid Image Stabilizer)</p> <ul style="list-style-type: none"> • The [] on the recording screen changes to [] while [E-Stabilization (Video)] is functioning. • The angle of view may become narrower if set to [ON]. 	
[Boost I.S. (Video)]	<p>Increases the effectiveness of the image stabilizer during video recording.</p> <p>This effect can help provide a stable composition when you want to perform recording from a fixed perspective. (→ 182)</p>	
[Anamorphic (Video)]	You can switch to an image stabilizer that suits anamorphic recording. (→ 182)	
[Lens Information]	When using a lens that does not have a communication function with the camera, register the lens information in the camera. (→ 183)	







- When the following functions are being used, [When to Activate] is fixed to [ALWAYS]:
 - [] ([Body(B.I.S.) / Lens(O.I.S.)])
 - [] mode
 - Video recording/[6K/4K PHOTO]/[Post-Focus]
- When the following functions are being used, [E-Stabilization (Video)] is not available:
 - 6K video/5.9K video/5.4K video
 - [Variable Frame Rate]
 - [Live Cropping]





- You can register functions to Fn buttons:
[] ⇒ [] ⇒ [Fn Button Set] ⇒ [Setting in REC mode] ⇒ [E-Stabilization (Video)] (→ [367](#))

❖ [Operation Mode]



Set the stabilization movement (blur) to match the recording method (normal, panning).

 [Normal]	Corrects vertical, horizontal, and rotational camera shake. This function is suitable for normal recording.
 [Panning (Auto)]	Automatically detects the panning direction, and corrects vertical and horizontal camera shake. This function is suitable for panning.
 [Panning (Left/Right)]	Corrects vertical camera shake. This is suitable for horizontal panning.
 [Panning (Up/Down)]	Corrects horizontal camera shake. This is suitable for vertical panning.
[OFF]	Turns the image stabilization function OFF.

- Operation modes that can be used will differ depending on the used lenses and on [Body(B.I.S.) / Lens(O.I.S.)] settings.
- [Panning (Auto)] is not displayed when using other manufacturer's lenses with an image stabilization function with [Body(B.I.S.) / Lens(O.I.S.)] set to . Set to either [Panning (Left/Right)] or [Panning (Up/Down)] to suit the panning direction.
- When using lenses with an O.I.S. switch, the camera's operation mode cannot be set to [OFF]. Set the switch on the lens to [OFF].
- When the following functions are being used, [Operation Mode] switches to  ([Normal]):
 -  mode
 - Video recording/[6K/4K PHOTO]/[Post-Focus]



- You can register functions to Fn buttons:

[] ⇒ [] ⇒ [Fn Button Set] ⇒ [Setting in REC mode] ⇒ [Image Stabilizer] (→ 367)

❖ [Boost I.S. (Video)]

Increase the effectiveness of the image stabilizer during video recording. This effect can help provide a stable composition when you want to perform recording from a fixed perspective.



Settings: [ON]/[OFF]

- When [Boost I.S. (Video)] is operating, [] is displayed on the recording screen.
- To change composition while recording, first set this to [OFF] before moving the camera.
To set this to [OFF] during recording, use the Fn button. (→ 367)
- Longer focal lengths will result in weaker stabilization.







- When [Body(B.I.S.) / Lens(O.I.S.)] is set to [, [Boost I.S. (Video)] is not available.





- You can register functions to Fn buttons:
[] ⇒ [] ⇒ [Fn Button Set] ⇒ [Setting in REC mode] ⇒ [Boost I.S. (Video)] (→ 367)

❖ [Anamorphic (Video)]

You can switch to an image stabilizer that suits anamorphic recording.

Settings: []([2.0×])/[]([1.8×])/[]([1.5×])/[]([1.33×])/[]([1.30×])/[OFF]

- Make settings to suit the magnification of the anamorphic lens you are using.
- While [Anamorphic (Video)] is functioning, the set magnification appears on the image stabilizer icons on the recording screen, as shown by [] and [].



- When [Boost I.S. (Video)] is set, [Boost I.S. (Video)] is prioritized.
- When the following function is being used, [Anamorphic (Video)] is fixed to [OFF]:
– [] ([Body(B.I.S.) / Lens(O.I.S.)])
- Image stabilizer functions on your lens may not work correctly. Turn off the image stabilizer function on your lens if this is the case.

❖ [Lens Information]

Register the information for lenses that cannot communicate with the camera.

Match the in-body image stabilizer with the information of the lens you register.

The settings on this camera enable you to switch settings to suit full-frame or Super 35 mm/APS-C lenses. (→ 24)





Press ▲▼ to select the lens information to use and then press  or .

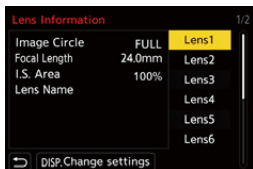



- In the default setting, the lens information for 6 lenses with a focal length of between 24 mm and 135 mm is registered.

The lens information for up to 12 lenses can be registered.



Registering, modifying, and deleting lens information

- 1 Press ▲▼ to select the lens information and then press [DISP.].
 - If lens information that has not been registered is selected, press  or  to proceed to Step 3.
- 2 Press ▲▼ to select [Edit] or [Delete] and then press  or .
 - The lens information is deleted when you select [Delete].
 - You cannot delete the lens information for a lens that is being used.
- 3 Enter the lens Information.
 - The lens information changes if the lens information has already been registered.
- 4 (If lens information that has not been registered is selected) Press [DISP.] to register the lens information.

[Image Circle]	<p>Select the image circle for the lens.</p> <p>[FULL]: Full-frame lens [S35mm]: Lens for Super 35 mm/lens for APS-C</p>
[Focal Length]	<p>Enter the focal length.</p> <ul style="list-style-type: none"> The live view images can be enlarged for display when you rotate .
[I.S. Area]	<p>You can set the range of stabilization for the image stabilizer so that vignetting does not occur due to the image stabilizer.</p> <p>[70%]/[80%]/[90%]/[100%]</p> <ul style="list-style-type: none"> Rotate  to select the range of stabilization, then press  or  to confirm. When the four edges are selected by pressing , the in-body image stabilizer works and you can see if there is any vignetting. If vignetting has occurred, set again to a smaller range.
[Lens Name]	<p>Register the lens.</p> <ul style="list-style-type: none"> For information on how to enter characters, refer to page 464. Up to a maximum of 30 characters can be entered.

7. Metering/Exposure/ISO Sensitivity





[Metering Mode]

iA P A S M 





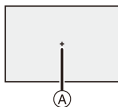

Type of optical measurement to measure brightness can be changed.

 → [] → [] → Select [Metering Mode]

[] (Multi-metering)	Method in which the most suitable exposure is measured by judging the allocation of brightness on the whole screen.
[] (Center-weighted)	Method used to perform measuring which focuses on the center of the screen.
[] (Spot)	Method used to measure the extremely small part around the spot-metering target  . • When you move the AF area, the spot metering target also moves to match.
[] (Highlight-weighted)	Method used to perform measuring which focuses on the highlighted parts of the screen to prevent overexposure. This is suitable for theatre photography, etc.



- • You can register functions to Fn buttons:
[] → [] → [Fn Button Set] → [Setting in REC mode] → [Metering Mode] (→ 367)
- The standard value for correct exposure can be adjusted:
[] → [] → [Exposure Offset Adjust.] (→ 419)

Program AE Mode

iA **P** A S M 



In [P] mode (Program AE mode), the camera automatically sets the shutter speed and aperture value for the brightness of the subject.

You can also use Program Shift to change combinations of shutter speed and aperture values while keeping the same exposure.

1 Set the mode dial to [P].

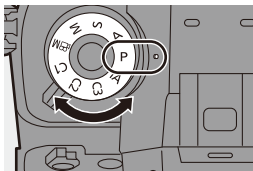

2 Press the shutter button halfway.

- This displays the aperture value (A) and shutter speed value (B) on the recording screen.
- If the correct exposure is not achieved, the aperture value and shutter speed blink red.

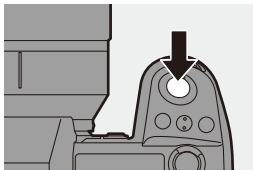

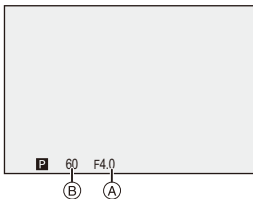

3 Start recording.





❖ Program Shift

You can change the shutter speed and aperture value combination set automatically by the camera while maintaining the same exposure. With this, you can, for example, make the background more defocused by decreasing the aperture value or capture a moving subject more dynamically by slowing the shutter speed.

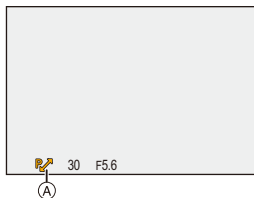
- ❶ Press the shutter button halfway.
 - This displays the aperture value and shutter speed value on the recording screen. (Approx. 10 seconds)
- ❷ Rotate  or  while the values are displayed.
 - This displays the Program Shift icon (A) on the recording screen.
- ❸ Start recording.





Canceling Program Shift

- Set the camera on/off switch to [OFF].
- Rotate  or  until the Program Shift icon disappears.



- Program Shift is not available when using the following functions:
 - Flash
 - [6K/4K PHOTO]/[Post-Focus]



- You can customize dial operations:
 - [] ⇒ [] ⇒ [Dial Set.] ⇒ [Assign Dial (F/SS)]/[Rotation (F/SS)] (→ 428)
- The recording screen can display an exposure meter indicating the relationship between aperture value and shutter speed:
 - [] ⇒ [] ⇒ [Expo.Meter] (→ 436)

Aperture-Priority AE Mode

iA P **A** S M 



In [A] mode (Aperture-Priority AE mode), you can set the aperture value before recording.

The shutter speed will be automatically set by the camera.



Smaller aperture values

It becomes easier to defocus the background.



Larger aperture values

It becomes easier to bring everything into focus including the background.

- 1 Set the mode dial to [A].

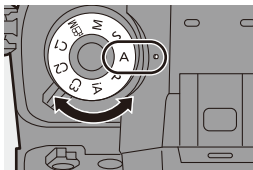

2 Set the aperture value.

- Rotate  or .

3 Start recording.

- If the correct exposure is not achieved when the shutter button is pressed halfway, the aperture value and the shutter speed blink red.

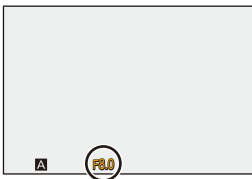
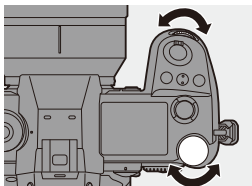

❖ Depth of Field Characteristics

Aperture value	Small	Large
Focal length of lens	Telephoto	Wide-angle
Distance to subject	Near	More distant
Depth of field (area in sharp focus)	Shallow (narrow) Example: When you want to take a image with a defocused background.	Deep (wide) Example: When you want to take a image with focus as far as the background.



- The effects of the set aperture value and shutter speed will not be visible on the recording screen.

To check the effects on the recording screen, use [Preview]. (→ [196](#))

- The brightness of the recording screen and of actual recorded images may differ.

Check the images on the playback screen.



- When using a lens with an aperture ring, set the position of the aperture ring to other than [A] to use the aperture value of the lens.



- You can customize dial operations:

[] ⇒ [] ⇒ [Dial Set.] ⇒ [Assign Dial (F/SS)]/[Rotation (F/SS)] (→ [428](#))

- The recording screen can display an exposure meter indicating the relationship between aperture value and shutter speed:

[] ⇒ [] ⇒ [Expo.Meter] (→ [436](#))

Shutter-Priority AE Mode

iA P A **S** M 



In [S] mode (Shutter-Priority AE mode), you can set the shutter speed before recording.

The aperture value will be automatically set by the camera.

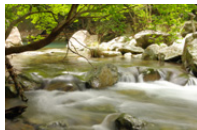

Slower shutter speeds

It becomes easier to capture motion



Faster shutter speeds

It becomes easier to freeze motion

1 Set the mode dial to [S].

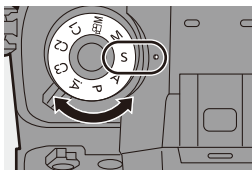

2 Set the shutter speed.

- Rotate  or .

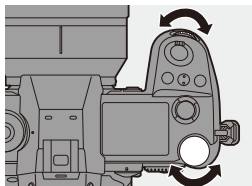



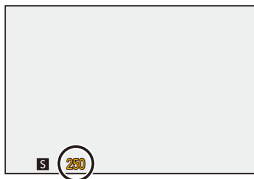

3 Start recording.

- If the correct exposure is not achieved when the shutter button is pressed halfway, the aperture value and the shutter speed blink red.



- The effects of the set aperture value and shutter speed will not be visible on the recording screen.
To check the effects on the recording screen, use [Preview]. (→ 196)
- The brightness of the recording screen and of actual recorded images may differ.
Check the images on the playback screen.
- Shutter speeds faster than 1/320 of a second are not available when you fire the flash. (→ 233)



- You can customize dial operations:
[] ⇒ [] ⇒ [Dial Set.] ⇒ [Assign Dial (F/SS)]/[Rotation (F/SS)] (→ 428)
- The recording screen can display an exposure meter indicating the relationship between aperture value and shutter speed:
[] ⇒ [] ⇒ [Expo.Meter] (→ 436)

Manual Exposure Mode

iA P A S **M** 



In [M] mode (Manual Exposure mode), you can take pictures by manually setting the aperture value and shutter speed.

In default settings, the ISO sensitivity is set to [AUTO].



As a result, the ISO sensitivity will be adjusted according to the aperture value and shutter speed.

Exposure compensation can also be used when ISO sensitivity is set to [AUTO].

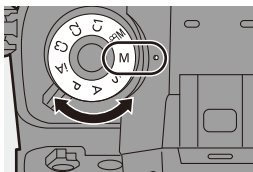
1 Set the mode dial to [M].



2 Set the aperture value and shutter speed.

- Rotate  to set the aperture value, and  to set the shutter speed.

- (A) Aperture value
- (B) Shutter speed

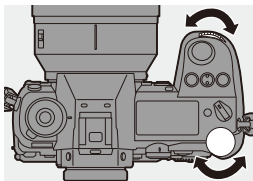

3 Start recording.

- If the correct exposure is not achieved when the shutter button is pressed halfway, the aperture value and the shutter speed blink red.

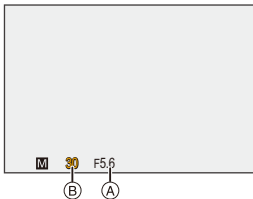

❖ Available Shutter Speeds (Sec.)

[MECH.]	[B] (Bulb, max. approx. 30 minutes), 60 to 1/8000
[EFC]	[B] (Bulb, max. approx. 30 minutes), 60 to 1/2000
[ELEC.]	[B] (Bulb, max. approx. 60 seconds), 60 to 1/8000



- The effects of the set aperture value and shutter speed will not be visible on the recording screen.

To check the effects on the recording screen, use [Preview]. (→ 196)

You can set the preview mode to operate constantly in [M] mode.

[] → [] → [Constant Preview] (→ 431)

- The brightness of the recording screen and of actual recorded images may differ.
Check the images on the playback screen.
- When using a lens with an aperture ring, set the position of the aperture ring to other than [A] to use the aperture value of the lens.
- Shutter speeds faster than 1/320 of a second are not available when you fire the flash. (→ 233)



- You can customize dial operations:

[] → [] → [Dial Set.] → [Assign Dial (F/SS)]/[Rotation (F/SS)] (→ 428)

- The recording screen can display an exposure meter indicating the relationship between aperture value and shutter speed:

[] → [] → [Expo.Meter] (→ 436)

❖ Manual Exposure Assist

When ISO sensitivity is set to other than [AUTO], Manual Exposure Assist (example: +1) will be displayed on the recording screen.

You can check the difference between the current exposure value and the correct exposure (± 0) measured by the camera.

- Use Manual Exposure Assist as a guide.

We recommend checking the images on the playback screen when recording.

❖ [B] (Bulb)

If you set the shutter speed to [B] (Bulb), the shutter stays open while the shutter button is pressed fully. (up to approx. 30 minutes)

The shutter closes when the shutter button is released.

Use this when you want to keep the shutter open for a long time to record images of fireworks, night scenery or a starry sky.



- We recommend using a tripod or the Shutter Remote Control (DMW-RS2: optional) during bulb recording.
- Bulb recording may create noticeable noise.
If you are concerned about noise, we recommend that you set [Long Exposure NR] (→ 397) to [ON] in the [Photo] ([Image Quality]) menu before recording.



- Bulb is not available when using the following functions:
 - [6K/4K PHOTO]/[Post-Focus]
 - [Time Lapse Shot]
 - [Stop Motion Animation] (when set to [Auto Shooting])
 - [Bracketing]
 - [High Resolution Mode]

Preview Mode



You can check the effects of aperture on the recording screen by physically closing the aperture blades of the lens to the aperture value set for actual recording.

In addition to the effects of aperture, you can check the effects of shutter speed at the same time.

- Use the Fn button registered with [Preview] to operate. In default settings, this is registered in the [Fn2] button.

For information about the Fn button, refer to page [367](#).

Press the preview button.

- Each press of the button switches between the effect preview screens.

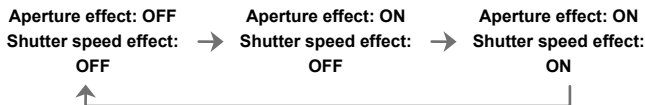
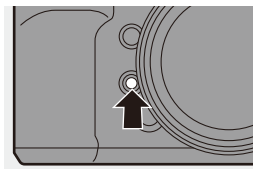

- It is possible to record in preview mode.
- Range for shutter speed effect check is 8 seconds to 1/8000 of a second.
- Preview mode is not available when recording with [6K/4K Pre-Burst].

Exposure Compensation

iA P A S M 



You can compensate the exposure when the correct exposure determined by the camera is too bright or too dark.

You can adjust the exposure in 1/3 EV steps in a range of ± 5 EV.

When recording videos or recording with 6K/4K photo or Post-Focus, the range changes to ± 3 EV.

- 1 Press [].
- 2 Compensate the exposure.

- Rotate , , or .

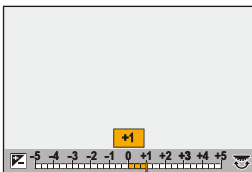
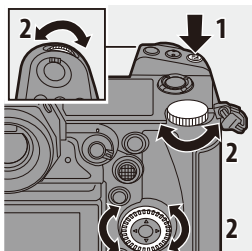



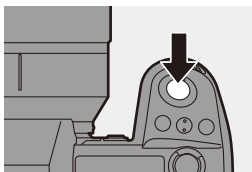





- 3 Confirm your selection.
- Press the shutter button halfway.





- In [M] mode, you can compensate the exposure by setting the ISO sensitivity to [AUTO].
- When [Auto Exposure Comp.] is set to [ON], the flash output will automatically be set to the level appropriate to the exposure compensation.
- When the exposure compensation value falls below or exceeds ± 3 EV, the brightness of the recording screen will no longer change.
Press the shutter button halfway or use AE Lock to reflect the value on the recording screen.
- The set exposure compensation value is stored even if you turn off the camera.



- The standard value for correct exposure can be adjusted:
[] \Rightarrow [] \Rightarrow [Exposure Offset Adjust.] (\rightarrow 419)
- You can set the exposure compensation value to be reset when the camera is turned off:
[] \Rightarrow [] \Rightarrow [Exposure Comp. Reset] (\rightarrow 420)
- You can change the operation of the [] button:
[] \Rightarrow [] \Rightarrow [WB/ISO/Expo. Button] (\rightarrow 427)
- Exposure Bracket can be set and flash output can be adjusted on the exposure compensation screen:
[] \Rightarrow [] \Rightarrow [Exposure Comp. Disp. Setting] (\rightarrow 427)

Locking Focus and Exposure (AF/AE Lock)



Lock the focus and exposure in advance to take pictures with the same focus and exposure settings while changing the composition.

This is useful when you want to bring an edge of the screen into focus or there is a backlight, for example.

1 Register [AE LOCK], [AF LOCK], or [AF/AE LOCK] to the Fn button. (→ 367)

- These cannot be registered to [Fn3] to [Fn7].

[AE LOCK]	The exposure is locked.
[AF LOCK]	The focus is locked.
[AF/AE LOCK]	Both focus and exposure are locked.

2 Lock focus and exposure.

- Press and hold the Fn button.
- If focus is locked, then the AF lock icon (A) will be displayed.
- If exposure is locked, then the AE lock icon (B) will be displayed.

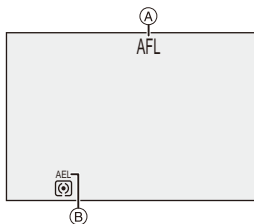

3 Hold the Fn button to decide on the composition and then perform recording.

- Press the shutter button fully.



- Program Shift can be set even when AE is locked.



- You can maintain lock even without pressing and holding the Fn button:
[⚙️] → [AF] → [AF/AE Lock Hold] (→ 421)

ISO Sensitivity

iA P A S M 





You can set light sensitivity (ISO sensitivity).

With the default settings, you can set 100 to 51200 in 1/3 EV increments.

This camera supports Dual Native ISO which enables recording at high sensitivity with reduced noise by switching the base sensitivity.

The base sensitivity can also be fixed as necessary.

- 1** Press [ISO].
- 2** Select ISO sensitivity.
 - Rotate , , or .
 - Selection is also possible by pressing [ISO].

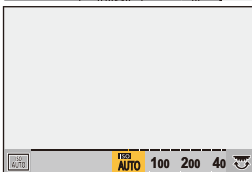
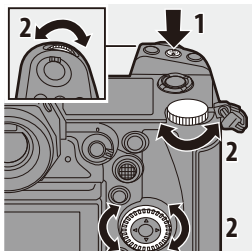

- 3** Confirm your selection.
 - Press the shutter button halfway.

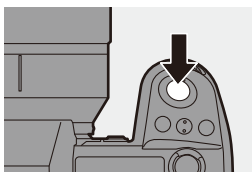

**Characteristics of the ISO Sensitivity**

By increasing the ISO sensitivity, the shutter speed can be increased in dark places to prevent camera shake and subject blur. However, higher ISO sensitivities also increase the amount of noise in the recorded images.

❖ Setting Items (ISO Sensitivity)

[AUTO]	<p>The ISO sensitivity is automatically adjusted according to the brightness.</p> <ul style="list-style-type: none"> • Taking picture: Maximum [6400]*¹ • Video recording: Maximum [6400]*²
[100] to [51200]	<p>The ISO sensitivity is fixed at the selected value.</p> <ul style="list-style-type: none"> • The available ISO sensitivity range changes according to the setting of [Dual Native ISO Setting] in the [Photo] ([Image Quality]) menu (→ 203). • You can extend the ISO sensitivity range in between a lower limit of [50] and an upper limit of [204800] by setting [Extended ISO] (→ 419) to [ON] in the [Custom] ([Image Quality]) menu.

*1 Default setting. The upper limit can be changed with [ISO Sensitivity (photo)].

*2 Default setting. The upper limit can be changed with [ISO Sensitivity (video)].

- When the following functions are being used, the ISO sensitivity that can be set is restricted.
 - [High Resolution Mode]: Up to an upper limit of [3200]
 - [High Dynamic] ([Filter Settings]): Down to a lower limit of [400], up to an upper limit of [6400]
 - Other than [High Dynamic] ([Filter Settings]): Up to an upper limit of [6400]
 - [Multiple Exposure]: Down to a lower limit of [100], up to an upper limit of [6400]
 - [Cinelike D2]/[Cinelike V2] ([Photo Style]): Down to a lower limit of [200]
(The lower limit changes to [100] when [Extended ISO] is set.)
 - [Like709] ([Photo Style]): Down to a lower limit of [100]
 - [V-Log] ([Photo Style]): Down to a lower limit of [640], up to an upper limit of [51200]
(The lower limit changes to [320] when [Extended ISO] is set.)
 - [Standard(HLG)]/[Monochrome(HLG)]/[Like2100(HLG)] ([Photo Style]): Down to a lower limit of [400]



- You can set upper and lower limits for ISO Auto:
 - [📷] ⇒ [📷] ⇒ [ISO Sensitivity (photo)] (→ [398](#))
 - [👤] ⇒ [📷] ⇒ [ISO Sensitivity (video)] (→ [282](#))
- You can change the intervals between ISO sensitivity settings values:
[⚙️] ⇒ [📷] ⇒ [ISO Increments] (→ [418](#))
- The setting range of ISO sensitivity can be extended:
[⚙️] ⇒ [📷] ⇒ [Extended ISO] (→ [419](#))
- You can set the lower limit for shutter speed for ISO Auto:
[📷] ⇒ [📷] ⇒ [Min. Shutter Speed] (→ [398](#))
- You can change the operation of the [ISO] button:
[⚙️] ⇒ [🌅] ⇒ [WB/ISO/Expo. Button] (→ [427](#))
- You can set the upper limit for ISO Auto on the ISO sensitivity settings screen:
[⚙️] ⇒ [🌅] ⇒ [ISO Displayed Setting] (→ [427](#))
- You can change the units for sensitivity to dB when recording video:
[👤] ⇒ [📷] ⇒ [SS/Gain Operation] (→ [286](#))

[Dual Native ISO Setting]

You can set whether to switch the base sensitivity automatically or to fix it.

 →  →  → Select [Dual Native ISO Setting]

[AUTO]	The base sensitivity is automatically switched according to the brightness.	
	ISO sensitivity that can be set	[AUTO] / [100] to [51200]. When [Extended ISO] is set: [AUTO] / [50] to [204800].
[LOW]	Sets the base sensitivity for low sensitivity.	
	ISO sensitivity that can be set	[AUTO] / [100] to [800]. When [Extended ISO] is set: [AUTO] / [50] to [800].
[HIGH]	Sets the base sensitivity for high sensitivity.	
	ISO sensitivity that can be set	[AUTO] / [640] to [51200]. When [Extended ISO] is set: [AUTO] / [320] to [204800].



- [Dual Native ISO Setting] is fixed to [AUTO] in the following cases:
 - When [Photo Style] is set to [V-Log] and [High Resolution Mode] is set

8. White Balance/Image Quality

White Balance (WB)

iA P A S M 





White balance (WB) is a function that corrects the color cast produced by the light illuminating the subject.

It corrects the colors so that white objects appear in white to make the overall color closer to what is seen by the eye.

Normally, you can use auto ([AWB], [AWBc] or [AWBw]) to obtain the optimal white balance.

Set this function when the coloring of the image is different from what you expected, or you want to change the coloring to capture the ambience.

- 1 Press [WB].
- 2 Select the white balance.
 - Rotate ,  or .
 - Selection is also possible by pressing [WB].

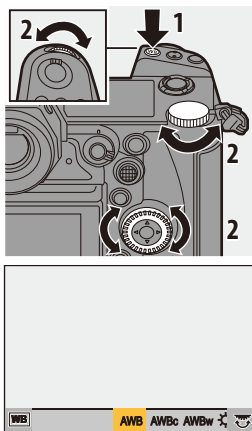

3 Confirm your selection.

- Press the shutter button halfway.

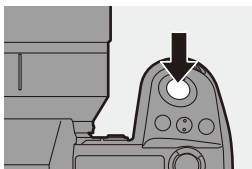

❖ Setting Items (White Balance)

[AWB]	Auto
[AWBc]	Auto (Reduces the reddish hue under an incandescent light source)
[AWBw]	Auto (Leaves the reddish hue under an incandescent light source)
[☀]	Clear sky
[☁]	Cloudy sky
[🏠]	Shade under a clear sky
[💡]	Incandescent light
[📷WB]*	Flash
[1] to [4]	Set mode 1 to 4 (→ 207)
[K1] to [K4]	Color temperatures 1 to 4 (→ 207)

- * It operates as [AWB] during video recording or when recording with [6K/4K PHOTO] or [Post-Focus].

8. White Balance/Image Quality

1 [AWB] will work within this range.

- 2 Blue sky
- 3 Cloudy sky (Rain)
- 4 Shade
- 5 Sunlight
- 6 White fluorescent light
- 7 Incandescent light bulb
- 8 Sunrise and sunset
- 9 Candlelight

K=Kelvin Color Temperature

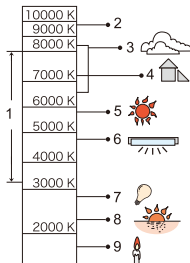





- Under lighting such as fluorescent or LED lighting, the appropriate white balance will vary depending on the lighting type.

Use [AWB], [AWBc], [AWBw] or [] to [].

















- The white balance is fixed to [AWB] while [Filter Settings] is being used.



- The white balance setting items can be registered to Fn buttons:
[] ⇒ [] ⇒ [Fn Button Set] ⇒ [Setting in REC mode] ⇒ [White Balance] (→ 367)
- You can change the operation of the [WB] button:
[] ⇒ [] ⇒ [WB/ISO/Expo. Button] (→ 427)

❖ Registering the White Set ([, ,

Take pictures of a white object under the light source of the recording location to adjust the white balance until it appears white.

- ❶ Press [WB] and then select any value from [, , , , , , , , , , , , , , , <

Adjusting the White Balance

You can adjust the coloring even when the coloring you want to apply is not produced by the selected white balance.

1 Press [WB].

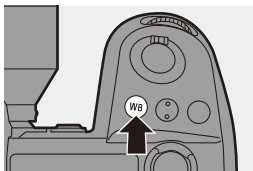





2 Select the white balance and then press ▼.

- The adjustment screen is displayed.

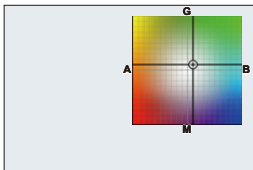
3 Adjust the coloring.

- ◀: [A] (AMBER: ORANGE)
- ▲: [G] (GREEN: GREENISH)
- ▶: [B] (BLUE: BLUISH)
- ▼: [M] (MAGENTA: REDDISH)



- You can also make adjustments in diagonal directions by using the joystick.
 - You can also touch the graph to make adjustments.
 - Press [DISP.] to return to the unadjusted state.
 - You can set the White Balance Bracket by rotating ,  or .
- (→ 165)

4 Confirm your selection.

- Press the shutter button halfway.

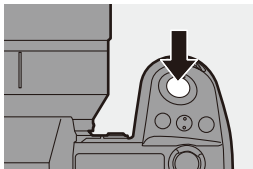

- When the white balance is adjusted, the color of its recording screen icon changes to the adjusted color.
Adjusting toward the [G] side will display [+], while adjusting toward the [M] side will display [-].

[Photo Style]











iA P A S M 







You can select the finishing settings of images to suit your subjects and expression styles.

The image quality can be adjusted for each Photo Style.

 → [] → [] → Select [Photo Style]



 STD. [Standard]	The standard setting.
 VIVID [Vivid]	A setting that produces a more vivid quality with higher saturation and contrast.
 NAT [Natural]	A setting that produces a softer quality with lower contrast.
 FLAT [Flat]	A setting that produces a flatter image quality with lower saturation and contrast.
 LAND [Landscape]	A setting suited for sceneries with vivid blue skies and greens.
 PORT [Portrait]	A setting suited for portraits with a healthy and beautiful skin tone.
 MONO [Monochrome]	A monochrome setting with no color shades.
 L.MONO [L.Monochrome]	A black-and-white setting with rich gradation and crisp black accents.
 L.MONO D [L.Monochrome D]	A monochrome setting that creates a dynamic impression with enhanced highlights and shadows.
 CINED2 [Cinelike D2]	A setting that creates a film-like finishing touch using a gamma curve and gives priority to the dynamic range. <ul style="list-style-type: none"> • This function is suitable for video editing processes.
 CINEV2 [Cinelike V2]	A setting that creates a film-like finishing touch using a gamma curve that gives priority to the contrast.

 [Like709]	<p>A setting that minimizes overexposure by applying a gamma curve correction equivalent to Rec.709 to perform compression (knee adjustment) of high-luminance areas.</p> <ul style="list-style-type: none"> Rec.709 is an abbreviation of "ITU-R Recommendation BT.709", a standard for high-definition broadcasting.
 [V-Log]	<p>Gamma curve setting intended for post-production processing.</p> <ul style="list-style-type: none"> It allows you to add rich gradation to images during post production editing.
 [Like2100(HLG)]*1	<p>A setting used to record HLG format video.</p>
 [MY PHOTO STYLE 1]*2 to [MY PHOTO STYLE 10]*2	<p>Adjusts the image quality of Photo Style items to your preferred settings and registers these as My Photo Style items. (→ 215)</p>

*1 Can only be selected when in the [M] mode and set to a 10-bit [Rec Quality]. (→ 255)

*2 Effects up to [MY PHOTO STYLE 4] are displayed with the default settings. You can set the items to display in the menu with [Show/Hide Photo Style] in [Photo Style Settings]. (→ 418)





• When [HLG Photo] is set, the items will be as follows.

 [Standard(HLG)]	<p>Standard [HLG Photo] setting.</p>
 [Monochrome(HLG)]	<p>Black and white setting for [HLG Photo].</p>





- In [iA] mode, operation differs from that in other recording modes.
 - [Standard] or [Monochrome] can be set.
 - The setting will be reset to [Standard] when the camera is switched to another recording mode or it is turned off.
 - Image quality cannot be adjusted.
- The range of available ISO sensitivities is different when [Photo Style] is set to the following:
 - [Cinelike D2], [Cinelike V2]: Down to a lower limit of [200]
(The lower limit changes to [100] when [Extended ISO] is set.)The range of available ISO sensitivities is also different for [LOW] and [HIGH] in [Dual Native ISO Setting].
Reset the exposure if necessary when ISO sensitivity changes.
- You can set the knee mode with [Like709].
For details, refer to page [280](#).
- When [Filter Settings] is being used, [Photo Style] is not available.







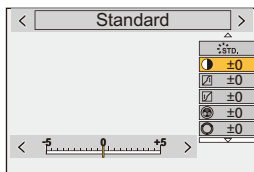

- You can register functions to Fn buttons:
[] ⇒ [] ⇒ [Fn Button Set] ⇒ [Setting in REC mode] ⇒ [Photo Style]
(→ [367](#))
- You can make detailed Photo Style settings:
[] ⇒ [] ⇒ [Photo Style Settings] (→ [418](#))









❖ Adjusting Image Quality



- 1 Press ◀▶ to select the type of Photo Style.
- 2 Press ▲▼ to select an item and then press ◀▶ to adjust.
 - Adjusted items are indicated with [*].
- 3 Press  or .
 - When the image quality is adjusted, the Photo Style icon on the recording screen is indicated with [*].



Settings Items (Image Quality Adjustment)

	[Contrast]*¹	Adjusts the contrast in the image.
	[Highlight]*¹	Adjusts the brightness of bright areas.
	[Shadow]*¹	Adjusts the brightness of dark areas.
	[Saturation]*²	Adjusts the vividness of colors.
	[Color Tone]*³	Adjusts blue and yellow tints.
	[Hue]*²	Assuming that the reference point is red, this rotates the hue toward violet/magenta or yellow/green to adjust the coloring of the entire image.
	[Yellow]	Enhances the contrast. (Effect: weak) Records the sky with a clear blue.
	[Orange]	Enhances the contrast. (Effect: medium) Records the sky with a darker blue.
	[Red]	Enhances the contrast. (Effect: strong) Records the sky with a much darker blue.
	[Green]	Skin and lips of people appear in natural tones. Green leaves appear brighter and more enhanced.
	[Off]	—

	[Grain Effect]*⁴	[Low]/ [Standard]/ [High]	Sets the grain effect level.
		[Off]	—
	[Sharpness]	Adjusts the outlines in the image.	
	[Noise Reduction]	Adjusts the noise reduction effect. • Increasing the effect may cause a slight drop in picture resolution.	
	[Dual Native ISO Setting]*⁵	Sets the Dual Native ISO. (→ 203)	
	[Sensitivity]*⁵	Sets the ISO sensitivity. (→ 200)	
	[White Balance]*⁵	Sets the white balance. (→ 204) • While [WB] is selected, press [] to display the white balance setting screen. Press [] again to return to the original screen.	

- *1 Cannot be adjusted when [Like709], [V-Log], [Standard(HLG)], [Monochrome(HLG)] or [Like2100(HLG)] is selected.
- *2 Available when anything other than [Monochrome], [L.Monochrome], [L.Monochrome D], [V-Log] or [Monochrome(HLG)] is selected.
- *3 Available when [Monochrome], [L.Monochrome], [L.Monochrome D] or [Monochrome(HLG)] is selected.
- *4 Available when [Monochrome], [L.Monochrome] or [L.Monochrome D] is selected.
- *5 Available when the following is set while [MY PHOTO STYLE 1] to [MY PHOTO STYLE 10] are selected:
[] → [] → [Photo Style Settings] → [My Photo Style Settings] → [Add Effects] → [Sensitivity]/[White Balance] → [ON]







- The effects of [Grain Effect] cannot be checked on the recording screen.
- [Grain Effect] is not available when using the following functions:
– Video recording/[6K/4K PHOTO]/[Post-Focus]

❖ Registering Settings in My Photo Style

iA P A S M 



- 1 Press ◀▶ to select the type of Photo Style.
- 2 Adjust the image quality.
 - My Photo Style displays the types of Photo Style at the top of image quality adjustment.
Select the base Photo Style.
- 3 Press [DISP.].
- 4 (When [MY PHOTO STYLE 1] to [MY PHOTO STYLE 10] is selected)
Press ▲▼ to select [Save Current Setting] and then press  or  .
- 5 Press ▲▼ to select the registration destination number and then press  or  .
 - A confirmation screen will be displayed.
On the confirmation screen, press [DISP.] to change the My Photo Style name.
Up to 22 characters may be entered. Double-byte characters are treated as 2 characters.
For information on how to enter characters, refer to page [464](#).



- My Photo Style cannot be registered when using [HLG Photo].

❖ Changing the Registered Contents of My Photo Style

- 1 Select any value from [MY PHOTO STYLE 1] to [MY PHOTO STYLE 10].
- 2 Press [DISP.] and then set the item.

[Load Preset Setting]

[Save Current Setting]

[Edit Title]

[Restore to Default]

[Filter Settings]

iA P A S M



This mode records with additional image effects (filters).

You can adjust the effect for each filter.

In addition, you can simultaneously take pictures without effects.

1 Set the [Filter Effect].

- → [CAMERA] → [FILTER] → [Filter Settings] → [Filter Effect] → [SET]

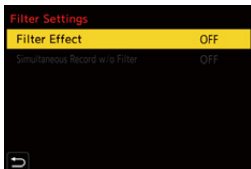

2 Select the filter.

- Press ▲▼ to select, and then press or .
- You can also select the image effect (filter) by touching the sample picture.

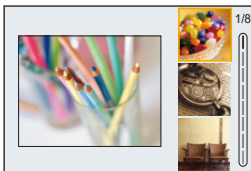



- Press [DISP.] to switch the screen in the order of normal display, guide display, and list display.
The guide display shows the description of each filter.

❖ Adjusting the Filter Effect

You can adjust the filter effect.

- 1 Select the filter.
- 2 On the recording screen, press [WB].
- 3 Rotate , or to set.
 - To return to the recording screen, press [WB] again.
 - When the filter effect is adjusted, the filter icon on the recording screen is indicated with [*].



Filter	Items that can be adjusted
[Expressive]	Vividness
[Retro]	Coloring
[Old Days]	Contrast
[High Key]	Coloring
[Low Key]	Coloring
[Sepia]	Contrast
[Monochrome]	Coloring
[Dynamic Monochrome]	Contrast
[Rough Monochrome]	Grittiness
[Silky Monochrome]	Defocus level
[Impressive Art]	Vividness
[High Dynamic]	Vividness
[Cross Process]	Coloring
[Toy Effect]	Coloring
[Toy Pop]	Area with reduced peripheral brightness
[Bleach Bypass]	Contrast
[Miniature Effect]	Vividness
[Soft Focus]	Defocus level
[Fantasy]	Vividness
[Star Filter]	 : Short rays/Long rays
	 : Few rays/Many rays
	 : Rotate to left/Rotate to right
[One Point Color]	Amount of color left
[Sunshine]	Coloring

❖ Setting a Filter with Touch Operation



- The default settings are for the Touch Tab to not be displayed.
Set [Touch Tab] to [ON] in [Touch Settings] in the [Custom] ([Operation]) menu. (→ 425)

1 Touch [].



2 Touch the item to set.



[]: Filter on/off

[EXPS]: Filter









[]: Filter effect adjustment



- White balance will be fixed to [AWB] and the flash will be fixed to [] (Forced Flash Off).
- The upper limit to ISO sensitivity is [6400].
- When [High Dynamic] is set, the lower limit of the ISO sensitivity is fixed to [400] and the higher limit to [6400].
The range of available ISO sensitivities is also different for [LOW] and [HIGH] in [Dual Native ISO Setting].
 - [LOW]: [AUTO] / [400] to [3200] (Base sensitivity: [400])
 - [HIGH]: [AUTO] / [2500] to [6400] (Base sensitivity: [2500])
 Reset the exposure if necessary when ISO sensitivity changes.
- Depending on the filter, the recording screen may seem as if frames are missed.
- [Rough Monochrome]/[Silky Monochrome]/[Soft Focus]/[Star Filter]/[Sunshine] are not available when using the following function:
 - [] mode
- When using Super 35 mm/APS-C lenses, [Toy Effect]/[Toy Pop] are not available.
- When [Image Area of Video] is [S35mm] or [PIXEL/PIXEL], recording video with [Toy Effect]/[Toy Pop] is not possible.
- [Filter Effect] is not available when using the following functions:
 - [High Resolution Mode]
 - [Multiple Exposure]

- ➔ • Filter on/off operations can be registered to a Fn button:
 [] ➔ [] ➔ [Fn Button Set] ➔ [Setting in REC mode] ➔ [Filter Effect]
 (➔ 367)
- When displaying the [Filter Effect] setting screen using the Fn button, pressing [DISP.] displays the filter selection screen.

❖ Setting the Type of Defocus ([Miniature Effect])



- ❶ Set [Filter Effect] to [Miniature Effect].
- ❷ Press ▲ to display the setting screen.
 - The setting screen can also be displayed by touching [] then [].
- ❸ Press ▲▼ or ◀▶ to move the in-focus portion.
 - You can also move the in-focus portion by touching the screen.
 - You can also switch the defocus orientation by touching [].
- ❹ Rotate  ,  or  to change the size of in-focus portion.
 - The portion can also be enlarged/reduced by pinching out/pinching in the screen.
 - To reset the in-focus portion setting to the default, press [DISP.].
- ❺ Press  or  to set.



-  • No audio is recorded in videos.
- When the system frequency is set to [59.94Hz (NTSC)], the length of the video recorded will be approx. 1/10 of the actual recording time. The displayed video recording time will be approx. 10 times longer than the recording time displayed during normal video recording.
 When the system frequency is set to [50.00Hz (PAL)] or [24.00Hz (CINEMA)], the length of the video recorded will be approx. 1/8 of the actual recording time. The displayed video recording time will be approx. 8 times longer than the recording time displayed during normal video recording.
- If you end video recording after a short time, the camera may go on recording for a certain period.

❖ Setting the Color to Be Left ([One Point Color])

- 1 Set [Filter Effect] to [One Point Color].
- 2 Press ▲ to display the setting screen.

- The setting screen can also be displayed by touching [] then [].

- 3 Press ▲▼◀▶ to move the frame and select the color you want to leave.

- Positions can be moved to the diagonal directions using the joystick.
- You can also select the color you want to leave by touching the screen.
- To return the frame back to the center, press [DISP.].



- 4 Press  or  to set.

❖ Setting the Light Source Position and Size ([Sunshine])



- 1 Set [Filter Effect] to [Sunshine].
- 2 Press ▲ to display the setting screen.

- The setting screen can also be displayed by touching [] then [].

- 3 Press ▲▼◀▶ to move the center position of the light source.

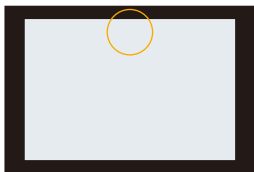
- Positions can be moved to the diagonal directions using the joystick.
- The position of the light source can also be moved by touching the screen.



- 4 Rotate  ,  or  to adjust the size of the light source.

- This can also be enlarged/reduced by pinching out/pinching in the screen.
- To reset the light source setting to the default, press [DISP.].

- 5 Press  or  .

[Simultaneous Record w/o Filter]



You can simultaneously take pictures with no added filter effects.

→ [] → [] → [Filter Settings] → Select [Simultaneous Record w/o Filter]

Settings: [ON]/[OFF]



- [Simultaneous Record w/o Filter] is not available when using the following functions:
 - Burst recording
 - [6K/4K PHOTO]/[Post-Focus]
 - [Time Lapse Shot]
 - [Stop Motion Animation]
 - [RAW+FINE]/[RAW+STD.]/[RAW] ([Picture Quality])
 - [Bracketing]

[High Resolution Mode]

iA P A S M



This merges pictures with a high resolution from multiple recorded images. This function is suitable for recording subjects that do not move.

Merged pictures will be saved as RAW files with a maximum image size of 96 M.



- Use a tripod to minimize camera shake.
- The image stabilization function is automatically turned off.

1 Set [High Resolution Mode].

- → [] → [] → [High Resolution Mode]



2 Start High Resolution mode.

- Select [Start] and then press or .

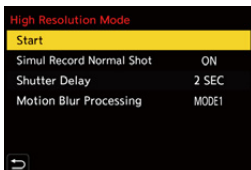

3 Decide on the composition and then fix the camera in place.

- If blurring is detected, the High Resolution mode icon (A) blinks.



4 Start recording.

- Press the shutter button fully.
- With the default settings, [Shutter Delay] is activated, so there will be a gap in time from when the shutter button is pressed until the shutter is released.
- The screen goes dark during recording.
- The recording state indication (red) (B) blinks.
- Do not move the camera while it is blinking.
- You can continue recording when the merging process ends.



5 End [High Resolution Mode].

- Press [Q].

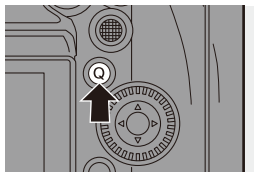

❖ Setting Items ([High Resolution Mode])

[Start]	Starts High Resolution mode.
[Simul Record Normal Shot]	Simultaneously takes pictures that are not merged when [ON] is set. The first picture will be saved with [Picture Size] set to [L].
[Shutter Delay]	Sets the delay time from when the shutter button is pressed until the shutter is released.
[Motion Blur Processing]	Sets the correction method to use when the subject moved. [MODE1]: This gives priority to High Resolution mode, therefore subject blur appears as an afterimage in the picture. [MODE2]: This reduces afterimage from subject blur, but cannot obtain the same High Resolution mode effect in the corrected range.

❖ Picture Quality/Image Size After Merging



- The recording [Picture Quality] will be [RAW].
- RAW images recorded in [High Resolution Mode] cannot be processed from [RAW Processing] in the [Playback] menu. Use the "SILKYPIX Developer Studio" software. (→ 531)
- The image size will vary depending on the [Aspect Ratio] setting.

[Aspect Ratio]	Picture size
[4:3]	10656×8000 (85 M)
[3:2]	12000×8000 (96 M)
[16:9]	12000×6736 (81 M)
[1:1]	8000×8000 (64 M)



- In [High Resolution Mode], recording will be performed using the following settings:
 - [Shutter Type]: Fixed to [ELEC.]
 - Minimum aperture value: F16
 - Shutter speed: 1 second to 1/8000 of a second
 - ISO sensitivity: Up to [3200]
 - When the focus mode is set to [AFC], it switches to [AFS].
- When you record in an extremely bright location or under lighting such as fluorescent or LED lighting, the coloring or brightness of the image may change or horizontal stripes may appear on the screen. Lowering the shutter speed may reduce the effect of horizontal stripes.
- The image produced by combining is displayed when Auto Review.
- The edges of images cannot be displayed enlarged when the camera is used for playback.
- Devices other than this camera may not be able to play back images recorded using [High Resolution Mode].
- When the following functions are being used, [High Resolution Mode] is not available:
 - [Time Lapse Shot]
 - [Stop Motion Animation]
 - [Filter Settings]
 - [Multiple Exposure]
- When using Super 35 mm/APS-C lenses, recording in [High Resolution Mode] is not possible.



- You can register functions to Fn buttons:
[] ⇒ [] ⇒ [Fn Button Set] ⇒ [Setting in REC mode] ⇒ [High Resolution Mode] (→ [367](#))

[HLG Photo]

iA P A S M 





Records an HLG format picture with a wide dynamic range. Bright lights that are easily overexposed, and dark areas that are easily underexposed can be recorded showing fine quality and rich colors just as seen with the human eyes.

Recorded pictures can be output over HDMI to devices (TV, etc.) that support HLG format pictures for viewing.

Additionally, devices that support the HSP format can directly play back images.

- “HLG (Hybrid Log Gamma)” is an international standard (ITU-R BT.2100) HDR format.
- “HSP” is an HDR picture format using HLG format video technology. These images are saved with a “.HSP” file extension.

 →  →  → Select [HLG Photo]

Setting items	[Aspect Ratio]			
	[4:3]	[3:2]	[16:9]	[1:1]
[Full-Res.]	5312×3984	5984×4000	5888×3312	4000×4000
[4K-Res.]	2880×2160	3232×2160	3840×2160	2144×2144
[OFF]	—			

- [Aspect Ratio] settings of [65:24] and [2:1] cannot be selected.
- [Photo Style] can be selected from [Standard(HLG)] or [Monochrome(HLG)]. (→ 210)
- JPEG images and RAW images are recorded simultaneously in accordance with [Picture Quality] (→ 90) and [Picture Size] (→ 88).
RAW images recorded with [HLG Photo] can be saved in the HLG format by using [RAW Processing]. (→ 359)

❖ ISO Sensitivity When [HLG Photo] Is Set

The lower limit of available ISO sensitivities will become [400].

- The range of available ISO sensitivities is also different for [LOW] and [HIGH] in [Dual Native ISO Setting].
- Reset the exposure if necessary when ISO sensitivity changes.





- The monitor and viewfinder on this camera do not support display of HLG format images.
In the [Custom] ([Monitor / Display (Video)]) menu, you can display the images converted for monitoring on the monitor/viewfinder of this camera with [Monitor] in [HLG View Assist]. (→ 314)



- HLG images appear darker on devices that do not support the HLG format.
With [HDMI] in [HLG View Assist] in the [Custom] ([Monitor / Display (Video)]) menu, you can set the conversion method for images displayed for monitoring. (→ 314)
- When using Super 35 mm/APS-C lenses, [Full-Res.] cannot be used.
- When the following functions are being used, [HLG Photo] is not available:
 - [6K/4K PHOTO]/[Post-Focus]
 - [High Resolution Mode]
 - [Filter Settings]
 - [Multiple Exposure]



- You can register functions to Fn buttons:
[] ⇒ [] ⇒ [Fn Button Set] ⇒ [Setting in REC mode] ⇒ [HLG Photo]
(→ 367)

9. Flash

Using an External Flash (Optional)

iA P A S M 



If you attach the Flash (DMW-FL580L/DMW-FL360L/DMW-FL200L: optional) to the hot shoe, you can record using the flash.

You can also use a commercially available external flash by connecting a synchro cable to the flash synchro socket.

Furthermore, by attaching an external flash that supports wireless flash recording, you can wirelessly control an external flash that is in a position separate from the camera.



- Remove the lens hood to prevent vignetting.
- Flash recording is not possible when the following functions are being used:
 - [6K/4K PHOTO]/[Post-Focus]
 - [ELEC.]/[Silent Mode]/[High Resolution Mode]
 - [Filter Settings]

Removing the Hot Shoe Cover

Before attaching the Flash (optional), remove the hot shoe cover.

Refer to the operating instructions for the Flash for details about how to attach it.

Remove the hot shoe cover by pulling it in the direction indicated by arrow ② while pressing it in the direction indicated by arrow ①.

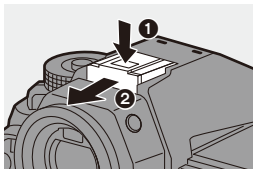

❖ Connecting a Synchro Cable to the Flash Synchro Socket

You can use a commercially available external flash by connecting a synchro cable to the flash synchro socket.



- Use an external flash with a synchronization voltage of 250 V or less.
- Do not use the synchro cables with the length of 3 m (9.8 feet) or more.

1 Rotate the flash synchro socket cap in the direction of the arrow to remove.

- Be careful not to lose the flash synchro socket cap.

2 Connect the synchro cable to the flash synchro socket.

- The socket has a lock screw to prevent the cable from falling off.
- For the connection, refer to the operating instructions for the synchro cable.

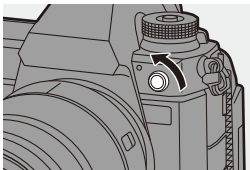

- The flash synchro socket has no polarity. You can use a synchro cable regardless of its polarity.
- In the [P/M] mode, the flash synchro socket is used to synchronize time codes with an external device. (→ 270) Do not connect an external flash to the flash synchro socket when set to the [P/M] mode. Doing so may cause a malfunction in the camera.

❖ Notes on Flash Recording



- Do not bring any object near the flash. Heat or light may cause the object to deform or discolor.
- If you record repeatedly, time may be needed to charge the flash. While the flash is charging, images will be recorded without the flash firing.
- When an external flash is attached, do not carry the camera by holding only the external flash. It may become detached.
- When using a commercially available external flash, do not use one with reversed polarity or function for communicating with a camera. It may cause the camera to malfunction, or it may not operate correctly.
- Refer to the operating instructions for the external flash for details.

Setting Flash

iA P A S M M



You can set the flash function to control flash firing from the camera.

[Flash Mode]





Sets the flash mode.

MENU/SET → [📷] → [⚡] → **Select [Flash Mode]**





[⚡]	(Forced Flash On)	The flash fires every time regardless of the recording conditions.
[⚡👁]	(Forced On/Red-Eye)	This is suitable for recording when there is backlighting or under lighting such as fluorescent lighting.
[⚡S]	(Slow Sync.)	When recording images against a nightscape, this will slow the shutter speed when the flash fires to make not only the subject but also the nightscape appear brighter.
[⚡S👁]	(Slow Sync./Red-Eye)	<ul style="list-style-type: none"> Slower shutter speeds may result in blurry images. To avoid this, we recommend using a tripod.
[☺]	(Forced Flash Off)	The flash does not fire.



- The flash fires twice.
The interval between the first and second firings is longer when [] or [] is set. The subject should not move until the second firing has finished.
- [] and [] cannot be used when the following are set:
 - [Firing Mode]: [MANUAL]
 - [Flash Synchro]: [2ND]
 - [Wireless]: [ON]
- Some flash modes may not be available depending on the settings on the external flash.
- The effectiveness of red-eye reduction varies from person to person.
The effect, which is influenced by factors such as distance to the subject and whether the subject is looking at the camera when the preliminary flash is fired, may not be very noticeable in some cases.







- You can register functions to Fn buttons:
[] → [] → [Fn Button Set] → [Setting in REC mode] → [Flash Mode]
(→ 367)



❖ Available Flash Settings by Recording Mode

The available flash settings depend on the recording mode.

(✓: Available, —: Not available)

Recording mode	[]	[]	[]	[]	[]
[P]/[A]	✓	✓	✓	✓	✓
[S]/[M]	✓	✓	—	—	✓



- [] and [] can be set in [iA] mode. In [], the flash mode switches to one suited to the recording situation.

❖ Shutter Speeds for Flash Modes

[Flash Mode]	Shutter speed (sec.)
[⚡]	1/60* ¹ to 1/320* ²
[⚡Ⓞ]	
[⚡S]	1 to 1/250
[⚡SⓄ]	

*1 In [S] mode, this will be 60 seconds and in [M] mode it will be [B] (Bulb).

*2 The maximum setting changes to 1/250 of a second in [P]/[A] modes.

- The guide number decreases when the shutter speed is set to 1/320 of a second.

[Red-Eye Removal]

When [Flash Mode] is set to [⚡Ⓞ] or [⚡SⓄ], the camera automatically detects red-eye and corrects image data.



➔ [📷] ➔ [⚡] ➔ **Select [Red-Eye Removal]**

Settings: [ON]/[OFF]



- When [ON] is set, [🔪] is displayed on the flash icon.
- Red-eye cannot be corrected depending on its appearance.
- When [HLG Photo] is being used, [Red-Eye Removal] is not available.

[Firing Mode]/[Manual Flash Adjust.]

You can select whether to set the flash output automatically or manually.

- Firing mode cannot be set when using a Flash (DMW-FL580L/DMW-FL360L/DMW-FL200L: optional). It can be set only when using an external flash that does not use a battery (supplied with some models of Panasonic digital cameras).

1 Set the [Firing Mode].

-  →  →  → [Firing Mode]



[TTL]	Sets flash output to be set automatically by the camera.
[MANUAL]	<p>Sets the flash output manually.</p> <ul style="list-style-type: none"> • With [TTL], you can record the images you want even when recording dark scenes where the flash output tends to become greater. • The flash output ([1/1], etc.) is displayed on the flash icon of the recording screen.

2 (When set to [MANUAL]) Select [Manual Flash Adjust.] and then press or .



3 Press ◀▶ to set the flash output and then press or



- It can be set within the range of [1/1] (full flash output) to [1/64] in 1/3 steps.

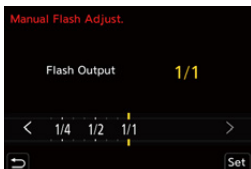

[Flash Adjust.]

You can adjust the flash output when taking pictures with the flash in TTL output mode.

1 Select [Flash Adjust.].

-  → [] → [] → [Flash Adjust.]



2 Press ◀▶ to adjust the flash output and then press or



- It can be adjusted within the range of [-3 EV] to [+3 EV] in 1/3 EV steps.

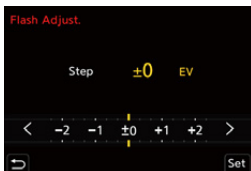



- [⚡] is displayed on the recording screen.
- For information about adjusting the flash output when recording using a wireless flash, refer to page 240.
- [Flash Adjust.] cannot be used when the following are set:
 - [Firing Mode]: [MANUAL]
 - [Wireless]: [ON]



- You can register functions to Fn buttons:
 [⚙️] → [🌅] → [Fn Button Set] → [Setting in REC mode] → [Flash Adjust.]
 (→ 367)



[Flash Synchro]

When a moving subject is recorded at night using a slow shutter and flash, a trail of light may appear in front of the subject.

If you set [Flash Synchro] to [2ND], you can take a dynamic picture with a trail of light appearing behind the subject by firing the flash immediately before the shutter closes.

→ [📷] → [⚡] → **Select [Flash Synchro]**



[1ST]	This is the normal method for recording with the Flash.	
[2ND]	The light source appears behind the subject and the picture becomes dynamic.	



- When [2ND] is set, [2nd] is displayed on the flash icon of the recording screen.
- When [Wireless] is set to [ON], this is fixed to [1ST].
- The effect may not be adequately achieved at faster shutter speeds.

[Auto Exposure Comp.]

Automatically adjust the flash output in conjunction with the exposure compensation value. (→ 197)



→ [📷] → [⚡] → **Select [Auto Exposure Comp.]**

Settings: [ON]/[OFF]

Recording Using a Wireless Flash

iA P A S M



You can use a Flash (DMW-FL580L/DMW-FL360L/DMW-FL200L: optional) to record using a wireless flash.

You can separately control the firing of three flash groups and the flash attached to the hot shoe of the camera.

❖ Placing a Wireless Flash

Place the wireless flash with its wireless sensor facing the camera.

Placement example

When C is placed to erase the shadow in the background of the subject that the flash groups A and B will create

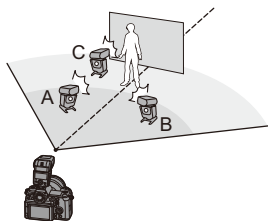

Placement range

When DMW-FL360L is attached

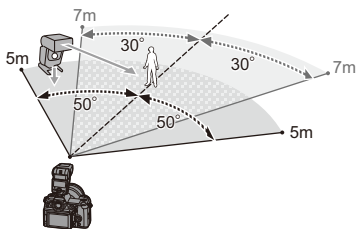

- The placement range serves as a guide for when recording with the camera held horizontally. The range differs depending on the surrounding environment.
- We recommend using a maximum of three wireless flashes in each group.
- If the subject is too close, communication light may affect the exposure. You can reduce the effect by setting [Communication Light] to [LOW] or lowering the output with a diffuser or similar device. (→ 241)

- 1** Attach an external flash to the camera. (→ 228)

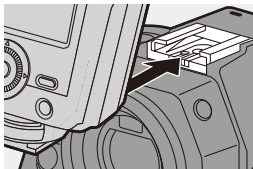

- 2** Set the wireless flashes to [RC] mode and then place them.

- Set the channel and group for the wireless flashes.

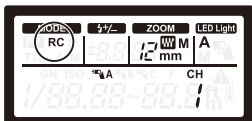

- 3** Enable the wireless flash function of the camera.

- MENU/SET → [CAMERA] → [FLASH] → [Wireless] → [ON]



- 4** Set [Wireless Channel].

- Select the same channel as on the wireless flash side.



- 5** Set [Wireless Setup].

- Set the firing mode and flash output.



❖ Setting Items ([Wireless Setup])

- To fire a test flash, press [DISP.].

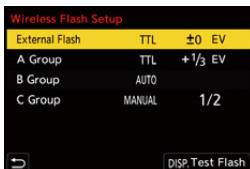



[External Flash]*1	[Firing Mode]	<p>[TTL]: The camera automatically sets the flash output.</p> <p>[AUTO]⁺²: Sets the flash output on the external flash side.</p> <p>[MANUAL]: Sets the flash output of the external flash manually.</p> <p>[OFF]: The external flash outputs only communication light.</p>
	[Flash Adjust.]	Adjusts the flash output of the external flash manually when [Firing Mode] is set to [TTL].
	[Manual Flash Adjust.]	<p>Sets the flash output of the external flash when [Firing Mode] is set to [MANUAL].</p> <ul style="list-style-type: none"> It can be set within the range of [1/1] (full flash output) to [1/128] in 1/3 steps.
[A Group]/ [B Group]/ [C Group]	[Firing Mode]	<p>[TTL]: The camera automatically sets the flash output.</p> <p>[AUTO]⁺¹: Sets the flash output on the wireless flash side.</p> <p>[MANUAL]: Sets the flash output of the wireless flash manually.</p> <p>[OFF]: The wireless flashes of the specified group will not fire.</p>
	[Flash Adjust.]	Adjusts the flash output of the wireless flash manually when [Firing Mode] is set to [TTL].
	[Manual Flash Adjust.]	<p>Sets the flash output of the wireless flash when [Firing Mode] is set to [MANUAL].</p> <ul style="list-style-type: none"> It can be set within the range of [1/1] (full flash output) to [1/128] in 1/3 steps.

*1 This cannot be selected when [Wireless FP] is set.

*2 This cannot be set when using the Flash (DMW-FL200L: optional).



- You can register functions to Fn buttons:

[] → [] → [Fn Button Set] → [Setting in REC mode] → [Wireless Flash Setup] (→ 367)

❖ [Wireless FP]

The external flash performs FP firing (repeated high-speed firing of the flash) during wireless recording, enabling recording using the Flash even at fast shutter speeds.



→ [] → [] → Select [Wireless FP]

Settings: [ON]/[OFF]

❖ [Communication Light]

Set the strength of communication light.



→ [] → [] → Select [Communication Light]

Settings: [HIGH]/[STANDARD]/[LOW]

10. Recording Videos

Recording Videos

iA P A S M 



It is possible to record video with a maximum resolution of 6K (5952×3968) on this camera.

It also supports switching of the system frequency and 3 types of recording file format; AVCHD, MP4, and MOV.

In the [M] mode (Creative Video mode), which is specifically for video recording, you can use all of the video functions.

1 Start recording.

- Press the video rec. button (A).
- You can also perform the same operation by pressing the sub video rec. button (B).
- Release the video rec. button right after you press it.
- During video recording, the front tally lamp (C) and rear tally lamp (D) light.

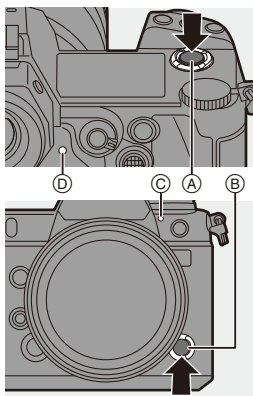

2 Stop recording.

- Press the video rec. button (A) again.
- You can also perform the same operation by pressing the sub video rec. button (B).

❖ Screen Displays While Video Recording

The live view angle of view changes to the angle of view for video recording, and video recording time (E) and elapsed recording time (F) are displayed.

- “h” is an abbreviation for hour, “m” for minute and “s” for second.
- The recording state indication (G) and card access indication (H) turn red while videos are being recorded.

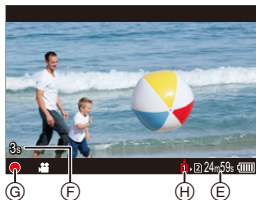

- If maintaining focus on the subject is difficult during video recording with AF, press the shutter button halfway to re-adjust the focus.

❖ Exposure Control While Video Recording

Videos will be recorded using the aperture, shutter speed, ISO sensitivity, and Dual Native ISO settings below.

Recording mode	Aperture value/shutter speed/ISO sensitivity/Dual Native ISO setting
[iA]	The camera automatically makes the settings to suit the scene. (→ 82)
[P]/[A]/[S]/[M]	The settings vary depending on the [Auto Exposure in P/A/S/M] in the [Custom] ([Image Quality]) menu. The default setting is [ON]. (→ 420) [ON]: Records with values set automatically by the camera. [OFF]: Records with manually set values.
[S/M]	Records with manually set values.

❖ Size Interval for Dividing Files

[Rec. File Format]	[Rec Quality]	Size interval for dividing files
[AVCHD]	All	A new file will be created to continue recording if the file size exceeds 4 GB. The files recorded can be played back continuously.
[MP4]	[FHD]	A new file will be created to continue recording if the continuous recording time exceeds 30 minutes or the file size exceeds 4 GB.
	[4K]	When using an SDHC memory card: A new file will be created to continue recording if the continuous recording time exceeds 30 minutes or the file size exceeds 4 GB.
[MOV]	All	When using an SDXC memory card: A new file will be created to continue recording if the continuous recording time exceeds 3 hours and 4 minutes or the file size exceeds 96 GB.



- When the remaining capacity of the battery or card gets low during video recording, the tally lamps blink at long intervals. When there is no remaining capacity in the battery or card, video recording is stopped and the tally lamps blink at short intervals.
- If an operation such as a zoom or button operation is performed during video recording, that operation sound may be recorded.
- The lens operation sound (AF and image stabilizer) may be recorded to video.
- If the operation sound of pressing the video rec. button or sub video rec. button to end recording bothers you, try the following:
 - Record the video about 3 seconds longer, and then divide the last part of the video using [Video Divide] in the [Playback] ([Edit Image]) menu.
 - Use the Shutter Remote Control (DMW-RS2: optional) for recording.
- Depending on the type of card, the card access indication may appear for a while after video recording. This is not a malfunction.
- Even when playback is performed on a supported device, situations may occur where image or sound quality is poor, recording information is not displayed correctly, or playback is not possible, for example. If you experience any of these, play them back on the camera.
- If the camera temperature rises under the any of following conditions, [,] may be displayed and recording may stop. Wait until the camera cools down.
 - During continuous video recording
 - When the ambient temperature is high
- Video recording is not possible while you are using the following functions:
 - [Time Lapse Shot]
 - [Stop Motion Animation]
 - [Rough Monochrome]/[Silky Monochrome]/[Soft Focus]/[Star Filter]/[Sunshine] ([Filter Settings])
 - [HLG Photo]
 - [Post-Focus]



- You can switch the recording screen, status LCD display, and live view angle of view to suit video recording just as with the [M] mode:
[⚙️] ⇒ [📺] ⇒ [Video-Priority Display] (→ 441)
- You can change the tally lamp that turns on. You can change the settings so the tally lamps do not turn on:
[⚙️] ⇒ [📡] ⇒ [Tally Lamp] (→ 442)
- You can display a red frame on the recording screen that indicates that video is being recorded:
[⚙️] ⇒ [📺] ⇒ [Red REC Frame Indicator] (→ 441)

Creative Video Mode



The [Creative Video Mode] mode (Creative Video mode) is a recording mode specifically for video recording in which you can use all video functions.

In the [Creative Video Mode] mode, the recording screen and status LCD switch to displays suited to video recording.

You can start and stop video recording with the shutter button.

Change the exposure and audio settings with touch operation to prevent operation sounds from being recorded.

Settings such as exposure and white balance can be changed independent of picture taking settings.

Displays Suited to Video Recording

❖ Recording Screen

In the recording screen, the following parts switch to displays suited to video recording.

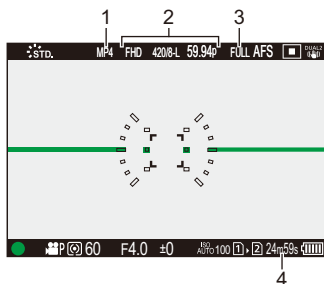

1 Recording file format (→ 255)

2 Recording quality (→ 255)

3 Image area of video (→ 266)

4 Video recording time (→ 583)

- Examples of displays at the time of purchase. For information about the icons other than those described here, refer to page 542.

❖ Status LCD

You can switch the status LCD between 2 types of information display.

- Use the Fn button registered with [Status-LCD Display(Video)] to operate. In default settings, this is registered in the [Fn1] button. For information about the Fn button, refer to page 367.

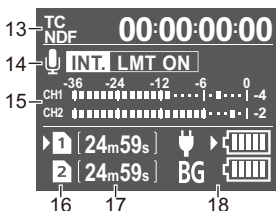
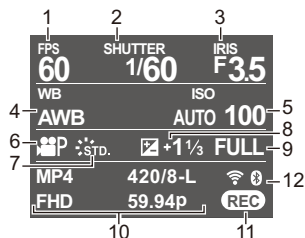
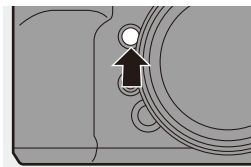

1	Frame rate (→ 255)/ Variable frame rate (→ 297)
2	Shutter speed (→ 61)
3	Aperture value (→ 61)
4	White balance (→ 204)
5	ISO sensitivity (→ 200)/ Dual Native ISO setting (→ 203)
6	Exposure mode (→ 249)
7	Photo Style (→ 210)/ Filter settings (→ 216)
8	Exposure compensation value (→ 197)
9	Image area of video (→ 266)
10	Recording file format (→ 255)/ Recording quality (→ 255)

11	Recording state (→ 242)
12	Wi-Fi/Bluetooth connection state (→ 466)
13	Time code (→ 268)
14	Built-in microphone/External microphone (→ 283, 340)/ XLR microphone adaptor setting (→ 343)/Sound recording level limiter (→ 285)
15	Sound recording level display (→ 283)
16	Card slot (→ 48)/ Double card slot function (→ 92)
17	Video recording time (→ 583)
18	Battery indication (→ 44)/ Power supply (→ 43)

- ➔ • Even in the [iA]/[P]/[A]/[S]/[M] modes, as with the [M] mode, you can switch to the display suited to video recording:
 [⚙️] ➔ [📺] ➔ [Video-Priority Display] (➔ 441)

Recording with Creative Video

1 Set the mode dial to [M].

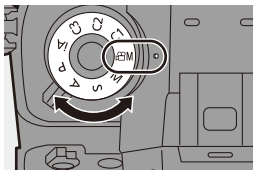

2 Set the exposure mode.

- [MENU/SET] ➔ [👤] ➔ [📐] ➔ [Exposure Mode] ➔ [P]/[A]/[S]/[M]
- You can perform the same exposure operations as the [P]/[A]/[S]/[M] modes.



3 Close the menu.

- Press the shutter button halfway.

4 Start recording.

- Press the shutter button (A), video rec. button (B), or sub video rec. button (C).

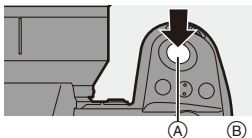

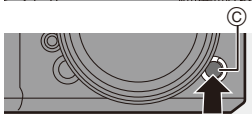

5 Stop recording.

- Press the shutter button, video rec. button, or sub video rec. button again.



- You can register functions to Fn buttons:

[] ⇒ [] ⇒ [Fn Button Set] ⇒ [Setting in REC mode] ⇒ [Exposure Mode] (→ 367)

❖ Operations During Video Recording



Change the exposure and audio settings with touch operation to prevent operation sounds from being recorded.



- With the default settings, the Touch Tab is not displayed.
Set [Touch Tab] to [ON] in [Touch Settings] in the [Custom] ([Operation]) menu. (→ 425)

① Touch [].

② Touch an icon.

F	Aperture value	ISO / GAIN	ISO sensitivity/Gain (dB)
SS	Shutter speed		Sound recording level adjustment
	Exposure compensation		

③ Drag the slide bar to set the item.

[▼]/[▲]: Changes the setting slowly.

[⏏]/[⏏]: Changes the setting quickly.

- If you touch icon , the screen of Step ② is redisplayed.

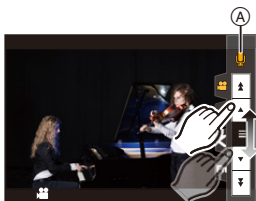

[CreativeVideo Combined Set.]



In default settings, settings such as exposure and white balance changed in [P/M] mode are also reflected in picture recording in [P]/[A]/[S]/[M] modes.

From the [CreativeVideo Combined Set.] menu, you can separate settings for video recording and for picture recording.

→ → → Select [CreativeVideo Combined Set.]

[F/SS/ISO/Exposure Comp.]	<p>:</p> <p>Links recording settings in [P/M] mode and [P]/[A]/[S]/[M] mode.</p> <ul style="list-style-type: none"> • Select to use the same settings in [P/M] mode and [P]/[A]/[S]/[M] mode.
[White Balance]	
[Photo Style]	
[Metering Mode]	<p>:</p> <p>Configures recording settings in [P/M] mode and [P]/[A]/[S]/[M] mode individually.</p> <ul style="list-style-type: none"> • Select to separate [P/M] mode and [P]/[A]/[S]/[M] mode settings.
[AF Mode]	

Recording Video

This section describes the settings used when video recording.

- ➔ In “4. Image Recording”, the functions described work with both pictures and video.
 - Please also refer to that section.
 - [Double Card Slot Function]: ➔ 92
 - [Folder / File Settings]: ➔ 93
 - [File Number Reset]: ➔ 95

[System Frequency]

iA P A S M 



This changes the system frequency of videos that are recorded and played back with the camera.

The default setting is for the system frequency to be set to the TV broadcast system for the region where the camera was bought.

 ➔ [] ➔ [] ➔ Select [System Frequency]

[59.94Hz (NTSC)]	System frequency for regions using the NTSC broadcasting system
[50.00Hz (PAL)]	System frequency for regions using the PAL broadcasting system
[24.00Hz (CINEMA)]	System frequency for producing cinema film



- After changing the setting, turn the camera off and on.
- If you record using a system frequency that differs from the broadcasting system of your region, it may not be possible for you to properly play back videos on your TV.

We recommend using the setting as it was at the time of purchase if you are unsure about broadcasting systems or if you will not be involved in producing cinema film.

- After changing the setting, it is recommended to insert another card and format it with this camera.
 - You cannot record [AVCHD] video with differing system frequencies onto 1 card.
 - When [Rec. File Format] is either [MP4] or [MOV], it is not possible to play back on this camera videos recorded using a system frequency that is different to the [System Frequency] setting.

[Rec. File Format]



iA P A S M 



Sets the recording file format of videos to be recorded.

 →  →  → Select [Rec. File Format]

[AVCHD]	This file format is suitable for playback on high-definition TVs.
[MP4]	This file format is suitable for playback on PCs.
[MOV]	This file format is suitable for image editing.

-  You can register functions to Fn buttons:
 →  → [Fn Button Set] → [Setting in REC mode] → [Motion Pic. Rec Format] (→ [367](#))

[Rec Quality]

iA P A S M 



Sets the image quality of videos to be recorded. The image qualities you can select depend on the [System Frequency] and [Rec. File Format] settings. The [Image Area of Video] you can select differs depending on the [Rec Quality] settings.

[Rec Quality] settings can also be made using [Filtering] (→ [264](#)) to display only items that meet your conditions and [add to list] (→ [265](#)) to register recording qualities you use often.

 →  →  → Select [Rec Quality]

- To record video with a bit rate of 72 Mbps or more, you require a card with the corresponding Speed Class.

For information about the cards that can be used, refer to page [26](#).

❖ [Rec. File Format]: [AVCHD]

- YUV, Bit value, Image compression: 4:2:0, 8-bit, Long GOP
- Audio format: Dolby Audio™ (2ch)

- (A) Recording frame rate
 (B) Bit rate
 (C) Video compression format (AVC: H.264/MPEG-4 AVC)

[System Frequency]: [59.94Hz (NTSC)]

[Rec Quality]	[Image Area of Video]			Resolution	Aspect ratio	(A)	(B) (Mbps)	(C)
	FULL	S35	P/P					
[FHD/28M/60p]*1	✓	✓	✓	1920×1080	16:9	59.94p	28	AVC
[FHD/17M/60i]	✓	✓	✓	1920×1080	16:9	59.94i	17	AVC
[FHD/24M/30p]	✓	✓	✓	1920×1080	16:9	59.94i*2	24	AVC
[FHD/24M/24p]	✓	✓	✓	1920×1080	16:9	23.98p	24	AVC

[System Frequency]: [50.00Hz (PAL)]

[Rec Quality]	[Image Area of Video]			Resolution	Aspect ratio	(A)	(B) (Mbps)	(C)
	FULL	S35	P/P					
[FHD/28M/50p]*1	✓	✓	✓	1920×1080	16:9	50.00p	28	AVC
[FHD/17M/50i]	✓	✓	✓	1920×1080	16:9	50.00i	17	AVC
[FHD/24M/25p]	✓	✓	✓	1920×1080	16:9	50.00i*3	24	AVC

*1 AVCHD Progressive

*2 Sensor output: 29.97 fps

*3 Sensor output: 25.00 fps

❖ [Rec. File Format]: [MP4]

- YUV, Bit value, Image compression:
 - [10bit] recording quality: 4:2:0, 10-bit, Long GOP
 - [8bit] recording quality: 4:2:0, 8-bit, Long GOP
- Audio format: AAC (2ch)

Ⓐ Recording frame rate

Ⓑ Bit rate

Ⓒ Video compression format (**HEVC**: H.265/HEVC, **AVC**: H.264/MPEG-4 AVC)

[System Frequency]: [59.94Hz (NTSC)]								
[Rec Quality]	[Image Area of Video]			Resolution	Aspect ratio	Ⓐ	Ⓑ (Mbps)	Ⓒ
	FULL	S35	P/P					
[4K/10bit/100M/60p]		✓	✓	3840×2160	16:9	59.94p	100	HEVC
[4K/8bit/100M/30p]	✓	✓	✓	3840×2160	16:9	29.97p	100	AVC
[4K/10bit/72M/30p]	✓	✓	✓	3840×2160	16:9	29.97p	72	HEVC
[4K/8bit/100M/24p]	✓	✓	✓	3840×2160	16:9	23.98p	100	AVC
[4K/10bit/72M/24p]	✓	✓	✓	3840×2160	16:9	23.98p	72	HEVC
[FHD/8bit/28M/60p]	✓	✓	✓	1920×1080	16:9	59.94p	28	AVC
[FHD/8bit/24M/24p]	✓	✓	✓	1920×1080	16:9	23.98p	24	AVC
[FHD/8bit/20M/30p]	✓	✓	✓	1920×1080	16:9	29.97p	20	AVC

[System Frequency]: [50.00Hz (PAL)]								
[Rec Quality]	[Image Area of Video]			Resolution	Aspect ratio	Ⓐ	Ⓑ (Mbps)	Ⓒ
	FULL	S35	P/P					
[4K/10bit/100M/50p]		✓	✓	3840×2160	16:9	50.00p	100	HEVC
[4K/8bit/100M/25p]	✓	✓	✓	3840×2160	16:9	25.00p	100	AVC
[4K/10bit/72M/25p]	✓	✓	✓	3840×2160	16:9	25.00p	72	HEVC
[FHD/8bit/28M/50p]	✓	✓	✓	1920×1080	16:9	50.00p	28	AVC
[FHD/8bit/20M/25p]	✓	✓	✓	1920×1080	16:9	25.00p	20	AVC

❖ [Rec. File Format]: [MOV]

- YUV, Bit value, Image compression:
 - [422/10-I] recording quality: 4:2:2, 10-bit, ALL-Intra
 - [422/10-L] recording quality: 4:2:2, 10-bit, Long GOP
 - [420/10-L] recording quality: 4:2:0, 10-bit, Long GOP
 - [420/8-L] recording quality: 4:2:0, 8-bit, Long GOP
- Audio format: LPCM (2ch)

(A) Recording frame rate

(B) Bit rate

(C) Video compression format (**HEVC**: H.265/HEVC, **AVC**: H.264/MPEG-4 AVC)

[System Frequency]: [59.94Hz (NTSC)]								
[Rec Quality]	[Image Area of Video]			Resolution	Aspect ratio	(A)	(B) (Mbps)	(C)
	FULL	S35	P/P					
[6K/24p/420/10-L]	✓			5952×3968	3:2	23.98p	200	HEVC
[5.9K/30p/420/10-L]	✓			5888×3312	16:9	29.97p	200	HEVC
[5.9K/24p/420/10-L]	✓			5888×3312	16:9	23.98p	200	HEVC
[5.4K/30p/420/10-L]	✓			5376×3584	3:2	29.97p	200	HEVC
[4K-A/48p/420/10-L]		✓	✓	3328×2496	4:3	47.95p	200	HEVC
[4K-A/30p/422/10-I]		✓	✓	3328×2496	4:3	29.97p	400	AVC
[4K-A/30p/422/10-L]		✓	✓	3328×2496	4:3	29.97p	150	AVC
[4K-A/30p/420/8-L]		✓	✓	3328×2496	4:3	29.97p	100	AVC
[4K-A/24p/422/10-I]		✓	✓	3328×2496	4:3	23.98p	400	AVC
[4K-A/24p/422/10-L]		✓	✓	3328×2496	4:3	23.98p	150	AVC
[4K-A/24p/420/8-L]		✓	✓	3328×2496	4:3	23.98p	100	AVC
[C4K/60p/420/10-L]		✓	✓	4096×2160	17:9	59.94p	200	HEVC
[C4K/60p/420/8-L]		✓	✓	4096×2160	17:9	59.94p	150	AVC
[C4K/48p/420/10-L]		✓	✓	4096×2160	17:9	47.95p	200	HEVC
[C4K/30p/422/10-I]	✓	✓	✓	4096×2160	17:9	29.97p	400	AVC

[System Frequency]: [59.94Hz (NTSC)]								
[Rec Quality]	[Image Area of Video]			Resolution	Aspect ratio	Ⓐ	Ⓑ (Mbps)	Ⓒ
	FULL	S35	P/P					
[C4K/30p/422/10-L]	✓	✓	✓	4096×2160	17:9	29.97p	150	AVC
[C4K/30p/420/8-L]	✓	✓	✓	4096×2160	17:9	29.97p	100	AVC
[C4K/24p/422/10-I]	✓	✓	✓	4096×2160	17:9	23.98p	400	AVC
[C4K/24p/422/10-L]	✓	✓	✓	4096×2160	17:9	23.98p	150	AVC
[C4K/24p/420/8-L]	✓	✓	✓	4096×2160	17:9	23.98p	100	AVC
[4K/60p/420/10-L]		✓	✓	3840×2160	16:9	59.94p	200	HEVC
[4K/60p/420/8-L]		✓	✓	3840×2160	16:9	59.94p	150	AVC
[4K/48p/420/10-L]		✓	✓	3840×2160	16:9	47.95p	200	HEVC
[4K/30p/422/10-I]	✓	✓	✓	3840×2160	16:9	29.97p	400	AVC
[4K/30p/422/10-L]	✓	✓	✓	3840×2160	16:9	29.97p	150	AVC
[4K/30p/420/8-L]	✓	✓	✓	3840×2160	16:9	29.97p	100	AVC
[4K/24p/422/10-I]	✓	✓	✓	3840×2160	16:9	23.98p	400	AVC
[4K/24p/422/10-L]	✓	✓	✓	3840×2160	16:9	23.98p	150	AVC
[4K/24p/420/8-L]	✓	✓	✓	3840×2160	16:9	23.98p	100	AVC
[FHD/120p/420/10-L]	✓	✓		1920×1080	16:9	119.88p	150	HEVC
[FHD/60p/422/10-I]	✓	✓	✓	1920×1080	16:9	59.94p	200	AVC
[FHD/60p/422/10-L]	✓	✓	✓	1920×1080	16:9	59.94p	100	AVC
[FHD/60p/420/8-L]	✓	✓	✓	1920×1080	16:9	59.94p	100	AVC
[FHD/60i/422/10-I]	✓	✓	✓	1920×1080	16:9	59.94i	100	AVC
[FHD/60i/422/10-L]	✓	✓	✓	1920×1080	16:9	59.94i	50	AVC
[FHD/48p/420/10-L]	✓	✓	✓	1920×1080	16:9	47.95p	100	HEVC
[FHD/30p/422/10-I]	✓	✓	✓	1920×1080	16:9	29.97p	200	AVC
[FHD/30p/422/10-L]	✓	✓	✓	1920×1080	16:9	29.97p	100	AVC
[FHD/30p/420/8-L]	✓	✓	✓	1920×1080	16:9	29.97p	100	AVC
[FHD/24p/422/10-I]	✓	✓	✓	1920×1080	16:9	23.98p	200	AVC
[FHD/24p/422/10-L]	✓	✓	✓	1920×1080	16:9	23.98p	100	AVC
[FHD/24p/420/8-L]	✓	✓	✓	1920×1080	16:9	23.98p	100	AVC

10. Recording Videos

- (A) Recording frame rate
 (B) Bit rate
 (C) Video compression format (**HEVC**: H.265/HEVC, **AVC**: H.264/MPEG-4 AVC)

[System Frequency]: [50.00Hz (PAL)]								
[Rec Quality]	[Image Area of Video]			Resolution	Aspect ratio	(A)	(B) (Mbps)	(C)
	FULL	S35	P/P					
[5.9K/25p/420/10-L]	✓			5888×3312	16:9	25.00p	200	HEVC
[5.4K/25p/420/10-L]	✓			5376×3584	3:2	25.00p	200	HEVC
[4K-A/50p/420/10-L]		✓	✓	3328×2496	4:3	50.00p	200	HEVC
[4K-A/50p/420/8-L]		✓	✓	3328×2496	4:3	50.00p	150	AVC
[4K-A/25p/422/10-I]		✓	✓	3328×2496	4:3	25.00p	400	AVC
[4K-A/25p/422/10-L]		✓	✓	3328×2496	4:3	25.00p	150	AVC
[4K-A/25p/420/8-L]		✓	✓	3328×2496	4:3	25.00p	100	AVC
[C4K/50p/420/10-L]		✓	✓	4096×2160	17:9	50.00p	200	HEVC
[C4K/50p/420/8-L]		✓	✓	4096×2160	17:9	50.00p	150	AVC
[C4K/25p/422/10-I]	✓	✓	✓	4096×2160	17:9	25.00p	400	AVC
[C4K/25p/422/10-L]	✓	✓	✓	4096×2160	17:9	25.00p	150	AVC
[C4K/25p/420/8-L]	✓	✓	✓	4096×2160	17:9	25.00p	100	AVC
[4K/50p/420/10-L]		✓	✓	3840×2160	16:9	50.00p	200	HEVC
[4K/50p/420/8-L]		✓	✓	3840×2160	16:9	50.00p	150	AVC
[4K/25p/422/10-I]	✓	✓	✓	3840×2160	16:9	25.00p	400	AVC
[4K/25p/422/10-L]	✓	✓	✓	3840×2160	16:9	25.00p	150	AVC
[4K/25p/420/8-L]	✓	✓	✓	3840×2160	16:9	25.00p	100	AVC

[System Frequency]: [50.00Hz (PAL)]								
[Rec Quality]	[Image Area of Video]			Resolution	Aspect ratio	Ⓐ	Ⓑ (Mbps)	Ⓒ
	FULL	S35	P/P					
[FHD/100p/420/10-L]	✓	✓		1920×1080	16:9	100.00p	150	HEVC
[FHD/50p/422/10-I]	✓	✓	✓	1920×1080	16:9	50.00p	200	AVC
[FHD/50p/422/10-L]	✓	✓	✓	1920×1080	16:9	50.00p	100	AVC
[FHD/50p/420/8-L]	✓	✓	✓	1920×1080	16:9	50.00p	100	AVC
[FHD/50i/422/10-I]	✓	✓	✓	1920×1080	16:9	50.00i	100	AVC
[FHD/50i/422/10-L]	✓	✓	✓	1920×1080	16:9	50.00i	50	AVC
[FHD/25p/422/10-I]	✓	✓	✓	1920×1080	16:9	25.00p	200	AVC
[FHD/25p/422/10-L]	✓	✓	✓	1920×1080	16:9	25.00p	100	AVC
[FHD/25p/420/8-L]	✓	✓	✓	1920×1080	16:9	25.00p	100	AVC

Ⓐ Recording frame rate

Ⓑ Bit rate

Ⓒ Video compression format (**HEVC**: H.265/HEVC, **AVC**: H.264/MPEG-4 AVC)

[System Frequency]: [24.00Hz (CINEMA)]								
[Rec Quality]	[Image Area of Video]			Resolution	Aspect ratio	Ⓐ	Ⓑ (Mbps)	Ⓒ
	FULL	S35	P/P					
[6K/24p/420/10-L]	✓			5952×3968	3:2	24.00p	200	HEVC
[5.9K/24p/420/10-L]	✓			5888×3312	16:9	24.00p	200	HEVC
[4K-A/48p/420/10-L]		✓	✓	3328×2496	4:3	48.00p	200	HEVC
[4K-A/24p/422/10-I]		✓	✓	3328×2496	4:3	24.00p	400	AVC
[4K-A/24p/422/10-L]		✓	✓	3328×2496	4:3	24.00p	150	AVC
[4K-A/24p/420/8-L]		✓	✓	3328×2496	4:3	24.00p	100	AVC

[System Frequency]: [24.00Hz (CINEMA)]								
[Rec Quality]	[Image Area of Video]			Resolution	Aspect ratio	Ⓐ	Ⓑ (Mbps)	Ⓒ
	FULL	S35	P/P					
[C4K/48p/420/10-L]		✓	✓	4096×2160	17:9	48.00p	200	HEVC
[C4K/24p/422/10-I]	✓	✓	✓	4096×2160	17:9	24.00p	400	AVC
[C4K/24p/422/10-L]	✓	✓	✓	4096×2160	17:9	24.00p	150	AVC
[C4K/24p/420/8-L]	✓	✓	✓	4096×2160	17:9	24.00p	100	AVC
[4K/48p/420/10-L]		✓	✓	3840×2160	16:9	48.00p	200	HEVC
[4K/24p/422/10-I]	✓	✓	✓	3840×2160	16:9	24.00p	400	AVC
[4K/24p/422/10-L]	✓	✓	✓	3840×2160	16:9	24.00p	150	AVC
[4K/24p/420/8-L]	✓	✓	✓	3840×2160	16:9	24.00p	100	AVC
[FHD/48p/420/10-L]	✓	✓	✓	1920×1080	16:9	48.00p	100	HEVC
[FHD/24p/422/10-I]	✓	✓	✓	1920×1080	16:9	24.00p	200	AVC
[FHD/24p/422/10-L]	✓	✓	✓	1920×1080	16:9	24.00p	100	AVC
[FHD/24p/420/8-L]	✓	✓	✓	1920×1080	16:9	24.00p	100	AVC



• In this document, videos are indicated as follows according to their resolution:

- 6K (5952×3968) video: **6K video**
- 5.9K (5888×3312) video: **5.9K video**
- 5.4K (5376×3584) video: **5.4K video**
- 4K-A (3328×2496) video: **Anamorphic (4:3) video**
- C4K (4096×2160) video: **C4K video**
- 4K (3840×2160) video: **4K video**
- Full High Definition (1920×1080) video: **FHD video**





- Since the camera employs the VBR recording format, the bit rate is changed automatically depending on the subject to record. As a result, video recording time is shortened when a fast-moving subject is recorded.
- Videos in ALL-Intra and 4:2:2 10-bit formats are intended for editing on a PC used for video production.
- When using Super 35 mm/APS-C lenses, 6K, 5.9K, and 5.4K [Rec Quality] cannot be set.
- When using the following function, you can only select 8-bit FHD video:
 - [Miniature Effect] ([Filter Settings])





- You can register functions to Fn buttons:
[] ⇒ [] ⇒ [Fn Button Set] ⇒ [Setting in REC mode] ⇒ [Motion Pic. Rec Quality] (→ [367](#))
- You can register a combination of [System Frequency], [Rec. File Format], [Image Area of Video], and [Rec Quality] to My List. (→ [265](#))

❖ [Filtering]

When the [Rec. File Format] is set to [MOV], you can specify items such as frame rate, resolution, and codec (YUV, Bit value, Image compression), and just display recording quality that meets those conditions.

- 1 In the [Rec Quality] setting screen, press [DISP.].
- 2 Press ▲▼ to select a setting item and then press  or .
 - Settings: [Frame Rate]/[Resolution]/[Codec]/[Variable Frame Rate]/[Hybrid Log Gamma]



- 3 Press ▲▼ to select the filtering conditions and then press  or .
- 4 Press [DISP.] to confirm the setting.
 - You are returned to the [Rec Quality] setting screen.

Clearing the filtering conditions

Select [ANY] in Step 3.

- The filtering conditions are also cleared when you do the following:
 - Change the [System Frequency]
 - Select a recording quality from [Rec Quality (My List)]



- When you change recording quality using a filter, the current filtering conditions are stored.

❖ [add to list]

Select a recording quality and register it in My List. The recording quality you register can be set in [Rec Quality (My List)].

In the [Rec Quality] setting screen, press [Q].

- The following settings are also registered at the same time:
 - [System Frequency]
 - [Rec. File Format]
 - [Image Area of Video]



Setting or deleting in My List

① Select [Rec Quality (My List)].

- ⇒ ⇒ ⇒ [Rec Quality (My List)]

② Press ▲▼ to select a setting item and then press or .

- You cannot select setting items that have different system frequencies.
- To delete from My List, select the item and press [Q].



- Up to 12 types of recording quality can be registered.



- You can register functions to Fn buttons:

[] ⇒ [] ⇒ [Fn Button Set] ⇒ [Setting in REC mode] ⇒ [Rec Quality (My List)] (→ [367](#))



[Image Area of Video]

iA P A S M 



Set the image area during video recording. The angle of view differs depending on the image area. Narrowing the image area allows you to achieve a telescopic effect without image deterioration.

 →  →  → Select [Image Area of Video]

Item	Settings details	Angle of view	Telescopic effect
[FULL]	Recording is within the area suited to the image circle of a full-frame lens.	 Wide Narrow	 None High
[S35mm]	Recording is within the area suited to the image circle of a Super 35 mm lens.		
[PIXEL/PIXEL]	Records with one pixel on the sensor, which is equal to one pixel of the video. Records a range corresponding to the resolution range in [Rec Quality]. (→ 255)		

- The [Image Area of Video] settings you can select differ depending on the [Rec Quality] setting.
For details, refer to page [255](#).
- It is not possible to set to [FULL] in the following cases.
 - When using Super 35 mm/APS-C lenses
 - When [Image Circle] in [Lens Information] is set to [S35mm]
- When set to [Live Cropping], the setting is fixed to [FULL]. However, the setting is fixed to [S35mm] in the following cases:
 - When a 59.94p or 50.00p [Rec Quality] is set

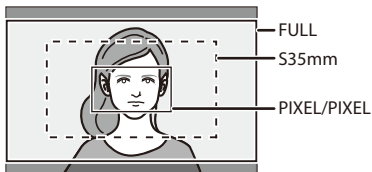
Image area (Ex.: FHD video)

- To check the image area in recording modes other than [M] mode, set [Video-Priority Display] in the [Custom] ([Monitor / Display (Video)]) menu to [ON]. (→ 441)

Time Code

iA P A S M



When [Rec. File Format] is set to [AVCHD] or [MOV], the time code is automatically recorded during video recording. If [MP4], the time code is not recorded.

Setting the Time Code

Sets the recording, display, and output of the time code.

1 Set [Rec. File Format] to [AVCHD] or [MOV].

- → → [Rec. File Format] → [AVCHD]/[MOV]

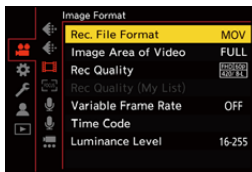

2 Select [Time Code].

- → → [Time Code]

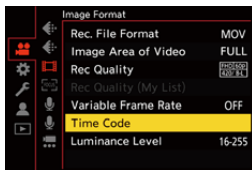

[Time Code Display]	Displays the time code on the recording screen/playback screen.	
[Count Up]	[REC RUN]	Counts the time code only when recording videos.
	[FREE RUN]	Counts the time code also when video recording is stopped and when the camera is turned off.
	<ul style="list-style-type: none"> When the following function is being used, [Count Up] is fixed to [REC RUN]: <ul style="list-style-type: none"> – [Variable Frame Rate] 	

[Time Code Value]	[Reset]	Sets to 00:00:00:00 (hour: minute: second: frame)
	[Manual Input]	Manually input hour, minute, second and frame.
	[Current Time]	Sets hour, minute and second to current time and sets frame to 00.
[Time Code Mode]	[DF]	Drop Frame. The camera modifies the difference between recorded time and time code. <ul style="list-style-type: none"> Seconds and frames are separated by “.”. (Example: 00:00:00.00)
	[NDF]	Non-Drop Frame. Records the time code without drop frame. <ul style="list-style-type: none"> Seconds and frames are separated by “.”. (Example: 00:00:00:00)
<ul style="list-style-type: none"> When the following functions are being used, [Time Code Mode] is fixed to [NDF]: <ul style="list-style-type: none"> [50.00Hz (PAL)]/[24.00Hz (CINEMA)] ([Synchro Scan]) 47.95p or 23.98p [Rec Quality] 		
[HDMI Time Code Output]	<p>Time code information is added to images output via HDMI when recording with the [⏏M] mode.</p> <ul style="list-style-type: none"> The time code can also be output via HDMI by setting the mode dial to [⏏M] during playback. In the [Setup] ([IN/OUT]) menu, set [HDMI Mode (Playback)] in [TV Connection] to [AUTO]. (→ 451) The device screen may go dark depending on the connected device. 	
[External TC Setting]	<ul style="list-style-type: none"> Synchronize the time code default value with an external device that supports time code input and output. (→ 270) 	
	[TC Synchronization]	Selects the input (→ 273) and output (→ 271) for time code signals.
	[TC Output Reference]	Sets the timing for time code signal output. (→ 271)

Synchronizing the Time Code with an External Device



Synchronize the time code default value with an external device that supports time code signal input and output.

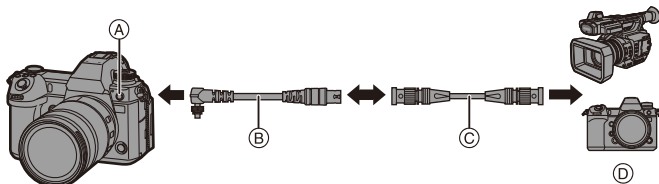

- (A) Flash synchro socket
- (B) BNC conversion cable (for TC IN/OUT) (supplied)
- (C) BNC cable (commercially available)
- (D) External devices

❖ Preparations for Time Code Synchronization

When [Count Up] is set to [FREE RUN] in the [M] mode, you can synchronize the initial value of the time code with an external device.

- 1 Set the mode dial to [M].
- 2 Set [Count Up] to [FREE RUN].
 - MENU/SET → [] → [] → [Time Code] → [Count Up] → [FREE RUN]
- 3 Rotate the flash synchro socket cap in the direction of the arrow to remove.
 - Be careful not to lose the flash synchro socket cap.

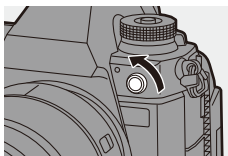

- 4 Insert the BNC conversion cable (for TC IN/OUT), and then rotate the locking screw in the direction of the arrow to attach the cable.



- 5 Connect the BNC conversion cable (for TC IN/OUT) and the external device with the BNC cable.



- Do not use any other BNC conversion cables (for TC IN/OUT) except the supplied one.
- Do not use the BNC cables with the length of 2.8 m (9.2 feet) or more.
- We recommend using a 5C-FB equivalent double-shielded BNC cables.

Synchronize the Time Code of the External Device with That of the Camera (TC OUT)

The initial time code value of the external device is synchronized according to the time code signal (LTC signal) of the camera.

1 Prepare for time code synchronizing. (→ 270)

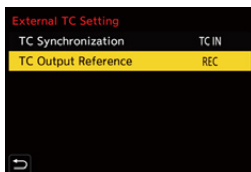

2 Select [TC Output Reference].

- → → → [Time Code] → [External TC Setting] → [TC Output Reference]



[Recording Reference]	Outputs the time code signal for the images that you record.
[HDMI Reference]	When connected with an external device (external recorder, etc.) via HDMI, the time code signal output is delayed slightly to match the HDMI images.

3 Set [TC Synchronization] to [TC OUT].

-  ⇒  ⇒  ⇒ [Time Code] ⇒ [External TC Setting] ⇒ [TC Synchronization] ⇒ [TC OUT]
- The time code signal is output according to the recording frame rate of the [Rec Quality] and the [Time Code Mode] ([DF]/[NDF]) setting.

4 Operate the external device to synchronize the time code.

❖ Outputting the Time Code Signal Again

By setting as follows, the time code signal (LTC signal) can be output just by connecting with the external device with the BNC cable:

-  mode
- [Count Up] ([Time Code]): [FREE RUN]
- [TC Synchronization] ([External TC Setting] in [Time Code]): [TC OUT]



Synchronize the Time Code of the Camera with That of the External Device (TC IN)

The initial time code value of the camera is synchronized according to the time code signal (LTC signal) of the external device.

- In advance, change the [System Frequency] (→ 253), [Rec Quality] (→ 255), and [Time Code Mode] (→ 269) to match the external device.

1 Prepare for time code synchronizing. (→ 270)

2 Set [TC Synchronization] to [TC IN].

-  → [] → [] → [Time Code] → [External TC Setting] → [TC Synchronization] → [TC IN]

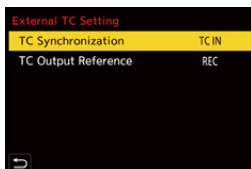

3 Operate the external device to output the time code signal.

- Set the time code count method of the external device to free run, and output the signal.
- When synchronized with the time code of an external device, this camera is in a slave state, and the [TC] of the time code shown on the screen switches to [**TC**].

- When multiple units of this camera are synchronized, the time code and exposure timings are synchronized so you can match the timings for starting exposure between cameras.
- The exposure timing can only be synchronized the first time after [TC Synchronization] is set to [TC IN].

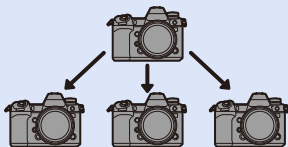

❖ Maintaining, Releasing, and Restoring the Slave State

Even if you disconnect the BNC cable, the camera will remain in slave state.

- Perform one of the following operations to release the camera from the slave state.
 - Operate the camera on/off switch
 - Switch the recording mode
 - Change the [System Frequency]
 - Set the [Variable Frame Rate]
 - Switch the [Rec Quality] between 47.95p/23.98p and a different recording frame rate
 - Change the following [Time Code] setting items
[Count Up], [Time Code Value], [Time Code Mode], [TC Synchronization]
- To restore the slave state, reconnect the BNC cable to the external device while set as follows.

The time code signal (LTC signal) can be input just by connecting.

- [M] mode
- [Count Up] ([Time Code]): [FREE RUN]
- [TC Synchronization] ([External TC Setting] in [Time Code]): [TC IN]



- Even when the system frequency differs between the camera and the external device, their initial time code values may be synchronized. Bear in mind, however, that the time codes lose sync as they count up.

Using AF (Video)

This section describes the use of AF when video recording.

- ➔ In “5. Focus/Zoom”, the functions described work with both pictures and video.
 - Selecting the Focus Mode: ➔ 96
 - Selecting the AF Mode: ➔ 103
 - AF Area Movement Operation: ➔ 118
 - Record Using MF: ➔ 123
 - Recording with Zoom: ➔ 127

[Continuous AF]



You can select how to set the focus in AF when recording videos.

➔ ➔ ➔ Select [Continuous AF]

[MODE1]	The camera continues to automatically focus only during recording.
[MODE2]	The camera automatically keeps focusing on subjects during recording standby and during recording. <ul style="list-style-type: none"> • To keep focusing on subjects during recording standby while in the [P]/[A]/[S]/[M] modes, set [Video-Priority Display] to [ON] in the [Custom] ([Monitor / Display (Video)]) menu.
[OFF]	The camera maintains the focus point at the start of recording.



- In the [iA] mode, the camera automatically keeps focusing during recording standby, irrespective of the [Continuous AF] setting.
- Depending on the recording conditions or lens used, the AF operation sound may be recorded during video recording.
If the operation sound bothers you, we recommend recording with [Continuous AF] set to [OFF].
- If the zoom is operated while recording videos, the subject may take a while to come into focus.
- When the following function is being used, [MODE1] switches to [MODE2]:
 - HDMI output
- [MODE2] does not work during recording standby in the following cases:
 - In preview mode
 - In low light situations

[AF Custom Setting(Video)]

iA P A S M 





You can fine-adjust the focusing method for video recording using [Continuous AF].

 ⇒  ⇒  ⇒ Select [AF Custom Setting(Video)]

[ON]	Enables the following settings.	
[OFF]	Disables the following settings.	
[SET]	[AF Speed]	<p>[+] side: Focus moves at a faster speed.</p> <p>[-] side: Focus moves at a slower speed.</p>
	[AF Sensitivity]	<p>[+] side: When the distance to the subject changes significantly, the camera immediately readjusts the focus.</p> <p>[-] side: When the distance to the subject changes significantly, the camera waits for a little before readjusting the focus.</p>



• You can register functions to Fn buttons:

 ⇒  ⇒ [Fn Button Set] ⇒ [Setting in REC mode] ⇒ [AF Custom Setting(Video)] (→ [367](#))

Video Brightness and Coloring

This section describes the brightness and coloring settings used during video recording.



- In “7. Metering/Exposure/ISO Sensitivity” and “8. White Balance/Image Quality”, the functions described work with both pictures and video. Please also refer to those sections.
 - [Metering Mode]: → 185
 - Exposure Compensation: → 197
 - Locking Focus and Exposure (AF/AE Lock): → 199
 - ISO Sensitivity: → 200
 - White Balance (WB): → 204
 - [Photo Style]: → 210
 - [Filter Settings]: → 216

[Luminance Level]



You can set the luminance range to suit the purpose of video recording.



→ [] → [] → Select [Luminance Level]

Settings: [0-255]/[16-235]/[16-255]



- When set to a 10-bit [Rec Quality], the setting items change to [0-1023], [64-940], and [64-1023].
- When [Rec. File Format] is set to [AVCHD], [0-255] cannot be set.
- When [Photo Style] is set to [V-Log], this is fixed to [0-255] ([0-1023]).
- When [Photo Style] is set to [Like2100(HLG)], this is fixed to [64-940].

[Master Pedestal Level]

iA P A S M 



You can adjust the black level, which serves as the reference for images.

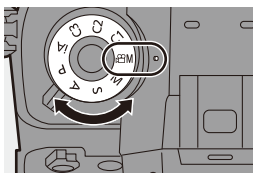

1 Set the mode dial to [].



2 Select [Master Pedestal Level].

-  → [] → [] → [Master Pedestal Level]

3 Adjust master pedestal.

- Rotate ,  or .
- Set in the range between -15 and $+15$.

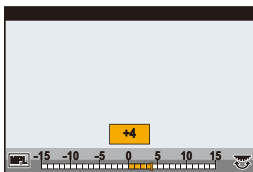

- [Master Pedestal Level] is not available when using the following function:
– [V-Log] ([Photo Style])

Recording While Controlling Overexposure (Knee)



When [Photo Style] is set to [Like709], you can adjust the knee so that recording can be performed with minimal overexposure.

1 Set [Photo Style] to [Like709].

- → → → [Photo Style] → [Like709]

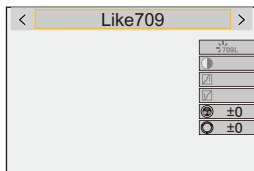

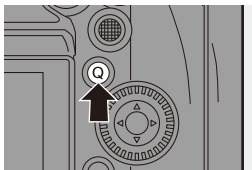

2 Press [Q].

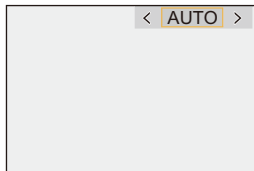

3 Select a knee setting.

- Press ◀▶ to select a setting item.



[AUTO]	Adjusts the compression levels of high-luminance areas automatically.
[MANUAL]	<p>Allows you to adjust the master knee point and master knee slope manually.</p> <p>Press ▲▼ to select an item and then press ◀▶ to adjust.</p> <p>[POINT]: Master knee point</p> <p>[SLOPE]: Master knee slope</p> <ul style="list-style-type: none"> • Rotate  to adjust the knee master point, and  to adjust the knee master slope. • Values within the following ranges can be set: <ul style="list-style-type: none"> – Master knee point: 80.0 to 107.0 – Master knee slope: 0 to 99
[Off]	—

4 Confirm your selection.

- Press  or .

[ISO Sensitivity (video)]

iA P A S M 

Sets the lower and upper limits for ISO sensitivity when ISO sensitivity is set to [AUTO].

1 Set the mode dial to [].

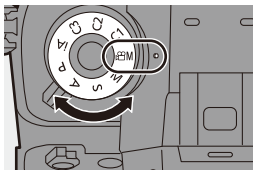

2 Set [ISO Sensitivity (video)].

-  → [] → [] → [ISO Sensitivity (video)]

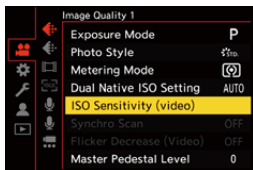

❖ Setting Items ([ISO Sensitivity (video)])

[ISO Auto Lower Limit Setting]	Sets the lower limit for ISO sensitivity when ISO sensitivity is [AUTO]. <ul style="list-style-type: none"> • Set in the range between [100] and [25600].
[ISO Auto Upper Limit Setting]	Sets the upper limit for ISO sensitivity when ISO sensitivity is [AUTO]. <ul style="list-style-type: none"> • Set to [AUTO] or in the range between [200] and [51200].



Audio Settings





iA P A S M 



[Sound Rec Level Disp.]

The sound recording level is displayed on the recording screen.





 ⇒ [] ⇒ [] ⇒ Select [Sound Rec Level Disp.]
Settings: [ON]/[OFF]

-  • When [Sound Rec Level Limiter] is set to [OFF], [Sound Rec Level Disp.] is fixed to [ON].
-  • You can register functions to Fn buttons:
[] ⇒ [] ⇒ [Fn Button Set] ⇒ [Setting in REC mode] ⇒ [Sound Rec Level Disp.] (→ 367)

[Mute Sound Input]

This mutes audio input.

 ⇒ [] ⇒ [] ⇒ Select [Mute Sound Input]
Settings: [ON]/[OFF]

-  • [] is displayed on the recording screen.
-  • You can register functions to Fn buttons:
[] ⇒ [] ⇒ [Fn Button Set] ⇒ [Setting in REC mode] ⇒ [Mute Sound Input] (→ 367)

[Sound Rec Gain Level]

This switches the gain of audio input.







 ⇒ [] ⇒ [] ⇒ Select [Sound Rec Gain Level]





[STANDARD]	This is the standard input gain setting. (0 dB)
[LOW]	Audio input is reduced for recording in environments with loud noises. (−12 dB)

-  • [Sound Rec Gain Level] is not available when [Mic Socket] is set to **[LINE]** and an external audio device is connected.

[Sound Rec Level Adj.]



Manually adjust the sound recording level.



- Select [Sound Rec Level Adj.].
 -  ⇒ [] ⇒ [] ⇒ [Sound Rec Level Adj.]
- Press   to adjust the sound recording level and then press  or  .
 - You can adjust the sound recording level within the range from [MUTE], [−18dB] to [+12dB] in steps of 1 dB.
 - Displayed dB values are approximate.

-  • When set to [MUTE],  is displayed in the recording screen.
-  • You can register functions to Fn buttons:
 - [] ⇒ [] ⇒ [Fn Button Set] ⇒ [Setting in REC mode] ⇒ [Sound Rec Level Adj.] (→ [367](#))

[Sound Rec Level Limiter]

The sound recording level is adjusted automatically to minimize sound distortion (crackling noise).

 ⇒ [] ⇒ [] ⇒ Select [Sound Rec Level Limiter]
Settings: [ON]/[OFF]

- ➔ You can register functions to Fn buttons:
[] ⇒ [] ⇒ [Fn Button Set] ⇒ [Setting in REC mode] ⇒ [Sound Rec Level Limiter] (→ 367)

[Wind Noise Canceller]

This reduces the wind noise coming into the built-in microphone while maintaining sound quality.

 ⇒ [] ⇒ [] ⇒ Select [Wind Noise Canceller]

[HIGH]	This effectively reduces the wind noise by reducing the low-pitched sound when a strong wind is detected.
[STANDARD]	This reduces wind noise without loss of sound quality by filtering out only wind noise.
[OFF]	—

-  You may not see the full effect depending on the recording conditions.
- ➔ This function works only with the built-in microphone.
When an external microphone is connected, [Wind Cut] is displayed. (→ 342)

Main Assist Functions

This section describes the main assist functions that are convenient when recording.

- ➔ The [Custom] ([Monitor / Display (Video)]) menu has display assist functions such as the center marker.
For details, refer to page 439.

[SS/Gain Operation]



You can switch the units of shutter speed values and gain (sensitivity) values.

➔ ➔ ➔ Select [SS/Gain Operation]

[SEC/ISO]	Displays the shutter speed in seconds and the gain in ISO.
[ANGLE/ISO]	Displays the shutter speed in degrees and the gain in ISO. <ul style="list-style-type: none"> • The angle can be set in a range between 11° and 358° (when [Synchro Scan] is set to [OFF])
[SEC/dB]	Displays the shutter speed in seconds and the gain in dB. <ul style="list-style-type: none"> • 0 dB corresponds to either of the following ISO sensitivity values. <ul style="list-style-type: none"> – When [Dual Native Gain Setting] is set to [AUTO] or [LOW]: [100] – When [Dual Native Gain Setting] is set to [HIGH]: [640]



- When [SS/Gain Operation] is set to [SEC/dB], menu names change as shown below:
 - [Dual Native ISO Setting] ➔ [Dual Native Gain Setting]
 - [ISO Sensitivity (video)] ➔ [Gain Setting]
 - [ISO Auto Lower Limit Setting] ➔ [Auto Gain Lower Limit Setting]
 - [ISO Auto Upper Limit Setting] ➔ [Auto Gain Upper Limit Setting]
 - [Extended ISO] ➔ [Extended Gain Setting]
 - [ISO Displayed Setting] ➔ [Gain Displayed Setting]

❖ Setting Range for Gain (Sensitivity)

When [SS/Gain Operation] is set to [SEC/dB], gain (sensitivity) can be set in the following ranges.

[Dual Native Gain Setting]	[Extended Gain Setting]	Setting Range for Gain (Sensitivity)
[AUTO]	[OFF]	[AUTO], [0dB] to [+54dB]
	[ON]	[AUTO], [−6dB] to [+66dB]
[LOW]	[OFF]	[AUTO], [0dB] to [+18dB]
	[ON]	[AUTO], [−6dB] to [+18dB]
[HIGH]	[OFF]	[AUTO], [0dB] to [+38dB]
	[ON]	[AUTO], [−6dB] to [+50dB]

[WFM/Vector Scope]



iA P A S M 

This displays the waveform monitor or the vector scope on the recording screen. You can change the size of the waveform display.

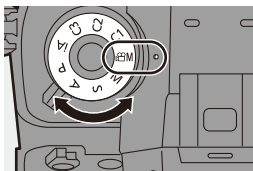
1 Set the mode dial to .





2 Set [WFM/Vector Scope].

-  →  →  → [WFM/Vector Scope]



[WAVE]	Displays a waveform.
[VECTOR]	Displays the vector scope.
[OFF]	—

3 Select the position to display.

- Press ▲▼◀▶ to select and then press  or .
- Positions can be moved to the diagonal directions using the joystick.
- You can also move using touch operations.
- You can rotate  to change the size of the waveform.
- To return the waveform or vector scope position back to the center, press [DISP.]. With waveform, pressing [DISP.] once again returns the size to the default setting.

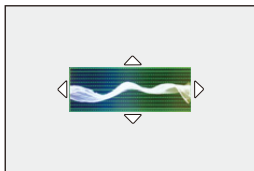

❖ Screen Displays

Waveform

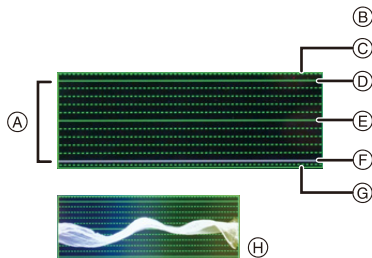

(A) The range between 0 and 100 shows dotted lines at intervals of 10.

(B) %, IRE (Institute of Radio Engineers)

(C) 109 (dotted line)

(D) 100

(E) 50

(F) 0

(G) -4 (dotted line)

(H) Display example

- The waveform displayed on the camera indicates the luminance as values based on the conversions below:

0% (IRE): Luminance value 16 (8-bit)

100% (IRE): Luminance value 235 (8-bit)

Vector scope

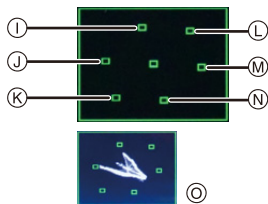



- ① R (Red)
- ② YL (Yellow)
- ③ G (Green)
- ④ MG (Magenta)
- ⑤ B (Blue)
- ⑥ CY (Cyan)
- ⑦ Display example



- You can also change the position by dragging on the recording screen.
- The waveform and vector scope are not output through HDMI.
- When [WFM/Vector Scope] is set, [Histogram] does not work.



- You can register functions to Fn buttons:
 [] ⇒ [] ⇒ [Fn Button Set] ⇒ [Setting in REC mode] ⇒ [WFM/Vector Scope] (→ [367](#))

[Luminance Spot Meter]

iA P A S M 









Specify any spot on the subject to measure the luminance over a small area.

1 Set [Luminance Spot Meter].

- Press  → [] → [] → [Luminance Spot Meter] → [ON]



2 Select the position where you want to measure the luminance.

- Press     to select and then press  or .

(A) Luminance value

- Positions can be moved to the diagonal directions using the joystick.
- You can also change the position by dragging the frame on the recording screen.
- To return the position back to the center, press [DISP.].

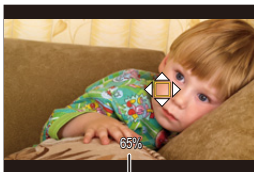

(A)



Measurement Range

Measuring is possible in the range -7% to 109% (IRE).

- When [Photo Style] is set to [V-Log], this can be measured with Stop units.
(Calculated as 0 Stop=42% (IRE))



- You can register functions to Fn buttons:

[] → [] → [Fn Button Set] → [Setting in REC mode] → [Luminance Spot Meter] (→ 367)

[Zebra Pattern]

iA P A S M 



Parts that are brighter than the benchmark value are displayed with stripes.

You can also set the benchmark value and the breadth of the range so that the stripes are displayed on parts that are within the range of brightness you specify.



[ZEBRA1]



[ZEBRA2]



[ZEBRA1+2]

 →  →  → Select [Zebra Pattern]

[ZEBRA1]	Parts that are brighter than the benchmark value are displayed with [ZEBRA1] stripes.		
[ZEBRA2]	Parts that are brighter than the benchmark value are displayed with [ZEBRA2] stripes.		
[ZEBRA1+2]	Both [ZEBRA1] and [ZEBRA2] are displayed.		
[OFF]	—		
[SET]	[Zebra 1]	50% to 105%/ [BASE/RANGE]	Sets the benchmark brightness.
	[Zebra 2]	50% to 105%/ [BASE/RANGE]	

❖ When [BASE/RANGE] Was Selected with [SET]

Centerd on the brightness set with [Base Level], parts with the brightness in the range set in [Range] are displayed with the stripes.



- [Base Level] can be set in the range between 0% and 109% (IRE).
- [Range] can be set in the range between $\pm 1\%$ and $\pm 10\%$ (IRE).
- When [Photo Style] is set to [V-Log], these are set at Stop units. (Calculated as 0 Stop=42% (IRE))



- [ZEBRA1+2] cannot be selected while you are setting [BASE/RANGE].



- You can register functions to Fn buttons:

[] \Rightarrow [] \Rightarrow [Fn Button Set] \Rightarrow [Setting in REC mode] \Rightarrow [Zebra Pattern]
([→ 367](#))

[Video Frame Marker]

iA P A S M 





A frame with the set aspect ratio is displayed on the recording screen. This allows you to see during recording the angle of view that will be achieved with trimming (cropping) in post-processing.

 ⇒  ⇒  ⇒ Select [Video Frame Marker]

	[ON]	Displays video grid lines on the recording screen.
	[OFF]	—
[SET]	[Frame Aspect]	Sets the aspect ratio of video grid lines. [2.39:1]/[2.35:1]/[2.00:1]/[1.85:1]/[16:9]/[4:3]/ [1:1]/[4:5]
	[Frame Color]	Sets the color of video grid lines.
	[Frame Mask]	Sets the opacity of the outside of video grid lines. [100%]/[75%]/[50%]/[25%]/[OFF]



- You can register functions to Fn buttons:

[] ⇒ [] ⇒ [Fn Button Set] ⇒ [Setting in REC mode] ⇒ [Video Frame Marker] (→ [367](#))

Color bars/Test Tone



The color bars are displayed on the recording screen.

A test tone is output while the color bars are being displayed.



[SMPTTE]



[EBU]



[ARIB]

→ → → Select [Color Bars]

Settings: [SMPTTE]/[EBU]/[ARIB]

• To end the display, press .

❖ Adjusting the Test Tone

There are 4 levels ([−12dB], [−18dB], [−20dB], and [MUTE]) of test tone to select.

Rotate , or to select the test tone level.



- The color bars and test tone will be recorded on the video if video recording is started while the color bars are being displayed.
- The brightness and coloring that appear on the camera's monitor or viewfinder may differ from those that appear on another device such as an external monitor.



- You can register functions to Fn buttons:

→ → [Fn Button Set] → [Setting in REC mode] → [Color Bars]
(→ 367)

11. Special Video Recording

Variable Frame Rate

iA P A S M 



By recording using a frame rate that is different to the playback frame rate, you can record smooth slow motion video and fast motion video.

Slow Motion Video (Overcrank Recording)	Set a number of frames that is higher than the recording frame rate of the [Rec Quality]. For example: When recording at 48 fps when set to a 24.00p [Rec Quality], the speed is halved.
Fast Motion Video (Undercrank Recording)	Set a number of frames that is lower than the recording frame rate of the [Rec Quality]. For example: When recording at 12 fps when set to a 24.00p [Rec Quality], the speed is doubled.

1 Set the mode dial to [M].

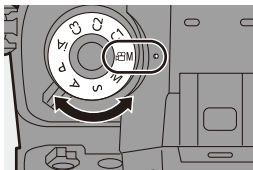

2 Set [Rec. File Format] to [AVCHD] or [MOV].

-  → [] → [] → [Rec. File Format] → [AVCHD]/[MOV]

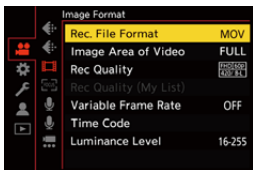



3 Select a recording quality with which you can use [Variable Frame Rate] recording.

-  →  →  → [Rec Quality]

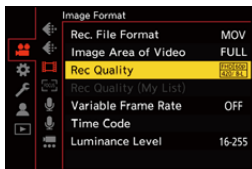
- Items with which you can use [Variable Frame Rate] are indicated as [VFR available].
- Recording qualities with which you can use [Variable Frame Rate] recording:
→ 323



4 Select an [Image Area of Video] with which you can use [Variable Frame Rate].

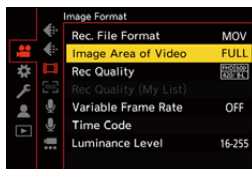

-  →  →  → [Image Area of Video]

- [Variable Frame Rate] is not available with the following combinations of [Rec Quality] and [Image Area of Video]. Change the [Image Area of Video] as necessary.







[Rec Quality]	[Image Area of Video]
4K video, C4K video	[FULL]
[FHD/60p/420/8-L]/[FHD/50p/420/8-L]	[PIXEL/PIXEL]

5 Set [Variable Frame Rate].

-  →  →  → [Variable Frame Rate] → [ON]
- Press ◀▶ to switch between [ON] and [OFF].

6 Set the frame rate.

- Rotate ,  or  to select a numeric value, then press  or .

- The angle of view is reduced when you set to a frame rate exceeding 150 fps.

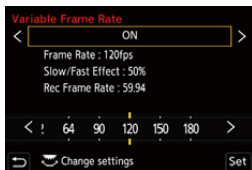

❖ Available Frame Rate Setting Ranges

The frame rate you can set differs depending on the [Rec. File Format] and [Rec Quality] settings.

[Rec. File Format]	[Rec Quality]	Frame rate
[AVCHD]	FHD video	2 fps to 60 fps
[MOV]	Anamorphic (4:3) video	2 fps to 50 fps ^{*1}
	C4K video/4K video	2 fps to 60 fps
	FHD video	2 fps to 180 fps ^{*2}

- *1 When set to a 23.98p or 24.00p [Rec Quality], a frame rate exceeding 48 fps cannot be set.
- *2 When [Image Area of Video] is set to [PIXEL/PIXEL], it is not possible to set to a frame rate exceeding 60 fps.



- When the [Rec. File Format] has been set to [MOV], you can filter to show just the recording qualities where [Variable Frame Rate] can be used. (→ 264)
- We recommend using a tripod when recording images with [Variable Frame Rate].



- Focus mode switches to MF.
- Audio will not be recorded during variable frame rate recording.
- When set to a frame rate exceeding 60 fps, there may be some deterioration in recording quality.
- When the following functions are being used, [Variable Frame Rate] is not available:
 - [Filter Settings]
 - [Live Cropping]



- You can register functions to Fn buttons:
 [] ⇒ [] ⇒ [Fn Button Set] ⇒ [Setting in REC mode] ⇒ [Variable Frame Rate] (→ 367)

High Frame Rate Video

iA P A S M 



[MOV] video with high frame rates can be recorded to cards. By converting it with the compatible software, it is possible to produce slow motion video. AF recording and audio recording, not possible with [Variable Frame Rate], also become possible.

❖ Recording Qualities for High Frame Rate Video

[Rec. File Format]	[System Frequency]	[Rec Quality]	Recording frame rate
[MOV]	[59.94Hz (NTSC)]	[4K-A/48p/420/10-L] [C4K/48p/420/10-L] [4K/48p/420/10-L] [FHD/48p/420/10-L]	47.95p
		[FHD/120p/420/10-L]	119.88p
	[50.00Hz (PAL)]	[FHD/100p/420/10-L]	100.00p
	[24.00Hz (CINEMA)]	[4K-A/48p/420/10-L] [C4K/48p/420/10-L] [4K/48p/420/10-L] [FHD/48p/420/10-L]	48.00p



- By filtering the [Rec Quality] by the frame rate, you can display just those recording qualities that match the frame rate conditions.

For details, refer to page [264](#).

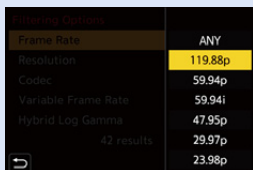

Recording Options	
Frame Rate	ANY
Resolution	119.88p
Codec	59.94p
Variable Frame Rate	59.94i
Hybrid Log Gamma	47.95p
	42 results
	29.97p
	23.98p



- When outputting via HDMI, the frame rate is down-converted to 59.94p, 23.98p, 50.00p, or 24.00p for output.

For details, refer to page [335](#).

[Focus Transition]



iA P A S M 

Smoothly transitions the focus position from the current position to a position registered in advance.

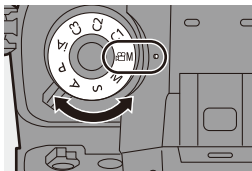
1 Set the mode dial to [M].





2 Select [Focus Transition].



-  →  →  → [Focus Transition]



3 Set the recording settings.

[Start]	Start recording.
[Focus Pull Setting]	Registers the focus position. <ul style="list-style-type: none"> • The setting screen for the focus position is displayed when you select either [1], [2], or [3]. Use the same procedure as MF (→ 123) to check the focus, then press  or  to register the focus position.
[Focus Transition Speed]	Sets the moving speed of focus. <ul style="list-style-type: none"> • Moving speed: [SH] (fast) to [SL] (slow)
[Focus Transition Rec]	Starts Focus Transition when recording starts. <ul style="list-style-type: none"> • Select the position registered with [Focus Pull Setting].
[Focus Transition Wait]	Sets the wait time before the start of Focus Transition.

4 Close the menu.

- Selects [Start], and press  or .
- The recording screen is displayed.
- To return to the setting screen, press [DISP].

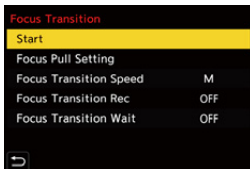

5 Start recording.

- Press the video rec. button.
- If you have enabled [Focus Transition Rec], Focus Transition will start when you start recording a video.

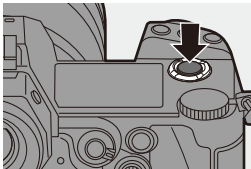

6 Start Focus Transition.

- Press   to select [1], [2], or [3], and then press  or .

- (A) Current focus position
- (B) Registered focus position

- When [Focus Transition Wait] is set, Focus Transition starts after the set time has elapsed.

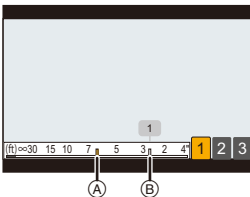

7 End Focus Transition.

- Press [Q].

8 Stop recording.

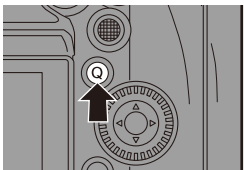

- Press the video rec. button once again.





- Maintain the same distance to the subject after setting the focus position.
- The moving speed of focus varies depending on the lens being used.
- While using [Focus Transition], it is not possible to focus on anything other than the registered focus position.
- Any of the operations below will clear the focus position settings.
 - Operating the camera on/off switch
 - Zoom operation
 - Switching the focus mode
 - Switching the recording mode
 - Replacing the lens
- When the following functions are being used, [Focus Transition] is not available:
 - [Variable Frame Rate]
 - [Live Cropping]
- [Focus Transition] cannot be used when using an interchangeable lens that does not support the focus mode [AFC].



- You can register functions to Fn buttons:
[] ⇒ [] ⇒ [Fn Button Set] ⇒ [Setting in REC mode] ⇒ [Focus Transition] (→ [367](#))

[Live Cropping]

iA P A S M 

By cropping a part of the image from the image displayed in the live view, it is possible to record FHD video that incorporates panning and zooming with the camera staying in a fixed position.



Pan

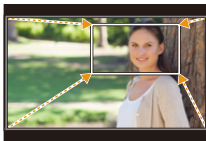



Zoom in

 • Use a tripod to minimize camera shake.

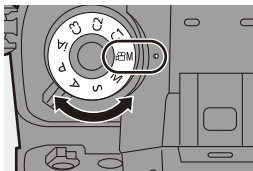
1 Set the mode dial to [].



2 Set [Rec. File Format] to [MP4] or [MOV].

-  ⇒ [] ⇒ [] ⇒ [Rec. File Format] ⇒ [MP4]/[MOV]

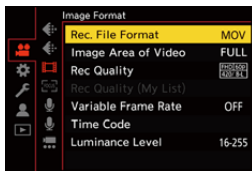

3 Select a recording quality with which you can record [Live Cropping] video.

- **MENU/SET** → [] → [] → [Rec Quality]

- A recording quality with which you can record [Live Cropping] video: → 323

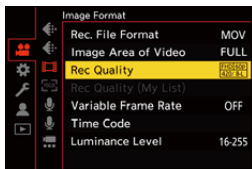

4 Set the time for panning or zooming.

- **MENU/SET** → [] → [] → [Live Cropping] → [40SEC]/[20SEC]

- If you have selected a recording format or recording quality where Live Cropping recording is not available, the camera switches to a recording format or FHD video recording quality where recording is possible. (→ 323)



5 Set the cropping start frame.

- Select the range to be cropped and press **MENU/SET** or **DISP.**.

6 Set the cropping end frame.

- (A) Cropping start frame
- (B) Cropping end frame

- Select the range to be cropped and press **MENU/SET** or **DISP.**.

- To redo the settings for the position and size of the start frame and the end frame, press **DISP.**.

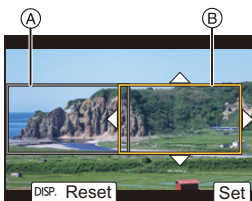



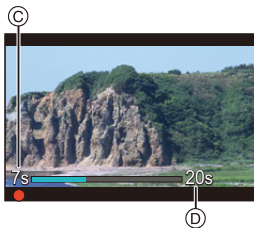
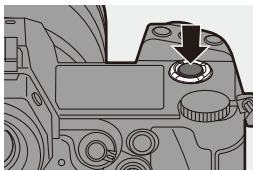

7 Start Live Cropping recording.





- Ⓒ Elapsed recording time
 - Ⓓ Set operating time
 - Press the video rec. button.
- When the set operating time has elapsed, recording automatically ends.
To end recording midway, press the video rec. button again.



❖ Operations for Setting the Cropping Frame

Button operation	Touch operation	Description of operation
	Touch	Moves the frame. <ul style="list-style-type: none"> • Positions can be moved to the diagonal directions using the joystick.
 / 	Pinch out/ pinch in	Enlarges/reduces the frame in small steps.
	—	Enlarges/reduces the frame.
[DISP.]	[Reset]	Start frame: Returns the frame position and size to the default settings. End frame: Cancels the settings for the position and size of the frame.
	[Set]	Confirms the frame position and size.



- AF mode switches to [] (face detection). (Human bodies cannot be detected. It is not possible to specify the person to bring into focus.)
 - Brightness measurements and focusing are performed within the cropping frame. To lock the focus point, set [Continuous AF] to [OFF], or set the focus mode to [MF].
 - [Metering Mode] will be [] (multi-metering).
- ➔ You can register functions to Fn buttons:
- [] ➔ [] ➔ [Fn Button Set] ➔ [Setting in REC mode] ➔ [Live Cropping] (➔ 367)

Log Recording

iA P A S M 



Setting [Photo Style] to [V-Log] enables Log recording.

Images finished with rich gradation can be created through post production processing.

 → [] → [] → [Photo Style] → Select [V-Log]



- Post-production processing is enabled by utilizing LUT (Look-Up Table). You can download LUT data from the following support site:
<https://panasonic.jp/support/global/cs/dsc/download/index3.html>
(English only)

❖ ISO Sensitivity When [V-Log] Is Set

The lower limit of available ISO sensitivity is [640] (when [Extended ISO] is set: [320]), and the upper limit is [51200].

- The range of available ISO sensitivities is also different for [LOW] and [HIGH] in [Dual Native ISO Setting].
- Reset the exposure if necessary when ISO sensitivity changes.

❖ Exposure When [V-Log] Is Set

The [V-Log] curve characteristics comply with “V-Log/V-Gamut REFERENCE MANUAL Rev.1.0”. When set to [V-Log], the standard exposure when gray with a reflectance ratio of 18% is imaged is IRE 42%.

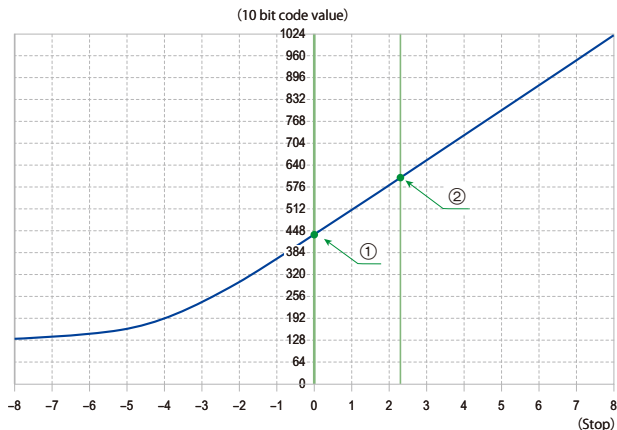

When [Photo Style] is set to [V-Log]

Reflectance ratio (%)	IRE (%)	Stop	10 bit code value	12 bit code value
0	7.3	—	128	512
① 18	42	0.0	433	1732
② 90	61	2.3	602	2408

- When luminance is to be displayed by Stop units, this camera calculates IRE 42% to 0 Stop.





- Luminance can be checked by Stop units:

[] → [] → [Luminance Spot Meter] (→ 292)

[] → [] → [Zebra Pattern] (→ 293)

[V-Log View Assist]

When [Photo Style] is set to [V-Log], the recording screen and images output via HDMI will darken. Using [V-Log View Assist] means you can show images with LUT data applied on the monitor/viewfinder and output them via HDMI.



 ⇒ [] ⇒ [] ⇒ Select [V-Log View Assist]

[Read LUT File]	Reads LUT data from the card.
[LUT Select]	Selects the LUT data to be applied from among the preset ([Vlog_709]) and registered LUT data.
[LUT View Assist (Monitor)]	Displays the images with LUT data applied on the monitor/viewfinder of the camera.
[LUT View Assist (HDMI)]	Applies LUT data to images output over HDMI.



- When applying the LUT data, [LUT] is displayed on the recording screen.
- Up to 4 LUT data files can be registered.



- You can register functions to Fn buttons:
 [] ⇒ [] ⇒ [Fn Button Set] ⇒ [Setting in REC mode] ⇒ [LUT View Assist (Monitor)]/[LUT View Assist (HDMI)]/[LUT Select] (→ [367](#))

❖ Reading LUT Files



- The following LUT data can be used:
 - The “.vlt” format, which meets the requirements specified in the “VARICAM 3DLUT REFERENCE MANUAL Rev.1.0”
 - File names consisting of up to 8 alphanumeric characters (excluding extension)
- Save the LUT data with a file extension of “.vlt” in the root directory of the card (the folder opened when the card is opened on a PC).

- 1 Insert a card on which LUT data is saved into the camera.
- 2 Select [Read LUT File].
 - ⇒ [] ⇒ [] ⇒ [V-Log View Assist] ⇒ [Read LUT File] ⇒ [Card Slot 1]/[Card Slot 2]
- 3 Press ▲▼ to select the LUT data to read and then press or .
- 4 Press ▲▼ to select the location to register the data, and then press or .
 - When registered items are selected, they will be overwritten.

HLG Videos

iA P A S M 



Record videos with the wide dynamic range of the HLG format. You can record in very bright light where overexposure can occur or in dark areas where underexposure can occur, maintaining the rich yet subtle colors you can see with your naked eye.



You can view the video that you record by outputting via HDMI to devices (TVs, etc.) that support the HLG format, or playing back directly on supporting devices.

- “HLG (Hybrid Log Gamma)” is an international standard (ITU-R BT.2100) HDR format.

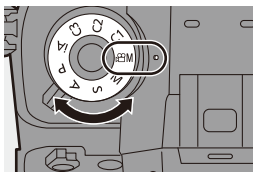
1 Set the mode dial to [M].



2 Set [Rec. File Format] to [MP4] or [MOV].

-  ⇒  ⇒  ⇒ [Rec. File Format] ⇒ [MP4]/[MOV]

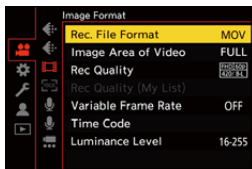

3 Select a recording quality with which you can record HLG video.

- **MENU/SET** → [] → [] → [Rec Quality]

- Items available for recording with HLG video are indicated as [HLG available].
- Recording qualities with which you can record HLG video: → 323

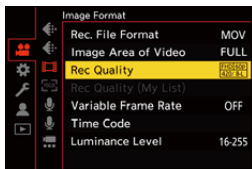

4 Set [Photo Style] to [Like2100(HLG)].

- **MENU/SET** → [] → [] → [Photo Style] → [Like2100(HLG)]

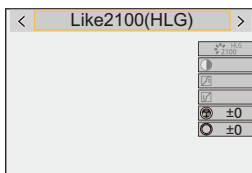

- When the [Rec. File Format] has been set to [MOV], you can display just the recording qualities where HLG video recording can be used. (→ 264)
- The monitor and viewfinder on this camera do not support display of HLG format images.
With [Monitor] in [HLG View Assist] in the [Custom] ([Monitor / Display (Video)]) menu, you can display the images converted for monitoring on the monitor/viewfinder of this camera. (→ 314)



- HLG images are shown dark on devices that do not support the HLG format.
With [HDMI] in [HLG View Assist] in the [Custom] ([Monitor / Display (Video)]) menu, you can set the conversion method for images displayed for monitoring. (→ 314)

❖ ISO Sensitivity When [Like2100(HLG)] Is Set

The lower limit of available ISO sensitivities will become [400].

- The range of available ISO sensitivities is also different for [LOW] and [HIGH] in [Dual Native ISO Setting].
- Reset the exposure if necessary when ISO sensitivity changes.

[HLG View Assist]

At recording or playback of [HLG Photo] and HLG video, this displays images with converted color gamut and brightness on the camera monitor/viewfinder, or outputs these over HDMI.



 →  →  → [HLG View Assist] → [Monitor] or [HDMI]

[AUTO]*	Converts images before outputting them via HDMI while applying the effect of [MODE2]. This conversion setting works only when the camera is connected to a device that does not support HDR (HLG format).
[MODE1]	Converts with an emphasis on bright areas such as sky. <ul style="list-style-type: none"> • [MODE1] is displayed on the recording screen.
[MODE2]	Converts with an emphasis on the brightness of a main subject. <ul style="list-style-type: none"> • [MODE2] is displayed on the recording screen.
[OFF]	Displays without converting color gamut and brightness. <ul style="list-style-type: none"> • HLG images appear darker on devices that do not support the HLG format.

* Can only be set while [HDMI] is selected.



- You can register functions to Fn buttons:

[] → [] → [Fn Button Set] → [Setting in REC mode] → [HLG View Assist (Monitor)]/[HLG View Assist (HDMI)] (→ [367](#))

Anamorphic Recording

iA P A S M 



This camera can record video with a resolution of 4K-A (anamorphic (4:3) video) that is compatible with anamorphic recording with an aspect ratio of 4:3. It can also record video with an aspect ratio of 3:2 that has 6K resolution or 5.4K resolution. You can select a recording quality that suits anamorphic recording from a variety of different video formats (recording qualities).

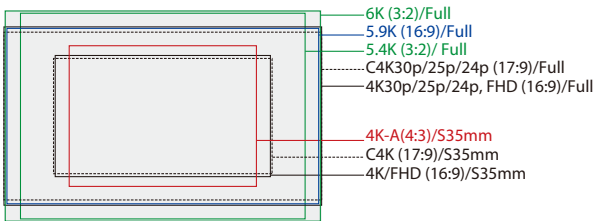

- The above shows some of the recording qualities available when a full-frame lens is attached. Refer to page [255](#) for details about recording quality.

During anamorphic recording, it is also possible to display de-squeezed images and the angle of view when cropping after de-squeeze editing. It is also possible to switch to an image stabilizer that suits anamorphic recording.

- Refer to page [182](#) for information about image stabilizers suited to anamorphic recording.



- When [Rec. File Format] is set to [MOV], by filtering [Rec Quality] by the number of pixels, you can display just those recording qualities with resolutions and aspect ratios that meet the conditions. For details, refer to page 264.

- Anamorphic (4:3) video is displayed as [ANAMOR] in the [Rec Quality] setting screen.

Filtering Options	ANY
Frame Rate	6K(3:2)
Resolution	5.9K(16:9)
Codec	5.4K(3:2)
Variable Frame Rate	4K-A(4:3)
Hybrid Log Gamma	C4K(17:9)
	4K(16:9)
	FHD(16:9)

42 results



- This camera is not compatible with de-squeeze editing of video recorded with anamorphic recording. Use compatible software.



- Recording qualities for anamorphic recording with an aspect ratio of 4:3:
→ 323

[Anamorphic Desqueeze Display]



Display the desqueezed images suited to the magnification of the anamorphic lens on this camera.



Using the [Video Frame Marker], it is also possible to impose on display the frame of the angle of view when cropping after de-squeeze editing.

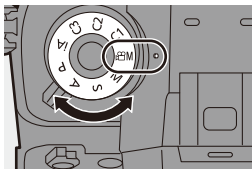

1 Set the mode dial to [M].







2 Set [Anamorphic Desqueeze Display].



-  ⇒ [] ⇒ [] ⇒ [Anamorphic Desqueeze Display]

Settings: [] [] ([2.0×])/

[] [] ([1.8×])/

[] [] ([1.5×])/



[] [] ([1.33×])/

[] [] ([1.30×])/[OFF]

- Make settings to suit the magnification of the anamorphic lens you are using.



3 Set [Video Frame Marker].

-  ⇒ [] ⇒ [] ⇒ [Video Frame Marker]

- For details, refer to page [295](#).

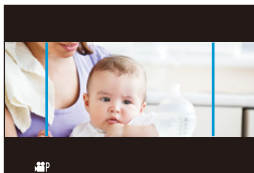

- Images output via HDMI are not de-squeezed.



- You can register functions to Fn buttons:

[] ⇒ [] ⇒ [Fn Button Set] ⇒ [Setting in REC mode] ⇒ [Anamorphic Desqueeze Display] (→ [367](#))

[Synchro Scan]

iA P A S M 



Fine-adjust the shutter speed to reduce flickering and horizontal stripes. The shutter speed set in Synchro Scan is saved separately from the shutter speed used for normal recording.

In the Synchro Scan setting screen you can call up the current shutter speed for normal recording and adjust it.

1 Set the mode dial to [M].

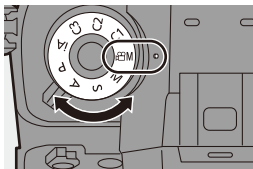

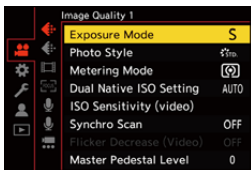

2 Set the exposure mode to [S] or [M].

-  →  →  →
 [Exposure Mode] → [S]/[M]





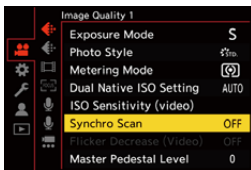

3 Set [Synchro Scan].

-  →  →  →
 [Synchro Scan] → [ON]



4 Set the shutter speed.



- Rotate ,  or  to select a numeric value, then press  or .

- You can call up the current shutter speed for normal recording by pressing [DISP].
- Adjust the shutter speed while looking at the screen so that flickering and horizontal stripes will be minimized.



- When you set [Synchro Scan] to [ON], the available shutter speed range becomes narrower.



- You can register functions to Fn buttons:
 [] ⇒ [] ⇒ [Fn Button Set] ⇒ [Setting in REC mode] ⇒ [Synchro Scan]
 (→ 367)

[Loop Recording (video)]



iA P A S M 

Even when recording uses up the card's free space, the camera continues the recording by deleting the oldest segment of the recorded data.

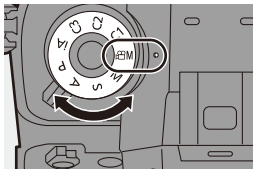
1 Set the mode dial to [M].



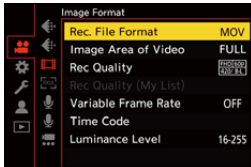

2 Set [Rec. File Format] to [MOV].

-  ⇒  ⇒  ⇒ [Rec. File Format] ⇒ [MOV]



3 Set [Loop Recording (video)].

-  ⇒  ⇒  ⇒ [Loop Recording (video)] ⇒ [ON]

-  is displayed on the recording screen.
- When the recording fills the card to capacity, loop recording starts and video recording time is no longer displayed.





- Make sure the camera does not turn off during recording.
- Loop recording cannot start if there is insufficient available capacity on the card.
- When the recording time exceeds 12 hours, recording continues with data being deleted in order from the point where recording started.
- When the following functions are being used, [Loop Recording (video)] is not available:
 - [Rec Quality] with a bit rate of 400 Mbps
 - [Variable Frame Rate]
 - [Live Cropping]



[Segmented File Recording]

iA P A S M 

To avoid video loss due to unforeseen interruptions to the power supply, recorded video is divided every minute while MOV video is being recorded.

- The divided videos are saved as one group image.

1 Set [Rec. File Format] to [MOV].

-  ⇒  ⇒  ⇒ [Rec. File Format] ⇒ [MOV]

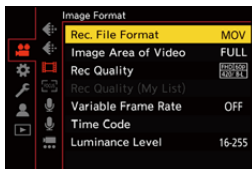

2 Set [Segmented File Recording].

-  ⇒  ⇒  ⇒ [Segmented File Recording] ⇒ [ON]



- When the following function is being used, [Segmented File Recording] is not available:
 - [Loop Recording (video)]

List of Recording Qualities That Enable Special Videos to be Recorded

VFR : Recording qualities that enable use of [Variable Frame Rate]

HFR : Recording qualities for High Frame Rate video

Live Crop : Recording qualities that enable use of [Live Cropping]

HLG : Recording qualities with which you can record HLG video

ANAMOR 4:3 : Recording qualities for anamorphic recording with an aspect ratio of 4:3

❖ [Rec. File Format]: [AVCHD]

[System Frequency]	[Rec Quality]	VFR	HFR	Live Crop	HLG	ANAMOR 4:3
[59.94Hz (NTSC)]	[FHD/28M/60p]					
	[FHD/17M/60i]					
	[FHD/24M/30p]	✓				
	[FHD/24M/24p]	✓				
[50.00Hz (PAL)]	[FHD/28M/50p]					
	[FHD/17M/50i]					
	[FHD/24M/25p]	✓				

❖ [Rec. File Format]: [MP4]

[System Frequency]	[Rec Quality]	VFR	HFR	Live Crop	HLG	ANAMOR 4:3
[59.94Hz (NTSC)]	[4K/10bit/100M/60p]				✓	
	[4K/8bit/100M/30p]					
	[4K/10bit/72M/30p]				✓	
	[4K/8bit/100M/24p]					
	[4K/10bit/72M/24p]				✓	
	[FHD/8bit/28M/60p]			✓		
	[FHD/8bit/24M/24p]					
	[FHD/8bit/20M/30p]			✓		
[50.00Hz (PAL)]	[4K/10bit/100M/50p]				✓	
	[4K/8bit/100M/25p]					
	[4K/10bit/72M/25p]				✓	
	[FHD/8bit/28M/50p]			✓		
	[FHD/8bit/20M/25p]			✓		

❖ [Rec. File Format]: [MOV]

[System Frequency]	[Rec Quality]	VFR	HFR	Live Crop	HLG	ANAMOR 4:3
[59.94Hz (NTSC)]	[6K/24p/420/10-L]				✓	
	[5.9K/30p/420/10-L]				✓	
	[5.9K/24p/420/10-L]				✓	
	[5.4K/30p/420/10-L]				✓	
	[4K-A/48p/420/10-L]		✓		✓	✓
	[4K-A/30p/422/10-I]				✓	✓
	[4K-A/30p/422/10-L]				✓	✓
	[4K-A/30p/420/8-L]	✓				✓
	[4K-A/24p/422/10-I]				✓	✓
	[4K-A/24p/422/10-L]				✓	✓
	[4K-A/24p/420/8-L]	✓				✓
	[C4K/60p/420/10-L]				✓	
	[C4K/60p/420/8-L]					
	[C4K/48p/420/10-L]		✓		✓	
	[C4K/30p/422/10-I]				✓	
	[C4K/30p/422/10-L]				✓	
	[C4K/30p/420/8-L]	✓				
	[C4K/24p/422/10-I]				✓	
	[C4K/24p/422/10-L]				✓	
	[C4K/24p/420/8-L]	✓				

[System Frequency]	[Rec Quality]	VFR	HFR	Live Crop	HLG	ANAMOR 4:3
[59.94Hz (NTSC)]	[4K/60p/420/10-L]				✓	
	[4K/60p/420/8-L]					
	[4K/48p/420/10-L]		✓		✓	
	[4K/30p/422/10-I]				✓	
	[4K/30p/422/10-L]				✓	
	[4K/30p/420/8-L]	✓				
	[4K/24p/422/10-I]				✓	
	[4K/24p/422/10-L]				✓	
	[4K/24p/420/8-L]	✓				
	[FHD/120p/420/10-L]		✓		✓	
	[FHD/60p/422/10-I]				✓	
	[FHD/60p/422/10-L]				✓	
	[FHD/60p/420/8-L]	✓		✓		
	[FHD/60i/422/10-I]				✓	
	[FHD/60i/422/10-L]				✓	
	[FHD/48p/420/10-L]		✓		✓	
	[FHD/30p/422/10-I]				✓	✓
	[FHD/30p/422/10-L]				✓	✓
	[FHD/30p/420/8-L]	✓			✓	
	[FHD/24p/422/10-I]				✓	✓
[FHD/24p/422/10-L]				✓	✓	
[FHD/24p/420/8-L]	✓			✓		

[System Frequency]	[Rec Quality]	VFR	HFR	Live Crop	HLG	ANAMOR 4:3
[50.00Hz (PAL)]	[5.9K/25p/420/10-L]				✓	
	[5.4K/25p/420/10-L]				✓	
	[4K-A/50p/420/10-L]				✓	✓
	[4K-A/50p/420/8-L]					✓
	[4K-A/25p/422/10-I]				✓	✓
	[4K-A/25p/422/10-L]				✓	✓
	[4K-A/25p/420/8-L]	✓				✓
	[C4K/50p/420/10-L]				✓	
	[C4K/50p/420/8-L]					
	[C4K/25p/422/10-I]				✓	
	[C4K/25p/422/10-L]				✓	
	[C4K/25p/420/8-L]	✓				
	[4K/50p/420/10-L]				✓	
	[4K/50p/420/8-L]					
	[4K/25p/422/10-I]				✓	
	[4K/25p/422/10-L]				✓	
	[4K/25p/420/8-L]	✓				
	[FHD/100p/420/10-L]			✓		✓
	[FHD/50p/422/10-I]					✓
	[FHD/50p/422/10-L]					✓
	[FHD/50p/420/8-L]	✓		✓		
	[FHD/50i/422/10-I]					✓
	[FHD/50i/422/10-L]					✓
	[FHD/25p/422/10-I]				✓	✓
	[FHD/25p/422/10-L]				✓	✓
	[FHD/25p/420/8-L]	✓			✓	

[System Frequency]	[Rec Quality]	VFR	HFR	Live Crop	HLG	ANAMOR 4:3
[24.00Hz (CINEMA)]	[6K/24p/420/10-L]				✓	
	[5.9K/24p/420/10-L]				✓	
	[4K-A/48p/420/10-L]		✓		✓	✓
	[4K-A/24p/422/10-I]				✓	✓
	[4K-A/24p/422/10-L]				✓	✓
	[4K-A/24p/420/8-L]	✓				✓
	[C4K/48p/420/10-L]		✓		✓	
	[C4K/24p/422/10-I]				✓	
	[C4K/24p/422/10-L]				✓	
	[C4K/24p/420/8-L]	✓				
	[4K/48p/420/10-L]		✓		✓	
	[4K/24p/422/10-I]				✓	
	[4K/24p/422/10-L]				✓	
	[4K/24p/420/8-L]	✓				
	[FHD/48p/420/10-L]		✓		✓	
	[FHD/24p/422/10-I]				✓	✓
	[FHD/24p/422/10-L]				✓	✓
	[FHD/24p/420/8-L]	✓			✓	

12. Connections with External Devices (Video)

HDMI Devices (HDMI Output)

iA P A S M



You can record while outputting the camera images to an external monitor or external recorder connected with an HDMI cable.

- HDMI output control differs between during recording and during playback. Refer to page 451 for HDMI output settings during playback.

Getting started:

- Turn off the camera and the external monitor/external recorder.

Connect the camera and an external monitor or external recorder with a commercially available HDMI cable.

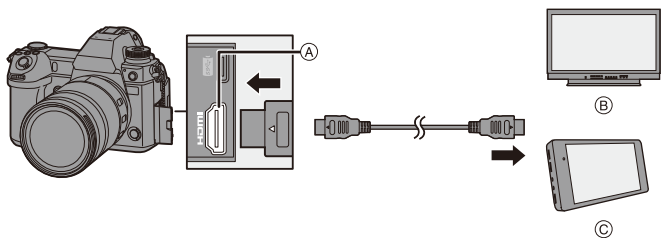

Ⓐ [HDMI] socket (Type A)

Ⓒ External recorder

Ⓑ External monitor

- Check the direction of the terminals and plug in/out straight holding onto the plug. (Inserting at an angle can deform the terminal and cause malfunction.)
- Do not connect the cable to the wrong terminals. This may cause a malfunction.



- Use a “High Speed HDMI cable” with the HDMI logo.
Cables that do not comply with the HDMI standards will not work.
“High Speed HDMI cable” (Type A–Type A plug, up to 1.5 m (4.9 feet) long)

Attaching the Cable Holder

Use of the supplied cable holder prevents detachment of the cable and damage to the terminals.

- Put the camera on a stable surface to perform this task.

- 1 While pushing (A), slide the clamp portion (B) of the cable holder to remove it.

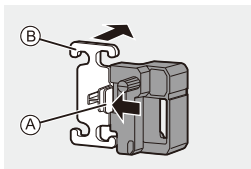

- 2 Open the door of the terminal section and slide the door into the part marked (C).

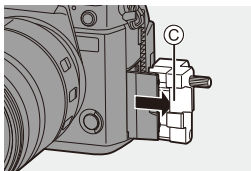

- 3 Loosely mount the cable holder to the mount on the camera, and then rotate the screws in the direction of the arrows to secure the cable holder. (D)

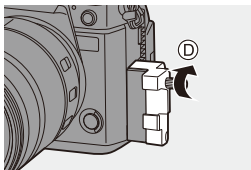

- 4 Fit the USB connection cable (C–C or A–C) (E) and HDMI cable (F) to the clamp.

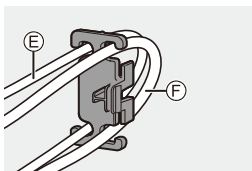

- 5 Slide the clamp portion (G) to attach it to the cable holder.

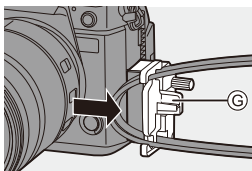

- 6 Connect the USB connection cable (C–C or A–C) to the USB port (H).

- 7 Connect the HDMI cable to the [HDMI] socket (I).

- J Leave some slack so that this section has a length of at least 10 cm (0.33 feet).

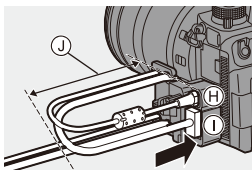

Removing the cable holder

To remove the cable holder, follow the steps for attaching it in the reverse order.

❖ Adjusting the Monitor Angle

You can adjust the angle of the monitor while it is tilted (→ 55) by rotating it, without interfering with the connection cables.

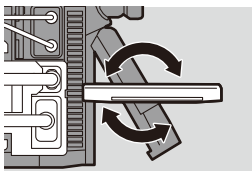

- Do not use any other USB connection cables except the supplied USB connection cables (C–C and A–C).
- We recommend using an HDMI cable with a thickness diameter of 6.5 mm (0.26 inch) or less.
- It may not be possible to attach HDMI cables of certain shapes.

Images Output via HDMI

The images output via HDMI differ depending on the recording mode.

❖ [pIM] Mode

Aspect ratio, resolution, and frame rate output is according to the [Rec Quality] settings in the [Video] ([Image Format]) menu. Resolution and frame rate can be down-converted for output according to the application.

YUV 4:2:2 is used for YUV and bit value output, as shown on the right.

Recording to card	HDMI output
4:2:2 10-bit	4:2:2 10-bit
4:2:0 10-bit	4:2:2 10-bit
4:2:0 8-bit	4:2:2 8-bit

Resolution, frame rate

Resolution and frame rate output is according to the following menu combinations:

- [Rec Quality] in the [Video] ([Image Format]) menu.
- [Down Convert] in [HDMI Rec Output] in the [Custom] ([IN/OUT]) menu.
- 6K, 5.9K, and 5.4K videos are output with a 4K or FHD resolution. Output is not possible during recording.
- Anamorphic (4:3) video is output with a 4K or FHD resolution.
- When set to a recording quality for high frame rate video, the frame rate is down-converted for output.
- For details, refer to “Image Quality When Outputting via HDMI” on pages 335 to 337.



- When set to a 4:3 or 3:2 [Rec Quality], bands are added to the images and they are output with a 16:9 aspect ratio.
- Output may be in 8-bit if you output to devices that do not support 10-bit.

❖ [iA]/[P]/[A]/[S]/[M] Mode

Output is the same as [iM] mode during video recording or when [Video-Priority Display] is set to [ON].

Output is with a 16:9 aspect ratio during recording standby. Resolution, frame rate, YUV, and bit value output matches the connected device.



- When set to any [Aspect Ratio] other than 16:9, bands are added to the images and they are output with a 16:9 aspect ratio.



❖ Notice Regarding HDMI Output

- It may take some time for the output method to change.
- When you use the HDMI output during recording, the image may be displayed with a time lag.
- Beep sounds, AF beep, and electronic shutter sounds are muted during HDMI output.
- When you check the image and audio from the TV connected to the camera, the microphone of the camera may pick up the sound from the speakers of the TV, producing an abnormal sound (audio feedback).
If this occurs, move the camera away from the TV or lower the volume on the TV.
- Certain setting screens are not output via HDMI.
- There is no output via HDMI while you are using the following functions:
 - [6K/4K PHOTO]/[Post-Focus]

HDMI Output Image Quality (Resolution/Frame Rate)

Settings for Down-Converting

Make settings for the down-conversion of resolution and frame rate for HDMI output in the [pMM] mode.

 → [⚙️] → [] → [HDMI Rec Output] → Select [Down Convert]

[AUTO]	Outputs by down-converting to match the connected device.
[4K/30p] ([4K/25p])	Outputs by down-converting resolution to 4K and frame rate to either 29.97p or 25.00p.
[1080p]	Down-converts resolution to FHD (1080), and outputs as progressive.
[1080i]	Down-converts resolution to FHD (1080), and outputs as interlaced.
[OFF]	Outputs at the resolution and recording frame rate of the [Rec Quality].

-  • The items you can select depend on the [System Frequency] setting.
- 6K, 5.9K, and 5.4K videos are output with a 4K or FHD resolution. (→ 335)
Output is not possible during recording.
- Anamorphic (4:3) video is output with a 4K or FHD resolution. (→ 335)
- When set to a recording quality for high frame rate video, the frame rate is down-converted for output. (→ 335)
- If down-converting, AF may take longer than usual for focusing, and the performance of continuous focus tracking may deteriorate.

❖ Image Quality When Outputting via HDMI

Output is with the resolution and frame rate according to the combinations of the [Rec Quality] and [Down Convert] settings.

- When [Down Convert] is set to [AUTO], the output matches the connected device.
- There is no HDMI output when setting combinations result in a [—] in the below tables.

[System Frequency]: [59.94Hz (NTSC)]

[Down Convert]	Resolution and recording frame rate of the [Rec Quality]			
	6K/23.98p 5.9K/23.98p 4K-A/47.95p 4K-A/23.98p 4K/47.95p 4K/23.98p	5.9K/29.97p 5.4K/29.97p 4K-A/29.97p 4K/29.97p	C4K/59.94p	C4K/47.95p C4K/23.98p
[4K/30p]	—	4K/29.97p	4K/29.97p	—
[1080p]	1080/23.98p	1080/29.97p* ¹	1080/59.94p	1080/23.98p
[1080i]	—	1080/59.94i	1080/59.94i	—
[OFF]	4K/23.98p	4K/29.97p	C4K/59.94p	C4K/23.98p

[Down Convert]	Resolution and recording frame rate of the [Rec Quality]		
	C4K/29.97p	4K/59.94p	1080/119.88p 1080/59.94p
[4K/30p]	4K/29.97p	4K/29.97p	—
[1080p]	1080/29.97p* ¹	1080/59.94p	1080/59.94p
[1080i]	1080/59.94i	1080/59.94i	1080/59.94i
[OFF]	C4K/29.97p	4K/59.94p	1080/59.94p

[Down Convert]	Resolution and recording frame rate of the [Rec Quality]		
	1080/59.94i	1080/47.95p 1080/23.98p	1080/29.97p
[4K/30p]	—	—	—
[1080p]	—	1080/23.98p	1080/29.97p* ¹
[1080i]	1080/59.94i	—	1080/59.94i
[OFF]	1080/59.94i	1080/23.98p	1080/29.97p

*¹ Output is 1080/59.94p if the connected device is not compatible.

[System Frequency]: [50.00Hz (PAL)]

[Down Convert]	Resolution and recording frame rate of the [Rec Quality]			
		5.9K/25.00p 5.4K/25.00p 4K-A/25.00p 4K/25.00p	4K-A/50.00p 4K/50.00p	C4K/50.00p
[4K/25p]	4K/25.00p	4K/25.00p	4K/25.00p	4K/25.00p
[1080p]	1080/25.00p*2	1080/50.00p	1080/50.00p	1080/25.00p*2
[1080i]	1080/50.00i	1080/50.00i	1080/50.00i	1080/50.00i
[OFF]	4K/25.00p	4K/50.00p	C4K/50.00p	C4K/25.00p

[Down Convert]	Resolution and recording frame rate of the [Rec Quality]		
		1080/100.00p 1080/50.00p	1080/50.00i
[4K/25p]	—	—	—
[1080p]	1080/50.00p	—	1080/25.00p*2
[1080i]	1080/50.00i	1080/50.00i	1080/50.00i
[OFF]	1080/50.00p	1080/50.00i	1080/25.00p

*2 Output is 1080/50.00p if the connected device is not compatible.

[System Frequency]: [24.00Hz (CINEMA)]

[Down Convert]	Resolution and recording frame rate of the [Rec Quality]		
		6K/24.00p 5.9K/24.00p 4K-A/48.00p 4K-A/24.00p 4K/48.00p 4K/24.00p	C4K/48.00p C4K/24.00p
[1080p]	1080/24.00p	1080/24.00p	1080/24.00p
[OFF]	4K/24.00p	C4K/24.00p	1080/24.00p



HDMI Output Settings

iA P A S M 





Outputting the Camera Information Display via HDMI

Output the camera information display to an external device connected by HDMI.

 ⇒ [] ⇒ [] ⇒ [HDMI Rec Output] ⇒ Select [Info Display]
Settings: [ON]/[OFF]

Outputting Control Information to an External Recorder



Recording start and stop control information is output to an external recorder connected by HDMI.

 ⇒ [] ⇒ [] ⇒ [HDMI Rec Output] ⇒ Select [HDMI Recording Control]
Settings: [ON]/[OFF]

- [HDMI Recording Control] can be set when [HDMI Time Code Output] is set to [ON] in [] Mode.
- Control information is output when pressing the video rec. button or shutter button, even if the video cannot be recorded (such as when there is no card inserted into the camera).
- Only compatible external devices can be controlled.

Outputting Down-converted Audio to an HDMI Device



When an XLR Microphone Adaptor (DMW-XLR1: optional) is attached, audio is down-converted to a format suitable for the connected HDMI external device before being output.

 ⇒ [] ⇒ [] ⇒ [HDMI Rec Output] ⇒ Select [Sound Down Convert]

[AUTO]	Output is down-converted to match the connected device.
[OFF]	Output is according to the settings in [XLR Mic Adaptor Setting].

Outputting Audio via HDMI

Output audio to an external device connected by HDMI.

 ⇒ [] ⇒ [] ⇒ [HDMI Rec Output] ⇒ Select [Sound Output (HDMI)]

Settings: [ON]/[OFF]

External Microphones (Optional)

iA P A S M 





With a Stereo Shotgun Microphone (DMW-MS2: optional) or Stereo Microphone (VW-VMS10: optional), you can record higher-quality audio compared to the built-in microphone.

1 Set the [Mic Socket] that suits the device to be connected.

-  ⇒  ⇒  ⇒ [Mic Socket]

MIC 	[Mic Input (Plug-in Power)]	When connecting an external microphone that requires a power supply from the camera [MIC] socket.
MIC	[Mic Input]	When connecting an external microphone that does not require a power supply from the camera [MIC] socket.
LINE	[Line Input]	When connecting an external audio device for line output.

- The setting will be fixed to **[MIC**  when a Stereo Shotgun Microphone (DMW-MS2: optional) is connected.
- When using **[MIC** , if you connect an external microphone that does not require power supply, the connected external microphone may malfunction. Check the device before connecting.

2 Set the camera on/off switch to [OFF].

3 Connect the camera and external microphone.

- If mounting the external microphone on the camera hot shoe (A), remove the hot shoe cover. (→ 228)

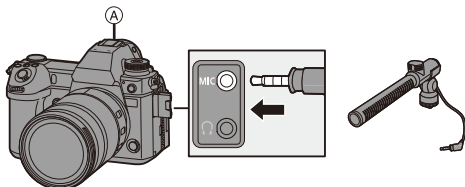

- Do not use the stereo microphone cables with the length of 3 m (9.8 feet) or more.

❖ Setting the Sound Pickup Range (DMW-MS2: Optional)

When using the Stereo Shotgun Microphone (DMW-MS2: optional), you can set the microphone sound pickup range.

1 Select [Special Mic.].

- → → → [Special Mic.]



[STEREO]	Picks up sound over a wide area.
[LENS AUTO]	Picks up sound from a range automatically set by the lens angle of view.
[SHOTGUN]	Helps prevent picking up background noise, and records sound from a specific direction.
[S.SHOTGUN]	Narrows the sound pickup range more than with [SHOTGUN].
[MANUAL]	Sets the range manually for sound pickup.

2 (When [MANUAL] is selected)

Press ◀▶ to adjust the sound pickup range and then press or





- You can register the [MANUAL] sound pickup range setting in an Fn button:
[] ⇒ [] ⇒ [Fn Button Set] ⇒ [Setting in REC mode] ⇒ [Mic. Directivity Adjust] (→ [367](#))

❖ Reduction of Wind Noise

This reduces wind noise when an external microphone is connected.



⇒ [] ⇒ [] ⇒ Select [Wind Cut]

Settings: [HIGH]/[STANDARD]/[LOW]/[OFF]



- While the external microphone is connected, [EXT.MIC] is displayed on the screen.
- When an external microphone is connected, [Sound Rec Level Disp.] automatically turns [ON], and the recording level is displayed on the screen.
- When [Mute Sound Input] is set to [ON], the audio input from the external microphone is muted.
- When the external microphone is attached, do not carry the camera by holding the external microphone. It may become detached.
- If noises are recorded when using the AC adaptor, use the battery.
- When a Stereo Microphone (VW-VMS10: optional) is used, [Special Mic.] is fixed to [STEREO].
- Setting [Wind Cut] may alter the usual sound quality.
- For details, refer to the operating instructions for the external microphone.

XLR Microphone Adaptor (Optional)

iA P A S M 



By attaching an XLR Microphone Adaptor (DMW-XLR1: optional) to the camera, you can use a commercially available XLR microphone to enable the recording of superior-quality high-res/stereo audio.

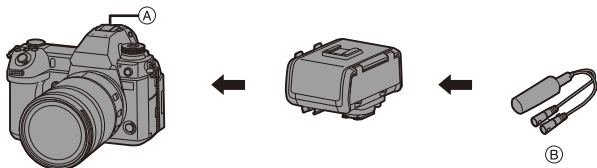

- Ⓐ Hot shoe
- Ⓑ Commercially available XLR microphone

Getting started:

- Turn off the camera, and remove the hot shoe cover. (→ 228)

- 1 Attach the XLR Microphone Adaptor to the hot shoe.**
- 2 Set the camera on/off switch to [ON].**
- 3 Select [XLR Mic Adaptor Setting].**

-  →  →  → [XLR Mic Adaptor Setting]

[96kHz/24bit]	Records high resolution audio at 96 kHz/24-bit.	Only available when [Rec. File Format] is set to [MOV].
[48kHz/24bit]	Records high-quality audio at 48 kHz/24-bit.	
[48kHz/16bit]	Records standard-quality audio at 48 kHz/16-bit.	
[OFF]	Records audio using the built-in microphone of the camera.	



- While an XLR Microphone Adaptor is attached, [XLR] is displayed on the screen.
- When [XLR Mic Adaptor Setting] is set to other than [OFF], the following settings are fixed:
 - [Sound Rec Level Limiter]: [OFF]
 - [Wind Noise Canceller]: [OFF]
 - [Sound Output]: [REC SOUND]
- [Sound Rec Level Adj.] cannot be used when [XLR Mic Adaptor Setting] is set to other than [OFF].
- When the XLR Microphone Adaptor is attached, [Sound Rec Gain Level] or [Sound Rec Level Disp.] automatically turns [ON], and the recording level is displayed on the screen.
- When [Mute Sound Input] is set to [ON], the audio input from the XLR Microphone Adaptor is muted.
- When the XLR Microphone Adaptor is attached, do not carry the camera by holding the XLR Microphone Adaptor. It may become detached.
- If noises are recorded when using the AC adaptor, use the battery.
- For details, refer to the operating instructions for the XLR Microphone Adaptor.

Headphones

iA P A S M



You can record videos while monitoring their sound by connecting commercially available headphones to the camera.

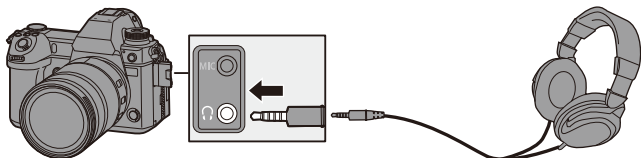

- Do not use the headphone cables with the length of 3 m (9.8 feet) or more.
- When headphones are connected, beep sounds, AF beep, and electronic shutter sounds are muted.

❖ Switching the Sound Output Method

MENU/SET → [] → [] → Select [Sound Output]

[REALTIME]	Audio without time lag. It may differ from the sound recorded in videos.
[REC SOUND]	Audio to be recorded in videos. Output sound may be delayed from actual sound.



- The setting is fixed to [REC SOUND] in the following cases:
 - During output of audio via HDMI
 - When [Special Mic.] is set to [LENS AUTO], [SHOTGUN], [S.SHOTGUN], or [MANUAL]
 - When using an XLR Microphone Adaptor (DMW-XLR1: optional)

❖ Adjusting the Headphone Volume

Connect the headphones and rotate .



: Reduces the volume.





: Increases the volume.

- You can also adjust the volume by touching []/[] on the playback screen.

To adjust the volume using the menu:

❶ Select [Headphone Volume].

-  ⇒ [] ⇒ [] ⇒ [Headphone Volume]

❷ Press   to adjust the headphone volume and then press  or .

- It can be adjusted in a range of [0] to [LEVEL15].

13. Playing Back and Editing of Images

This chapter explains how to play back and delete pictures and videos. It also explains editing using [RAW Processing] (→ 359) and [Video Divide] (→ 364).

- ➔ • For [Playback] menus other than [RAW Processing] and [Video Divide], refer to “[Playback] Menu” beginning on page 456.

Playing Back Pictures

1 Display the playback screen.

- Press [▶].

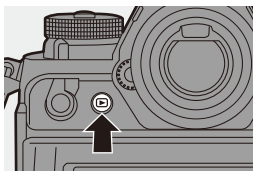

2 Select a picture.

(A) Card slot

- Select the pictures by pressing ◀▶.
- ◀: Move to the previous image
- ▶: Move to the next image
- You can move continuously through images by pressing and holding ◀▶.
- You can also select by rotating 🌞 or ⚙️.
- You can also move through images by dragging the screen horizontally. By leaving your finger touching the left or right edge of the screen after dragging to change the image, you can continuously move through images.



3 Stop playback.

- Press the shutter button halfway.
- You can also stop playback by pressing [▶].

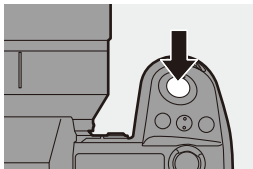



❖ Switching the Card to Display

Images are displayed separately by card slot.

You can switch the card displayed just by pressing the Fn button during playback.

- Use the Fn button registered with [Card Slot Change] to operate. In default settings, this is registered in [].

For information about the Fn button, refer to page 367.

- 1 Press [].
- 2 Press ▲▼ to select [Card Slot 1] or [Card Slot 2] and then press  or  .

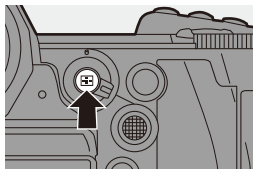

- This camera complies with the “Design rule for Camera File system” (DCF) and “Exchangeable Image File Format” (Exif) standards established by “Japan Electronics and Information Technology Industries Association” (JEITA). The camera cannot play back files that do not comply with the DCF standard. Exif is a file format for pictures which allows recording information, etc. to be added.
- Images recorded on devices other than this one may not be played back or edited correctly on this camera.

Playing Back Videos

1 Display the playback screen.

- Press [▶].

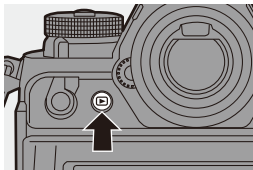

2 Select a video.

- For information about how to select images, refer to page 347.
- The [👤] video icon is displayed for a video.

(A) Video recording time

- The video recording time is displayed on the screen.

Example) When 8 minutes 30 seconds: 8m30s

- h: hour, m: minute, s: second

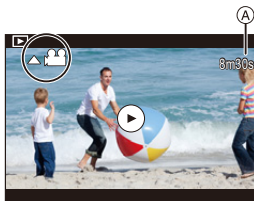

3 Play back the video.

- (B) Elapsed playback time
- (C) Playback bar



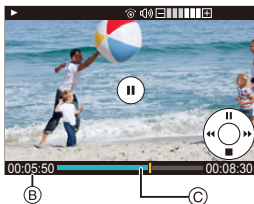



- Press ▲.
- You can also start playback by touching [▶] at the center of the screen.



4 Stop playback.

- Press ▼.

❖ Operations During Video Playback

Button operation	Touch operation	Description of operation
▲		Plays/pauses.
▼	—	Stops.
◀	—	Performs fast-rewind playback. <ul style="list-style-type: none"> If you press ◀ again, the fast-rewind speed increases.
		Performs frame-by-frame rewinding (while paused). <ul style="list-style-type: none"> When you press ◀ during playback of AVCHD video, rewinding at intervals of approx. 0.5 seconds is activated.
▶	—	Performs fast-forward playback. <ul style="list-style-type: none"> If you press ▶ again, the fast-forward speed increases.
		Performs frame-by-frame forwarding (while paused).
—		Selects the frame to display.
 / 	<input type="text" value="Save"/>	Extracts a picture (while paused). (→ 351)
	<input type="text" value="−"/>	Reduces the volume.
	<input data-bbox="308 957 347 999" type="text" value="+"/>	Increases the volume.

-  The camera can play back videos in AVCHD, MP4, and MOV formats.
- Some information (recording information, etc.) is not displayed for an AVCHD video.
- Video recorded with a [System Frequency] setting that is different to the current one cannot be played back.
- To play back videos on a PC, use the “PHOTOfunSTUDIO” software.

Extracting a Picture



Extract one frame of a video and save it as a JPEG image.

1 Pause playback at the position you wish to extract a picture.

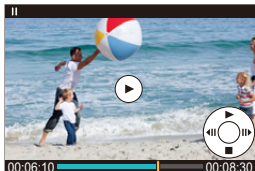
- Press ▲.
- To fine-adjust the position, press ◀▶ (rewind frame-by-frame or forward frame-by-frame).



2 Save the picture.

- Press  or .
- You can also save the picture by touching [Save].



- The picture created from the video is saved with a [FINE] picture quality. The picture is saved with a size according to the resolution of the [Rec Quality].
- The image quality of a picture created from a video may be coarser than normal.
-  is displayed on the detailed information display screen for a picture created from a video.

Switching the Display Mode



You can use features to do things like enlarge recorded images for display and switch to thumbnail display to display multiple images at once (multi-playback).

You can also switch to calendar display to show images of a selected recording date.

Enlarged Display



Playback images can be displayed enlarged (Playback Zoom).

Enlarging the playback screen.

- Rotate  to the right.
- The playback screen is enlarged in the order of 2× ⇨ 4× ⇨ 8× ⇨ 16×.
- Rotating  to the left returns to the previous display size.
- Pictures taken with [Picture Quality] set to [RAW] cannot be displayed enlarged at 16×.
- You cannot enlarge the edges of images recorded using [High Resolution Mode].



❖ Operations During Enlarged Display

Button operation	Touch operation	Description of operation
	—	Enlarges/reduces the screen.
—	Pinch out/ pinch in	Enlarges/reduces the screen in small steps.
	Drag	Moves the enlarged display position. Positions can be moved to the diagonal directions using the joystick.
	—	Forwards or rewinds images while maintaining the same zoom magnification and zoom position.



- You can display the point focused with AF. You can enlarge the display from that point:



[] ⇒ [] ⇒ [Magnify from AF Point] (→ [458](#))

Thumbnail Screen

1 Switch to thumbnail display.

- Rotate  to the left.
- The display is switched in the order of 12-image screen \rightarrow 30-image screen.

(A) Card

- An orange frame is shown around the selected image.
- Rotating  to the left during 30-image screen display switches to calendar display. (\rightarrow 355)
- Rotating  to the right returns to the previous display.
- You can also switch the display by touching an icon.

[]: 1-image screen

[]: 12-image screen

[]: 30-image screen

[]: Calendar (\rightarrow 355)



2 Select an image.

- Press \blacktriangle \blacktriangledown \blacktriangleleft \blacktriangleright to select an image and then press  or .

❖ Switching the Card to Display

Images are displayed separately by card slot.

To switch the card to display, press [] during thumbnail display.



- You can scroll the screen by dragging the thumbnail display up or down.



- Images indicated with [] cannot be played back.

Calendar Playback







1 Switch to calendar playback.

- Rotate  to the left.
- The display is switched in the order of thumbnail screen (12 images)
 - ⇒ Thumbnail screen (30 images)
 - ⇒ Calendar playback.









- Rotating  to the right returns to the previous display.

2 Select the recording date.

- Press     to select a date and then press  or .
- The selected date is displayed in orange.

3 Select an image.

- Press     to select an image and then press  or .
- Rotating  to the left returns to calendar playback.



- The card to display cannot be switched during calendar display.
- The recording date of the image selected in the playback screen becomes the date selected when the calendar screen is first displayed.
- The range that the calendar can be displayed is January 2000 to December 2099.





Group Images

Images recorded with Time Lapse Shot or Stop Motion Shooting are handled as group images in the camera, and can be deleted and edited on a group basis.

(For example, if you delete a group image, all images in the group are deleted.)

You can also delete and edit each image in a group individually.

❖ Images Handled as Group Images by the Camera

	Group images saved with [6K/4K PHOTO Bulk Saving].
	Group images recorded with Focus Bracket.
	Group images recorded with Time Lapse Shot.
	Group images recorded with Stop Motion Shooting.
	Group images recorded with [Segmented File Recording].



❖ Playing and Editing the Images in a Group One by One



Operations such as displaying thumbnails and deleting images are available with images in groups just as with normal playback.

- ❶ Select the group image in the playback state. (→ 347)
- ❷ Press ▼ to display the images in the group.
 - You can also perform the same operation by touching the group image icon.
- ❸ Press ◀▶ to select an image.
 - To return to the normal playback screen, press ▼ or touch [

Deleting Images





-  • Images cannot be restored once they have been deleted. Carefully confirm the images before deletion.
- You can only delete the images in the card of the selected card slot.
- If you delete a group image, all images in the group are deleted.

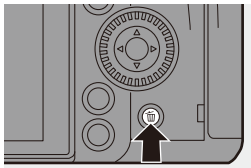





❖ [Delete Single]

- 1 Press  in playback state.
- 2 Press  to select [Delete Single] and then press  or .



❖ [Delete Multi]/[Delete All]

- 1 Press  in playback state.
- 2 Press  to select the deletion method and then press  or .

[Delete Multi]	<p>Selecting and deleting multiple images.</p> <ol style="list-style-type: none"> 1 Press  to select the image to delete and then press  or . <ul style="list-style-type: none"> •  is displayed for the selected image. • If you press  or  again, the selection is canceled. • Up to 100 images can be selected. 2 Press [DISP.] to delete the selected image.
[Delete All]	<p>Deleting all images in a card.</p> <ul style="list-style-type: none"> • If you select [Delete All], all images in the card are deleted. • If you select [Delete All Non-rating], all images except those with a rating set are deleted.







- To switch the card selected for deleting images, press [] and then select the card slot.



- Depending on the number of images to be deleted, it may take some time to delete them.
- [Delete All] can be used when [Playback Mode] is set to [Normal Play].



- You can register functions to Fn buttons:
[] ⇒ [] ⇒ [Fn Button Set] ⇒ [Setting in PLAY mode] ⇒ [Delete Single] (→ 367)
- You can set which of [Yes] and [No] is selected initially in the confirmation screen when deleting:
[] ⇒ [] ⇒ [Delete Confirmation] (→ 463)

[RAW Processing]

This processes pictures taken in RAW format on the camera and saves them in JPEG format.

You can also save images recorded with [HLG Photo] in the RAW format as HLG format.

1 Select [RAW Processing].

- Press **MENU/SET** → [▶] → [🖼️] → [RAW Processing]



2 Select the RAW image.

- Press ◀▶ to select an image and then press **MENU/SET** or 🔄.
- When group images are selected, press ▲ and then select an image in the group. Press ▲ again to return to the normal selection screen.
- The settings from the time of recording are reflected in displayed images.



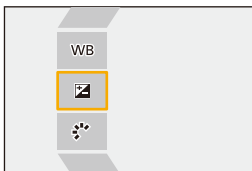

3 Select a setting item.

- Press ▲▼ to select an item and then press **MENU/SET** or 🔄.



4 Change the setting.



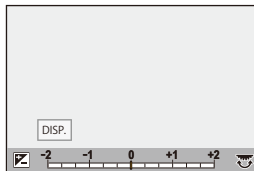

- Rotate , , or .
- The image can be enlarged/reduced by pinching out/pinching in the screen.



5 Confirm the setting.

- Press  or .
- The screen of Step 3 reappears.
To set another item, repeat Steps 3 to 5.

6 Save the image.

- Press   to select [Begin Processing] and then press  or .

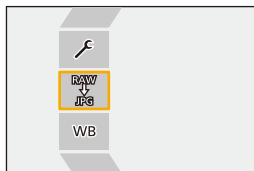

❖ Setting Items ([RAW Processing])

[Begin Processing]	Saves the image.
[White Balance]	<p>Selects and adjusts the white balance.</p> <p>Selecting the item with [📷] enables processing with the same setting as at the time of recording.</p> <ul style="list-style-type: none"> If you press ▼ in the [White Balance] selection screen, the white balance adjustment screen appears. If you press ▲ while [☀️] to [🌙] is selected, the color temperature setting screen appears.
[Brightness correction]	<p>Corrects the brightness.</p> <ul style="list-style-type: none"> The [Brightness correction] effect differs from the effect of exposure compensation during recording.
[Photo Style]	<p>Selects a Photo Style.</p> <ul style="list-style-type: none"> If you press [Q] while [Like709] is selected, the knee setting screen appears. (→ 280) You cannot select a Photo Style for images recorded with [V-Log]. You cannot select [V-Log] for images not recorded with [V-Log]. You cannot select a Photo Style other than [Cinelike D2] or [Cinelike V2] for images recorded with [Cinelike D2] or [Cinelike V2]. You cannot select [Cinelike D2] or [Cinelike V2] for images not recorded with Photo Style [Cinelike D2] or [Cinelike V2]. When you have selected [HLG] in [File Format] in [More Settings], only [Standard(HLG)] and [Monochrome(HLG)] are available for selection.
[i.Dynamic Range]*1	Selects the setting of [i.Dynamic Range].
[Contrast]*1	Adjusts the contrast.
[Highlight]*1	Adjusts the brightness of bright portions.
[Shadow]*1	Adjusts the brightness of dark portions.
[Saturation]*2/ [Color Tone]*3	Adjusts the saturation or color tone.
[Hue]*2	Adjusts the hue.
[Filter Effect]*3	Selects filter effects.
[Grain Effect]*4	Selects a grain effect setting.

[Noise Reduction]	Sets noise reduction.
[Sharpness]	Adjusts the sharpness.
[More Settings]	<p>[Revert To Original]: Returns the settings to the ones from the time of recording.</p> <p>[File Format]: Selects a file format from [JPG] or [HLG]. When you select [HLG], both JPEG format and HSP format pictures are saved. (Only images recorded with [HLG Photo])</p> <p>[Color Space]: Selects a Color Space setting from [sRGB] or [AdobeRGB]. (Only when [JPG] is selected in [File Format])</p> <p>[Picture Size]: Selects the size for storing images.</p> <p>[HLG View Assist (Monitor)]/[HLG View Assist (HDMI)]: The color gamut and brightness of images recorded with [HLG Photo] can be converted for display on the monitor/viewfinder of this camera, or displayed on an HDMI device. Refer to [HLG View Assist] in the [Custom] menu for details. (→ 314)</p> <ul style="list-style-type: none"> • [HLG View Assist (Monitor)] and [HLG View Assist (HDMI)] can only be selected when [HLG] is selected in [File Format].

- *1 Cannot be adjusted when [Like709] or [V-Log] is selected in [Photo Style], or if [HLG] is selected in [File Format] in [More Settings].
- *2 Available when items other than [Monochrome], [L.Monochrome], [L.Monochrome D], [V-Log], or [Monochrome(HLG)] are selected in [Photo Style].
- *3 Available when [Monochrome], [L.Monochrome], [L.Monochrome D], or [Monochrome(HLG)] is selected in [Photo Style].
- *4 Available when [Monochrome], [L.Monochrome], or [L.Monochrome D] is selected in [Photo Style].

❖ Displaying a Comparison Screen

You can change a setting while checking the effect by displaying images with the applied setting value side by side.

❶ Press [DISP.] in the screen of Step 4.

- The image with the current setting (A) is displayed at the center.
- Touching the image with the current setting enlarges it.
Touching [↩] returns to the original display.
- A comparison screen cannot be displayed while [Noise Reduction] or [Sharpness] is selected.

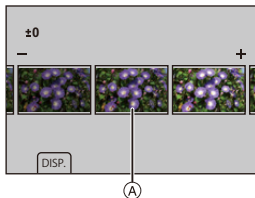

❷ Rotate , , or to change the setting.

❸ Press or to confirm the setting.





- RAW images recorded with the camera are always recorded in the [L] size of [3:2].

With this function, images are processed with the aspect ratio and the angle of view of [Ex. Tele Conv.] from the time of recording.

- The [White Balance] item is fixed to the setting from the time of recording for pictures recorded with multiple exposures.
- The results of RAW processing with this function and with the “SILKYPIX Developer Studio” software do not completely match.
- RAW processing cannot be performed on the following types of RAW images:
 - Images recorded with the [High Resolution Mode]
 - Images recorded with devices other than this camera



- You can register functions to Fn buttons:

[] ⇒ [] ⇒ [Fn Button Set] ⇒ [Setting in PLAY mode] ⇒ [RAW Processing] (→ 367)

[Video Divide]

Divide a recorded video or 6K/4K burst file into two.

- Images cannot be returned to their original state once they have been divided. Carefully confirm the images before performing the divide operation.
- Do not remove the card or battery from the camera during the divide process. The images may be lost.

1 Select [Video Divide].

- Press **MENU/SET** → [] → [] → [Video Divide]

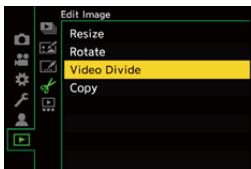

2 Select and play the image.

- Press ◀▶ to select an image and then press **MENU/SET** or .



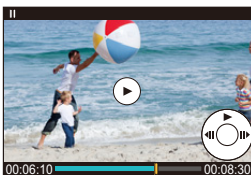

3 Pause playback at the position you wish to divide.

- Press ▲.
- To fine-adjust the position, press ◀▶ (frame-by-frame rewind or frame-by-frame forward).



4 Divide the video.

- Press  or .
- You can also divide the video by touching [Divide].



- Dividing the video at a point close to the start or end may not be possible.
- Videos with a short recording time cannot be divided.
- [Video Divide] cannot be used on images recorded using [Segmented File Recording].

14. Camera Customization

This chapter describes the customization function with which you can configure the camera to your preferred settings.

Change how buttons, dials, etc. on the camera are to be operated.



[Fn Button Set]

→ [367](#)



[Dial Operation Switch Setup]

→ [376](#)

Register the currently set information of the camera.

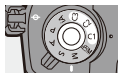

Custom mode

→ [383](#)

Change menu display items.

Quick menu

→ [378](#)

My Menu

→ [387](#)

Import camera settings information onto another camera.

[Save/Restore Camera Setting]

→ [389](#)



- Detailed settings for camera operations and screen display are available in the [Custom] menu. (→ [418](#))

Fn Buttons

You can register functions to the Fn (Function) buttons. Additionally, you can register other functions to specialized buttons such as [WB] button, in the same way as with the Fn buttons.

Different functions can be set for both during recording and playback.

❖ Fn Button Default Settings

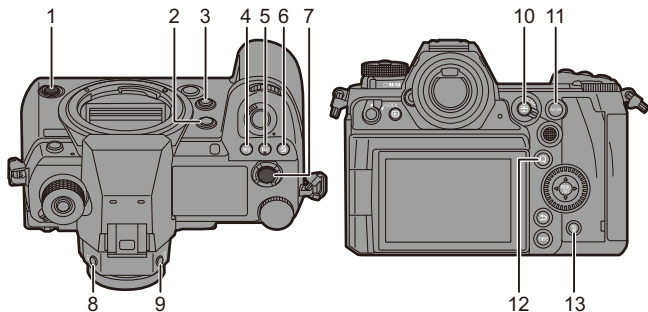

	Fn buttons	[Setting in REC mode]	[Setting in PLAY mode]
1	Sub video rec. button	[Video Record]	[Video Record]
2	[Fn1]	[Status-LCD Display(Video)]	[No Setting]
3	[Fn2]	[Preview]	[No Setting]
4	[WB]	[White Balance]	[No Setting]
5	[ISO]	[Sensitivity]	[No Setting]
6	[]	[Exposure Comp.]	[No Setting]
7	Video rec. button	[Video Record]	[Video Record]
8	[LVF]	[LVF/Monitor Switch]	[LVF/Monitor Switch]
9	[V.MODE]	[LVF Magnification]	[No Setting]
10	[]	[AF Mode]	[Card Slot Change]
11	[AF ON]	[AF-ON]	[Rating★3]
12	[Q]	[Q.MENU]	[Send Image (Smartphone)]
13	[]	[Level Gauge]	<ul style="list-style-type: none"> • Cannot be used as Fn buttons during playback.

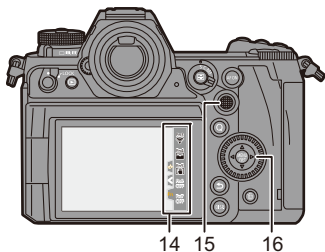



	Fn buttons	[Setting in REC mode]	[Setting in PLAY mode]
14	[Fn3]	[Wi-Fi]	
	[Fn4]	[Histogram]	
	[Fn5]	[Boost I.S. (Video)]	
	[Fn6]	[No Setting]	
	[Fn7]	[No Setting]	
15	 [Fn8] [Fn9] [Fn10] [Fn11] [Fn12]	[No Setting]	<ul style="list-style-type: none"> • Cannot be used as Fn buttons during playback.
16	 [Fn13] [Fn14] [Fn15] [Fn16]	[No Setting]	

Register Functions to the Fn Buttons



- With default settings, [Fn8] to [Fn12] on the joystick cannot be used. When using functions, set the [Joystick Setting] in the [Custom] ([Operation]) menu to [Fn]. (→ 429)

1 Select [Fn Button Set].

- Press **MENU/SET** → [] → [] → [Fn Button Set] → [Setting in REC mode]/[Setting in PLAY mode]



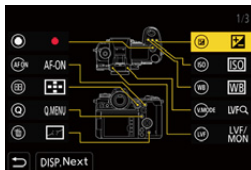

2 Select the button.

- Press **▲▼** to select the button and then press **MENU/SET** or .
- Selection is also possible by rotating  or .
- Press [DISP.] to change the page.







3 Find the function to register.

- Rotate  to select the sub tab where the function to register is categorized (→ 371, 374) and then press **MENU/SET** or .
- You can also select by pressing **◀** to select the sub tab, pressing **▲▼** or rotating , and then pressing **▶**.
- Switch the [1] to [3] tabs by pressing [Q].



4 Register the function.



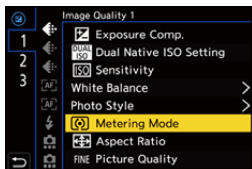

- Press ▲▼ to select a function and then press  or .
- Selection is also possible by rotating  or .
- Select items with [>] by selecting the item again.
- Depending on the button, some functions cannot be registered.



- You can also touch [Fn] on the control panel (→ 70) to display the screen in Step **2**.
- You can also press and hold the Fn button (2 sec.) to display the screen in Step **4**.
(This may not be displayed depending on the registered function and on the button type.)





❖ Setting Items ([Fn Button Set]/[Setting in REC mode])

[1] tab

 [Image Quality]		 [Focus/Shutter]	
[Exposure Comp.]	→ 197	[AF Mode]	→ 103
[Dual Native ISO Setting]	→ 203	[AF Custom Setting(Photo)]	→ 101
[Sensitivity]	→ 200	[AF Custom Setting(Video)]	→ 277
[White Balance]	→ 204	[Focus Peaking]	→ 402
[Photo Style]	→ 210	[Focus Peaking Sensitivity]	→ 402
[Metering Mode]	→ 185	[1-Area AF Moving Speed]	→ 403
[Aspect Ratio]	→ 87	[Focus Ring Lock]	→ 422
[Picture Quality]	→ 90	[AE LOCK]	→ 199
[Picture Size]	→ 88	[AF LOCK]	→ 199
[HLG Photo]	→ 226	[AF/AE LOCK]	→ 199
[High Resolution Mode]	→ 222	[AF-ON]	→ 98
[1 Shot Spot Metering]		[AF-ON : Near Shift]:	
• Records with the metering mode set to  (Spot metering) once only.		• AF operates giving priority to close-up subjects.	
[Long Exposure NR]	→ 397	[AF-ON : Far Shift]:	
[Min. Shutter Speed]	→ 398	• AF operates giving priority to distant subjects.	
[1 Shot RAW+JPG]		[AF-Point Scope]	→ 100
• Records a RAW image and a JPEG image simultaneously once only.		[Focus Area Set]	
[i.Dynamic Range]	→ 399	• Displays the AF area/MF Assist transition screen.	
[Filter Effect]	→ 216	 [Flash]	
[One Push AE]		[Flash Mode]	→ 231
• Adjusts the aperture value and shutter speed to the settings suited for the correct exposure determined by the camera.		[Flash Adjust.]	→ 235
[Touch AE]	→ 85	[Wireless Flash Setup]	→ 238
[Exposure Mode]	→ 249		
[Synchro Scan]	→ 318		

 [Others (Photo)]	[Silent Mode]	→ 174	
[Drive Mode]	→ 131	[Image Stabilizer]	→ 177
[1 Shot "6K/4K PHOTO"]		[Shutter Type]	→ 175
• Performs 6K/4K photo recording only once.		[Ex. Tele Conv.]	→ 128
[Bracketing]	→ 160	[Flicker Decrease (Photo)]	→ 407
		[Post-Focus]	→ 166



[2] tab

 [Image Format]	 [Operation]		
[Motion Pic. Rec Format]	→ 255	[Q.MENU]	→ 73
[Motion Pic. Rec Quality]	→ 255	[Rec / Playback Switch]	
[Rec Quality (My List)]	→ 265	• Switches to the playback screen.	
[Variable Frame Rate]	→ 297	[Video Record]	→ 242
[Time Code Display]	→ 268	[LVF/Monitor Switch]	→ 69
 [Audio]		[LVF Magnification]	→ 68
[Sound Rec Level Disp.]	→ 283	[Dial Operation Switch]	→ 377
[Mute Sound Input]	→ 413	 [Monitor / Display]	
[Sound Rec Level Adj.]	→ 284	[Preview]	→ 196
[Sound Rec Level Limiter]	→ 285	[Constant Preview]	→ 431
[XLR Mic Adaptor Setting]	→ 343	[Level Gauge]	→ 438
[Mic. Directivity Adjust]	→ 341	[Histogram]	→ 432
 [Others (Video)]		[Luminance Spot Meter]	→ 292
[Image Stabilizer]	→ 179	[Video Frame Marker]	→ 295
[E-Stabilization (Video)]	→ 179	[Photo Grid Line]	→ 433
[Boost I.S. (Video)]	→ 179	[Live View Boost]	→ 434
[Image Area of Video]	→ 266	[Monochrome Live View]	→ 440
[Focus Transition]	→ 301	[Night Mode]	→ 435
[Live Cropping]	→ 304	[LVF/Monitor Disp. Style]	
		• Switches the displayed monitor or viewfinder display style.	

[Video-Priority Display]	→ 441
[Status-LCD Display(Video)]	→ 248
[Zebra Pattern]	→ 440
[LUT View Assist (Monitor)]	→ 310
[LUT View Assist (HDMI)]	→ 310
[LUT Select]	→ 310
[HLG View Assist (Monitor)]	→ 314
[HLG View Assist (HDMI)]	→ 314
[Sheer Overlay]	→ 437
[I.S. Status Scope]	→ 437
[WFM/Vector Scope]	→ 288
[Anamorphic Desqueeze Display]	→ 316
[Color Bars]	→ 296

 [Lens / Others]	
[Focus Ring Control]	→ 443
[Zoom Control]	→ 129









[3] tab

 [Card/File]	
[Destination Card Slot]	
• Changes the priority of cards for recording. This can be used if [Double Card Slot Function] (→ 92) is set to [Relay Rec].	
 [IN/OUT]	
[Wi-Fi]	→ 465
[Fan Mode]	→ 442

 [Others]	
[No Setting]	
• Set when not using as an Fn button.	
[Restore to Default]	
• Restore the default settings for the Fn button. (→ 367)	

❖ Setting Items ([Fn Button Set]/[Setting in PLAY mode])

[1] tab

 [Playback Mode]	 [Operation]
[Magnify from AF Point] → 458	[Rec / Playback Switch] • Switches to the recording screen.
[LUT View Assist (Monitor)] → 310	[LVF/Monitor Switch] → 69
[HLG View Assist (Monitor)] → 439	[Video Record] → 242
[Anamorphic Desqueeze Display] → 316	 [Monitor / Display]
 [Process Image]	[Night Mode] → 435
[RAW Processing] → 359	 [Card/File]
[6K/4K PHOTO Bulk Saving] → 148	[Card Slot Change] → 348
 [Add/Delete Info.]	 [IN/OUT]
[Delete Single] → 357	[Wi-Fi] → 465
[Protect] → 460	[Fan Mode] → 442
[Rating★1] → 460	[Send Image (Smartphone)] → 498
[Rating★2] → 460	[LUT View Assist (HDMI)] → 310
[Rating★3] → 460	[HLG View Assist (HDMI)] → 439
[Rating★4] → 460	
[Rating★5] → 460	
 [Edit Image]	
[Copy] → 462	

[2] tab





 [Others]
[6K/4K Photo Play] • Displays the screen to select pictures to save from a 6K/4K burst file.
[No Setting] • Set when not using as an Fn button.
[Restore to Default] • Restore the default settings for the Fn button. (→ 367)

Use the Fn Buttons

During recording, pressing the Fn buttons enables usage of the functions registered in [Setting in REC mode], and during playback, usage of the functions registered in [Setting in PLAY mode].

1 Press the Fn button.

2 Select a setting item.

- Press ◀▶ to select a setting item and then press  or .
- Selection is also possible by rotating ,  or .
- Display and selection methods of a setting item differ depending on the menu item.

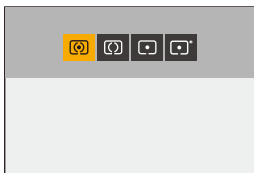

❖ Use [Fn3] to [Fn7] (Touch Icons)

During recording, you can use the Fn buttons within the Touch Tab.

- With the default settings, the Touch Tab is not displayed. Set [Touch Tab] to [ON] in [Touch Settings] in the [Custom] ([Operation]) menu. (→ 425)

- 1 Touch .
- 2 Touch one of [Fn3] to [Fn7].



[Dial Operation Switch]

This temporarily changes the functions operated with ☀️ (front dial) and 🌑 (rear dial).

Register Functions to the Dials

Register functions to each of ☀️ and 🌑.

1 Select [Dial Operation Switch Setup].

- → [] → [] → [Dial Set.]
→ [Dial Operation Switch Setup] →
[]/[]

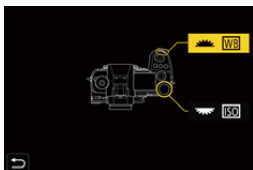

2 Register the function.

- Press ▲▼ to select a function and then press or .

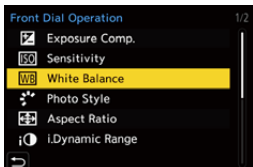

❖ Functions That Can Be Registered

– [Exposure Comp.] (→ 197)	– [Filter Effect] (→ 216)
– [Sensitivity]*1 (→ 200)	– [AF Mode] (→ 103)
– [White Balance]*2 (→ 204)	– [Flash Mode] (→ 231)
– [Photo Style] (→ 210)	– [Flash Adjust.] (→ 235)
– [Aspect Ratio] (→ 87)	– [6K/4K PHOTO] (→ 136)
– [i.Dynamic Range] (→ 399)	

*1 🌑 default setting



*2 ☀️ default setting

Temporarily Change Dial Operation

Use the Fn button to temporarily change dial operation.



1 Set [Dial Operation Switch] to the Fn button. (→ 367)

2 Switch dial operation.

- Press the Fn button set in Step 1.
- A guide will display the functions registered to  and .
- If no operations are performed, then several seconds later, the guide disappears.



3 Set the registered function.

- Rotate  or  while the guide is displayed.

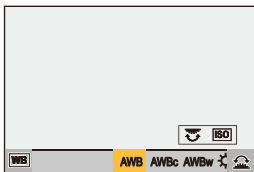

4 Confirm your selection.

- Press the shutter button halfway.

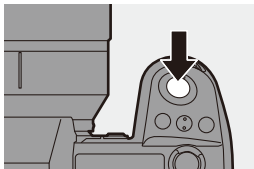

Quick Menu Customization

You can change Quick menu items depending on the recording mode. Additionally, you can change the items to display on the Quick menu and their order to suit your preferences.



For information about Quick menu operation methods, refer to page 73.

Register to the Quick Menu

Change the menus to be displayed in the Quick menu.





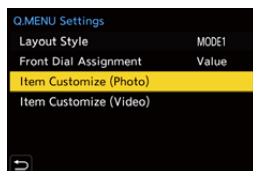

These can be set separately for [P/M] mode (Video) and for other recording modes (Photo).

1 Select [Q.MENU Settings].

-  ⇒ [] ⇒ [] ⇒ [Q.MENU Settings] ⇒ [Item Customize (Photo)]/[Item Customize (Video)]











2 Select the item position (① to ⑫).

- Press     to select the position and then press  or .
- Selection is also possible by rotating .
- Directions on the diagonal can also be selected using the joystick.









3 Find the function to register.

- Rotate  to select the sub tab where the function to register is categorized (→ 380) and then press  or .
- You can also select by pressing  to select the sub tab, pressing   or rotating , and then pressing .
- Each press of [Q] switches between tabs [1] and [2].



4 Register menu items.

- Press   to select an item and then press  or .
- Selection is also possible by rotating  or .
- Select items with [\rightarrow] by selecting the item again.







❖ Menu Items That Can Be Registered

[1] tab



 [Image Quality]		 [Others (Photo)]	
[Exposure Comp.]	→ 197	[Drive Mode]	→ 131
[Dual Native ISO Setting]	→ 203	[Bracketing]	→ 160
[Sensitivity]	→ 200	[Silent Mode]	→ 174
[White Balance]	→ 204	[Image Stabilizer]	→ 177
[Photo Style]	→ 210	[Shutter Type]	→ 175
[Metering Mode]	→ 185	[Ex. Tele Conv.]	→ 128
[Aspect Ratio]	→ 87	[Flicker Decrease (Photo)]	→ 407
[Picture Quality]	→ 90	[Post-Focus]	→ 166
[Picture Size]	→ 88	 [Image Format]	
[HLG Photo]	→ 226	[Motion Pic. Rec Format]	→ 255
[Long Exposure NR]	→ 397	[Motion Pic. Rec Quality]	→ 255
[Min. Shutter Speed]	→ 398	[Rec Quality (My List)]	→ 265
[i.Dynamic Range]	→ 399	[Variable Frame Rate]	→ 297
[Filter Effect]	→ 216	[Time Code Display]	→ 268
[Exposure Mode]	→ 249	 [Audio]	
[Synchro Scan]	→ 318	[Sound Rec Level Disp.]	→ 283
 [Focus/Shutter]		[Sound Rec Level Adj.]	→ 284
[AF Mode]	→ 103	[Sound Rec Level Limiter]	→ 285
[AF Custom Setting(Photo)]	→ 101	[XLR Mic Adaptor Setting]	→ 343
[AF Custom Setting(Video)]	→ 277	[Mic. Directivity Adjust]	→ 341
[Focus Peaking]	→ 402	 [Others (Video)]	
[Focus Peaking Sensitivity]	→ 402	[Image Stabilizer]	→ 179
[1-Area AF Moving Speed]	→ 403	[E-Stabilization (Video)]	→ 179
 [Flash]		[Boost I.S. (Video)]	→ 179
[Flash Mode]	→ 231	[Image Area of Video]	→ 266
[Flash Adjust.]	→ 235	[Focus Transition]	→ 301
[Wireless Flash Setup]	→ 238	[Live Cropping]	→ 304

[2] tab

 [Monitor / Display]	 [Lens / Others]
[Constant Preview] → 431	[Focus Ring Control] → 443
[Level Gauge] → 438	 [Card/File]
[Histogram] → 432	[Destination Card Slot] → 348
[Luminance Spot Meter] → 292	 [IN/OUT]
[Video Frame Marker] → 295	[Wi-Fi] → 465
[Photo Grid Line] → 433	[Fan Mode] → 442
[Live View Boost] → 434	 [Others]
[Monochrome Live View] → 440	[No Setting]
[Night Mode] → 435	• Set when not using.
[LVF/Monitor Disp. Style] → 435	
[Video-Priority Display] → 441	
[Zebra Pattern] → 440	
[LUT View Assist (Monitor)] → 310	
[LUT View Assist (HDMI)] → 451	
[HLG View Assist (Monitor)] → 439	
[HLG View Assist (HDMI)] → 439	
[Sheer Overlay] → 437	
[I.S. Status Scope] → 437	
[WFM/Vector Scope] → 288	
[Anamorphic Desqueeze Display] → 316	
[Color Bars] → 296	

❖ Quick Menu Detailed Settings

Change the appearance of the Quick menu and the operation of  during menu display.

 ⇒ [] ⇒ [] ⇒ Select [Q.MENU Settings]

<p>[Layout Style]</p>	<p>Changes the appearance of the Quick menu. [MODE1]: Displays the live view and the menu simultaneously. [MODE2]: Displays the menu in full screen.</p>
<p>[Front Dial Assignment]</p>	<p>Changes the operation of  in the Quick menu. [Item]: Selects menu items. [Value]: Selects setting values.</p>
<p>[Item Customize (Photo)]</p>	<p>Customizes the Quick menu to display when the mode dial is set to [iA]/[P]/[A]/[S]/[M].</p>
<p>[Item Customize (Video)]</p>	<p>Customizes the Quick menu to display when the mode dial is set to [vM].</p>

Custom Mode

C1 C2 C3



Recording modes and menu settings that match your preferences can be registered in Custom mode. You can use registered settings by switching the mode dial to [C1] to [C3] modes.



Register in Custom Mode

You can register the currently set information of the camera.

At the time of purchase, the default settings of the [P] mode menus are registered with all Custom modes.



1 Set to recording mode and menu settings of the state you wish to save.

2 Select [Save to Custom Mode].

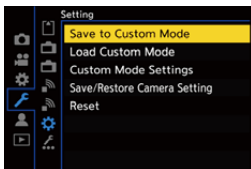
-  → [] → [] → [Save to Custom Mode]



3 Register.

- Select the save-to number and then press  or .
- A confirmation screen will be displayed. Press [DISP.] to change the Custom mode name.
For information on how to enter characters, refer to page [464](#).

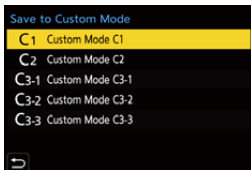



- You cannot register [iA] mode in Custom mode.



- List of settings that can be registered in Custom mode (→ [587](#))

❖ Custom Mode Detailed Settings

Sets the ease of use of Custom mode.

You can create additional Custom mode sets, and how long to retain temporarily changed settings details.



→ [] → [] → Select [Custom Mode Settings]

[Limit No. of Custom Mode]	Sets the number of Custom modes that can be registered in [C3]. A maximum of 10 sets can be registered; 3 sets are available as default settings.
[Edit Title]	Changes the Custom mode name. A maximum of 22 characters can be entered. A two-byte character is treated as two characters. • For information on how to enter characters, refer to page 464 .
[How to Reload Custom Mode]	Sets the timing at which to return the settings that were changed temporarily while the Custom mode was being used to their registered settings. [Change Recording Mode]/[Return from Sleep Mode]/[Turn the Power ON]
[Select Loading Details]	Sets the types of settings to call up with [Load Custom Mode]. [F / SS / ISO Sensitivity]: Enables calling up of aperture value, shutter speed, and ISO sensitivity settings. [White Balance]: Enables calling up of white balance settings.



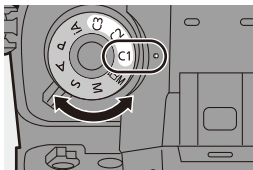

Using Custom Mode

Set the mode dial to one of [C1] to [C3].

- If [C3], the last-used Custom mode will be called up.



❖ [C3] Custom Mode Selection

- 1 Set the mode dial to [C3].
- 2 Press .
 - The Custom mode selection menu appears.
- 3 Press   to select the Custom mode and then press  or .
 - The selected Custom mode icon will be displayed on the recording screen.

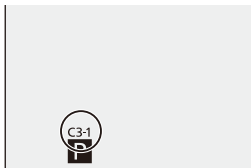

❖ Changing Registered Details

Registered settings do not change even if you change the camera settings temporarily with the mode dial set to [C1] to [C3].



To change the registered details, overwrite them by using [Save to Custom Mode] in the [Setup] ([Setting]) menu.

Calling Up Settings

Call up registered Custom mode settings to the selected recording mode and overwrite the current settings with these.



1 Set to the mode dial to use.

2 Select [Load Custom Mode].

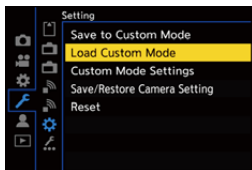
-  → [] → [] → [Load Custom Mode]



3 Select the Custom mode to call up.

- Select the Custom mode and then press  or .

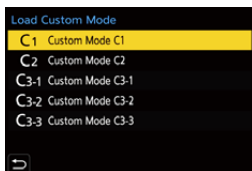



- Calling up of Custom modes is not possible between those created from [P]/[A]/[S]/[M] modes and those created from [CAM] mode.

My Menu

Register frequently-used menus in My Menu.

A maximum of 23 items can be registered.

Registered menus can be called up from [] to [].

Registration in My Menu

Select a menu, and register this in My Menu.

1 Select [Add].

-  → [] → [] → [Add]

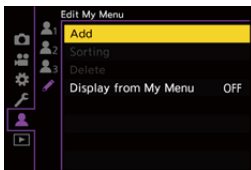

2 Register.

- Select the menu to register and then press  or .

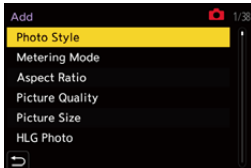

❖ Calling up My Menu

Call up the menus registered in My Menu.

-  → [] → []/[]/[] → Registered menus

Edit My Menu

You can reorder the display order of My Menu, and delete unnecessary menus.



 ⇒ [] ⇒ Select []

[Add]	Selects and registers the menus to be displayed in My Menu.
[Sorting]	Changes the order of My Menu. Select the menu to change, then set the destination.
[Delete]	Deletes menus that are registered to My Menu. [Delete Item]: Selects the menu, then deletes. [Delete All]: Deletes all menus registered in My Menu.
[Display from My Menu]	Displays My Menu first when displaying a menu. [ON]: Displays My Menu. [OFF]: Displays the last-used menu.

[Save/Restore Camera Setting]

Saves the camera's settings information to the card.

Saved settings information can be loaded to the camera, letting you set the same settings on multiple cameras.

 ⇒ [] ⇒ [] ⇒ Select [Save/Restore Camera Setting]

[Save]	Saves the camera's settings information to the card. <ul style="list-style-type: none"> • If saving new data, then select [New File], and if overwriting an existing file, select that existing file. • When [New File] is selected, a screen to select the file name to save as is displayed. 	
	[OK]	Saves using the file name on the screen.
	[Change the file name]	Changes the file name and saves the file. <ul style="list-style-type: none"> • Available characters: alphabetic characters (upper-case), numerals, up to 8 characters • For information on how to enter characters, refer to page 464.
[Load]	Loads the settings information on the card and copies it to the camera.	
[Delete]	Deletes settings information on the card.	
[Keep Settings While Format]	When formatting the card, formats the card while keeping camera settings information stored on the card.	



- Only settings information from the same model can be loaded.
- Up to 10 instances of settings information can be saved on one card.



- List of functions for which saving of settings information is possible (→ [587](#))

15. Menu Guide

Camera customization and many function settings are performed with menus on this camera. This chapter provides a list of menus and describes them in detail.

Menus explained in detail in other chapters are indicated with page numbers.

- For information about menu operation methods, refer to page [77](#).

Search the Menus

List of Menu → [391](#)

Learn About the Menu Functions and Default Settings

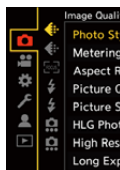

[Photo] menu → [396](#)

[Video] menu → [410](#)

[Custom] menu → [418](#)

[Setup] menu → [444](#)

[My Menu] → [387](#)

[Playback] menu → [456](#)

Enter Characters

















Entering Characters → [464](#)

- ➔ • Refer to the “18. Materials” chapter for the following lists:
 - List of Default Settings/Custom Saving/Settings Available for Copying: → [587](#)
 - List of Functions That Can Be Set in Each Recording Mode: → [601](#)













List of Menu







: Menu items common to the [Photo] menu and [Video] menu.
Their settings are synchronized.

[Photo] menu





 [Image Quality]	→ 396	[Flash Adjust.]	→ 403
[Photo Style]	 → 396	[Flash Synchro]	→ 403
[Metering Mode]	 → 396	[Manual Flash Adjust.]	→ 403
[Aspect Ratio]	→ 396	[Auto Exposure Comp.]	→ 403
[Picture Quality]	→ 396	[Red-Eye Removal]	→ 404
[Picture Size]	→ 396	[Wireless]	→ 404
[HLG Photo]	→ 396	[Wireless Channel]	→ 404
[High Resolution Mode]	→ 397	[Wireless FP]	→ 404
[Long Exposure NR]	→ 397	[Communication Light]	→ 404
[Dual Native ISO Setting]	 → 397	[Wireless Setup]	→ 404
[ISO Sensitivity (photo)]	→ 398	 [Others (Photo)]	→ 405
[Min. Shutter Speed]	→ 398	[Bracketing]	→ 405
[i.Dynamic Range]	 → 399	[Silent Mode]	 → 405
[Vignetting Comp.]	 → 400	[Image Stabilizer]	 → 405
[Diffraction Compensation]	 → 400	[Burst Shot 1 Setting]	→ 405
[Filter Settings]	 → 401	[Burst Shot 2 Setting]	→ 405
 [Focus]	→ 401	[Shutter Type]	→ 405
[AF Custom Setting(Photo)]	→ 401	[Shutter Delay]	→ 406
[AF Assist Light]	 → 401	[Ex. Tele Conv.]	→ 406
[Focus Peaking]	 → 402	[Time Lapse/Animation]	→ 406
[1-Area AF Moving Speed]	 → 403	[Self Timer]	→ 406
 [Flash]	→ 403	[Flicker Decrease (Photo)]	→ 407
[Flash Mode]	→ 403	[6K/4K PHOTO]	→ 407
[Firing Mode]	→ 403	[Post-Focus]	→ 408
		[Multiple Exposure]	→ 408
		[Time Stamp Rec.]	 → 417

 **[Video] menu**

 [Image Quality]	→ 410
[Exposure Mode]	→ 410
[Photo Style]	 → 410
[Metering Mode]	 → 410
[Dual Native ISO Setting]	 → 410
[ISO Sensitivity (video)]	→ 410
[Synchro Scan]	→ 410
[Flicker Decrease (Video)]	→ 411
[Master Pedestal Level]	→ 411
[SS/Gain Operation]	→ 411
[i.Dynamic Range]	 → 399
[Vignetting Comp.]	 → 400
[Diffraction Compensation]	 → 400
[Filter Settings]	 → 401
 [Image Format]	→ 412
[Rec. File Format]	→ 412
[Image Area of Video]	→ 412
[Rec Quality]	→ 412
[Rec Quality (My List)]	→ 412
[Variable Frame Rate]	→ 412
[Time Code]	→ 412
[Luminance Level]	→ 412
 [Focus]	→ 413
[AF Custom Setting(Video)]	→ 413
[Continuous AF]	→ 413
[AF Assist Light]	 → 413
[Focus Peaking]	 → 413

[1-Area AF Moving Speed]	 → 413
 [Audio]	→ 413
[Sound Rec Level Disp.]	→ 413
[Mute Sound Input]	→ 413
[Sound Rec Gain Level]	→ 414
[Sound Rec Level Adj.]	→ 414
[Sound Rec Level Limiter]	→ 414
[Wind Noise Canceller/]	→ 414
[Wind Cut]	→ 414
[Mic Socket]	→ 414
[Special Mic.]	→ 414
[XLR Mic Adaptor Setting]	→ 414
[Sound Output]	→ 414
[Headphone Volume]	→ 415
 [Others (Video)]	→ 415
[Silent Mode]	 → 415
[Image Stabilizer]	 → 415
[Focus Transition]	→ 416
[Loop Recording (video)]	→ 416
[Segmented File Recording]	→ 416
[Live Cropping]	→ 416
[Time Stamp Rec.]	 → 417



 **[Custom] menu**



 [Image Quality]	→ 418	[ISO Displayed Setting]	→ 427
[Photo Style Settings]	→ 418	[Exposure Comp. Disp. Setting]	→ 427
[ISO Increments]	→ 418	[Dial Set.]	→ 428
[Extended ISO]	→ 419	[Joystick Setting]	→ 429
[Exposure Offset Adjust.]	→ 419	[Illuminated Button]	→ 429
[Color Space]	→ 420	[Video Rec. Button (Remote)]	→ 430
[Exposure Comp. Reset]	→ 420	 [Monitor / Display (Photo)]	→ 430
[Auto Exposure in P/A/S/M]	→ 420	[Auto Review]	→ 430
[CreativeVideo Combined Set.]	→ 420	[Constant Preview]	→ 431
 [Focus/Shutter]	→ 421	[Histogram]	→ 432
[Focus/Shutter Priority]	→ 421	[Photo Grid Line]	→ 433
[Focus Switching for Vert / Hor]	→ 421	[AF Area Display]	→ 433
[AF/AE Lock Hold]	→ 421	[Live View Boost]	→ 434
[AF+MF]	→ 421	[Night Mode]	→ 435
[MF Assist]	→ 422	[LVF/Monitor Disp. Set]	→ 435
[MF Guide]	→ 422	[Expo.Meter]	→ 436
[Focus Ring Lock]	→ 422	[Focal Length]	→ 436
[Show/Hide AF Mode]	→ 423	[Blinking Highlights]	→ 436
[Pinpoint AF Setting]	→ 423	[Sheer Overlay]	→ 437
[AF-Point Scope Setting]	→ 424	[I.S. Status Scope]	→ 437
[Shutter AF]	→ 424	[Level Gauge]	→ 438
[Half-Press Shutter]	→ 424	[Luminance Spot Meter]	→ 439
[Quick AF]	→ 424	[Framing Outline]	→ 439
[Eye Sensor AF]	→ 424	[Show/Hide Monitor Layout]	→ 439
[Looped Focus Frame]	→ 425		
[AFC Start Point (225-Area)]	→ 425		
 [Operation]	→ 425		
[Q.MENU Settings]	→ 425		
[Touch Settings]	→ 425		
[Lock Lever Setting]	→ 426		
[Fn Button Set]	→ 426		
[WB/ISO/Expo. Button]	→ 427		



[Custom] menu (Continued)

 [Monitor / Display (Video)]	→ 439
[V-Log View Assist]	→ 439
[HLG View Assist]	→ 439
[Anamorphic Desqueeze Display]	→ 440
[Monochrome Live View]	→ 440
[Center Marker]	→ 440
[Video Frame Marker]	→ 440
[Zebra Pattern]	→ 440
[WFM/Vector Scope]	→ 441
[Color Bars]	→ 441

[Setup] menu

 [Card/File]	→ 444
[Card Format]	→ 444
[Double Card Slot Function]	→ 444
[Folder / File Settings]	→ 444
[File Number Reset]	→ 444
[Copyright Information]	→ 444
 [Monitor / Display]	→ 445
[Power Save Mode]	→ 445
[Monitor Frame Rate]	→ 445
[LVF Frame Rate]	→ 445
[Monitor Settings]/[Viewfinder]	→ 446
[Monitor Backlight]/ [LVF Luminance]	→ 446
[Remaining Battery Level]	→ 446
[Status-LCD]	→ 447
[Eye Sensor]	→ 447
[Level Gauge Adjust.]	→ 448



[Video-Priority Display]	→ 441
[Red REC Frame Indicator]	→ 441
 [IN/OUT]	→ 442
[HDMI Rec Output]	→ 442
[Fan Mode]	→ 442
[Tally Lamp]	→ 442
 [Lens / Others]	→ 443
[Lens Focus Resume]	→ 443
[Focus Ring Control]	→ 443
[Lens Information]	→ 443
[Lens Info. Confirmation]	→ 443

 [IN/OUT]	→ 448
[Beep]	→ 448
[Headphone Volume]	→ 448
[Wi-Fi]	→ 448
[Bluetooth]	→ 449
[USB]	→ 449
[Battery Information]	→ 450
[Battery Use Priority]	→ 450
[TV Connection]	→ 451
[Card Access Light]	→ 452
 [Setting]	→ 453
[Save to Custom Mode]	→ 453
[Load Custom Mode]	→ 453
[Custom Mode Settings]	→ 453
[Save/Restore Camera Setting]	→ 453
[Reset]	→ 453



 **[Setup] menu (Continued)**

 [Others]	→ 454
[Clock Set]	→ 454
[Time Zone]	→ 454
[System Frequency]	→ 454
[Pixel Refresh]	→ 454

 **[My Menu]**



 [Page 1]	→ 387
 [Page 2]	→ 387
 [Page 3]	→ 387

 **[Playback] menu**

 [Playback Mode]	→ 457
[Playback Mode]	→ 457
[Slide Show]	→ 457
[Rotate Disp.]	→ 457
[Picture Sort]	→ 457
[Magnify from AF Point]	→ 458
[LUT View Assist (Monitor)]	→ 458
[HLG View Assist (Monitor)]	→ 458
[Anamorphic Desqueeze Display]	→ 440
 [Process Image]	→ 459
[RAW Processing]	→ 459
[6K/4K PHOTO Bulk Saving]	→ 459
[6K/4K PHOTO Noise Reduction]	→ 459
[Time Lapse Video]	→ 459
[Stop Motion Video]	→ 459

[Sensor Cleaning]	→ 454
[Language]	→ 455
[Firmware Version]	→ 455
[Online Manual]	→ 455
[Approved Regulations]	→ 455

 [Edit My Menu]	→ 388
[Add]	→ 388
[Sorting]	→ 388
[Delete]	→ 388
[Display from My Menu]	→ 388







 [Add/Delete Info.]	→ 460
[Protect]	→ 460
[Rating]	→ 460
 [Edit Image]	→ 461
[Resize]	→ 461
[Rotate]	→ 461
[Video Divide]	→ 461
[Copy]	→ 462
 [Others]	→ 463
[Delete Confirmation]	→ 463

[Photo] Menu



: Menu items common to the [Photo] menu and [Video] menu. Their settings are synchronized.

▶: Default settings



[Photo] menu → [Image Quality]

 [Photo Style]	▶[Standard]/[Vivid]/[Natural]/[Flat]/[Landscape]/ [Portrait]/[Monochrome]/[L.Monochrome]/ [L.Monochrome D]/[Cinelike D2]/[Cinelike V2]/ [Like709]/[V-Log]/[Standard(HLG)]/ [Monochrome(HLG)]/[MY PHOTO STYLE 1] to [MY PHOTO STYLE 10] You can select the finishing settings of images to suit your subjects and expression styles.	→ 210
 [Metering Mode]	▶[]/[]/[]/[] Type of optical measurement to measure brightness can be changed.	→ 185
[Aspect Ratio]	[4:3]/▶[3:2]/[16:9]/[1:1]/[65:24]/[2:1] You can select the image aspect ratio.	→ 87
[Picture Quality]	▶[FINE]/[STD.]/[RAW+FINE]/[RAW+STD.]/[RAW] Set the compression rate used for storing pictures.	→ 90
[Picture Size]	▶[L]/[M]/[S] Sets the picture's image size.	→ 88
[HLG Photo]	[Full-Res.]/[4K-Res.]/▶[OFF] Records an HLG format picture with a wide dynamic range.	→ 226



 [Photo] menu →  [Image Quality]

[High Resolution Mode]	[Start]		→ 222
	[Simul Record Normal Shot]	▶[ON]/[OFF]	
	[Shutter Delay]	[30 SEC] to [1/8 SEC] (▶[2 SEC])/[OFF]	
	[Motion Blur Processing]	▶[MODE1]/[MODE2]	
	Merges pictures with a high resolution from multiple recorded images.		
[Long Exposure NR]	▶[ON]/[OFF]		—
	 <p>The camera automatically removes noise generated when recording images with a slow shutter speed.</p> <ul style="list-style-type: none"> Recording is not possible during noise reduction. When the following functions are being used, [Long Exposure NR] is not available: <ul style="list-style-type: none"> – Video recording/[6K/4K PHOTO]/[Post-Focus] – [ELEC.] (Excluding [ELEC.+NR])/[Silent Mode]/[High Resolution Mode] This menu item can be registered to the Fn button. (→ 367) 		
 [Dual Native ISO Setting]	▶[AUTO]/[LOW]/[HIGH]		→ 203
	Sets whether to switch the base sensitivity automatically or to fix it.		





 **[Photo] menu** →  **[Image Quality]**

[ISO Sensitivity (photo)]	[ISO Auto Lower Limit Setting]	▶[100] to [25600]	—
	[ISO Auto Upper Limit Setting]	▶[AUTO]/[200] to [51200]	
	 <p>Sets the lower and upper limits for ISO sensitivity when ISO sensitivity is set to [AUTO].</p>		
[Min. Shutter Speed]	▶[AUTO]/[1/8000] to [1/1]		—
	 <p>Sets the minimum shutter speed when the ISO sensitivity is set to [AUTO].</p> <ul style="list-style-type: none"> • The shutter speed may become slower than the set value in recording situations where correct exposure cannot be achieved. • This menu item can be registered to the Fn button. (→ 367) 		

 [Photo] menu →  [Image Quality]



 [i.Dynamic Range]	[AUTO]/[HIGH]/[STANDARD]/[LOW]/▶[OFF]	—
	<div data-bbox="329 258 593 297" style="border: 1px solid black; padding: 2px; display: inline-block;"> iA P A S M  </div> <p>Contrast and exposure are compensated when the brightness difference between the background and subject is great.</p> <ul style="list-style-type: none"> • Compensation effect may not be achieved depending on the recording conditions. • When the following functions are being used, [i.Dynamic Range] is not available: <ul style="list-style-type: none"> – [Like709]/[V-Log]/[Standard(HLG)]/[Monochrome(HLG)]/[Like2100(HLG)] ([Photo Style]) – [Filter Settings] • This menu item can be registered to the Fn button. (→ 367) 	



 [Photo] menu →  [Image Quality]



 [Vignetting Comp.]	<p>▶[ON]/[OFF]</p> <p>iA P A S M </p> <p>When the screen periphery darkens as a result of the lens characteristics, you can record pictures with the brightness of the screen periphery corrected.</p> <ul style="list-style-type: none"> • Compensation effect may not be achieved depending on the recording conditions. • Noise in the periphery of the picture may stand out with higher ISO sensitivity. • When the following function is being used, [Vignetting Comp.] in the [Photo] ([Image Quality]) menu is not available: <ul style="list-style-type: none"> – [Ex. Tele Conv.] • When the following functions are being used, [Vignetting Comp.] in the [Video] ([Image Quality]) menu is not available: <ul style="list-style-type: none"> – [S35mm]*/[PIXEL/PIXEL] ([Image Area of Video]) – [Variable Frame Rate] <p>* Only when using a full-frame lens</p>	—
 [Diffraction Compensation]	<p>[AUTO]▶[OFF]</p> <p>iA P A S M </p> <p>The camera raises the image resolution by correcting the blurriness caused by diffraction when the aperture is closed.</p> <ul style="list-style-type: none"> • Compensation effect may not be achieved depending on the recording conditions. • Noise may stand out with higher ISO sensitivity. 	—





 [Photo] menu →  [Image Quality]

 [Filter Settings]	[Filter Effect]	[ON]/▶[OFF]/[SET]	→ 216
	[Simultaneous Record w/o Filter]	[ON]/▶[OFF]	
	This mode records with additional image effects (filters).		





 [Photo] menu →  [Focus]



[AF Custom Setting(Photo)]	▶[Set 1]/[Set 2]/[Set 3]/[Set 4]	→ 101
	Select features of AF operation when recording using [AFC] that are appropriate for the subject and scene.	
 [AF Assist Light]	▶[ON]/[OFF]	—
	<div style="display: flex; justify-content: space-around; align-items: center;"> iA P A S M  </div> <p>When recording in low light conditions, the AF assist light turns on when you press the shutter button halfway, making it easier for the camera to focus.</p> <ul style="list-style-type: none"> • The effective range of the AF assist light is different depending on the lens used. <ul style="list-style-type: none"> – When the interchangeable lens (S-R24105) is attached and at wide-angle end. Approx. 1.0 m (3.3 feet) to 3.0 m (9.8 feet) • Remove the lens hood. • The AF assist light may be greatly blocked, and it may become harder to focus when a lens with large diameter is used. • When [Silent Mode] is being used, [AF Assist Light] is fixed to [OFF]. 	





 **[Photo] menu** →  **[Focus]**



 [Focus Peaking]	▶[ON]/[OFF]	
	[SET]	[Focus Peaking Sensitivity]
		[Display Color]
		[Display While AFS]
		
	<p>During MF operation, in-focus portions (portions on the screen with clear outlines) are highlighted with color.</p> <ul style="list-style-type: none"> • If the [Focus Peaking Sensitivity] is adjusted to the negative direction, portions to be highlighted are reduced, allowing you to achieve a more precise focus. • With [Display Color], you can set the display color of the in-focus portion. • When [Display While AFS] is set to [ON], the Focus Peaking display is also possible when the shutter button is pressed halfway in the [AFS] focus mode. • You can display the Touch Tab (→ 425) and then touch  in [] to switch [ON]/[OFF]. • When [Rough Monochrome] of [Filter Settings] is being used, [Focus Peaking] is not available. • When [Live View Boost] is being used, [Focus Peaking] is not available. • This menu item can be registered to the Fn button. (→ 367) 	



 [Photo] menu →  [Focus]

 [1-Area AF Moving Speed]	▶[FAST]/[NORMAL]	—
	 Sets the speed when moving a single AF area. This operates when AF mode is set to  ,  or  . • This menu item can be registered to the Fn button. (→ 367)	









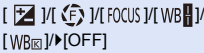

 [Photo] menu →  [Flash]

[Flash Mode]	▶  /[] / [ S] / [ S [⊙]] / []	→ 231
	Sets the flash mode.	
[Firing Mode]	▶[TTL]/[MANUAL]	→ 234
	You can select whether to set the flash output automatically or manually.	
[Flash Adjust.]	[−3 EV] to [+3 EV] (▶[±0 EV])	→ 235
	When [Firing Mode] is set to [TTL], you can adjust the flash output.	
[Flash Synchro]	▶[1ST]/[2ND]	→ 236
	Sets the flash mode to Second Curtain Synchro.	
[Manual Flash Adjust.]	[1/128] to ▶[1/1]	→ 234
	When [Firing Mode] is set to [MANUAL], you can set the flash output.	
[Auto Exposure Comp.]	[ON]/▶[OFF]	→ 237
	Automatically adjust the flash output in conjunction with the exposure compensation value.	



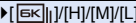

 **[Photo] menu** →  **[Flash]**

[Red-Eye Removal]	[ON]▶[OFF]		→ 233
	When [Flash Mode] is set to [] or [], the camera automatically detects red-eye and corrects image data.		
[Wireless]	[ON]▶[OFF]		→ 239
	Enables recording using a wireless flash.		
[Wireless Channel]	▶[1CH]/[2CH]/[3CH]/[4CH]		→ 239
	Sets the channel to use when recording with a wireless flash.		
[Wireless FP]	[ON]▶[OFF]		→ 241
	Uses FP firing for an external flash when recording with a wireless flash.		
[Communication Light]	▶[HIGH]/[STANDARD]/[LOW]		→ 241
	Set the strength of communication light.		
[Wireless Setup]	[External Flash]	[Firing Mode]/[Flash Adjust.]/[Manual Flash Adjust.]	→ 240
	[A Group]/[B Group]/[C Group]	[Firing Mode]/[Flash Adjust.]/[Manual Flash Adjust.]	
	Sets details for wireless flash recording.		

 [Photo] menu →  [Others (Photo)]

[Bracketing]	[Bracketing Type]	 [WB] / [WB] ▶ [OFF]	→ 160
	[More Settings]		
	You can take multiple pictures while automatically adjusting a setting.		
 [Silent Mode]	[ON] ▶ [OFF]		→ 174
	Disables all operation sounds and light output at once.		
 [Image Stabilizer]	[Operation Mode]	▶ [] / [OFF]	→ 177
	[Body(B.I.S.) / Lens(O.I.S.)]	[] / []	
	[When to Activate]	[ALWAYS] ▶ [HALF-SHUTTER]	
	[E-Stabilization (Video)]	[ON] ▶ [OFF]	
	[Boost I.S. (Video)]	[ON] ▶ [OFF]	
	[Anamorphic (Video)]	[] / [OFF]	
	[Lens Information]	[Lens1] to [Lens12] ▶ [Lens1]	
	Configures image stabilizer settings.		
[Burst Shot 1 Setting]	[] ▶ [H]/[M]/[L]	→ 132 → 136	
	Sets the burst recording operation of the drive mode [].		
[Burst Shot 2 Setting]	▶ [] ▶ [H]/[M]/[L]	→ 132 → 136	
	Sets the burst recording operation of the drive mode [].		
[Shutter Type]	[AUTO] ▶ [MECH.] / [EFC] / [ELEC.] / [ELEC.+NR]	→ 175	
	Selects the shutter type to use for taking pictures.		



 [Photo] menu →  [Others (Photo)]

[Shutter Delay]	<p>[8SEC]/[4SEC]/[2SEC]/[1SEC]▶[OFF]</p> <p>iA P A S M </p> <p>To reduce camera shake and shutter-induced blur, the shutter is released after the specified time has passed since the shutter button was pressed.</p> <ul style="list-style-type: none"> When the following functions are being used, [Shutter Delay] is not available: <ul style="list-style-type: none"> – Video recording/[6K/4K PHOTO]/[Post-Focus] – [High Resolution Mode] 	—				
[Ex. Tele Conv.]	<p>[ZOOM]/[TELE CONV.]▶[OFF]</p> <p>You can take pictures that are further enlarged beyond what is available with the optical zoom, without any deterioration in image quality.</p>	→ 128				
[Time Lapse/ Animation]	<table border="1" data-bbox="319 713 859 786"> <tr> <td data-bbox="319 713 564 786">[Mode]</td> <td data-bbox="564 713 859 786">▶[Time Lapse Shot]</td> </tr> <tr> <td colspan="2" data-bbox="319 786 859 862">▶[Stop Motion Animation]</td> </tr> </table> <p>Time Lapse Shot automatically starts/stops recording at a set recording interval.</p> <p>Stop Motion Animation enables you to take pictures while moving the subject little by little.</p>	[Mode]	▶[Time Lapse Shot]	▶[Stop Motion Animation]		<p>→ 149</p> <p>→ 153</p>
[Mode]	▶[Time Lapse Shot]					
▶[Stop Motion Animation]						
[Self Timer]	<p>▶[10]/[10]/[2]</p> <p>Sets the self-timer duration.</p>	→ 158				

 [Photo] menu →  [Others (Photo)]

[Flicker Decrease (Photo)]	[ON]▶[OFF]		—
	 <p>Detects flickering such as that under fluorescent lighting, and records using a timing that minimizes this.</p> <ul style="list-style-type: none"> • The reduction effect may not be obtained depending on the recording conditions. • When Flicker Decrease is operating, the [FLICKER] icon will be displayed in yellow on the recording screen. • When the following functions are being used, [Flicker Decrease (Photo)] is not available: <ul style="list-style-type: none"> – Video recording/[6K/4K PHOTO]/[Post-Focus] – [ELEC.]/[Silent Mode] • This menu item can be registered to the Fn button. (→ 367) 		
[6K/4K PHOTO]	[Picture Size / Burst Speed]	▶[6K 18M]/[4K H 8M]/[4K 8M]	→ 136
	[Rec Method]	▶[6K/4K Burst]/[6K/4K Burst(S/S)]/[6K/4K Pre-Burst]	
	[Pre-Burst Recording]	[ON]▶[OFF]	
	<p>Sets 6K/4K photos. You can save pictures extracted from a burst file taken using high-speed burst.</p>		

 [Photo] menu →  [Others (Photo)]

[Post-Focus]	<p>[6K 18M]/[4K 8M]/▶[OFF]</p> <p>Taking burst pictures with the same image quality as 6K/4K photos while automatically changing the focus point.</p> <p>You can select the focus point for the picture to save after recording.</p>	→ 166				
[Multiple Exposure]	<p>[Start]</p> <table border="1" data-bbox="319 466 862 540"> <tr> <td>[Auto Gain]</td> <td>▶[ON]/[OFF]</td> </tr> <tr> <td>[Overlay]</td> <td>[ON]/▶[OFF]</td> </tr> </table> <p></p> <p>You can apply an effect equivalent to four exposures on a single image.</p> <p>[Start]: Starts exposure for multiple exposures.</p> <p>[Auto Gain]: Automatically adjusts brightness in accordance with image count.</p> <p>[Overlay]: Allows multiple exposure for recorded RAW images. After selecting [Start], a selection screen for images to stack is displayed.</p> <ul style="list-style-type: none"> • After selecting [Start], pressing the shutter button fully starts multiple exposure. • Preview is displayed for each recording, and the following operations are available: <ul style="list-style-type: none"> – [Next] (You can also perform the same operation by pressing the shutter button halfway.) – [Retake] – [Exit]: Records the picture, and finishes multiple exposure recording. <div data-bbox="629 1053 853 1202" style="text-align: right;">  </div>	[Auto Gain]	▶[ON]/[OFF]	[Overlay]	[ON]/▶[OFF]	—
[Auto Gain]	▶[ON]/[OFF]					
[Overlay]	[ON]/▶[OFF]					

 [Photo] menu →  [Others (Photo)]

<p>[Multiple Exposure] (Continued)</p>	<ul style="list-style-type: none"> • Recording the picture will automatically stop multiple exposure recording. • To finish multiple exposure recording before starting the recording, press [Q] on the recording screen. • Recording information for the last-recorded image will be saved as recording information for images recorded with multiple exposures. • [Overlay] can be set only for RAW images recorded with the camera. • For RAW images recorded using the following functions, [Overlay] cannot be set: <ul style="list-style-type: none"> – [65:24]/[2:1] ([Aspect Ratio]) – [HLG Photo] – [High Resolution Mode] • When the following functions are being used, [Multiple Exposure] is not available: <ul style="list-style-type: none"> – [Time Lapse Shot] – [Stop Motion Animation] – [High Resolution Mode] – [Filter Settings] • When using Super 35 mm/APS-C lenses, [Multiple Exposure] is not available. 	<p>—</p>
<p> [Time Stamp Rec.]</p>	<p>[ON]▶[OFF]</p> <p>Records the recorded date and time superimposed on the images.</p>	<p>→ 417</p>



[Video] Menu









: Menu items common to the [Photo] menu and [Video] menu. Their settings are synchronized.

▶: Default settings

[Video] menu → [Image Quality]



[Exposure Mode]	▶[P]/[A]/[S]/[M] Sets the exposure mode to use in mode.	→ 249
[Photo Style]	▶[Standard]/[Vivid]/[Natural]/[Flat]/[Landscape]/[Portrait]/[Monochrome]/[L.Monochrome]/[L.Monochrome D]/[Cinelike D2]/[Cinelike V2]/[Like709]/[V-Log]/[Standard(HLG)]/[Monochrome(HLG)]/[Like2100(HLG)]/[MY PHOTO STYLE 1] to [MY PHOTO STYLE 10] You can select the finishing settings of images to suit your subjects and expression styles.	→ 210
[Metering Mode]	▶///	→ 185
[Dual Native ISO Setting]	▶[AUTO]/[LOW]/[HIGH] Sets whether to switch the base sensitivity automatically or to fix it.	→ 203
[ISO Sensitivity (video)]	[ISO Auto Lower Limit Setting] ▶[100] to [25600] [ISO Auto Upper Limit Setting] ▶[AUTO]/[200] to [51200] Sets the lower and upper limits for ISO sensitivity when ISO sensitivity is set to [AUTO].	→ 282
[Synchro Scan]	[ON]/▶[OFF] Fine-adjust the shutter speed to reduce flickering and horizontal stripes.	→ 318





 [Video] menu →  [Image Quality]



 [Flicker Decrease (Video)]	[1/50]/[1/60]/[1/100]/[1/120]▶[OFF]	—	
	 <p>The shutter speed can be fixed to reduce the flicker or striping in the video.</p> <ul style="list-style-type: none"> This can be set when [Auto Exposure in P/A/S/M] is [ON]. 		
 [Master Pedestal Level]	[- 15] to [15] (▶[0])	→ 279	
	You can adjust the black level, which serves as the reference for images.		
 [SS/Gain Operation]	▶[SEC/ISO]/[ANGLE/ISO]/[SEC/dB]	→ 286	
	You can switch the units of shutter speed values and gain (sensitivity) values.		
 [i.Dynamic Range]	[AUTO]/[HIGH]/[STANDARD]/[LOW]▶[OFF]	→ 399	
	Contrast and exposure are compensated when the brightness difference between the background and subject is great.		
 [Vignetting Comp.]	▶[ON]/[OFF]	→ 400	
	When the screen periphery darkens as a result of the lens characteristics, you can record pictures with the brightness of the screen periphery corrected.		
 [Diffraction Compensation]	[AUTO]▶[OFF]	→ 400	
	The camera raises the image resolution by correcting the blurriness caused by diffraction when the aperture is closed.		
 [Filter Settings]	[Filter Effect]	→ 216	
	[Simultaneous Record w/o Filter]		[ON]▶[OFF]/[SET]
	This mode records with additional image effects (filters).		



 **[Video] menu** →  **[Image Format]**



[Rec. File Format]	[AVCHD]/▶[MP4]/[MOV]	→ 255	
	Sets the video recording file format.		
[Image Area of Video]	▶[FULL]/[S35mm]/[PIXEL/PIXEL]	→ 266	
	Sets the image area during video recording.		
[Rec Quality]	Sets the video recording image quality.	→ 255	
[Rec Quality (My List)]	Calls up a recording quality registered in My List.	→ 265	
[Variable Frame Rate]	[ON]/▶[OFF]	→ 297	
	Varies the recording frame rate to record slow motion video and fast motion video.		
[Time Code]	[Time Code Display]	[ON]/▶[OFF]	→ 268
	[Count Up]	▶[REC RUN]/[FREE RUN]	
	[Time Code Value]	[Reset]	
		[Manual Input]	
		[Current Time]	
	[Time Code Mode]	▶[DF]/[NDF]	
	[HDMI Time Code Output]	[ON]/▶[OFF]	
	[External TC Setting]	[TC Synchronization]	
[TC Output Reference]			
Sets the recording, display, and output of the time code.			
[Luminance Level]	[0-255]/[16-235]/▶[16-255]	→ 278	
	You can set the luminance range to suit the purpose of video recording.		

 [Video] menu →  [Focus]



 [AF Custom Setting(Video)]	[ON]▶[OFF]	→ 277
	[SET] [AF Speed]/ [AF Sensitivity]	
You can fine-adjust the focusing method for video recording using [Continuous AF].		
 [Continuous AF]	▶[MODE1]/[MODE2]/[OFF]	→ 275
	You can select how to set the focus in AF when recording videos.	
 [AF Assist Light]	▶[ON]/[OFF]	→ 401
	When recording in low light conditions, the AF assist light turns on when you press the shutter button halfway, making it easier for the camera to focus.	
 [Focus Peaking]	▶[ON]/[OFF]	→ 402
	[SET]	
	[Focus Peaking Sensitivity]	
	[Display Color]	
	[Display While AFS]	
During MF operation, in-focus portions (portions on the screen with clear outlines) are highlighted with color.		
 [1-Area AF Moving Speed]	▶[FAST]/[NORMAL]	→ 403
	Sets the speed when moving a single AF area.	

 [Video] menu →  [Audio]

 [Sound Rec Level Disp.]	[ON]▶[OFF]	→ 283
	The sound recording level is displayed on the recording screen.	
 [Mute Sound Input]	[ON]▶[OFF]	→ 283
	This mutes audio input.	















 [Video] menu →  [Audio]

[Sound Rec Gain Level]	▶[STANDARD]/[LOW]	→ 284
	This switches the gain of audio input.	
[Sound Rec Level Adj.]	[MUTE], [-18dB] to [+12dB] (▶[0dB])	→ 284
	Manually adjust the sound recording level.	
[Sound Rec Level Limiter]	▶[ON]/[OFF]	→ 285
	The sound recording level is adjusted automatically to minimize sound distortion (crackling noise).	
[Wind Noise Canceller]	[HIGH]▶[STANDARD]/[OFF]	→ 285
	This reduces the wind noise coming into the built-in microphone while maintaining sound quality.	
[Wind Cut]	[HIGH]/[STANDARD]/[LOW]▶[OFF]	→ 342
	This reduces wind noise when an external microphone is connected.	
[Mic Socket]	▶[MIC▼]/[MIC]/[LINE]	→ 340
	Sets the [MIC] socket input method that suits the device to be connected.	
[Special Mic.]	▶[STEREO]/[LENS AUTO]/[SHOTGUN]/[S.SHOTGUN]/[MANUAL]	→ 341
	Sets the sound pickup range when using the Stereo Shotgun Microphone (DMW-MS2: optional).	
[XLR Mic Adaptor Setting]	[96kHz/24bit]/[48kHz/24bit]▶[48kHz/16bit]/[OFF]	→ 343
	Sets the audio input for when an XLR Microphone Adaptor (DMW-XLR1: optional) is attached.	
[Sound Output]	▶[REALTIME]/[REC SOUND]	→ 345
	Sets the audio output method when headphones are connected.	

 [Video] menu →  [Audio]

 [Headphone Volume]	[0] to [LEVEL15] (▶[LEVEL3])	→ 346
	Adjusts the volume when headphones are connected.	



 [Video] menu →  [Others (Video)]

 [Silent Mode]	[ON]▶[OFF]	→ 174	
	Disables all operation sounds and light output at once.		
 [Image Stabilizer]	[Operation Mode]	▶[[]]/[] _{AUTO}]/[[]]/[]/[[]]/[OFF]	→ 177
	[Body(B.I.S.) / Lens(O.I.S.)]	[] ^{BODY}]/▶[[]] ^{LENS}]	
	[When to Activate]	[ALWAYS]▶[HALF-SHUTTER]	
	[E-Stabilization (Video)]	[ON]▶[OFF]	
	[Anamorphic (Video)]	A2.0 A1.8 A1.5 [[]]/[]]/[]]/ A1.33 A1.30 [[]]/[]]/▶[OFF]	
	[Lens Information]	[Lens1] to [Lens12] (▶[Lens1])	
	Configures image stabilizer settings.		

 [Video] menu →  [Others (Video)]

[Focus Transition]	[Start]		→ 301
	[Focus Pull Setting]	[1]/[2]/[3]	
	[Focus Transition Speed]	[SH]/[H]/▶[M]/[L]/[SL]	
	[Focus Transition Rec]	[1]/[2]/[3]/▶[OFF]	
	[Focus Transition Wait]	[10SEC]/[5SEC]/▶[OFF]	
	Smoothly transitions the focus position from the current position to a position registered in advance.		
[Loop Recording (video)]	[ON]/▶[OFF]		→ 320
	When the recording fills the card to capacity, recording continues while deleting older data.		
[Segmented File Recording]	[ON]/▶[OFF]		→ 322
	Video is divided every minute while being recorded.		
[Live Cropping]	[40SEC]/[20SEC]/▶[OFF]		→ 304
	By cropping a part of the range displayed in the live view, it is possible to record FHD video that incorporates panning and zooming with the camera staying in a fixed position.		

 [Video] menu →  [Others (Video)]

 [Time Stamp Rec.]	[ON]▶[OFF]	—
	<div data-bbox="326 258 592 297" style="border: 1px solid black; padding: 2px; display: inline-block; margin-bottom: 10px;">  </div> <p>Records the recorded date and time superimposed on the images.</p> <ul style="list-style-type: none"> • You cannot delete recording dates after superimposing them. • The recorded date and time are not recorded in 6K/4K burst files or RAW images. • When the following functions are being used, [Time Stamp Rec.] is not available: <ul style="list-style-type: none"> – [Post-Focus] – [High Resolution Mode] – 6K video/5.9K video/5.4K video/Anamorphic (4:3) video – [Variable Frame Rate] 	



[Custom] Menu

▶: Default settings

⚙ [Custom] menu → 📷 [Image Quality]

[Photo Style Settings]	[Show/Hide Photo Style]	[Vivid]/[Natural]/[Flat]/[Landscape]/[Portrait]/[L.Monochrome]/[L.Monochrome D]/[Cinelike D2]/[Cinelike V2]/[Like709]/[V-Log]/[Like2100(HLG)]/[MY PHOTO STYLE 1] to [MY PHOTO STYLE 10]
	Sets Photo Style items to be displayed on the menu.	
	[My Photo Style Settings]	[Add Effects] [Load Preset Setting]
	Enables detailed image quality adjustment settings for My Photo Style. [Add Effects]: Enables [Dual Native ISO Setting], [Sensitivity], and [White Balance] settings in image quality adjustment. [Load Preset Setting]: Sets the timing at which image quality adjustment values changed in My Photo Style are returned to their registered state.	
	[Reset Photo Style]	Returns details changed in [Photo Style] and [Photo Style Settings] to their default settings.
[ISO Increments]	▶[1/3 EV]/[1 EV]	Changes the intervals between ISO sensitivity adjustment values.

 [Custom] menu →  [Image Quality]

[Extended ISO]	[ON]▶[OFF]	
	<p>Extends the setting range of ISO sensitivity.</p> <ul style="list-style-type: none"> • The extendible range depends on the [Dual Native ISO Setting] (→ 203). <ul style="list-style-type: none"> – When set to [AUTO]: Lower limit can be extended to [50] and the upper limit can be extended to [204800] – When set to [LOW]: Lower limit can be extended to [50] – When set to [HIGH]: Lower limit can be extended to [320] and the upper limit can be extended to [204800] 	
[Exposure Offset Adjust.]	[Multi Metering]	[– 1EV] to [+ 1EV] (▶[±0EV])
	[Center Weighted]	[– 1EV] to [+ 1EV] (▶[±0EV])
	[Spot]	[– 1EV] to [+ 1EV] (▶[±0EV])
	[Highlight Weighted]	[– 1EV] to [+ 1EV] (▶[±0EV])
	<p>Adjusts the exposure level that is the standard correct exposure for each item of [Metering Mode]. Adds the adjustment value from this function to the exposure compensation value (→ 197) when recording.</p> <ul style="list-style-type: none"> • For video recording, [6K/4K PHOTO], and [Post-Focus], it is not possible to add an adjustment value of a range that exceeds ± 3 EV. 	



 [Custom] menu →  [Image Quality]

[Color Space]	▶[sRGB]/[AdobeRGB]	
	<p>This sets the method for correcting the color reproduction of the recorded images on the screens of a PC or on a device such as a printer.</p> <p>[sRGB]: This is widely used in PCs and similar devices.</p> <p>[AdobeRGB]: AdobeRGB is mainly used for business purposes such as professional printing because it has a greater range of reproducible colors than sRGB.</p> <ul style="list-style-type: none"> • Set to [sRGB] if you are not very familiar with AdobeRGB. • When the following functions are being used, the setting is fixed to [sRGB]: <ul style="list-style-type: none"> – Video recording/[6K/4K PHOTO]/[Post-Focus] – [Like709]/[V-Log] ([Photo Style]) – [Filter Settings] 	
[Exposure Comp. Reset]	<p>[ON]/▶[OFF]</p> <p>This resets the exposure value when you change the recording mode or turn off the camera.</p>	
[Auto Exposure in P/A/S/M]	<p>▶[ON]/[OFF]</p> <p>Selects the setting method for aperture value, shutter speed, and ISO sensitivity for the video being recorded in the [P]/[A]/[S]/[M] modes.</p> <p>[ON]: Records with values set automatically by the camera.</p> <p>[OFF]: Records with manually set values.</p>	
[CreativeVideo Combined Set.]	[F/SS/ISO/Exposure Comp.]	▶ [📷] / [👤]
	[White Balance]	▶ [📷] / [👤]
	[Photo Style]	▶ [📷] / [👤]
	[Metering Mode]	▶ [📷] / [👤]
	[AF Mode]	▶ [📷] / [👤]
<p>Content set in [📷M] mode can be separated from when taking pictures.</p> <ul style="list-style-type: none"> • For details, refer to page 252. 		

 [Custom] menu ➔  [Focus/Shutter]

[Focus/Shutter Priority]	[AFS]	▶[FOCUS]/[BALANCE]/[RELEASE]
	[AFC]	[FOCUS]▶[BALANCE]/[RELEASE]
<p>This sets whether to give priority to focus or shutter release during AF.</p> <p>[FOCUS]: Disables recording when focus is not achieved.</p> <p>[BALANCE]: Performs recording while controlling the balance between focusing and shutter release timing.</p> <p>[RELEASE]: Enables recording even when focus is not achieved.</p>		
[Focus Switching for Vert / Hor]	[ON]▶[OFF]	
	<p>This stores separate AF area positions (MF positions for MF Assist) for when the camera is held vertically and when it is held horizontally.</p> <ul style="list-style-type: none"> • For details, refer to page 122. 	
[AF/AE Lock Hold]	[ON]▶[OFF]	
	<p>This sets button operations for AF/AE Lock.</p> <p>Turning this [ON] maintains the lock after releasing the button until it is pressed again.</p>	
[AF+MF]	[ON]▶[OFF]	
	<p>You can fine-adjust the focus manually during AF Lock by rotating the focus ring.</p> <ul style="list-style-type: none"> – When focus mode is [AFS], and the shutter button is pressed halfway – When [AF ON] is pressed – When locked using the Fn button [AF LOCK] or [AF/AE LOCK] 	

 [Custom] menu →  [Focus/Shutter]

	[Focus Ring]	▶[ON]/[OFF]
	[AF Mode]	▶[ON]/[OFF]
	[Press Joystick]	[ON]/▶[OFF]
	[MF Assist Display]	[FULL]/▶[PIP]
[MF Assist]	<p>This sets the display method of MF Assist (enlarged screen).</p> <p>[Focus Ring]: The screen is enlarged by focusing with the lens.</p> <p>[AF Mode]: The screen is enlarged by pressing [].</p> <p>[Press Joystick]: Press the joystick to enlarge the display. (if [Joystick Setting] is set to [D.FOCUS Movement]) (→ 429)</p> <p>[MF Assist Display]: Sets the display method (full screen mode/windowed mode) of MF Assist (enlarged screen).</p> <ul style="list-style-type: none"> • While you are using the following functions, MF Assist will not be displayed: <ul style="list-style-type: none"> – Video recording – [6K/4K Pre-Burst] 	
[MF Guide]	[]/▶[]/[OFF]	
	<p>During MF, MF Guide, which acts as a guide to recording distance, is displayed on the screen. You can select from meters or feet for the display unit.</p>	
[Focus Ring Lock]	[ON]/▶[OFF]	
	<p>This disables the focus ring operation during MF to lock the focus.</p> <ul style="list-style-type: none"> • [MFL] is displayed on the recording screen while the focus ring is locked. • This menu item can be registered to the Fn button. (→ 367) 	

 [Custom] menu ➔  [Focus/Shutter]

[Show/Hide AF Mode]	[Face/Eye/Body/ Animal Detect.]	▶[ON]/[OFF]
	[Tracking]	▶[ON]/[OFF]
	[225-Area]	▶[ON]/[OFF]
	[Zone (Vert./ Horz.)]	▶[ON]/[OFF]
	[Zone (Square)]	[ON]/▶[OFF]
	[Zone (Oval)]	▶[ON]/[OFF]
	[1-Area+]	▶[ON]/[OFF]
	[Pinpoint]	▶[ON]/[OFF]
	[Custom1]	[ON]/▶[OFF]
	[Custom2]	[ON]/▶[OFF]
	[Custom3]	[ON]/▶[OFF]
	Sets the AF mode items to be displayed on the AF mode selection screen.	
[Pinpoint AF Setting]	[Pinpoint AF Time]	[LONG]/▶[MID]/[SHORT]
	[Pinpoint AF Display]	[FULL]/▶[PIP]
	Changes enlarged screen settings displayed when AF mode is [].	
<p>[Pinpoint AF Time]: Sets the time for which the screen is enlarged when the shutter button is pressed halfway.</p> <p>[Pinpoint AF Display]: Sets the display method (full screen mode/windowed mode) of the enlarged screen.</p>		

 [Custom] menu ➔  [Focus/Shutter]



[AF-Point Scope Setting]	[Keep Enlarged Display]	[ON]▶[OFF]
	[PIP Display]	[FULL]▶[PIP]
	Changes the enlarged screen settings of AF-Point Scope (➔ 100).	
	[Keep Enlarged Display]: Setting this to [ON] maintains the enlarged screen after pressing the Fn button until it is pressed again.	
	[PIP Display]: Sets the display method (full screen mode/ windowed mode) of the enlarged screen.	
[Shutter AF]	▶[ON]/[OFF]	
	This adjusts focus automatically when you press the shutter button halfway.	
[Half-Press Shutter]	[ON]▶[OFF]	
	You can release the shutter quickly by pressing the shutter button halfway.	
[Quick AF]	[ON]▶[OFF]	
	When the amount of camera shake becomes small, the camera will automatically adjust the focus and focus adjustment will then be quicker when the shutter button is pressed.	
	<ul style="list-style-type: none"> • The battery will drain faster than usual. • This function is not available in the following cases: <ul style="list-style-type: none"> – In preview mode – In low light situations 	
[Eye Sensor AF]	[ON]▶[OFF]	
	When looking through the viewfinder, if the eye sensor operates, then AF will function.	
	<ul style="list-style-type: none"> • [Eye Sensor AF] may not work in low light situations. 	













[Custom] menu ➔ [Focus/Shutter]



[Looped Focus Frame]	[ON]▶[OFF]
	When moving the AF area or MF Assist, this enables its position to loop from one edge to the other edge of the screen.
[AFC Start Point (225-Area)]	[ON]▶[OFF]
	When the focus mode is set to [AFC] in the  AF mode, you can specify which area to start [AFC]. • For details, refer to page 110.















[Custom] menu ➔ [Operation]



[Q.MENU Settings]	[Layout Style]	▶[MODE1]/[MODE2]
	[Front Dial Assignment]	[Item]▶[Value]
	[Item Customize (Photo)]	
	[Item Customize (Video)]	
	Customizes the Quick menu. • For details, refer to page 378.	
[Touch Settings]	[Touch Screen]	▶[ON]/[OFF]
	[Touch Tab]	[ON]▶[OFF]
	[Touch AF]	▶[AF]/[AF+AE]
	[Touch Pad AF]	[EXACT]/[OFFSET1] to [OFFSET7]/▶[OFF]
	Enables touch operation on the monitor display. [Touch Screen]: All touch operations. [Touch Tab]: Operations of tabs, such as  on the right side of the screen. [Touch AF]: Operation to optimize the focus ([AF]) for a touched subject. Alternatively, operation to optimize both the focus and brightness ([AF+AE]). (➔ 119) [Touch Pad AF]: Touch pad operation during viewfinder display. (➔ 121)	























 [Custom] menu →  [Operation]

[Lock Lever Setting]	[Cursor]	▶[]/[]
	[Joystick]	▶[]/[]
	[Touch Screen]	▶[]/[]
	[Dial]	▶[]/[]
	Sets the operations to be disabled with the operation lock lever. (Only for recording screen)	
	[Cursor]: Cursor buttons, [MENU/SET] button, and 	
	[Joystick]: Joystick	
	[Touch Screen]: Touch screen	
	[Dial]:  ,  , and 	
[Fn Button Set]	[Setting in REC mode]	
	[Setting in PLAY mode]	
	Registers a function to the Fn button.	
	<ul style="list-style-type: none"> • For details, refer to page 369. 	





















 [Custom] menu →  [Operation]



<p>[WB/ISO/Expo. Button]</p>	<p>[WHILE PRESSING]/[AFTER PRESSING1]▶[AFTER PRESSING2]</p> <p>This sets the operation to be performed when [WB] (White balance), [ISO] (ISO sensitivity) or [] (Exposure compensation) is pressed.</p> <p>[WHILE PRESSING]: Allows you to change the setting while pressing and holding the button. Release the button to confirm the settings value, and to return to the recording screen.</p> <p>[AFTER PRESSING1]: Press the button to change settings. Press the button again to confirm the settings value, and to return to the recording screen.</p> <p>[AFTER PRESSING2]: Press the button to change settings. Each press of the button switches the settings value. (Except that of exposure compensation) To confirm your selection and return to the recording screen, press the shutter button halfway.</p>
<p>[ISO Displayed Setting]</p>	<p>[Front/Rear Dials] ▶ [ISO/ISO] / [ / ISO] / [OFF/ISO] / [ISO/ ] / [ISO/OFF]</p> <p>This sets the operations of the dials in the setting screen for ISO sensitivity. Assigning [] lets you change [ISO Auto Upper Limit Setting].</p>
<p>[Exposure Comp. Disp. Setting]</p>	<p>[Cursor Buttons (Up/Down)] []▶[OFF]</p> <p>This sets the operations of the ▲▼ buttons in the exposure compensation screen. Assigning [] lets you set exposure bracketing.</p> <p>[Front/Rear Dials] ▶ [ / ] / [ / ] / [OFF/ ] / [ / ] / [ /OFF]</p> <p>This sets the operations of the dials in the exposure compensation screen. Assigning [] lets you adjust flash output.</p>

 [Custom] menu →  [Operation]

[Dial Set.]	[Assign Dial (F/SS)]	▶[SET1]/[SET2]/[SET3]/[SET4]/[SET5]				
	Sets the operations to be assigned to the dials in [P]/[A]/[S]/[M] modes.					
	P/↗: Program Shift, F: Aperture value, SS: Shutter speed					
			[P]	[A]	[S]	[M]
	[SET1]		P/↗	F	SS	F
			P/↗	F	SS	SS
	[SET2]		–	F	–	F
			P/↗	–	SS	SS
	[SET3]		–	–	SS	SS
			P/↗	F	–	F
[SET4]		–	–	–	F	
		P/↗	F	SS	SS	
[SET5]		P/↗	F	SS	F	
		–	–	–	SS	
[Rotation (F/SS)]	▶   /[ 					
Changes the rotational directions of the dials for aperture value and shutter speed adjustment.						
[Control Dial Assignment]	▶[] ([Headphone Volume])/[]/[] ([Exposure / Aperture])/[] ([Exposure Comp.])/[] ([Sensitivity])/[] ([Focus Frame Size])					
Sets the function to be assigned to  on the recording screen.						
[]/[]: In [M] mode, this assigns the operation to adjust the aperture value. In other than [M] mode, this assigns the operation of exposure compensation.						

[Custom] menu → [Operation]

[Dial Set.] (Continued)	[Exposure Comp.]	[]/[]/[OFF]
	Assigns exposure compensation to  or  . (Except in [M] mode)	
	<ul style="list-style-type: none"> The [Assign Dial (F/SS)] setting takes priority. 	
	[Dial Operation Switch Setup]	[] []
In the Fn button [Dial Operation Switch], this sets the functions to be registered temporarily to  or  . (→ 376)		
[Rotation (Menu Operation)]	▶ []/[]/[]/[]/ []/[]/[]/[]	
Changes the rotational direction of the dials when operating menus.		
[Joystick Setting]	▶ [D.FOCUS Movement]/[Fn]/[MENU]/[OFF]	
	Sets the joystick movement on the recording screen.	
	[D.FOCUS Movement]: Moves the AF area and MF Assist. (→ 118, 123)	
	[Fn]: Operates as Fn buttons. [MENU]: Operates as  . Operations that can be performed by moving the joystick are disabled. [OFF]: Disables the joystick.	
[Illuminated Button]	[ON1]/▶[ON2]/[OFF]	
	Sets how the illuminated button turn on.	
	The following illuminated buttons turn on: – [] button/[Q] button/[] button/[] button/[DISP.] button	
	[ON1]: Buttons remain on while the camera is turned on. [ON2]: The buttons turn on when the camera on/off switch is set to []. The buttons turn off if no operations are performed for a certain period of time. [OFF]: The buttons do not turn on.	

 [Custom] menu →  [Operation]

[Video Rec. Button (Remote)]

You can register a favorite function to the video rec. button on a Shutter Remote Control (optional).

- [Video Record] is registered in the default setting.
- For details, refer to page [540](#).

 [Custom] menu →  [Monitor / Display (Photo)]

[Auto Review]

[Duration Time (photo)]

[HOLD]/[5SEC] to [1SEC]▶[OFF]

[Duration Time (6K/4K PHOTO)]

▶[HOLD]/[OFF]

[Duration Time (Post-Focus)]

▶[HOLD]/[OFF]

[Playback Operation Priority]

[ON]▶[OFF]

This displays an image immediately after it is recorded.

[Duration Time (photo)]: Sets the Auto Review when taking pictures.

[Duration Time (6K/4K PHOTO)]: Sets the Auto Review when recording 6K/4K photos.

[Duration Time (Post-Focus)]: Sets the Auto Review when recording with Post-Focus.

[Playback Operation Priority]: When this is set to [ON], you can toggle the playback screen during Auto Review, or delete pictures.

- If you set [Duration Time (photo)] to [HOLD], the image recorded stays displayed until the shutter button is pressed halfway.

[Playback Operation Priority] will be fixed to [ON].

 [Custom] menu →  [Monitor / Display (Photo)]

[Constant Preview]	[ON]▶[OFF]	
	[SET]	[Preview While MF Assist]
	<p>You can always confirm the effects of aperture and shutter speed on the recording screen when in [M] mode. Preview also operates in the MF Assist screen when [Preview While MF Assist] is set to [ON].</p> <ul style="list-style-type: none"> • This function does not work when using the flash. • This menu item can be registered to the Fn button. <p>(→ 367)</p>	

⚙️ [Custom] menu ➔ 🖨️ [Monitor / Display (Photo)]
[ON]▶️/[OFF]

This displays the histogram.

Turning this [ON] displays the histogram transition screen.

Press ▲▼◀️▶️ to set the position.

Positions can be moved to the diagonal directions using the joystick.

- You can also move the position by dragging the histogram on the recording screen.

- A histogram is a graph that displays brightness along the horizontal axis, and the number of pixels at each brightness level on the vertical axis.

By looking at the distribution of the graph, you can determine the current exposure.

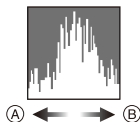

(A) Dark

















(B) Bright

- When the recorded image and the histogram do not match each other under the following conditions, the histogram is displayed in orange:
 - During exposure compensation
 - When the flash fires
 - When the correct exposure is not achieved, such as in low light situations.
- When the following function is being used, the [Histogram] is not available:
 - [WFM/Vector Scope]
- The histogram is an approximation in the recording mode.
- This menu item can be registered to the Fn button.

(➔ 367)

[Histogram]









 [Custom] menu →  [Monitor / Display (Photo)]

<p>[Photo Grid Line]</p>	<p>    [OFF]</p> <p>Sets the grid line pattern to be displayed on the recording screen.</p> <p>When using , you can press ▲▼◀▶ to set the position.</p> <p>Positions can be moved to the diagonal directions using the joystick.</p> <ul style="list-style-type: none"> • When using , you can also drag  on the grid lines on the recording screen to move the position. • This menu item can be registered to the Fn button. (→ 367)
<p>[AF Area Display]</p>	<p>▶[ON]/[OFF]</p> <p>Displays the AF areas for the , , , , ,  AF modes.</p> <ul style="list-style-type: none"> • AF areas are not displayed in the following cases: <ul style="list-style-type: none"> – When [AFC Start Point (225-Area)] is not used during  – When AF area shapes are not registered in  to  • When the following functions are being used, [AF Area Display] is not available: <ul style="list-style-type: none"> – Video recording – [6K/4K PHOTO]

 [Custom] menu →  [Monitor / Display (Photo)]

	[MODE1]/[MODE2]▶[OFF]	
	[SET]	[P/A/S/M]▶[M]
[Live View Boost]	<p>Displays the screen brighter to make it easier to check subjects and compositions even in low-light environment.</p> <p>[MODE1]: Setting for low brightness, with priority given to a soft display.</p> <p>[MODE2]: Setting for high brightness, with priority given to image visibility.</p> <ul style="list-style-type: none"> • You can change the recording mode in which [Live View Boost] works by using [SET]. • This mode does not affect recorded images. • Noise may be more noticeable in the screen than in the recorded image. • This function does not work in the following cases: <ul style="list-style-type: none"> – When adjusting the exposure (when the shutter button is pressed halfway, for example) – When recording a video or 6K/4K photo – When using [Filter Settings] – When using [Constant Preview] • This menu item can be registered to the Fn button. <p>(→ 367)</p>	

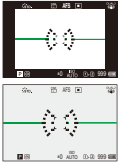

[Custom] menu → [Monitor / Display (Photo)]

	[Monitor]	[ON]/▶[OFF]
	[LVF]	[ON]/▶[OFF]
[Night Mode]	<p>Displays the monitor and viewfinder in red. In dark environments, this reduces brightness of the screen that can make the surroundings difficult to see. You can also set the luminance of the red display.</p> <ol style="list-style-type: none"> Press ▲▼◀▶ to select [ON] on the monitor or viewfinder (LVF). Press [DISP.] to display the brightness adjustment screen. <ul style="list-style-type: none"> Display the monitor to adjust the monitor, and display the viewfinder to adjust the viewfinder. Press ◀▶ to adjust luminance and then press  or . <ul style="list-style-type: none"> This effect is not applied to images output via HDMI. This menu item can be registered to the Fn button. (→ 367) 	
[LVF/Monitor Disp. Set]	[LVF Disp. Set]	 /▶ 
	[Monitor Disp. Set]	 /▶ 
	<p>Selects whether to show the live view without covering the information display, or to display over the entire screen.</p> <p>: Scales down images slightly so you can better review the composition of the images.</p> <p>: Scales images to fill the entire screen so you can see their details.</p>	
		

⚙ [Custom] menu → 📷 [Monitor / Display (Photo)]

[Expo.Meter]	[ON]▶[OFF]											
	<p>This displays the exposure meter.</p> <div data-bbox="467 304 816 412" style="border: 1px solid black; padding: 5px; margin: 10px auto; width: fit-content;"> <table style="border-collapse: collapse; text-align: center;"> <tr> <td style="border: 1px solid black; padding: 2px;">SS</td> <td style="border: 1px solid black; padding: 2px;">125</td> <td style="border: 1px solid black; padding: 2px;">60</td> <td style="border: 1px solid black; padding: 2px;">30</td> <td style="border: 1px solid black; padding: 2px;">15</td> <td style="border: 1px solid black; padding: 2px;">8</td> </tr> <tr> <td style="border: 1px solid black; padding: 2px;">F</td> <td style="border: 1px solid black; padding: 2px;">4.0</td> <td style="border: 1px solid black; padding: 2px;">5.6</td> <td style="border: 1px solid black; padding: 2px;">8.0</td> <td style="border: 1px solid black; padding: 2px;">11</td> <td></td> </tr> </table> <p style="margin-top: 5px;">📷 30 F5.6</p> </div> <ul style="list-style-type: none"> Set to [ON] to display the exposure meter when performing Program Shift, setting aperture, and setting shutter speed. If no operations are performed for a certain period of time, the exposure meter disappears. 	SS	125	60	30	15	8	F	4.0	5.6	8.0	11
SS	125	60	30	15	8							
F	4.0	5.6	8.0	11								
[Focal Length]	▶[ON]/[OFF]											
	<p>Displays the focal length on the recording screen during zoom control.</p>											
[Blinking Highlights]	[ON]▶[OFF]											
	<p>Overexposed areas appear blinking in black and white during Auto Review or playback.</p> <ul style="list-style-type: none"> The display without the highlights is added to the display shown when [DISP.] is pressed in the playback screen. Use this to delete the highlight display. (→ 71) <div data-bbox="733 766 957 914" style="border: 1px solid black; margin: 10px auto; width: 150px; height: 100px;">  </div>											

 [Custom] menu →  [Monitor / Display (Photo)]

[Sheer Overlay]	[ON]▶[OFF]	
	[SET]	[Transparency]
		[Image Select]
		[Reset at Power Off]
	<p>Displays recorded pictures by overlapping on the recording screen.</p> <ul style="list-style-type: none"> • Use [Image Select] to select the pictures to be displayed. Press ◀▶ to select pictures and then press  or  to confirm. • When the following functions are being used, [Sheer Overlay] is not available: <ul style="list-style-type: none"> – Video recording/[6K/4K PHOTO]/[Post-Focus] • This menu item can be registered to the Fn button. (→ 367) 	
[I.S. Status Scope]	[ON]▶[OFF]	
	<p>Displays a reference point on the recording screen in order to let you check for camera shake.</p> <p>Ⓐ Reference point</p> <ul style="list-style-type: none"> • When the following functions are being used, [I.S. Status Scope] is not available: <ul style="list-style-type: none"> – Video recording/[6K/4K PHOTO]/[Post-Focus] • This menu item can be registered to the Fn button. (→ 367) 	

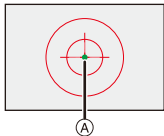

 [Custom] menu →  [Monitor / Display (Photo)]

[Level Gauge]

▶[ON]/[OFF]

Displays the level gauge which is useful in correcting camera tilt.

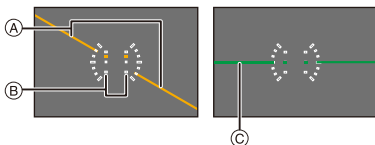

- Ⓐ Horizontal
- Ⓑ Vertical
- Ⓒ Green (no tilt)

- When the camera is not tilted, the level gauge changes to green.
- Even after correcting the tilt, there may still be an error of approx. $\pm 1^\circ$.
- When the camera is tilted significantly upwards or downwards, the level gauge may not be displayed correctly.
- This menu item can be registered to the Fn button. (→ 367)
- You can adjust the level gauge and reset the adjusted values in [Level Gauge Adjust.] in the [Setup] ([Monitor / Display]) menu. (→ 448)

⚙️ [Custom] menu ➡ 📺 [Monitor / Display (Photo)]

[Luminance Spot Meter]	[ON]▶[OFF]	
	Specify any spot on the subject to measure the luminance over a small area. • For details, refer to page 292 .	
[Framing Outline]	[ON]▶[OFF]	
	Displays the outline for the live view.	
[Show/Hide Monitor Layout]	[Control Panel]	▶[ON]/[OFF]
	[Black Screen]	▶[ON]/[OFF]
	Displays the control panel and black screen when switching between displays using [DISP.] button. (➡ 70)	

⚙️ [Custom] menu ➡ 📺 [Monitor / Display (Video)]

[V-Log View Assist]	[Read LUT File]	
	[LUT Select]	
	[LUT View Assist (Monitor)]	[ON]▶[OFF]
	[LUT View Assist (HDMI)]	[ON]▶[OFF]
You can show images with LUT data applied on the monitor/viewfinder, or output them via HDMI. • For details, refer to page 310 .		
[HLG View Assist]	[Monitor]	[MODE1]▶[MODE2]/[OFF]
	[HDMI]	▶[AUTO]/[MODE1]/[MODE2]/[OFF]
	At recording or playback of [HLG Photo] and HLG video, this displays images with converted color gamut and brightness on the camera monitor/viewfinder, or outputs these over HDMI. • For details, refer to page 314 .	

 [Custom] menu →  [Monitor / Display (Video)]

[Anamorphic Desqueeze Display]	$2.0\times$ / $1.8\times$ / $1.5\times$ / $1.33\times$ / $1.30\times$ / [OFF]	
	<p>This displays the de-squeezed images suited to the magnification of the anamorphic lens on this camera.</p> <ul style="list-style-type: none"> For details, refer to page 316. 	
[Monochrome Live View]	[ON] / [OFF]	
	<p>You can display the recording screen in black and white.</p> <ul style="list-style-type: none"> If you use the HDMI output during recording, the output image will not be displayed in black and white. [Monochrome Live View] is not available when [Night Mode] is used. This menu item can be registered to the Fn button. (→ 367) 	
[Center Marker]	[ON] / [OFF]	
	The center of the recording screen will be displayed as [+].	
[Video Frame Marker]	[ON] / [OFF]	
	[SET]	[Frame Aspect]
		[Frame Color]
		[Frame Mask]
<p>A frame with the set aspect ratio is displayed on the recording screen.</p> <ul style="list-style-type: none"> For details, refer to page 295. 		
[Zebra Pattern]	[ZEBRA1] / [ZEBRA2] / [ZEBRA1+2] / [OFF]	
	[SET]	[Zebra 1]
		[Zebra 2]
	<p>Parts that are brighter than the benchmark value are displayed with stripes.</p> <ul style="list-style-type: none"> For details, refer to page 293. 	

 [Custom] menu →  [Monitor / Display (Video)]

[WFM/Vector Scope]	<p>[WAVE]/[VECTOR]▶[OFF]</p> <p>This displays the waveform monitor or the vector scope on the recording screen.</p> <ul style="list-style-type: none"> • For details, refer to page 288.
[Color Bars]	<p>[SMPTE]/[EBU]/[ARIB]</p> <p>The color bars are displayed on the recording screen.</p> <ul style="list-style-type: none"> • For details, refer to page 296.
[Video-Priority Display]	<p>[ON]▶[OFF]</p> <p>When in [iA]/[P]/[A]/[S]/[M] modes, switch the recording screen display, the status LCD display, and the live view angle of view to suit video recording, as with the [M] mode.</p> <p>The playback screen also switches to a display that prioritizes video.</p> <ul style="list-style-type: none"> • When set to a setting where video recording is not available, such as [Post-Focus], [Video-Priority Display] is fixed to [OFF]. • [Video-Priority Display] works only during video recording when using the following functions: <ul style="list-style-type: none"> – [6K/4K PHOTO] – [Time Lapse Shot] – [Stop Motion Animation] – [65:24]/[2:1] ([Aspect Ratio]) – [Multiple Exposure] • This menu item can be registered to the Fn button. (→ 367)
[Red REC Frame Indicator]	<p>[ON]▶[OFF]</p> <p>A red frame is displayed on the recording screen that indicates that video is being recorded.</p>

 [Custom] menu →  [IN/OUT]

[HDMI Rec Output]	[Info Display] (→ 338)	▶[ON]/[OFF]
	[Down Convert] (→ 335)	▶[AUTO]/[4K/30p]([4K/25p])/[1080p]/[1080i]/[OFF]
	[HDMI Recording Control] (→ 338)	[ON]/▶[OFF]
	[Sound Down Convert] (→ 339)	[AUTO]/▶[OFF]
	[Sound Output (HDMI)] (→ 339)	▶[ON]/[OFF]
Sets HDMI output during recording.		
[Fan Mode]	▶[AUTO1]/[AUTO2]/[NORMAL]/[SLOW]	
	<p>Sets fan operation.</p> <p>[AUTO1]: The fan operation switches automatically according to the temperature of the camera. This setting prioritizes controlling rises in temperature in the camera.</p> <p>[AUTO2]: The fan operation switches automatically according to the temperature of the camera. This setting prioritizes reducing fan noise.</p> <p>[NORMAL]: The fan operates constantly at a standard speed.</p> <p>[SLOW]: The fan operates constantly at low speed.</p> <ul style="list-style-type: none"> This menu item can be registered to the Fn button. (→ 367) 	
[Tally Lamp]	▶[FRONT/REAR]/[FRONT]/[REAR]/[OFF]	
	Selects how the tally lamps turn on while recording.	

 [Custom] menu →  [Lens / Others]

[Lens Focus Resume]	[ON]▶[OFF] The camera saves the focus position when you turn it off.
[Focus Ring Control]	▶[NON-LINEAR]/[LINEAR] [SET] [90°] to [360°] (▶[150°])/[Maximum] Sets the amount of movement for focusing using the focus ring. (When using supported lenses) [NON-LINEAR]: Focus responds by accelerating according to rotation speed of the focus ring. [LINEAR]: Focus responds at a constant amount according to the rotational angle of the focus ring. [SET]: Sets the rotational angle of the focus ring for when [LINEAR] is selected. <ul style="list-style-type: none"> • This menu item can be registered to the Fn button. (→ 367)
[Lens Information]	[Lens1] to [Lens12] (▶[Lens1]) When using a lens that does not have a communication function with the camera, register the lens information in the camera. <ul style="list-style-type: none"> • This is linked with [Lens Information] in [Image Stabilizer] under the [Photo] ([Others (Photo)]) menu. • For details, refer to page 183.
[Lens Info. Confirmation]	▶[ON]/[OFF] When you have attached a lens that does not have a communication function with this camera, a message asking for confirmation of the lens information is displayed when you turn on the camera.



[Setup] Menu

▶: Default settings



[Setup] menu → [Card/File]

[Card Format]	[Card Slot 1]/[Card Slot 2]	
	Formats the card (initialization). <ul style="list-style-type: none"> • For details, refer to page 50. 	
[Double Card Slot Function]	[Recording Method]	▶
	This sets the way recording to the card slots 1 and 2 is performed. <ul style="list-style-type: none"> • For details, refer to page 92. 	
[Folder / File Settings]	[Select Folder]/[Create a New Folder]/[File Name Setting]	
	Set the folder and file name where to save the images. <ul style="list-style-type: none"> • For details, refer to page 93. 	
[File Number Reset]	[Card Slot 1]/[Card Slot 2]	
	Resets the file number of the next recording to 0001. <ul style="list-style-type: none"> • For details, refer to page 95. 	
[Copyright Information]	[Artist]	[ON]/▶[OFF]/[SET]
	[Copyright Holder]	[ON]/▶[OFF]/[SET]
	[Display Copyright Info.]	
	Records the names of the artist and the copyright holder in the image Exif data. <ul style="list-style-type: none"> • You can register names from [SET] in [Artist] and [Copyright Holder]. For information on how to enter characters, refer to page 464. • Up to 63 characters may be entered. • You can confirm registered copyright information in [Display Copyright Info.]. • Copyright information cannot be registered in AVCHD videos. 	

 [Setup] menu →  [Monitor / Display]

[Power Save Mode]	[Sleep Mode]	[10MIN.]▶[5MIN.]/[2MIN.]/[1MIN.]/[OFF]
	[Sleep Mode(Wi-Fi)]	▶[ON]/[OFF]
	[Auto LVF/Monitor Off]	▶[5MIN.]/[2MIN.]/[1MIN.]/[OFF]
	[Power Save LVF Shooting]	[Time to Sleep]
		[Method of Activation]
<p>This is a function to automatically turn the camera to sleep (power save) status or turn off the viewfinder/monitor if no operation is performed for a set time.</p> <ul style="list-style-type: none"> • For details, refer to page 46. 		
[Monitor Frame Rate]	[30fps]▶[60fps]	
	<p>Sets the display speed for live view on the monitor when recording pictures.</p> <p>[30fps]: Reduces the power consumption for a longer operating time.</p> <p>[60fps]: Enables smooth display of movements.</p> <ul style="list-style-type: none"> • When the following functions are being used, [Monitor Frame Rate] is not available: <ul style="list-style-type: none"> – [6K/4K PHOTO] – HDMI output 	
[LVF Frame Rate]	▶[60fps]/[120fps]	
	<p>Sets the display speed for live view on the viewfinder when recording pictures.</p> <p>[60fps]: Reduces the power consumption for a longer operating time.</p> <p>[120fps]: Enables smooth display of movements.</p> <ul style="list-style-type: none"> • [LVF120] is displayed on the viewfinder when it is displayed at [120fps]. • When the following functions are being used, [LVF Frame Rate] is not available: <ul style="list-style-type: none"> – [6K/4K PHOTO] – HDMI output 	



 [Setup] menu →  [Monitor / Display]



[Monitor Settings]/ [Viewfinder]	<p>[Brightness]/[Contrast]/[Saturation]/[Red Tint]/[Blue Tint]</p> <p>This adjusts the brightness, coloring, and red or blue tints of the monitor/viewfinder.</p> <ol style="list-style-type: none"> 1 Press ▲▼ to select the setting item, and press ◀▶ to adjust. 2 Press  or  to confirm the setting. <ul style="list-style-type: none"> • It will adjust the monitor when the monitor is in use, and the viewfinder when the viewfinder is in use.
[Monitor Backlight]/ [LVF Luminance]	<p>▶[AUTO]/[-3] to [+3]</p> <p>Adjusts monitor/viewfinder luminance.</p> <p>[AUTO]: The brightness is adjusted automatically depending on how bright it is around the camera.</p> <ul style="list-style-type: none"> • Adjusts the monitor luminance when displaying the monitor, and the viewfinder luminance when displaying the viewfinder. • When either [AUTO] is set, or the adjusted value is set to positive side, the usage period will shorten. • When [Night Mode] is being used, [Monitor Backlight]/[LVF Luminance] are not available.
[Remaining Battery Level]	<p>▶[]/[%]</p> <p>Switches the battery remaining level display between a bar and a percentage (%) display.</p>















 [Setup] menu →  [Monitor / Display]



[Status-LCD]	[Character/ Background Color]	▶[A]/[A]
	Changes the text color and background color for the status LCD.	
	[A]: Makes the text white and the background black. [A]: Makes the text black and the background white.	
	[Backlight]	▶[H]/[L]/[OFF]
Sets how the status LCD backlight turns on.		
[H]: Brightens the status LCD backlight. [L]: Darkens the status LCD backlight. [OFF]: Turns off the status LCD backlight.		
[Display While Power Off]	▶[ON]/[OFF]	
When set to [ON], this displays the following information on the status LCD even when the camera is turned off:		
<ul style="list-style-type: none"> – Battery indication – Card slot – Number of still images that can be taken/Video recording time – Wi-Fi/Bluetooth connection state – Charging/charging complete/charging error displays 		
[Eye Sensor]	[Sensitivity]	▶[HIGH]/[LOW]
	This will set the sensitivity of the eye sensor.	
	[LVF/Monitor Switch]	▶[LVF/MON AUTO] (automatic viewfinder/monitor switching)/ [LVF] (viewfinder)/ [MON] (monitor)
This will set the method for switching between the viewfinder and monitor.		
<ul style="list-style-type: none"> • If you press [LVF] to switch the display, the [LVF/Monitor Switch] setting will also switch. 		

















 [Setup] menu →  [Monitor / Display]



[Level Gauge Adjust.]	[Adjust.]
	Hold the camera in a horizontal position, and press  or  . The level gauge will be adjusted.
	[Level Gauge Value Reset]
	Restores the default level gauge setting.

 [Setup] menu →  [IN/OUT]

[Beep]	[Beep Volume]	[] (High)/▶[] (Low)/[] (Off)
	[AF Beep Volume]	[] (High)/▶[] (Low)/[] (Off)
	[AF Beep Tone]	▶[] (Pattern 1)/[] (Pattern 2)/[] (Pattern 3)
	[E-Shutter Vol]	[] (High)/▶[] (Low)/[] (Off)
	[E-Shutter Tone]	▶[] (Pattern 1)/[] (Pattern 2)/[] (Pattern 3)
<p>Sets the beep sounds, AF beep, and electronic shutter sounds.</p> <ul style="list-style-type: none"> • When [Silent Mode] is being used, [Beep Volume], [AF Beep Volume], and [E-Shutter Vol] are fixed to [OFF]. 		
[Headphone Volume]	[0] to [LEVEL15] (▶[LEVEL3])	<p>Adjusts the volume when headphones are connected.</p> <ul style="list-style-type: none"> • This functions in tandem with [Headphone Volume] in the [Video] ([Audio]) menu. • For details, refer to page 346.
[Wi-Fi]	[Wi-Fi Function] (→ 466)	
	[Wi-Fi Setup] (→ 517)	

 [Setup] menu →  [IN/OUT]

[Bluetooth]	[Bluetooth] (→ 469)		
	[Send Image (Smartphone)] (→ 496)		
	[Remote Wakeup] (→ 489)		
	[Returning from Sleep Mode] (→ 482)		
	[Auto Transfer] (→ 486)		
	[Location Logging] (→ 488)		
	[Auto Clock Set] (→ 490)		
	[Wi-Fi network settings]		
<p>[Wi-Fi network settings]: Registers the Wi-Fi access point. Wireless access points used to connect the camera to Wi-Fi networks will be registered automatically.</p>			
[USB]	<table border="1"> <tr> <td>[USB Mode]</td> <td> ▶  [Select on connection]/  [PC(Storage)]/  [PC(Tether)]/  [PictBridge(PTP)] </td> </tr> </table>	[USB Mode]	▶  [Select on connection]/  [PC(Storage)]/  [PC(Tether)]/  [PictBridge(PTP)]
	[USB Mode]	▶  [Select on connection]/  [PC(Storage)]/  [PC(Tether)]/  [PictBridge(PTP)]	
	<p>This sets the communication method to be used when the USB connection cable is connected.</p>		
	<p> [Select on connection]: Select this setting to select the USB communication system when connecting to another device.</p>		
	<p> [PC(Storage)]: Select this setting to export images to a connected PC.</p>		
<p> [PC(Tether)]: Select this setting to control the camera from a PC installed with "LUMIX Tether".</p>			
<p> [PictBridge(PTP)]: Select this setting when connecting to a printer that supports PictBridge.</p>			
[USB Power Supply]	▶ [ON]/[OFF]		
<p>Provides power from the USB connection cable. (→ 43)</p> <ul style="list-style-type: none"> • Even if this item is set to [OFF], power will be supplied when the AC adaptor is connected. 			

 [Setup] menu →  [IN/OUT]

[Battery Information]

Displays the remaining level and degree of deterioration of the battery.



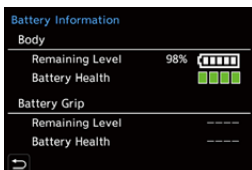

If the usage duration drops significantly even when the battery is fully charged, then the battery is at the end of its service life.

Check its status, and replace with a new battery.



[Remaining Level]: Displays the battery remaining level as a percentage (1% units) and as a bar.

[Battery Health]:

-  (Green): No deterioration
-  (Green): Slight deterioration
-  (Green): Moderate deterioration
-  (Red): Significant deterioration. Replace with a new battery.



- Batteries have lower rechargeable capacity in colder ambient temperatures. Even if a new battery is charged at around 5 °C (41 °F) or below, [Battery Information] may show significant deterioration. When this is again charged with a temperature range from 10 °C to 30 °C (50 °F to 86 °F), the indication for the degree of deterioration returns to “No deterioration”.

[Battery Use Priority]



[BODY] / ▶ [BG]

Selects which battery to use first when the batteries are installed in both the camera and the Battery Grip.



- For details, refer to page [539](#).

 [Setup] menu →  [IN/OUT]

[TV Connection]	[HDMI Mode (Playback)]	▶[AUTO]/[C4K/60p]/[C4K/50p]/[C4K/30p]/[C4K/25p]/[C4K/24p]/[4K/60p]/[4K/50p]/[4K/30p]/[4K/25p]/[4K/24p]/[1080p]/[1080i]/[720p]/[576p]/[480p]
	Sets the HDMI output resolution for playback. [AUTO]: Outputs with a resolution suited to the connected TV. <ul style="list-style-type: none"> • The items you can select depend on the [System Frequency] setting. • If no image appears on the TV with [AUTO], switch to a constant setting other than [AUTO] to set a format supported by your TV. (Refer to the operating instructions for the TV.) 	
	[LUT View Assist (HDMI)]	[ON]/▶[OFF]
	Images with LUT (Look-Up Table) data applied are output when you play back videos recorded with [Photo Style] set to [V-Log]. <ul style="list-style-type: none"> • This is linked with [LUT View Assist (HDMI)] in [V-Log View Assist] under the [Custom] ([Monitor / Display (Video)]) menu. • For details, refer to page 310. 	
[HLG View Assist (HDMI)]	▶[AUTO]/[MODE1]/[MODE2]/[OFF]	
At recording or playback of [HLG Photo] and HLG video, this converts their color gamut and brightness for display. <ul style="list-style-type: none"> • This is linked with [HDMI] in [HLG View Assist] under the [Custom] ([Monitor / Display (Video)]) menu. • For details, refer to page 314. 		





 [Setup] menu →  [IN/OUT]



[TV Connection] (Continued)	[VIERA Link (CEC)]	[ON]▶[OFF]
	<p>You can use the device remote control to operate the camera when it is connected to a VIERA Link compatible device using an HDMI cable.</p> <ul style="list-style-type: none"> • For details, refer to page 525. 	
	[Background Color(Playback)]	[■]▶[■]
	<p>Sets the color of the bands displayed on the top and bottom or the left and right of images output on a TV or similar display.</p> <ul style="list-style-type: none"> • We recommend setting to [■] to prevent burn-in on the screen of the output destination. 	
	[Photo Luminance Level]	[0-255]▶[16-255]
	<p>Sets the level of luminance when outputting pictures to TVs, etc.</p> <ul style="list-style-type: none"> • When pictures recorded with [HLG Photo] are output without converting with [HLG View Assist], they are output with the setting [64-940]. 	
[Card Access Light]	▶[ON]/[OFF]	
	<p>The card access light turns on while the card is being accessed.</p>	



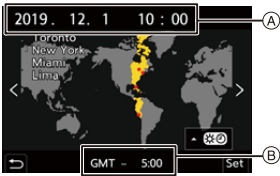

 [Setup] menu →  [Setting]

[Save to Custom Mode]	[C1]/[C2]/[C3-1] to [C3-10] You can register the currently set information of the camera. • For details, refer to page 383 .
[Load Custom Mode]	[C1]/[C2]/[C3-1] to [C3-10] Calls up registered Custom mode settings to the selected recording mode and overwrites the current settings with these. • For details, refer to page 386 .
[Custom Mode Settings]	[Limit No. of Custom Mode]
	[Edit Title]
	[How to Reload Custom Mode]
	[Select Loading Details]
[Save/Restore Camera Setting]	Sets the ease of use of Custom mode. • For details, refer to page 384 .
	[Save]/[Load]/[Delete]/[Keep Settings While Format] Saves the camera's settings information to the card. Saved settings information can be loaded to the camera, letting you set the same settings on multiple cameras. • For details, refer to page 389 .
[Reset]	Returns the camera to its default settings. • For details, refer to page 80 .

[Setup] menu → [Others]

[Clock Set]	<p>Sets the date and time.</p> <ul style="list-style-type: none"> For details, refer to page 56.
[Time Zone]	<p>Sets the time zone.</p> <p>Press ◀▶ to select the time zone and then press  or  to confirm.</p> <p>(A) Current time (B) Time difference from GMT (Greenwich Mean Time)</p>  <ul style="list-style-type: none"> If you are using Daylight Savings [], press ▲. (The time will move forward by 1 hour.) To return to the normal time, press ▲ again.
[System Frequency]	<p>▶[59.94Hz (NTSC)]/[50.00Hz (PAL)]/[24.00Hz (CINEMA)]</p> <p>This changes the system frequency of videos that are recorded and played back with the camera.</p> <ul style="list-style-type: none"> For details, refer to page 253.
[Pixel Refresh]	<p>This optimizes the image sensor and image processing.</p> <ul style="list-style-type: none"> The image sensor and image processing are optimized when the camera is purchased. Use this function when bright spots that do not exist in the subject get recorded. Turn the camera off and on after the pixels are corrected.
[Sensor Cleaning]	<p>Dust reduction to blow off the debris and dust that have affixed to the front of the image sensor is performed.</p> <ul style="list-style-type: none"> The dust reduction function will operate automatically when you set the camera on/off switch to [ON], but you can use this function when the dust is particularly noticeable.

 [Setup] menu →  [Others]

[Language]	<p>This set the language displayed on the screen.</p> <ul style="list-style-type: none"> • If you set a different language by mistake, select [, , ] from the menu icons to set the desired language.
[Firmware Version]	<p>[Firmware Update]/[Software info]</p> <p>You can check the firmware versions of the camera and lens.</p> <p>In addition, you can update the firmware, and display information about the camera software.</p> <p>[Firmware Update]: Updates firmware.</p> <ol style="list-style-type: none"> 1 Download the firmware from the site on page 19. 2 Save the firmware to the root directory of the card (the first folder that appears when you access the card on your PC), and then insert the card into the camera. 3 Select [Firmware Update], press  or , and then select [Yes] to update the firmware. <p>[Software info]: Displays information about the camera software.</p> <ul style="list-style-type: none"> • When a supported optional item (XLR Microphone Adaptor, etc.) is attached to the camera, you can also check its firmware version.
[Online Manual]	<p>[URL display]/[QR Code display]</p> <p>Displays the URL or QR code in order to download the "Owner's Manual" (PDF format).</p>
[Approved Regulations]	<p>Displays the certification number for radio regulations.</p>

[Playback] Menu







- Images recorded by another device may not be correctly played back or edited with the camera.

❖ How to Select an Image(s) in the [Playback] menu

Follow the steps below when the image selection screen is displayed.







- When [Single] and [Multi] are not available, select an image in the same way as when [Single] is selected.
- Images are displayed separately by card slot.
To switch the card to display, press [] and select the card slot.
- You can only select images on one card at a time.

When [Single] has been selected

- 1 Press  to select the image.
- 2 Press  or  .
 - If [Set/Cancel] is displayed at the right bottom of the screen, the setting is canceled when  or  is pressed again.









When [Multi] has been selected

- 1 Press    to select the image and then press  or  (repeat).
 - The setting is canceled when  or  is pressed again.
- 2 Press [DISP.] to execute.



When [Protect] is selected

Press    to select the image, and then press  or  to set (repeat).

- The setting is canceled when  or  is pressed again.







▶: Default settings



▶ [Playback] → [Playback Mode]

[Playback Mode]	▶[Normal Play]/[Picture Only]/[Video Only]/[HLG Only] Filters the type of images to play back.
[Slide Show]	<p>[ALL]/[Picture Only]/[Video Only]/[HLG Only]</p> <p>Selects image types and plays them back at regular intervals in order.</p> <p>[Start]: Starts slide show playback.</p> <p>[Duration]: Sets repeat playback.</p> <p>[Repeat]: Sets repeat playback.</p> <p>Operations during slide show</p> <p>▲:Plays/pauses. You can also perform the same operation by touching [▶] or [⏸].</p> <p>◀: Move to the previous image</p> <p>▶: Move to the next image</p> <p>▼: Ends the slide show</p> <p>⚙️: Adjusts the volume You can also perform the same operation by touching [−] or [+].</p> <ul style="list-style-type: none"> • When [Video Only] is set, [Duration] is not available.
[Rotate Disp.]	▶[ON]/[OFF] Automatically displays pictures vertically if they were recorded when holding the camera vertically.
[Picture Sort]	[FILE NAME]▶[DATE/TIME] This sets the order in which the camera displays images during playback. <p>[FILE NAME]: Displays images by folder name/file name.</p> <p>[DATE/TIME]: Displays images by recording date.</p> <ul style="list-style-type: none"> • If you insert another card, it may take some time to read all data, therefore pictures may not be displayed in the set order.







 **[Playback]** ➔  **[Process Image]**

[RAW Processing]	<p>Processes pictures taken in RAW format on the camera and saves them in JPEG format. In addition, RAW images recorded using [HLG Photo] can be saved in HLG format.</p> <ul style="list-style-type: none"> • For details, refer to page 359.
[6K/4K PHOTO Bulk Saving]	<p>You can save any 5 second period of pictures from a 6K/4K burst file all at once.</p> <ul style="list-style-type: none"> • For details, refer to page 148.
[6K/4K PHOTO Noise Reduction]	<p>▶[AUTO]/[OFF]</p> <p>When saving pictures, reduce the noise that occurs due to high ISO sensitivity.</p> <ul style="list-style-type: none"> • For details, refer to page 144.
[Time Lapse Video]	<p>This creates videos from group images recorded with [Time Lapse Shot].</p> <ol style="list-style-type: none"> 1 Press ◀▶ to select a [Time Lapse Shot] group and then press  or . 2 Select the options for creating a video to combine the pictures into a video. <ul style="list-style-type: none"> • For details, refer to page 156. <ul style="list-style-type: none"> • When [System Frequency] is set to [24.00Hz (CINEMA)], [Time Lapse Video] is not available.
[Stop Motion Video]	<p>This creates videos from group images recorded with [Stop Motion Animation].</p> <ol style="list-style-type: none"> 1 Press ◀▶ to select the Stop Motion Animation group and then press  or . 2 Select the options for creating a video to combine the pictures into a video. <ul style="list-style-type: none"> • For details, refer to page 156. <ul style="list-style-type: none"> • When [System Frequency] is set to [24.00Hz (CINEMA)], [Stop Motion Video] is not available.

 **[Playback]** ➔  **[Add/Delete Info.]**

<p>[Protect]</p>	<p>[Single]/[Multi]/[Cancel]</p> <p>You can set protection for images so that they will not be deleted by mistake.</p> <p>However, if you format the card, the protected images will also be deleted.</p> <ul style="list-style-type: none"> • For information about how to select images, refer to page 456. • [Cancel] only allows to cancel settings at once for the images in a single card. • Be careful because the [Protect] setting may be disabled on a device other than this camera. • This menu item can be registered to the Fn button. (➔ 367)
<p>[Rating]</p>	<p>[Single]/[Multi]/[Cancel]</p> <p>If you set any of the five different rating levels for images, you can do the following:</p> <ul style="list-style-type: none"> • Deleting all images except for those with ratings. • Check the rating level in the file details display in operating systems such as Windows 10, Windows 8.1, and Windows 8. (JPEG images only) <ol style="list-style-type: none"> 1 Select an image. (➔ 456) 2 Press  to select a rating level (1 to 5) and then press  or  . <ul style="list-style-type: none"> • When [Multi] is selected, repeat Steps 1 and 2. • To cancel the setting, set the rating level to [OFF]. <ul style="list-style-type: none"> • [Cancel] only allows to cancel settings at once for the images in a single card. • AVCHD videos can be set to "5" only. • This menu item can be registered to the Fn button. (➔ 367)

 [Playback] →  [Edit Image]

<p>[Resize]</p>	<p>[Single]/[Multi]</p> <p>Reduce the picture size of JPEG images and save them as different images to enable them to be easily used for web pages or sent as email attachments.</p> <ul style="list-style-type: none"> • For information about how to select images, refer to page 456. <ul style="list-style-type: none"> – When [Single] is selected, after choosing the image, press ▲▼ to select the size, then press  or . – When [Multi] is selected, before choosing the images, press ▲▼ to select the size, then press  or . • You can set up to 100 images at once with [Multi]. • The image quality of the resized image becomes lower. • [Resize] is not available for images recorded using the following functions: <ul style="list-style-type: none"> – Video recording/[6K/4K PHOTO]/[Post-Focus] – Group images – [65:24]/[2:1] ([Aspect Ratio]) – [RAW] ([Picture Quality]) – [HLG Photo] – [High Resolution Mode] – Pictures created from [C4K] video
<p>[Rotate]</p>	<p>Rotate images manually in 90° steps.</p> <p>: Rotates 90° clockwise.</p> <p>: Rotates 90° counter-clockwise.</p> <ul style="list-style-type: none"> • For information about how to select images, refer to page 456.
<p>[Video Divide]</p>	<p>Divide a recorded video or 6K/4K burst file into two.</p> <ul style="list-style-type: none"> • For details, refer to page 364.



▶ [Playback] ⇒ ✂ [Edit Image]

[Copy]	[Copy Direction] ▶ [1 → 2]/[2 → 1]
	[Select Copy]/[Copy All in Folder]/[Copy All in Card]
	<p>You can copy the images in one of the cards to the other card.</p> <ul style="list-style-type: none"> • Copied images will be saved in a new folder. <p>[Select Copy]: Copies selected images.</p> <ol style="list-style-type: none"> 1 Select the folder containing the images to copy. 2 Select the images. (→ 456) <p>[Copy All in Folder]: Copies all images in a folder.</p> <ol style="list-style-type: none"> 1 Select the folder to copy. 2 Check the images to be copied and then press  or  to execute copying. <p>[Copy All in Card]: Copies all images in the card.</p> <p>Using the Fn button to copy images</p> <p>If you press the Fn button with [Copy] assigned while playing back images one at a time, the image currently being played back will be copied to the other card.</p> <ul style="list-style-type: none"> • Select the copy destination folder from the following options. In the case of group images, [Create a New Folder] is selected automatically. <p>[Same Folder Number as Source]: Copies to a folder with the same name as the folder of the image to be copied.</p> <p>[Create a New Folder]: Creates a new folder with an incremented folder number and then copies the image to it.</p> <p>[Select Folder]: Selects a folder to store the image and then copies the image to it.</p>

 **[Playback]** ⇒  **[Edit Image]**

**[Copy]
(Continued)**

- You can set up to 100 images at once with [Select Copy].
- The [Protect] setting is not copied.
- Copying may take a while.
- AVCHD videos cannot be copied.
- When using the following combinations of cards, videos, 6K/4K photos, and images recorded with [Post-Focus] cannot be copied:
 - Copying from an SDXC memory card to an SD memory card or SDHC memory card

 **[Playback]** ⇒  **[Others]**

**[Delete
Confirmation]**

["Yes" first]/▶["No" first]

This sets which option, [Yes] or [No], will be highlighted first when the confirmation screen for deleting an image is displayed.









["Yes" first]: [Yes] is highlighted first.

["No" first]: [No] is highlighted first.

Entering Characters



Follow the steps below when the character entry screen is displayed.

1 Enter characters.

- Press ▲▼◀▶ to select characters and then press  or  until the character to enter is displayed.
(Repeat this)
- To repeatedly enter the same character, rotate  or  to the right to move the entry position cursor.
- If you select an item and press  or , you can perform the following operations:
 - []: Change the character type to [A] (upper case characters), [a] (lower case characters), [1] (numbers), and [&] (special characters)
 - []: Enter a blank
 - [Delete]: Delete a character
 - [<]: Move the entry position cursor to the left
 - [>]: Move the entry position cursor to the right
- When entering a password, (A) shows the number of characters you have entered and the number of characters you can enter.



2 Complete entering.

- Select [Set] and then press  or .

16. Wi-Fi/Bluetooth

This chapter explains the Wi-Fi® and Bluetooth® functions of the camera.

Remote Operations from a Smartphone



You can use the “LUMIX Sync” smartphone app for remote recording and image transfers.

→ 467

Transferring Images from This Camera





You can transfer images to another device, such as a smartphone or PC, by operating the camera.

→ 492

This document refers to both smartphones and tablets as **smartphones**.





• Checking operation of the Wi-Fi and Bluetooth functions

Operation of the Wi-Fi and Bluetooth functions can be confirmed with the []/[] icon on the status LCD.

Status LCD Display Monitor Display



- (A) The Bluetooth function is set to on, or there is a connection
- (B) The Wi-Fi function is set to on, or there is a connection

When image data is sent using a camera operation, [] on the status LCD blinks and [] is displayed on the monitor.



- Do not remove the card or battery or move to an area without any reception while sending images.
- The camera cannot be used to connect to a public wireless LAN connection.
- We strongly recommend that you set an encryption to maintain information security.
- We recommend that you use a sufficiently charged battery when sending images.
- When the remaining battery level is low, it may not be possible to connect to or maintain communication with other devices.
(A message such as [Communication error] is displayed.)
- Images may not be completely sent depending on radio wave conditions.
If the connection is terminated while sending images, images with missing parts may be sent.

Connecting to a Smartphone

Connect with a smartphone which has the “Panasonic LUMIX Sync” (below: “LUMIX Sync”) smartphone app installed.

Use “LUMIX Sync” for remote recording and image transfers.

Flow of connecting a smartphone

1	Install “LUMIX Sync” on your smartphone. (→ 468) Connect to a network, and install “LUMIX Sync”  .	
2	Connect to a smartphone. Connect the camera and the smartphone using a method depending on the smartphone.	
	Using a smartphone that supports Bluetooth Low Energy • Bluetooth connection (→ 469) Connect using simple connection setup procedure (pairing).	Using a smartphone that does not support Bluetooth Low Energy • Wi-Fi connection (→ 473) Connect with Wi-Fi. You can also use a QR code to connect easily.
3	Operate the camera using the smartphone. (→ 479) Using “LUMIX Sync” to carry out the following operations: <ul style="list-style-type: none"> • [Remote shooting] (→ 480) • [Shutter Remote Control] (→ 481) • [Import images] (→ 484) • [Auto Transfer] (→ 486) • [Location Logging] (→ 488) • [Remote Wakeup] (→ 489) • [Auto Clock Set] (→ 490) • [Camera settings copy] (→ 491) <div style="display: flex; justify-content: space-around; align-items: center;">   </div>	

- You can also use the camera to transfer images to a smartphone.
- For details, refer to “Sending Images from the Camera” on page 492.

Installing “LUMIX Sync”

“LUMIX Sync” is an application for smartphones provided by Panasonic.

Supported OS

Android™: Android 5 or higher

iOS: iOS 11 or higher

- 1** Connect the smartphone to a network.
- 2** (Android) Select “Google Play™ Store”.
(iOS) Select “App Store”.
- 3** Enter “Panasonic LUMIX Sync” or “LUMIX” into the search box.
- 4** Select and install the “Panasonic LUMIX Sync” .



- Use the latest version.
- Supported OSs are current as of August 2019 and are subject to change.
- Some of the screens and information provided in this document may differ from your device depending on the supported OS and “LUMIX Sync” version.
- Read the [Help] in the “LUMIX Sync” menu for further details on how to operate.
- The app may not operate correctly depending on your smartphone.
For information on the “LUMIX Sync”, refer to the following support site:
<https://panasonic.jp/support/global/cs/dsc/>
(English only)
- Depending on your data plan, downloading the app or transferring pictures and videos via a mobile network, such as 4G (LTE) or 3G, may incur high data usage charges.

Connecting to a Smartphone (Bluetooth Connection)

Follow a simple connection setup procedure (pairing) to connect to a smartphone that supports Bluetooth Low Energy.

When pairing is set up, the camera also automatically connects to the smartphone via Wi-Fi.

- For the first-time connection, pairing settings are required.

For information about connecting for the second and subsequent times, refer to page [472](#).

Supported smartphones

Android™: Android 5 or higher with Bluetooth 4.0 or higher
(excluding those that do not support Bluetooth Low Energy)

iOS: iOS 11 or higher

1 On the smartphone, start up “LUMIX Sync”.

- A message regarding device (camera) registration is displayed. Select [Next].

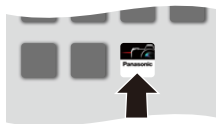

- If you have closed the message, select [, then register the camera using [Camera registration (pairing)].
- A message is displayed if the Bluetooth function of the smartphone is turned off. (For Android devices) Allow turning on the Bluetooth function.





(For iOS devices) Follow the message to turn on the Bluetooth function in the settings screen of the smartphone and then display “LUMIX Sync”.

2 Check the content in the displayed guide and select [Next] until the screen to register the camera is displayed.

Operating the camera in accordance with the smartphone guide.

3 Set the camera to Bluetooth pairing standby state.

- **MENU/SET** ⇒ [] ⇒ [] ⇒ [Bluetooth] ⇒ [Bluetooth] ⇒ [SET] ⇒ [Pairing]
- The camera enters pairing standby state and the device name **(A)** is displayed.



4 On the smartphone, select the camera's device name.

- (iOS devices) When a message to confirm the change of destination is displayed, select [Join].

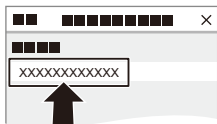

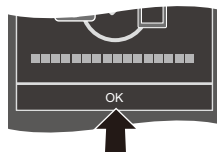

5 When a message indicating that device registration is complete, select [OK].

- A Bluetooth connection between the camera and the smartphone will be made.







- The paired smartphone is registered as a paired device.
- During Bluetooth connection, [] is displayed in the recording screen. When the Bluetooth function is enabled, but a connection is not established with the smartphone, [] appears translucent.
- Up to 16 smartphones can be registered. If you try to register more than 16 smartphones, the registration information will be deleted from the oldest first.
- (iOS devices) If the Wi-Fi connection attempt fails during Bluetooth connection, follow the message displayed to allow connection to the camera. If you still cannot connect, select the SSID of the camera on the Wi-Fi setup screen of the smartphone to connect. If the SSID is not displayed, turn off and on the camera, then perform the Bluetooth connection settings again.

❖ End Bluetooth Connection

To terminate the Bluetooth connection, turn off the Bluetooth function of the camera.





⇒ [] ⇒ [] ⇒ [Bluetooth] ⇒ [Bluetooth] ⇒ Select [OFF]



- Even if you terminate the connection, the pairing information for it will not be deleted.

❖ Connecting to a Paired Smartphone

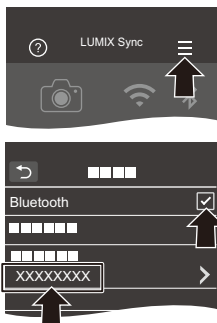

Connect paired smartphones using the following procedure.

- 1 Enable the Bluetooth function of the camera.
 - **MENU/SET** ⇒ [] ⇒ [] ⇒ [Bluetooth] ⇒ [Bluetooth] ⇒ [ON]
- 2 On the smartphone, start up “LUMIX Sync”.
 - If a message is displayed indicating that the smartphone is searching for cameras, close the message.
- 3 Select [].
- 4 Select [Bluetooth Setup].
- 5 Turn Bluetooth ON.
- 6 From [Camera registered] items, select the camera's device name.



- Even if you set up pairing with more than one smartphone, you can only connect to one smartphone at a time.
- When pairing takes some time, canceling the pairing settings on both the smartphone and camera and re-establishing the connection may result in the camera being detected correctly.

❖ Canceling Pairing

- 1 Cancel the pairing setting of the camera.
 -  ⇒ [] ⇒ [] ⇒ [Bluetooth] ⇒ [Bluetooth] ⇒ [SET] ⇒ [Delete]
- 2 Select the smartphone for which to cancel the pairing.



- Also cancel the pairing setting on the smartphone.
- When [Reset] in the [Setup] ([Setting]) menu is used to reset the network settings, the information for registered devices is deleted.

Connecting to a Smartphone ([Wi-Fi connection])



Use Wi-Fi to connect the camera and a smartphone that does not support Bluetooth Low Energy.

With default settings, simple connection with smartphones is possible without entering a password.

You can also use password authentication for enhanced connection security.

- You can also connect via Wi-Fi to a smartphone that supports Bluetooth Low Energy by following the same steps.

1 Set the camera to Wi-Fi connection standby status.

-  → [] → [] → [Wi-Fi] → [Wi-Fi Function] → [New Connection] → [Remote Shooting & View]
- The SSID (A) of the camera is displayed on the screen.



- You can also perform the same operation by pressing the Fn button assigned with [Wi-Fi].

For information about the Fn button, refer to page 367.

2 In the setting menu of the smartphone, turn the Wi-Fi function ON.

3 Select the SSID displayed on the camera.

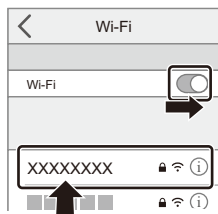

4 On the smartphone, start up "LUMIX Sync".



5 (At the first connection) Confirm the device name displayed on the camera and then select [Yes].





- When a device different than the one you want to connect to is displayed, the camera will automatically connect to that device if you select [Yes]. If there are other Wi-Fi connection devices nearby, we recommend using either QR code or manual password input to connect with password authentication. (→ 475)

❖ Using Password Authentication to Connect

You can enhance Wi-Fi connection security by using password authentication through either QR code or manual input.

Scanning QR code to connect

- 1 Set [Wi-Fi Password] on the camera to [ON].
 - → [] → [] → [Wi-Fi] → [Wi-Fi Setup] → [Wi-Fi Password] → [ON]
- 2 Display the QR code (A).
 - → [] → [] → [Wi-Fi] → [Wi-Fi Function] → [New Connection] → [Remote Shooting & View]
 - You can also perform the same operation by pressing the Fn button assigned with [Wi-Fi].
For information about the Fn button, refer to page 367.
 - Press or to enlarge the QR code.
- 3 On the smartphone, start up “LUMIX Sync”.
 - If a message is displayed indicating that the smartphone is searching for cameras, close the message.
- 4 Select [].
- 5 Select [Wi-Fi connection].
- 6 Select [QR code].
- 7 Scan the QR code displayed on the screen of the camera using “LUMIX Sync”.
 - (iOS devices) When a message to confirm the change of destination is displayed, select [Join].

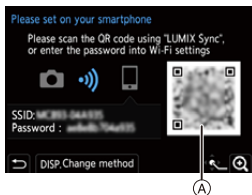



- (iOS devices) If the Wi-Fi connection fails, follow the message displayed to allow connection to the camera. If you still cannot connect, select the SSID of the camera on the Wi-Fi setup screen of the smartphone to connect. If the SSID is not displayed, turn off and on the camera, then perform the Wi-Fi connection settings again.

Manually entering a password to connect

- 1 Display the screen in Step 2 on page 475.
- 2 In the setting menu of the smartphone, turn the Wi-Fi function ON.

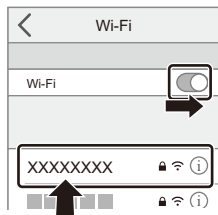

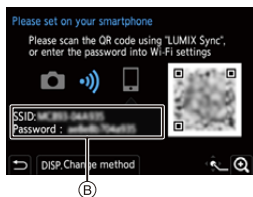

- 3 On the Wi-Fi setup screen, select the SSID (B) displayed on the camera.
- 4 (At the first connection)
Enter the password (B) displayed on the camera.
- 5 On the smartphone, start up "LUMIX Sync".





❖ Connection Methods Other Than the Default Settings



When connecting with [Via Network], or [WPS Connection] in [Direct], follow the steps below:

- 1 Display the connection method setting screen for the camera.
 -  ⇒ [] ⇒ [] ⇒ [Wi-Fi] ⇒ [Wi-Fi Function] ⇒ [New Connection] ⇒ [Remote Shooting & View]
- 2 Press [DISP.].

Connecting via network

- 1 Select [Via Network] and then press  or  .
 - Follow the connection method on page 508 to connect the camera to a wireless access point.
- 2 In the setting menu of the smartphone, turn the Wi-Fi function ON.
- 3 Connect the smartphone to the wireless access point that the camera is connected to.
- 4 On the smartphone, start up “LUMIX Sync”.

Connecting directly

- 1 Select [Direct] and then press  or  .
 - Select [WPS Connection], and follow the connection method on page 512 to connect the camera to a smartphone.
- 2 On the smartphone, start up “LUMIX Sync”.

Terminating the Wi-Fi Connection

To end the Wi-Fi connection between the camera and smartphone, follow the steps below.

1 Set the camera to recording mode.

- Press the shutter button halfway.

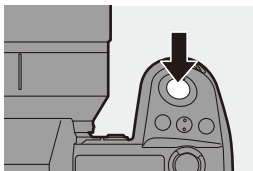

2 Terminate the Wi-Fi connection.

-  ⇒ [] ⇒ [] ⇒ [Wi-Fi] ⇒ [Wi-Fi Function] ⇒ [Yes]

- You can also perform the same operation by pressing the Fn button assigned with [Wi-Fi].

For information about the Fn button, refer to page [367](#).

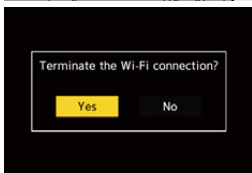

3 On the smartphone, close the “LUMIX Sync”.





Operating the Camera with a Smartphone

This explains the functions for operating the camera from a smartphone. Functions described in this document with the (Bluetooth) symbol require a smartphone that supports Bluetooth Low Energy.

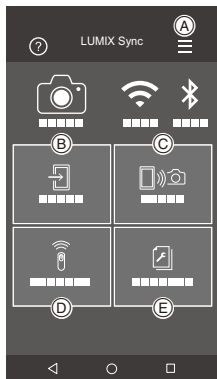
❖ Home Screen

When you start up “LUMIX Sync”, the home screen is displayed.



(A) 	App settings (→ 472, 475, 489) This allows connection settings, camera power operations, and displays Help.
(B) 	[Import images] (→ 484)
(C) 	[Remote shooting] (→ 480)
(D) 	[Shutter Remote Control] (→ 481)
(E) 	[Camera settings copy] (→ 491)

[Remote shooting]

You can use the smartphone to record from a remote location while viewing the live view images from the camera.

Getting started:

- Connect the camera to a smartphone. (→ 469, 473)
- On the smartphone, start up “LUMIX Sync”.

1 Select [📷] ([Remote shooting]) in the home screen.

- (iOS devices) When a message to confirm the change of destination is displayed, select [Join].

2 Start recording.

(A)	Takes a picture
(B)	Starts/ends the video recording

- The recorded image is saved on the camera.

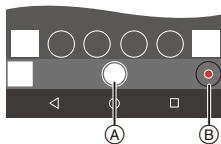



- Certain features, including some settings, may not be available.

❖ Operation Method During Remote Recording

Set either the camera or the smartphone as the priority control device to be used during remote recording.

 → [🔧] → [📶] → [Wi-Fi] → [Wi-Fi Setup] → Select [Priority of Remote Device]

 [Camera]	<p>Operation is possible on both the camera and the smartphone.</p> <ul style="list-style-type: none"> The camera's dial settings, etc. cannot be changed with the smartphone.
 [Smartphone]	<p>Operation is possible only on the smartphone.</p> <ul style="list-style-type: none"> The camera's dial settings, etc. can be changed with the smartphone. To end remote recording, press any of the buttons on the camera to turn on the screen, and select [End].

- The default setting is [Camera].



- The setting of this function cannot be changed while the connection is active.

[Shutter Remote Control]

Bluetooth



You can use the smartphone as a remote control for the shutter.

Getting started:

- Connect the camera to a smartphone by Bluetooth. (→ 469)
- On the smartphone, start up "LUMIX Sync".

1 Select [] ([Shutter Remote Control]) in the home screen.

2 Start recording.





	Starts/ends the video recording
	Takes a picture <ul style="list-style-type: none"> Bulb recording (→ 482)



❖ Bulb Recording

The shutter can be kept open from the start to end of recording, which is useful for recording of starry skies or night scenery.

Getting started:

- Set the camera to [M] mode. (→ [193](#))
 - Set the camera shutter speed to [B] (Bulb). (→ [195](#))
- 1 Touch [] to start recording (keep touching, without removing your finger).
 - 2 Remove your finger from [] to end recording.
 - Slide [] in the direction of [LOCK] to record with the shutter button locked in a fully-pressed state.
(Slide [] back to its original position or press the camera shutter button to end recording)
 - During [B] (Bulb) recording, if the Bluetooth connection is broken, then carry out Bluetooth connection again, then end recording from the smartphone.



❖ Shortening the Return Time from [Sleep Mode]

You can shorten the time it takes for the camera to return from [Sleep Mode] when the [Shutter Remote Control] is used.

Getting started:

- Connect the camera to a smartphone by Bluetooth. (→ [469](#))
- Set [Remote Wakeup] in [Bluetooth] to [ON]. (→ [489](#))

 ⇒ [] ⇒ [] ⇒ [Bluetooth] ⇒ Select [Returning from Sleep Mode]

	[Import / Remote Priority]	Shortens the time to return when using [Import images] or [Remote shooting].
	[Remote Shutter Priority]	Shortens the time to return when using [Shutter Remote Control].



- To use the [Shutter Remote Control] to cancel [Sleep Mode] on the camera, set [Bluetooth] in the [Setup] ([IN/OUT]) menu as follows, then connect via Bluetooth:
 - [Remote Wakeup]: [ON] (→ 489)
 - [Auto Transfer]: [OFF] (→ 486)
- The camera cannot be turned on by using [Shutter Remote Control].

[Import images]

Transfer an image stored on the card to the smartphone connected via Wi-Fi.

Getting started:

- Connect the camera to a smartphone. (→ 469, 473)
- On the smartphone, start up “LUMIX Sync”.

1 Select [] ([Import images]) in the home screen.



- (iOS devices) When a message to confirm the change of destination is displayed, select [Join].

2 Select the image to transfer.

- You can switch the card displayed by touching .



3 Transfer the image.

- Select [].
- If the image is a video, you can play it back by touching [] at the center of the screen.





- You will need Android 7.0 or higher to save RAW pictures on an Android device.
Depending on the smartphone or the OS, these may not be displayed correctly.
- When a video is played back, this has a small data size and is transmitted using “LUMIX Sync”, therefore its image quality will differ from that of the actual video recording.
Depending on the smartphone and on the usage conditions, the image quality may deteriorate or the sound may skip during video or picture playback.
- Images recorded using the following functions cannot be transferred:
 - [AVCHD] videos, [MP4] 4K videos, [MOV] videos
 - [6K/4K PHOTO]/[Post-Focus]
 - [HLG Photo] (HLG format pictures)

[Auto Transfer]

Bluetooth

You can automatically transfer recorded pictures to a smartphone as they are taken.

Getting started:

- Connect the camera to a smartphone by Bluetooth. (→ 469)

1 Enable [Auto Transfer] on the camera.

-  → [] → [] → [Bluetooth] → [Auto Transfer] → [ON]

- If a confirmation screen is displayed on the camera asking you to terminate the Wi-Fi connection, select [Yes] to terminate it.

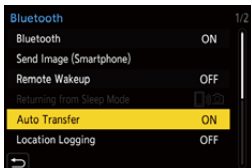

2 On the smartphone, select [Yes] (for Android devices) or [Join] (for iOS devices).

- The camera automatically makes a Wi-Fi connection.

3 Check the send settings on the camera and then press or .

- To change the send setting, press [DISP.]. (→ 515)
- The camera will enter a mode where it can automatically transfer images and [] will be displayed on the recording screen.

(If the settings are not displayed, then automatic image transfer is not possible. Check the status of the Wi-Fi connection to the smartphone.)

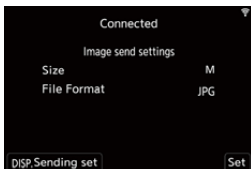

4 Record with the camera.

- This automatically sends the recorded pictures to the specified device as they are taken.
- [📷➔] is displayed in the recording screen of the camera while a file is being sent.

❖ To Stop the Automatic Transfer of Images

 → [🔧] → [📶] → [Bluetooth] → [Auto Transfer] → Select [OFF]

- A confirmation screen is displayed, asking you to terminate the Wi-Fi connection.



- If the [Bluetooth] and [Auto Transfer] settings of the camera are [ON], the camera automatically connects to the smartphone via Bluetooth and Wi-Fi when you turn on the camera.
Start up the “LUMIX Sync” on the smartphone to connect to the camera. The camera will enter a mode where it can automatically transfer images and [📶] is displayed in the recording screen of the camera.



- When [Auto Transfer] is set to [ON], [Wi-Fi Function] cannot be used.
- If the camera is turned off during image transfer, and the file sending is interrupted, then turn on the camera to restart the sending.
 - If the storage status of unsent files changes, then sending of files may no longer be possible.
 - If there are many unsent files, then sending of all files may not be possible.
- Saving RAW format images on Android devices requires Android 7.0 or higher.
Depending on the smartphone or the OS, these may not be displayed correctly.
- Images recorded with the following functions cannot be transferred automatically:
 - Video recording/[6K/4K PHOTO]/[Post-Focus]
 - [HLG Photo] (HLG format pictures)

[Location Logging]

Bluetooth

The smartphone sends its location information to the camera via Bluetooth, and the camera performs recording while writing the acquired location information.

Getting started:

- Enable the GPS function on the smartphone.
- Connect the camera to a smartphone by Bluetooth. (→ 469)

1 Enable [Location Logging] on the camera.

-  →  →  → [Bluetooth] → [Location Logging] → [ON]

- The camera will enter a mode where location information can be recorded and [GPS] is displayed in the recording screen of the camera.

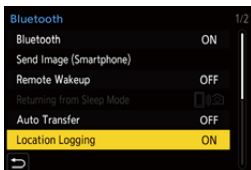

2 Record images with the camera.

- Location information will be written to the recorded images.





- When [GPS] on the recording screen appears translucent, location information cannot be acquired, therefore data cannot be written. Smartphone GPS positioning may not be possible if the smartphone is within a building, a bag, or similar. Move the smartphone to a position affording a wide view of the sky to improve positioning performance. In addition, refer to the operating instructions of your smartphone.
- Images with location information are indicated with [GPS].
- Be sure to pay special attention to the privacy, the likeness rights, etc. of the subject when you use this function. Use at your own risk.
- The smartphone drains its battery faster while acquiring location information.
- Location information is not written to AVCHD videos.

[Remote Wakeup]

Bluetooth

Even when the camera is turned off, the smartphone can be used to start the camera and record images, or check the recorded images.

Getting started:

- 1 Connect to a smartphone using Bluetooth. (→ 469)
- 2 Enable [Remote Wakeup] on the camera.
 -  ⇒ [] ⇒ [] ⇒ [Bluetooth] ⇒ [Remote Wakeup] ⇒ [ON]
- 3 Set the camera on/off switch to [OFF].
- 4 On the smartphone, start up “LUMIX Sync”.

❖ Turning On the Camera

Select [Remote shooting] in the “LUMIX Sync” home screen.

- (iOS devices) When a message to confirm the change of destination is displayed, select [Join].
- The camera turns on, and automatically connects using Wi-Fi.

❖ Turning Off the Camera

- 1 Select [] in the “LUMIX Sync” home screen.
- 2 Select [Turn off the camera].
- 3 Select [Power OFF].



- When [Remote Wakeup] has been set, the Bluetooth function continues to work even if the camera on/off switch is set to [OFF], so the battery will drain.

[Auto Clock Set]

Bluetooth

Synchronize the clock and the time zone setting of the camera with those of a smartphone.

Getting started:

- Connect the camera to a smartphone by Bluetooth. (→ 469)

Enable [Auto Clock Set] on the camera.

-  → [] → [] → [Bluetooth] → [Auto Clock Set] → [ON]

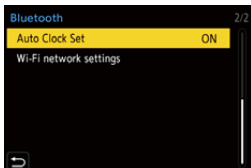

[Camera settings copy]

Bluetooth

This saves the camera's settings information to the smartphone.

Saved settings information can be loaded to the camera, letting you set the same settings on multiple cameras.

Getting started:

- Connect the camera to a smartphone by Bluetooth. (→ [469](#))

1 Select [] ([Camera settings copy]) in the “LUMIX Sync” home screen.

2 Save or load settings information.

- Read the [Help] in the “LUMIX Sync” menu for further details on how to operate the “LUMIX Sync”.





- Only settings information from the same model can be loaded.
- When transferring settings information, a Wi-Fi connection is automatically created.
(iOS devices) When a message to confirm the change of destination is displayed, select [Join].
- You can save or load the settings information of items that are the same as those in [Save/Restore Camera Setting] under the [Setup] ([Setting]) menu. (→ [587](#))

Sending Images from the Camera

Operate the camera to send recorded images to a device connected by Wi-Fi.

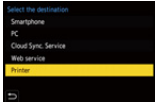
Operation flow

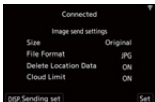
1	Select the sending method.	
2	Select the destination (type of the destination device). <ul style="list-style-type: none"> - [Smartphone] (→ 496) - [PC] (→ 499) - [Cloud Sync. Service] (→ 506) - [Web service] (→ 504) - [Printer] (→ 502) 	
3	Select the connection method and then connect by Wi-Fi. <ul style="list-style-type: none"> - [Via Network] (→ 508) - [Direct] (→ 512) 	
4	Check the send settings. <p>Change the send settings as necessary.</p> <ul style="list-style-type: none"> - Image send settings (→ 515) 	
5	<div style="display: flex; justify-content: space-between;"> <div style="width: 45%;"> <p style="text-align: center; background-color: #d9e1f2; padding: 5px;">[Send Images While Recording]</p> <p>Take pictures.</p> <p>This automatically sends the recorded pictures as they are taken.</p> </div> <div style="width: 45%;"> <p style="text-align: center; background-color: #d9e1f2; padding: 5px;">[Send Images Stored in the Camera]</p> <p>Select an image.</p> <p>Send the selected images.</p> <ul style="list-style-type: none"> - Selecting images (→ 516) </div> </div>	

Detailed information about connection methods for each destination device is described on pages [496](#) to [507](#).

Refer to the following pages for the steps common to all devices.

- Wi-Fi connections: [Via Network] (→ [508](#))/[Direct] (→ [512](#))
- Image send settings (→ [515](#))
- Selecting images (→ [516](#))



- When recording, recording is prioritized so it will take time for sending to complete.
- If the camera is turned off, or the Wi-Fi is disconnected before sending is completed, then sending will not restart.
- You may not be able to delete files or use the [Playback] menu while sending.
- When [Auto Transfer] in [Bluetooth] is set to [ON], [Wi-Fi Function] is not available.

❖ Images That Can be Sent

Images that can be sent differ depending on the destination device.

Destination device	Images that can be sent	
	[Send Images While Recording]	[Send Images Stored in the Camera]
[Smartphone] (→ 496)	JPEG/RAW	JPEG/RAW/MP4
[PC] (→ 499)	JPEG/RAW	JPEG/RAW/MP4/ MOV/AVCHD/ 6K/4K burst files/ Post-Focus images
[Cloud Sync. Service] (→ 506)	JPEG	JPEG/MP4
[Web service] (→ 504)	JPEG/RAW*	JPEG/MP4/RAW*
[Printer] (→ 502)	—	JPEG

* Sending is possible when the destination web service supports the sending of RAW images from this camera.

- You will need Android 7.0 or higher to send RAW images to a [Smartphone] when using an Android device.
- AVCHD videos with a file size exceeding 4 GB cannot be sent to a [PC].
- 4K videos cannot be sent to [Smartphone], [Cloud Sync. Service], and [Web service].
- It is not possible to send HLG format pictures recorded with [HLG Photo]. However, the RAW/JPEG images recorded at the same time will be sent to [Smartphone], [PC], [Cloud Sync. Service] or [Web service].



- Sending may not be possible depending on your device.
- It may not be possible to send images recorded with devices other than this camera, or images edited or processed on a PC.

❖ Fn Button Assigned with [Wi-Fi]

You can perform the following operations by pressing the Fn button assigned with [Wi-Fi] after connecting to Wi-Fi.

For information on Fn buttons, refer to page [367](#).

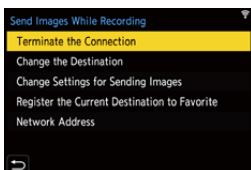

[Terminate the Connection]	Terminates the Wi-Fi connection.
[Change the Destination]	Terminates the Wi-Fi connection, and allows you to select a different Wi-Fi connection.
[Change Settings for Sending Images]	Sets the image size, file format, and other items for sending recorded images. (→ 515)
[Register the Current Destination to Favorite]	Registers the current connection destination or method so that you can easily connect with the same connection settings next time.
[Network Address]	Displays the MAC address and IP address of the camera. (→ 518)

- Depending on the Wi-Fi function being used or the connection destination, you may not be able to perform some of these operations.



[Smartphone]

Transfer recorded images to a smartphone connected using Wi-Fi.

Getting started:

- Install “LUMIX Sync” on your smartphone. (→ 468)

1 Select the method for sending the images on the camera.

-  →  →  → [Wi-Fi] → [Wi-Fi Function] → [New Connection] → [Send Images While Recording]/[Send Images Stored in the Camera]

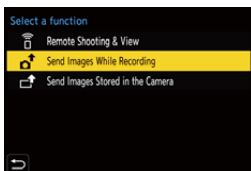

2 Set the destination to [Smartphone].

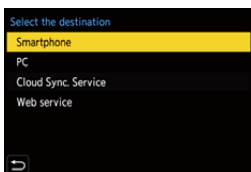

3 Connect the camera to a smartphone by Wi-Fi.

- Select [Via Network] (→ 508) or [Direct] (→ 512), and then connect.

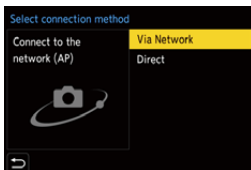

4 On the smartphone, start up “LUMIX Sync”.

5 Select the destination smartphone on the camera.

6 Check the send settings and then press or .

- To change the send settings of images, press [DISP.]. (→ 515)

7 When [Send Images While Recording] is selected:

Take pictures.

- This automatically sends the recorded pictures to the specified device as they are taken.
- [] is displayed in the recording screen of the camera while a file is being sent.
- To end the connection, follow the steps below:

 ⇒ [] ⇒ [] ⇒ [Wi-Fi] ⇒ [Wi-Fi Function] ⇒ [Yes]

When [Send Images Stored in the Camera] is selected:

Select an image.

- Select [Single Select] or [Multi Select], and then select one or more images. (→ 516)
- To end the connection, select [Exit].

❖ Sending Images on the Camera to a Smartphone with Simple Operations

You can transfer pictures to a smartphone connected by Bluetooth just by pressing the Fn button during playback.

You can also use the menu to connect easily.

- Use the Fn button registered with [Send Image (Smartphone)] to operate. In default settings, this is registered in [Q] button.

For information about the Fn button, refer to page [367](#).

Getting started:

- Install “LUMIX Sync” on your smartphone. (→ [468](#))
- Connect the camera to a smartphone by Bluetooth. (→ [469](#))
- Press [▶] on the camera to display the playback screen.



Send a single image

- 1 Press ◀▶ to select the image.
- 2 Press [Q].
- 3 Select [Single Select].
 - To change the send settings of images, press [DISP.]. (→ [515](#))
- 4 On the smartphone, select [Yes] (for Android devices) or [Join] (for iOS devices).
 - This connects automatically using Wi-Fi.

Send multiple images

- 1 Press [Q].
- 2 Select [Multi Select].
 - To change the send settings of images, press [DISP.]. (→ [515](#))
- 3 Select the images and then transfer.

◀▶ : Select images



 or  : Set/Cancel



[DISP.]: Transfer
- 4 On the smartphone, select [Yes] (for Android devices) or [Join] (for iOS devices).
 - This connects automatically using Wi-Fi.



• This function is not available when [Auto Transfer] in [Bluetooth] is set to [ON].

Using the menu to transfer easily

 ⇒ [] ⇒ [] ⇒ [Bluetooth] ⇒ [Send Image (Smartphone)]
Settings: [Single Select]/[Multi Select]

- If [Single Select], press ◀▶ to select the image and then press  or  to execute.
- If [Multi Select], use the same operation as with “Send multiple images”.

[PC]

Send recorded images to the PC connected with Wi-Fi.



Supported OS

Windows: Windows 10/Windows 8.1/Windows 8/Windows 7

Mac: OS X v10.5 to v10.11, macOS 10.12 to macOS 10.14

Getting started:

- Turn on the PC.
- Create a destination folder for images.
- If the workgroup of the destination PC has been changed from the standard setting, change the corresponding setting of the camera in [PC Connection]. (→ 517)

❖ Create a Destination Folder for Images

When using Windows (Example for Windows 10)

- 1 Select the destination folder and then right-click.
- 2 Select [Properties] and then enable folder sharing.

- You can also use “PHOTOfunSTUDIO” to create folders.
For details, refer to the operating instructions for “PHOTOfunSTUDIO”.



When using Mac (Example for OS X v10.14)

- 1 Select the destination folder and then click the items in the following order.
[File] ⇒ [Get Info]
- 2 Enable folder sharing.



- Create a PC account name (up to 254 characters) and password (up to 32 characters) consisting of alphanumeric characters. A destination folder may not be created if the account name includes non-alphanumeric characters.
- When the computer name (NetBIOS name for Mac) contains a space (blank character), etc., it may not be recognized. In that case, we recommend changing the name to one consisting only of 15 or less alphanumeric characters.
- Refer to the operating instructions for your PC or Help on the OS for detailed setting procedures.

1 Select the method for sending images on the camera.

-  ⇒ [] ⇒ [] ⇒ [Wi-Fi] ⇒ [Wi-Fi Function] ⇒ [New Connection] ⇒ [Send Images While Recording]/[Send Images Stored in the Camera]

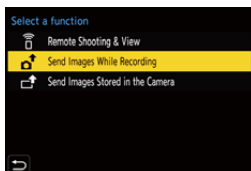

2 Set the destination to [PC].

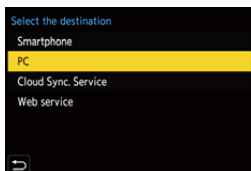

3 Connect the camera and PC by Wi-Fi.

- Select [Via Network] (→ 508) or [Direct] (→ 512), and then connect.

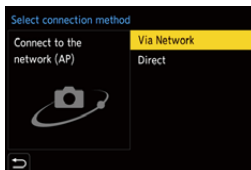

4 Enter the computer name of the PC name you want to connect to (for Mac, the NetBIOS name).

- For information on how to enter characters, refer to page 464.



5 Select a folder for storing images.

- Folders sorted by sent date will be created in the selected folder, and images will be saved there.

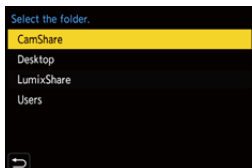



6 Check the send settings and then press or .

- To change the send setting, press [DISP.]. (→ 515)

7 When [Send Images While Recording] is selected:

Take pictures.

- This automatically sends the recorded pictures to the specified device as they are taken.
- [] is displayed in the recording screen of the camera while a file is being sent.
- To end the connection, follow the steps below:

 ⇒ [] ⇒ [] ⇒ [Wi-Fi] ⇒ [Wi-Fi Function] ⇒ [Yes]

When [Send Images Stored in the Camera] is selected:

Select an image.

- Select [Single Select] or [Multi Select], and then select one or more images. (→ 516)
- To end the connection, select [Exit].





- If the screen for a user account and password entry appears, enter the one you set on your PC.
- When the firewall of the OS, security software, etc. is enabled, connecting to the PC may not be possible.

[Printer]

You can send images to a PictBridge (wireless LAN)*-supported printer connected by Wi-Fi for printing.

* DPS over IP standard-compliant

1 Select the method for sending images on the camera.

-  ⇒ [] ⇒ [] ⇒ [Wi-Fi] ⇒ [Wi-Fi Function] ⇒ [New Connection] ⇒ [Send Images Stored in the Camera]

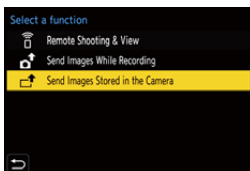

2 Set the destination to [Printer].

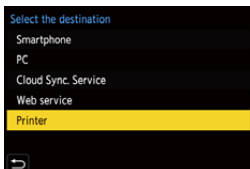

3 Connect the camera to a printer by Wi-Fi.

- Select [Via Network] (→ 508) or [Direct] (→ 512), and then connect.

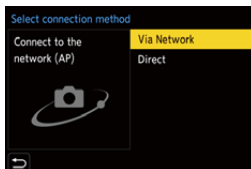

4 Select the destination printer.

5 Select and print images.

- The procedure for selecting images is the same as the one for when the USB connection cable is connected. (→ 536)
- To terminate the connection, press [↵].

- For details about PictBridge (wireless LAN-compatible) printers, contact their manufacturers.
- When [Auto Transfer] in [Bluetooth] is set to [ON], [Wi-Fi Function] is not available.



[Web service]

You can use “LUMIX CLUB” to upload recorded images to web services such as social networking sites.

Getting started:

- Register with “LUMIX CLUB”. (→ 518)
- Before sending images to a service, register that web service. (→ 520)

1 Select the method for sending images on the camera.

-  ⇒ [] ⇒ [] ⇒ [Wi-Fi] ⇒ [Wi-Fi Function] ⇒ [New Connection] ⇒ [Send Images While Recording]/[Send Images Stored in the Camera]

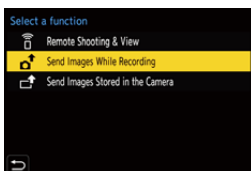

2 Set the destination to [Web service].

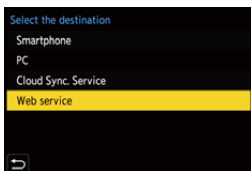

3 Connect to the web service.

- Select [Via Network] and then connect. (→ 508)

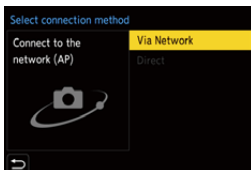

4 Select the web service.



5 Check the send settings and then press or .

- To change the send settings of images, press [DISP.]. (→ 515)

6 When [Send Images While Recording] is selected:

Take pictures.

- This automatically sends the recorded pictures to the specified service as they are taken.
- [] is displayed in the recording screen of the camera while a file is being sent.
- To end the connection, follow the steps below:

[] ⇒ [] ⇒ [] ⇒ [Wi-Fi] ⇒ [Wi-Fi Function] ⇒ [Yes]

When [Send Images Stored in the Camera] is selected:

Select an image.

- Select [Single Select] or [Multi Select], and then select one or more images. (→ 516)
- To end the connection, select [Exit].



- If image sending fails, a report email outlining the failure will be sent to the email address registered in the "LUMIX CLUB".
- Panasonic assumes no responsibility for any damages resulting from the leakage, loss, etc. of images uploaded on web services.
- When uploading images to a web service, do not delete images from the camera, even after they have finished sending, until you have checked that they have been properly uploaded to the web service.
Panasonic assumes no responsibility for any damages resulting from the deletion of images stored on the camera.
- Images uploaded to web services cannot be displayed or deleted with the camera.
- Images may contain information that can be used to identify the user, such as recording dates and times, and location information. Check carefully when uploading the images to a web service.



[Cloud Sync. Service]

This camera can automatically transfer recorded images to a cloud sync service via “LUMIX CLUB” to send them to a PC or smartphone.

To use [Cloud Sync. Service] (As of August 2019)

- You need to register to the “LUMIX CLUB” (→ 518) and set up cloud synchronization to send images to a cloud folder.
To set up cloud synchronization, use “PHOTOfunSTUDIO”.
- Sent images are temporarily saved in the cloud folder. These can be synchronized with your PC, smartphone, and other devices.
- A cloud folder stores sent images for 30 days (up to 1000 images).
Please note that the images will be deleted automatically in the following cases:
 - If 30 days have passed after sending (even if within 30 days of the transfer, if images have been downloaded to all specified devices, then these may be deleted)
 - If there are in excess of 1000 images (depending on the [Cloud Limit] (→ 515) setting)

1 Select the method for sending images on the camera.

-  ⇒ [] ⇒ [] ⇒ [Wi-Fi] ⇒ [Wi-Fi Function] ⇒ [New Connection] ⇒ [Send Images While Recording]/[Send Images Stored in the Camera]

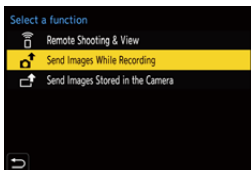

2 Set the destination to [Cloud Sync. Service].

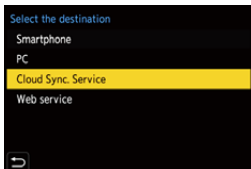

3 Connect to the cloud sync service.

- Select [Via Network] and then connect. (→ 508)

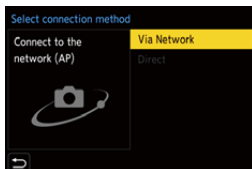

4 Check the send settings and then press or .

- To change the send settings of images, press [DISP.]. (→ 515)

5 When [Send Images While Recording] is selected:

Take pictures.

- This automatically sends the recorded pictures to the cloud sync services as they are taken.
-  is displayed in the recording screen of the camera while a file is being sent.
- To end the connection, follow the steps below:

 ⇒  ⇒  ⇒ [Wi-Fi] ⇒ [Wi-Fi Function] ⇒ [Yes]

When [Send Images Stored in the Camera] is selected:

Select one or more images.

- Select [Single Select] or [Multi Select], and then select one or more images. (→ 516)
- To end the connection, select [Exit].

Wi-Fi Connections

When [New Connection] has been selected in [Wi-Fi Function] in [Wi-Fi] of the [Setup] ([IN/OUT]) menu, select the connection method from either [Via Network] or [Direct] to connect.

On the other hand, when you use [Select a destination from History] or [Select a destination from Favorite], the camera connects to the selected device with the previously-used settings.



[Via Network]

Connect the camera and destination device through the wireless access point.

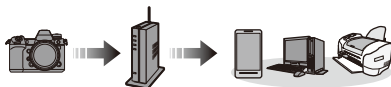

Select the method for connecting to a wireless access point.

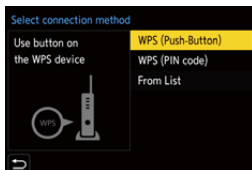

[WPS (Push-Button)] (→ 509)	Press the WPS button on the wireless access point to set up a connection.
[WPS (PIN code)] (→ 510)	Enter a PIN code into the wireless access point to set up a connection.
[From List] (→ 510)	Searches for a wireless access point to use, and connects to this.



- After selecting [Via Network] once, the camera will connect to the previously-used wireless access point.
To change the wireless access point used for connection, press [DISP.] and change the connection destination.

❖ [WPS (Push-Button)]

Press the WPS button on the wireless access point to set up a connection.

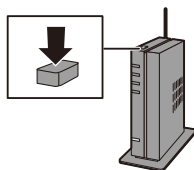

Press the wireless access point WPS button until it switches to WPS mode.

Example)



❖ [WPS (PIN code)]

Enter a PIN code into the wireless access point to set up a connection.

- 1 On the camera screen, select the wireless access point you are connecting to.
- 2 Enter the PIN code displayed on the camera screen into the wireless access point.
- 3 Press  or  of the camera.



• WPS is a function that allows you to easily configure the settings related to the connection and security of wireless LAN devices.

For details about the operation and compatibility of WPS, refer to the operating instructions for the wireless access point.

❖ [From List]

Searches for a wireless access point to use, and connects to this.



• Confirm the encryption key of the wireless access point.

- 1 Select the wireless access point you are connecting to.
 - Press [DISP.] to run a wireless access point search again.
 - If no wireless access point is found, refer to “Connecting by Manual Input” on page 511.
- 2 (If network authentication is encrypted) Enter the encryption key.
 - For information on how to enter characters, refer to page 464.

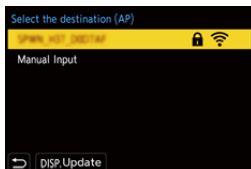

❖ Connecting by Manual Input



- Check the SSID, network authentication, encryption, and encryption key of the wireless access point you are using.

- 1 In the screen in Step 1 of “[From List]”, select [Manual Input]. (→ 510)
- 2 Enter the SSID of the wireless access point you are connecting to, and then select [Set].
 - For information on how to enter characters, refer to page 464.
- 3 Select the network authentication.

[WPA2-PSK]	Supported encryption: [TKIP], [AES]
[WPA2/WPA-PSK]	
[No Encryption]	—

- 4 (When other than [No Encryption] is selected)
Enter the encryption key and then select [Set].



- Check the operating instructions and settings of the wireless access point.
- If a connection cannot be made, the signal strength of the wireless access point may be too weak.
For details, refer to “Message Displays” (→ 553) and “Troubleshooting” (→ 557).
- Depending on your environment, the communication speed with the wireless access point may decrease, or the wireless access point may not be available for use.

[Direct]

Directly connect the camera and the destination device.



Select the method for connecting with the destination device.

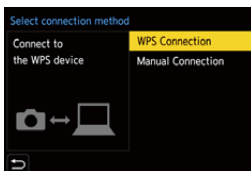

[WPS Connection]	[WPS (Push-Button)]	<p>Press the WPS button on the destination device to connect.</p> <ul style="list-style-type: none"> On the camera, press [DISP.] to extend the connection wait time.
	[WPS (PIN code)]	<p>Enter the PIN code into the camera, and connect.</p>
[Manual Connection]	<p>Search for the camera on the destination device to connect. Enter the SSID and password displayed on the camera into the device.</p> <ul style="list-style-type: none"> If the destination is set to [Smartphone], the password is not displayed. Select the SSID to establish a connection. (→ 473) 	



- Please also refer to the operating instructions for the device to be connected.

Connect to Wi-Fi Using Previously Saved Settings

Use the Wi-Fi connection history to connect using the same settings as previously.

1 Display the Wi-Fi connection history.

- **MENU/SET** ⇒ [**Wrench**] ⇒ [**Wi-Fi**] ⇒ [Wi-Fi] ⇒ [Wi-Fi Function] ⇒ [Select a destination from History]/[Select a destination from Favorite]



2 Select the History item to connect to.

- Press [DISP.] to confirm details of the connection history.

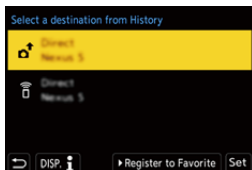

- If the settings of the device to connect to have been changed, it may not be possible to connect to the device.

❖ Register to Favorite

You can register the Wi-Fi connection history to Favorite.

1 Display the Wi-Fi connection history.

- **MENU/SET** ⇒ [**Wrench**] ⇒ [**Wi-Fi**] ⇒ [Wi-Fi] ⇒ [Wi-Fi Function] ⇒ [Select a destination from History]



2 Select the History item to register and then press ►.

3 Enter a registration name and then select [Set].

- For information on how to enter characters, refer to page 464.
- A maximum of 30 characters can be entered. A two-byte character is treated as two characters.

❖ Editing Items Registered in Favorite

1 Display items registered to Favorite.

-  ⇒ [] ⇒ [] ⇒ [Wi-Fi] ⇒ [Wi-Fi Function] ⇒ [Select a destination from Favorite]

2 Select the History item to edit in Favorite and then press ►.

[Remove from Favorite]	—
[Change the Order in Favorite]	Specify the destination location of the desired item to change the display order.
[Change the Registered Name]	Enter characters to change the registered name. <ul style="list-style-type: none"> • For information on how to enter characters, refer to page 464.

-  The number of items that can be saved in History is limited. Register frequently-used connection settings to Favorite.
- When [Reset] in the [Setup] ([Setting]) menu is used to reset the network settings, the content registered in History and Favorite is deleted.
- If the device you want to connect to (smartphone, etc.) is connected to a wireless access point other than the camera, you cannot connect the device to the camera using [Direct].
Change the Wi-Fi settings of the device you want to connect to so that the access point to be used is set to the camera. You can also select [New Connection] and reconnect the devices. (→ [473](#))
- It may be difficult to connect to networks to which many devices are connected. In these cases, connect using [New Connection].

Send Settings and Selecting Images

Image Send Settings

Set the size, file format, and other items for sending the image to the destination device.

- 1 After Wi-Fi connection, the send settings confirmation screen will be displayed, so press [DISP.].
- 2 Change the send settings.

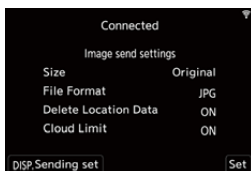



[Size]	Resize the image to send. [Original]/[Auto]/[Change] ([M], [S], or [VGA]) <ul style="list-style-type: none"> The [Auto] image size changes depending on the status of the destination device. (This can be set when the destination is [Web service])
[File Format]	Sets the file format of images to send. [JPG]/[RAW+JPG]/[RAW] <ul style="list-style-type: none"> This setting is possible when the destination supports the sending of RAW images from this camera. (→ 494)
[Delete Location Data]	Select whether to delete the location information from images before sending them. <ul style="list-style-type: none"> This can be set when the destination is [Cloud Sync. Service] or [Web service]. This operation only deletes the location information from the images that are set to be sent.
[Cloud Limit]	You can select whether to send images when the cloud folder runs out of free space. [ON]: Does not send images. [OFF]: Deletes images from the oldest ones, then sends new images. <ul style="list-style-type: none"> This can be set when the destination is [Cloud Sync. Service].

Selecting Images

When sending by [Send Images Stored in the Camera], select the images using the following procedure.





- 1 Select [Single Select] or [Multi Select].
- 2 Select the image.

[Single Select] setting

- 1 Press ◀▶ to select an image.
- 2 Press  or .



[Multi Select] setting

- 1 Press ▲▼◀▶ to select an image and then press  or . (Repeat this)
 - To cancel the setting, press  or  again.
 - Images are displayed separately by card slot.
 - To switch the card to display, press [].
 - Selecting images at once is possible only for the images in a single card.
- 2 Press [DISP.] to execute.





[Wi-Fi Setup] Menu

This configures the settings required for the Wi-Fi function.
The settings cannot be changed when connected to Wi-Fi.

Displaying the [Wi-Fi Setup] menu.

●  ⇒ [] ⇒ [] ⇒ [Wi-Fi] ⇒ [Wi-Fi Setup]

[Priority of Remote Device]	This sets either the camera or the smartphone as the priority control device to be used during remote recording. (→ 480)
[Wi-Fi Password]	You can use a password to connect for enhanced security. (→ 475)
[LUMIX CLUB]	This acquires or changes the “LUMIX CLUB” login ID. (→ 519)
[PC Connection]	<p>You can set the workgroup. To send images to a PC, you need to connect to the same workgroup as the destination PC. (The default setting is “WORKGROUP”).</p> <ul style="list-style-type: none"> • To change the workgroup name, press  or  and enter the new workgroup name. For information on how to enter characters, refer to page 464. • To return to the default settings, press [DISP.].
[Device Name]	<p>You can change the name (SSID) of the camera.</p> <ul style="list-style-type: none"> • To change the SSID name, press [DISP.] and enter the new SSID name. For information on how to enter characters, refer to page 464. • A maximum of 32 characters can be entered.

[Wi-Fi Function Lock]	<p>To prevent incorrect operation and use of the Wi-Fi function by a third party and to protect personal information in the camera and included with images, protect the Wi-Fi function with a password.</p> <p>[Setup]: Enter any 4-digit numbers as the password.</p> <ul style="list-style-type: none"> • For information on how to enter characters, refer to page 464. <p>[Cancel]: Cancel the password.</p> <ul style="list-style-type: none"> • Once a password is set, you are required to enter it each time you use the Wi-Fi function. • If you forget your password, you can use [Reset] in the [Setup] ([Setting]) menu to reset the network settings and thereby reset the password.
[Network Address]	Displays the MAC address and IP address of the camera.

“LUMIX CLUB”

Refer to the “LUMIX CLUB” site for details.

<https://lumixclub.panasonic.net/eng/c/>





- The service may be suspended due to regular maintenance or unexpected troubles, and the service contents may be changed or added, without prior notice to the users.

The service may also be stopped in whole or in part with a reasonable period of advance notice.

❖ Acquire a New Login ID from the Camera

From the camera menu, acquire a “LUMIX CLUB” login ID.

1 Follow the menu path.

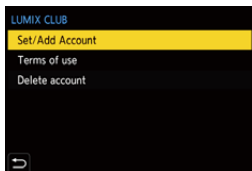

-  ⇒ [] ⇒ [] ⇒ [Wi-Fi] ⇒ [Wi-Fi Setup] ⇒ [LUMIX CLUB] ⇒ [Set/Add Account] ⇒ [New account]
- Connect to the network.
Proceed to the next page by selecting [Next].



2 Select and set the method for connecting to a wireless access point, and set. (→ 508)

- Except for the first-time connection, the camera will connect to the previously-used wireless access point.
To change the connection destination, press [DISP.].
- Proceed to the next page by selecting [Next].

3 Read through the “LUMIX CLUB” terms of use and then select [Agree].

- Switch pages: ▲▼
- Zoom: Rotate  to the right (to restore: rotate  to the left)
- Move the enlarged area: ▲▼◀▶
- Cancel without registering: [] button

4 Enter a password.

- Enter any combination of 8 to 16 characters and numbers for the password.
- For information on how to enter characters, refer to page 464.

5 Check the login ID and then select [OK].

- Be sure to make a note of the login ID and password.
- The login ID (12-digit number) will be displayed automatically.

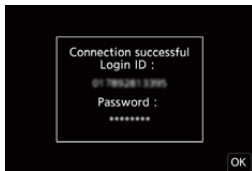

❖ Register a Web Service with “LUMIX CLUB”



- Confirm web services supported by “LUMIX CLUB” in “FAQ/Contact us” at the following site:
https://lumixclub.panasonic.net/eng/c/lumix_faqs/

Getting started:

- Make sure that you have created an account on the web service you want to use, and have the login information available.
- 1 Connect to the “LUMIX CLUB” site using a smartphone or PC.
<https://lumixclub.panasonic.net/eng/c/>
 - 2 Enter your “LUMIX CLUB” login ID and password to log in.
 - If you have not registered your email address to the “LUMIX CLUB” yet, please register it.
 - 3 Select and register the web service you want to use for web service link settings.
 - Follow the on-screen instructions to perform the registration.

❖ Confirm/Change Login ID or Password

Getting started:

- When using the acquired login ID, check the ID and password.
- Access the “LUMIX CLUB” site from your PC to change the password.

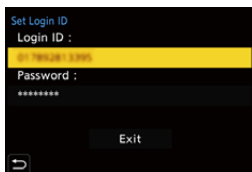

- 1 Follow the menu path.
 - ⇒ [] ⇒ [] ⇒ [Wi-Fi] ⇒ [Wi-Fi Setup] ⇒ [LUMIX CLUB] ⇒ [Set/Add Account] ⇒ [Set Login ID]
 - The login ID and password are displayed.
 - The password is displayed as “*”.
- 2 Select the item to change.



- 3 Enter the login ID or password.
 - For information on how to enter characters, refer to page 464.
- 4 Select [Exit].

❖ Checking the “LUMIX CLUB” Terms of Use

Check the details if the terms of use have been updated, for example.

 ⇒ [] ⇒ [] ⇒ [Wi-Fi] ⇒ [Wi-Fi Setup] ⇒ [LUMIX CLUB] ⇒ Select [Terms of use]



❖ Deleting Your Login ID and Closing Your “LUMIX CLUB” Account

Delete the login ID from the camera when transferring it to another party or disposing of it.

You can also close your “LUMIX CLUB” account.



- You can only change or delete the login ID acquired with the camera.

- 1 Follow the menu path.
 -  ⇒ [] ⇒ [] ⇒ [Wi-Fi] ⇒ [Wi-Fi Setup] ⇒ [LUMIX CLUB] ⇒ [Delete account]
 - A message is displayed. Select [Next].
- 2 Select [Yes] on the login ID delete confirmation screen.
 - A message is displayed. Select [Next].
- 3 Select [Yes] on the confirmation screen asking whether to close the “LUMIX CLUB” account.
 - A message is displayed. Select [Next].
 - To continue without closing the account, select [No] to delete only the login ID.
- 4 Select [OK].

17. Connecting to Other Devices

This chapter describes connections with other devices, such as TVs and PCs.

Connect using either the [HDMI] socket or the USB port on the camera. Refer to the sections below for more details about connections.

[HDMI] socket

Connect the camera and TV with a commercially available HDMI cable.

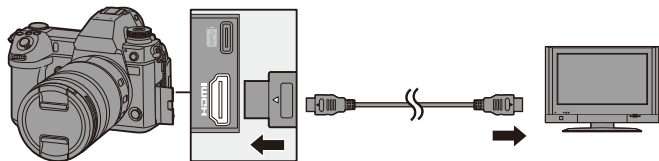

- Check the direction of the terminals and plug in/out straight holding onto the plug. (Inserting these at an angle may cause deformation or malfunction)
- Use a “High Speed HDMI cable” with the HDMI logo.
Cables that do not comply with the HDMI standards will not work.
“High Speed HDMI cable” (Type A–Type A plug, up to 1.5 m (4.9 feet) long)

USB port

Use a USB connection cable (C–C or A–C) to connect the camera to a PC, recorder, or printer.

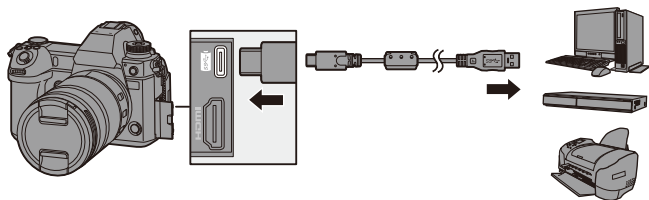

- Plug in/out straight holding onto the plug.
(Inserting these at an angle may cause deformation or malfunction)
- Do not use any other USB connection cables except the supplied USB connection cables (C–C and A–C).



- Do not connect the cable to the wrong terminals. This may cause a malfunction.

Viewing on a TV

You can connect the camera to a TV to view recorded pictures and videos on the TV.

Getting started:

- Turn off the camera and TV.

1 Connect the camera and TV with a commercially available HDMI cable. (→ 522)

2 Turn on the TV.

3 Switch the input of the TV.

- Switch the input of the TV to match the terminal to which you connected the HDMI cable.

4 Turn on the camera.

5 Display the playback screen.

- Press [▶].
- The recorded images are displayed on the TV. (The monitor and viewfinder of the camera will turn off.)

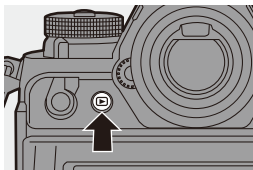



- With the default settings, pictures are output at the optimal resolution for the connected TV.
The output resolution can be changed in [HDMI Mode (Playback)]. (→ 451)
- Depending on the aspect ratio, gray bands may be displayed on the top and bottom or the left and right of images.
You can change the band color in [Background Color(Playback)] in [TV Connection] of the [Setup] ([IN/OUT]) menu. (→ 452)
- HDMI output is not possible if you connect a USB connection cable at the same time while [USB Mode] is set to [PC(Storage)] or [PictBridge(PTP)].
- Change the screen mode on your TV if images are displayed with the top or bottom cut off.
- Depending on the connected TV, 6K/4K burst files may not be played back correctly.
- Please also refer to the operating instructions for the TV.





❖ Using VIERA Link

VIERA Link (HDAVI Control™) is a function that allows you to use your remote control for the Panasonic TV for easy operations when the camera has been connected to a VIERA Link compatible device using an HDMI cable for automatic linked operations.

(Not all operations are possible.)



- To use VIERA Link, you need to also configure the settings on the TV.
For the setting procedure, refer to the operating instructions for the TV.

- 1 Connect the camera to a Panasonic TV compatible with VIERA Link using a commercially available HDMI cable. (→ 522)
- 2 Turn on the camera.
- 3 Turn on the VIERA Link.
 -  ⇒ [] ⇒ [] ⇒ [TV Connection] ⇒ [VIERA Link (CEC)] ⇒ [ON]
- 4 Display the playback screen.
 - Press [].
- 5 Operate with the remote control for the TV.

Power off link

If you turn off the TV with its remote control, the camera will also turn off.

Automatic input switching

If you turn on the camera and then press [], the input of the TV automatically switches to input to which this camera is connected.

Furthermore, when the TV power is in the standby state, it turns on automatically. (When “Power on link” on the TV is set to “Set”)



- VIERA Link is a unique Panasonic function built on an HDMI control function using the standard HDMI CEC (Consumer Electronics Control) specification. Linked operations with HDMI CEC compatible devices made by other companies are not guaranteed.
- The camera supports “VIERA Link Ver.5”. “VIERA Link Ver.5” is the standard for Panasonic’s VIERA Link compatible devices. This standard is compatible with Panasonic’s conventional VIERA Link devices.
- Operation using the buttons on the camera will be limited.

Importing Images to a PC

If you connect the camera to a PC, you can copy the recorded images to the PC.

When using Windows, you can also copy using the “PHOTOfunSTUDIO” software for LUMIX.

You can also use software to perform operations such as organizing and correcting recorded images, processing RAW images, and editing videos. (→ 529)

Copying Images to a PC

After connecting to the PC, you can copy the recorded images by dragging files and folders on this camera to the PC.



- Windows: We recommend importing AVCHD videos using “PHOTOfunSTUDIO”.
When importing using “PHOTOfunSTUDIO”, refer to page 529.
 - You cannot play back or edit AVCHD videos using “PHOTOfunSTUDIO” if you imported them by dragging them.
- Mac: Supported by “Final Cut Pro X”.
For details on “Final Cut Pro X”, please contact Apple Inc.
- The camera can be connected to a PC running any of the following OSs which can detect mass storage devices.



Supported OS

Windows: Windows 10/Windows 8.1/Windows 8/Windows 7

Mac: OS X v10.5 to v10.11, macOS 10.12 to macOS 10.14

Getting started:

- Turn on the camera and PC.

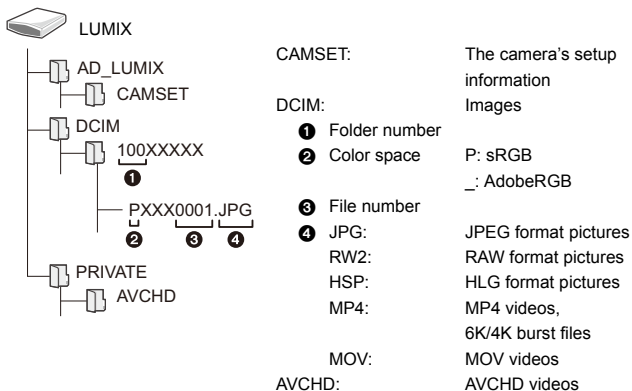

- 1 Connect the camera and PC with the USB connection cable (C–C or A–C). (→ 522)**
- 2 Press ▲▼ to select [PC(Storage)] and then press  or .**
 - Windows: A drive (“LUMIX”) is displayed in [This PC].
 - Mac: A drive (“LUMIX”) is displayed on the desktop.
 - A message about charging may be displayed. Wait for a while until the message disappears.
- 3 Drag the files and folders from the camera to the PC.**

❖ Folder Structure Inside Card



❖ Copying Images to a PC Using “PHOTOfunSTUDIO”

Getting started:

- Turn on the camera and PC.
 - Install “PHOTOfunSTUDIO” on PC. (→ 529)
- ❶ Connect the camera and PC with the USB connection cable (C–C or A–C). (→ 522)
 - ❷ Press ▲▼ to select [PC(Storage)] and then press  or .
 - A message about charging may be displayed. Wait for a while until the message disappears.
 - ❸ Copy images to the PC using “PHOTOfunSTUDIO”.
 - Do not delete or move the copied files and folders in, for example, Windows Explorer.
 - Playback and editing using “PHOTOfunSTUDIO” will become no longer possible.



- If [USB Mode] is set to [PC(Storage)] in the [Setup] ([IN/OUT]) menu, the camera will be automatically connected to the PC without the [USB Mode] selection screen being displayed. (→ 449)



- Take care not to turn off the camera while images are being imported.
- After importing of the images is completed, perform the operation to safely remove the USB connection cable on the PC.
- Turn off the camera and disconnect the USB connection cable before removing the card from the camera. Otherwise, the recorded data may be damaged.

Installing Software

Install the software to perform operations such as organizing and correcting recorded images, processing RAW images, and editing videos.



- To download the software, your PC needs to be able to connect to the internet.
- Downloading may take a while depending on the communication environment.
- Supported OSs are current as of August 2019 and are subject to change.

❖ PHOTOfunSTUDIO 10.1 PE

This software allows you to manage your images. For example, it allows you to import pictures and videos to your PC and then sort them by recording date, model name.

You can also perform operations such as writing images to a DVD, correcting images, and editing videos.

Check the following site and then download and install the software:

https://panasonic.jp/support/global/cs/soft/download/d_pfs101pe.html
(English only)

Download expiration: September 2024

Operating environment

Supported OS	Windows 10 (32-bit/64-bit) Windows 8.1 (32-bit/64-bit) Windows 7 (32-bit/64-bit) SP1 <ul style="list-style-type: none"> For 4K videos, videos in 10-bit format, and 6K/4K photos, a 64-bit version of the Windows 10/Windows 8.1/Windows 7 OS is required.
CPU	Pentium® 4 (2.8 GHz or higher)
Display	1024×768 or higher (1920×1080 or higher is recommended)
Installed memory	1 GB or more for 32-bit, 2 GB or more for 64-bit
Free hard disk space	450 MB or more for installing the software

- A high-performance PC environment is required to use the playback and editing functions for 4K videos and videos in 10-bit format or the picture cropping function for 6K/4K photos.
For details, refer to the operating instructions for "PHOTOfunSTUDIO".
- "PHOTOfunSTUDIO" is not available for Mac.

❖ SILKYPIX Developer Studio SE

This software processes and edits RAW images.

Edited images can be saved in a format (JPEG, TIFF, etc.) that can be displayed on a PC.

Check the following site and then download and install the software:

<http://www.isl.co.jp/SILKYPIX/english/p/>

Operating environment

Supported OS	Windows	Windows 10 (64-bit recommended) Windows 8.1 (64-bit recommended) Windows 7 (64-bit recommended)
	Mac	OS X v10.10 to v10.11 macOS 10.12 to macOS 10.14

- For more information such as how to use “SILKYPIX Developer Studio”, refer to the Help or the Ichikawa Soft Laboratory’s support site.

❖ 30-Day Full Trial Version of “LoiLoScope”

This software allows you to easily edit videos.

Check the following site and then download and install the software:

<http://loilo.tv/product/20>

Operating environment

Supported OS	Windows	Windows 10 Windows 8.1 Windows 8 Windows 7
--------------	---------	---



- You can download a trial version that can be used for free for 30 days.
- For more information on how to use “LoiLoScope”, refer to the “LoiLoScope” manual available for download at the site.
- “LoiLoScope” is not available for Mac.

Storing on a Recorder

By connecting the camera to a Panasonic Blu-ray disc recorder or DVD recorder, you can store the pictures and videos.

Getting started:

- Turn on the camera and recorder.
- Insert a card into card slot 1.

- 1 Connect the camera and recorder with the USB connection cable (C–C or A–C). (→ 522)**
- 2 Press ▲▼ to select [PC(Storage)] and then press  or .**
 - A message about charging may be displayed. Wait for a while until the message disappears.
- 3 Operate the recorder to store the images.**



- If [USB Mode] is set to [PC(Storage)] in the [Setup] ([IN/OUT]) menu, the camera will be automatically connected to the recorder without the [USB Mode] selection screen being displayed. (→ 449)



- Take care not to turn off the camera while storage is in progress.
- Images such as 4K videos may not be supported depending on your recorder.
- Turn off the camera and disconnect the USB connection cable before removing the card from the camera. Otherwise, the recorded data may be damaged.
- For the storage and playback procedures, refer to the operating instructions for the recorder.

Tethered Recording

If you install the “LUMIX Tether” camera control software on your PC, you can connect the camera to the PC via USB and then control the camera from the PC and record while checking the live view on the PC screen (tethered recording).

In addition, you can output via HDMI to an external monitor or TV during tethered recording.

Installing Software

❖ “LUMIX Tether”

This software is for controlling the camera from a PC.

It allows you to change various settings and to record remotely and then save the images to the PC.

Check the following site and then download and install the software:

https://panasonic.jp/support/global/cs/soft/download/d_lumixtether.html
(English only)

Operating environment

Supported OS	Windows	Windows 10, Windows 8.1, Windows 7
	Mac	OS X v10.10 to v10.11, macOS 10.12 to macOS 10.14
Interface	USB port (SuperSpeed USB (USB 3.0))	





- Supported OSs are current as of August 2019 and are subject to change.
- To download the software, your PC needs to be able to connect to the internet.
- Downloading may take a while depending on the communication environment.
- For how to operate the software, refer to the operation guide for “LUMIX Tether”.



Operating the Camera from a PC

-  • To output via HDMI to an external monitor or TV, connect the camera with an HDMI cable. (→ 524)

Getting started:

- Turn on the camera and PC.
- Install “LUMIX Tether” on PC.

- 1 Connect the camera and PC with the USB connection cable (C–C or A–C). (→ 522)**
- 2 Press ▲▼ to select [PC(Tether)] and then press  or .**
 - [] is displayed on the camera's screen.
 - A message about charging may be displayed. Wait for a while until the message disappears.
- 3 Use “LUMIX Tether” to operate the camera from the PC.**

-  • If [USB Mode] is set to [PC(Tether)] in the [Setup] ([IN/OUT]) menu, the camera will be automatically connected to the PC without the [USB Mode] selection screen being displayed. (→ 449)
-  • The Wi-Fi/Bluetooth functions are not available while there is a PC connection with [PC(Tether)].



Printing

If you connect the camera to a printer that supports PictBridge, you can select pictures on the camera's monitor and then print them.

Getting started:

- Turn on the camera and printer.
- Set the print quality and other settings on the printer.

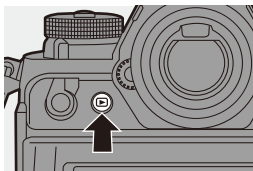

1 Display the playback screen.

- Press [▶].
- Images are displayed separately by card slot.
To switch the card to display, after pressing [⏏], press ▲▼ to select [Card Slot 1] or [Card Slot 2], and then press  or .
- The card for printing cannot be changed after connecting to the printer.



2 Connect the camera and printer with the USB connection cable (C-C or A-C). (→ 522)

3 Press ▲▼ to select [PictBridge(PTP)] and then press





 or .

- A message about charging may be displayed. Wait for a while until the message disappears.

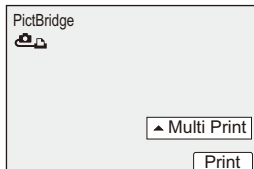
4 Press ◀▶ to select a picture and then press or .

- To print multiple pictures, press ▲, set the picture selection method, and then select pictures.



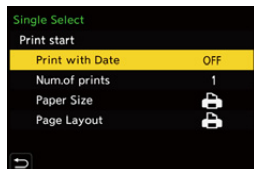

[Multi Select]	Selects the picture to print. 1 Press ▲▼◀▶ to select a picture and then press  or  . • To cancel the setting, press  or  again. 2 Press [DISP.] to end selection.
[Select All]	Prints all the stored pictures.
[Rating]	Prints all pictures with [Rating] levels from [★1] to [★5].

5 Set the print settings.



6 Start printing.

- Select [Print start] and then press  or .

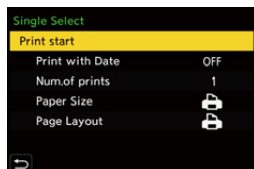

❖ Setting Items (Print Settings)

[Print start]	Starts printing.
[Print with Date]	Sets printing with date. <ul style="list-style-type: none">• If the printer does not support printing with date, the date cannot be printed.
[Num.of prints]	Sets the number of prints to be printed (up to 999).
[Paper Size]	Sets the paper size.
[Page Layout]	Sets whether to add borders and how many images to be printed on each sheet of paper.



- If [USB Mode] is set to [PictBridge(PTP)] in the [Setup] ([IN/OUT]) menu, the camera will be automatically connected to the printer without the [USB Mode] selection screen being displayed. (→ 449)



- Take care not to turn off the camera while printing is in progress.
- When connecting with the printer is not possible, set [USB Power Supply] to [OFF] and then try connecting again. (→ 449)
- Do not disconnect the USB connection cable while [⊗] (Cable disconnect prohibit icon) is displayed.
- Disconnect the USB connection cable after printing.
- Turn off the camera and disconnect the USB connection cable before removing the card from the camera. Otherwise, the recorded data may be damaged.
- To print images with paper size and layout settings not supported by the camera, set the [Paper Size] and [Page Layout] to [📄] and then select the desired settings on the printer.
(For details, refer to the operating instructions for your printer.)
- If a yellow [●] is displayed, the camera is receiving an error message from the printer. Check that there is no problem with the printer.
- If the number of prints is high, the pictures may be printed in batches. In this case, the remaining number of prints indicated may differ from the number set.
- When you print RAW images, JPEG images that were recorded at the same time will be printed. If JPEG images were not recorded, printing is not possible.
- Images recorded with the following functions cannot be printed:
 - Video recording/[6K/4K Burst]/[Post-Focus]
 - [HLG Photo]

18. Materials

Using Optional Accessories

- For information on the external flash, refer to page [228](#).
- For information on the external microphone, refer to page [340](#).
- For information on the XLR Microphone Adaptor, refer to page [343](#).
- Some optional accessories may not be available in some countries.

Battery Grip (Optional)

When mounted on the camera, the Battery Grip (DMW-BGS1: optional) improves ease of operation and grip when the camera is held vertically. Also, inserting a battery into the Battery Grip provides a stable supply of power even for long periods of recording.

- The Battery Grip is dust and splash resistant.

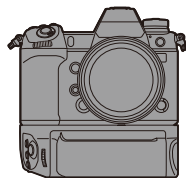

❖ Selecting Battery Usage Priority

Selects which battery to use first when the batteries are installed in both the camera and the Battery Grip.

The order of battery charging using the camera body is also determined by this setting.



Getting started:

- Turn the camera off, and remove the cover for the battery grip connector.

1 Attach the Battery Grip to the camera.



2 Turn on the camera.

3 Set the battery use priority.

-  ⇒ [] ⇒ [] ⇒ [Battery Use Priority]

[BODY]	The battery in the camera is used first.
[BG]	The battery in the Battery Grip is used first.



- When the battery in the Battery Grip is used, [] is displayed on the monitor.
- You can register functions of your choice to the [Fn] button on the Battery Grip. (→ 367)
The [WB] button, [ISO] button, [] button, [AF ON] button, and joystick each work the same as the buttons and joystick on the camera body.
- Refer to the operating instructions for the Battery Grip for details.

Shutter Remote Control (Optional)

You can connect the Shutter Remote Control (DMW-RS2: optional) to use the camera as follows:

- Fully pressing the shutter button without camera shake
- Securing the shutter button during bulb recording and burst recording
- Start/end the video recording
- Using the functions registered in the video rec. button of the Shutter Remote Control

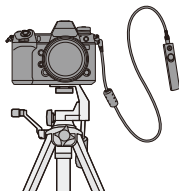

❖ Registering Functions to the Video Rec. Button

You can register a favorite function to the video rec. button on a Shutter Remote Control.

The functions that can be registered are the same as the functions that can be registered to the Fn buttons for recording (→ 371).

[Video Record] is registered in the default setting.



→ [] → [] → Select [Video Rec. Button (Remote)]

- Register functions using the same operations as [Fn Button Set]. (→ 367)



- Always use a genuine Panasonic Shutter Remote Control (DMW-RS2: optional).
- Refer to the operating instructions for the Shutter Remote Control for details.

AC Adaptor (Optional)/DC Coupler (Optional)

With an AC Adaptor (DMW-AC10: optional) and DC Coupler (DMW-DCC16: optional), you can perform recording and playback without worrying about the remaining battery charge.







- Be sure to purchase both an AC Adaptor and a DC Coupler as a set. They cannot be used independently of one another.
- When the DC Coupler is being mounted, the DC Coupler cover opens, so the structure ceases to be dust and splash resistant. Do not allow sand, dust and water droplets to adhere to or enter the camera. After use, confirm that no foreign objects are adhering to the DC Coupler cover, then firmly close the cover.
- For details, refer to the operating instructions for the AC Adaptor and DC Coupler.

Monitor/Viewfinder Displays

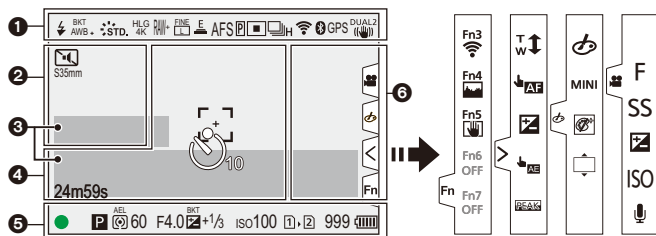











- The screen is an monitor display example of when [LVF/Monitor Disp. Set] is set to .

Recording Screen













	Flash mode (→ 231)
	Flash setting (→ 236, 238)
AWBc AWBw 	White balance (→ 204)
BKT AWB	White Balance Bracket, White Balance Bracket (Color Temperature) (→ 165)
AWB + AWB -	Adjusting the white balance (→ 208)
	Photo Style (→ 210)
*EXPS	Filter setting (→ 216)/ Filter effect adjustment (→ 216)

HLG 4K	HLG photo (→ 226)
MON LUT HDMI V-Log	LUT View Assist (→ 310)
MON MODE2 HDMI HLG	HLG View Assist (→ 314)
RAW+ FINE L STD M	Picture quality (→ 90)/ Picture size (→ 88)
EXM	Extended Tele Conversion (→ 128)
MOV 420/8-L FHD 24p	Recording file format (→ 255)/ Recording quality (→ 255)
MOV FHD 420/8-L	Recording file format (→ 255)/ Recording quality (→ 255)
59.94p 60/59.94p	Recording frame rate (→ 255)/Variable frame rate (→ 297)
E	Electronic shutter (→ 175)
AFS AFC MF	Focus mode (→ 96, 123)







 BKT AFS	Focus Bracket (→ 164)
 AFL	AF Lock (→ 199)
 P	Focus Peaking (→ 402)
 FULL S35mm PIXEL PIXEL	Image area of video (→ 266)
	AF mode (→ 103)
	Drive mode (→ 131)
	Post-Focus (→ 166)
	Connected to Wi-Fi (→ 466)
	Connected to Bluetooth (→ 471)
	Location logging (→ 488)
	Image stabilizer (→ 177)
	Camera shake alert (→ 178)

2









 PRE	Pre-Burst recording (→ 140)
	Multiple exposures (→ 408)
	Silent mode (→ 174)
 S35mm PIXEL PIXEL	Image area of video (→ 266)
 2.0x	Anamorphic Desqueeze Display (→ 316)

 FLICKER	Flicker Decrease (Photo) (→ 407)
	High Resolution mode (→ 222)
	Overlay indication (→ 437)
	LUT View Assist (→ 310)
	HLG View Assist (→ 314)
	Loop recording (→ 320)

3







 TC 00:00:00:00	Time code (→ 268)
	Built-in microphone, External microphone (→ 283, 340)/ XLR microphone adaptor setting (→ 343)
	Sound recording level limiter (→ 285)
	Mute (→ 283, 284)
	Sound recording level (→ 283)
	Exposure meter (→ 436)

4



	Histogram (→ 432)
	AF area (→ 118)
	Spot metering target (→ 185)
	Center marker (→ 440)
	Self-timer (→ 158)
	Lock lever (→ 67)
	Elapsed recording time (→ 242)
	Image being sent (→ 486)

5















2019.12. 1 10:00:00	Time stamp recording (→ 417)
●	Focus (turns green) (→ 61)/ Recording state (turns red) (→ 223, 242)
LOW ●	Focus (in low light AF situations) (→ 98)
STAR ●	Focus (Starlight AF) (→ 98)
⚡	Flash adjustment (→ 235)
iA P A S M P CS-1 P	Recording mode (→ 63)
P ↗	Program Shift (→ 187)
☉ ☉ ☉ ☉ AE	Metering mode (→ 185)
AEL	AE Lock (→ 199)
60	Shutter speed (→ 61)
F4.0	Aperture value (→ 61)
BKT F4.0	Aperture Bracket (→ 163)
BKT ⊠ +1/3	Exposure compensation value (→ 197) Exposure Bracket (→ 163)
MM+1	Manual Exposure Assist (→ 194)
iso100	ISO sensitivity (→ 200)/ Dual Native ISO setting (→ 203)



	Card access indication (turns red) (→ 242)
	Card slot (→ 48)/Double card slot function (→ 92)
	No card
	Card full
999	Number of still images that can be taken (→ 582)
r20	Number of pictures that can be taken continuously (→ 134)
24m59s	Video recording time (→ 583)
	Battery indication (→ 44)
	Power supply (→ 43)
	Battery Grip (→ 539)

6

	Temperature rise warning icon (→ 557)
	Fan error warning icon (→ 567)

Touch Tab (→ 425)

Fn	
	Fn button (→ 375)
	
	Touch Zoom (→ 129)
	Touch AF, Touch Shutter (→ 84)
	Exposure compensation (→ 197)
	Touch AE (→ 85)
	Focus Peaking (→ 402)
  (→ 251)	
	Type of defocus ([Miniature Effect]) (→ 219)
	One Point Color (→ 220)
	Light source position ([Sunshine]) (→ 220)
	Filter effect adjustment (→ 216)
	Filter on/off (→ 218)
MINI	Filter setting (→ 216)
F	Aperture value (→ 251)
SS	Shutter speed (→ 251)

	Exposure compensation (→ 251)
ISO	ISO sensitivity (→ 251)
	Sound recording level adjustment (→ 251)

❖ Control Panel



1

	Recording mode (→ 63)
1/60	Shutter speed (→ 61)
F4.0	Aperture value (→ 61)
	Battery indication (→ 44)
	Power supply (→ 43)
	Battery indication (battery grip) (→ 44)
	Wi-Fi/Bluetooth connection state (→ 466)









2

	ISO sensitivity (→ 200)/ Dual Native ISO setting (→ 203)
100	
	Exposure compensation value (→ 197)/ Manual Exposure Assist (→ 194)
±0	
	Flash setting (→ 235, 236, 238)/ Flash mode (→ 231)
±0	

3

	Drive mode (→ 131)/ Post-Focus (→ 166)/ High Resolution mode (→ 222)
	AFS Focus mode (→ 96, 123)
	AF mode (→ 103)
FINE	Picture quality (→ 90)
S35mm	Image area of video (→ 266)/Recording file format (→ 255)/Recording quality (→ 255)
3:2	Picture size/Aspect ratio (→ 88)
	HLG photo (→ 226)
	Fn button settings (→ 367)

4

 STD.	Photo Style (→ 210)
AWB	White balance (→ 204)
 iOFF	i.Dynamic Range (→ 399)
	Metering mode (→ 185)
 	Card slot (→ 48)/Double card slot function (→ 92)
 	No card
 	Card full
999	Number of still images that can be taken (→ 582)
r20	Number of pictures that can be taken continuously (→ 134)
R24m59s	Video recording time (→ 583)
----	No card

❖ Control Panel ([**CM**] Mode)

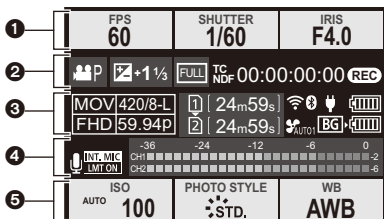

1

FPS 60	Frame rate (→ 255)/ Variable frame rate (→ 297)
SHUTTER 1/60	Shutter speed (→ 61)
IRIS F4.0	Aperture value (→ 61)

2

	Exposure mode (→ 249)
 	Exposure compensation value (→ 197)/Manual Exposure Assist (→ 194)
	Image area of video (→ 266)
TC NDF 00:00:00:00	Time code (→ 268)
	Recording state (→ 242)

3

 	Recording file format (→ 255)/Recording quality (→ 255)
 	Card slot (→ 48)/Double card slot function (→ 92)
24m59s	Video recording time (→ 583)

 	Wi-Fi/Bluetooth connection state (→ 466)
 AUTO1	Fan operating mode (→ 442)
	Battery indication (→ 44) Power supply (→ 43)
 	Battery indication (battery grip) (→ 44)

4

 96kHz/24bit 	Built-in microphone, External microphone (→ 283, 340)/ XLR microphone adaptor setting (→ 343)
 	Sound recording level limiter (→ 285)
	Mute (→ 283, 284)
	Sound recording level (→ 283)

5

ISO AUTO 100	ISO sensitivity (→ 200)/ Dual Native ISO setting (→ 203)
PHOTO STYLE *STD. MCN LUT HDMI V4.0g MCN MODE2 HDMI HLG	Photo Style (→ 210)/ LUT View Assist (→ 310)/ HLG View Assist (→ 314)
WB AWB	White balance (→ 204)

Playback Screen

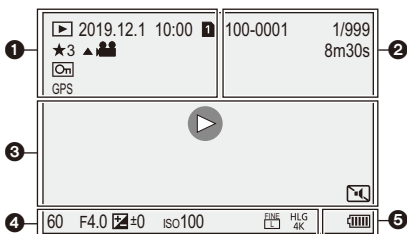











1

	Playback mode (→ 457)
2019.12. 1 10:00	Recording date and time (→ 56)
1 2	Card slot (→ 48)
★ 3	Rating (→ 460)
▲ 👤	Video playback (→ 349)
On	Protected picture (→ 460)
GPS	Location logging (→ 488)
	Obtaining information
	Cable disconnect prohibit icon (→ 538)
	Marker available (→ 144, 146)
	Reduce Rolling Shutter (→ 143)
	Saving pictures from a 6K/ 4K burst file (→ 142)
	Saving pictures from a Post-Focus image (→ 169)
8m30s	Elapsed playback time (→ 349)

2

100-0001	Folder/file number (→ 528)
1/999	Image number/Total number of images
9 pic. 9 files	Number of group images/ Number of files
8m30s	Video recording time (→ 349)
XXmXXs XXs	Variable frame rate (→ 297)
XXmXXs	Loop recording (→ 320)
MON MODE2	HLG View Assist (→ 314)
MON LUT	LUT View Assist (→ 310)



3

	Playback (video) (→ 349)
    	Group images (→ 356)
TC 00:00:00:00	Time code (→ 268)
96kHz/24bit 	XLR microphone adaptor setting (→ 343)
MOV	Recording file format (→ 255)/
FHD	Recording quality (→ 255)
420/8-L	Recording quality (→ 255)
59.94p	Frame rate (→ 255)/
60/59.94p	Variable frame rate (→ 297)
FULL S35mm PIXEL PIXEL	Image area of video (→ 266)
 	Wi-Fi/Bluetooth connection state (→ 466)
	Silent mode (→ 174)

4

Recording information

5

	Battery indication (→ 44)
	Power supply (→ 43)
	Battery Grip (→ 539)

Detailed information display

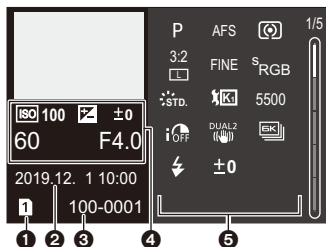

- 1 Card slot (→ 48)
- 2 Recording date and time (→ 56)
- 3 Folder/file number (→ 528)
- 4 Recording information (basic)
- 5 Recording information (advanced)

Photo Style display

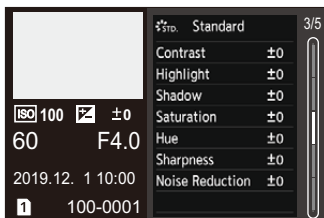

White balance display

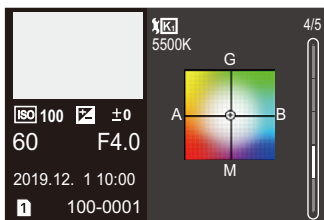

Histogram display

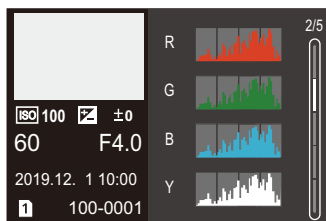

Lens information display

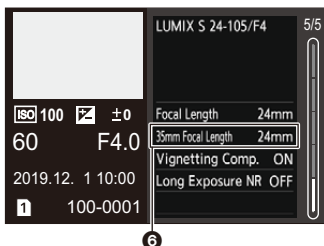

- 6 The focal length corresponding to the angle of view when using a full-frame lens with the [Aspect Ratio] set to [3:2]

Message Displays

Meanings of main messages displayed on the camera screen, and response methods.

❖ Card

[Memory Card Error]/[Format this card?]

- It is a format that cannot be used with the camera.
Either insert another card, or back up any necessary data before formatting. (→ 50)

[Memory Card Error]/[This memory card cannot be used]

- Use a card compatible with the camera. (→ 25)

[Insert memory card again.]/[Try another card]

- Unable to access the card. Reinsert the card.
- Insert a different card.

[Read Error]/[Write Error]/[Please check the card]

- Failure to read or write data.
Turn off the camera, reinsert the card, and then turn it on again.
- The card may be broken.
- Insert a different card.

[Unable to record AVCHD video. The selected system frequency does not match the AVCHD data on this SD card. Please use another SD card or change the system frequency.]

- If you change the [System Frequency], you may no longer be able to record video to the same card.
Try again after either returning the [System Frequency] to the original setting or inserting another card.

[Recording was cancelled due to the limitation of the writing speed of the card]

- Insufficient card write speed for video, 6K/4K photo, or Post-Focus recording. Use a card of a supported Speed Class. (→ 26)
- If the recording stops even when you are using a card that meets the specified Speed Class rating, the data writing speed of the card is getting slow. We recommend backing up data, and formatting (→ 50).
- Depending on the type of card, recording may stop part way.

[Now writing]

- The card door or battery door is opened while writing to a card. Wait until writing is finished, then turn the camera off and remove.

❖ Lens

[The lens is not attached properly. Do not push lens release button while lens is attached.]

- Remove the lens once, and then attach it again without pressing the lens release button. (→ 51)
Turn on the camera again, and if it is still displaying, contact the dealer.

[Lens attachment failed. Please make sure the lens is attached correctly.]

- Remove the lens from the camera body and gently wipe the contacts on the lens and the camera body using a dry cotton swab.
Attach the lens, turn on the camera again, and if it is still displaying, contact the dealer.

❖ Battery

[This battery cannot be used]

- Use a genuine Panasonic battery.
If this message is displayed even when a genuine Panasonic battery is used, contact the dealer.
- If the terminal of the battery is dirty, remove the dirt and dust from the terminal.

❖ Wi-Fi

[Failed to connect wireless access point]/[Connection failed]/[No destination found]

- The wireless access point information set on the camera is wrong.
Check the authentication type and encryption key. (→ 511)
- Radio waves from other devices may block the connection to a wireless access point.
Check the status of other devices that are connected to the wireless access point as well as the status of other wireless devices.

[Connection failed. Please retry in a few minutes.]/[Network disconnected. Transfer stopped.]

- Radio waves from the wireless access point are getting weak.
Perform the connection closer to the wireless access point.
- Depending on the wireless access point, connection may be automatically disconnected after specific time has passed.
Reconnect the connection again.

[Connection failed]

- Change the access point to connect to in the smartphone Wi-Fi settings to the camera.

❖ Others

[Some pictures cannot be deleted]/[This picture cannot be deleted]

- Images that do not comply with the DCF standard cannot be deleted.
Back up any necessary data before formatting the card. (→ 50)

[Cannot be set on this picture]

- Images that do not comply with the DCF standard cannot be edited.

[A folder cannot be created]

- The maximum number of folder numbers has been reached, so new folders cannot be created.
Back up any necessary data before formatting the card. (→ 50)
After formatting, execute [File Number Reset] in the [Setup] ([Card/File]) menu to reset the folder number to 100. (→ 95)

[Please turn camera off and then on again]/[System Error]

- Turn off and on the camera.

If the message is displayed even when doing this several times, contact the dealer.

[The fan is not functioning correctly.]

- The fan has stopped. Turn off and on the camera. If the fan does not work after turning the camera off and then on again, consult the dealer.
- The temperature of the camera will rise if you continue to use the camera with the fan stopped. Do not use over long periods of time.

Troubleshooting

First, try out the following procedures (→ 557 to 568).

If the problem is not resolved, it may be improved by selecting [Reset] (→ 80) on the [Setup] ([Setting]) menu.

Power, Battery

The camera turns off automatically.

- [Power Save Mode] is enabled. (→ 46)

The battery becomes flat too quickly.

- When [6K/4K Pre-Burst] or [Pre-Burst Recording] is set, the battery drains faster. Set these settings only when recording.
- When connected to Wi-Fi, the battery drains quickly. Turn the camera off frequently such as by using [Power Save Mode] (→ 46).

Recording

Recording stops before finishing.

Cannot record.

Cannot use some functions.

- In high ambient temperatures or if the camera is used for continuous recording, the temperature of the camera will rise. To protect the camera against a rise in temperature, after [] is displayed, recording will be stopped, and the following functions will not be available for a time. Wait until the camera cools down.
 - [6K/4K PHOTO]
 - [Post-Focus]
 - Video recording
 - [AF-Point Scope]

Cannot record images.

The shutter will not operate immediately when the shutter button is pressed.

- If [Focus/Shutter Priority] is set to [FOCUS], then recording will not take place until focus is achieved. (→ 421)

The recorded image is whitish.

- Images may look whitish when the lens or image sensor gets dirty with fingerprints or similar.

If the lens is dirty, turn the camera off, then wipe the lens surface with a soft, dry cloth.

For information about how to clean the image sensor, refer to page 571.

The recorded image is too bright or dark.

- Ensure AE Lock is not set where it is not appropriate. (→ 199)

Multiple images are recorded at once.

- When drive mode is set to [I] (Burst Shot 1) or [II] (Burst Shot 2), pressing and holding the shutter button will take burst pictures. (→ 131)
- When [Bracketing] is set, then pressing the shutter button records multiple images while automatically changing the settings. (→ 160)

The subject is not focused properly.

- Confirm the following details:
 - Is the subject outside of the focus range?
 - Is [Shutter AF] set to [OFF]? (→ 424)
 - Is [Focus/Shutter Priority] set to [RELEASE]? (→ 421)
 - Is AF Lock (→ 199) set where it is not appropriate?

The recorded image is blurred.

The image stabilizer is not effective.

- The shutter speed will become slower and the image stabilizer function may not work properly when recording in dark places.
In these cases, use a tripod and the self-timer when recording.

The recorded image looks rough.**Noise appears on the picture.**

- Try the following:
 - Reduce the ISO sensitivity. (→ 200)
 - Increase [Noise Reduction] of [Photo Style] to the positive direction, or adjust each item other than [Noise Reduction] to the negative direction. (→ 213)
 - Set [Long Exposure NR] to [ON]. (→ 397)

The subject appears distorted on the image.

- When a moving subject is recorded while using the following functions, the subject may appear distorted in the picture:
 - [ELEC.]
 - Video recording
 - [6K/4K PHOTO]

This is a characteristic of the CMOS sensor that is the image sensor of the camera, and is not a malfunction.

Striping or flicker may appear under lighting such as fluorescent or LED lighting.

- This is characteristic of CMOS sensors which serve as the camera's pickup sensors.
This is not a malfunction.
- When using the electronic shutter (→ 175), lowering the shutter speed may reduce the effect of the horizontal stripes.
- If flicker is noticeable when recording pictures, set [Flicker Decrease (Photo)]. (→ 407)
- If flicker or horizontal stripes are noticeable when recording video, this can be mitigated by fixing the shutter speed.
Either set [Flicker Decrease (Video)] (→ 411), or record in [M] mode (→ 247).



Stripes appear in high ISO sensitivity.

- Stripes may appear in high ISO sensitivity or depending on the lens you use. Decrease the ISO sensitivity. (→ [200](#))

The brightness or coloring of the recorded image is different from the actual scene.

- When recording under lighting such as fluorescent or LED lighting, increasing the shutter speed may introduce slight changes to brightness or coloring. These are a result of the characteristics of the light source and do not indicate a malfunction.
- When recording subjects in extremely bright locations or recording under lighting such as fluorescent, LED, mercury, or sodium lighting, the coloring or screen brightness may change or horizontal striping may appear on the screen.

Bright spot not in subject is recorded.

- Pixels may be missing from the image sensor. Perform [Pixel Refresh]. (→ [454](#))

Video

Cannot record videos.

- If you change the [System Frequency], you may no longer be able to record video to the same card.
Try again after either returning the [System Frequency] to the original setting or inserting another card.
- When using a large capacity card, you may not be able to record for a while after turning on the camera.

Video recording stops in the middle.

- Recording video requires a card of a supported speed class. Use a compatible card. (→ 26)

In videos, abnormal clicking and buzzing sounds are recorded.

The recorded audio is very quiet.

- Depending on the recording conditions or the lens used, the sound of aperture and focus actions may be recorded in videos.
You can set the focus operation during video recording to [OFF] in [Continuous AF] (→ 275).
- Do not block the microphone hole during video recording.

An operation sound is recorded in a video.

- We recommend setting the [P/M] mode and recording with touch operation if you are bothered about the operation sounds during recording. (→ 251)



Playback

Cannot play back.

There are no recorded pictures.

- Folders and images processed on a PC cannot be played on the camera.
We recommend using the software “PHOTOfunSTUDIO” to write images from the PC to the card.
- Some images are not displayed when the [Playback Mode] is set. Set to [Normal Play]. (→ 457)
- Videos recorded with a different [System Frequency] setting cannot be played back. Return the [System Frequency] setting to the one you used during the recording. (→ 253)

Red part of the recorded image has changed color to black.

- When Red-Eye Removal ([] or []) is performed, red parts may be corrected to black.
We recommend recording images with the flash mode set to [] or [Red-Eye Removal] set to [OFF]. (→ 233)

Monitor/Viewfinder

The monitor/viewfinder turns off when the camera is turned on.

- If no operations are performed during the set time period, [Auto LVF/Monitor Off] (→ 46) is activated, and the monitor/viewfinder turns off.
- When an object or your hand is positioned near the eye sensor, the monitor display may switch to the viewfinder display.

It may flicker for an instant or the brightness of the screen may change significantly for an instant.

- This occurs when the shutter button is pressed halfway, or when the subject brightness changes, making the lens aperture change.
This is not a malfunction.

Cannot switch between the monitor and viewfinder even when [LVF] is pressed.

- When the camera is connected to a PC or printer, it is not possible to switch to the viewfinder display.

Unevenly bright parts or irregular colors appear on the viewfinder.

- The viewfinder of the camera is built with OLED components. Screen burn-in may occur on the screen/viewfinder when a same image is displayed for a long period of time, but it does not affect the recorded images.

The coloring of the viewfinder differs from the actual tone.

- This is characteristic of the viewfinder of the camera and not a malfunction. It does not affect the recorded images.

Flash

The flash does not fire.

- The flash does not fire when using the following functions:
 - Video recording (→ 242)/[6K/4K PHOTO] (→ 136)/[Post-Focus] (→ 166)
 - [ELEC.] (→ 175)/[Silent Mode] (→ 174)/[High Resolution Mode] (→ 222)
 - [Filter Settings] (→ 216)

Wi-Fi Function

A Wi-Fi connection cannot be established.

Radio waves get disconnected.

Wireless access point is not displayed.

General tips for using a Wi-Fi connection

- Use within the communication range of the device to be connected.
- Usage near devices that utilize the 2.4 GHz frequency such as microwave ovens and cordless telephones may result in the radio wave being lost.
Use the camera at a sufficient distance from these devices.
- When the remaining battery level is low, it may not be possible to connect to or maintain communication with other devices.
(A message such as [Communication error] is displayed.)
- If you place the camera on a metal table or shelf, the radio waves may be adversely affected. In such cases, you may not be able to establish a connection.
Move the camera away from the metal surface.

Wireless access point

- Confirm that the connected wireless access point can be used.
- Confirm the radio wave conditions of the wireless access point.
 - Move the camera closer to the wireless access point.
 - Change the location and angle of the wireless access point.
- Depending on the wireless access point, the radio wave may not be displayed even though it is present.
 - Turn off and then on the wireless access point.
 - If the wireless channel of the wireless access point cannot be set automatically, manually set the channel supported by the camera.
 - If the wireless access point SSID is set not to broadcast, it may not be detected.
Enter the SSID, and then connect. (→ 511)

The camera is not displayed in the Wi-Fi setting screen of the smartphone.

- From the Wi-Fi setting menu on the smartphone, turn off and then on the Wi-Fi function.

When trying to connect to a PC by Wi-Fi, this does not recognize the user name and password, and connection is not possible.

- Depending on the version of the OS, there are two types of user account (local account/Microsoft account).

Ensure you use the local account user name and password.

The PC is not recognized when I use a Wi-Fi connection.

The camera cannot be connected to the PC using the Wi-Fi function.

- At the time of purchase, this camera is set to use a workgroup name of "WORKGROUP".
If you have changed the workgroup name of the PC, this will not be recognized.
In the [Wi-Fi Setup] menu, [PC Connection], change the workgroup name of the PC to which to connect. (→ 517)
- Check that the login name and password are correctly typed.
- When the clock settings of the PC connected to the camera differs considerably from those of the camera, the camera cannot be connected to the PC depending on the OS.

Images cannot be transmitted to the web service.

- Confirm that the login information (login ID/user name/email address/password) is correct.

It takes time to transmit an image to the web service.

Transmission of the image fails midway.

Some images cannot be transmitted.

- Is the size of the image too large?
 - Reduce the image size at [Size] (→ 515), and then send.
 - Transmit after dividing the video with [Video Divide] (→ 364).
- It may take longer time to transmit when distance to the wireless access point is far.
Transmit closer to the wireless access point.
- File format of the video that can be sent differs depending on the destination.
(→ 494)

I have forgotten the password for the Wi-Fi.

- In the [Setup] ([Setting]) menu, [Reset], reset network settings. (→ 80)
However, all information set in [Wi-Fi Setup] and [Bluetooth] will also be reset.
(With the exception of [LUMIX CLUB])

TV, PC, Printer

No image on the TV.

The TV screen is blurry or not colored.

- Confirm the connection with the TV. (→ 524)
- Set the TV input to HDMI input.

The TV images are displayed with gray bands.

- Depending on the [Aspect Ratio], gray bands may be displayed on the top and bottom or the left and right of the images. You can change the band color in [Background Color(Playback)] in [TV Connection] of the [Setup] ([IN/OUT]) menu. (→ 452)

VIERA Link is not working.

- Check that the [VIERA Link (CEC)] of the camera is set to [ON]. (→ 452)
- Check the VIERA Link setting on the connected device.
- Turn off and on the camera.

Cannot communicate with the PC.

- Set the [USB Mode] of the camera to [PC(Storage)]. (→ 449)
- Turn the camera off and on.

Cannot print when the camera is connected to a printer.

- Pictures cannot be printed using a printer that does not support PictBridge.
- Set the camera's [USB Mode] to [PictBridge(PTP)]. (→ 449)

The ends of the images are cut at printing.

- If the printer has trimming or borderless printing functions, cancel these settings before printing.
(Refer to the operating instructions for your printer.)
- Depending on the photo studio, images recorded with their aspect ratio set to 16:9 can be printed at sizes in 16:9 aspect ratio. Ask the photo studio in advance.

Others**[] is displayed on the screen.**

- The fan has stopped. Turn off and on the camera. If the fan does not work after turning the camera off and then on again, consult the dealer.
- The temperature of the camera will rise if you continue to use the camera with the fan stopped. Do not use over long periods of time.

An alarm sounds when the card door or battery door is opened.

- An alarm may sound when a door is opened while writing to a card. Wait until writing finishes, then turn the camera off and remove the card or battery.

When the camera is shaken, a rattling sound is heard from the camera.

- The sound is caused by the in-body stabilizer. This is not a malfunction.

The camera makes a noise when it is turned on.

- This is the noise of the dust reduction function working (→ 571); it is not a malfunction.

There is rattling noise from the lens when the camera is turned on or off, or when the camera is swung.

There is a sound from the lens when recording.

- This is the sound of the lens moving and aperture operation. It is not a malfunction.

A red light sometimes turns on when the shutter button is pressed halfway.

- In dark places, the red AF assist light (→ 401) turns on to make it easier to focus on a subject.

An unreadable language was selected by mistake.

- Reselect the language from the menu using the following procedure:

 ⇒ [] ⇒ [] ⇒ [] ⇒ Select desired language (→ 455)

The camera becomes warm.

- The camera surface and back of the monitor may become warm during use, but this does not indicate a problem with performance or quality.

The clock is wrong.

- When the camera is left for a long time, the clock may reset.
Reset the clock. (→ 56)

Cautions for Use

❖ The camera

Keep this unit as far away as possible from electromagnetic equipment (such as microwave ovens, TVs, video games etc.).

- If you use this unit on top of or near a TV, the pictures and/or sound on this unit may be disrupted by electromagnetic wave radiation.
- Do not use this unit near cell phones because doing so may result in noise adversely affecting the pictures and/or sound.
- Recorded data may be damaged, or pictures may be distorted, by strong magnetic fields created by speakers or large motors.
- Electromagnetic wave radiation may adversely affect this unit, disturbing the pictures and/or sound.
- If this unit is adversely affected by electromagnetic equipment and stops functioning properly, turn this unit off and remove the battery or disconnect AC adaptor. Then reinsert the battery or reconnect AC adaptor and turn this unit on.

Do not use this unit near radio transmitters or high-voltage lines.

- If you record near radio transmitters or high-voltage lines, the recorded pictures and/or sound may be adversely affected.

Always use the supplied cords and cables.

If you use optional accessories, use the cords and the cables supplied with them.

Do not extend the cords or the cables.

Keep items away from the magnetic parts (A)/(B)/(C)/(D) that are easily influenced by magnetism.

- The effects of the magnets may cause items like bank cards, commuter cards, and clocks to cease functioning correctly.

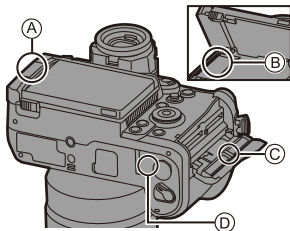

Do not spray the camera with insecticides or volatile chemicals.

- If the camera is sprayed with such chemicals, the body of the camera may be damaged and the surface finish may peel off.

Do not keep products made of rubber, PVC or similar materials in contact with the camera for a long period of time.

❖ When using in cold places or at low temperatures

- Skin burns may result if you leave the metal parts of the camera in direct contact with the skin for long periods of time at cold places (environments with temperatures at or below 0 °C (32 °F), such as ski resorts or places at high altitude).

Use gloves or similar when using it for long periods.

- The performance of the battery (Number of pictures that can be taken/available recording time) may decrease temporarily at temperatures between –10 °C and 0 °C (14 °F and 32 °F).

Keep the battery warm as you are using by keeping it inside your cold weather gear or clothes. Battery performance will recover when the internal temperature rises again.

- The battery cannot be charged at temperatures below 0 °C (32 °F).

An error message is shown on the charger or on the camera body when charging is not possible.

– When charging with the charger: The 50% charged light blinks rapidly.

– When charging in the camera body: [ERROR] is displayed on the status LCD.

- If using in cold locations, do not allow water droplets and snow to remain on the camera.

If these are left on the camera, water may freeze in gaps in the camera on/off switch, speaker, and microphone, making these parts difficult to move, and/or leading to reduced volume. This is not a malfunction.

❖ Cleaning

Before cleaning the camera, remove the battery or the DC Coupler, and disconnect the power plug from the electrical outlet. Then wipe the camera with a dry, soft cloth.

- When the camera is soiled badly, it can be cleaned by wiping the dirt off with a wrung wet cloth, and then with a dry cloth.
- Do not use solvents such as benzine, thinner, alcohol, kitchen detergents, etc., to clean the camera, since it may deteriorate the external case or the coating may peel off.
- When using a chemical cloth, be sure to follow the accompanying instructions.

❖ Dirt on the image sensor

If dirt gets inside the mount when changing lenses, depending on the recording conditions, it may adhere to the image sensor and appear on the recorded picture.

To prevent debris or dust adhering to internal parts of the body, avoid changing the lens in a dusty environment and always fit the body cap or a lens when storing the camera.

Remove any dirt on the body cap before attaching it.

Dust reduction function

The camera has a dust reduction function that will blow off the dirt and dust that have affixed to the front of the image sensor.

This function will function automatically when the camera is turned on, but if the dirt is particularly noticeable, from the [Setup] ([Others]) menu, perform [Sensor Cleaning].

Removing dirt on the image sensor

The image sensor is very precise and delicate, so be sure to observe the following when you do have to clean it yourself.

- Blow dust off the surface of the image sensor using a commercially available blower. Do not blow the dust off with excessive power.
- Do not put the blower brush further inside than the lens mount.
- Do not let the blower brush touch the image sensor as the image sensor may get scratched.
- Do not use any objects except a blower brush to clean the image sensor.
- If you cannot remove the dirt or dust with the blower, consult the dealer or Panasonic.

❖ Cleaning the Viewfinder

If the viewfinder is dirty, then remove the eye cup and clean.

While pushing the eye cup lock lever (A), rotate the eye cup in the direction of the arrow and remove (B).

Blow dirt off the surface of the viewfinder using a commercially available blower, then lightly wipe with a soft, dry cloth.

- After cleaning, align the fitting marks (Δ) (C) and press and rotate the eye cup in the direction of the arrow until a click is heard (D).
- Be careful not to lose the eye cup.

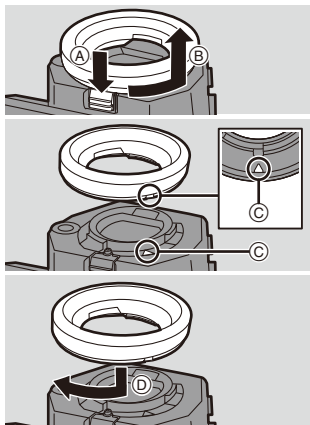

❖ Monitor/Viewfinder

- Do not push hard on the monitor.
This may cause irregular coloration or malfunction.
- Extremely high precision technology is employed to produce the monitor/viewfinder screen. However there may be some dark or bright spots, or spots that light constantly (red, blue, or green) on the screen.
This is not a malfunction.
Though the monitor/viewfinder screen parts are produced with highly controlled precision technology, some pixels may be inactive or always lit.
The spots will not be recorded on images on a card.

❖ Battery

The battery is a rechargeable lithium ion battery. It is highly sensitive to temperature and humidity, and the effect on performance increases as the temperature rises or drops.

Always remove the battery after use.

- Place the removed battery in a plastic bag, etc., and keep away from metallic objects (clips, etc.) for storage or transport.

If you drop the battery accidentally, check to see if the body of the battery and the contacts are deformed.

- Damage to the camera will result if a battery with deformed contacts is inserted into the camera.

Dispose of unusable battery.

- The battery has a limited life.
- Do not throw the battery into fire because it may cause an explosion.
- The unusable battery should be discarded in accordance with battery recycling laws. Call the RBRC hotline at 1-800-822-8837 for information.

Do not allow battery terminals to come into contact with metal objects (such as necklaces, hairpins, etc.).

- This can cause short-circuiting or heat generation and you may be badly burned if you touch a battery.

❖ Charger, AC Adaptor

- The [CHARGE] light may blink under the influence of static electricity or electromagnetic wave, depending on the charging environment. This phenomenon has no effects on charging.

- If you use the battery charger near a radio, the radio reception may be disturbed.

Keep the charger 1 m (3.3 feet) or more away from radio.

- During usage, the AC adaptor may emit an electrical hum; this is not a malfunction.
- After use, be sure to disconnect the power plug from the electrical outlet.
(A very small amount of current is consumed if it is left connected.)
- Keep the contacts (A) of the charger and battery clean.
Wipe them with a dry cloth if they get dirty.

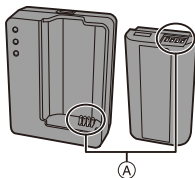

❖ Card

Do not leave the card in areas with high temperatures, direct sunlight, or areas prone to electromagnetic waves and static.

Do not bend or drop the card.

Do not subject the card to strong vibration.

- Otherwise, the card and recorded data may be damaged.
- Put the card in the card case or the storage bag after use and when storing or carrying the card.
- Do not allow dirt, water or other foreign objects to get into the contacts on the card.
Additionally, do not touch the contacts with your hands.

Points to remember when disposing of/transferring the memory card

Format or delete using the camera or a PC will only modify the file management information, so it will not delete the data in the card completely.

We recommend physically destroying the card or using commercially available PC data deletion software to delete the card data completely when disposing of/transferring the card.

You are responsible for handling of data on cards.

❖ Personal Information

Personal information is stored within the camera and in recorded images. We recommend that you enhance security by setting a Wi-Fi password and Wi-Fi function lock to protect personal information. (→ 517, 518)

Disclaimer

- Information including personal information may be altered or vanish due to erroneous operation, effect of static electricity, accident, malfunction, repair, or other handlings.

Please note in advance that Panasonic is not liable in any way for any direct or indirect damage from the alteration or vanishing of information or personal information.

When requesting a repair or transferring/disposing of the camera

- After making a copy of personal information, be sure to delete information, including personal information, such as wireless LAN connection settings that you have registered or saved within the camera with [Reset] (→ 80), and [Delete account]([LUMIX CLUB]) (→ 521).
- Reset the settings to protect the personal information. (→ 80)
- Remove the card from the camera.
- Settings may return to factory default when camera is repaired.
- Please contact the dealer where you purchased the camera or Panasonic if above operations are not possible due to malfunction.

When transferring/disposing of the card, refer to “Points to remember when disposing of/transferring the memory card” on page 574.

When uploading images to a web service

- Images may contain information that can be used to identify the user, such as recording dates and times, and location information.
Confirm details carefully before uploading images to a web service.

❖ When Not Using the Camera for a Long Period of Time

- Ensure you remove the battery and card from the camera.
When the battery is left inserted in the camera, a small amount of current will always flow even if the camera is turned off.
If the battery is left in the camera, it may over-discharge, and be rendered unusable even after charging.
- Store the battery in a cool and dry place with a relatively stable temperature. (Recommended temperature: 15 °C to 25 °C (59 °F to 77 °F); recommended humidity: 40%RH to 60%RH)
- If storing for a long period of time, it is recommended that the battery be charged once per year, fully drained in the camera, then removed from the camera and then stored again.
- We recommend storing the camera with a desiccant (silica gel) when you keep it in a closet or a cabinet.
- Check all the parts before recording when you have not used the camera for a long period of time.

❖ Image Data

- Recorded data may be damaged or lost if the camera breaks down due to inappropriate handling.
Panasonic will not be liable for any damage caused due to loss of recorded data.

❖ Tripod

- Make sure the tripod is stable when the camera is attached to it.
- When using a tripod, removal of the battery may not be possible.
- Make sure that the screw on the tripod is not at an angle when attaching or removing the tripod.
Using excessive force may damage the camera tripod mount.
Also, care is required because tightening the screw excessively may damage the camera, or cause the rating label to come off.
- Please also refer to the operating instructions for the tripod.

❖ **Shoulder Strap**

- If you attach a heavy interchangeable lens to the camera body, do not carry the camera by the shoulder strap.

Hold the camera and the lens when carrying them.

❖ **Wi-Fi Function**

Use the camera as a wireless LAN device

When using devices or computer systems that require more reliable security than wireless LAN devices, ensure that the appropriate measures are taken for safety designs and defects for the systems used.

Panasonic will not take any responsibility for any damage that arises when using the camera for any purpose other than as a wireless LAN device.

Use of the Wi-Fi function of the camera is presumed to be in countries where it is sold

There is the risk that the camera violates the radio wave regulations if used in countries other than those where it is sold, and Panasonic takes no responsibility for any violations.

There is the risk that data sent and received via radio waves may be intercepted

Please note that there is the risk that data sent and received via radio waves may be intercepted by a third party.

Do not use the camera in areas with magnetic fields, static electricity or interference

- Do not use the camera in areas with magnetic fields, static electricity or interference, such as near microwave ovens.

These may cause the interruption of the radio waves.

- Using the camera near devices such as microwave ovens or cordless telephones that use the 2.4 GHz radio wave band may cause a decrease in performance in both devices.

Do not connect to the wireless network you are not authorized to use

When the camera utilizes its wireless LAN function, wireless networks will be searched automatically.

When this happens, wireless networks that you are not authorized to use (SSID*) may be displayed, however do not attempt to connect to the network as it may be considered as unauthorized access.

- * SSID refers to the name that is used to identify a network over a wireless LAN connection. If the SSID matches for both devices, transmission is possible.

Number of Pictures That Can Be Taken and Available Recording Time with the Battery

Listed below are the numbers of pictures that can be taken and the time lengths available for recording when the supplied battery is being used.

- The number of pictures that can be taken is according to the CIPA (Camera & Imaging Products Association) standards.
- Using a Panasonic SDHC memory card.
- Using the interchangeable lens (S-R24105).
- The values listed are approximate.

❖ Recording Pictures (When Using the Monitor)

Number of pictures that can be taken	400
---	------------

❖ Recording Pictures (When Using the Viewfinder)

Number of pictures that can be taken	380 (1150)
---	-------------------

- The numbers in parentheses indicate the values that result when [Time to Sleep] in [Power Save LVF Shooting] is set to [1SEC] and the [Power Save LVF Shooting] function works as intended.

(Based on the test conditions derived from the CIPA standard and specified by Panasonic)

❖ Recording Videos (When Using the Monitor)

[Rec. File Format]	[Rec Quality]	Continuous available recording time (minutes)		Actual available recording time (minutes)	
		[Image Area of Video]		[Image Area of Video]	
		[FULL]	[S35mm]	[FULL]	[S35mm]
[AVCHD]	[FHD/17M/60i] [FHD/17M/50i]	160	140	80	70
[MP4]	[4K/10bit/100M/60p] [4K/10bit/100M/50p]	—	120	—	60
	[4K/8bit/100M/30p] [4K/8bit/100M/25p]	140	130	70	65
	[FHD/8bit/28M/60p] [FHD/8bit/28M/50p]	160	140	80	70
[MOV]	[5.9K/30p/420/10-L] [5.9K/25p/420/10-L]	120	—	60	—
	[4K/60p/420/10-L] [4K/50p/420/10-L]	—	120	—	60
	[4K/30p/422/10-L] [4K/25p/422/10-L]	120	120	60	60
	[FHD/120p/420/10-L] [FHD/100p/420/10-L]	140	130	70	65
	[FHD/60p/422/10-L] [FHD/50p/422/10-L]	140	130	70	65
	[FHD/60p/420/8-L] [FHD/50p/420/8-L]	140	130	70	65

- Actual available recording time is the time available for recording when repeating actions such as turning the camera on and off, starting/stopping recording, etc.

❖ Playback (When Using the Monitor)

Playback time (minutes)	270
-------------------------	-----



- The number of pictures that can be taken and the available recording time vary depending on the surrounding environment and the usage conditions. For example, these will reduce in the following case:
 - In low-temperature environments, such as on ski slopes.
- If the usage duration drops significantly even when the battery is fully charged, then the battery is at the end of its service life.
Check the battery status, and replace with a new battery. (→ 450)

Number of Still Images That Can Be Taken and Video Recording Time with Cards

Listed below are the numbers of pictures and the time lengths of videos that can be recorded on a card.

- The values listed are approximate.

❖ Number of Still Images That Can Be Taken

- [Aspect Ratio]: [3:2]; [Picture Quality]: [FINE]

[Picture Size]	Card capacity		
	32 GB	64 GB	128 GB
[L] (24M)	2470	4940	9780
[M] (12M)	4520	8980	17790
[S] (6M)	7950	15440	30580
[Full-Res.]*	970	1940	3840

- [Aspect Ratio]: [3:2]; [Picture Quality]: [RAW+FINE]

[Picture Size]	Card capacity		
	32 GB	64 GB	128 GB
[L] (24M)	650	1310	2590
[M] (12M)	740	1480	2940
[S] (6M)	790	1590	3160
[Full-Res.]*	460	930	1840

- * Indicates the number of pictures when [L]-size JPEG images are recorded simultaneously with [HLG Photo] set to [Full-Res.].

❖ Video Recording Time

- “h” is an abbreviation for hour, “m” for minute and “s” for second.
- Video recording time is the total time of all the videos which have been recorded.
- [Rec. File Format]: [AVCHD]

[System Frequency]: [59.94Hz (NTSC)]			
[Rec Quality]	Card capacity		
	32 GB	64 GB	128 GB
[FHD/28M/60p]	2h25m	5h00m	9h55m
[FHD/17M/60i]	4h05m	8h10m	16h20m
[FHD/24M/30p]/[FHD/24M/24p]	2h50m	5h45m	11h35m

[System Frequency]: [50.00Hz (PAL)]			
[Rec Quality]	Card capacity		
	32 GB	64 GB	128 GB
[FHD/28M/50p]	2h25m	5h00m	9h55m
[FHD/17M/50i]	4h05m	8h10m	16h20m
[FHD/24M/25p]	2h50m	5h45m	11h35m

- [Rec. File Format]: [MP4]

[System Frequency]: [59.94Hz (NTSC)]			
[Rec Quality]	Card capacity		
	32 GB	64 GB	128 GB
[4K/10bit/100M/60p]/[4K/8bit/100M/30p]/ [4K/8bit/100M/24p]	41m00s	1h25m	2h45m
[4K/10bit/72M/30p]/[4K/10bit/72M/24p]	58m00s	1h55m	3h55m
[FHD/8bit/28M/60p]	2h25m	4h55m	9h45m
[FHD/8bit/24M/24p]	2h50m	5h40m	11h25m
[FHD/8bit/20M/30p]	3h15m	6h30m	13h00m

[System Frequency]: [50.00Hz (PAL)]			
[Rec Quality]	Card capacity		
	32 GB	64 GB	128 GB
[4K/10bit/100M/50p]/[4K/8bit/100M/25p]	41m00s	1h25m	2h45m
[4K/10bit/72M/25p]	58m00s	1h55m	3h55m
[FHD/8bit/28M/50p]	2h25m	4h55m	9h45m
[FHD/8bit/20M/25p]	3h15m	6h30m	13h00m

- **[Rec. File Format]: [MOV]**

[System Frequency]: [59.94Hz (NTSC)]			
[Rec Quality]	Card capacity		
	32 GB	64 GB	128 GB
[4K-A/30p/422/10-I]/[4K-A/24p/422/10-I]/ [C4K/30p/422/10-I]/[C4K/24p/422/10-I]/ [4K/30p/422/10-I]/[4K/24p/422/10-I]	10m00s	21m00s	42m00s
[6K/24p/420/10-L]/[5.9K/30p/420/10-L]/ [5.9K/24p/420/10-L]/[5.4K/30p/420/10-L]/ [4K-A/48p/420/10-L]/[C4K/60p/420/10-L]/ [C4K/48p/420/10-L]/[4K/60p/420/10-L]/ [4K/48p/420/10-L]/[FHD/60p/422/10-I]/ [FHD/30p/422/10-I]/[FHD/24p/422/10-I]	20m00s	42m00s	1h20m
[4K-A/30p/422/10-L]/[4K-A/24p/422/10-L]/ [C4K/60p/420/8-L]/[C4K/30p/422/10-L]/ [C4K/24p/422/10-L]/[4K/60p/420/8-L]/ [4K/30p/422/10-L]/[4K/24p/422/10-L]/ [FHD/120p/420/10-L]	27m00s	56m00s	1h50m
[4K-A/30p/420/8-L]/[4K-A/24p/420/8-L]/ [C4K/30p/420/8-L]/[C4K/24p/420/8-L]/ [4K/30p/420/8-L]/[4K/24p/420/8-L]/ [FHD/60p/422/10-L]/[FHD/60p/420/8-L]/ [FHD/60i/422/10-I]/[FHD/48p/420/10-L]/ [FHD/30p/422/10-L]/[FHD/30p/420/8-L]/ [FHD/24p/422/10-L]/[FHD/24p/420/8-L]	41m00s	1h25m	2h45m
[FHD/60i/422/10-L]	1h20m	2h50m	5h35m

[System Frequency]: [50.00Hz (PAL)]			
[Rec Quality]	Card capacity		
	32 GB	64 GB	128 GB
[4K-A/25p/422/10-I]/[C4K/25p/422/10-I]/ [4K/25p/422/10-I]	10m00s	21m00s	42m00s
[5.9K/25p/420/10-L]/[5.4K/25p/420/10-L]/ [4K-A/50p/420/10-L]/[C4K/50p/420/10-L]/ [4K/50p/420/10-L]/[FHD/50p/422/10-I]/ [FHD/25p/422/10-I]	20m00s	42m00s	1h20m
[4K-A/50p/420/8-L]/[4K-A/25p/422/10-L]/ [C4K/50p/420/8-L]/[C4K/25p/422/10-L]/ [4K/50p/420/8-L]/[4K/25p/422/10-L]/ [FHD/100p/420/10-L]	27m00s	56m00s	1h50m
[4K-A/25p/420/8-L]/[C4K/25p/420/8-L]/ [4K/25p/420/8-L]/[FHD/50p/422/10-L]/ [FHD/50p/420/8-L]/[FHD/50i/422/10-I]/ [FHD/25p/422/10-L]/[FHD/25p/420/8-L]	41m00s	1h25m	2h45m
[FHD/50i/422/10-L]	1h20m	2h50m	5h35m

[System Frequency]: [24.00Hz (CINEMA)]			
[Rec Quality]	Card capacity		
	32 GB	64 GB	128 GB
[4K-A/24p/422/10-I]/[C4K/24p/422/10-I]/ [4K/24p/422/10-I]	10m00s	21m00s	42m00s
[6K/24p/420/10-L]/[5.9K/24p/420/10-L]/ [4K-A/48p/420/10-L]/[C4K/48p/420/10-L]/ [4K/48p/420/10-L]/[FHD/24p/422/10-I]	20m00s	42m00s	1h20m
[4K-A/24p/422/10-L]/[C4K/24p/422/10-L]/ [4K/24p/422/10-L]	27m00s	56m00s	1h50m
[4K-A/24p/420/8-L]/[C4K/24p/420/8-L]/ [4K/24p/420/8-L]/[FHD/48p/420/10-L]/ [FHD/24p/422/10-L]/[FHD/24p/420/8-L]	41m00s	1h25m	2h45m









- The available recording time will be shorter depending on the card used when recording with [Loop Recording (video)] or [Segmented File Recording].
- Depending on the recording conditions and the type of card, number of still images that can be taken, video recording time vary.
- [9999+] is displayed on the recording screen and status LCD if the remaining number of still images that can be taken is 10000 or more.
- The continuous recordable time for videos is displayed on the screen.













List of Default Settings/Custom Saving/ Settings Available for Copying











: Using [Reset], the function to return to default settings





: Using [Save to Custom Mode], the function to save settings details in the Custom mode







: Using [Save/Restore Camera Setting], the function to copy settings details









Menu		Default setting			
 [Photo]:  [Image Quality]					
[Photo Style]		[ STD.]	✓	✓	✓
[Metering Mode]		[]	✓	✓	✓
[Aspect Ratio]		[3:2]	✓	✓	✓
[Picture Quality]		[FINE]	✓	✓	✓
[Picture Size]		[L] (24M)	✓	✓	✓
[HLG Photo]		[OFF]	✓	✓	✓
[High Resolution Mode]	[Start]	—			
	[Simul Record Normal Shot]	[ON]	✓	✓	✓
	[Shutter Delay]	[2 SEC]	✓	✓	✓
	[Motion Blur Processing]	[MODE1]	✓	✓	✓
[Long Exposure NR]		[ON]	✓	✓	✓
[Dual Native ISO Setting]		[AUTO]	✓	✓	✓
[ISO Sensitivity (photo)]	[ISO Auto Lower Limit Setting]	[100]	✓	✓	✓
	[ISO Auto Upper Limit Setting]	[AUTO]	✓	✓	✓
[Min. Shutter Speed]		[AUTO]	✓	✓	✓
[i.Dynamic Range]		[OFF]	✓	✓	✓
[Vignetting Comp.]		[ON]	✓	✓	✓
[Diffraction Compensation]		[OFF]	✓	✓	✓
[Filter Settings]	[Filter Effect]	[OFF]	✓	✓	✓
	[Simultaneous Record w/o Filter]	[OFF]	✓	✓	✓











Menu		Default setting			
 [Photo]:  [Focus]					
[AF Custom Setting(Photo)]		[Set 1]	✓	✓	✓
[AF Assist Light]		[ON]	✓	✓	✓
[Focus Peaking]	[ON]/[OFF]	[ON]	✓	✓	✓
	[SET]	—	✓	✓	✓
[1-Area AF Moving Speed]		[FAST]	✓	✓	✓
 [Photo]:  [Flash]					
[Flash Mode]		[]	✓	✓	✓
[Firing Mode]		[TTL]	✓	✓	✓
[Flash Adjust.]		[±0 EV]	✓	✓	✓
[Flash Synchro]		[1ST]	✓	✓	✓
[Manual Flash Adjust.]		[1/1]	✓	✓	✓
[Auto Exposure Comp.]		[OFF]	✓	✓	✓
[Red-Eye Removal]		[OFF]	✓	✓	✓
[Wireless]		[OFF]	✓	✓	✓
[Wireless Channel]		[1CH]	✓	✓	✓
[Wireless FP]		[OFF]	✓	✓	✓
[Communication Light]		[HIGH]	✓	✓	✓
[Wireless Setup]		—	✓	✓	✓
 [Photo]:  [Others (Photo)]					
[Bracketing]	[Bracketing Type]	[OFF]	✓	✓	✓
	[More Settings]	—	✓	✓	✓
[Silent Mode]		[OFF]	✓	✓	✓
[Image Stabilizer]	[Operation Mode]	[]	✓	✓	✓
	[Body(B.I.S.) / Lens(O.I.S.)]	[]	✓	✓	✓
	[When to Activate]	[HALF-SHUTTER]	✓	✓	✓
	[E-Stabilization (Video)]	[OFF]	✓	✓	✓
	[Boost I.S. (Video)]	[OFF]	✓	✓	✓
	[Anamorphic (Video)]	[OFF]	✓	✓	✓
[Lens Information]		[Lens1]	✓		✓













Menu		Default setting			
[Burst Shot 1 Setting]		[H]	✓	✓	✓
[Burst Shot 2 Setting]		[	✓	✓	✓
[Shutter Type]		[MECH.]	✓	✓	✓
[Shutter Delay]		[OFF]	✓	✓	✓
[Ex. Tele Conv.]		[OFF]	✓	✓	✓
[Time Lapse/ Animation]	[Mode]	[Time Lapse Shot]	✓	✓	✓
	[Shooting Interval Setting]	[ON]	✓	✓	✓
	[Start Time]	[Now]	✓	✓	✓
	[Image Count]	[1]	✓	✓	✓
	[Shooting Interval]	[1m00s]	✓	✓	✓
	[Exposure Leveling]	[OFF]	✓	✓	✓
[Self Timer]		[ 10]	✓	✓	✓
[Flicker Decrease (Photo)]		[OFF]	✓	✓	✓
[6K/4K PHOTO]	[Picture Size / Burst Speed]	[6K 18M]	✓	✓	✓
	[Rec Method]	[	✓	✓	✓
	[Pre-Burst Recording]	[OFF]	✓	✓	✓
[Post-Focus]		[OFF]	✓	✓	✓
[Multiple Exposure]	[Start]	—			
	[Auto Gain]	[ON]	✓	✓	✓
	[Overlay]	[OFF]	✓	✓	✓
[Time Stamp Rec.]		[OFF]	✓	✓	✓
 [Video]:  [Image Quality]					
[Exposure Mode]		[P]	✓	✓	✓
[Photo Style]		[ STD.]	✓	✓	✓
[Metering Mode]		[	✓	✓	✓
[Dual Native ISO Setting]		[AUTO]	✓	✓	✓
[ISO Sensitivity (video)]	[ISO Auto Lower Limit Setting]	[100]	✓	✓	✓
	[ISO Auto Upper Limit Setting]	[AUTO]	✓	✓	✓
[Synchro Scan]		[OFF]	✓	✓	✓













Menu		Default setting			
[Flicker Decrease (Video)]		[OFF]	✓	✓	✓
[Master Pedestal Level]		[0]	✓	✓	✓
[SS/Gain Operation]		[SEC/ISO]	✓	✓	✓
[i.Dynamic Range]		[OFF]	✓	✓	✓
[Vignetting Comp.]		[ON]	✓	✓	✓
[Diffraction Compensation]		[OFF]	✓	✓	✓
[Filter Settings]	[Filter Effect]	[OFF]	✓	✓	✓
	[Simultaneous Record w/o Filter]	[OFF]	✓	✓	✓
 [Video]:  [Image Format]					
[Rec. File Format]	When [System Frequency] is set to [59.94Hz (NTSC)] or [50.00Hz (PAL)]: [MP4]		✓	✓	✓
	When [System Frequency] is set to [24.00Hz (CINEMA)]: [MOV]				
[Image Area of Video]		[FULL]	✓	✓	✓
[Rec Quality]	When [System Frequency] is set to [59.94Hz (NTSC)]: [FHD/8bit/28M/60p]				
	When [System Frequency] is set to [50.00Hz (PAL)]: [FHD/8bit/28M/50p]		✓	✓	✓
	When [System Frequency] is set to [24.00Hz (CINEMA)]: [FHD/24p/420/8-L]				
[Rec Quality (My List)]		—	✓	✓	✓
[Variable Frame Rate]		[OFF]	✓	✓	✓





Menu		Default setting			
[Time Code]	[Time Code Display]	[OFF]	✓	✓	✓
	[Count Up]	[REC RUN]	✓	✓	✓
	[Time Code Value]	—			
	[Time Code Mode]	[DF]	✓	✓	✓
	[HDMI Time Code Output]	[OFF]	✓	✓	✓
	[External TC Setting]	—	✓	✓	✓
[Luminance Level]	[16-255]	✓	✓	✓	
 [Video]:  [Focus]					
[AF Custom Setting(Video)]	[ON]/[OFF]	[OFF]	✓	✓	✓
	[SET]	—	✓	✓	✓
[Continuous AF]		[MODE1]	✓	✓	✓
[AF Assist Light]		[ON]	✓	✓	✓
[Focus Peaking]	[ON]/[OFF]	[ON]	✓	✓	✓
	[SET]	—	✓	✓	✓
[1-Area AF Moving Speed]		[FAST]	✓	✓	✓
 [Video]:  [Audio]					
[Sound Rec Level Disp.]		[OFF]	✓	✓	✓
[Mute Sound Input]		[OFF]	✓	✓	✓
[Sound Rec Gain Level]		[STANDARD]	✓	✓	✓
[Sound Rec Level Adj.]		[0dB]	✓	✓	✓
[Sound Rec Level Limiter]		[ON]	✓	✓	✓
[Wind Noise Canceller]		[STANDARD]	✓	✓	✓
[Wind Cut]		[OFF]	✓	✓	✓
[Mic Socket]		[MIC \downarrow]	✓	✓	✓
[Special Mic.]		[STEREO]	✓	✓	✓
[XLR Mic Adaptor Setting]		[48kHz/16bit]	✓	✓	✓
[Sound Output]		[REALTIME]	✓	✓	✓
[Headphone Volume]		[LEVEL3]	✓		✓















Menu		Default setting			
 [Video]:  [Others (Video)]					
[Silent Mode]		[OFF]	✓	✓	✓
[Image Stabilizer]	[Operation Mode]	[]	✓	✓	✓
	[Body(B.I.S.) / Lens(O.I.S.)]	[]	✓	✓	✓
	[When to Activate]	[HALF-SHUTTER]	✓	✓	✓
	[E-Stabilization (Video)]	[OFF]	✓	✓	✓
	[Boost I.S. (Video)]	[OFF]	✓	✓	✓
	[Anamorphic (Video)]	[OFF]	✓	✓	✓
	[Lens Information]	[Lens1]	✓		✓
[Focus Transition]	[Start]	—			
	[Focus Pull Setting]	—			
	[Focus Transition Speed]	[M]	✓	✓	✓
	[Focus Transition Rec]	[OFF]	✓	✓	✓
	[Focus Transition Wait]	[OFF]	✓	✓	✓
[Loop Recording (video)]		[OFF]	✓	✓	✓
[Segmented File Recording]		[OFF]	✓	✓	✓
[Live Cropping]		[OFF]	✓	✓	✓
[Time Stamp Rec.]		[OFF]	✓	✓	✓
 [Custom]:  [Image Quality]					
[Photo Style Settings]	[Show/Hide Photo Style]	—	✓	✓	✓
	[My Photo Style Settings]	—	✓	✓	✓
	[Reset Photo Style]	—			
[ISO Increments]		[1/3 EV]	✓	✓	✓
[Extended ISO]		[OFF]	✓	✓	✓
[Exposure Offset Adjust.]	[Multi Metering]	[±0EV]	✓	✓	✓
	[Center Weighted]	[±0EV]	✓	✓	✓
	[Spot]	[±0EV]	✓	✓	✓
	[Highlight Weighted]	[±0EV]	✓	✓	✓













Menu		Default setting			
[Color Space]		[sRGB]	✓	✓	✓
[Exposure Comp. Reset]		[OFF]	✓		✓
[Auto Exposure in P/A/S/M]		[ON]	✓	✓	✓
[CreativeVideo Combined Set.]	[F/SS/ISO/Exposure Comp.]	[]	✓	✓	✓
	[White Balance]	[]	✓	✓	✓
	[Photo Style]	[]	✓	✓	✓
	[Metering Mode]	[]	✓	✓	✓
	[AF Mode]	[]	✓	✓	✓
 [Custom]: [AF] [Focus/Shutter]					
[Focus/Shutter Priority]	[AFS]	[FOCUS]	✓	✓	✓
	[AFC]	[BALANCE]	✓	✓	✓
[Focus Switching for Vert / Hor]		[OFF]	✓	✓	✓
[AF/AE Lock Hold]		[OFF]	✓	✓	✓
[AF+MF]		[OFF]	✓	✓	✓
[MF Assist]	[Focus Ring]	[ON]	✓	✓	✓
	[AF Mode]	[ON]	✓	✓	✓
	[Press Joystick]	[OFF]	✓	✓	✓
	[MF Assist Display]	[PIP]	✓	✓	✓
[MF Guide]		[]	✓	✓	✓
[Focus Ring Lock]		[OFF]	✓	✓	✓
[Show/Hide AF Mode]	[Face/Eye/Body/Animal Detect.]	[ON]	✓	✓	✓
	[Tracking]	[ON]	✓	✓	✓
	[225-Area]	[ON]	✓	✓	✓
	[Zone (Vert./ Horz.)]	[ON]	✓	✓	✓
	[Zone (Square)]	[OFF]	✓	✓	✓
	[Zone (Oval)]	[ON]	✓	✓	✓
	[1-Area+]	[ON]	✓	✓	✓
	[Pinpoint]	[ON]	✓	✓	✓
	[Custom1]	[OFF]	✓	✓	✓
	[Custom2]	[OFF]	✓	✓	✓
[Custom3]	[OFF]	✓	✓	✓	









Menu		Default setting			
[Pinpoint AF Setting]	[Pinpoint AF Time]	[MID]	✓	✓	✓
	[Pinpoint AF Display]	[PIP]	✓	✓	✓
[AF-Point Scope Setting]	[Keep Enlarged Display]	[OFF]	✓	✓	✓
	[PIP Display]	[PIP]	✓	✓	✓
[Shutter AF]		[ON]	✓	✓	✓
[Half-Press Shutter]		[OFF]	✓	✓	✓
[Quick AF]		[OFF]	✓	✓	✓
[Eye Sensor AF]		[OFF]	✓	✓	✓
[Looped Focus Frame]		[OFF]	✓	✓	✓
[AFC Start Point (225-Area)]		[OFF]	✓	✓	✓
 [Custom]:  [Operation]					
[Q.MENU Settings]	[Layout Style]	[MODE1]	✓	✓	✓
	[Front Dial Assignment]	[Value]	✓	✓	✓
	[Item Customize (Photo)]	—	✓	✓	✓
	[Item Customize (Video)]	—	✓	✓	✓
[Touch Settings]	[Touch Screen]	[ON]	✓	✓	✓
	[Touch Tab]	[OFF]	✓	✓	✓
	[Touch AF]	[AF]	✓	✓	✓
	[Touch Pad AF]	[OFF]	✓	✓	✓
[Lock Lever Setting]	[Cursor]	[	✓	✓	✓
	[Joystick]	[	✓	✓	✓
	[Touch Screen]	[	✓	✓	✓
	[Dial]	[	✓	✓	✓
[Fn Button Set]	[Setting in REC mode]	—	✓	✓	✓
	[Setting in PLAY mode]	—	✓	✓	✓
[WB/ISO/Expo. Button]		[AFTER PRESSING2]	✓	✓	✓
[ISO Displayed Setting]	[Front/Rear Dials]	[ / 	✓	✓	✓
	[Exposure Comp. Disp. Setting]	[OFF]	✓	✓	✓
[Exposure Comp. Disp. Setting]	[Cursor Buttons (Up/Down)]	[OFF]	✓	✓	✓
	[Front/Rear Dials]	[ / 	✓	✓	✓















Menu		Default setting			
[Dial Set.]	[Assign Dial (F/SS)]	[SET1]	✓	✓	✓
	[Rotation (F/SS)]	[ 	✓	✓	✓
	[Control Dial Assignment]	[	✓	✓	✓
	[Exposure Comp.]	[OFF]	✓	✓	✓
	[Dial Operation Switch Setup]	—	✓	✓	✓
	[Rotation (Menu Operation)]	[ 	✓	✓	✓
[Joystick Setting]	[D.FOCUS Movement]	✓	✓	✓	
[Illuminated Button]	[ON2]	✓	✓	✓	
[Video Rec. Button (Remote)]	[Video Record]	✓	✓	✓	
 [Custom]:  [Monitor / Display (Photo)]					
[Auto Review]	[Duration Time (photo)]	[OFF]	✓	✓	✓
	[Duration Time (6K/4K PHOTO)]	[HOLD]	✓	✓	✓
	[Duration Time (Post-Focus)]	[HOLD]	✓	✓	✓
	[Playback Operation Priority]	[OFF]	✓	✓	✓
[Constant Preview]	[ON]/[OFF]	[OFF]	✓	✓	✓
	[SET]	—	✓	✓	✓
[Histogram]		[OFF]	✓	✓	✓
[Photo Grid Line]		[OFF]	✓	✓	✓
[AF Area Display]		[ON]	✓	✓	✓
[Live View Boost]	[MODE1]/[MODE2]/[OFF]	[OFF]	✓	✓	✓
	[SET]	[M]	✓	✓	✓
[Night Mode]	[Monitor]	[OFF]	✓	✓	✓
	[LVF]	[OFF]	✓	✓	✓
[LVF/Monitor Disp. Set]	[LVF Disp. Set]	[	✓	✓	✓
	[Monitor Disp. Set]	[	✓	✓	✓

Menu		Default setting			
[Expo.Meter]		[OFF]	✓	✓	✓
[Focal Length]		[ON]	✓	✓	✓
[Blinking Highlights]		[OFF]	✓	✓	✓
[Sheer Overlay]	[ON]/[OFF]	[OFF]	✓		
	[SET]	—	✓		
[I.S. Status Scope]		[OFF]	✓	✓	✓
[Level Gauge]		[ON]	✓	✓	✓
[Luminance Spot Meter]		[OFF]	✓	✓	✓
[Framing Outline]		[OFF]	✓	✓	✓
[Show/Hide Monitor Layout]	[Control Panel]	[ON]	✓	✓	✓
	[Black Screen]	[ON]	✓	✓	✓
 [Custom]:  [Monitor / Display (Video)]					
[V-Log View Assist]	[Read LUT File]	—			
	[LUT Select]	[Vlog_709]	✓	✓	
	[LUT View Assist (Monitor)]	[OFF]	✓	✓	
	[LUT View Assist (HDMI)]	[OFF]	✓	✓	
[HLG View Assist]	[Monitor]	[MODE2]	✓	✓	✓
	[HDMI]	[AUTO]	✓	✓	✓
[Anamorphic Desqueeze Display]		[OFF]	✓	✓	✓
[Monochrome Live View]		[OFF]	✓	✓	✓
[Center Marker]		[OFF]	✓	✓	✓
[Video Frame Marker]	[ON]/[OFF]	[OFF]	✓	✓	✓
	[SET]	—	✓	✓	✓
[Zebra Pattern]	[ZEBRA1]/[ZEBRA2]/ [ZEBRA1+2]/[OFF]	[OFF]	✓	✓	✓
	[SET]	—	✓	✓	✓
[WFM/Vector Scope]		[OFF]	✓	✓	✓
[Color Bars]		—	✓	✓	✓
[Video-Priority Display]		[OFF]	✓	✓	✓
[Red REC Frame Indicator]		[OFF]	✓	✓	✓





Menu		Default setting			
 [Custom]:  [IN/OUT]					
[HDMI Rec Output]	[Info Display]	[ON]	✓	✓	✓
	[Down Convert]	[AUTO]	✓	✓	✓
	[HDMI Recording Control]	[OFF]	✓	✓	✓
	[Sound Down Convert]	[OFF]	✓	✓	✓
	[Sound Output (HDMI)]	[ON]	✓	✓	✓
[Fan Mode]	[AUTO1]	✓	✓	✓	
[Tally Lamp]	[FRONT/REAR]	✓	✓	✓	
 [Custom]:  [Lens / Others]					
[Lens Focus Resume]		[OFF]	✓	✓	✓
[Focus Ring Control]	[NON-LINEAR]/[LINEAR]	[NON-LINEAR]	✓	✓	✓
	[SET]	[150°]	✓	✓	✓
[Lens Information]		[Lens1]	✓		✓
[Lens Info. Confirmation]		[ON]	✓	✓	✓
 [Setup]:  [Card/File]					
[Card Format]		—			
[Double Card Slot Function]	[Recording Method]		✓		✓
	[Destination Card Slot]	 → 	✓		✓
[Folder / File Settings]	[Select Folder]	—			
	[Create a New Folder]	—			
	[File Name Setting]	[Folder Number Link]	✓		✓
[File Number Reset]		—			
[Copyright Information]	[Artist]	[OFF]	✓		✓
	[Copyright Holder]	[OFF]	✓		✓
	[Display Copyright Info.]	—			
 [Setup]:  [Monitor / Display]					
[Power Save Mode]	[Sleep Mode]	[5MIN.]	✓		✓
	[Sleep Mode(Wi-Fi)]	[ON]	✓		✓
	[Auto LVF/Monitor Off]	[5MIN.]	✓		✓
	[Power Save LVF Shooting]	—	✓		✓





Menu		Default setting			
[Monitor Frame Rate]		[60fps]	✓		✓
[LVF Frame Rate]		[60fps]	✓		✓
[Monitor Settings]/[Viewfinder]		—	✓		
[Monitor Backlight]/[LVF Luminance]		[AUTO]	✓		✓
[Remaining Battery Level]		[]	✓		✓
[Status-LCD]	[Character/Background Color]	[ A]	✓		✓
	[Backlight]	[H]	✓		✓
	[Display While Power Off]	[ON]	✓		✓
[Eye Sensor]	[Sensitivity]	[HIGH]	✓		✓
	[LVF/Monitor Switch]	[LVF/MON AUTO]	✓		✓
[Level Gauge Adjust.]	[Adjust.]	—	✓		
	[Level Gauge Value Reset]	—			
 [Setup]:  [IN/OUT]					
[Beep]	[Beep Volume]	[]	✓		✓
	[AF Beep Volume]	[]	✓		✓
	[AF Beep Tone]	[]	✓		✓
	[E-Shutter Vol]	[]	✓		✓
	[E-Shutter Tone]	[]	✓		✓
[Headphone Volume]		[LEVEL3]	✓		✓
[Wi-Fi]		—	✓		
[Bluetooth]		—	✓		
[USB]	[USB Mode]	[][Select on connection]	✓		✓
	[USB Power Supply]	[ON]	✓		✓
[Battery Information]		—			
[Battery Use Priority]		[BG]	✓		✓



Menu		Default setting			
[TV Connection]	[HDMI Mode (Playback)]	[AUTO]	✓		✓
	[LUT View Assist (HDMI)]	[OFF]	✓	✓	
	[HLG View Assist (HDMI)]	[AUTO]	✓	✓	✓
	[VIERA Link (CEC)]	[OFF]	✓		✓
	[Background Color(Playback)]	[	✓		✓
	[Photo Luminance Level]	[16-255]	✓		✓
[Card Access Light]	[ON]	✓		✓	
 [Setup]:  [Setting]					
[Save to Custom Mode]		—	✓		✓
[Load Custom Mode]		—	✓		✓
[Custom Mode Settings]	[Limit No. of Custom Mode]	[3]	✓		✓
	[Edit Title]	—	✓		✓
	[How to Reload Custom Mode]	—	✓		✓
	[Select Loading Details]	—	✓		✓
[Save/Restore Camera Setting]	[Save]	—			
	[Load]	—			
	[Delete]	—			
	[Keep Settings While Format]	[OFF]	✓		✓
[Reset]	—				
 [Setup]:  [Others]					
[Clock Set]		0:00:00 1/1/2019			
[Time Zone]		GMT – 5:00			✓
[System Frequency]		[59.94Hz (NTSC)]	✓		✓
[Pixel Refresh]		—			
[Sensor Cleaning]		—			
[Language]		—	✓		





Menu	Default setting			
[Firmware Version]	—			
[Online Manual]	—			
[Approved Regulations]	—			
 [My Menu]:  [Edit My Menu]				
[Add]	—	✓		✓
[Sorting]	—			
[Delete]	—			
[Display from My Menu]	[OFF]	✓		✓
 [Playback]:  [Playback Mode]				
[Playback Mode]	[Normal Play]	✓		✓
[Slide Show]	—	✓		✓
[Rotate Disp.]	[ON]	✓		✓
[Picture Sort]	[DATE/TIME]	✓		✓
[Magnify from AF Point]	[OFF]	✓		✓
[LUT View Assist (Monitor)]	[OFF]	✓	✓	
[HLG View Assist (Monitor)]	[MODE2]	✓	✓	✓
[Anamorphic Desqueeze Display]	[OFF]	✓	✓	✓
 [Playback]:  [Process Image]				
[RAW Processing]	—			
[6K/4K PHOTO Bulk Saving]	—			
[6K/4K PHOTO Noise Reduction]	[AUTO]	✓		✓
[Time Lapse Video]	—			
[Stop Motion Video]	—			
 [Playback]:  [Add/Delete Info.]				
[Protect]	—			
[Rating]	—			
 [Playback]:  [Edit Image]				
[Resize]	—			
[Rotate]	—			
[Video Divide]	—			
[Copy]	—			
 [Playback]:  [Others]				
[Delete Confirmation]	["No" first]	✓		✓





List of Functions That Can Be Set in Each Recording Mode

Menu		iA	P	A	S	M	
 [Photo]:  [Image Quality]							
[Photo Style]		✓	✓	✓	✓	✓	
[Metering Mode]			✓	✓	✓	✓	
[Aspect Ratio]		✓	✓	✓	✓	✓	
[Picture Quality]		✓	✓	✓	✓	✓	
[Picture Size]		✓	✓	✓	✓	✓	
[HLG Photo]			✓	✓	✓	✓	
[High Resolution Mode]	[Start]		✓	✓	✓	✓	
	[Simul Record Normal Shot]		✓	✓	✓	✓	
	[Shutter Delay]		✓	✓	✓	✓	
	[Motion Blur Processing]		✓	✓	✓	✓	
[Long Exposure NR]			✓	✓	✓	✓	
[Dual Native ISO Setting]			✓	✓	✓	✓	
[ISO Sensitivity (photo)]	[ISO Auto Lower Limit Setting]		✓	✓	✓	✓	
	[ISO Auto Upper Limit Setting]		✓	✓	✓	✓	
[Min. Shutter Speed]			✓	✓			
[i.Dynamic Range]			✓	✓	✓	✓	
[Vignetting Comp.]			✓	✓	✓	✓	
[Diffraction Compensation]			✓	✓	✓	✓	
[Filter Settings]	[Filter Effect]		✓	✓	✓	✓	
	[Simultaneous Record w/o Filter]		✓	✓	✓	✓	
 [Photo]:  [Focus]							
[AF Custom Setting(Photo)]			✓	✓	✓	✓	
[AF Assist Light]			✓	✓	✓	✓	

Menu		iA	P	A	S	M	
[Focus Peaking]	[ON]/[OFF]	✓	✓	✓	✓	✓	
	[SET]	✓	✓	✓	✓	✓	
[1-Area AF Moving Speed]		✓	✓	✓	✓	✓	
 [Photo]:  [Flash]							
[Flash Mode]		✓	✓	✓	✓	✓	
[Firing Mode]			✓	✓	✓	✓	
[Flash Adjust.]			✓	✓	✓	✓	
[Flash Synchro]			✓	✓	✓	✓	
[Manual Flash Adjust.]			✓	✓	✓	✓	
[Auto Exposure Comp.]			✓	✓	✓	✓	
[Red-Eye Removal]			✓	✓	✓	✓	
[Wireless]			✓	✓	✓	✓	
[Wireless Channel]			✓	✓	✓	✓	
[Wireless FP]			✓	✓	✓	✓	
[Communication Light]			✓	✓	✓	✓	
[Wireless Setup]			✓	✓	✓	✓	
 [Photo]:  [Others (Photo)]							
[Bracketing]	[Bracketing Type]	✓	✓	✓	✓	✓	
	[More Settings]	✓	✓	✓	✓	✓	
[Silent Mode]		✓	✓	✓	✓	✓	
[Image Stabilizer]	[Operation Mode]	✓	✓	✓	✓	✓	
	[Body(B.I.S.) / Lens(O.I.S.)]	✓	✓	✓	✓	✓	
	[When to Activate]	✓	✓	✓	✓	✓	
	[E-Stabilization (Video)]	✓	✓	✓	✓	✓	
	[Boost I.S. (Video)]	✓	✓	✓	✓	✓	
	[Anamorphic (Video)]	✓	✓	✓	✓	✓	
[Lens Information]		✓	✓	✓	✓	✓	

Menu		iA	P	A	S	M	
[Burst Shot 1 Setting]		✓	✓	✓	✓	✓	
[Burst Shot 2 Setting]		✓	✓	✓	✓	✓	
[Shutter Type]		✓	✓	✓	✓	✓	
[Shutter Delay]		✓	✓	✓	✓	✓	
[Ex. Tele Conv.]		✓	✓	✓	✓	✓	
[Time Lapse/Animation]		✓	✓	✓	✓	✓	
[Self Timer]		✓	✓	✓	✓	✓	
[Flicker Decrease (Photo)]		✓	✓	✓	✓	✓	
[6K/4K PHOTO]	[Picture Size / Burst Speed]	✓	✓	✓	✓	✓	
	[Rec Method]	✓	✓	✓	✓	✓	
	[Pre-Burst Recording]	✓	✓	✓	✓	✓	
[Post-Focus]		✓	✓	✓	✓	✓	
[Multiple Exposure]	[Start]		✓	✓	✓	✓	
	[Auto Gain]		✓	✓	✓	✓	
	[Overlay]		✓	✓	✓	✓	
[Time Stamp Rec.]		✓	✓	✓	✓	✓	
 [Video]:  [Image Quality]							
[Exposure Mode]							✓
[Photo Style]		✓	✓	✓	✓	✓	✓
[Metering Mode]			✓	✓	✓	✓	✓
[Dual Native ISO Setting]			✓	✓	✓	✓	✓
[ISO Sensitivity (video)]	[ISO Auto Lower Limit Setting]						✓
	[ISO Auto Upper Limit Setting]						✓
[Synchro Scan]							✓
[Flicker Decrease (Video)]			✓	✓	✓	✓	
[Master Pedestal Level]							✓
[SS/Gain Operation]							✓
[i.Dynamic Range]			✓	✓	✓	✓	✓

Menu		iA	P	A	S	M	
[Vignetting Comp.]			✓	✓	✓	✓	✓
[Diffraction Compensation]			✓	✓	✓	✓	✓
[Filter Settings]	[Filter Effect]		✓	✓	✓	✓	✓
	[Simultaneous Record w/o Filter]		✓	✓	✓	✓	
 [Video]:  [Image Format]							
[Rec. File Format]		✓	✓	✓	✓	✓	✓
[Image Area of Video]		✓	✓	✓	✓	✓	✓
[Rec Quality]		✓	✓	✓	✓	✓	✓
[Rec Quality (My List)]		✓	✓	✓	✓	✓	✓
[Variable Frame Rate]							✓
[Time Code]	[Time Code Display]	✓	✓	✓	✓	✓	✓
	[Count Up]	✓	✓	✓	✓	✓	✓
	[Time Code Value]	✓	✓	✓	✓	✓	✓
	[Time Code Mode]	✓	✓	✓	✓	✓	✓
	[HDMI Time Code Output]						✓
	[External TC Setting]						✓
[Luminance Level]		✓	✓	✓	✓	✓	✓
 [Video]:  [Focus]							
[AF Custom Setting(Video)]	[ON]/[OFF]	✓	✓	✓	✓	✓	✓
	[SET]	✓	✓	✓	✓	✓	✓
[Continuous AF]		✓	✓	✓	✓	✓	✓
[AF Assist Light]			✓	✓	✓	✓	✓
[Focus Peaking]	[ON]/[OFF]	✓	✓	✓	✓	✓	✓
	[SET]	✓	✓	✓	✓	✓	✓
[1-Area AF Moving Speed]		✓	✓	✓	✓	✓	✓

Menu		iA	P	A	S	M	
 [Video]:  [Audio]							
[Sound Rec Level Disp.]		✓	✓	✓	✓	✓	✓
[Mute Sound Input]		✓	✓	✓	✓	✓	✓
[Sound Rec Gain Level]		✓	✓	✓	✓	✓	✓
[Sound Rec Level Adj.]		✓	✓	✓	✓	✓	✓
[Sound Rec Level Limiter]		✓	✓	✓	✓	✓	✓
[Wind Noise Canceller]		✓	✓	✓	✓	✓	✓
[Wind Cut]		✓	✓	✓	✓	✓	✓
[Mic Socket]		✓	✓	✓	✓	✓	✓
[Special Mic.]		✓	✓	✓	✓	✓	✓
[XLR Mic Adaptor Setting]		✓	✓	✓	✓	✓	✓
[Sound Output]		✓	✓	✓	✓	✓	✓
[Headphone Volume]		✓	✓	✓	✓	✓	✓
 [Video]:  [Others (Video)]							
[Silent Mode]		✓	✓	✓	✓	✓	✓
[Image Stabilizer]	[Operation Mode]	✓	✓	✓	✓	✓	✓
	[Body(B.I.S.) / Lens(O.I.S.)]	✓	✓	✓	✓	✓	✓
	[When to Activate]	✓	✓	✓	✓	✓	
	[E-Stabilization (Video)]	✓	✓	✓	✓	✓	✓
	[Boost I.S. (Video)]	✓	✓	✓	✓	✓	✓
	[Anamorphic (Video)]	✓	✓	✓	✓	✓	✓
	[Lens Information]	✓	✓	✓	✓	✓	✓
[Focus Transition]							✓
[Loop Recording (video)]							✓
[Segmented File Recording]		✓	✓	✓	✓	✓	✓
[Live Cropping]							✓
[Time Stamp Rec.]		✓	✓	✓	✓	✓	✓

Specifications

The specifications are subject to change for performance enhancement.

Digital camera body (DC-S1H):

Information for your safety

Power source:	9.0 V===
Power consumption:	6.3 W (when recording with the monitor), 4.8 W (when playing back with the monitor) [When using the interchangeable lens (S-R24105)]

Type	
Type	Digital Single Lens Mirrorless camera
Recording media	SD memory card / SDHC memory card* / SDXC memory card* * Compliant with UHS-I/UHS-II UHS Speed Class 3, UHS-II Video Speed Class 90 Double slot recording function is available.
Lens mount	Leica Camera AG L-Mount
Image sensor	
Image sensor	35 mm full-frame (35.6 mm×23.8 mm) CMOS sensor, a total of 25,280,000 pixels, primary color filter
Effective number of pixels of the camera	24,200,000 pixels
Latitude	
	14+ stops ([V-Log])

Recording format for still images	
File format for still images	JPEG (DCF compliant, Exif 2.31 compliant) / RAW / HLG photo (CTA-2072 compliant)
File format for 6K/4K photos	6K photo: MP4 (H.265/HEVC, AAC (2ch)) 4K photo: MP4 (H.264/MPEG-4 AVC, AAC (2ch))
Picture size (pixels)	<p>When the aspect ratio setting is [4:3]</p> <p>[L]: 5328×4000 (3536×2656)* [M]: 3792×2848 (2560×1920)* [S]: 2688×2016 (1840×1376)* [High Resolution Mode]: 10656×8000 6K photo: 4992×3744 4K photo: 3328×2496 (3328×2496)* [HLG Photo] ([Full-Res.]): 5312×3984 [HLG Photo] ([4K-Res.]): 2880×2160 (2880×2160)*</p> <p>When the aspect ratio setting is [3:2]</p> <p>[L]: 6000×4000 (3888×2592)* [M]: 4272×2848 (2784×1856)* [S]: 3024×2016 (1968×1312)* [High Resolution Mode]: 12000×8000 6K photo: 5184×3456 4K photo: 3504×2336 (3504×2336)* [HLG Photo] ([Full-Res.]): 5984×4000 [HLG Photo] ([4K-Res.]): 3232×2160 (3232×2160)*</p> <p>When the aspect ratio setting is [16:9]</p> <p>[L]: 6000×3368 (4064×2288)* [M]: 4272×2400 (2816×1584)* [S]: 3024×1704 (1920×1080)* [High Resolution Mode]: 12000×6736 4K photo: 3840×2160 (3840×2160)* [HLG Photo] ([Full-Res.]): 5888×3312 [HLG Photo] ([4K-Res.]): 3840×2160 (3840×2160)*</p> <p>* Figures in parentheses are for Super 35 mm/APS-C lenses</p>

Picture size (pixels)	<p>When the aspect ratio setting is [1:1] [L]: 4000×4000 (2656×2656)* [M]: 2848×2848 (1920×1920)* [S]: 2016×2016 (1376×1376)* [High Resolution Mode]: 8000×8000 4K photo: 2880×2880 (2880×2880)* [HLG Photo] ([Full-Res.]): 4000×4000 [HLG Photo] ([4K-Res.]): 2144×2144 (2144×2144)*</p> <p>When the aspect ratio setting is [65:24] [L]: 6000×2208</p> <p>When the aspect ratio setting is [2:1] [L]: 6000×3000</p> <p>* Figures in parentheses are for Super 35 mm/APS-C lenses</p>	
Image quality for pictures	Fine / Standard / RAW+Fine / RAW+Standard / RAW	
Recording format for video		
Video format	AVCHD Progressive / AVCHD / MP4 (H.264/MPEG-4 AVC, H.265/HEVC) / MOV (H.264/MPEG-4 AVC, H.265/HEVC)	
Audio format	AVCHD	Dolby Audio (2ch)
	MP4	AAC (2ch)
	MOV	LPCM (2ch, 48 kHz/16-bit)* * When an XLR Microphone Adaptor (DMW-XLR1: optional) is attached, LPCM (2ch, 48 kHz/24-bit, 96 kHz/24-bit) can be selected
System frequency	59.94 Hz / 50.00 Hz / 24.00 Hz	
Image quality for video	Refer to page 255 in this document for information about resolution, recording frame rate, and other elements of recording quality.	

Viewfinder	
System	Aspect ratio 4:3, 0.5 inches, approx. 5,760,000 dots, organic EL (OLED) live view viewfinder
Field of view ratio	Approx. 100%
Magnification	Approx. $0.78\times$ (-1.0 m^{-1} 50 mm at infinity, with aspect ratio set to [3:2])
Eye point	Approx. 21 mm (at -1.0 m^{-1})
Diopter adjustment range	-4.0 to $+2.0$ diopter
Eye sensor	Yes
Monitor	
System	Aspect ratio 3:2, 3.2 inches, approx. 2,330,000 dots monitor, capacitive touch screen
Field of view ratio	Approx. 100%
Status LCD	
1.8 inches, 303×230 dots, black and white LCD monitor	
Focus	
AF type	TTL type based on image detection (Contrast AF)
Focus mode	AFS / AFC / MF
AF mode	Automatic detection (Face/Eye/Body/Animal) / Tracking / 225-Area / Zone (Vertical/Horizontal) / Zone (Square) / Zone (Oval) / 1-Area+Supplementary / 1-Area / Pinpoint / Custom1, 2, 3, Focus area selection is possible by touching or with the joystick

Exposure control		
Light metering system, Light metering mode	1728-zone metering, multi-metering / center-weighted metering / spot metering / highlight-weighted metering	
Metering range	EV 0 to EV 18 (F2.0 lens, ISO100 conversion)	
Exposure	Program AE (P) / Aperture-Priority AE (A) / Shutter-Priority AE (S) / Manual Exposure (M)	
Exposure compensation	1/3 EV steps, ± 5 EV	
ISO sensitivity (standard output sensitivity)	AUTO / 100 to 51200, When [Extended ISO] is set: AUTO / 50 to 204800, 1/3 EV steps	
Dual Native ISO setting	Auto	Base sensitivity: 100/640 (dB display values are based on 100) AUTO / 100 to 51200 When [Extended ISO] is set: AUTO / 50 to 204800
	Low sens.	Base sensitivity: 100 AUTO / 100 to 800 When [Extended ISO] is set: AUTO / 50 to 800
	High sens.	Base sensitivity: 640 AUTO / 640 to 51200 When [Extended ISO] is set: AUTO / 320 to 204800
Dual Native ISO setting (V-Log)	Auto	Base sensitivity: 640/4000 (dB display values are based on 640) AUTO / 640 to 51200 When [Extended ISO] is set: AUTO / 320 to 51200
	Low sens.	Base sensitivity: 640 AUTO / 640 to 5000 When [Extended ISO] is set: AUTO / 320 to 5000
	High sens.	Base sensitivity: 4000 AUTO / 4000 to 51200 When [Extended ISO] is set: AUTO / 2000 to 51200

Dual Native ISO setting (Cinelike D2/ Cinelike V2)	Auto	Base sensitivity: 200/1250 (dB display values are based on 200) AUTO / 200 to 51200 When [Extended ISO] is set: AUTO / 100 to 204800
	Low sens.	Base sensitivity: 200 AUTO / 200 to 1600 When [Extended ISO] is set: AUTO / 100 to 1600
	High sens.	Base sensitivity: 1250 AUTO / 1250 to 51200 When [Extended ISO] is set: AUTO / 640 to 204800
Dual Native ISO setting (HLG video/ HLG photo)	Auto	Base sensitivity: 400/2500 (dB display values are based on 400) AUTO / 400 to 51200 When [Extended ISO] is set: AUTO / 400 to 204800
	Low sens.	Base sensitivity: 400 AUTO / 400 to 3200
	High sens.	Base sensitivity: 2500 AUTO / 2500 to 51200 When [Extended ISO] is set: AUTO / 2500 to 204800
Image stabilizer		
Image stabilizer type	Compliant with Image sensor shift type, 5-axis stabilizer, Dual I.S.2	
Image stabilizer effect	In-body image stabilizer: 6.0 stops [Focal length f=50 mm, using an interchangeable lens (S-X50)] Dual I.S.2: 6.5 stops [Focal length f=105 mm, using an interchangeable lens (S-R24105)]* (Based on the CIPA standard, Yaw/Pitch direction) * Firmware version 1.1 or higher	
White balance		
White balance mode	AWB / AWBc / AWBw / Daylight / Cloudy / Shade / Incandescent lights / Flash / Set mode 1, 2, 3, 4 / Color temperature 1, 2, 3, 4	

Shutter		
Format	Focal-plane shutter	
Shutter speed	Pictures: Mechanical shutter: Bulb (max. approx. 30 minutes), 60 seconds to 1/8000 of a second Electronic front curtain: Bulb (max. approx. 30 minutes), 60 seconds to 1/2000 of a second Electronic shutter: Bulb (max. approx. 60 seconds), 60 seconds to 1/8000 of a second Videos: 1/25* of a second to 1/16000 of a second * When [Exposure Mode] is set to [M] in [Ⓜ] and focus mode is set to [MF], this can be set up to 1/2	
Burst recording		
Mechanical shutter/ Electronic front curtain	High speed	9 frames/second ([AFS], [MF]) / 6 frames/second ([AFC])
	Medium speed	5 frames/second
	Low speed	2 frames/second
Electronic shutter	High speed	9 frames/second ([AFS], [MF]) / 5 frames/second ([AFC])
	Medium speed	5 frames/second
	Low speed	2 frames/second
Maximum number of frames recordable	[FINE] / [STD.]: 999 frames or more [RAW+FINE] / [RAW+STD.] / [RAW]: 60 frames or more (When recording is performed under the test conditions specified by Panasonic)	
Minimum illumination		
Approx. 6 lx (system frequency 59.94 Hz, shutter speed 1/30 of a second)		
Approx. 6 lx (system frequency 50.00 Hz, shutter speed 1/25 of a second)		
[When using the interchangeable lens (S-R24105)]		

Flash (when using an external flash)	
Flash mode	Auto / Auto/Red-Eye / Forced Flash On / Forced On/Red-Eye / Slow Sync. / Slow Sync./Red-Eye / Forced Flash Off
Flash synchronization speed	Equal to or smaller than 1/320 of a second* * The guide number decreases at 1/320 of a second, only during [S]/[M] modes
Zoom	
Extended Tele Conversion (Picture)	Max. 2×* (when a picture size of [S] is selected.) * Max. 1.9× when using Super 35 mm/APS-C lenses
Display language	
[ENGLISH] / [DEUTSCH] / [FRANÇAIS] / [ITALIANO] / [ESPAÑOL] / [繁體中文] / [PORTUGUÊS] / [日本語]	
Microphone / Speaker	
Microphone	Stereo
Speaker	Monaural
Interface	
USB	USB Type-C™, SuperSpeed USB3.1 GEN1, Supports USB Power Delivery (9.0 V/3.0 A)
[HDMI]	HDMI Type A
[REMOTE]	∅ 2.5 mm jack
[MIC]	∅ 3.5 mm stereo mini jack, Mic Input (Plug-in Power) / Mic Input / Line Input (Operate the menu to switch between these inputs), Standard input level: –55 dBV (Mic Input) / –10 dBV (Line Input)
Headphones	∅ 3.5 mm stereo mini jack
Flash Synchro	Yes
TC IN/OUT	Yes (connect the BNC conversion cable (supplied) to the flash synchro socket) Input: 1.0 V to 4.0 V [p-p], 10 kΩ Output: 2.0 V ±0.5 V [p-p], low impedance
Splash Resistant	
Yes	

External dimensions / Mass	
External dimensions	Approx. 151.0 mm (W)×114.2 mm (H)×110.4 mm (D) (5.94" (W)×4.50" (H)×4.35" (D)) (excluding the projecting parts)
Mass (Weight)	Approx. 1164 g/2.57 lb (with one card and the battery) Approx. 1052 g/2.32 lb (only camera body)
Operating environment	
Recommended operating temperature	–10 °C to 40 °C (14 °F to 104 °F) <ul style="list-style-type: none">• Battery performance temporarily worsens at low temperatures (–10 °C to 0 °C (14 °F to 32 °F)), reducing the number of pictures that can be taken and the available recording time.
Permissible relative humidity	10%RH to 80%RH

Index

Numerics

1 Shot "6K/4K PHOTO"	372
1 Shot RAW+JPG	371
1 Shot Spot Metering	371
1-Area (AF)	113
1-Area AF Moving Speed	403
1-Area+ (AF)	113
225-Area (AF)	110
6K/4K Burst	137
6K/4K Burst (S/S)	138
6K/4K burst file	142
6K/4K PHOTO	136, 407
6K/4K PHOTO Bulk Saving	148, 459
6K/4K PHOTO Noise Reduction	144, 459
6K/4K Photo Play	374
6K/4K Pre-Burst	138

A

AC adaptor	541, 574
AF	97
AF Area Display	433
AF Assist Light	401
AF Custom Setting (Photo)	101, 401
AF Custom Setting (Video)	277, 413
AF mode	103
AF ON	98, 125
AF/AE Lock	199
AF/AE Lock Hold	421
AF+AE	120
AF+MF	421
AFC	96
AFC Start Point (225-Area)	110, 425
AF-Point Scope	100
AF-Point Scope Setting	424
AFS	96

Anamorphic (Video)	182, 405
Anamorphic Desqueeze Display	316, 440, 458
Anamorphic recording	315
Android	468
Aperture Bracket	163
Aperture-Priority AE mode	188
Approved Regulations	455
Aspect Ratio	87, 396
Auto Clock Set	449, 490
Auto Exposure Comp	237, 403
Auto Exposure in P/A/S/M	243, 420
Auto focus	97
Auto LVF/Monitor Off	46, 445
Auto Review	430
Auto Transfer	449, 486
Auto White Balance	205
Automatic scene detection	82
Available recording time	579
Available recording time (for video recording)	583
AVCHD	255, 412
AVCHD Progressive	256

B

Backlight compensation	82
Battery	36, 39, 573
Battery Grip	539
Battery Information	450
Battery Use Priority	450, 539
Beep	448
Blinking Highlights	436
Bluetooth	449, 469
Boost I.S. (Video)	182, 405
Bracketing	160, 405
Bulb	195, 482

-
- Burst rate 133
Burst Shot 132
Burst Shot 1 Setting 132, 136, 405
Burst Shot 2 Setting 132, 136, 405
- C**
-
- Cable holder 330
Calendar screen 355
Card 25, 48, 92, 574
Card Access Light 49, 452
Card Format 50, 444
Card Slot Change 348, 374, 381
Center Marker 440
Center-weighted metering 185
Charge 36
Cleaning 571
Clock Set 56, 454
Cloud Limit 515
Cloud sync service 506
Color Bars 296, 441
Color Space 420, 528
Color Tone 213
Communication Light 241, 404
Compression rate 90, 396
Condensation 20
Constant Preview 431
Continuous AF 275, 413
Continuous available recording
time 580
Contrast 213
Control dial 65
Control panel 70, 75, 546
Copy 462
Copyright Information 444
Creating a picture from a video 351
Creative Video Combined
Set 252, 420
Creative Video mode 247
Custom (AF) 116
Custom menu 418
Custom mode 383
Custom Mode Settings 384, 453
- D**
-
- DC Coupler 541
DCF standard 348
Delete 357
Delete Confirmation 463
Delete Location Data 515
Delete Single 357
Destination Card Slot 92, 373
Device Name 517
Dial Operation Switch Setup 376, 429
Dial Setting 428
Diffraction Compensation 400
Diopter adjustment 68
Double Card Slot Function 92, 444
Down Convert 335, 442
Drive mode 131
Dual Native ISO Setting 203, 397
Dust reduction function 571
- E**
-
- Electronic front curtain 175, 405
Electronic shutter 175, 405
Enlarged display 352
Entering characters 464
E-Stabilization (Video) 179, 405
Exposure Bracket 163
Exposure compensation 197
Exposure Compensation Display
Setting 427
Exposure Compensation Reset 420
Exposure Meter 436

-
- Exposure Mode 249, 410
- Exposure Offset Adjustment..... 419
- Extended ISO 419
- Extended Tele Conversion 128, 406
- External flash..... 228
- External microphone..... 340
- External monitor/external recorder 329
- External TC Setting 269
- Eye cup..... 572
- Eye Sensor..... 447
- Eye Sensor AF 424
- F**
-
- Face/Eye/Body/Animal Detect..... 83, 105
- Fan inlet..... 59
- Fan Mode 442
- Fan outlet..... 59
- File number..... 93, 528, 550, 552
- File Number Reset..... 95, 444
- Filter Effect 216, 401
- Filter Settings..... 216, 401
- Firing Mode..... 234, 403
- Firmware update..... 19, 455
- Firmware Version 455
- Flash..... 228
- Flash Adjust..... 235, 403
- Flash Mode..... 231, 403
- Flash Synchro..... 236, 403
- Flash synchro socket..... 229
- Flicker Decrease (Photo)..... 407
- Flicker Decrease (Video)..... 411
- Fn button 367, 368
- Fn Button Set..... 369, 426
- Focal Length..... 436
- Focus..... 97, 275
- Focus Area Set..... 371
- Focus Bracket..... 164
- Focus mode..... 96
- Focus Peaking..... 402
- Focus Ring Control..... 443
- Focus Ring Lock..... 422
- Focus Stacking 171
- Focus Switching for Vert/Hor 122, 421
- Focus Transition 301, 416
- Focus/Shutter Priority 421
- Folder number 93, 95, 528, 550, 552
- Folder/File Settings..... 93, 444
- Forced Flash Off..... 231
- Framing Outline 439
- Front dial..... 65
- G**
-
- Gain 286
- Gamma setting (Photo Style)..... 210, 396
- Group image..... 356
- H**
-
- Half-Press Shutter 424
- HDAVI Control™ 525
- HDMI cable 329, 522, 524, 526
- HDMI Mode (Playback)..... 451
- HDMI output..... 329
- HDMI Rec Output 335, 338, 442
- HDMI Recording Control..... 338, 442
- HDMI socket 329, 522
- Headphone socket..... 345
- Headphone Volume 346, 415, 448
- High frame rate video 300
- High Resolution Mode 222, 397
- Highlight..... 213
- Highlight-weighted metering 185
- Histogram 432
- HLG Photo..... 226, 396
- HLG video..... 312

-
- HLG View Assist 314, 439
HLG View Assist (Monitor)..... 458
Hot shoe cover 228
Hue 213
- I**
-
- i.Dynamic Range 399
I.S. Status Scope 437
Illuminated Button 429
Image Area of Video 266, 412
Image Quality 213
Image Stabilizer 177, 405
Info Display (During HDMI
Output) 338, 442
Intelligent Auto mode 81
iOS 468
ISO Displayed Setting 427
ISO Increments 418
ISO sensitivity 200
ISO Sensitivity (photo) 398
ISO Sensitivity (video)..... 282, 410
- J**
-
- Joystick 66
Joystick Setting 429
- K**
-
- Knee 280
- L**
-
- Lens 23, 51
Lens Focus Resume 443
Lens Info. Confirmation 443
Lens Information 183, 405, 443
Level Gauge 438
Level Gauge Adjustment 448
Live Cropping 304, 416
Live View Boost 434
Load Custom Mode 386, 453
Location Logging 449, 488
Lock Lever Setting 426
Log recording 308
Long Exposure NR 397
Loop Recording (video) 320, 416
Looped Focus Frame 425
Low illumination AF 98
Luminance Level 278, 412
Luminance Spot Meter 292, 439
LUMIX CLUB 518
LUMIX Sync 468
LUMIX Tether 533
LUT View Assist 310, 439
LUT View Assist (Monitor)..... 458
LVF Frame Rate 445
LVF Luminance 446
LVF/Monitor Display Set 435
LVF/Monitor Display Style 372
LVF/Monitor Switch 447
- M**
-
- Magnify from AF Point 458
Manual Exposure mode 193
Manual Flash Adjust 234, 240, 403
Manual focus 123
Master Pedestal Level 279, 411
Mechanical shutter 175, 405
Metering Mode 185, 396
MF 123
MF Assist 422
MF Assist Display 422
MF Guide 422
Mic Socket 340, 414
Minimum Shutter Speed 398
Monitor 54, 542
Monitor Backlight 446

-
- Monitor Frame Rate 445
- Monitor Settings 446
- Monochrome Live View 440
- MOV 255, 412
- MP4 255, 412
- Multi-metering 185
- Multiple Exposure 408
- Mute Sound Input 283, 413
- My Menu 387
- N**
-
- Network Address 518
- Night Mode 435
- Noise Reduction 214
- Number of pictures that can be taken 579
- Number of pictures that can be taken continuously 134
- Number of prints 537
- Number of still images that can be taken 582
- O**
-
- One Push AE 371
- Online Manual 455
- Operation lock lever 67
- Optical zoom 127
- P**
-
- Page Layout 537
- Paper Size 537
- PC connection 499, 517, 527, 533
- Photo Grid Line 433
- Photo menu 396
- Photo Style 210, 396
- Photo Style Settings 418
- PHOTOfunSTUDIO 530
- PictBridge 535
- Picture Quality 90, 396
- Picture Size 88, 396
- Picture Sort 457
- Pinpoint (AF) 114
- Pinpoint AF Setting 423
- Pixel Refresh 454
- Play back 347
- Play back picture 347
- Play back video 349
- Playback menu 456
- Playback Mode 457
- Post-Focus 166, 408
- Post-Recording Refinement 143
- Power Save LVF Shooting 46, 445
- Power Save Mode 46, 445
- Pre-Burst Recording 140, 407
- Preview 196
- Print 502, 535
- Print with Date 537
- Program AE mode 186
- Program Shift 187
- Protect 460
- Q**
-
- Q.Menu Settings 378, 425
- Quick AF 424
- Quick menu 73, 378
- R**
-
- Rating 460
- RAW 90
- RAW Processing 359, 459
- Rear dial 65
- Rec Quality 255, 412
- Rec Quality (My List) 265, 412
- Rec. File Format 255, 412
- Rec/Playback Switch 372, 374

- Recording distance reference 126
- Recording mode 63
- Recording videos 242
- Recording with Time Lapse Shot 149
- Red REC Frame Indicator 441
- Red-Eye Removal 233, 404
- Reduce Rolling Shutter 143
- Register to Favorite (Wi-Fi connection) 513
- Registering to My List 265
- Remaining Battery Level 446
- Remote shooting 480
- Remote Wakeup 449, 489
- Reset 80, 453
- Resize 461
- Restore to default 373, 374
- Returning from Sleep Mode 449, 482
- Rotate 461
- Rotate Display 457
- S**
- Saturation 213
- Save to Custom Mode 383, 453
- Save/Restore Camera
- Setting 389, 453
- SD Speed Class 26
- Segmented File Recording 322, 416
- Self-timer 158, 406
- Send Image (Smartphone) 449, 496, 498
- Sending file format 515
- Sending size 515
- Sensor Cleaning 454
- Setup menu 444
- Shadow 213
- Sharpness 214
- Sheer Overlay 437
- Shoulder strap 34
- Show/Hide AF Mode 423
- Show/Hide Monitor Layout 439
- Shutter AF 424
- Shutter Delay 406
- Shutter Remote Control 481, 540
- Shutter Type 175, 405
- Shutter-Priority AE mode 191
- Silent Mode 174, 405
- Simultaneous Record w/o Filter 221, 401
- Sleep Mode 46, 445
- Sleep Mode (Wi-Fi) 46, 445
- Slide show 457
- Sound Down Convert 339, 442
- Sound Output 345, 414
- Sound Output (HDMI) 339, 442
- Sound Rec Gain Level 284, 414
- Sound Rec Level Adj. 284, 414
- Sound Rec Level Disp. 283, 413
- Sound Rec Level Limiter 285, 414
- Special Mic 341, 414
- Spot metering 185
- SS/Gain Operation 286, 411
- Starlight AF 98
- Status LCD 33, 248, 447
- Status LCD backlight 72, 447
- Stereo Shotgun Microphone 340, 414
- Stop Motion Animation 153, 406
- Stop Motion Video 459
- Storage (recorder) 532
- Sub video rec. button 62, 242
- Supplying power 43
- Synchro Scan 318, 410
- System Frequency 253, 454

T

Tally Lamp	242, 442
Tethered Recording	533
Thumbnail screen	354
Time Code	268, 412
Time Lapse Shot	149, 406
Time Lapse Video	459
Time Stamp Rec	409
Time Zone	454
Touch AE	85
Touch AF	84, 120, 425
Touch Pad AF	121, 425
Touch screen	66
Touch Settings	425
Touch Shutter	84
Touch Tab	425
Touch Zoom	129
Tracking (AF)	83, 108
Tripod	576
TTL	234, 235, 403
TV Connection	451, 452
TV playback	524

U

UHS Speed Class	26
USB	449
USB connection cable	37, 41, 43, 522, 528, 529, 532, 534, 535
USB Mode	449
USB PD (USB Power Delivery)	43
USB port	41, 522
USB Power Supply	449

V

V.MODE button	68
Variable Frame Rate	297, 412
Vertical orientation detection function	60

Video Divide	364, 461
Video Frame Marker	295, 440
Video menu	410
Video rec. button	62, 242
Video Rec. Button (Remote)	430, 541
Video Speed Class	26
Video-Priority Display	441
VIERA Link (CEC)	452, 525
Viewfinder	68, 446, 542
Vignetting Compensation	400
V-Log	308
V-Log View Assist	310, 439

W

WB/ISO/Exposure Button	427
Web service	504
WFM/Vector Scope	288, 441
White balance	204
White balance adjustment	208
White Balance Bracket	165
White Balance Bracket (Color Temperature)	165
Wi-Fi	448, 465
Wi-Fi Function	448, 465
Wi-Fi Function Lock	518
Wi-Fi network settings	449
Wi-Fi Password	517
Wi-Fi Setup menu	448, 517
Wind Cut	342, 414
Wind Noise Canceller	285, 414
Wireless	239, 404
Wireless Channel	239, 404
Wireless flash	238
Wireless FP	241, 404
Wireless printing	502
Wireless Setup	240, 404
WPS	508, 512

X

XLR Mic Adaptor Setting..... 343, 414

XLR Microphone Adaptor..... 343

Z

Zebra Pattern..... 293, 440

Zone (AF)..... 111

Zoom..... 127

Trademarks and Licences



- L-Mount is a trademark or registered trademark of Leica Camera AG.
- SDXC Logo is a trademark of SD-3C, LLC.
- The terms HDMI and HDMI High-Definition Multimedia Interface, and the HDMI Logo are trademarks or registered trademarks of HDMI Licensing Administrator, Inc. in the United States and other countries.
- USB Type-C™ and USB-C™ are trademarks of USB Implementers Forum.
- The USB Type-C™ Charging Trident Logos are trademarks of USB Implementers Forum, Inc.
- The SuperSpeed USB Trident Logo is a registered trademark of USB Implementers Forum, Inc.
- “AVCHD”, “AVCHD Progressive” and the “AVCHD Progressive” logo are trademarks of Panasonic Corporation and Sony Corporation.
- QuickTime and the QuickTime logo are trademarks or registered trademarks of Apple Inc., used under license therefrom.
- Manufactured under license from Dolby Laboratories. Dolby, Dolby Audio, and the double-D symbol are trademarks of Dolby Laboratories.
- HDAVI Control™ is a trademark of Panasonic Corporation.
- Adobe is a trademark or registered trademark of Adobe Systems Incorporated in the United States and/or other countries.
- Pentium is a trademark of Intel Corporation in the U.S. and/or other countries.
- Windows is a registered trademark or trademark of Microsoft Corporation in the United States and/or other countries.



- Final Cut Pro, Mac, OS X and macOS are trademarks of Apple Inc., registered in the U.S. and other countries.
- App Store is a service mark of Apple Inc.
- Google, Android and Google Play are trademarks of Google LLC.
- The Bluetooth® word mark and logos are registered trademarks owned by Bluetooth SIG, Inc. and any use of such marks by Panasonic Corporation is under license. Other trademarks and trade names are those of their respective owners.
- The Wi-Fi CERTIFIED™ Logo is a certification mark of Wi-Fi Alliance®.
- The Wi-Fi Protected Setup™ Logo is a certification mark of Wi-Fi Alliance®.
- "Wi-Fi®" is a registered trademarks of Wi-Fi Alliance®.
- "Wi-Fi Protected Setup™", "WPA™", and "WPA2™" are trademarks of Wi-Fi Alliance®.
- This product uses "DynaFont" from DynaComware Corporation. DynaFont is a registered trademark of DynaComware Taiwan Inc.
- QR Code is a registered trademark of DENSO WAVE INCORPORATED.
- Other names of systems and products mentioned in these instructions are usually the registered trademarks or trademarks of the manufacturers who developed the system or product concerned.

This product is licensed under the AVC Patent Portfolio License for the personal use of a consumer or other uses in which it does not receive remuneration to (i) encode video in compliance with the AVC Standard ("AVC Video") and/or (ii) decode AVC Video that was encoded by a consumer engaged in a personal activity and/or was obtained from a video provider licensed to provide AVC Video. No license is granted or shall be implied for any other use. Additional information may be obtained from MPEG LA, L.L.C.

See <http://www.mpegla.com>

Firmware Update

LUMIX

S1H

❖ Firmware Has Been Updated

A firmware update has been made available to improve camera capabilities and to add functionality.

The subsequent sections describe functions that have been added or modified. Also refer to the “Owner’s Manual”.

- To check the firmware version of the camera, select [Firmware Version] in the [Setup] ([Others]) menu.
- For the latest information on the firmware or to download/update the firmware, visit the following support site:

<https://panasonic.jp/support/global/cs/dsc/>

(English only)



Click here to move to the cover page of the “Owner’s Manual”.

Contents

Before Use	F-4
About Applications/Software	F-4
Firmware Ver. 2.0/2.1	F-5
Support for Output of RAW Video Data	F-5
Outputting RAW Video Data via HDMI	F-6
Notes When Outputting RAW Video Data	F-11
Additions/Changes to Video Functions	F-12
Support for Output via HDMI During Recording of 6K/5.9K/5.4K Video	F-12
[Assign REC to Shutter Button] Has Been Added	F-12
Support for Settings with [Rec Quality (My List)] in the Control Panel	F-13
Changes to the [Noise Reduction] Adjustment Range When Using [V-Log]	F-13
[HDMI MF Assist Output] Has Been Added to [HDMI Rec Output]	F-14
Improved Ease of Operation	F-15
Changes to How All Images Are Deleted	F-15
Changes to the AF Function	F-16
Support for [AF+MF] in AFC	F-16
Improved Compatibility with Interchangeable Lenses	F-16
[Lens Fn Button Setting] Has Been Added	F-16
Changes to the Operation of the Image Stabilizer When Using Other Manufacturer's Lenses	F-17
Additions/Changes to Other Functions	F-18
[Backlight Illumination Period] Has Been Added to [Status-LCD] ..	F-18
[Destination Card Slot] Has Been Added to the [RAW Processing] Setting Items	F-19
[0.5SEC] Has Been Added to the [Duration Time (photo)] of [Auto Review]	F-19
[Off (Disable Press and Hold)] Has Been Added to [Fn Button Set]	F-20
[Preview Aperture Effect] Has Been Added to [Fn Button Set]	F-21

Support for Aperture/Shutter Speed Operations When Monitor is Off.....	F-21
Added Menus	F-22

Firmware Ver. 2.2

F-24

Additions/Changes to AF Functions	F-24
Improved Automatic Detection AF Performance.....	F-24
Automatic Detection AF Has Been Added to [1-Area+]/[1-Area] ...	F-25
Support for the [AF+MF] Function During Recording of Video	F-26
Additions/Changes to Video Functions.....	F-27
Support for Vertical Playback of Video	F-27
Additions/Changes to Other Functions	F-28
Support for Transfer of 4K Video Files to Smartphones	F-28
[Horizontal Image Flip(Monitor)] and [Vertical Image Flip(Monitor)] Have Been Added to [LVF/Monitor Disp. Set].....	F-28
Added Menus	F-29

Firmware Ver. 2.4

F-30

Models Supporting Output of RAW Video Data Have Been Added	F-30
[Vertical Position Info (Video)] Has Been Added	F-31
Support for the [Power Save Mode] When Using an AC Adaptor	F-31
Added Menus	F-32

Before Use

About Applications/Software

When you have updated the firmware for the camera, use the latest version of the application for your smartphone or the software for your PC.

“LUMIX Sync”

- Install or update the application on your smartphone.
-

“PHOTOfunSTUDIO 10.1 PE”

- Check the following site and then download and install the software:

<If already using>

https://panasonic.jp/support/global/cs/soft/download/d_pfs101pe_up.html
(English only)

<If installing for the first time>

https://panasonic.jp/support/global/cs/soft/download/d_pfs101pe.html
(English only)

“LUMIX Tether”

- Check the following site and then download and install the software:

https://panasonic.jp/support/global/cs/soft/download/d_lumixtether.html
(English only)

Firmware Ver. 2.0/2.1

Support for Output of RAW Video Data (Firmware Ver. 2.1)

iA P A S M 



12-bit RAW Video Data with a maximum resolution of 5.9K can now be output via HDMI to a compatible external recorder.

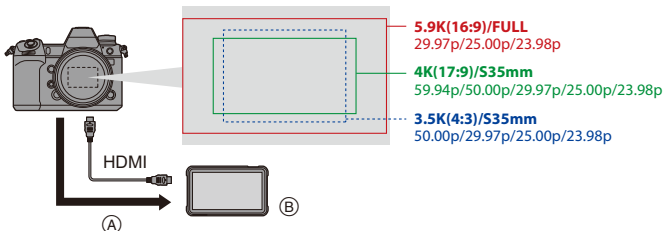

Ⓐ RAW Video

Ⓑ External recorder

- Recording of the RAW Video Data of this camera has been confirmed on the following external recorder. (As of July 2020)
 - ATOMOS Ninja V 4K HDR Monitor-Recorder (AtomOS 10.52 or higher)
For details, please contact ATOMOS.
- This does not guarantee all of the capabilities that the compatible external recorder may have.
- You will need compatible software to edit the RAW Video Data recorded with the external recorder. To change the coloring according to V-Log/V-Gamut when editing, download a LUT (Look-Up Table) from the support site below and load it into the software.
- Visit the following site to download LUT data or view the latest support information:
<https://panasonic.jp/support/global/cs/dsc/>
(English only)



- Video cannot be recorded to cards while RAW Video Data is being output via HDMI.
- When [System Frequency] is set to [24.00Hz (CINEMA)], RAW Video Data cannot be output via HDMI.

Outputting RAW Video Data via HDMI

[HDMI RAW Data Output] has been added to the [Video] menu. The image quality for the output images is set in [Rec Quality].

Getting started:

- 1 Turn off the camera and the external recorder.
- 2 Connect the camera and the external recorder with a commercially available HDMI cable.
 - Use a “High Speed HDMI cable” with the HDMI logo. Cables that do not comply with the HDMI standards will not work. “High Speed HDMI cable” (Type A–Type A plug, up to 1.5 m (4.9 feet) long)
- 3 Turn on the camera and the external recorder.

1 Set the mode dial to [CAM].

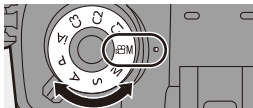

2 Set [HDMI RAW Data Output].

- → → → [HDMI RAW Data Output] → [ON]
- [HDMI RAW] is displayed on the recording screen.

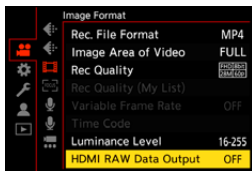

3 Select [Rec Quality].

-  →  →  → [Rec Quality]

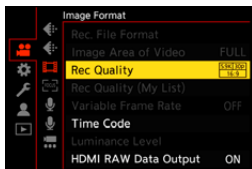

4 Set the HDMI input on the external recorder.

- When the connection is complete, images will be displayed on the screen of the external recorder.



There are differences from normal HDMI output operation.

- [HDMI Rec Output] in the [Custom] ([IN/OUT]) menu.
 - [Info Display] is not available. You cannot output the camera information display to an external recorder connected by HDMI.
 - [Down Convert] is not available. Outputs at the resolution and recording frame rate of the [Rec Quality].

❖ [Rec Quality] (When [HDMI RAW Data Output] is selected)

[Rec Quality]	[System Frequency]	[Image Area of Video]	Resolution	Frame rate
[5.9K/30p/16:9]	[59.94Hz(NTSC)]	[FULL]	5888×3312	29.97p
[5.9K/24p/16:9]		[FULL]	5888×3312	23.98p
[4K/60p/17:9]		[S35mm]	4128×2176	59.94p
[4K/30p/17:9]		[S35mm]	4128×2176	29.97p
[4K/24p/17:9]		[S35mm]	4128×2176	23.98p
[3.5K/30p/4:3]*		[S35mm]	3536×2656	29.97p
[3.5K/24p/4:3]*		[S35mm]	3536×2656	23.98p
[5.9K/25p/16:9]	[50.00Hz(PAL)]	[FULL]	5888×3312	25.00p
[4K/50p/17:9]		[S35mm]	4128×2176	50.00p
[4K/25p/17:9]		[S35mm]	4128×2176	25.00p
[3.5K/50p/4:3]*		[S35mm]	3536×2656	50.00p
[3.5K/25p/4:3]*		[S35mm]	3536×2656	25.00p

* Anamorphic (4:3) video

- Bit value: 12-bit
- Audio format: LPCM (2ch)
- [Image Area of Video] is fixed to the image area according to the [Rec Quality] setting.
- When the XLR Microphone Adaptor (DMW-XLR1: optional) is attached, [XLR Mic Adaptor Setting] can be set to [96kHz/24bit] or [48kHz/24bit].

❖ Monitor/Viewfinder Display When Outputting RAW Video Data

Images equivalent to those recorded when recording with V-Log are displayed on the monitor/viewfinder of the camera for monitoring purposes. [LUT View Assist (Monitor)] with the [Vlog_709] preset applied can be used for the [V-Log View Assist].

- The LUT for the monitor display cannot be change.
- When you use [LUT View Assist (Monitor)], [709] is displayed on the screen and [RAW] is displayed on the screen as a [LUT View Assist (HDMI)] item.
- [Luminance Spot Meter], and [BASE/RANGE] of [Zebra Pattern] are set at "Stop" units.
(Calculated as "0 Stop"=42 % (IRE))

Notes on displayed images



- The images displayed on the camera do not affect the RAW Video Data that is output.
- The images displayed on the external recorder are images that suit the external recorder specifications. This means that there may be differences between the images displayed on the camera and the images displayed on the external recorder.
- The monitor/viewfinder of the camera shows images with the angle of view of the RAW Video Data. There may be some difference with the angle of view of the data recorded on the external recorder.

❖ [HDMI Time Code Output]/[HDMI Recording Control]



The time code of the camera can be added and output via HDMI to the external recorder.

In addition, recording can be started and stopped on the external recorder by using the video rec. button and shutter button of the camera.

❶ Set [HDMI Time Code Output] to [ON].

-  ⇒  ⇒  ⇒ [Time Code] ⇒ [HDMI Time Code Output] ⇒ [ON]

❷ Set [HDMI Recording Control] to [ON].

-  ⇒  ⇒  ⇒ [HDMI Rec Output] ⇒ [HDMI Recording Control] ⇒ [ON]
- [HDMI Recording Control] can be set when [HDMI Time Code Output] is set to [ON] in [p^{CO}M] mode.

Notes When Outputting RAW Video Data

Operation is as follows when outputting RAW Video Data:

- The lower limit of available ISO sensitivity is [640] (when [Extended ISO] is set: [320]), and the upper limit is [51200].
The range of available ISO sensitivities is also different for [LOW] and [HIGH] in [Dual Native ISO Setting].
- [AWB], [AWBc], [AWBw] and [$\frac{1}{4}$ WB] cannot be used for white balance.
- [Photo Style] is fixed to [V-Log], and Image quality cannot be adjusted.
- [+] of the AF mode is not available.
- Enlarging the display with MF Assist is not possible.
- The following functions are not available:
 - [Master Pedestal Level]
 - [i.Dynamic Range]
 - [Vignetting Comp.]
 - [Diffraction Compensation]
 - [Filter Settings]
 - [Rec. File Format]
 - [Filtering] and [add to list] in [Rec Quality]
 - [Rec Quality (My List)]
 - [Variable Frame Rate]
 - [Luminance Level]
 - [E-Stabilization (Video)] ([Image Stabilizer])
 - [Loop Recording (video)]
 - [Segmented File Recording]
 - [Live Cropping]
 - [Time Stamp Rec.]
 - [Color Bars]

Additions/Changes to Video Functions

Support for Output via HDMI During Recording of 6K/5.9K/5.4K Video





It is now possible to output via HDMI with a resolution of 4K or FHD during the recording of 6K video, 5.9K video, and 5.4K video.

- Output is with the resolution and frame rate according to [Down Convert] settings in [HDMI Rec Output] in the [Custom] ([IN/OUT]) menu.

[Assign REC to Shutter Button] Has Been Added

Use the shutter button for the start/stop operation of video recording in the [M] mode.

The start/stop operation of video recording using the shutter button can be disabled when set to [OFF].

 ⇒  ⇒  ⇒ Select [Assign REC to Shutter Button]

Settings: [ON]/[OFF]

Support for Settings with [Rec Quality (My List)] in the Control Panel

It is now possible to display the My List of recording quality from the control panel in [iA/M] mode or when [Video-Priority Display] is set.

Display the setting screen.

- Touch the recording quality item.
- When already registered in My List, the [Rec Quality (My List)] setting screen is displayed.

When not yet registered, the [Rec Quality] setting screen is displayed.

- [Rec Quality (My List)] and [Rec Quality] switch each time you press the [DISP.] button.
- The next time the setting screen is displayed, the screen last used is displayed.

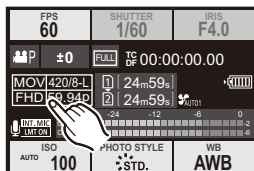

Changes to the [Noise Reduction] Adjustment Range When Using [V-Log]





When [Photo Style] is set to [V-Log], [-1] has been added to the image quality adjustment values of [Noise Reduction].

MENU SET → [CAMERA]/[VIDEO] → [DISP.] → [Photo Style] → [V-Log] → [Noise Reduction]

[HDMI MF Assist Output] Has Been Added to [HDMI Rec Output]

The MF Assist enlarged display is output to the external device connected via HDMI.

The MF Assist enlarged display is not output via HDMI when set to [OFF].

 ⇒ [] ⇒ [] ⇒ [HDMI Rec Output] ⇒ Select [HDMI MF Assist Output]

Settings: [ON]/[OFF]



- When [HDMI MF Assist Output] is set to [OFF] and the MF Assist enlarged display is being shown, the camera information display is not output via HDMI.

Improved Ease of Operation

Changes to How All Images Are Deleted

To prevent unintentional deletion of images, touch operations are prohibited in some screens for deleting all images.

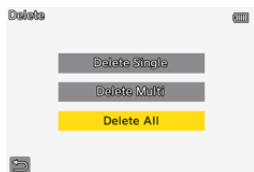

Touch operation allowed

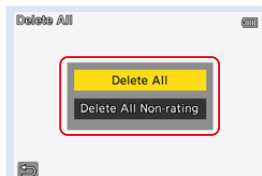

Touch operation not allowed*

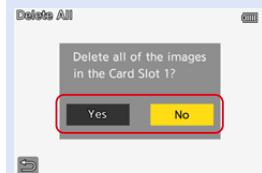

Touch operation not allowed*

* [] can be operated with a touch operation.

Changes to the AF Function

Support for [AF+MF] in AFC

When the focus mode is set to [AFC], [AF+MF] is now available.

When using AF, [AF+MF] can be used even when AF Lock is not engaged.

 ⇒  ⇒  ⇒ [AF+MF]

Improved Compatibility with Interchangeable Lenses

[Lens Fn Button Setting] Has Been Added

Register a function to the focus button of an interchangeable lens.

 ⇒  ⇒  ⇒ Select [Lens Fn Button Setting]

Setting Items ([Lens Fn Button Setting])



– [Focus Stop]	– [AF-Point Scope]
– [AF Mode]	– [Focus Area Set]
– [Focus Ring Lock]	– [Image Stabilizer]
– [AE LOCK]	– [Preview]
– [AF LOCK]	– [Preview Aperture Effect]
– [AF/AE LOCK]	– [No Setting]
– [AF-ON]	– [Off (Disable Press and Hold)]
– [AF-ON : Near Shift]	– [Restore to Default]
– [AF-ON : Far Shift]	



- [Focus Stop] is registered in the default setting.
When [Focus Stop] is used, the focus is locked while the focus button is pressed and held.
- When using an interchangeable lens that has a switch for the image stabilizer (normal/panning), [Image Stabilizer] in [Lens Fn Button Setting] is not available.

Changes to the Operation of the Image Stabilizer When Using Other Manufacturer's Lenses

Setting items for [Body(B.I.S.) / Lens(O.I.S.)] have been changed.

[Body(B.I.S.) / Lens(O.I.S.)] can be set when using other manufacturer's lenses with an image stabilizer function.



 → [] → [] → [Image Stabilizer] → Select [Body(B.I.S.) / Lens(O.I.S.)]



 ([Body])	The in-body image stabilizer corrects for vertical, horizontal, and rotational shake.
 ([Lens + Body (Roll)])	The in-lens image stabilizer corrects for vertical and horizontal shake, while the in-body image stabilizer corrects for rotational shake.

Additions/Changes to Other Functions

[Backlight Illumination Period] Has Been Added to [Status-LCD]



Sets the timing for the turning on/off of the status LCD backlight.

 → [] → [] → [Status-LCD] → Select [Backlight Illumination Period]

[ON1]	<p>The backlight turns on when the camera on/off switch is set to []. It keeps on until switched to [] again.</p> <ul style="list-style-type: none"> • If you use the following functions while the backlight being on, the backlight turns off: <ul style="list-style-type: none"> – Taking burst pictures – [6K/4K PHOTO] – [Post-Focus]
[ON2]	<p>When the camera on/off switch is set to [], the backlight turns on for a certain period.</p> <ul style="list-style-type: none"> • The timing for the turning on/off the backlight is same as in the past.
[OFF]	<p>Turns off the status LCD backlight.</p>



❖ [Backlight] of [Status-LCD] Has Been Changed to [Backlight Illumination]

The brightness of the backlight can be set to [H] (brighter) or [L] (dimmer).

 → [] → [] → [Status-LCD] → Select [Backlight Illumination]
Settings: [H]/[L]

[Destination Card Slot] Has Been Added to the [RAW Processing] Setting Items



You can select the card slot to which to save images processed with RAW.

- 1 **Select [RAW Processing].**
 -  ⇒  ⇒  ⇒ [RAW Processing]
- 2 **Select the RAW image.**
- 3 **Select [More Settings] from the setting items.**
- 4 **Select [Destination Card Slot] and set the card slot to be saved to.**

[AUTO]	Saved to the same card slot as the RAW format image to be processed.
[1]	Saved to card slot 1.
[2]	Saved to card slot 2.

[0.5SEC] Has Been Added to the [Duration Time (photo)] of [Auto Review]

After taking a picture, the recorded image is displayed for approx. 0.5 seconds.

 ⇒  ⇒  ⇒ [Auto Review] ⇒ [Duration Time (photo)] ⇒ [0.5SEC]

[Off (Disable Press and Hold)] Has Been Added to [Fn Button Set]

A setting item has been added that disables display of the function registering screen even when you press and hold the Fn button.

 ⇒ [] ⇒ [] ⇒ Select [Fn Button Set]

[Setting in REC mode] ⇒ [3] tab:  [Others]

[Setting in PLAY mode] ⇒ [2] tab:  [Others]



[Off (Disable Press and Hold)]	The button does not work as an Fn button. The function registering screen is not displayed when you press and hold (2 seconds) the Fn button.
---------------------------------------	--



- The firmware update has changed the default setting for [Fn6] and [Fn7] in [Setting in REC mode] from [No Setting] to [Off (Disable Press and Hold)].

[Preview Aperture Effect] Has Been Added to [Fn Button Set]

An Fn button function has been added so that you can preview the aperture effect.

 ⇒ [] ⇒ [] ⇒ [Fn Button Set] ⇒ Select [Setting in REC mode]

[2] tab:  [Monitor / Display]

[Preview Aperture Effect]

The aperture effect can be previewed while the Fn button is being pressed.

- These cannot be registered to [Fn3] to [Fn7].

Support for Aperture/Shutter Speed Operations When Monitor is Off

Aperture value and shutter speed settings with the front dial and rear dial are now possible when the monitor is off.

Added Menu





















Specifications information for the menus added by the firmware update.

❖ List of Default Settings/Saving Customization/Copied Settings







: Using [Reset], the function to return to default settings

: Using [Save to Custom Mode], the function to save settings details in the Custom mode

: Using [Save/Restore Camera Setting], the function to copy settings details

Menu		Default settings			
 [Photo]:  [Others (Photo)]					
[Image Stabilizer]	[Body(B.I.S.) / Lens(O.I.S.)]	[]	✓	✓	✓
 [Video]:  [Image Format]					
[HDMI RAW Data Output]		[OFF]	✓	✓	✓
 [Video]:  [Others (Video)]					
[Image Stabilizer]	[Body(B.I.S.) / Lens(O.I.S.)]	[]	✓	✓	✓
 [Custom]:  [Focus/Shutter]					
[Assign REC to Shutter Button]		[ON]	✓	✓	✓
 [Custom]:  [Monitor / Display (Photo)]					
[Auto Review]	[Duration Time (photo)]	[OFF]	✓	✓	✓
 [Custom]:  [IN/OUT]					
[HDMI Rec Output]	[HDMI MF Assist Output]	[ON]	✓	✓	✓
 [Custom]:  [Lens / Others]					
[Lens Fn Button Setting]		[Focus Stop]	✓	✓	✓
 [Setup]:  [Monitor / Display]					
[Status-LCD]	[Backlight Illumination Period]	[ON2]	✓		✓
	[Backlight Illumination]	[H]	✓		✓

❖ List of Functions That Can Be Set in Each Recording Mode

Menu		iA	P	A	S	M	
 [Photo]:  [Others (Photo)]							
[Image Stabilizer]	[Body(B.I.S.) / Lens(O.I.S.)]	✓	✓	✓	✓	✓	
 [Video]:  [Image Format]							
[HDMI RAW Data Output]							✓
 [Video]:  [Others (Video)]							
[Image Stabilizer]	[Body(B.I.S.) / Lens(O.I.S.)]	✓	✓	✓	✓	✓	✓

- Ninja V / ATOMOS are registered trademarks of ATOMOS Limited.

Firmware Ver. 2.2



Additions/Changes to AF Functions

Improved Automatic Detection AF Performance





Automatic detection is now able to detect the heads of people whose faces are not facing directly to the front.

The item names have been changed from [Face/Eye/Body Detection] to [Human Detect AF], and from [Face/Eye/Body/Animal Detect.] to [Human/Animal Detect AF] accordingly.

 [Human Detect AF]	The camera detects a person's face, eyes, and body (entire body, upper half of the body, or head) and adjusts the focus.
 [Human/Animal Detect AF]	Along with humans, animals such as birds, canines (including wolves), and felines (including lions) will be detected. Animals will be prioritized for detection over humans.

Automatic Detection AF Has Been Added to

 [1-Area+]/ [1-Area]



iA P A S M  



Automatic detection is now available in the [1-Area+]/[1-Area] AF modes. When a part of a human or animal enters the [1-Area+]/[1-Area] AF area, the automatic detection AF area is indicated in yellow.

Eye detection works when a person's face is inside the AF area.

❖ Switching of Automatic Detection

- 1 Press  to display the AF mode selection screen.
- 2 Select  or  and then press ▲.
 - Each press of ▲ switches automatic detection.
 - The automatic detection settings of [1-Area+] and [1-Area] are linked.

Automatic detection:
OFF



[Human Detect AF]:
ON



[Human/Animal
Detect AF]: ON

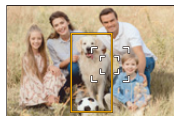

- Only 1 human or animal can be automatically detected in the AF area.
- You cannot change the person, animal or eye being focused on during automatic detection.

Support for the [AF+MF] Function During Recording of Video



During video recording, the MF mode is engaged when you rotate the focus ring, and the AF mode is engaged when you stop rotating the focus ring.



- When [Continuous AF] is set to [MODE2], the focus can be adjusted manually even during recording standby.

Additions/Changes to Video Functions

Support for Vertical Playback of Video

When video is recorded with the camera held vertically, the video is automatically played back vertically on smartphones and PCs.



- In the camera playback screen, playback is vertical only in the thumbnail display.

Additions/Changes to Other Functions

Support for Transfer of 4K Video Files to Smartphones

It is now possible to transfer 4K MP4 video files to smartphones.





- It is not possible to transfer images with file sizes exceeding 4 GB.

[Horizontal Image Flip(Monitor)] and [Vertical Image Flip(Monitor)] Have Been Added to [LVF/Monitor Disp. Set]

It is now possible to set whether the screen flips or not depending on the facing or angle of the monitor during recording.



⇒ [] ⇒ [] ⇒ [LVF/Monitor Disp. Set] ⇒ Select [Horizontal Image Flip(Monitor)]/[Vertical Image Flip(Monitor)]

[Horizontal Image Flip(Monitor)]	[AUTO]	The screen automatically flips horizontally according to the angle to which the monitor is opened or closed.
	[ON]	The screen is flipped horizontally all the time.
	[OFF]	Screen is not flipped.
[Vertical Image Flip(Monitor)]	[AUTO]	The screen automatically flips vertically according to the angle to which the monitor is rotated.
	[ON]	The screen is flipped vertically all the time.
	[OFF]	Screen is not flipped.



- The settings for this function are not reflected in the playback screen.

Added Menu





Specifications information for the menus added by the firmware update.

❖ List of Default Settings/Saving Customization/Copied Settings

: Using [Reset], the function to return to default settings

: Using [Save to Custom Mode], the function to save settings details in the Custom mode

: Using [Save/Restore Camera Setting], the function to copy settings details

Menu		Default settings			
 [Custom]:  [Monitor / Display (Photo)]					
[LVF/Monitor Disp. Set]	[Horizontal Image Flip(Monitor)]	[AUTO]	✓	✓	✓
	[Vertical Image Flip(Monitor)]	[AUTO]	✓	✓	✓

Firmware Ver. 2.4

Models Supporting Output of RAW Video Data Have Been Added

RAW Video Data of this camera can now be recorded to a Blackmagic Design external recorder.

- Recording of the RAW Video Data of this camera has been confirmed on the following external recorder. (As of March 2021)
 - Blackmagic Design “Blackmagic Video Assist 5” 12G HDR” and “Blackmagic Video Assist 7” 12G HDR” (Ver. 3.4 or higher)For details, please contact Blackmagic Design.
- This does not guarantee all of the capabilities that the compatible external recorder may have.
- You will need compatible software to edit the RAW Video Data recorded with the external recorder.
- Visit the following site to download LUT data or view the latest support information:
<https://panasonic.jp/support/global/cs/dsc/>
(English only)





- Video cannot be recorded to cards while RAW Video Data is being output via HDMI.
- When [System Frequency] is set to [24.00Hz (CINEMA)], RAW Video Data cannot be output via HDMI.



- Refer to “Outputting RAW Video Data via HDMI” in “Firmware Ver. 2.0/2.1” for operations and limitations for RAW Video Data output.

[Vertical Position Info (Video)] Has Been Added

You can now set on the menu, whether or not to record the camera's vertical orientation information during video recording.

 → [] → [] → Select [Vertical Position Info (Video)]

[ON]	Records vertical orientation information. Videos recorded with the camera held vertically will be automatically played vertically on the PC or smartphone etc. during playback.
[OFF]	Does not record vertical orientation information.

Support for the [Power Save Mode] When Using an AC Adaptor

When using an AC adaptor (DMW-AC10: optional), it is now possible to set the [Power Save Mode].

Added Menu





Specifications information for the menu added by the firmware update.

❖ List of Default Settings/Saving Customization/Copied Settings

: Using [Reset], the function to return to default settings

: Using [Save to Custom Mode], the function to save settings details in the Custom mode

: Using [Save/Restore Camera Setting], the function to copy settings details

Menu	Default settings			
 [Custom]:  [Lens / Others]				
[Vertical Position Info (Video)]	[ON]	✓	✓	✓

- 'Blackmagic Design' is a registered trademark of Blackmagic Design Pty. Ltd. All other company and product names are trademarks of their respective corporations.