

Panasonic[®]

Owner's Manual <Complete Guide>

Digital Camera

Model No. **DC-GH5M2**

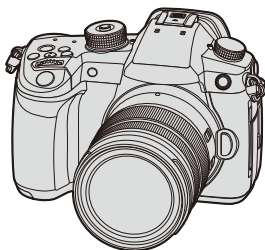

LUMIX

Please read these instructions carefully before using this product.

Register online at

<http://shop.panasonic.com/support>

(U.S. customers only)

DVQP2461ZA
F0521MZ0

About Owner's Manual

This document, "Owner's Manual <Complete Guide>", includes detailed explanations of all the functions and operations of the camera.

❖ How to Use the <Complete Guide> (HTML)

Display on a PC

Example: Display in English

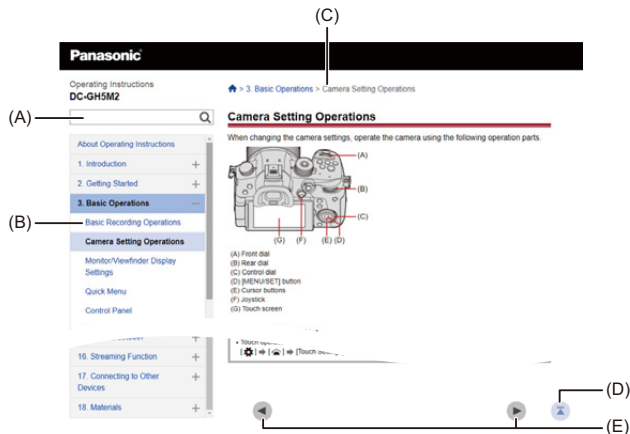

Display on a smartphone

Example: Display in English

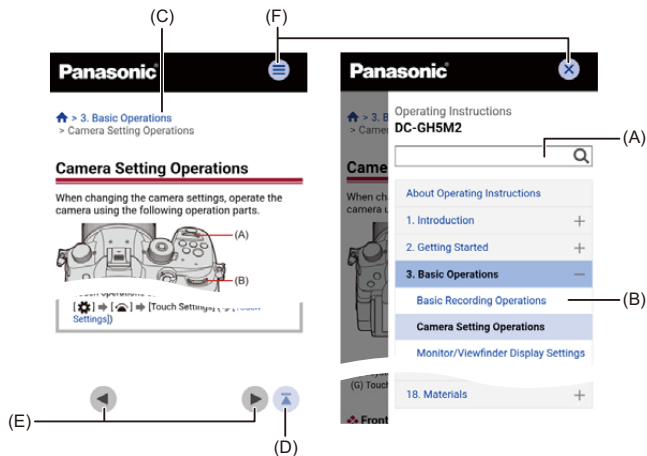

(A) Search field

Enter the term to search for and press [Q].

By entering multiple search terms separated by spaces, you can find pages that include all of the search terms you entered.

No distinction is made between upper and lower case or between single- and double-byte characters.

(B) 'Contents'

Description pages open when you press headings.

Use [+][-] to open and collapse the 'Contents'.

(C) Breadcrumbs

Indicates the location of the page that is currently open.

Press [Home] to return to the front page.

(D) 'Back to Top' button

(E) 'Show Previous Page' button/'Show Next Page' button

(F) 'Show Contents' button/'Close Contents' button

When displaying on a smartphone, press [] to display the 'Contents'.

Press [] to exit 'Contents'.

❖ Symbols Used in This Document

Black icons show conditions in which these can be used, and gray icons show conditions in which these cannot be used.





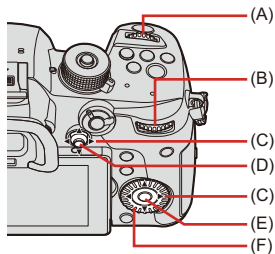

Example:

Pictures/Videos  

Recording mode      

Operating symbols



(A)		Front dial
(B)		Rear dial
(C)		Cursor button up/down/left/right or Joystick up/down/left/right
(D)		Press the center of the joystick
(E)		[MENU/SET] button
(F)		Control dial

- Other symbols, such as icons shown on the camera screen, are also used in explanations.
- This document describes the procedure for selecting menu items as follows:
Example: Set the [Picture Quality] of the [Photo] ([Image Quality]) menu

 ⇒ [] ⇒ [] ⇒ [Picture Quality] ⇒ **Select [STD.]**

- Images and illustrations used in this document are for explaining the functions.
- Description in this document is based on the interchangeable lens (H-ES12060).

Contents

About Owner's Manual 2

1. Introduction 18

Before Use.....	19
Standard Accessories.....	22
Lenses That Can Be Used.....	24
Memory Cards That Can Be Used.....	25
Names of Parts.....	28
Camera.....	28
Lens.....	36
Viewfinder/Monitor Displays.....	38

2. Getting Started 40

Attaching a Shoulder Strap.....	41
Charging the Battery.....	43
Charging with the Charger.....	44
Battery Insertion.....	47
Inserting a Battery into the Camera for Charging.....	49
Using the Camera While Supplying It with Power (Supplying Power/Charging).....	53
Notifications Regarding Charging/Power Supply.....	55
[Power Save Mode].....	57
Inserting Cards (Optional).....	59
Formatting Cards (Initialization).....	62
Attaching a Lens.....	63
Attaching a Lens Hood.....	66
Adjusting the Monitor Direction and Angle.....	69
Setting the Clock (When Turning On for the First Time).....	70
Clock Set.....	70

3. Basic Operations **74**

Basic Recording Operations	75
How to Hold the Camera	75
Recording	77
Selecting the Recording Mode	79
Camera Setting Operations	80
Monitor/Viewfinder Display Settings	85
Setting the Viewfinder	85
Switching Between the Monitor and Viewfinder	86
Switching the Display Information	88
Quick Menu.....	91
Control Panel.....	93
Menu Operation Methods	95
Menu operation	95
[Reset]	100
Intelligent Auto Mode	101
Recording Using Touch Functions.....	108
Touch AF/Touch Shutter	108
Touch AE.....	111

4. Image Recording **113**

[Aspect Ratio]	114
[Picture Size].....	115
[Picture Quality]	116
[Double Card Slot Function].....	118
[Folder / File Settings].....	120
[File Number Reset].....	123

5. Focus/Zoom 124

Selecting the Focus Mode	125
Using AF	127
[AF Custom Setting(Photo)]	132
Selecting the AF Mode	135
[Human Detect AF]/[Human/Animal Detect AF]	138
[Tracking].....	143
[225-Area].....	145
[Zone (Vert./ Horz.)]/[Zone (Square)]/[Zone (Oval)].....	146
[1-Area+]/[1-Area].....	149
[Pinpoint]	152
[Custom1] to [Custom3].....	155
AF Area Movement Operation	158
Moving the AF Area by Touch	161
Moving the AF Area Position with the Touch Pad	163
[Focus Switching for Vert / Hor].....	166
Record Using MF	167
Recording with Zoom.....	174
Extended Tele Conversion	176
[Power Zoom Lens]	180

6. Drive/Shutter/Image Stabilizer 181

Selecting the Drive Mode.....	182
Taking Burst Pictures.....	184
6K/4K Photo Recording	190
Selecting Pictures from a 6K/4K Burst File.....	197
Correcting Pictures After Recording (Post-Recording Refinement).....	200
Picture Selection Operations.....	202

Post-Focus Recording	207
Selecting the Focus Point for the Picture to Save	211
Focus Stacking	213
Recording with Time Lapse Shot.....	216
Recording with Stop Motion Animation.....	221
Time Lapse Shot/Stop Motion Animation Videos	225
Recording Using the Self-timer.....	227
Bracket Recording	231
[Silent Mode].....	239
[Shutter Type]	240
Image Stabilizer	243
Image Stabilizer Settings.....	246
7. Metering/Exposure/ISO Sensitivity	251
[Metering Mode].....	252
Program AE Mode	253
Aperture-Priority AE Mode.....	257
Shutter-Priority AE Mode	260
Manual Exposure Mode.....	263
Preview Mode	267
Exposure Compensation	269
Locking Focus and Exposure (AF/AE Lock).....	271
ISO Sensitivity	273
8. White Balance/Image Quality	277
White Balance (WB)	278
Adjusting the White Balance	283
[Photo Style]	285

[Filter Settings].....	293
[Simultaneous Record w/o Filter].....	302

9. Flash **303**

Using an External Flash (Optional).....	304
Removing the Hot Shoe Cover.....	305
Setting Flash.....	308
[Flash Mode].....	309
[Firing Mode]/[Manual Flash Adjust.].....	311
[Flash Adjust.].....	313
[Flash Synchro]	315
[Auto Exposure Comp.].....	316
Recording Using a Wireless Flash.....	317

10. Recording Videos **324**

Recording Videos	325
Recording Videos	325
Creative Video Mode	330
Setting the Exposure for Recording Videos.....	331
Separating Settings for Recording Video and Pictures	334
Video Recording Settings	335
[System Frequency]	336
[Rec. File Format].....	337
[Rec Quality].....	338
[Image Area of Video].....	348
Time Code	350
Setting the Time Code.....	350
Using AF (Video)	353
[Continuous AF].....	354
[AF Custom Setting(Video)].....	355

Video Brightness and Coloring	356
[Luminance Level]	357
[Master Pedestal Level]	358
Recording While Controlling Overexposure (Knee).....	360
[ISO Sensitivity (video)]	362
Audio Settings.....	364
[Sound Rec Level Disp.].....	364
[Mute Sound Input]	365
[Sound Rec Gain Level]	365
[Sound Rec Level Adj.].....	366
[Sound Rec Level Limiter]	366
[Wind Noise Canceller].....	367
[Lens Noise Cut].....	368
Main Assist Functions.....	369
[SS/Gain Operation]	370
[WFM/Vector Scope]	371
[Luminance Spot Meter]	375
[Zebra Pattern]	377
[Frame Marker].....	379
Color bars/Test Tone.....	380
[Variable Frame Rate].....	382
[Focus Transition]	386
[Live Cropping].....	390
Log Recording	396
[V-Log L] Settings	396
[V-LogL View Assist]	398
HLG Videos	400
[Hybrid Log Gamma] settings.....	401
[HLG View Assist].....	404
Anamorphic Recording	405

6K/4K Anamorphic (4:3) video	406
[Anamorphic Desqueeze Display]	407
[Synchro Scan]	410
[Loop Recording (video)]	412
[Segmented File Recording]	414
List of Recording Qualities That Enable Special Videos to be Recorded	416
11. Connections with External Devices (Video)	421
HDMI Devices (HDMI Output)	422
Attaching the Cable Holder	424
Images Output via HDMI	427
HDMI Output Image Quality (Resolution/Frame Rate)	429
Settings for Down-Converting.....	429
HDMI Output Settings.....	432
Outputting the Camera Information Display via HDMI.....	432
Outputting Control Information to an External Recorder	433
Outputting Down-converted Audio to an HDMI Device	434
Outputting Audio via HDMI.....	434
Output the enlarged display of MF assist via HDMI	435
External Microphones (Optional)	436
XLR Microphone Adaptor (Optional).....	439
Headphones	441
12. Playing Back and Editing of Images	443
Playing Back Pictures	444
Playing Back Videos	446
Extracting a Picture	449
Switching the Display Mode.....	450

Enlarged Display	450
Thumbnail Screen	452
Calendar Playback	454
Group Images	456
Deleting Images	458
[RAW Processing].....	460
[Video Divide].....	467
13. Camera Customization	469
Fn Buttons	471
Fn Button Default Settings	472
Register Functions to the Fn Buttons	474
Use the Fn Buttons.....	485
[Dial Operation Switch]	487
Register Functions to the Dials.....	487
Temporarily Change Dial Operation	489
Quick Menu Customization	490
Register to the Quick Menu	490
Custom Mode	498
Register in Custom Mode	498
Using Custom Mode	501
Calling Up Settings	502
My Menu	503
Registration in My Menu	503
Edit My Menu	504
[Save/Restore Camera Setting]	505
14. Menu Guide	507
List of Menu	508

[Photo] Menu	518
[Photo] menu ([Image Quality])	518
[Photo] menu ([Focus])	523
[Photo] menu ([Flash])	525
[Photo] menu ([Others (Photo)])	528
[Video] Menu.....	534
[Video] menu ([Image Quality]).....	534
[Video] menu ([Image Format]).....	538
[Video] menu ([Focus])	540
[Video] menu ([Audio]).....	542
[Video] menu ([Others (Video)]).....	545
[Custom] Menu	548
[Custom] menu ([Image Quality]).....	549
[Custom] menu ([Focus/Shutter])	553
[Custom] menu ([Operation])	559
[Custom] menu ([Monitor / Display (Photo)])	564
[Custom] menu ([Monitor / Display (Video)])	575
[Custom] menu ([IN/OUT]).....	579
[Custom] menu ([Lens / Others])	580
[Setup] Menu	583
[Setup] menu ([Card/File])	583
[Setup] menu ([Monitor / Display])	585
[Setup] menu ([IN/OUT])	588
[Setup] menu ([Setting])	592
[Setup] menu ([Others])	594
[Playback] Menu	597
How to Select an Image(s) in the [Playback] menu	597
[Playback] menu ([Playback Mode])	599
[Playback] menu ([Process Image]).....	602
[Playback] menu ([Add/Delete Info.]).....	604
[Playback] menu ([Edit Image])	605

[Playback] menu ([Others]).....	608
Entering Characters.....	609

15. Wi-Fi/Bluetooth **610**

Connecting to a Smartphone	612
Flow of connecting a smartphone	612
Installing "LUMIX Sync"	614
Connecting to a Smartphone (Bluetooth Connection).....	615
Connecting to a Smartphone ([Wi-Fi connection]).....	622
Operating the Camera with a Smartphone	629
[Remote shooting]	631
[Shutter Remote Control].....	634
[Import images].....	637
[Auto Transfer].....	639
[Location Logging]	642
[Remote Wakeup].....	644
[Auto Clock Set].....	645
[Camera settings copy].....	646
Sending Images from the Camera.....	647
[Smartphone].....	651
[PC]	655
[Printer].....	659
Wi-Fi Connections	661
[Via Network]	662
[Direct]	666
Connect to Wi-Fi Using Previously Saved Settings.....	668
Send Settings and Selecting Images.....	671
Image Send Settings	671
Selecting Images	673
[Wi-Fi Setup] Menu	674

16. Streaming Function **676**

Stream by Operating a Smartphone	677
Stream by Operating the Camera	679
Streaming Settings	682
Notes When Using the Streaming Function	686

17. Connecting to Other Devices **688**

Viewing on a TV	690
Importing Images to a PC	694
Installing Software	696
Storing on a Recorder	698
Tethered Recording	699
Installing Software	700
Operating the Camera from a PC	701
Printing	702

18. Materials **706**

Digital Camera Accessory System	707
Using Optional Accessories	709
Battery Grip (Optional)	709
Shutter Remote Control (Optional)	711
Tripod Grip (Optional)	712
AC Adaptor (Optional)/DC Coupler (Optional)	713
Monitor/Viewfinder Displays	714
Recording Screen	714
Playback Screen	728
Message Displays	733
Troubleshooting	736
Power, Battery	736

Recording	737
Video	742
Playback.....	743
Monitor/Viewfinder.....	744
Flash.....	744
Wi-Fi Function	745
TV, PC, Printer	748
Others.....	749
Cautions for Use	750
Number of Pictures That Can Be Taken and Available Recording Time with the Battery.....	762
Number of Still Images That Can Be Taken and Video Recording Time with Cards	766
List of Default Settings/Custom Saving/Settings Available for Copying.....	771
List of Functions That Can Be Set in Each Recording Mode...	790
Specifications.....	797
Trademarks and Licences	809

1. Introduction

- Before Use: 19
- Standard Accessories: 22
- Lenses That Can Be Used: 24
- Memory Cards That Can Be Used: 25
- Names of Parts: 28

Before Use

❖ Firmware of Your Camera/Lens

Firmware updates may be provided in order to improve camera capabilities or to add functionality.

Make sure that the firmware of the camera/lens you purchased is the latest version. We recommend using the latest firmware version.

- To check the firmware version of the camera/lens, attach the lens to the camera and select [Firmware Version] in the [Setup] ([Others]) menu. You can also update the firmware in [Firmware Version].
- For the latest information on the firmware or to download/update the firmware, visit the following support site:
<https://panasonic.jp/support/global/cs/dsc/>
(English only)

❖ Handling of the Camera

When using the camera, take care not to drop it, bump it, or apply undue force. These may cause malfunction or damage to the camera and lens.

If sand, dust, or liquid gets on the monitor, wipe it off with a dry soft cloth.
– Touch operations may be incorrectly recognized.

When using in low temperatures (–10 °C to 0 °C (14 °F to 32 °F))

- Before use, attach a Panasonic lens with a minimum recommended operating temperature of –10 °C (14 °F).

Do not place a hand inside the camera mount.

This may cause a failure or damage because the sensor is a precision device.

If you shake the camera while turning the camera off, a sensor may operate or a rattling sound may be heard. This is caused by the image stabilizer mechanism in the body. It is not a malfunction.

❖ **Splash Resistant**

Splash Resistant is a term used to describe an extra level of protection this camera offers against exposure to a minimal amount of moisture, water or dust. Splash Resistant does not guarantee that damage will not occur if this camera is subjected to direct contact with water.

In order to minimize the possibility of damage please be sure the following precautions are taken:

- Splash Resistant works in conjunction with the lenses that were specifically designed to support this feature.
- Securely close the doors, socket caps, contact points cover, etc.
- When the lens or cap is removed or a door is open, do not allow sand, dust, and moisture to enter inside.
- If liquid gets on the camera, wipe it off with a dry soft cloth.

❖ **Condensation (When the Lens, the Viewfinder or Monitor is Fogged Up)**

- Condensation occurs when there are temperature or humidity differences. Take care as this may lead to soiling, mold, and malfunctions in the lens, viewfinder, and monitor.
- If condensation occurs, turn off the camera and leave it for approx. 2 hours. The fog will disappear naturally when the temperature of the camera becomes close to the ambient temperature.

❖ **Be Sure to Perform Trial Recording in Advance**

Perform trial recording in advance of an important event (wedding, etc.) to check that recording can be performed normally.

❖ **No Compensation Regarding Recording**

Please note that compensation cannot be provided in the event that recording could not be performed due to a problem with the camera or a card.

❖ **Be Careful with Regard to Copyrights**

Under copyright law, you may not use the images and audio you have recorded for other than personal enjoyment without the permission of the copyright holder.

Be careful because there are cases where restrictions apply to recording even for the purpose of personal enjoyment.

❖ **Also Read “[Cautions for Use](#)” (→ [Cautions for Use: 750](#))**

Standard Accessories

Check that all the accessories are supplied before using the camera.

- The accessories and their shape will differ depending on the country or area where the camera was purchased.

For details on the accessories, refer to “Owner’s Manual <Quick Start Guide>” (supplied).

- **Digital camera body**

(This is referred to as **camera** in this document.)

- **Battery pack**

(This is referred to as **battery pack** or **battery** in this document.)

– Charge the battery before use.

- **Battery charger**

(This is referred to as **battery charger** or **charger** in this document.)

- **AC adaptor**

– This is used for charging and power supply.

- **USB connection cable**

- **Cable holder**

- **Shoulder strap**

- **Body cap**^{*1}

- **Eye cup**^{*1}

- **Hot shoe cover**^{*1}

- **Cover for the battery grip connector**^{*1}

- **Flash synchro socket cap**^{*1}

*1 This is attached to the camera at the time of purchase.

Items Supplied with DC-GH5M2L (Lens Kit Product)

- **Interchangeable lens^{*2}:**

H-ES12060 “LEICA DG VARIO-ELMARIT 12–60mm/F2.8–4.0 ASPH./POWER O.I.S.”

- This lens is dust and splash resistant.
- The recommended operating temperature is from –10 °C to 40 °C (14 °F to 104 °F).

- **Lens hood**

- **Lens cap^{*3}**

- **Lens rear cap^{*3}**

Items Supplied with DC-GH5M2M (Lens Kit Product)

- **Interchangeable lens^{*2}:**

H-FS12060 “LUMIX G VARIO 12–60mm/F3.5–5.6 ASPH./POWER O.I.S.”

- This lens is dust and splash resistant.
- The recommended operating temperature is from 0 °C to 40 °C (32 °F to 104 °F).

- **Lens hood**

- **Lens cap^{*3}**

- **Lens rear cap^{*3}**

^{*2} This is referred to as **lens** in these operating instructions.

^{*3} This is attached to the lens at the time of purchase.

- **The memory card is optional.**

- Consult the dealer or Panasonic if you lose the supplied accessories. (You can purchase the accessories separately.)
- Please dispose of all packaging appropriately.
- Keep small parts in a safe place out of the reach of children.

(For U.S.A. only)

- If accessories are lost, customers can visit us at <http://shop.panasonic.com/support> for further information about obtaining replacement parts.

(For Canada only)

- If any accessories are lost, customers in Canada should visit our support page at www.panasonic.ca/english/support for further information about obtaining replacement parts.

Lenses That Can Be Used

This unit can use the dedicated lenses compatible with the Micro Four Thirds™ System lens mount specification (Micro Four Thirds mount).



You can also use the Leica M Mount interchangeable lens by attaching the M Mount Adaptor (DMW-MA2M: optional).

❖ About the lens and functions

Depending on the lens used, certain functions, such as Auto Focus, Image Stabilizer, and zoom functions, may be disabled or operate differently.

- **Refer to catalogs/websites for most current information regarding supported lenses.**

<https://panasonic.jp/support/global/cs/dsc/>

(English only)

- The focal length noted on the Micro Four Thirds lens is equivalent to double when converted to the 35 mm film camera. (It will be equivalent to 100 mm lens when a 50 mm lens is used.)

Memory Cards That Can Be Used

You can use the following memory cards with this camera. (As of May 2021)

SD memory card/SDHC memory card/SDXC memory card (Maximum 256 GB)

- SD memory card, SDHC memory card, and SDXC memory card are referred to by the generic name of **card** in this document.
- This camera supports cards compliant with UHS Speed Class 3 of the UHS-I/ UHS-II standard and Video Speed Class 90 of the UHS-II standard.





-
- For the latest information on memory cards with confirmed operation, check the following support site:

<https://panasonic.jp/support/global/cs/dsc/>

(English only)

- When using the following functions, use cards that have the correct SD Speed Class, UHS Speed Class, and Video Speed Class.
 - Speed classes are standards to guarantee the minimum speed necessary for continuous writing.

[Video Record]

Bit rate of the recording quality	Speed Class	Example of indication
72 Mbps or less	Class 10	CLASS  
	UHS Speed Class 1 or higher	U1
	Video Speed Class 10 or higher	V10
100 Mbps to 200 Mbps	UHS Speed Class 3	U3
	Video Speed Class 30 or higher	V30
400 Mbps	Video Speed Class 60 or higher	V60 V90

[6K/4K PHOTO]/[Post-Focus]

Speed Class	Example of indication
UHS Speed Class 3	U3
Video Speed Class 30 or higher	V30

- You can prevent the writing and deleting of data by setting the write-protect switch (A) on the card to “LOCK”.
- The data stored on a card may be damaged due to electromagnetic waves, static electricity or a failure of the camera or card. We recommend backing up important data.
- Keep the memory card out of reach of children to prevent swallowing.

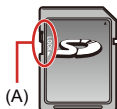



Names of Parts

- Camera: 28
- Lens: 36
- Viewfinder/Monitor Displays: 38

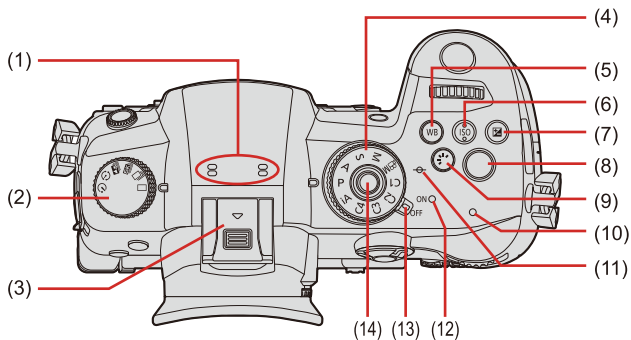

Camera

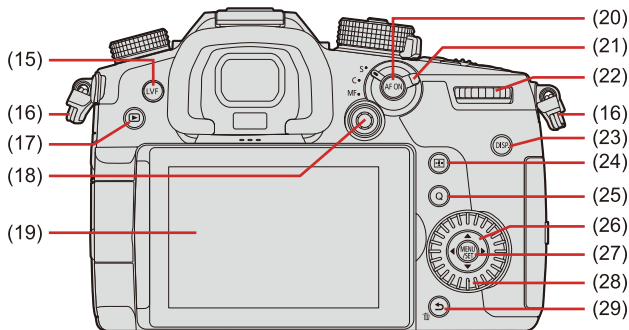

- (1) Stereo microphone (→[\[Sound Rec Level Adj.\]: 366](#))
 - Do not block the microphone with a finger. Audio will be difficult to record.
- (2) Drive mode dial (→[Selecting the Drive Mode: 182](#))
- (3) Hot shoe (hot shoe cover) (→[Removing the Hot Shoe Cover: 305](#))
 - Keep the hot shoe cover out of reach of children to prevent swallowing.
- (4) Mode dial (→[Selecting the Recording Mode: 79](#))
- (5) [WB] (White balance) button (→[White Balance \(WB\): 278](#))
- (6) [ISO] (ISO sensitivity) button (→[ISO Sensitivity: 273](#))
- (7) [] (Exposure compensation) button (→[Exposure Compensation: 269](#))
- (8) Video rec. button (→[Recording Videos: 325](#))
- (9) [] (Photo style) button (→[\[Photo Style\]: 285](#))
- (10) Charging light (→[Charging light Indications: 50](#))/
NETWORK connection lamp (→[NETWORK connection lamp: 611](#))
- (11) [] (Recording distance reference mark) (→[Operations on the MF Assist Screen: 172](#))
- (12) Status indicator (→[Setting the Clock \(When Turning On for the First Time\): 70](#))
- (13) Camera on/off switch (→[Setting the Clock \(When Turning On for the First Time\): 70](#))
- (14) Mode dial lock button (→[Selecting the Recording Mode: 79](#))



- (15) [LVF] button (→ [Switching Between the Monitor and Viewfinder: 86](#))
- (16) Shoulder strap eyelet (→ [Attaching a Shoulder Strap: 41](#))
- (17) [▶] (Playback) button (→ [Playing Back Pictures: 444](#))
- (18) Joystick (→ [Joystick: 83](#))/
Fn buttons (→ [Fn Buttons: 471](#))
Center: Fn8, ▲: Fn9, ►: Fn10, ▼: Fn11, ◀: Fn12
- (19) Monitor (→ [Viewfinder/Monitor Displays: 38](#), [Monitor/Viewfinder Displays: 714](#))/
Touch screen (→ [Touch Screen: 84](#))
- (20) [AF ON] button (→ [\[AF ON\] button: 129](#))
- (21) Focus mode lever (→ [Selecting the Focus Mode: 125](#))
- (22) Rear dial (→ [Front Dial/Rear Dial: 81](#))
- (23) [DISP.] button (→ [Switching the Display Information: 88](#))
- (24) [] (AF mode) button (→ [Using AF: 127](#))
- (25) [Q] (Quick menu) button (→ [Quick Menu: 91](#))
- (26) Cursor buttons (→ [Cursor Buttons: 82](#))/
Fn buttons (→ [Fn Buttons: 471](#))
▲: Fn13, ►: Fn14, ▼: Fn15, ◀: Fn16

- (27) [MENU/SET] button (→[\[MENU/SET\] Button: 82, Menu Operation Methods: 95](#))
- (28) Control dial (→[Control Dial: 81](#))
- (29) [] (Cancel) button/
[] (Delete) button (→[Deleting Images: 458](#))/
Fn button (Fn1) (→[Fn Buttons: 471](#))

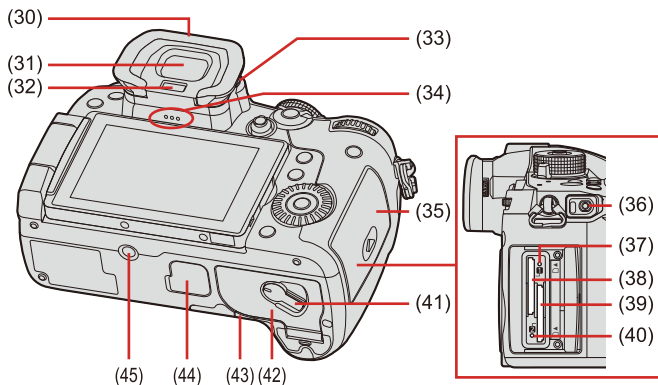

- (30) Eye cup (→[Cleaning the Viewfinder: 753](#))
- Keep the eye cup out of reach of children to prevent swallowing.
- (31) Viewfinder (→[Viewfinder/Monitor Displays: 38](#), [Switching Between the Monitor and Viewfinder: 86](#), [Monitor/Viewfinder Displays: 714](#))
- (32) Eye sensor (→[Switching Between the Monitor and Viewfinder: 86](#))
- (33) Diopter adjustment dial (→[Adjusting the Viewfinder Diopter: 85](#))
- (34) Speaker (→[\[Beep\]: 588](#))
- (35) Card door (→[Inserting Cards \(Optional\): 59](#))
- (36) [REMOTE] socket (→[Shutter Remote Control \(Optional\): 711](#))
- (37) Card access light 1 (→[Card Access Indications: 60](#))
- (38) Card slot 1 (→[Inserting Cards \(Optional\): 59](#))
- (39) Card slot 2 (→[Inserting Cards \(Optional\): 59](#))
- (40) Card access light 2 (→[Card Access Indications: 60](#))
- (41) Battery door release lever (→[Battery Insertion: 47](#))
- (42) Battery door (→[Battery Insertion: 47](#))

- (43) DC Coupler cover (→ [AC Adaptor \(Optional\)/DC Coupler \(Optional\): 713](#))
- When using an AC adaptor, ensure that the Panasonic DC Coupler (DMW-DCC17: optional) and AC Adaptor (DMW-AC10: optional) are used.
 - Always use a genuine Panasonic AC Adaptor (DMW-AC10: optional).
 - When using an AC Adaptor (optional), use the AC cable supplied with the AC Adaptor (optional).
- (44) Battery grip connector (cover for the battery grip connector) (→ [Battery Grip \(Optional\): 709](#))
- Keep the cover for the battery grip connector out of reach of children to prevent swallowing.
- (45) Tripod mount (→ [Tripod: 760](#))
- If you attempt to attach a tripod with a screw length of 5.5 mm (0.22 inch) or more, you may not be able to securely fix it in place or it may damage the camera.

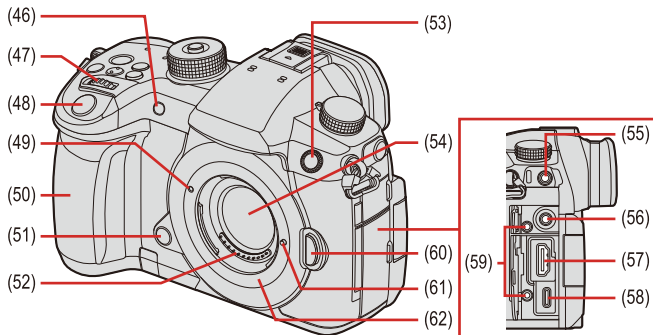

- (46) Self-timer light (→[Recording Using the Self-timer: 227](#))/
AF assist light (→[\[AF Assist Light\]: 523](#))
- (47) Front dial (→[Front Dial/Rear Dial: 81](#))
- (48) Shutter button (→[Recording: 77](#))
- (49) Lens fitting mark (→[Attaching a Lens: 63](#))
- (50) Grip
- (51) Preview button (→[Preview Mode: 267](#))/
Fn button (Fn2) (→[Fn Buttons: 471](#))
- (52) Contact points
- (53) Flash synchro socket (flash synchro socket cap) (→[Connecting a Synchro Cable to the Flash Synchro Socket: 306](#))
- Use an external flash with a synchronization voltage of 400 V or less.
 - Keep the flash synchro socket cap out of reach of children to prevent swallowing.
- (54) Sensor
- (55) [MIC] socket (→[External Microphones \(Optional\): 436](#))

(56) Headphone socket (→ [Headphones: 441](#))

- Excessive sound pressure from earphones and headphones can cause hearing loss.

(57) [HDMI] socket (→ [HDMI Devices \(HDMI Output\): 422](#), [\[HDMI\] socket: 688](#))

(58) USB port (→ [Inserting a Battery into the Camera for Charging: 49](#), [USB port: 689](#))

(59) Cable holder mount (→ [Attaching the Cable Holder: 424](#))

(60) Lens release button (→ [Removing a Lens: 65](#))

(61) Lens lock pin

(62) Mount

Lens

H-ES12060

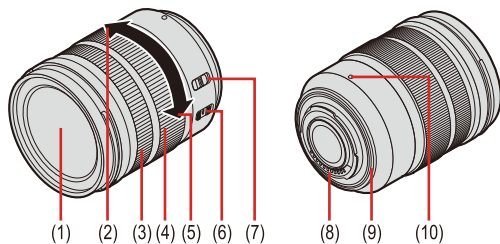

H-FS12060

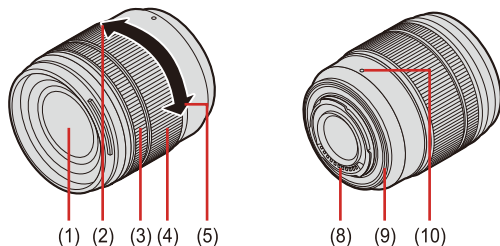

- (1) Lens surface
- (2) Tele
- (3) Focus ring (→ [Adjust the focus.: 169](#))
- (4) Zoom ring (→ [Recording with Zoom: 174](#))
- (5) Wide
- (6) O.I.S. switch
- (7) [AF/MF] switch

- When either the [AF/MF] switch of the lens or the setting of the camera is set to [MF], Manual Focus (MF) is enabled.

- (8) Contact point
- (9) Lens mount rubber
- (10) Lens fitting mark (→ [Attaching a Lens: 63](#))

Viewfinder/Monitor Displays

At the time of purchase, the viewfinder/monitor displays the following icons.

- For information about the icons other than those described here (→ [Monitor/Viewfinder Displays: 714](#))

Viewfinder

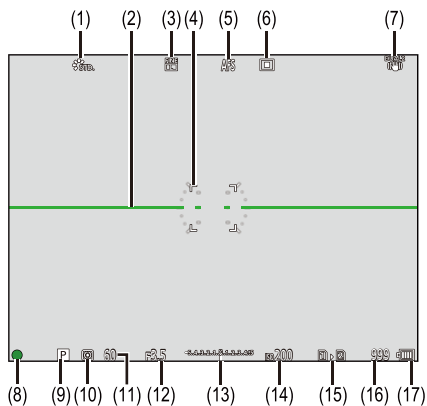

Monitor

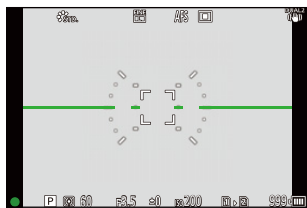

- (1) Photo Style
- (2) Level gauge
- (3) Picture quality/Picture size
- (4) AF area
- (5) Focus mode
- (6) AF mode
- (7) Image stabilizer
- (8) Focus (green)/Recording state (red)
- (9) Recording mode
- (10) Metering mode
- (11) Shutter speed
- (12) Aperture value
- (13) Exposure compensation value/
Manual Exposure Assist
- (14) ISO sensitivity
- (15) Card slot/Double card slot function
- (16) Number of still images that can be taken/
Number of pictures that can be taken continuously
- (17) Battery indication

- Press [>] to switch between display/hide of the level gauge.

2. Getting Started

- [Attaching a Shoulder Strap: 41](#)
- [Charging the Battery: 43](#)
- [Inserting Cards \(Optional\): 59](#)
- [Attaching a Lens: 63](#)
- [Adjusting the Monitor Direction and Angle: 69](#)
- [Setting the Clock \(When Turning On for the First Time\): 70](#)

Attaching a Shoulder Strap

Attach a shoulder strap to the camera with the following procedure to prevent it from dropping.

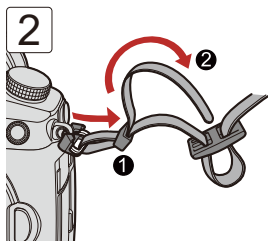
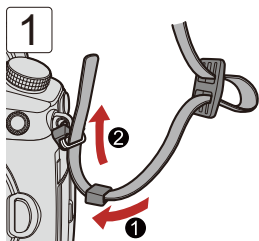

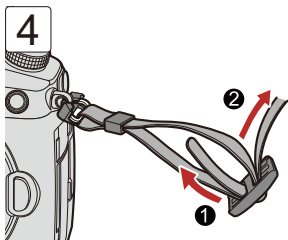
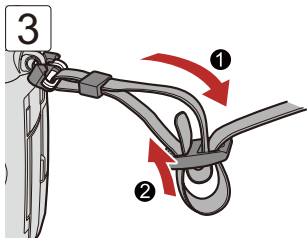

- Pull the shoulder strap and check that it will not come out.
- Attach the opposite end of the shoulder strap with the same procedure.
- Use the shoulder strap around your shoulder.
 - Do not wrap the strap around your neck.
It may result in injury or accident.
- Do not leave the shoulder strap where an infant can reach it.
 - It may result in an accident by mistakenly wrapping around the neck.

Charging the Battery

- [Charging with the Charger: 44](#)
- [Battery Insertion: 47](#)
- [Inserting a Battery into the Camera for Charging: 49](#)
- [Using the Camera While Supplying It with Power \(Supplying Power/Charging\): 53](#)
- [Notifications Regarding Charging/Power Supply: 55](#)
- [\[Power Save Mode\]: 57](#)

You can charge the battery either using the supplied charger, or in the camera body.

You can also turn on the camera and supply power from an electrical outlet.

- The battery that can be used with the camera is DMW-BLK22/DMW-BLF19. (As of May 2021)
 - You can also use DMW-BLF19 (optional), but since it has a smaller battery capacity than DMW-BLK22 (supplied/optional), it is recommended to use DMW-BLK22 (supplied/optional).

- The battery is not charged at the time of purchase. Charge the battery before use.

Charging with the Charger

Charging time: Approx. 230 min

- Use the supplied charger and AC adaptor.
- The indicated charging time is for when the battery has been discharged completely. The charging time may vary depending on how the battery has been used. The charging time for the battery in hot/cold environments or a battery that has not been used for a long time may be longer than normal.

- **Use the products supplied with the camera for charging.**
- Use the charger indoors.

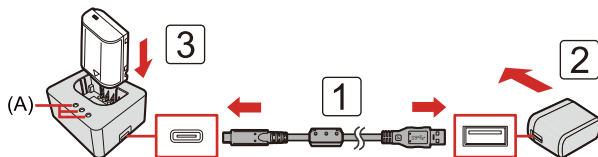

1 Connect the charger and the AC adaptor with the USB connection cable.

- Check the direction of the terminals and plug in/out straight holding onto the plug.
(Inserting at an angle can deform the terminal and cause malfunction.)

2 Connect the AC adaptor to an electrical outlet.

3 Insert the battery.

- The [CHARGE] light (A) blinks and charging begins.

- Do not use any other USB connection cables except the supplied one.
This may cause malfunction.
- Do not use any other AC adaptors except the supplied one.
This may cause malfunction.

❖ [CHARGE] Light Indications

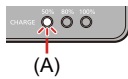
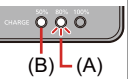
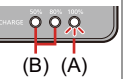
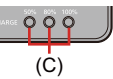
Charging status	0 % to 49 %	50 % to 79 %	80 % to 99 %	100 %
[CHARGE] light	 <p>(A)</p>	 <p>(B) (A)</p>	 <p>(B) (A)</p>	 <p>(C)</p>

(A) Blinking

(B) On

(C) Off

- When the battery is inserted while the charger is not connected to the power source, the charging lights turn on for a certain period to allow you to confirm the battery level.

- After charging, disconnect the power source connection and remove the battery.
- If the [50%] light is blinking quickly, then charging is not occurring.
 - The temperature of the battery or surroundings is either too high or too low. Try charging at an ambient temperature between 10 °C and 30 °C (50 °F and 86 °F).
 - The terminals of the charger or the battery are dirty. Remove the connection to the power source, and wipe with a dry cloth.

Battery Insertion

- Always use genuine Panasonic batteries (DMW-BLK22/DMW-BLF19).
 - DMW-BLF19 (optional) has a smaller battery capacity than DMW-BLK22.
- If you use other batteries, we cannot guarantee the quality of this product.

- Check that this unit is turned off.

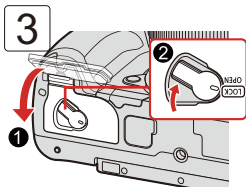
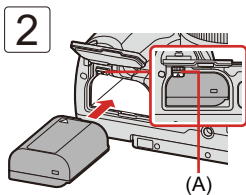
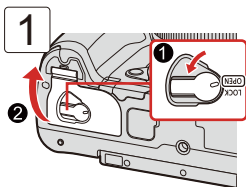

- Check that the lever (A) is holding the battery in place.

❖ Removing the Battery

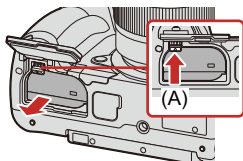

- 1 Set the camera on/off switch to [OFF].
- 2 Open the battery door.
 - Check that the card access light turned off and then open the battery door.
(→ [Card Access Indications: 60](#))
- 3 Push the lever (A) in the direction of the arrow and then remove the battery.

- Ensure that no foreign objects are adhering to the inner side (rubber seal) of the battery door.
- Remove the battery after use.
(The battery will drain if left inserted in the camera for a long period of time.)
- The battery becomes warm after use, during charging, and immediately after charging.
The camera also becomes warm during use. This is not a malfunction.
- Be careful when removing the battery as the battery will jump out.

Inserting a Battery into the Camera for Charging

Charging time: Approx. 220 min

- Using the camera body and the supplied AC adaptor.
- The indicated charging time is for when the battery has been discharged completely. The charging time may vary depending on how the battery has been used. The charging time for the battery in hot/cold environments or a battery that has not been used for a long time may be longer than normal.

- **Use the products supplied with the camera for charging.**
- The battery in the Battery Grip (DMW-BGGH5:optional) cannot be charged.

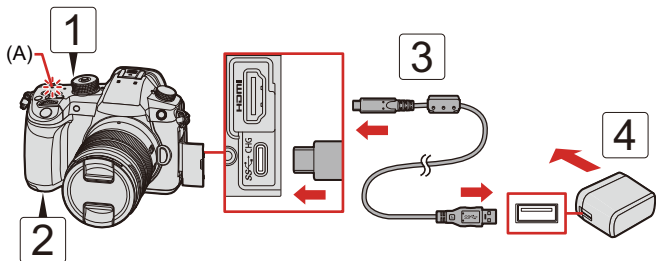

- 1 Set the camera on/off switch to [OFF].**
- 2 Insert the battery into the camera.**
- 3 Connect the camera USB port and the AC adaptor using the USB connection cable.**
 - Check the direction of the terminals and plug in/out straight holding onto the plug.
(Inserting at an angle can deform the terminal and cause malfunction.)
- 4 Connect the AC adaptor to an electrical outlet.**
 - The charging light (A) blinks red and charging begins.

❖ Charging light Indications

- (A) Charging light (red)
On: Charging in progress
Off: Charging complete
Flashing: Charging error

- You can also charge the battery by connecting a USB device (PC, etc.) and the camera with the USB connection cable.
In that case, charging may take a while.
- Do not use any other USB connection cables except the supplied USB connection cables.
This may cause malfunction.
- Do not use any other AC adaptors except the supplied one.
This may cause malfunction.
- After charging, disconnect the connection to the power source.
- While the charging light is blinking red, charging is not possible.
 - The temperature of the battery or surroundings is either too high or too low.
Try charging at an ambient temperature between 10 °C and 30 °C (50 °F and 86 °F).
 - The terminals of the battery are dirty.
Remove the battery and wipe off the dirt with a dry cloth.
- Even when the camera on/off switch is set to [OFF] thus turning the camera off, it consumes power.
When the camera will not be used for a long time, remove the power plug from the electrical outlet in order to save power.

❖ Power Supply

When a battery is inserted in the camera then charged with the AC adaptor (supplied), and the camera is turned on, you can record while supplying power.

- [] is displayed in the screen while power is being supplied.

- You can also supply power by using a USB connection cable to connect the camera and a USB device (PC, etc.).
- The battery cannot be charged while power is being supplied.
- Turn off the camera before connecting or disconnecting the AC adaptor.
- Remaining charge in the battery may decrease depending on usage conditions. When the battery level is depleted, the camera will turn off.
- If the temperature of the camera rises, [] may be displayed, recording may stop, and some functions may become unavailable temporarily. Wait until the camera cools down.
- Depending on the power supply capabilities of the connected device, it may not be possible to supply power.

Using the Camera While Supplying It with Power (Supplying Power/Charging)

Since this camera and the items supplied with the battery charger (DMW-BTC15: optional) are compatible with USB PD (USB Power Delivery), you can charge while the camera is being supplied with power. Connect the USB connection cable, AC adaptor and AC cable of the battery charger (DMW-BTC15: optional) to the camera.

Charging time: Approx. 170 min

- Use the camera body and the AC adaptor supplied with the battery charger (DMW-BTC15: optional). The camera is turned off.
- The indicated charging time is for when the battery has been discharged completely. The charging time may vary depending on how the battery has been used. The charging time for the battery in hot/cold environments or a battery that has not been used for a long time may be longer than normal.

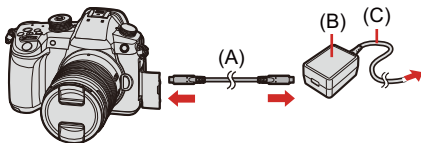

(A) USB connection cable

(B) AC adaptor

(C) AC cable

- Insert the battery into the camera.
- Connect using the USB connection cable of the battery charger (DMW-BTC15: optional).
- When the camera is on, charging will take longer than when the camera is off.

- Even when connecting with devices that support USB PD, you may not be able to charge while using the camera.
- If connecting with devices (PC, etc.) that do not support USB PD and turning the camera on, then this will supply power only.
- Turn off the camera before plugging or unplugging the power plug.
- Remaining charge in the battery may decrease depending on usage conditions. When the battery level is depleted, the camera will turn off.
- Depending on the power supply capabilities of the connected device, it may not be possible to supply power.

Notifications Regarding Charging/Power Supply

❖ Power Indications

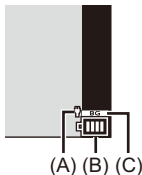

- (A) USB connection cable supplying power
 (B) Battery indication
 (C) Using the battery in the Battery Grip

	75 % or higher
	50 % to 74 %
	25 % to 49 %
	24 % or below
 Blinking in red	Low battery (The status indicator also blinks.) <ul style="list-style-type: none"> • Charge or replace the battery.

- The battery level indicated on the screen is approximate.

- To ensure that safe products are used, we recommend that a genuine Panasonic battery pack is used.

There is a possibility that other battery packs may lead to fire or explosion.

Please be advised that we are not liable for any accident or failure occurring as a result of use of a counterfeit battery pack.

- Do not leave any metal items (such as clips) near the contact areas of the power plug.

Otherwise, a fire and/or electric shocks may be caused by short-circuiting or the resulting heat generated.

- Do not use the AC adaptor or USB connection cables on other devices.

This may cause a malfunction.

- Do not use USB extension cables or USB conversion adaptors.

- The battery can be charged even when it still has some charge left, but it is not recommended that the battery charge be frequently topped up while the battery is fully charged.

(Since characteristic swelling may occur.)

- If there is a power outage or other problem with the electrical outlet, then charging may not complete successfully.

Reconnect the power plug.

- Do not connect to keyboard or printer USB ports, or to USB hubs.

- If the connected PC enters sleep status, then charging/power supply may stop.

[Power Save Mode]

This is a function to automatically turn the camera to sleep (power save) status or turn off the viewfinder/monitor if no operation is performed for a set time. Reduces battery consumption.



➔ [] ➔ [] ➔ **Select [Power Save Mode]**

[Sleep Mode]	Sets the amount of time until the camera is put to sleep.
[Sleep Mode(Wi-Fi)]	Sets the camera to sleep 15 minutes after being disconnected from Wi-Fi.
[Auto LVF/ Monitor Off]	Sets the amount of time it takes for the viewfinder/monitor to turn off. (The camera is not turned off.)
[Power Save LVF Shooting]	Puts the camera to sleep when the recording screen is being displayed on the monitor when automatic viewfinder/monitor switching is active.
	[Time to Sleep] Sets the amount of time until the camera is put to sleep.
	[Method of Activation] Sets the screen where the camera is put to sleep. [Only Control Panel]: Puts the camera to sleep only when the control panel (➔ Switching the Display Information: 88) is displayed. [While Recording Standby]: Puts the camera to sleep from any screen during recording standby.

- To recover from [Sleep Mode], [Sleep Mode(Wi-Fi)], or [Power Save LVF Shooting], perform one of the following operations:
 - Press the shutter button halfway.
 - Set the camera on/off switch to [OFF] and then [ON] again.
- To recover from [Auto LVF/Monitor Off], press any button.

- [Power Save Mode] is not available in the following cases:
 - While connected to a PC or printer
 - During video recording/video playback
 - When recording with [6K/4K Pre-Burst]
 - During a [Time Lapse Shot]
 - When recording with [Stop Motion Animation] (when [Auto Shooting] is set)
 - When recording with [Multiple Exposure]
 - When recording with [Focus Transition]
 - During a [Slide Show]
 - During HDMI output for recording

Inserting Cards (Optional)

- [Formatting Cards \(Initialization\): 62](#)

This camera supports the double card slot function.

When two cards are used, relay recording, backup recording, and allocation recording are available.

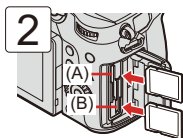
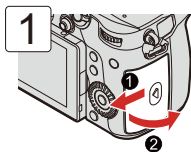

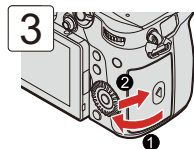

(A) Card slot 1

(B) Card slot 2



- Match the orientation of the cards as shown in the figure and then insert them firmly until they click.

- You can set the way to record to card slots 1 and 2:

[] ⇒ [] ⇒ [Double Card Slot Function] (⇒ [\[Double Card Slot Function\]: 118](#))

❖ Card Access Indications

The card access light (C) turns on while the card is being accessed.

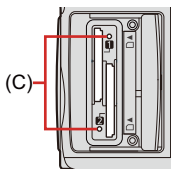

- **Do not perform the following operations during access.**

The camera may operate incorrectly or the card and recorded images may be damaged.

- Turn off the camera.
- Remove the battery or card or disconnect the power plug.
- Subject the camera to vibration, impacts, or static electricity.

❖ Removing a Card

- 1 Open the card door.
- 2 Push the card until it clicks and then pull the card out straight.

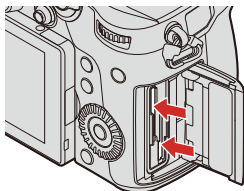

- The card may be warm just after the camera has been used.

Formatting Cards (Initialization)

Format the cards with the camera before use in order to ensure optimal card performance.

- **When a card is formatted, all of the data stored in the card is erased and cannot be restored.**



Save a backup of necessary data before formatting the card.



⇒ [] ⇒ [] ⇒ **Select [Card Format]**

Settings: [Card Slot 1]/[Card Slot 2]

- Do not turn off the camera or perform another operation during formatting.
- Take care not to turn off the camera while formatting is in progress.
- If the card has been formatted with a PC or other device, format it again with the camera.
- You can format the card while keeping the camera settings information stored on the card:

[] ⇒ [] ⇒ [Save/Restore Camera Setting] ⇒ [Keep Settings While Format] (⇒ [\[Save/Restore Camera Setting\]: 505](#))

Attaching a Lens

- [Attaching a Lens Hood: 66](#)

- Check that the camera on/off switch is set to [OFF].
- Change the lens in a location where there is not a lot of dirt and dust. If dirt or dust gets on the lens (→ [Dirt on the Image Sensor: 752](#))
- Change the lens while the lens cap is attached.

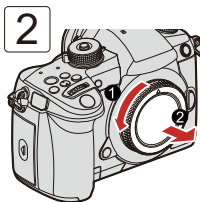
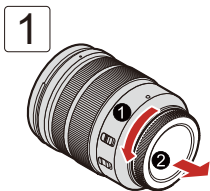

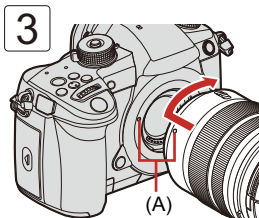

(A) Lens fitting mark

- When you have attached a lens that does not have a communication function with this camera, after turning on the camera, a message asking for confirmation of the lens information is displayed. You can register the focal length for the lens when you select [Yes]. (→[[Lens Information](#)]: 249)
- Insert the lens straight in.
Inserting this at an angle to attach it may damage the camera lens mount.

❖ Removing a Lens

- 1 While pressing the lens release button (B), rotate the lens in the direction of the arrow until it stops and then remove it.

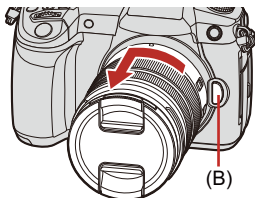

- After removing the lens, be sure to attach the body cap and the lens rear cap.

Attaching a Lens Hood

For recording against strong backlight, a lens hood can reduce the inclusion of unwanted light in images and drop in contrast resulting from the irregular reflection of light that occurs within the lens.

It allows you take more beautiful pictures by cutting out excess light.

When attaching the lens hood (flower shape) supplied with the interchangeable lens (H-ES12060/H-FS12060)

Hold the lens hood by placing your fingers as shown in the figure.

- Do not hold the lens hood in such a way that it will become bent.



- 1 Align mark (A) (●) on the lens hood with the mark on the tip of the lens.**

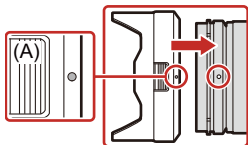

- 2 Rotate the lens hood in the direction of the arrow to align mark (B) (◐) on the lens hood with the mark on the tip of the lens.**

- Attach the lens hood by rotating it until it clicks.

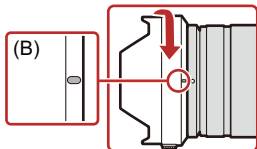

❖ Removing the Lens Hood (H-ES12060)

- 1 While pressing the lens hood button (C), rotate the lens hood in the direction of the arrow and then remove it.

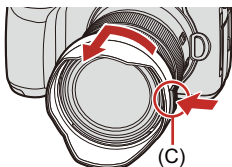

❖ When carrying the camera

- The lens hood can be attached in the reverse direction.

Example: H-ES12060

- 1 Align mark (B) () on the lens hood with the mark on the tip of the lens.
- 2 Attach the lens hood by rotating it in the direction of the arrow until it clicks.

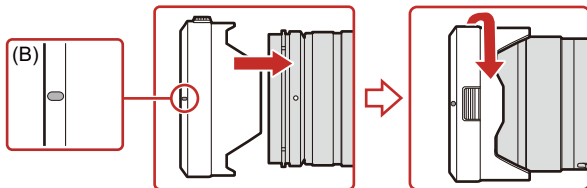

Adjusting the Monitor Direction and Angle

At the time of purchase, the monitor is stowed in the camera body.

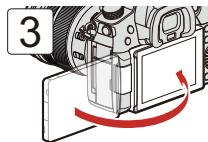
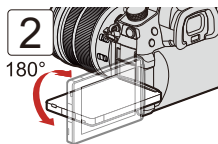
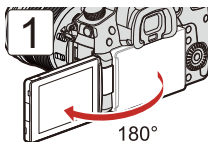

- The angles of adjustment are guides only.
- Do not apply an excessive force to the monitor. This may cause damage or malfunction.
- When not using the camera, close the monitor with the monitor surface facing in.

Setting the Clock (When Turning On for the First Time)

- Clock Set: 70

When you turn the camera on for the first time, a screen to set the time zone and clock appears.

Be sure to set these settings before use to ensure images are recorded with the correct date and time information.

Clock Set

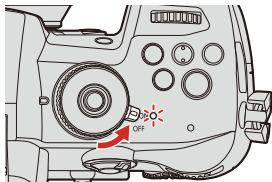

1 Set the camera on/off switch to [ON].

- When the camera is turned on, the status indicator lights up.
- If the language select screen is not displayed, proceed to Step 4.





2 When [Please set the language] appears, press or .

3 Set the language.

- Press ▲▼ to select the language and then press  or .

4 When [Please set the time zone] appears, press or .

5 Set the time zone.

- Press ◀▶ to select the time zone and then press  or .
- If you are using Daylight Savings [], press ▲. (The time will move forward by 1 hour.)
To return to the normal time, press ▲ again.



(A)

(A) Time difference from GMT (Greenwich Mean Time)

6 When [Please set the clock] appears, press or .



7 Set the clock.

◀▶: Select an item (year, month, day, hour, minute, or second).

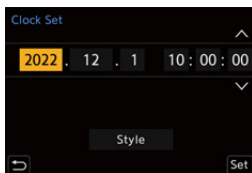
▲▼: Select a value.



To set the display order (B) and time display format (C)

- Press ▶◀ to select the time zone [Style] and then press  or , the screen for setting the display order and time display format appears.

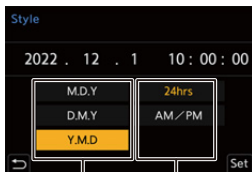





(B)

(C)

8 Confirm your selection.

- Press  or .

9 When [The clock setting has been completed.] appears, press or .

- If the camera is used without setting the clock, it will be set to “0:00:00 1/1/2021”.
- Clock settings are maintained for approx. 3 months using the built-in clock battery even without the battery.
(Leave the fully-charged battery in the camera for approx. 24 hours to charge the built-in battery.)
- [Time Zone] and [Clock Set] can be changed from the menu:
 - [] ⇒ [] ⇒ [Time Zone] (→ [\[Time Zone\]: 594](#))
 - [] ⇒ [] ⇒ [Clock Set]

3. Basic Operations

- Basic Recording Operations: 75
- Camera Setting Operations: 80
- Monitor/Viewfinder Display Settings: 85
- Quick Menu: 91
- Control Panel: 93
- Menu Operation Methods: 95
- Intelligent Auto Mode: 101
- Recording Using Touch Functions: 108

Basic Recording Operations

- [How to Hold the Camera: 75](#)
- [Recording: 77](#)
- [Selecting the Recording Mode: 79](#)

How to Hold the Camera

To minimize camera shake, hold the camera so that it will not move during recording.

Hold the camera with both hands, keep your arms still at your side, and stand with your feet shoulder width apart.

- Hold the camera firmly by wrapping your right hand around the camera grip.
- Support the lens from below with your left hand.
- Do not cover the AF assist light (A) or microphone (B) with your fingers or other objects.

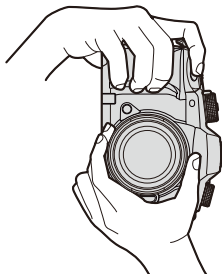
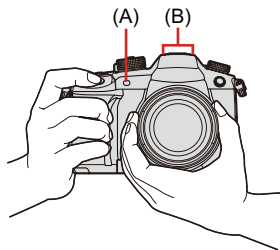

❖ Vertical Orientation Detection Function



This function detects when pictures were recorded with the camera held vertically orientated.

With the default settings, pictures are automatically played back vertically oriented.

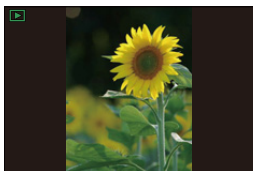
- If you set [Rotate Disp.] to [OFF], pictures will be played back without being rotated.
(→[Rotate Disp.]: 600)



- When the camera is tilted significantly up or down, the vertical orientation detection function may not work correctly.
- You can set whether or not to record the camera's vertical orientation information during video recording.

[] ⇒ [] ⇒ [Vertical Position Info (Video)] (→[Vertical Position Info (Video)]: 582)

Recording

1 Adjust the focus.

- Press the shutter button halfway (press it gently).

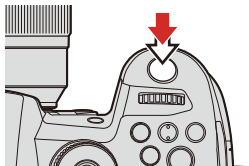

- The aperture value (A) and shutter speed (B) are displayed. (When the correct exposure cannot be obtained, the indications blink in red.)
- Once the subject is in focus, the focus icon (C) lights. (When the subject is not in focus, the indication blinks.)
- You can also perform the same operation by pressing [AF ON].

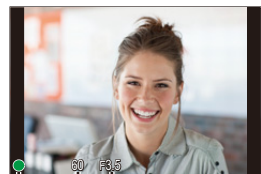

(C) (B) (A)

2 Start recording.

- Press the shutter button fully (press it further).
- When recording videos, press the video rec. button. (→ [10. Recording Videos: 324](#))

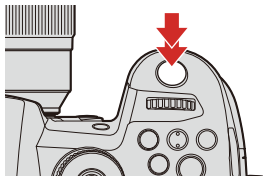

- Recorded pictures can be displayed automatically by setting [Auto Review] of the [Custom] ([Monitor / Display (Photo)]) menu. You can also change the picture display duration to your preferred setting. (→ [\[Auto Review\]: 564](#))
- **With the default settings, you cannot take a picture until the subject is brought into focus.**
If you set [Focus/Shutter Priority] in the [Custom] ([Focus/Shutter]) menu to [BALANCE] or [RELEASE], you will be able to take a picture even when the subject is not in focus. (→ [\[Focus/Shutter Priority\]: 553](#))

Selecting the Recording Mode

- 1 Press the mode dial lock button (1) to release the lock.**
 - The dial is locked if the mode dial lock button is depressed. Each press locks/unlocks the dial.
- 2 Rotate the mode dial (2) and adjust the recording mode.**

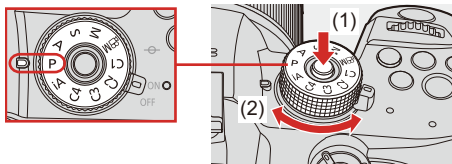

[iA]	Intelligent Auto mode (→ Intelligent Auto Mode: 101)
[P]	Program AE mode (→ Program AE Mode: 253)
[A]	Aperture-Priority AE mode (→ Aperture-Priority AE Mode: 257)
[S]	Shutter-Priority AE mode (→ Shutter-Priority AE Mode: 260)
[M]	Manual Exposure mode (→ Manual Exposure Mode: 263)
[M]	Creative Video mode (→ Creative Video Mode: 330)
[C1]/[C2]/[C3]/ [C4]	Custom mode (→ Custom Mode: 498)

Camera Setting Operations

When changing the camera settings, operate the camera using the following operation parts.

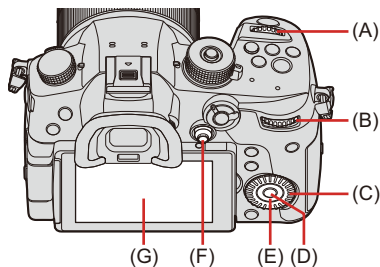

- (A) Front dial
- (B) Rear dial
- (C) Control dial
- (D) [MENU/SET] button
- (E) Cursor buttons
- (F) Joystick
- (G) Touch screen

❖ Front Dial/Rear Dial

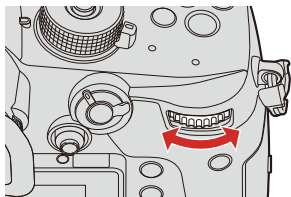
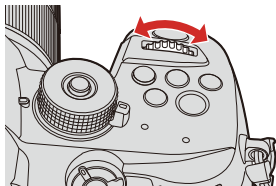

Rotate:

Selects an item or numeric value.

❖ Control Dial

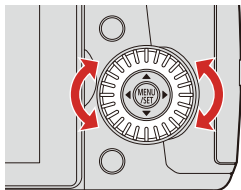

Rotate:

Selects an item or numeric value.

❖ Cursor Buttons

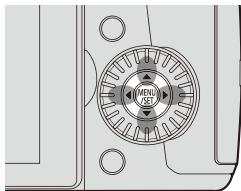

Press:

Selects an item or numeric value.

❖ [MENU/SET] Button

Press:

Confirms a setting.

- Displays the menu during recording and playback.

❖ Joystick

The joystick can be operated in 4 directions by tilting it up, down, left and right and by pressing the center part.

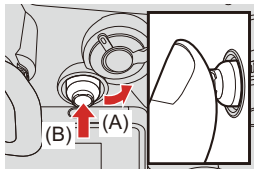



(A) **Tilt:** Selects an item or numeric value, or moves a position.

- Place your finger on the center of the joystick before tilting. The joystick may not work as expected when the sides are pressed.

(B) **Press:** Confirms a setting.

- You can register [Operation Lock] to the Fn button to disable the operations of operating parts:

[] ⇒ [] ⇒ [Fn Button Set] ⇒ [Setting in REC mode] ⇒ [Operation Lock]
(→ [Fn Buttons: 471](#))

❖ Touch Screen

Operations can be performed by touching the icons, slide bars, menus, and other items displayed on the screen.

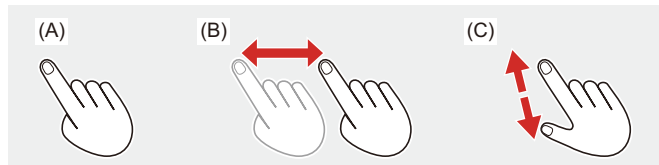

(A) Touch

Operation of touching and then lifting your finger from the touch screen.

(B) Drag

Operation of moving a finger while it touches the touch screen.

(C) Pinch (widen/narrow)

Operations of widening the distance between two fingers (pinch out) and narrowing the distance between two fingers (pinch in) while they are touching the touch screen.

- If you will use a commercially available monitor protection sheet, observe the precautions for the sheet.

(Visibility and operability may be impaired depending on the type of monitor protection sheet.)

- Touch operations can be disabled:

[] ⇒ [] ⇒ [Touch Settings] (→[Touch Settings]: 559)

Monitor/Viewfinder Display Settings

- [Setting the Viewfinder: 85](#)
- [Switching Between the Monitor and Viewfinder: 86](#)
- [Switching the Display Information: 88](#)

Setting the Viewfinder

❖ Adjusting the Viewfinder Diopter

- 1 Rotate the diopter adjustment dial while looking through the viewfinder.
 - Adjust until you can clearly see the text on the viewfinder.

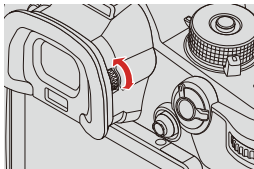

Switching Between the Monitor and Viewfinder

With the default settings, automatic viewfinder/monitor switching is set. When you look through the viewfinder, the eye sensor (A) works and the camera switches from monitor display to viewfinder display.

You can switch to viewfinder display or monitor display with [LVF] button (B).



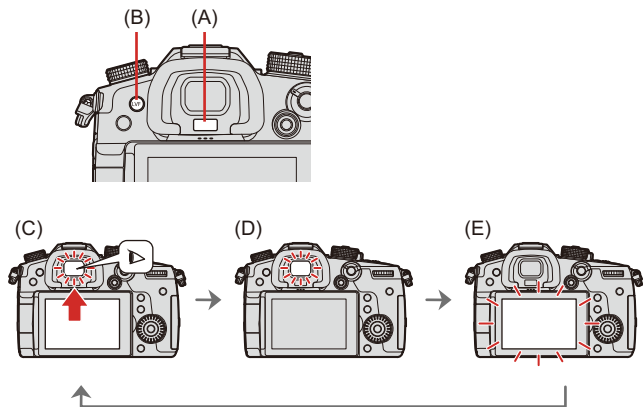

1 Press [LVF].



(C) Automatic viewfinder/monitor switching

(D) Viewfinder display

(E) Monitor display

- The eye sensor may not work correctly due to the shape of eyeglasses, the way the camera is held, or bright light shining around the eyepiece.
- During video playback or slide show, automatic viewfinder/monitor switching does not work.
- To focus when looking through the viewfinder:
[] ⇒ [] ⇒ [Eye Sensor AF] (→ [\[Eye Sensor AF\]: 557](#))
- The sensitivity of the eye sensor can be changed:
[] ⇒ [] ⇒ [Eye Sensor] (→ [\[Eye Sensor\]: 587](#))

Switching the Display Information

1 Press [DISP.].

- The display information is switched.

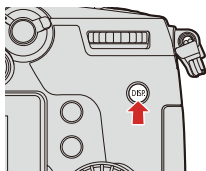

❖ Recording Screen

Monitor

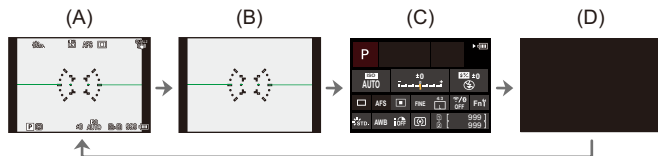

- (A) With information
- (B) Without information
- (C) Control panel
- (D) Turned off (black)

Viewfinder

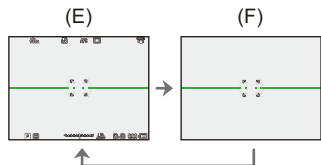

(E) With information

(F) Without information

- Press [] to switch between display/hide of the level gauge.
This can also be set by using [Level Gauge]. (→[\[Level Gauge\]: 573](#))
- Control panel operation (→[Control Panel: 93](#))
- You can hide the control panel and black screen:
[] ⇒ [] ⇒ [Show/Hide Monitor Layout] (→[\[Show/Hide Monitor Layout\]: 574](#))
- The display can be changed so that live view and display information do not overlap:
[] ⇒ [] ⇒ [LVF/Monitor Disp. Set] (→[\[LVF/Monitor Disp. Set\]: 570](#))

❖ Playback Screen

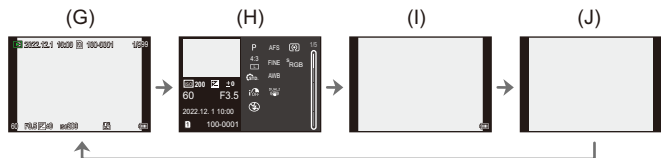

(G) With information

(H) Detailed information display*1

(I) Without information

(J) Display without blinking highlights*2

*1 Pressing ▲▼ switches the display information. (→ [Detailed information display: 731](#))

*2 This is a screen without blinking highlights display that is shown when [Blinking Highlights] of the [Custom] ([Monitor / Display (Photo)]) is set to [ON].
In other than this screen, overexposed parts of the screen will blink. (→ [\[Blinking Highlights\]: 571](#))

Quick Menu

This menu enables you to quickly set functions that are frequently used during recording without calling up the menu screen. You can also change the Quick menu display method and the items to display.

1 Display the Quick menu.

- Press [Q].

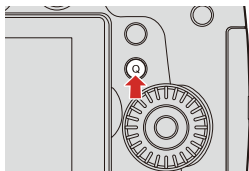

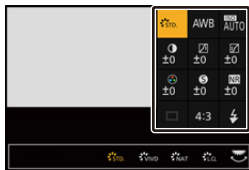

2 Select a menu item.

- Press ▲▼◀▶.
- Selection is also possible by rotating .
- Selection is also possible by touching a menu item.





3 Select a setting item.

- Rotate  or .
- Selection is also possible by touching a setting item.



4 Close the Quick menu.

- Press the shutter button halfway.
- You can also close the menu by pressing [Q].

- Some items cannot be set depending on the recording mode or camera settings.
- The Quick menu can be customized:
[] ⇒ [] ⇒ [Q.MENU Settings] (⇒ [Quick Menu Customization: 490](#))

Control Panel

This screen allows you to view the current recording settings on the monitor. You can also touch the screen to change the settings.

In the [P] mode (Creative Video mode), the display changes to one especially for video. (→ [Control Panel \(Creative Video mode\): 725](#))

1 Display the control panel.

- Press [DISP.] several times.

2 Touch the items.

- The setting screens for each of the items are displayed.

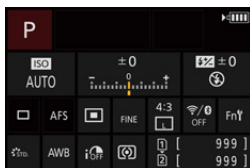

3 Change the setting.

Example) Changing the AF mode

- Touch the setting item.
- Refer to the pages explaining each item for information on how to change the settings.

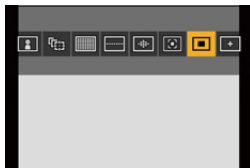

4 Touch [Set].

Steps **2** to **4** can also be changed using the following operations.

- 1 Press ▲▼◀▶ to select an item.
 - Selection is also possible by rotating 🌞 or ⚙️.
- 2 Rotate 🌞 to change the settings values.

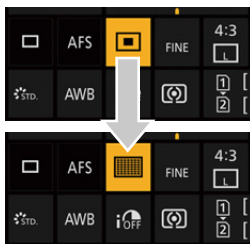

- Some items cannot be set depending on the recording mode or camera settings.

Menu Operation Methods

- [Menu operation: 95](#)
- [\[Reset\]: 100](#)

In this camera, the menu is used for setting a wide variety of functions and performing camera customizations.

Menu operations can be performed using the cursors, joystick, dial, or by touch.

Menu operation

Configuration and operation parts of the menu

The menu can be operated by pressing ◀▶ to move between menu screens.

Use the operation parts indicated below to operate the main tab, the sub tab, the page tab, and menu items without moving to the corresponding menu levels.

- You can also operate by touching the icons, menu items, and setting items.

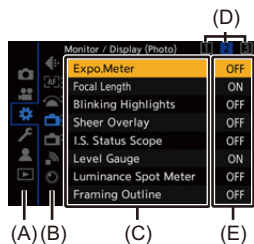





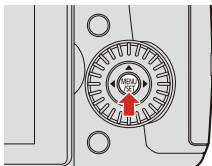

- (A) Main tab ([Q] button)
- (B) Sub tab (☀)
- (C) Menu item (☀)
- (D) Page tab (☀)
- (E) Setting item

1 Display the menu.

- Press .





2 Select a main tab.

- Press   to select a main tab and then press .
- You can also perform the same operation by rotating  to select the main tab and then pressing  or .



3 Select a sub tab.



- Press ▲▼ to select a sub tab and then press ►.
- You can also perform the same operation by rotating  to select the sub tab and then pressing  or .



- If there are page tabs (F), then after the page tabs have finished switching, the next sub tab is switched to.







4 Select a menu item.

- Press ▲▼ to select a menu item and then press ►.
- You can also perform the same operation by rotating  to select the menu item and then pressing  or .



5 Select a setting item and then confirm your selection.

- Press ▲▼ to select a setting item and then press  or .
- You can also perform the same operation by rotating  to select the setting item and then pressing  or .

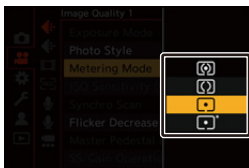

6 Close the menu.

- Press the shutter button halfway.
- You can also close the menu by pressing [>] several times.

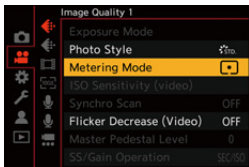

- For details about menu items, refer to Menu Guide. (→ [14. Menu Guide: 507](#))



❖ Displaying Descriptions About Menu Items and Settings

If you press [DISP.] while a menu item or setting item is selected, a description about the item is displayed on the screen.



❖ Grayed Out Menu Items

Menu items that cannot be set are displayed grayed out.

If you press  or  while a grayed out menu item is selected, the reason why it cannot be set is displayed.

The reason why a menu item cannot be set may not be displayed depending on the menu item.

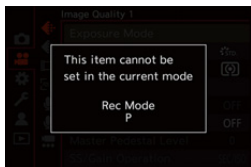

[Reset]

Return each of the following settings to the default setting:

- Recording settings
- Network settings (settings of [Wi-Fi Setup], [Streaming Setup] and [Bluetooth])
- Setup and custom settings (other than [Wi-Fi Setup], [Streaming Setup] and [Bluetooth])

 ⇒  ⇒  ⇒ **Select [Reset]**

- If the setup and custom settings are reset, the [Playback] menu is also reset.
- If the setup and custom settings are reset, [Lens Information] in [Image Stabilizer] in the [Photo] ([Others (Photo)]) menu/[Video] ([Others (Video)]) menu is also returned to the default setting.
- The folder numbers and clock settings are not reset.
- List of default settings and settings that can be reset (→ [List of Default Settings/Custom Saving/Settings Available for Copying: 771](#))

Intelligent Auto Mode



The [iA] mode (Intelligent Auto mode) can record images using settings automatically selected by the camera.

The camera detects the scene to set the optimal recording settings automatically to match the subject and recording conditions.

1 Set the mode dial to [iA].

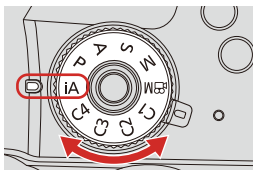

2 Aim the camera at the subject.

- When the camera detects the scene, the recording mode icon changes.

(Automatic Scene Detection)



3 Adjust the focus.

- Press the shutter button halfway.
- Once the subject is in focus, the focus icon lights.
(When the subject is not in focus, the indication blinks.)
- [] of the AF mode works and the AF area is displayed aligned to any humans.

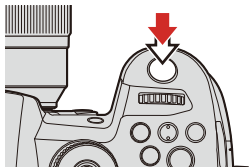

4 Start recording.

- Press the shutter button fully.

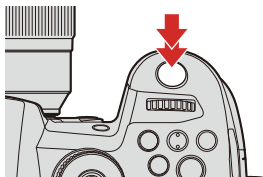

- Backlight compensation operates automatically to prevent subjects from appearing dark when there is a backlight.

❖ Types of Automatic Scene Detection

📷: Scenes detected during picture taking

🎥: Scenes detected during video recording



📷 🎥: i-Portrait

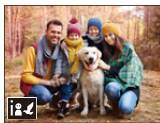

📷 🎥: i-Portrait & Animal^{*1}



📷 🎥: i-Scenery



📷 🎥: i-Macro



📷: i-Night Portrait^{*2}



📷: i-Night Scenery

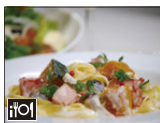

📷: i-Food



📷: i-Sunset



📷: i-Low Light

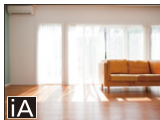

📷 👤 : iA

- *1 Detected when animal detection is enabled.
- *2 Detected when using an external flash.

- If none of the scenes are applicable, recording is with [iA] (standard setting).
- Different scene types may be selected for the same subject depending on the recording conditions.

❖ AF Mode

1 Changing the AF mode.

- Each press of [>] changes the AF mode.

/ ([Human Detect AF]/[Human/Animal Detect AF])

The camera detects a person's face, eyes, and body (entire body, upper half of the body, or head) and adjusts the focus.

When animal detection is enabled, animals, such as birds, canines (including wolves), and felines (including lions) will also be detected.

- Each press of  switches the person, animal or eye to be brought into focus. It cannot be switched by touching.
- Animal detection will maintain the enable/disable setting selected during other than [iA] mode.



([Tracking])

When the focus mode is set to [AFC], the AF area follows the movement of the subject, maintaining focusing.

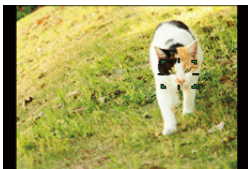

- 1 Aim the AF area over the subject and then press and hold the shutter button halfway.
 - The camera will track the subject while the shutter button is pressed halfway or fully.



- For information about AF modes (→ [\[Human Detect AF\]/\[Human/Animal Detect AF\]: 138](#), [\[Tracking\]: 143](#))

Flash

When recording using a flash, the camera switches to the appropriate flash mode for the recording conditions.

When Slow Sync. (, ), be careful with regard to camera shake because the shutter speed becomes slow.

- For information about external flashes (→ [Using an External Flash \(Optional\): 304](#))

Recording Using Touch Functions

- [Touch AF/Touch Shutter: 108](#)
- [Touch AE: 111](#)

Touch AF/Touch Shutter



Touch functions allow you to focus on the point that you touch, release the shutter, etc.

- With the default settings, the Touch Tab is not displayed.
Set [Touch Tab] to [ON] in [Touch Settings] in the [Custom] ([Operation]) menu.
(→ [\[Touch Settings\]: 559](#))

1 Touch [◀].

2 Touch the icon.

- The icon switches each time you touch it.



☑ AF (Touch AF)

Focus on the Touched Position.



☑ (Touch Shutter)

Record with focus on the point touched.

☒ (OFF)

3 (When set to anything other than OFF) Touch the subject.



- When the Touch Shutter fails, the AF area first turns red and then disappears.
- Refer to “[Operations on the AF area movement screen](#)” for information about operations to move the AF area. (→[Operations on the AF area movement screen: 142](#))
- It is also possible to optimize the focus and brightness on the touched position:
[] ⇒ [] ⇒ [Touch Settings] ⇒ [Touch AF] ⇒ [AF+AE] (→[Moving the AF Area by Touch: 161](#))

Touch AE



This function adjusts the brightness according to a touched position.

When a subject's face appears dark, you can make the screen brighter to match the face.

- With the default settings, the Touch Tab is not displayed.
Set [Touch Tab] to [ON] in [Touch Settings] in the [Custom] ([Operation]) menu.
(→[Touch Settings]: 559)

1 Touch [].

2 Touch [].

- The Touch AE settings screen appears.

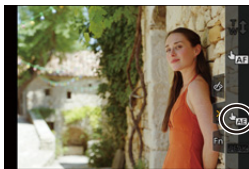

3 Touch the subject to which you wish to adjust the brightness.



- To return the position to which to adjust the brightness to the center, touch [Reset].



4 Touch [Set].

❖ How to Disable Touch AE

Touch [].

- When the following function is being used, Touch AE is not available:
 - [Live Cropping]
- You can also adjust both the focus and brightness to those of the position you touch. (At this time, Touch AE is not available):
[] ⇒ [] ⇒ [Touch Settings] ⇒ [Touch AF] ⇒ [AF+AE] (⇒ [Moving the AF Area by Touch: 161](#))

4. Image Recording

- [Aspect Ratio]: 114
- [Picture Size]: 115
- [Picture Quality]: 116
- [Double Card Slot Function]: 118
- [Folder / File Settings]: 120
- [File Number Reset]: 123

[Aspect Ratio]



You can select the image aspect ratio.

MENU / SET → **[CAMERA]** → **[ASPECT RATIO]** → **Select [Aspect Ratio]**

[4:3]	Aspect ratio of a 4:3 monitor
[3:2]	Aspect ratio of a standard film camera
[16:9]	Aspect ratio of a 16:9 TV
[1:1]	Square aspect ratio

- [16:9] and [1:1] aspect ratios are not available when using the following functions:
 - 6K photo
 - [Post-Focus] (when set to [6K 18M])
- A frame for trimming (cropping) can be displayed on the recording screen:
 - [**SETTINGS**] → [**FRAME MARKER**] → [Frame Marker] (→ [\[Frame Marker\]: 379](#))

[Picture Size]



Sets the picture's image size.

MENU / SET → **[CAMERA]** → **[P]** → **Select [Picture Size]**

[Aspect Ratio]	Picture size		
[4:3]	[L] 20M 5184×3888	[M] 10.5M 3712×2784	[S] 5M 2624×1968
[3:2]	[L] 18M 5184×3456	[M] 9M 3712×2480	[S] 4.5M 2624×1752
[16:9]	[L] 15M 5184×2920	[M] 8M 3840×2160	[S] 2M 1920×1080
[1:1]	[L] 15M 3888×3888	[M] 7.5M 2784×2784	[S] 4M 1968×1968

• When [Ex. Tele Conv.] is set, the [M] and [S] image sizes are indicated with **[EX]**.

- When the following functions are being used, [Picture Size] is not available:
 - [6K/4K PHOTO]/[Post-Focus]
 - [RAW] ([Picture Quality])
 - [Multiple Exposure]

[Picture Quality]



Set the compression rate used for storing pictures.

MENU / SET → **[📷]** → **[⏪]** → **Select [Picture Quality]**

Setting	File format	Settings details
[FINE]	JPEG	JPEG images that give priority to image quality.
[STD.]		JPEG images of standard image quality. This is useful for increasing the number of recordable pictures without changing the picture size.
[RAW+FINE]	RAW+JPEG	This records RAW and JPEG images ([FINE] or [STD.]) simultaneously.
[RAW+STD.]		
[RAW]	RAW	This records RAW images.

• **Note on RAW**

RAW format refers to a data format of images that have not been processed on the camera.

Playback and editing of RAW images require the camera or the dedicated software.

- You can process RAW images on the camera. (→[RAW Processing]: 460)
- Use software (“SILKYPIX Developer Studio” by Ichikawa Soft Laboratory) to process and edit RAW files on a PC. (→SILKYPIX Developer Studio SE: 696)
- Pictures taken with [RAW] cannot be displayed enlarged to the maximum magnification during playback.



Take pictures with [RAW+FINE] or [RAW+STD.] if you want to check their focus on the camera after recording.

- RAW images are always recorded in the [L] size of the [4:3] aspect ratio.
- When you delete an image recorded with [RAW+FINE] or [RAW+STD.] on the camera, both the RAW and JPEG images will be deleted simultaneously.
- When the following functions are being used, [Picture Quality] is not available:
 - [6K/4K PHOTO]/[Post-Focus]
 - [Multiple Exposure]

[Double Card Slot Function]

This sets the way recording to the card slots 1 and 2 is performed.

 → [] → [] → **Select [Double Card Slot Function]**

[Recording Method]	 [Relay Rec]	<p>Selects the priority of card slots for recording.</p> <p>[Destination Card Slot]: [1 → 2] / [2 → 1]</p> <p>Relays recording to the card in the other card slot after the first card runs out of free space.</p>
	 [Backup Rec]	<p>Records the same images to both cards simultaneously.</p>
	 [Allocation Rec]	<p>Allows you to specify the card slot to be used for recording for different image formats.</p> <p>[JPEG Destination]/[RAW Destination]/[6K/4K Photo Destination]/[Video Destination]</p>

Notes about relay recording

- The following video cannot be continued to be recorded on another card:
 - [Loop Recording (video)]

Notes about Backup Recording

- We recommend using cards with the same Speed Class rating and capacity. If the card Speed Class or capacity is insufficient when video recording, recording to both cards stops.
- Backup recording is not available with the following video. They can only be recorded on a single card:
 - [Loop Recording (video)]
- When using the following combinations of cards, backup recording for videos, 6K/4K photos, and [Post-Focus] are not available:
 - SD/SDHC memory card, and SDXC memory card

[Folder / File Settings]

Set the folder and file name where to save the images.

Folder name

100ABCDE



(1) (2)

- (1) Folder number (3 digits, 100 to 999)
- (2) 5-character user-defined segment

File name

PABC0001.MP4



(3) (4) (5) (6)

- (3) Color space ([P]: sRGB, [_]: AdobeRGB)
- (4) 3-character user-defined segment
- (5) File number (4 digits, 0001 to 9999)
- (6) Extension

 → [] → [] → **Select [Folder / File Settings]**

[Select Folder]^{*1}	Selects a folder for storing images.
[Create a New Folder]	<p>Creates a new folder with an incremented folder number.</p> <ul style="list-style-type: none"> • If there are no recordable folders in the card, a screen for resetting the folder number is displayed. <p>[OK]: Increments the folder number without changing the 5-character user-defined segment ((2) above).</p> <p>[Change]: Changes the 5-character user-defined segment ((2) above). This will also increment the folder number.</p>
[File Name Setting]	<p>[Folder Number Link]: Uses the 3-character user-defined segment ((4) above) to set the folder number ((1) above).</p> <p>[User Setting]: Changes the 3-character user-defined segment ((4) above).</p>

*1 When [Double Card Slot Function] is set to [Allocation Rec], [Select Folder (Slot 1)] and [Select Folder (Slot 2)] will be displayed.

- Follow the steps on “[Entering Characters](#)” when the character entry screen is displayed. (→ [Entering Characters: 609](#))

Available characters: alphabetic characters (upper-case), numerals, [_]

- Each folder can store up to 1000 files.
- File numbers are assigned sequentially from 0001 to 9999 in the order of recording.

If you change the storage folder, a number continuing on from the last file number will be assigned.

- In the following cases, a new folder with an incremented folder number will be created automatically when the next file is saved:
 - The number of files in the current folder reaches 1000.
 - The file number reaches 9999.
- New folders cannot be created when there are folders numbered from 100 all the way up to 999.

We recommend backing up your data and formatting the card.

- [Select Folder] is not available when [Backup Rec] in [Double Card Slot Function] is being used.

[File Number Reset]

Refresh the folder number to reset the file number to 0001.



→ [] → [] → **Select [File Number Reset]**

Settings: [Card Slot 1]/[Card Slot 2]

- When the folder number reaches 999, the file number cannot be reset. We recommend backing up your data and formatting the card.
- **To reset the folder number to 100:**
 - 1 Perform [Card Format] to format the card. (→ [Formatting Cards \(Initialization\): 62](#))
 - 2 Perform [File Number Reset] to reset the file number.
 - 3 Select [Yes] on the folder number reset screen.

5. Focus/Zoom

- Selecting the Focus Mode: 125
- Using AF: 127
- Selecting the AF Mode: 135
- AF Area Movement Operation: 158
- Record Using MF: 167
- Recording with Zoom: 174

Selecting the Focus Mode



Select the focusing method (focus mode) to match subject movement.

1 Set the focus mode lever.

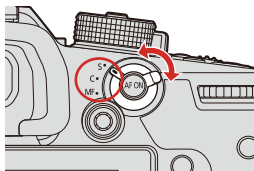

[S] ([AFS])

This is suitable for recording still subjects.

When the shutter button is pressed halfway, the camera focuses once.

The focus stays locked while the shutter button is pressed halfway.

[C] ([AFC])

This is suitable for recording moving subjects.

While the shutter button is pressed halfway, the focus is constantly adjusted according to the movement of the subject.

- This predicts the movement of the subject, maintaining focusing. (Movement prediction)
-

[MF]

Manual focusing. Use this when you want to fix the focus or avoid activating AF.

(→ [Record Using MF: 167](#))

- In the following cases, [AFC] works the same as [AFS] when the shutter button is pressed halfway:
 - [M] mode
 - In low light situations
- This function is not available for Post-Focus recording.

Using AF

- [\[AF Custom Setting\(Photo\)\]: 132](#)



AF (Auto Focus) refers to automatic focusing.





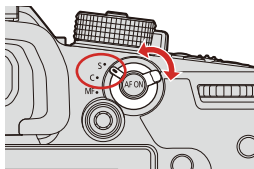

Select the focus mode and the AF mode appropriate for the subject and scene.

1 Set the focus mode to [S] or [C].

- Set the focus mode lever. (→ [Selecting the Focus Mode: 125](#))



2 Select the AF mode.

- Press [] to display the AF mode selection screen, and set using  or . (→ [Selecting the AF Mode: 135](#))
- Selection is also possible by pressing [].
- In [iA] mode, each press of [] switches between [] and []. (→ [AF Mode: 106](#))

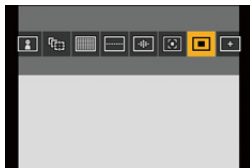

3 Press the shutter button halfway.

- The AF operates.



	Focus	
	In focus	Not in focus
Focus icon (A)	Lights	Blinking
AF area (B)	Green	Red
AF beep	Two beeps	—

Low illumination AF

- In dark environments, low illumination AF automatically operates, and the focus icon is indicated as [LOW].
- Achieving focus may take more time than usual.

Starlight AF

- If the camera detects stars in the night sky after determining low illumination AF, then Starlight AF will be activated.

When focus is achieved, the focus icon will display [●^{STAR}], and the AF area will be displayed on the area in focus.







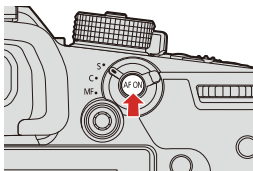



- Edges of the screen cannot detect Starlight AF.

❖ [AF ON] button

You can also activate AF by pressing [AF ON].



- **Subjects and recording conditions that make focusing difficult with AF mode**

- Fast-moving subjects
 - Extremely bright subjects
 - Subjects without contrast
 - Subjects recorded through windows
 - Subjects near shiny objects
 - Subjects in very dark locations
 - When recording subjects both distant and near
- You can change the operation of AF-ON so that AF prioritizes subjects close by. This function is useful when the camera mistakenly focuses on the background:
[] ⇒ [] ⇒ [Fn Button Set] ⇒ [Setting in REC mode] ⇒ [AF-ON : Near Shift] (⇒ [Fn Buttons: 471](#))
 - You can change the operation of AF-ON so that AF prioritizes subjects far away. This function is useful when taking pictures through fences or nets:
[] ⇒ [] ⇒ [Fn Button Set] ⇒ [Setting in REC mode] ⇒ [AF-ON : Far Shift] (⇒ [Fn Buttons: 471](#))
 - When the following operations are performed while recording with [AFC], it may take some time for the camera to focus:
 - When zooming from the wide-angle end to the telephoto end
 - When the subject is suddenly changed from one far away to one close by
 - If using the zoom after achieving focus, the focus may be erroneous. In that case, re-adjust the focus.
 - When camera shake reduces, it is possible to focus automatically:
[] ⇒ [] ⇒ [Quick AF] (⇒ [Quick AF: 557](#))
 - You can change the settings so that AF does not function when the shutter button is pressed halfway:
[] ⇒ [] ⇒ [Half-Press Shutter] (⇒ [Half-Press Shutter: 556](#))
 - The AF beep volume and sound can be changed:
[] ⇒ [] ⇒ [Beep] ⇒ [AF Beep Volume]/[AF Beep Tone] (⇒ [Beep: 588](#))

❖ Magnify the AF Area Position ([AF-Point Scope])



This magnifies the focus point when the AF mode is [], [], or []. (In other AF modes, the center of the screen is magnified.)

You can check focus and observe an enlarged subject as with a telephoto lens.

- 1 Register [AF-Point Scope] to the Fn button. (→ [Fn Buttons: 471](#))
- 2 Enlarge the AF area position by pressing and holding the Fn button.
 - When the screen is enlarged, pressing the shutter button halfway re-acquires focus in a small central AF area.
 - When the screen is enlarged, turn or to adjust the magnification. Use for more detailed adjustments.



- When the screen is enlarged, [AFC] changes to [AFS].
- When the following functions are being used, AF-Point Scope does not work:
 - Video recording/[Post-Focus]
 - [6K/4K Pre-Burst]
 - [Miniature Effect] ([Filter Settings])
 - [Multiple Exposure]
- You can change the display method of the magnified screen:
 - [] ⇒ [] ⇒ [AF-Point Scope Setting] (→ [\[AF-Point Scope Setting\]: 556](#))

[AF Custom Setting(Photo)]



Select features of AF operation when recording using [AFC] that are appropriate for the subject and scene.

Each of these features can be further customized.

1 Set the focus mode to [AFC]. (→ [Selecting the Focus Mode: 125](#))

2 Set [AF Custom Setting(Photo)].

- → → → [AF Custom Setting(Photo)]

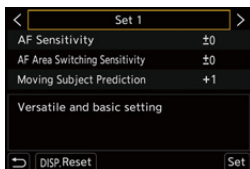

[Set 1]

Basic general-purpose setting.

[Set 2]

Suggested for situations where the subject moves at a constant speed in one direction.

[Set 3]



Suggested when the subject moves randomly, and other objects may be in the scene.

[Set 4]

Suggested for situations where the speed of the subject changes significantly.

- When the following function is being used, [AF Custom Setting(Photo)] is not available:
 - [6K/4K PHOTO]

❖ Adjusting AF Custom Settings

- 1 Press ◀▶ to select the AF Custom setting type.
- 2 Press ▲▼ to select items and press ◀▶ to adjust.
 - To reset settings to the default, press [DISP].
- 3 Press  or .

[AF Sensitivity]		Sets the tracking sensitivity for the movement of subjects.
	[+]	When the distance to the subject changes drastically, the camera re-adjusts the focus immediately. You can bring different subjects into focus one after another.
	[-]	When the distance to the subject changes drastically, the camera waits for a short period of time before re-adjusting the focus. This allows you to prevent the focus from being accidentally re-adjusted when, for example, an object moves across the image.
[AF Area Switching Sensitivity]		Sets the sensitivity for switching the AF area to match subject movement. (When in an AF mode where the AF area uses 225-area focusing)
	[+]	When the subject moves out of the AF area, the camera immediately switches the AF area to keep the subject in focus.
	[-]	The camera switches the AF area at a gradual pace. Effects caused by a slight movement of the subject or by obstacles in front of the camera will be minimized.

[Moving Subject Prediction]	Sets the level of movement prediction for changes in the speed of subject movement. <ul style="list-style-type: none">• At larger setting values, the camera tries to maintain focus by responding even to sudden movements of the subject. However, the camera becomes more sensitive to slight movements of the subject, so focusing may become unstable.	
	[0]	This is suited to a subject with minimal changes in speed.
	[+1]	These are suited to a subject that changes its speed.
	[+2]	

Selecting the AF Mode

- [Human Detect AF]/[Human/Animal Detect AF]: 138
- [Tracking]: 143
- [225-Area]: 145
- [Zone (Vert./ Horz.)]/[Zone (Square)]/[Zone (Oval)]: 146
- [1-Area+]/[1-Area]: 149
- [Pinpoint]: 152
- [Custom1] to [Custom3]: 155





Select the focusing method to match the position and number of subjects.

1 Press [].

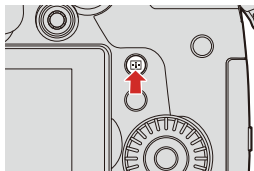
- The AF mode selection screen appears.



2 Select the AF mode.

- Press ◀▶ to select an item and then press  or .
- Selection is also possible by pressing [].





 [Human Detect AF]/ [Human/Animal Detect AF]
(→[Human Detect AF]/[Human/Animal Detect AF]: 138)

 [Tracking]
(→[Tracking]: 143)

 [225-Area]
(→[225-Area]: 145)

 [Zone (Vert./ Horz.)]
(→[Zone (Vert./ Horz.)]: 146)

 [Zone (Square)]¹
(→[Zone (Square)]: 146)

 [Zone (Oval)]
(→[Zone (Oval)]: 147)

 [1-Area+]
(→[1-Area+]: 149)

 **[1-Area]**

(→[\[1-Area\]: 149](#))





 **[Pinpoint]**

(→[\[Pinpoint\]: 152](#))

 **[Custom1]^{*1}** /  **[Custom2]^{*1}** /  **[Custom3]^{*1}**

(→[\[Custom1\] to \[Custom3\]: 155](#))

*1 This is not displayed with the default settings. From [\[Show/Hide AF Mode\]](#) in the [\[Custom\] \(\[Focus/Shutter\]\)](#) menu, you can set the items to display on the selection screen. (→[\[Show/Hide AF Mode\]: 555](#))

- When the following function is being used,  is not available.
 - [\[Time Lapse Shot\]](#)
- When the focus mode is set to [\[AFC\]](#),  is not available.
- When the following function is being used, the AF mode is fixed to  ([\[Human Detect AF\]](#)):
 - [\[Live Cropping\]](#)
- When the following function is being used, the AF mode is fixed to :
 - [\[Miniature Effect\] \(\[Filter Settings\]\)](#)
- The AF mode cannot be set when using [Post-Focus](#).

[Human Detect AF]/[Human/Animal Detect AF]

The camera detects a person's face, eyes, and body (entire body, upper half of the body, or head) and adjusts the focus. With animal detection enabled, the camera will also detect animals, such as birds, canines (including wolves), and felines (including lions).

When the camera detects a person's face (A)/(B) or body or an animal's body (C)*1, an AF area is displayed.

*1 When the animal detection is enabled.

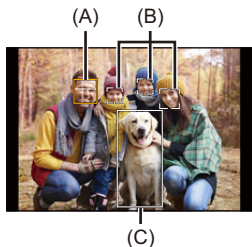

Yellow

AF area to be brought into focus.

The camera selects this automatically.

White

Displayed when multiple subjects are detected.

- Eye detection works only for the eyes inside the yellow frame (A).

- When a person's eyes are detected, the eye closer to the camera will be brought into focus.
The exposure will be adjusted to the face. (When [Metering Mode] is set to [☉])
- The camera can detect the faces of up to 15 people.
- The camera can detect a combined total of up to 3 human and animal bodies.
- If any humans or animals are not detected, the camera operates as [☐].

❖ Enable/Disable Animal Detection

- 1 Press [☐] to display the AF mode selection screen.
- 2 Select [☐] and then press ▲.
 - This enables animal detection, and the icon changes to [☐].
 - Press ▲ again to disable animal detection.

❖ Specify the Person, Animal, or the Person's Eye to Bring into Focus

When the person or animal to be brought into focus is shown using the white AF area, you can change this to a yellow AF area.

Touch operation

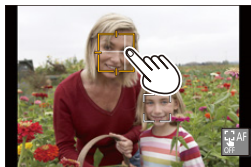

Touch the person, animal or eye indicated with the white AF area.

- The AF area will change to yellow.
- Touching outside the AF area displays the AF area setting screen. Touch [Set] to set the [] AF area at the position touched.
- To cancel the setting, touch [].



Button operation



Press .

- Each press of  switches the person, animal or eye to be brought into focus.
- To cancel the settings specified, press .





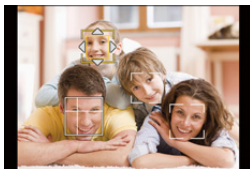

❖ Move and Change the Size of the Yellow AF Area

You can move the yellow AF area to the position of the white AF area and replace the white AF area with the yellow AF area.



If moving to a position outside an AF area, then the [■] AF area will be set.

- 1 Press [] to display the AF mode selection screen.
- 2 Select [] or [] and then press ▼.
- 3 Press ▲▼◀▶ to move the position of the AF area.



- 4 Rotate  ,  or  to change the size of the AF area.
- 5 Press  .
 - On the recording screen, press  , or touch [] to cancel the AF area setting.

Operations on the AF area movement screen

Button operation	Touch operation	Description of operation
	Touch	Moves the AF area.
	Pinch out/ pinch in	Enlarges/reduces the AF area in small steps.
	—	Enlarges/reduces the AF area.
[DISP.]	[Reset]	First time: Returns the AF area position to the center. Second time: Returns the AF area size to the default setting.

[Tracking]

When the focus mode is set to [AFC], the AF area follows the movement of the subject, maintaining focusing.





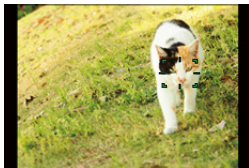

1 Start tracking.

- Aim the AF area over the subject, and press the shutter button halfway.



The camera will track the subject while the shutter button is pressed halfway or pressed fully.

- If tracking fails, the AF area blinks red.
- When set to [AFS], the focus will be on the AF area position. Tracking will not work.



- In [AF-ON] mode, while recording video, and while recording with [6K/4K Burst(S/S)], tracking will continue even if the shutter button is released.
To cancel tracking, press  or , or touch [].
Tracking is also available with [AFS].
- Set [Metering Mode] to [] to continue to adjust the exposure as well.
- In the following, [] operates as []:
 - [Monochrome]/[L.Monochrome]/[L.Monochrome D]/[L.Monochrome S] ([Photo Style])
 - [Sepia]/[Monochrome]/[Dynamic Monochrome]/[Rough Monochrome]/[Silky Monochrome]/[Soft Focus]/[Star Filter]/[Sunshine] ([Filter Settings])

❖ Move the Position of the AF Area

- 1 Press [] to display the AF mode selection screen.
- 2 Select [] and then press ▼.
- 3 Press ▲▼◀▶ to move the position of the AF area.
 - You can also move the AF area by touching.
 - To return the position back to the center, press [DISP.].
- 4 Press .

[225-Area]





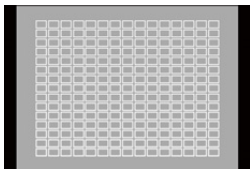







The camera selects the most optimal AF area to focus from 225 areas. When multiple AF areas are selected, all selected AF areas will be brought into focus.

When the focus mode is set to [AFC], ensuring that the subject stays within the 225 areas during recording will ensure the subject stays in focus.



❖ Specify the [AFC] Start Point

When the focus mode is set to [AFC], you can specify at which area to start [AFC].

- 1 Set the focus mode to [AFC]. (→ [Selecting the Focus Mode: 125](#))
- 2 Set [AFC Start Point (225-Area)] to [ON].
 -  ⇒  ⇒ [] ⇒ [AFC Start Point (225-Area)] ⇒ [ON]
- 3 Press [] to display the AF mode selection screen.
- 4 Select [] and then press .
 - After performing Steps 1 and 2, the icon changes from [] to [].
- 5 Press     to move the AF area to the start point.
 - You can also move the AF area by touching.
 - To return the position back to the center, press [DISP.].
- 6 Press .

[Zone (Vert./ Horz.)]/[Zone (Square)]/[Zone (Oval)]

.....[Zone (Vert./ Horz.)]

Within the 225 AF areas, vertical and horizontal zones can be focused.

Horizontal pattern

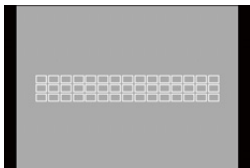

Vertical pattern

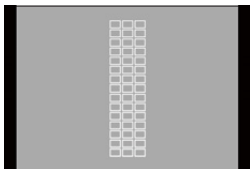

!!![Zone (Square)]

Within the 225 AF areas, a central square zone can be focused.

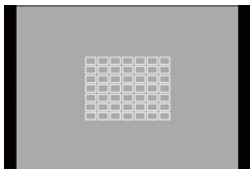



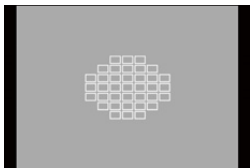

[Zone (Oval)]

Within the 225 AF areas, a central oval zone can be focused.



-  is not displayed with default settings. Set [Zone (Square)] to [ON] in [Show/Hide AF Mode] in the [Custom] ([Focus/Shutter]) menu. (→[\[Show/Hide AF Mode\]: 555](#))





❖ Move and Change the Size of the AF Area

- 1 Press [] to display the AF mode selection screen.
- 2 Select [], [] or [] and then press ▼.
- 3 Press ▲▼◀▶ to move the position of the AF area.
 - You can also move the AF area by touching.

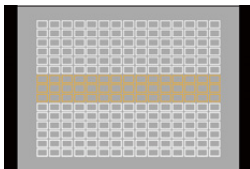
When [] is selected

- Press ▲▼ to switch to a horizontal pattern AF area.
- Press ▶◀ to switch to a vertical pattern AF area.



- 4 Rotate  ,  or  to change the size of the AF area.
 - You can also pinch out/pinch in the AF area to change the size.
 - The first press of [DISP.] returns the AF area position to the center. The second press returns the size of the AF area to the default.
- 5 Press  .

- The display method for the AF area using 225-area focusing can be changed:

[] ⇒ [] ⇒ [AF Area Display] (→[AF Area Display]: 567)

[1-Area+]/[1-Area]

[1-Area+]

Emphasis within a single AF area can be focused.

Even when the subject moves out of the single AF area, the subject remains focused in a supplementary AF area (A).

- Effective when recording moving subjects that are difficult to track with [].

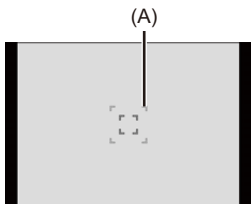

[1-Area]

Specify the point to be brought into focus.







❖ Switching of Automatic Detection

Automatic detection is now available in the [1-Area+]/[1-Area] AF modes.



When a part of a human or animal enters the [1-Area+]/[1-Area] AF area, the automatic detection AF area is indicated in yellow.

Eye detection works when a person's face is inside the AF area.

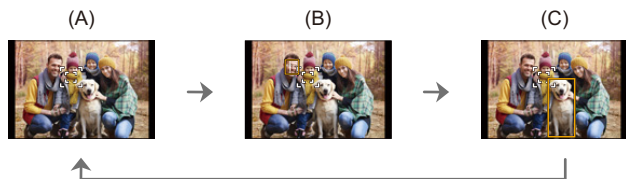
- 1 Press [] to display the AF mode selection screen.
- 2 Select [] or [] and then press .
 - Each press of  switches automatic detection.
 - The automatic detection settings of [1-Area+] and [1-Area] are linked.













(A) Automatic detection: OFF ( / )

(B) [Human Detect AF]: ON ( / )

(C) [Human/Animal Detect AF]: ON ( / )



- Only 1 human or animal can be automatically detected in the AF area.
- You cannot change the person, animal or eye being focused on during automatic detection.

❖ Move and Change the Size of the AF Area

- 1 Press [] to display the AF mode selection screen.
- 2 Select []/[]/[] or []/[]/[] and then press ▼.
- 3 Press ▲▼◀▶ to move the position of the AF area.
- 4 Rotate  ,  or  to change the size of the AF area.



- 5 Press  .

- For information about detailed operations to move the AF area (→ [Operations on the AF area movement screen: 142](#))
- Change the movement speed of a single AF area:
[] ⇒ [] ⇒ [1-Area AF Moving Speed] (→ [\[1-Area AF Moving Speed\]: 524](#))

[Pinpoint]





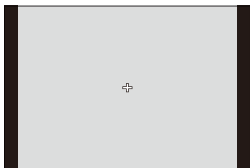

You can achieve a more precise focus on a small point.

If you press the shutter button halfway, the screen that lets you check the focus will be enlarged.



- When the focus mode is set to [AFC], [+] is not available.

❖ Move the Position of the AF Area

- 1 Press [] to display the AF mode selection screen.
- 2 Select [] and then press ▼.
- 3 Press ▲▼◀▶ to set the position of [] and then press  or  .
 - The selected position on the screen will be enlarged.
 - The AF area cannot be moved to the edge of the screen.
- 4 Press ▲▼◀▶ to fine-adjust the position of [] .

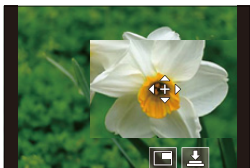

- 5 Press  or  .

Operations on the Magnification Window

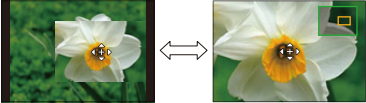
Button operation	Touch operation	Description of operation
	Touch	Moves [+].
	Pinch out/ pinch in	Enlarges/reduces the screen in small steps.
	—	Enlarges/reduces the screen.
		Switches magnification window (windowed mode/full screen mode). 
[DISP.]	[Reset]	First time: Returns to the screen in Step 3. Second time: Returns the AF area position to the center.

- When the picture is displayed in windowed mode, you can enlarge the picture by approx. 3× to 6×; when the picture is displayed in full screen, you can enlarge the picture by approx. 3× to 10×.
- You can also take a picture by touching [].

- When the following functions are being used, [+] switches to [■]:
– Video recording/[6K/4K PHOTO]
- You can change the display method of the magnified screen:
[] ⇒ [[AF]] ⇒ [Pinpoint AF Setting] (⇒ [Pinpoint AF Setting]: 556)

[Custom1] to [Custom3]



The shape of the AF area can be set freely in the 225 AF areas.

The set AF area can be registered using [**C1**] to [**C3**].

The AF area can also be moved while maintaining the set shape.

- This is not displayed with default settings. In [Show/Hide AF Mode] in the [Custom] ([Focus/Shutter]) menu, set [Custom1] to [Custom3] to [ON]. (→ [\[Show/Hide AF Mode\]: 555](#))

❖ Register the AF Area Shape

- 1 Press [] to display the AF mode selection screen.
- 2 Select one of [] to [] and then press ▲.

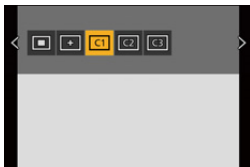

- 3 Select the AF area.



Touch operation

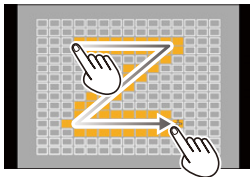

Touch the area to make the AF area.

- To select consecutive points, drag the screen.
- To cancel selection of the selected AF area, touch it again.







Button operation

Press ▲▼◀▶ to select the AF area and then set with  or . (Repeat this)

- To cancel selection of the selected AF area, press  or  again.
- To cancel all selections, press [DISP.].

- 4 Press [Q].

❖ Move the Position of the AF Area

- 1 Press [] to display the AF mode selection screen.
- 2 Select a registered AF mode shape ([] to []) and then press ▼.
- 3 Press ▲▼◀▶ to move the position of the AF area and then press  .
 - Press [DISP.] to return the [+] position to the center.

AF Area Movement Operation

- Moving the AF Area by Touch: 161
- Moving the AF Area Position with the Touch Pad: 163
- [Focus Switching for Vert / Hor]: 166





In default settings, you can use the joystick to directly move and change the size of the AF area when recording.

1 Move the position of the AF area.

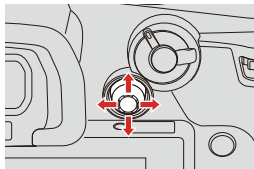
- On the recording screen, tilt the joystick.





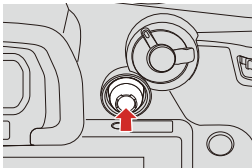

- Pressing  enables switching between the default and set AF area positions.

In []/], this operation switches the person, animal or eye to be brought into focus.

In [], this operation displays the enlarged screen.



2 Change the size of the AF area.

- Rotate ,  or .
- Use  for more detailed adjustments.
- The first press of [DISP.] returns the AF area position to the center. The second press returns the size of the AF area to the default.

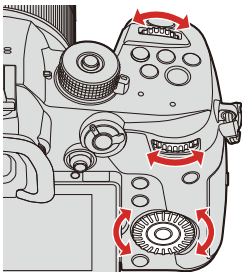

3 Confirm your selection.

- Press the shutter button halfway.
- This will return you to the recording screen.

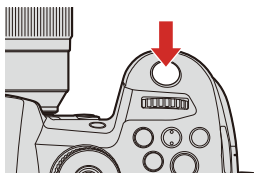

- When [Metering Mode] is [], the metering target also moves together with the AF area.
- In [], [], [], and [] to [], the size of the AF area cannot be changed.
- In [], it is not possible to move the AF area or change its size.
- In the [iA] mode, the []/[] AF area cannot be moved.
- You can set the AF area to loop when moved:
[] ⇒ [] ⇒ [Looped Focus Frame] (⇒ [\[Looped Focus Frame\]: 557](#))

Moving the AF Area by Touch

You can move the AF area to a touched position on the monitor.

You can also change the size of the AF area.

 →  →  → **[Touch Settings]** → **Select [Touch AF]**

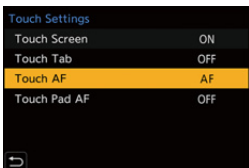

[AF]	This focuses on the touched subject.
[AF+AE]	This focuses on and adjusts brightness for the touched subject.

- The default setting is [AF].

❖ Focus on the Touched Position ([AF])

- 1 Touch the subject.
 - The AF area moves to the touched position.
- 2 Pinch out/pinch in to change the AF area size.
 - The first touch of [Reset] returns the AF area position to the center.
The second touch returns the size of the AF area to the default.
- 3 Touch [Set].
 - In [+], touch [Exit].
 - For [Person]/[Person with arrow], the AF area setting is canceled if you touch  on the recording screen.

❖ Focus on and Adjust Brightness for the Touched Position ([AF+AE])

- 1 Touch the subject to which you wish to adjust the brightness.
 - At the touched position, an AF area that works in the same way as [] is displayed.

This places a point to adjust brightness at the center of the AF area.

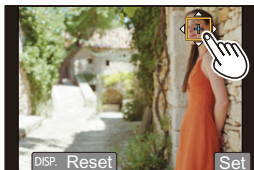



- 2 Pinch out/pinch in to change the AF area size.
 - The first touch of [Reset] returns the AF area position to the center. The second touch returns the size of the AF area to the default.
- 3 Touch [Set].
 - The [AF+AE] area setting is canceled if you touch [] (when [] or [] is set: [])

Moving the AF Area Position with the Touch Pad

During viewfinder display, you can touch the monitor to change the position and size of the AF area.

1 Set [Touch Pad AF].

-  →  →  → [Touch Settings] → [Touch Pad AF] → [EXACT]/[OFFSET1] to [OFFSET7]

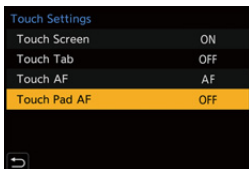



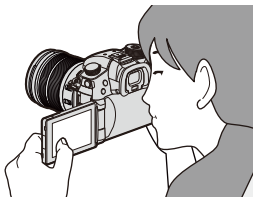

2 Move the position of the AF area.

- During viewfinder display, touch the monitor.



3 Change the size of the AF area.

- Rotate ,  or .
- Use  for more detailed adjustments.
- The first press of [DISP.] returns the AF area position to the center. The second press returns the size of the AF area to the default.

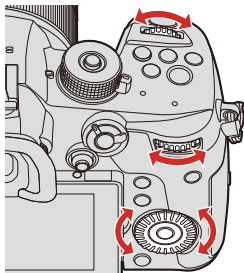

4 Confirm your selection.

- Press the shutter button halfway.

❖ Setting Items ([Touch Pad AF])

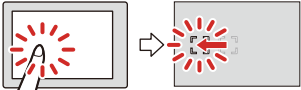
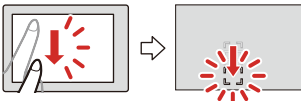
<p>[EXACT]</p>	<p>Moves the AF area of the viewfinder by touching a desired position on the touch pad.</p> 
<p>[OFFSET1] to [OFFSET7]</p>	<p>Moves the AF area of the viewfinder according to the distance you drag your finger on the touch pad. Select the range to be detected with the drag operation.</p>  <p>[OFFSET1] (entire area)/[OFFSET2] (right half)/ [OFFSET3] (upper right)/[OFFSET4] (lower right)/ [OFFSET5] (left half)/[OFFSET6] (upper left)/ [OFFSET7] (lower left)</p>
<p>[OFF]</p>	<p>—</p>

[Focus Switching for Vert / Hor]

Memorizes separate positions for AF areas for when the camera is vertically aligned and for when it is horizontally aligned.

Two vertical orientations, left and right, are available.



→ [] → [] → **Select [Focus Switching for Vert / Hor]**

[ON]	Memorizes separate positions for vertical and horizontal orientations.
[OFF]	Sets the same position for vertical and horizontal orientations.

- In MF, this memorizes the MF Assist position.
- This does not work in the [] and [] to [] AF modes.

Record Using MF



MF (Manual Focus) refers to manual focusing.

Use this function when you want to fix the focus or when the distance between the lens and the subject is determined and you do not want to activate AF.

1 Set the focus mode lever to [MF].

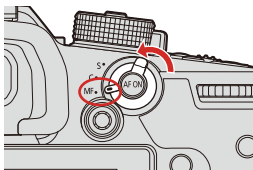

2 Select the focus point.

- Tilt the joystick to select the focus point.
- To return the point to be brought into focus to the center, press [DISP.].

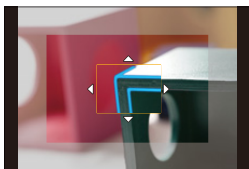
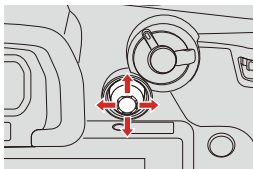

3 Confirm your selection.

- Press  .
- This switches to the MF Assist screen, and shows an enlarged display.

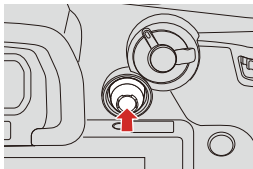

4 Adjust the focus.

The operations used to focus differ depending on the lens.

When using an interchangeable lens with a focus ring

Rotate to (A) side:

Focuses on nearby subject

Rotate to (B) side:

Focuses on distant subjects

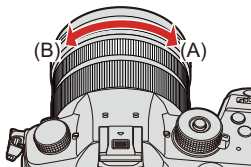

When using the interchangeable lens having a focus lever

Move to (C) side:

Focuses on nearby subject

Move to (D) side:

Focuses on distant subjects

- The focusing speed varies depending on how far you move the focus lever.

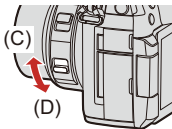

When using an interchangeable lens with no focus ring

Press **▶**: Focuses on nearby subject

Press **◀**: Focuses on distant subjects

- Pressing and holding **◀/▶** will increase the focus speed.
- Focus can also be adjusted by dragging the slide bar.

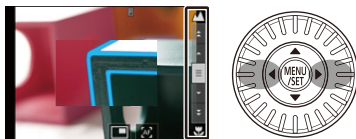

- This will display the in-focus portion highlighted with color. (Focus Peaking)
- A recording distance guideline is displayed. (MF Guide)

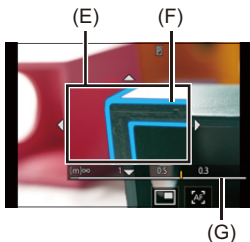

(E) MF Assist (enlarged screen)

(F) Focus Peaking

(G) MF Guide







5 Close the MF Assist screen.

- Press the shutter button halfway.
- This operation can also be performed by pressing  .

6 Start recording.

- Press the shutter button fully.

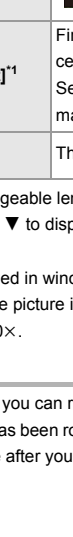
❖ Operations on the MF Assist Screen

Button operation	Touch operation	Description of operation
▲▼◀▶*1	Drag	Moves the enlarged display position.
	Pinch out/ pinch in	Enlarges/reduces the screen in small steps.
	—	Enlarges/reduces the screen.
		Switches magnification window (windowed mode/full screen mode). 
[DISP.]*1	[Reset]*1	First time: Returns the MF Assist position to the center. Second time: Returns the MF Assist magnification to the default setting.
[AF ON]		The AF operates.









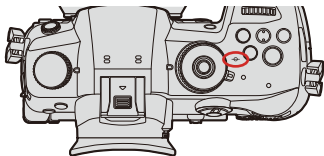







*1 When using an interchangeable lens with no focus ring, you can perform these operations after pressing ▼ to display the screen that lets you set the area to be enlarged.

- When the picture is displayed in windowed mode, you can enlarge the picture by approx. 3× to 6×; when the picture is displayed in full screen, you can enlarge the picture by approx. 3× to 20×.

- On the recording screen, you can rotate the focus ring to display the MF Assist screen. If the focus ring has been rotated to enlarge the display, the assist screen will be exited a short time after you cease the operation.

- You can also display the MF Assist screen by pressing the [].
- MF Assist and MF Guide may not display depending on the lens used. You can, however, display MF Assist by directly operating the camera using the touch screen or a button.
- During MF, pressing [AF ON] will activate AF.
- The recording distance reference mark indicates the position of the imaging surface. This becomes the reference when measuring the recording distance.



- You can change the Focus Peaking sensitivity and the display method:
[] ⇒ [] ⇒ [Focus Peaking] (⇒ [\[Focus Peaking\]: 524](#))
- You can memorize the MF Assist position separately for vertical and horizontal orientations:
[] ⇒ [] ⇒ [Focus Switching for Vert / Hor] (⇒ [\[Focus Switching for Vert / Hor\]: 166](#))
- You can change the display method of the magnified screen:
[] ⇒ [] ⇒ [MF Assist] (⇒ [\[MF Assist\]: 554](#))
- You can change the MF Guide display units:
[] ⇒ [] ⇒ [MF Guide] (⇒ [\[MF Guide\]: 555](#))
- You can disable focus ring operation:
[] ⇒ [] ⇒ [Focus Ring Lock] (⇒ [\[Focus Ring Lock\]: 555](#))
- You can set the movement of the MF Assist position to loop:
[] ⇒ [] ⇒ [Looped Focus Frame] (⇒ [\[Looped Focus Frame\]: 557](#))
- The camera memorizes the focus point when you turn it off:
[] ⇒ [] ⇒ [Lens Focus Resume] (⇒ [\[Lens Focus Resume\]: 580](#))
- The amount of focus movement can be set:
[] ⇒ [] ⇒ [Focus Ring Control] (⇒ [\[Focus Ring Control\]: 581](#))

Recording with Zoom

- [Extended Tele Conversion: 176](#)
- [\[Power Zoom Lens\]: 180](#)



Use the optical zoom of the lens to zoom to telephoto or wide-angle.

When taking pictures, use [Ex. Tele Conv.] to increase a telescopic effect without image deterioration.

When recording videos, use [Image Area of Video] to obtain the same telescopic effect as [Ex. Tele Conv.].

- For details about [Image Area of Video] (→ [\[Image Area of Video\]: 348](#))

1 Perform zoom operations.

(T): Telephoto

(W): Wide-angle

Interchangeable lens with a zoom ring

Rotate the zoom ring.



Interchangeable lens that supports the power zoom (electrically operated zoom)

Move the zoom lever.

(The zoom speed varies depending on how far you move the lever.)

- If you set [Zoom Control] to an Fn button, you can operate the optical zoom slowly by pressing ◀▶ or fast by pressing ▲▼.

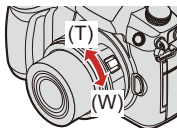



Interchangeable lens that does not support the zoom

The optical zoom is not available.

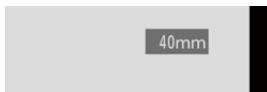
- The focal length is displayed on the recording screen.



- The focal length display can be hidden:

[] ⇒ [] ⇒ [Focal Length] (⇒[Focal Length]: 571)

Extended Tele Conversion



[Ex. Tele Conv.] enables you to take pictures that are further enlarged beyond what is available with the optical zoom, without any deterioration in image quality.

- The [Ex. Tele Conv.] maximum magnification ratio differs depending on the [Picture Size] set in the [Photo] ([Image Quality]) menu.
 - Set to [EXM]: 1.4×
 - Set to [EXS]: 2.0×

1 Set [Picture Size] to [M] or [S].

- → [CAMERA] → [ZOOM] → [Picture Size] → [M]/[S]

2 Set [Ex. Tele Conv.].

- → [CAMERA] → [ZOOM] → [Ex. Tele Conv.]

[ZOOM]

Changes the zoom magnification.



[TELE CONV.]

Fixes the zoom magnification at the maximum.

[OFF]

❖ Changing the Zoom Magnification



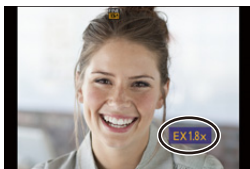

Button operation

- 1 Set [Ex. Tele Conv.] to [ZOOM].
 -  ⇒ [] ⇒ [] ⇒ [Ex. Tele Conv.] ⇒ [ZOOM]
- 2 Set the Fn button to [Zoom Control]. (⇒ [Fn Buttons: 471](#))
- 3 Press the Fn button.
- 4 Press the cursor buttons to operate the zoom.
 - ▲▶: T (telephoto)
 - ◀▼: W (wide-angle)
 - Press the Fn button again, or wait a specified time to end zoom operation.



Touch operation

- With the default settings, the Touch Tab is not displayed.
Set [Touch Tab] to [ON] in [Touch Settings] in the [Custom] ([Operation]) menu.
(→[Touch Settings]: 559)

- 1 Set [Ex. Tele Conv.] to [ZOOM].
 -  ⇒ [] ⇒ [] ⇒ [Ex. Tele Conv.] ⇒ [ZOOM]
- 2 Touch [].
- 3 Touch [].

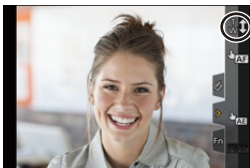

- 4 Drag the slide bar to operate the zoom.



(T): Telephoto

(W): Wide-angle

- To end Touch Zoom operations, touch [] again.

- When displaying the [Ex. Tele Conv.] setting screen using the Fn button, pressing [DISP.] allows you to change the [Picture Size] setting.
- When the following functions are being used, [Ex. Tele Conv.] is not available:
 - [6K/4K PHOTO] (when set to [6K 18M])
 - [RAW] ([Picture Quality])
 - [Toy Effect]/[Toy Pop] ([Filter Settings])
 - [Post-Focus] (when set to [6K 18M])
 - [Multiple Exposure]
- When the following functions are being used, [ZOOM] is not available:
 - [6K/4K PHOTO]
 - [Post-Focus]

[Power Zoom Lens]



Sets the screen display and operations when using an interchangeable lens that is compatible with power zoom (electrically operated zoom).

- This may only be selected when using a lens that is compatible.

→ → → **Select [Power Zoom Lens]**

[Step Zoom]	When it is set to [ON] and a zoom operation is performed, zooming stops at each decided focal point position. This setting does not work when recording video or 6K/4K photos with [6K/4K Pre-Burst].
[Zoom Speed]	You can set the zoom speed for zoom operations. • If you set [Step Zoom] to [ON], the zoom speed will not change. [Photo]: [H] (High speed)/[M] (Middle speed)/[L] (Low speed) [Video]: [H] (High speed)/[M] (Middle speed)/[L] (Low speed)
[Zoom Ring]	This may only be selected when a power zoom-compatible lens with a zoom lever and zoom ring is attached. When set to [OFF], the operations controlled by the zoom ring are disabled to prevent accidental operation.

6. Drive/Shutter/Image Stabilizer

- Selecting the Drive Mode: 182
- Taking Burst Pictures: 184
- 6K/4K Photo Recording: 190
- Selecting Pictures from a 6K/4K Burst File: 197
- Post-Focus Recording: 207
- Recording with Time Lapse Shot: 216
- Recording with Stop Motion Animation: 221
- Time Lapse Shot/Stop Motion Animation Videos: 225
- Recording Using the Self-timer: 227
- Bracket Recording: 231
- [Silent Mode]: 239
- [Shutter Type]: 240
- Image Stabilizer: 243

Selecting the Drive Mode

You can switch the drive mode to Single, Burst, etc. to match the recording conditions.

1 Rotating the drive mode dial.

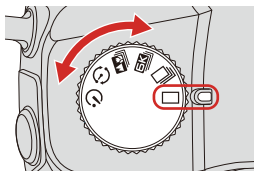

[Single]

Takes one picture each time the shutter button is pressed.

[Burst] (→ [Taking Burst Pictures: 184](#))

Takes pictures continuously while the shutter button is pressed and held.

[6K/4K PHOTO] (→ [6K/4K Photo Recording: 190](#))

When the shutter button is pressed, the pictures are recorded with [6K/4K PHOTO].

[Post-Focus] (→ [Post-Focus Recording: 207](#))

When the shutter button is pressed, the pictures are recorded with [Post-Focus].

Time Lapse Shot/Stop Motion Animation (→ [Recording with Time Lapse Shot: 216](#), [Recording with Stop Motion Animation: 221](#))

Takes pictures with Time Lapse Shot or Stop Motion Animation.

 **Self-timer** (→ [Recording Using the Self-timer: 227](#))

Takes pictures when the set time elapses after the shutter button is pressed.

- The detailed setting screens for each drive mode can be called up with an Fn button:

[] ⇒ [] ⇒ [Fn Button Set] ⇒ [Setting in REC mode] ⇒ [Drive Mode Setting] (→ [Fn Buttons: 471](#))

Taking Burst Pictures



Takes pictures continuously while the shutter button is pressed and held.

- 1 Set the drive mode dial to [📷].

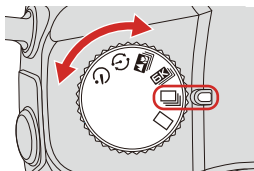

2 Select the burst rate.

-  →  →  → [Burst Rate]

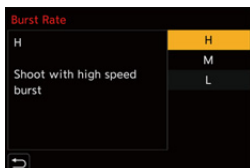

[H]

Takes high-speed burst pictures.

[M]

Takes medium-speed burst pictures.

[L]

Takes low-speed burst pictures.

3 Close the menu.

- Press the shutter button halfway.

4 Start recording.

- Takes burst pictures while the shutter button is pressed fully.

❖ Burst Rate

	Mechanical shutter, electronic front curtain	Electronic shutter	Live View when taking burst pictures
[H] (High speed)	12 frames/second ([AFS]/[MF]) 9 frames/second ([AFC])	12 frames/second ([AFS]/[MF]) 7 frames/second ([AFC])	None ([AFS]/[MF]) Available ([AFC])
[M] (Medium speed)	7 frames/second	7 frames/second	Available
[L] (Low speed)	2 frames/second	2 frames/second	Available

- The burst rate may be lower depending on the settings for recording such as [Picture Size] and focus mode.

❖ Maximum Number of Frames Recordable

	[Picture Quality]	
	[FINE]/[STD.]	[RAW+ FINE]/[RAW+ STD.]/ [RAW]
[H] (High speed)	999 frames or more	108 frames or more
[M] (Medium speed)		
[L] (Low speed)		

- When recording under the test conditions specified by Panasonic. (Using an UHS-II compatible card.)
Recording conditions may reduce the maximum number of frames recordable.
- The burst rate will become lower during recording but pictures can continue to be taken until the card becomes full.

❖ Number of Pictures That Can Be Taken Continuously

When you press the shutter button halfway, the number of pictures that can be taken continuously will appear on the recording screen.

Example) When 20 frames: [r20]

- Once recording starts, the number of pictures that can be taken continuously will decrease.

When [r0] appears, the burst rate decreases.

- When [r99+] is displayed on the recording screen, you can take 100 or more burst pictures.



❖ Focus when Taking Burst Pictures

Focus mode	[Focus/Shutter Priority] (→[Focus/Shutter Priority]: 553)	[H]	[M]/[L]
[AFS]	[FOCUS]	Fixed to the focus of the first frame	
	[BALANCE]		
	[RELEASE]		
[AFC]	[FOCUS]	Estimated focus	Normal focus
	[BALANCE]	Estimated focus	
	[RELEASE]		
[MF]	—	Focus set with manual focus	

- When the subject is dark with [AFC], the focus is fixed to that of the first frame.
- With estimated focus, the burst rate takes priority and the focus is estimated to the extent possible.
- With normal focus, the burst rate may become slow.

❖ Exposure when Taking Burst Pictures

Focus mode	[H]	[M]/[L]
[AFS]	Fixed to the exposure of the first frame	The exposure is adjusted for each frame
[AFC]	The exposure is adjusted for each frame	
[MF]	Fixed to the exposure of the first frame	

- It may take a while to save burst pictures.

If you continue to take burst pictures while saving is in progress, the maximum number of frames recordable will be reduced.

When taking burst pictures, we recommend using a high-speed card.

- Taking burst pictures does not work while you are using the following functions:
 - [Rough Monochrome]/[Silky Monochrome]/[Miniature Effect]/[Soft Focus]/[Star Filter]/[Sunshine] ([Filter Settings])
 - [Multiple Exposure]

6K/4K Photo Recording



With 6K Photo, you can take high-speed burst pictures at 30 frames/second and save the desired pictures, each made up of approx. 18 million pixels, extracted from their burst file.

With 4K photo, you can take high-speed burst pictures at 60 frames/second and save the desired pictures, each made up of approx. 8 million pixels.



- “6K PHOTO” is a high-speed burst picture function to extract and save the desired pictures from images with an aspect ratio for pictures of 4:3 or 3:2 and an effective picture size equivalent to the number of pixels (approx. 18 megapixels) for images of 6K size (around 6,000 wide×3,000 high).

- Use a UHS Speed Class 3 or higher card when recording.

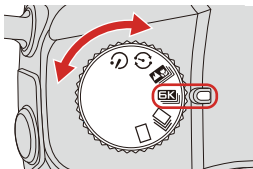
1 Set the drive mode dial to [].



2 Select [Picture Size / Burst Speed].

-  → [] → [] → [6K/4K PHOTO] → [Picture Size / Burst Speed]

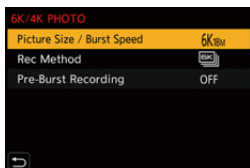

	Picture size	Burst rate	[Rec Quality] ^{*1}
[6K 18M]	[4:3]: 4992×3744	30 frames/ second	[6K/200M/30p]
	[3:2]: 5184×3456		
[4K H 8M]	[4:3]: 3328×2496	60 frames/ second	[4K/150M/60p]
	[3:2]: 3504×2336		
[4K 8M]	[16:9]: 3840×2160	30 frames/ second	[4K/100M/30p]
	[1:1]: 2880×2880		

*1 Saved as 6K/4K burst files whose [Rec. File Format] is [MP4].

3 Select [Rec Method].

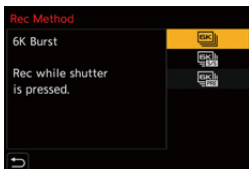

[] [] [] ([6K/4K Burst])

When you wish to capture the best moments of a fast-moving subject

Takes burst pictures while the shutter button is pressed.

Audio recording: None

[] [] [] ([6K/4K Burst(S/S)])

“S/S” is an abbreviation for start/stop.

When you wish to capture an unpredictable photo opportunity

Starts taking burst pictures when the shutter button is pressed. Pressing the button again stops taking burst pictures.

The start tone and stop tone are output.

Audio recording: Available (Audio is not played back during playback with the camera.)

[] [] [] ([6K/4K Pre-Burst])

When you wish to capture at the moment of a photo opportunity

Takes burst pictures for approx. 1 second before and after the moment the shutter button is pressed.

The shutter sound is output once only.

Recording duration: Approx. 2 seconds

Audio recording: None

4 Close the menu.

- Press the shutter button halfway.

5 Start recording.

- [Continuous AF] works and the focus is adjusted continuously during recording with AF.

[6K/4K Burst]

- 1 Press the shutter button halfway.
- 2 Press the shutter button fully and keep it pressed during recording.

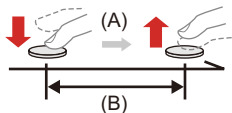

(A) Press and hold

(B) Recording is performed

- Press the shutter button fully early because recording will take approx. 0.5 second to start after it is pressed fully.
-

[6K/4K Burst(S/S)]

- 1 Press the shutter button fully to start recording.
- 2 Press the shutter button fully again to stop recording.

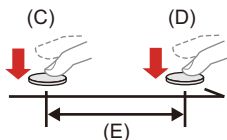

(C) Start (First)

(D) Stop (Second)

(E) Recording is performed

- You can add markers by pressing [Q] during recording. (Up to 40 markers per recording)

This allows you to skip to the positions where you added markers when selecting pictures from a 6K/4K burst file.

[6K/4K Pre-Burst]

- 1 Press the shutter button fully.

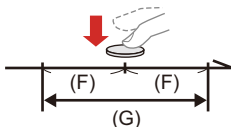

(F) Approx. 1 second

(G) Recording is performed

- While the recording screen is displayed, the AF will operate constantly to continue focusing.

The exposure is also adjusted continuously, except in [M] mode.

- When the subject is not at the center, use AF/AE Lock if you wish to lock the focus and exposure. (→ [Locking Focus and Exposure \(AF/AE Lock\): 271](#))
-

- In default settings, Auto Review operates, and a screen that lets you select pictures from a burst file will be displayed.

To continue recording, press the shutter button halfway to return to the recording screen.

For how to select and save pictures from a recorded 6K/4K burst file (→ [Selecting Pictures from a 6K/4K Burst File: 197](#))

❖ [Pre-Burst Recording] ([6K/4K Burst]/[6K/4K Burst(S/S)])

The camera starts recording approx. 1 second before the shutter button is pressed fully, so you will not miss a photo opportunity.

 → [] → [] → [6K/4K PHOTO] → Select [Pre-Burst Recording]

Settings: [ON]/[OFF]

- When [Pre-Burst Recording] is being used, [PRE] is displayed on the recording screen.
- The AF behavior and functionality restrictions when using [Pre-Burst Recording] are the same as for [6K/4K Pre-Burst].

- Setting ranges become the following with 6K/4K photo recording:
 - Shutter speed: 1/30 (1/60 when [4K H 8M] is set) to 1/16000
 - [Min. Shutter Speed]: [1/1000] to [1/30] ([1/60] when [4K H 8M] is set)
 - Exposure compensation: ± 3 EV
- The file save method differs depending on the type of card.
 - SDHC memory card:
A new file will be created to continue recording if the file size exceeds 4 GB.
 - SDXC memory card:
Files are not divided for recording.
- If the temperature of the camera rises, [] may be displayed, recording may stop, and some functions may become unavailable temporarily. Wait until the camera cools down.
- When [6K/4K Pre-Burst] or [Pre-Burst Recording] is set, the battery drains faster and the camera temperature rises. Set these settings only when recording.

- For 6K/4K photo, the menu items below are fixed to the following settings:
 - [Shutter Type]: [ELEC.]
 - [Picture Quality]: [FINE]
- With 6K/4K photo recording, the following functions are not available:
 - Flash
 - [Bracketing]
 - Program Shift
 - AF mode ()
 - [MF Assist] ([6K/4K Pre-Burst] only)
- When you record in an extremely bright location or under lighting such as fluorescent or LED lighting, the coloring or brightness of the image may change or horizontal stripes may appear on the screen.
Lowering the shutter speed may reduce the effect of horizontal stripes.
- The following functions are restricted when recording 6K/4K photos when connected to an external device (TV, etc.) via HDMI:
 - HDMI output is not possible during recording.
 - [6K/4K Pre-Burst] changes to [6K/4K Burst].
 - [Pre-Burst Recording] is not available.
- 6K/4K photo recording does not work while you are using the following functions:
 - [Rough Monochrome]/[Silky Monochrome]/[Miniature Effect]/[Soft Focus]/[Star Filter]/[Sunshine] ([Filter Settings])
 - [Multiple Exposure]

Selecting Pictures from a 6K/4K Burst File

- [Correcting Pictures After Recording \(Post-Recording Refinement\): 200](#)
- [Picture Selection Operations: 202](#)

You can select pictures from the 6K/4K burst files and save them.

- When continuing to select pictures from the Auto Review after recording 6K/4K photos, start the operation from either Step **2** or **3**.

1 Select a 6K/4K burst file on the playback screen.

(→ [Playing Back Pictures: 444](#))

- Select an image with the [▲] or [▲] icon and then press ▲.
- You can also perform the same operation by touching [▲] or [▲].



- If the images were recorded with [6K/4K Pre-Burst], proceed to Step **3**.

2 Roughly select the scene.

- Drag the slide bar (A).
- For information about how to use the picture selection slide view screen.
(→ [Picture Selection Slide View Screen Operations: 202](#))
- If the images were recorded with [6K/4K Burst] or [6K/4K Burst(S/S)], touching [] allows you to select the scene in the 6K/4K burst playback screen. (→ [6K/4K Burst Playback Screen Operations: 204](#))

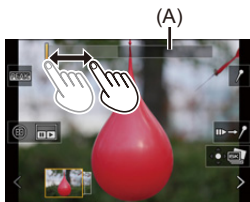



3 Select the frame to save.

- Drag the picture selection slide view (B).
- You can also perform the same operation by pressing ◀▶.
- To continuously rewind or forward frame-by-frame, touch and hold [< / >].



4 Save the picture.

- Touch [] or [].
- A confirmation screen appears.

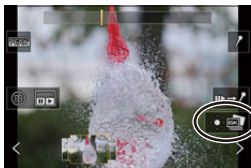

- The picture is saved in JPEG format ([FINE] picture quality).
- The recording information (Exif information), such as the shutter speed, aperture, and ISO sensitivity, is also saved with the picture that is saved.

Correcting Pictures After Recording (Post-Recording Refinement)

❖ Correcting Distortion in Pictures ([Reduce Rolling Shutter])



When saving pictures, correct any distortion caused by the electronic shutter (rolling shutter effect).

- 1 On the save confirmation screen in Step **4** (→ [Selecting Pictures from a 6K/4K Burst File: 197](#)), touch [Reduce Rolling Shutter].
 - If there is no effect even after using correction, after a message is displayed advising that there is no effect, the confirmation screen returns.
- 2 Check the correction result and then touch [Save].
 - To check the corrected and uncorrected versions of the picture, touch [Set/Cancel].

- The angle of view may become narrower if correction is performed.
- The correction may appear unnatural due to the movement of subjects.

❖ Reducing Noise Caused by High Sensitivity ([6K/4K PHOTO Noise Reduction])

When saving pictures, reduce the noise that occurs due to high ISO sensitivity.

 ⇒ [] ⇒ [] ⇒ Select [6K/4K PHOTO Noise Reduction]
Settings: [AUTO]/[OFF]

- This is not applied to pictures saved with [6K/4K PHOTO Bulk Saving].

Picture Selection Operations



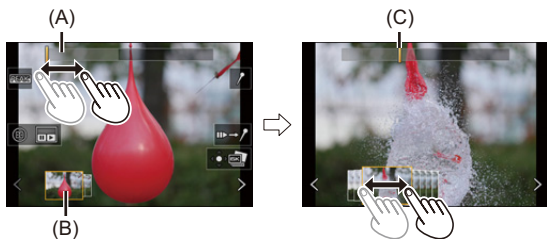











❖ Picture Selection Slide View Screen Operations



(A) Slide bar

(B) Picture selection slide view

(C) Position of displayed frame

Button operation	Touch operation	Description of operation
	Drag/ < >	Selects a frame. • To change the frames displayed in the picture selection slide view, select the frame at the left/right end and then touch [<] or [>].
Press and hold 	< > Touch and hold	Continuously rewinds or forwards frame-by-frame.
—	 Touch/drag	Selects the frame to display.
	Pinch out/ pinch in	Enlarges or reduces the display.
	—	Selects a frame while maintaining the enlarged display (during enlarged display).
	Drag	Moves the enlarged display position (during enlarged display).
[]		Displays the 6K/4K burst playback screen.
—		Switches to marker operation.
—		Adds or deletes a marker.
—		Displays the in-focus portion highlighted with color ([Focus Peaking]). • [ON]/[OFF] are switched.
	 	Saves the picture.

- During marker operation, you can skip to set markers or the beginning or end of the 6K/4K burst file. Touch [] to return to the previous operation.

Button operation	Touch operation	Description of operation
▶	▶	Moves to the next marker.
◀	◀	Moves to the previous marker.

❖ 6K/4K Burst Playback Screen Operations















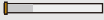

(A)





(B)

(A) While paused

(B) During continuous playback

Button operation	Touch operation	Description of operation
	—	Performs continuous playback or pauses (during continuous playback).
	—	Performs continuous rewind playback or pauses (during continuous rewind playback).
	—	Performs fast-forward playback or performs frame-by-frame forwarding (while paused).
	—	Performs fast-rewind playback or performs frame-by-frame rewinding (while paused).
—	 Touch/drag	Selects the frame to display (while paused).
	Pinch out/ pinch in	Enlarges or reduces the display (while paused).
	—	Selects a frame while maintaining the enlarged display (during enlarged display).
	Drag	Moves the enlarged display position (during enlarged display).
[]		Displays the picture selection slide view screen (while paused).
—		Switches to marker operation.
—		Adds or deletes a marker.
—		Displays the in-focus portion highlighted with color ([Focus Peaking]). • [ON]/[OFF] switches.
		Saves the picture (while paused).

- During marker operation, you can skip to set markers or the beginning or end of the 6K/4K burst file. Touch [] to return to the previous operation.









Button operation	Touch operation	Description of operation
	—	Moves to the next marker.
	—	Moves to the previous marker.

- To play and edit 6K burst files on a PC, you need a high-performance PC environment.

We recommend selecting and saving pictures with the camera.

❖ [6K/4K PHOTO Bulk Saving]

You can save any 5 second period of pictures from a 6K/4K burst file all at once.

- 1 Select [6K/4K PHOTO Bulk Saving].
 -  ⇒ [] ⇒ [] ⇒ [6K/4K PHOTO Bulk Saving]
- 2 Press   to select a 6K/4K burst file and then press  or  .
 - If the burst time is 5 seconds or less, all frames are saved as pictures.
- 3 Select the first frame of the pictures to be saved all at once and then press  or  .
 - The pictures are saved as a group of burst pictures in JPEG format.

Post-Focus Recording

- [Selecting the Focus Point for the Picture to Save: 211](#)
- [Focus Stacking: 213](#)



Taking burst pictures with the same image quality as 6K/4K photos while automatically changing the focus point.

You can select the focus point for the picture to save after recording.

Also Focus Stacking lets you combine images with multiple focus points.

This function is suitable for subjects that do not move.

- 1 Perform burst 6K/4K photo recording while automatically shifting the focus.



- 2 Touch the desired focus point.

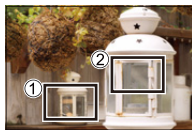

3 A picture with the desired focus point is made.



- Use a UHS Speed Class 3 or higher card when recording.
- If you are going to perform Focus Stacking after recording, we recommend using a tripod during recording.

1 Set the drive mode dial to [📷].

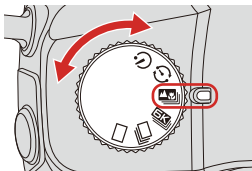

2 Set the image quality for [Post-Focus].

- [MENU/SET] → [📷] → [📷] → [Post-Focus] → [6K 18M]/[4K 8M]



3 Close the menu.

- Press the shutter button halfway.

4 Decide on the composition and then adjust the focus.

- Press the shutter button halfway.
- AF detects the focus point on the screen. (Excluding the edges of the screen)



- If no areas on the screen can be brought into focus, the focus icon (A) blinks and recording is not possible.
- Maintain the same distance to the subject and the same composition until recording finishes.

5 Start recording.

- Press the shutter button fully.

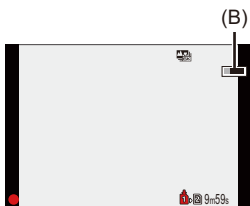



- Recording is performed while automatically changing the focus point. When the icon (B) disappears, recording ends automatically.
- A video will be recorded with [Rec. File Format] set to [MP4]. (Audio will not be recorded.)
- In default settings, Auto Review operates, and a screen that lets you select the focus point will be displayed. (→ [Selecting the Focus Point for the Picture to Save: 211](#))

- Since recording is performed with the same image quality as 6K/4K photos, limitations apply to recording functions and menus.
- Focus settings cannot be changed during Post-Focus recording.
- When the following functions are being used, [Post-Focus] is not available:
 - [Rough Monochrome]/[Silky Monochrome]/[Miniature Effect]/[Soft Focus]/[Star Filter]/[Sunshine] ([Filter Settings])
 - [Multiple Exposure]

Selecting the Focus Point for the Picture to Save

1 Select a Post-Focus image on the playback screen. (→ **Playing Back Pictures: 444**)

- Select an image with the [] icon and then press **▲**.
- You can also perform the same operation by touching the [] icon.



2 Touch the focus point.



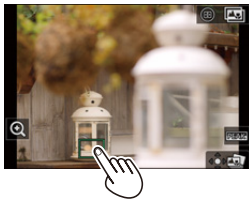







- When the point is in focus, a green frame appears.
- If there is no picture with the selected point in focus, a red frame appears.
A picture cannot be saved.
- The edge of the screen cannot be selected.



3 Save the picture.

- Touch [].
- The picture is saved in JPEG format.

❖ Focus Point Selection Operations

Button operation	Touch operation	Description of operation
	Touch	<p>Selects a focus position.</p> <ul style="list-style-type: none"> • Selection is not possible during enlarged display.
		<p>Enlarges the display.</p> <ul style="list-style-type: none"> • During enlarged display, you can fine-adjust the focus by dragging the slide bar. (You can also perform the same operation by pressing ◀▶.) 
		<p>Reduces the display (during enlarged display).</p>
		<p>Switches to Focus Stacking operation. (→ Focus Stacking: 213)</p>
—		<p>Displays the in-focus portion highlighted with color ([Focus Peaking]).</p> <ul style="list-style-type: none"> • [ON]/[OFF] switches.
		<p>Saves the picture.</p>

- You cannot display an image on a TV screen and then select the focus point.

Focus Stacking

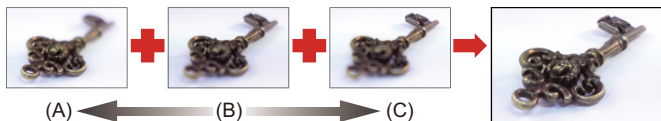

By merging multiple focus points, you can save pictures that are focused from the foreground through to the background.



(A) Closer

(B) Focus

(C) More distant

- 1 Touch [ ] on the screen for selecting the focus point. (→ [Selecting the Focus Point for the Picture to Save: 211](#))

- You can also perform the same operation by pressing [].

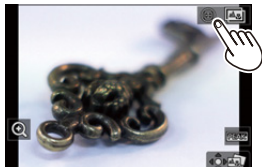

2 Select the merging method.

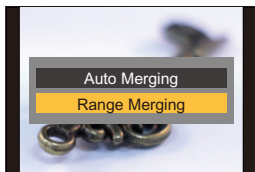

[Auto Merging]

Automatically selects pictures suitable for merging and then merges them into a single picture.

[Range Merging]

Merge pictures with selected focus points into a single picture.

3 (When [Range Merging] is selected) Touch the focus points.









- Select at least two points.
Selected points are indicated with a green frame.
- The in-focus range between the two selected points is displayed in green.
- Ranges that cannot be selected are displayed in gray.
- To cancel the selection, touch a point with a green frame again.
- To select consecutive points, drag the screen.

4 Save the picture.

- Touch [].

❖ Operations when [Range Merging] Is Selected

Button operation	Touch operation	Description of operation
 	Touch	Selects a point.
[]	[Set/Cancel]	Sets or cancels a point.
[DISP.]	[All]	Selects all points. (Before selecting points)
	[Reset]	Cancels all selections. (After selecting points)
 / 		Merges the pictures and saves the resulting picture.

- The picture is saved in JPEG format ([FINE] picture quality), and the recording information (Exif information), such as the shutter speed, aperture, and ISO sensitivity, of the picture with the closest point is also saved with the picture that is saved.
- Image misalignment due to camera shake will be adjusted automatically. If adjustments are made, the angle of view will become slightly narrower when the pictures are merged.
- If the subject moves during recording or the distance between subjects is great, merging may create an unnatural picture.

Recording with Time Lapse Shot



Pictures are taken automatically at a set recording interval.

This feature is ideal for keeping track of changes over time in subjects such as animals and plants.



The pictures taken will be saved as a set of group images that can also be combined into a video.

- Check that the clock is set correctly. (→ [Setting the Clock \(When Turning On for the First Time\): 70](#))
- For long recording intervals, we recommend setting [Lens Focus Resume] to [ON] in the [Custom] ([Lens / Others]) menu.

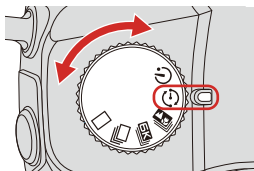
1 Set the drive mode dial to [].



2 Set [Mode] to [Time Lapse Shot].

-  →  →  → [Time Lapse/Animation] → [Mode] → [Time Lapse Shot]

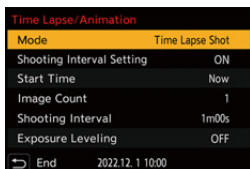

3 Set the recording settings.

[Mode]

Switches between Time Lapse Shot and Stop Motion Animation.

[Shooting Interval Setting]

[ON]: Sets the interval before the next recording takes place.

[OFF]: Takes pictures without leaving recording intervals.

[Start Time]

[Now]: Starts recording when the shutter button is pressed fully.

[Start Time Set]: Starts recording at the set time.

[Image Count]/[Shooting Interval]

Sets the number of pictures and the recording interval to be taken.

- [Shooting Interval] is not displayed when [Shooting Interval Setting] is set to [OFF].

[Exposure Leveling]

Adjusts the exposure automatically to prevent large changes in brightness between adjacent frames.

4 Close the menu.

- Press the shutter button halfway.

5 Start recording.

- Press the shutter button fully.
- When [Start Time Set] is set, the camera will enter into sleep status until the start time is reached.
- During recording standby, the camera enters into sleep status when no operation is performed for a certain period of time.
- The recording will stop automatically.

6 Create a video. (→ [Time Lapse Shot/Stop Motion Animation Videos: 225](#))

- After the recording has stopped, select [Yes] on the confirmation screen to proceed to create a video.

Even if you select [No], you can still create a video with [Time Lapse Video] in the [Playback] ([Process Image]) menu. (→ [\[Time Lapse Video\]: 603](#))

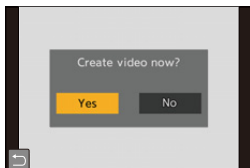

❖ Operations during Time Lapse Shot Recording

Pressing the shutter button halfway during sleep status will turn on the camera.

- You can perform the following operations by pressing [Q] during Time Lapse Shot recording.

[Continue]	Returns to the recording. (Only during recording)
[Pause]	Pauses the recording. (Only during recording)
[Resume]	Resumes the recording. (Only while paused) <ul style="list-style-type: none">• You can also press the shutter button to resume.
[End]	Stops the Time Lapse Shot recording.

- Pictures recorded to more than one card cannot be combined into a single video.
- The camera gives priority to achieving the standard exposure, so it may not take pictures at the set interval or take the set number of pictures.
Furthermore, it may not end at the end time displayed on the screen.
- Time Lapse Shot is paused in the following cases.
 - When the charge on the battery runs out
 - When you set the camera on/off switch to [OFF]
You can set the camera on/off switch to [OFF] and replace the battery or card. Set the camera on/off switch to [ON] and then press the shutter button fully to resume recording.
(Note that the images recorded after replacing the card will be saved as a separate set of group images.)
- [Exposure Leveling] is not available if ISO sensitivity is set to other than [AUTO] in [M] mode.
- [Time Lapse Shot] is not available when using the following functions:
 - [Multiple Exposure]

Recording with Stop Motion Animation





Take pictures while moving the subject little by little.

The pictures taken will be saved as a set of group images that can be combined into a stop motion video.

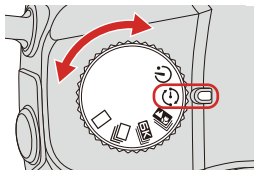
1 Set the drive mode dial to [].



2 Set [Mode] to [Stop Motion Animation].

-  → [] → [] → [Time Lapse/Animation] → [Mode] → [Stop Motion Animation]



3 Set the recording settings.

[Mode]

Switches between Time Lapse Shot and Stop Motion Animation.

[Add to Picture Group]

Allows you to continue recording for a set of stop motion images that have already been recorded.

- Select an image and proceed to Step **5**.
-

[Auto Shooting]

[ON]: Takes pictures automatically at a set recording interval.

[OFF]: This is for taking pictures manually, frame by frame.

[Shooting Interval]

Sets the recording interval for [Auto Shooting].

4 Close the menu.

- Press the shutter button halfway.

5 Start recording.

- Press the shutter button fully.
- Take pictures repeatedly while moving the subject little by little.
- The recording screen displays up to two pictures taken previously. Use them as reference for the amount of movement.
- You can play back the recorded stop motion images by pressing [▶] during recording.

Press [🗑️] to delete unnecessary images.

To return to the recording screen, press [▶] again.



6 Stop recording.

- Press [MENU/SET] and then select [Time Lapse/Animation] from the [Photo] menu to stop recording.

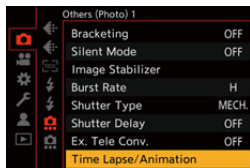

7 Create a video. (→[Time Lapse Shot/Stop Motion Animation Videos: 225](#))

- After the recording has stopped, select [Yes] on the confirmation screen to proceed to create a video.

Even if you select [No], you can still create a video with [Stop Motion Video] in the [Playback] ([Process Image]) menu. (→[\[Stop Motion Video\]: 603](#))

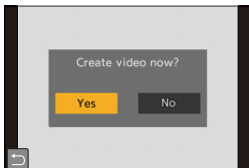

- Up to 9999 frames can be recorded.
- If the camera is turned off while recording, a message for resuming the recording is displayed when it is turned on. Selecting [Yes] allows you to continue the recording from the interruption point.
- The camera gives priority to achieving the standard exposure, so it may not take pictures at the set interval when the flash, etc. is used for recording.
- A picture cannot be selected from [Add to Picture Group] when it is the only one that was taken.
- [Stop Motion Animation] is not available when using the following functions:
 - [Multiple Exposure]

Time Lapse Shot/Stop Motion Animation Videos

After performing Time Lapse Shot or stop motion recording, you can proceed to create a video.

- Refer to the sections below about these recording functions.
 - [Recording with Time Lapse Shot: 216](#)
 - [Recording with Stop Motion Animation: 221](#)
- You can also create videos with [Time Lapse Video] (→[\[Time Lapse Video\]: 603](#)) or [Stop Motion Video] (→[\[Stop Motion Video\]: 603](#)) in the [Playback] menu.

1 Select [Yes] on the confirmation screen that appears after recording.

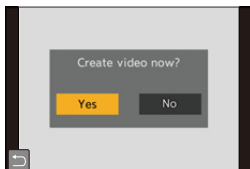

2 Set the options for creating a video.

3 Select [OK].

- A video will be created in the [MP4] recording file format.



[OK]

Creates a video.

[Rec Quality]

Sets the video image quality.

[Frame Rate]

Sets the number of frames per second.

The larger the number is, the smoother the video will be.

[Sequence]

[NORMAL]: Splices pictures together in recording order.

[REVERSE]: Splices pictures together in reverse recording order.

- Videos cannot be created when the [System Frequency] is set to [24.00Hz (CINEMA)].
- Videos cannot be created if the recording time exceeds 29 minutes and 59 seconds.
- In the following cases, videos cannot be created if the file size exceeds 4 GB:
 - When an SDHC memory card is being used and a 4K [Rec Quality] is set
 - When an FHD [Rec Quality] is set

Recording Using the Self-timer



1 Set the drive mode dial to [⌚].

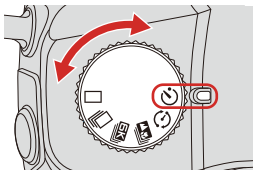

2 Set the Self-Timer time. (→ [Setting the Self-timer Time: 229](#))

- When recording videos, set [Self Timer For Video] in [Self Timer Setting] of the [Video] ([Others (Video)]) menu to [ON].

3 Close the menu.

- Press the shutter button halfway.

4 Decide on the composition and then adjust the focus.

- Press the shutter button halfway.
- The focus and exposure are fixed when the shutter button is pressed halfway.



5 Start recording.

- Press the shutter button (A) or video rec. button (B).
- After the self-timer light blinks, recording starts.

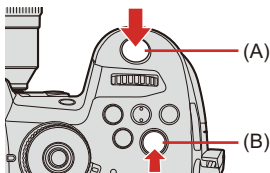











❖ Setting the Self-timer Time

When taking pictures

 →  →  → Select [Self Timer]

When recording videos

 →  →  → Select [Self Timer Setting]

[Self Timer]^{*1}	    etc. (Custom)	
	<p>: Takes a picture after 10 seconds.</p> <p>: Takes 3 pictures at approx. 2 second intervals after 10 seconds.</p> <p>(When recording video, it will be the same operation with .)</p> <p>: Takes a picture after 2 seconds.</p> <p>This setting is a convenient way to avoid camera shake caused by pressing the shutter button.</p> <p> etc. (Custom): Records after the number of seconds registered in [Custom Time].</p>	
	[SET]	<p>[Custom Time] ([2SEC] to [10SEC])</p> <p>[Display Countdown] ([ON]/[OFF])</p> <p>[Display Countdown]: Sets whether or not to display the count down on the recording screen when [Self Timer] is set to custom.</p>
[Self Timer For Video]^{*1}	<p>[ON]^{*1}/[OFF]^{*1}</p> <p>Sets whether or not to enable self timer during video recording.</p>	

*1 It will only be displayed when [Self Timer Setting] of the [Video] ([Others (Video)]) menu is selected.

- We recommend using a tripod when recording with the self-timer.
- When the following functions are being used, [⏸] is not available:
 - [Simultaneous Record w/o Filter] ([Filter Settings])
 - [Bracketing]
 - [Multiple Exposure]

Bracket Recording



When the shutter button is pressed, the camera can record multiple images while automatically changing the setting value for exposure, aperture, focus or white balance (adjustment value or color temperature).

- Aperture Bracket can be selected in the following modes:
 - [A] mode
 - [M] mode (when ISO sensitivity is set to [AUTO])
- White Balance Bracket (Color Temperature) can be selected when the white balance is set to [K₁], [K₂], [K₃], or [K₄].

1 Set [Bracketing Type].

- → → → [Bracketing] → [Bracketing Type]

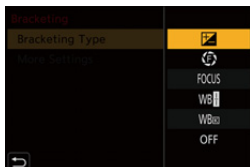

2 Set [More Settings].

- For information about [More Settings], refer to page for each bracketing method.

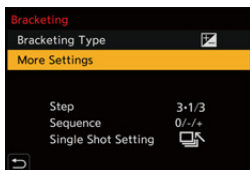





3 Close the menu.

- Press the shutter button halfway.

4 Focus on the subject and then take pictures.

❖ Setting Items ([Bracketing Type])

 Exposure Bracket	When the shutter button is pressed, the camera records while changing the exposure. (→ [More Settings] (Exposure Bracket): 235)
 Aperture Bracket	When the shutter button is pressed, the camera records while changing the aperture value. (→ [More Settings] (Aperture Bracket): 236)
 Focus Bracket	When the shutter button is pressed, the camera records while changing the focus point. (→ [More Settings] (Focus Bracket): 237)
 White Balance Bracket	When the shutter button is pressed once, the camera automatically records three images with the different white balance adjustment values. (→ [More Settings] (White Balance Bracket): 238)
 White Balance Bracket (Color Temperature)	When the shutter button is pressed once, the camera automatically records three images with the different white balance color temperatures. (→ [More Settings] (White Balance Bracket (Color Temperature)): 238)
[OFF]	—

❖ How to Cancel Bracketing

Select [OFF] in Step **1**.

- White Balance Bracket and White Balance Bracket (Color Temperature) are not available when using the following functions:
 - [iA] mode
 - Taking burst pictures
 - [RAW+FINE]/[RAW+STD.]/[RAW] ([Picture Quality])
 - [Filter Settings]
- Bracket recording is not available while you are using the following functions:
 - [6K/4K PHOTO]/[Post-Focus]
 - [Time Lapse Shot]
 - [Stop Motion Animation] (when [Auto Shooting] is set)
 - [Rough Monochrome]/[Silky Monochrome]/[Miniature Effect]/[Soft Focus]/[Star Filter]/[Sunshine] ([Filter Settings])
 - [Multiple Exposure]

❖ [More Settings] (Exposure Bracket)

[Step]	Sets the image count and exposure compensation step. [3•1/3] (record 3 images in 1/3 EV steps) to [7•1] (record 7 images in 1 EV steps)
[Sequence]	Sets the order in which images are recorded.
[Single Shot Setting]	<p>[□]: Takes only one image each time the shutter button is pressed.</p> <p>[📷]: Takes all of the set number of images when the shutter button is pressed once.</p> <ul style="list-style-type: none"> • The [BKT] icon blinks until all of the set number of pictures is taken.

- When you record images with Exposure Bracket after setting the exposure compensation value, the images recorded are based on the selected exposure compensation value.

❖ [More Settings] (Aperture Bracket)

<p>[Image Count]</p>	<p>[3]/[5]: Records the set number of images while alternately setting the aperture value in the sequence of one before and then one after using the initial aperture value as the reference.</p> <p>[ALL]: Records images using all aperture values.</p>
-----------------------------	---

Example when the initial position is set to F8.0 (H-ES12060)

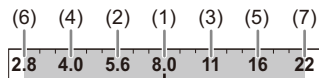

(1) 1st image, (2) 2nd image, (3) 3rd image ... (7) 7th image

❖ [More Settings] (Focus Bracket)

[Step]	<p>Sets the focus adjustment step.</p> <ul style="list-style-type: none"> The distance that the focus point is moved becomes shorter if the initial focus point is close, and longer if it is far away.
[Image Count]	<p>Sets the image count.</p> <ul style="list-style-type: none"> This cannot be set when taking burst pictures. Burst pictures are taken while the shutter button is pressed.
[Sequence]	<p>[0/-/+]: Records while alternately moving the focus point in the sequence of forward and then backward using the initial focus point as the reference.</p> <p>[0/+]: Records while moving the focus point toward the far side using the initial focus point as the reference.</p>

Example when [Sequence]: [0/-/+] is set

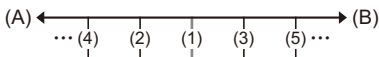

Example when [Sequence]: [0/+] is set

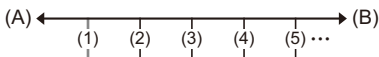





(A) Focus: closer

(B) Focus: more distant

(1) 1st image, (2) 2nd image ... (5) 5th image ...





• Pictures recorded with Focus Bracket are displayed as images of one group.

❖ [More Settings] (White Balance Bracket)

- 1 Rotate ,  or  to set the correction step and then press  or  .





Horizontal direction ([A] - [B])

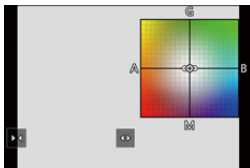

Vertical direction ([G] - [M])

- The correction step can also be set by touching []/[]/[]/[].



❖ [More Settings] (White Balance Bracket (Color Temperature))

- 1 Rotate ,  or  to set the correction step and then press  or  .

- The correction step can also be set by touching []/[].



[Silent Mode]



This disables all operation sounds and light output at once.

The audio from the speaker will be muted and the flash and the AF assist light will be set to forced off mode.

- The following settings are fixed:
 - [Flash Mode]: [🚫] (Forced Flash Off)
 - [AF Assist Light]: [OFF]
 - [Shutter Type]: [ELEC.]
 - [Beep Volume]: [🔇] (OFF)
 - [AF Beep Volume]: [🔇] (OFF)
 - [E-Shutter Vol]: [🔇] (OFF)



➡ [📷] ➡ [🔇] ➡ **Select [Silent Mode]**

Settings: [ON]/[OFF]

- Even when [ON] is set, the following functions light/blink:
 - Status indicator
 - Charging light/NETWORK connection lamp
 - Card access light
 - Self-timer light
- Use this function at your own responsibility sufficiently considering the privacy, portrait, and other rights of subjects.

[Shutter Type]



Selects the shutter type to use for taking pictures.

 →  →  → **Select [Shutter Type]**

[AUTO]	Switches the shutter type automatically depending on the recording conditions and shutter speed.
[MECH.]	Records with the mechanical shutter type.
[EFC]	Records with the electronic front curtain type.
[ELEC.]	Records with the electronic shutter type.
[ELEC.+NR]	Records with the electronic shutter type. When pictures are taken at slower shutter speeds, the shutter is closed after recording to perform long shutter noise reduction.

	Mechanical shutter type	Electronic front curtain type	Electronic shutter type
Mechanism	This type starts and ends exposure with the mechanical shutter.	This type starts exposure electronically and ends it with the mechanical shutter.	This type starts and ends exposure electronically.
Flash	✓	✓	—
Shutter speed (sec.)	[B] (Bulb, max. approx. 30 minutes) ^{*1} , 60 to 1/8000	[B] (Bulb, max. approx. 30 minutes) ^{*1} , 60 to 1/2000	[B] (Bulb, max. approx. 60 seconds) ^{*1} , 60 to 1/16000
Shutter sound	Mechanical shutter sound	Mechanical shutter sound	Electronic shutter sound ^{*2}

*1 This setting is available only in [M] mode.

*2 The electronic shutter sound can be set in [E-Shutter Vol] and [E-Shutter Tone] in [Beep] of the [Setup] ([IN/OUT]) menu. (→[Beep]: 588)

- The electronic front curtain type reduces blur caused by the shutter because the amount of vibration from the shutter is small compared to the mechanical shutter type.
- The electronic shutter type allows you to record without vibration from the shutter.



- To reduce shutter-induced blur, you can set the shutter to release a few seconds after the shutter button is pressed:
[] ⇒ [] ⇒ [Shutter Delay] (⇒ [\[Shutter Delay\]: 529](#))
- When [] is displayed on the screen, recording will be with the electronic shutter type.
- When a moving subject is recorded using the electronic shutter, the subject may appear distorted in the picture.
- When you record using the electronic shutter under lighting such as fluorescent or LED lighting, horizontal stripes may be recorded. In such a case, lowering the shutter speed may reduce the effect of horizontal stripes.
- When [Silent Mode] is being used, [Shutter Type] is fixed to [ELEC.].

Image Stabilizer

- [Image Stabilizer Settings: 246](#)







This camera can use both the in-body image stabilizer and the in-lens image stabilizer.

Compatible with the Dual I.S. method, which effectively combines two image stabilizers, and the Dual I.S.2 method, which has a higher stabilizing effect.

Furthermore, during video recording, you can use the 5-Axis Hybrid Image Stabilizer that incorporates electronic stabilization.

Combinations of lenses and image stabilizers (As of May 2021)

Image stabilizers that can be used will differ depending on the attached lens.

Attached lens	Available image stabilizer	Example of icon
Panasonic lenses compatible with Dual I.S. Mode (Based on the Micro Four Thirds System standard) <ul style="list-style-type: none"> If the [DUAL] or [DUAL2] icon is not displayed on the recording screen even when a compatible lens is used, update the lens firmware to the latest version. (→ Firmware of Your Camera/Lens: 19) 	Body+Lens (Dual I.S./Dual I.S.2)	DUAL / DUAL2  / 
Lenses compatible with the image stabilizer function (Based on the Micro Four Thirds System standard)	Body or Lens	
Lenses without image stabilizer	Body	
Lenses without communication function	Body	

- The 5-Axis Hybrid Image Stabilizer (→ [Image Stabilizer Settings: 246](#)) can be used with any lenses.

❖ Using the Image Stabilizer

- When using a lens with an O.I.S. switch, set the switch on the lens to [ON].
- When using a lens that does not have a communication function with this camera, after turning on the camera, a message asking for confirmation of the lens information is displayed.

Correctly operating the image stabilization function requires that the focal length and lens name be set to match the attached lens.



Follow the message to make the settings.

This can also be set using the menu. (→[\[Lens Information\]: 249](#))

- When the shutter button is pressed halfway, the camera shake alert icon [] may be displayed on the recording screen.

If this is displayed, we recommend using a tripod, the self timer or the Shutter Remote Control (DMW-RS2: optional).

- We recommend turning off the image stabilizer function when using a tripod.
- The image stabilizer may cause vibration or produce operational sound during operation, but these are not malfunctions.
- When using a lens that does not have a communication function with this camera, you can hide the message asking for confirmation of the lens information that is displayed after turning on the camera:

[] ⇒ [] ⇒ [Lens Info. Confirmation] (→[\[Lens Info. Confirmation\]: 582](#))



- You can display the reference point and check the camera shake status:

[] ⇒ [] ⇒ [I.S. Status Scope] (→[\[I.S. Status Scope\]: 572](#))

Image Stabilizer Settings

Set the image stabilizer operation to match the recording situation.



 →  →  → **Select [Image Stabilizer]**

[Operation Mode]	Sets the stabilization movement (blur) to match the recording method (normal, panning). (→ [Operation Mode]: 247)
[E-Stabilization (Video)]	<p>Camera shake during video recording is corrected along the vertical, horizontal, roll, pitch, and yaw axes through the combined use of the in-lens, in-body, and electronic image stabilizers. (5-Axis Hybrid Image Stabilizer)</p> <ul style="list-style-type: none"> • The [] on the recording screen changes to [] while [E-Stabilization (Video)] is functioning. • The angle of view may become narrower if set to [ON].
[Boost I.S. (Video)]	<p>Increases the effectiveness of the image stabilizer during video recording.</p> <p>This effect can help provide a stable composition when you want to perform recording from a fixed perspective. (→[Boost I.S. (Video)]: 248)</p>
[Anamorphic (Video)]	You can switch to an image stabilizer that suits anamorphic recording. (→ [Anamorphic (Video)]: 248)
[Lens Information]	When using a lens that does not have a communication function with the camera, register the lens information in the camera. (→ [Lens Information]: 249)

- When the following functions are being used, [E-Stabilization (Video)] is not available:
 - [Variable Frame Rate]
 - [Live Cropping]

❖ [Operation Mode]

Set the stabilization movement (blur) to match the recording method (normal, panning).

 [Normal]	Corrects vertical, horizontal, and rotational camera shake. This function is suitable for normal recording.
 [Panning (Left/Right)]	Corrects vertical camera shake. This is suitable for horizontal panning.
 [Panning (Up/Down)]	Corrects horizontal camera shake. This is suitable for vertical panning.
[OFF]	Turns the image stabilization function OFF.

- The [Operation Mode] that can be used differ depending on the lens used.
- When using lenses with an O.I.S. switch, the camera's operation mode cannot be set to [OFF]. Set the switch on the lens to [OFF].
- When the following functions are being used, [Operation Mode] switches to  ([Normal]):
 - [M] mode
 - Video recording/[6K/4K PHOTO]/[Post-Focus]

❖ [Boost I.S. (Video)]

Increase the effectiveness of the image stabilizer during video recording. This effect can help provide a stable composition when you want to perform recording from a fixed perspective.





Settings: [ON]/[OFF]



- When [Boost I.S. (Video)] is operating, [] is displayed on the recording screen.
- To change composition while recording, first set this to [OFF] before moving the camera.
To set this to [OFF] during recording, use the Fn button. (→ [Fn Buttons: 471](#))
- Longer focal lengths will result in weaker stabilization.

❖ [Anamorphic (Video)]

You can switch to an image stabilizer that suits anamorphic recording.

Settings:

[]([2.0×])/[]([1.8×])/[]([1.5×])/[]([1.33×])/[]([1.30×])/[OFF]



- Make settings to suit the magnification of the anamorphic lens you are using.
- While [Anamorphic (Video)] is functioning, the set magnification appears on the image stabilizer icons on the recording screen, as shown by [] and [].

- When [Boost I.S. (Video)] is set, [Boost I.S. (Video)] is prioritized.
- Image stabilizer functions on your lens may not work correctly. Turn off the image stabilizer function on your lens if this is the case.

❖ [Lens Information]



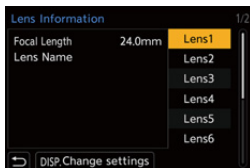

Register the information for lenses that cannot communicate with the camera.

Match the in-body image stabilizer with the information of the lens you register.

- 1 Press ▲▼ to select the lens information to use and then press  or  .
 - In the default setting, the lens information for 6 lenses with a focal length of between 24 mm and 135 mm is registered.
The lens information for up to 12 lenses can be registered.





Registering, modifying, and deleting lens information

- 1 Press ▲▼ to select the lens information and then press [DISP].
 - If lens information that has not been registered is selected, press  or  to proceed to Step 3.
- 2 Press ▲▼ to select [Edit] or [Delete] and then press  or .
 - The lens information is deleted when you select [Delete].
 - You cannot delete the lens information for a lens that is being used.
- 3 Enter the lens Information.
 - The lens information changes if the lens information has already been registered.

[Focal Length]

Enter the focal length.

- The live view images can be enlarged for display when you rotate  or .

[Lens Name]

Register the lens.

- For information on how to enter characters (→ [Entering Characters: 609](#))
- Up to a maximum of 30 characters can be entered.

-
- 4 (If lens information that has not been registered is selected) Press [DISP.] to register the lens information.

7. Metering/Exposure/ISO Sensitivity

- [Metering Mode]: 252
- Program AE Mode: 253
- Aperture-Priority AE Mode: 257
- Shutter-Priority AE Mode: 260
- Manual Exposure Mode: 263
- Preview Mode: 267
- Exposure Compensation: 269
- Locking Focus and Exposure (AF/AE Lock): 271
- ISO Sensitivity: 273

[Metering Mode]



Type of optical measurement to measure brightness can be changed.

MENU / SET → **[CAMERA]** → **[METERING]** → **Select [Metering Mode]**

[CAMERA] (Multi-metering)	Method in which the most suitable exposure is measured by judging the allocation of brightness on the whole screen.
[CAMERA] (Center-weighted)	Method used to perform measuring which focuses on the center of the screen.
[CAMERA] (Spot)	Method used to measure the extremely small part around the spot-metering target (A). <ul style="list-style-type: none"> When you move the AF area, the spot metering target also moves to match. 
[CAMERA] (Highlight-weighted)	Method used to perform measuring which focuses on the highlighted parts of the screen to prevent overexposure. This is suitable for theater photography, etc.

- The standard value for correct exposure can be adjusted:

[CAMERA] → **[METERING]** → [Exposure Offset Adjust.] (→ [\[Exposure Offset Adjust.\]: 550](#))

Program AE Mode



In [P] mode (Program AE mode), the camera automatically sets the shutter speed and aperture value for the brightness of the subject.

You can also use Program Shift to change combinations of shutter speed and aperture values while keeping the same exposure.

1 Set the mode dial to [P].

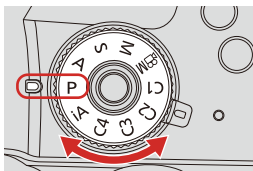

2 Press the shutter button halfway.

- This displays the aperture value and shutter speed value on the recording screen.

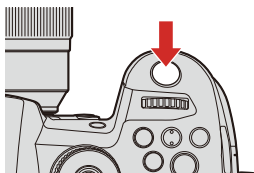

- If the correct exposure is not achieved, the aperture value and shutter speed blink red.

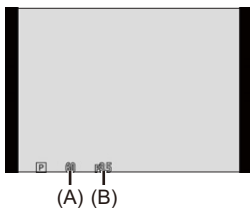

3 Start recording.



- (A) Shutter speed
(B) Aperture value

❖ Program Shift



You can change the shutter speed and aperture value combination set automatically by the camera while maintaining the same exposure. With this, you can, for example, make the background more defocused by decreasing the aperture value or capture a moving subject more dynamically by slowing the shutter speed.

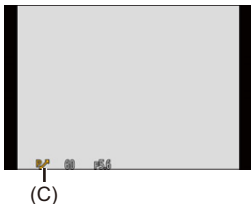



- 1 Press the shutter button halfway.
 - This displays the aperture value and shutter speed value on the recording screen. (Approx. 10 seconds)
- 2 Rotate  or  while the values are displayed.
 - This displays the Program Shift icon (C) on the recording screen.



- 3 Start recording.

Canceling Program Shift

- Set the camera on/off switch to [OFF].
- Rotate  or  until the Program Shift icon disappears.

- Program Shift is not available when using the following functions:
 - Flash
 - [6K/4K PHOTO]/[Post-Focus]
- You can customize dial operations:
 - [] ⇒ [] ⇒ [Dial Set.] ⇒ [Assign Dial (F/SS)]/[Rotation (F/SS)] (⇒ [\[Dial Set.\]: 562](#))
- The recording screen can display an exposure meter indicating the relationship between aperture value and shutter speed:
 - [] ⇒ [] ⇒ [Expo.Meter] (⇒ [\[Expo.Meter\]: 571](#))

Aperture-Priority AE Mode



In [A] mode (Aperture-Priority AE mode), you can set the aperture value before recording.

The shutter speed will be automatically set by the camera.



Smaller aperture values

It becomes easier to defocus the background.



Larger aperture values

It becomes easier to bring everything into focus including the background.

1 Set the mode dial to [A].

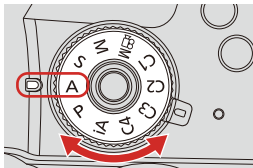

2 Set the aperture value.

- Rotate  or .

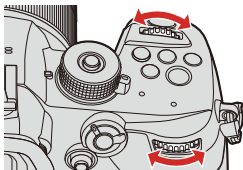







3 Start recording.



- If the correct exposure is not achieved when the shutter button is pressed halfway, the aperture value and the shutter speed blink red.

❖ Depth of Field Characteristics

Aperture value	Small	Large
Focal length of lens	Telephoto	Wide-angle
Distance to subject	Near	More distant
Depth of field (area in sharp focus)	Shallow (narrow) Example: When you want to take a image with a defocused background.	Deep (wide) Example: When you want to take a image with focus as far as the background.

- The effects of the set aperture value and shutter speed will not be visible on the recording screen.
To check the effects on the recording screen, use [Preview]. (→ [Preview Mode: 267](#))
You can set the preview of the aperture effect to constantly operate in [A] mode to check the depth of field while recording:
[] ⇒ [] ⇒ [Constant Preview] (→ [Constant Preview: 565](#))
- The brightness of the recording screen and of actual recorded images may differ.
Check the images on the playback screen.
- When using a lens with an aperture ring, set the position of the aperture ring to other than [A] to use the aperture value of the lens.
- You can customize dial operations:
[] ⇒ [] ⇒ [Dial Set.] ⇒ [Assign Dial (F/SS)]/[Rotation (F/SS)] (→ [Dial Set.: 562](#))
- The recording screen can display an exposure meter indicating the relationship between aperture value and shutter speed:
[] ⇒ [] ⇒ [Expo.Meter] (→ [Expo.Meter: 571](#))

Shutter-Priority AE Mode



In [S] mode (Shutter-Priority AE mode), you can set the shutter speed before recording.

The aperture value will be automatically set by the camera.



Slower shutter speeds

It becomes easier to capture motion.



Faster shutter speeds

It becomes easier to freeze motion.

1 Set the mode dial to [S].

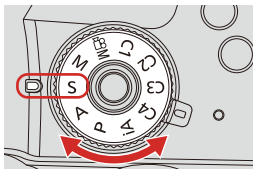

2 Set the shutter speed.



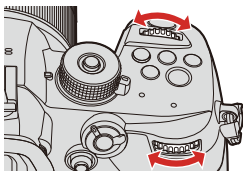

- Rotate  or .

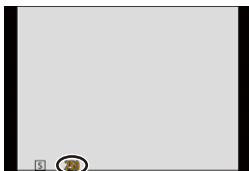

3 Start recording.



- If the correct exposure is not achieved when the shutter button is pressed halfway, the aperture value and the shutter speed blink red.

- The effects of the set aperture value and shutter speed will not be visible on the recording screen.
To check the effects on the recording screen, use [Preview]. (→ [Preview Mode: 267](#))
- The brightness of the recording screen and of actual recorded images may differ. Check the images on the playback screen.
- Shutter speeds faster than 1/250 of a second are not available when recording using a flash. (→ [Shutter Speeds for Flash Modes: 311](#))
- You can customize dial operations:
[] ⇒ [] ⇒ [Dial Set.] ⇒ [Assign Dial (F/SS)]/[Rotation (F/SS)] (→ [Dial Set.:](#) 562)
- The recording screen can display an exposure meter indicating the relationship between aperture value and shutter speed:
[] ⇒ [] ⇒ [Expo.Meter] (→ [Expo.Meter:](#) 571)

Manual Exposure Mode



In [M] mode (Manual Exposure mode), you can take pictures by manually setting the aperture value and shutter speed.

In default settings, the ISO sensitivity is set to [AUTO].



As a result, the ISO sensitivity will be adjusted according to the aperture value and shutter speed.

Exposure compensation can also be used when ISO sensitivity is set to [AUTO].

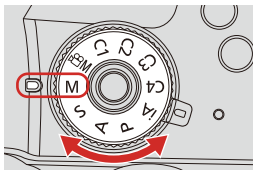
1 Set the mode dial to [M].



2 Set the aperture value and shutter speed.

- Rotate  to set the aperture value, and  to set the shutter speed.

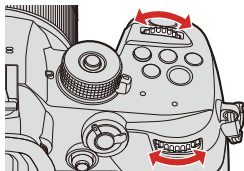

3 Start recording.

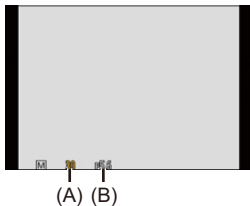

- (A) Shutter speed
(B) Aperture value

- If the correct exposure is not achieved when the shutter button is pressed halfway, the aperture value and the shutter speed blink red.

❖ Available Shutter Speeds (Sec.)





- **[MECH.]**
[B] (Bulb, max. approx. 30 minutes), 60 to 1/8000
- **[EFC]**
[B] (Bulb, max. approx. 30 minutes), 60 to 1/2000
- **[ELEC.]**
[B] (Bulb, max. approx. 60 seconds), 60 to 1/16000

- The effects of the set aperture value and shutter speed will not be visible on the recording screen.

To check the effects on the recording screen, use [Preview]. (→ [Preview Mode: 267](#))

You can set the preview of the aperture effect and the shutter speed effect to constantly operate in [M] mode to check the depth of field and movement of the subject while recording:

[] ⇒ [] ⇒ [Constant Preview] (→ [Constant Preview: 565](#))

- The brightness of the recording screen and of actual recorded images may differ. Check the images on the playback screen.
- When using a lens with an aperture ring, set the position of the aperture ring to other than [A] to use the aperture value of the lens.
- Shutter speeds faster than 1/250 of a second are not available when recording using a flash. (→ [Shutter Speeds for Flash Modes: 311](#))
- You can customize dial operations:
[] ⇒ [] ⇒ [Dial Set.] ⇒ [Assign Dial (F/SS)]/[Rotation (F/SS)] (→ [Dial Set.:](#) 562)
- The recording screen can display an exposure meter indicating the relationship between aperture value and shutter speed:
[] ⇒ [] ⇒ [Expo.Meter] (→ [Expo.Meter:](#) 571)

❖ Manual Exposure Assist

When ISO sensitivity is set to other than [AUTO], Manual Exposure Assist (example: **MM+1**) will be displayed on the recording screen.

You can check the difference between the current exposure value and the standard exposure (± 0) measured by the camera.

- Use Manual Exposure Assist as a guide.

We recommend checking the images on the playback screen when recording.

❖ [B] (Bulb)

If you set the shutter speed to [B] (Bulb), the shutter stays open while the shutter button is pressed fully. (up to approx. 30 minutes)

The shutter closes when the shutter button is released.

Use this when you want to keep the shutter open for a long time to record images of fireworks, night scenery or a starry sky.

- We recommend using a tripod or the Shutter Remote Control (DMW-RS2: optional) during bulb recording.
- Bulb recording may create noticeable noise.
If you are concerned about noise, we recommend that you set [Long Exposure NR] (→[Long Exposure NR]: 519) to [ON] in the [Photo] ([Image Quality]) menu before recording.
- Bulb is not available when using the following functions:
 - [6K/4K PHOTO]/[Post-Focus]
 - [Time Lapse Shot]
 - [Stop Motion Animation] (when set to [Auto Shooting])
 - [Bracketing]

Preview Mode



You can check the effects of aperture on the recording screen by physically closing the aperture blades of the lens to the aperture value set for actual recording.

In addition to the effects of aperture, you can check the effects of shutter speed at the same time.

- Use the Fn button registered with [Preview] to operate. In default settings, this is registered in the [Fn2] button.

For information about the Fn button (→ [Fn Buttons: 471](#))

1 Press the preview button.

- Each press of the button switches between the effect preview screens.

Aperture effect: OFF

Shutter speed effect: OFF



Aperture effect: ON

Shutter speed effect: OFF



Aperture effect: ON

Shutter speed effect: ON

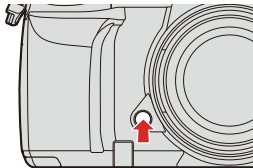

- It is possible to record in preview mode.
- Range for shutter speed effect check is 8 seconds to 1/16000 of a second.
- Preview mode is not available when recording with [6K/4K Pre-Burst].
- Depending on the [Constant Preview] setting, there are preview screens that cannot be displayed.

Exposure Compensation



You can compensate the exposure when the standard exposure determined by the camera is too bright or too dark.

You can adjust the exposure in 1/3 EV steps in a range of ± 5 EV.

When recording videos or recording with 6K/4K photo or Post-Focus, the range changes to ± 3 EV.

1 Press [].

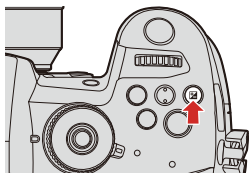





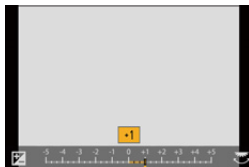



2 Compensate the exposure.

- Rotate  ,  , or  .



3 Confirm your selection.

- Press the shutter button halfway.

- In [M] mode, you can compensate the exposure by setting the ISO sensitivity to [AUTO].
- When the exposure compensation value falls below or exceeds ± 3 EV, the brightness of the recording screen will no longer change.
Press the shutter button halfway or use AE Lock to reflect the value on the recording screen.
- The set exposure compensation value is stored even if you turn off the camera.
- The standard value for standard exposure can be adjusted:
[] \Rightarrow [] \Rightarrow [Exposure Offset Adjust.] (\Rightarrow [[Exposure Offset Adjust.:](#) 550])
- You can set the exposure compensation value to be reset when the camera is turned off:
[] \Rightarrow [] \Rightarrow [Exposure Comp. Reset] (\Rightarrow [[Exposure Comp. Reset:](#) 551])
- You can change the operation of the [] button:
[] \Rightarrow [] \Rightarrow [WB/ISO/Expo. Button] (\Rightarrow [[WB/ISO/Expo. Button:](#) 561])
- Exposure Bracket can be set and flash output can be adjusted on the exposure compensation screen:
[] \Rightarrow [] \Rightarrow [Exposure Comp. Disp. Setting] (\Rightarrow [[Exposure Comp. Disp. Setting:](#) 561])

Locking Focus and Exposure (AF/AE Lock)



Lock the focus and exposure in advance to take pictures with the same focus and exposure settings while changing the composition.

This is useful when you want to bring an edge of the screen into focus or there is a backlight, for example.

1 Register [AE LOCK], [AF LOCK], or [AF/AE LOCK] to the Fn button. (→ [Fn Buttons: 471](#))

- These cannot be registered to [Fn3] to [Fn7].

[AE LOCK]

The exposure is locked.

[AF LOCK]

The focus is locked.

[AF/AE LOCK]

Both focus and exposure are locked.

2 Lock focus and exposure.

- Press and hold the Fn button.
- If focus is locked, then the AF lock icon will be displayed.
- If exposure is locked, then the AE lock icon will be displayed.

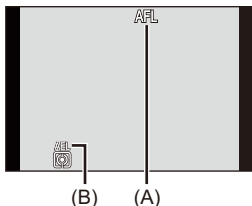

(A) AF lock icon (AFL)

(B) AE lock icon (AEL)

3 Hold the Fn button to decide on the composition and then perform recording.

- Press the shutter button fully.

- In the [M] mode, the AE Lock can be used when ISO sensitivity is set to [AUTO].
- Program Shift can be set even when AE is locked.
- You can maintain lock even without pressing and holding the Fn button:
[] ⇒ [[AF]] ⇒ [AF/AE Lock Hold] (⇒ [\[AF/AE Lock Hold\]: 553](#))

ISO Sensitivity





You can set light sensitivity (ISO sensitivity).

With the default settings, you can set 200 to 25600 in 1/3 EV increments.

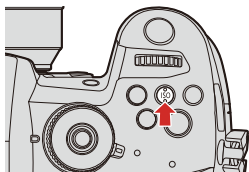
1 Press [ISO].



2 Select ISO sensitivity.

- Rotate  ,  , or  .
- Selection is also possible by pressing [ISO].

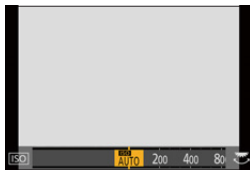

3 Confirm your selection.

- Press the shutter button halfway.

Characteristics of the ISO Sensitivity

By increasing the ISO sensitivity, the shutter speed can be increased in dark places to prevent camera shake and subject blur. However, higher ISO sensitivities also increase the amount of noise in the recorded images.



















❖ Setting Items (ISO Sensitivity)

[AUTO]	<p>The ISO sensitivity is automatically adjusted according to the brightness.</p> <ul style="list-style-type: none"> • Taking picture: Maximum [3200]^{*1} • Video recording: Maximum [6400]^{*2}
[200] to [25600]	<p>The ISO sensitivity is fixed at the selected value.</p> <ul style="list-style-type: none"> • You can extend the ISO sensitivity lower limit to [100] by setting [Extended ISO] (→[Extended ISO]: 550) to [ON] in the [Custom] ([Image Quality]) menu.

*1 Default setting. The upper limit can be changed with [ISO Sensitivity (photo)].

*2 Default setting. The upper limit can be changed with [ISO Sensitivity (video)].

- When the following functions are being used, the ISO sensitivity that can be set is restricted.
 - [High Dynamic] ([Filter Settings]): Fixed to [AUTO]
 - Other than [High Dynamic] ([Filter Settings]): Up to an upper limit of [3200]
 - [Multiple Exposure]: Down to a lower limit of [200], up to an upper limit of [3200]
 - [Like709] ([Photo Style]): Down to a lower limit of [200]
 - [V-Log L] ([Photo Style]): Down to a lower limit of [400]
 - [Hybrid Log Gamma] ([Photo Style]): Down to a lower limit of [400]
 - [pCM] mode, [6K/4K PHOTO], [Post-Focus]: Up to an upper limit of [12800]
- During video recording, the camera operates as [AUTO]. (When not in [pCM] mode)

- You can set upper and lower limits for ISO Auto:
 - [] → [] → [ISO Sensitivity (photo)] (→ [\[ISO Sensitivity \(photo\)\]: 520](#))
 - [] → [] → [ISO Sensitivity (video)] (→ [\[ISO Sensitivity \(video\)\]: 362](#))
- You can change the intervals between ISO sensitivity settings values:
[] → [] → [ISO Increments] (→ [\[ISO Increments\]: 549](#))
- The setting range of ISO sensitivity can be extended:
[] → [] → [Extended ISO] (→ [\[Extended ISO\]: 550](#))
- You can change the ISO sensitivity setting method when recording video in [P]/[A]/[S]/[M] modes from automatic to manual:
[] → [] → [Auto Exposure in P/A/S/M] (→ [\[Auto Exposure in P/A/S/M\]: 551](#))
- You can set the lower limit for shutter speed for ISO Auto:
[] → [] → [Min. Shutter Speed] (→ [\[Min. Shutter Speed\]: 520](#))
- You can change the operation of the [ISO] button:
[] → [] → [WB/ISO/Expo. Button] (→ [\[WB/ISO/Expo. Button\]: 561](#))
- You can set the upper limit for ISO Auto on the ISO sensitivity settings screen:
[] → [] → [ISO Displayed Setting] (→ [\[ISO Displayed Setting\]: 561](#))
- You can change the units for sensitivity to dB when recording video:
[] → [] → [SS/Gain Operation] (→ [\[SS/Gain Operation\]: 370](#))

8. White Balance/Image Quality

- [White Balance \(WB\): 278](#)
- [\[Photo Style\]: 285](#)
- [\[Filter Settings\]: 293](#)

White Balance (WB)

- [Adjusting the White Balance: 283](#)



White balance (WB) is a function that corrects the color cast produced by the light illuminating the subject.

It corrects the colors so that white objects appear in white to make the overall color closer to what is seen by the eye.



Normally, you can use auto ([AWB], [AWBc] or [AWBw]) to obtain the optimal white balance.

Set this function when the coloring of the image is different from what you expected, or you want to change the coloring to capture the ambience.

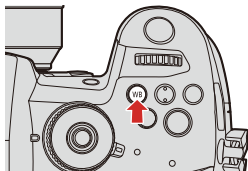
1 Press [WB].



2 Select the white balance.

- Rotate ,  or .
- Selection is also possible by pressing [WB].



3 Confirm your selection.

- Press the shutter button halfway.

❖ Setting Items (White Balance)

[AWB]	Auto
[AWBc]	Auto (Reduces the reddish hue under an incandescent light source)
[AWBw]	Auto (Leaves the reddish hue under an incandescent light source)
[☀]	Clear sky
[☁]	Cloudy sky
[🏠]	Shade under a clear sky
[☀-]	Incandescent light
[WB] ^{*1}	Flash
[1] to [4]	Set mode 1 to 4 (→ Registering the White Set: 282)
[K1] to [K4]	Color temperatures 1 to 4 (→ Color Temperature Setting: 282)

*1 It operates as [AWB] during video recording or when recording with [6K/4K PHOTO] or [Post-Focus].

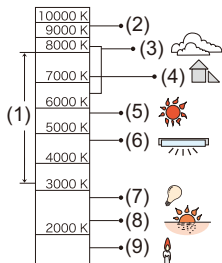

K=Kelvin Color Temperature

- (1) [AWB] will work within this range.
- (2) Blue sky
- (3) Cloudy sky (Rain)
- (4) Shade
- (5) Sunlight
- (6) White fluorescent light
- (7) Incandescent light bulb
- (8) Sunrise and sunset
- (9) Candlelight

- Under lighting such as fluorescent or LED lighting, the appropriate white balance will vary depending on the lighting type.





Use [AWB], [AWBc], [AWBw] or [] to [].

- The white balance is fixed to [AWB] while [Filter Settings] is being used.
- You can change the operation of the [WB] button:

[] ⇒ [] ⇒ [WB/ISO/Expo. Button] (⇒ [WB/ISO/Expo. Button]: 561)







❖ Registering the White Set

Take pictures of a white object under the light source of the recording location to adjust the white balance until it appears white.

- 1 Press [WB] and then select any value from [] to [].
- 2 Press ▲.
- 3 Aim the camera at a white object so that it appears inside the frame at the center of the screen and then press  or .
 - This will set the white balance and return you to the recording screen.

❖ Color Temperature Setting

Set the numeric value for the white balance color temperature.

- 1 Press [WB] and then select any value from [] to [].
- 2 Press ▲.
 - The color temperature setting screen is displayed.
- 3 Press ▲▼ to select the color temperature and then press  or .
 - You can set the White Balance Bracket (Color Temperature) by rotating ,  or . (→ [\[More Settings\] \(White Balance Bracket \(Color Temperature\): 238\)](#))

- You can set a color temperature from [2500K] to [10000K].

Adjusting the White Balance

You can adjust the coloring even when the coloring you want to apply is not produced by the selected white balance.

1 Press [WB].

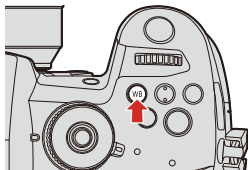

2 Select the white balance and then press ▼.

- The adjustment screen is displayed.

3 Adjust the coloring.

◀: [A] (AMBER: ORANGE)

▲: [G] (GREEN: GREENISH)

▶: [B] (BLUE: BLUISH)

▼: [M] (MAGENTA: REDDISH)

- You can also touch the graph to make adjustments.
- Press [DISP.] to return to the unadjusted state.
- You can set the White Balance Bracket by rotating 🌞, 🌧️ or ⚙️.
(→[More Settings] (White Balance Bracket): 238)



4 Confirm your selection.

- Press the shutter button halfway.

- When the white balance is adjusted, the color of its recording screen icon changes to the adjusted color.

Adjusting toward the [G] side will display [+], while adjusting toward the [M] side will display [-].

[Photo Style]











You can select the finishing settings of images to suit your subjects and expression styles.

The image quality can be adjusted for each Photo Style.

→ → → **Select [Photo Style]**

- You can also display the setting screen of [Photo Style] by pressing .

[Standard]	The standard setting.
[Vivid]	A setting that produces a more vivid quality with higher saturation and contrast.
[Natural]	A setting that produces a softer quality with lower contrast.
[L.ClassicNeo]	A setting for a film-like effect that has a nostalgic, soft coloring.
[Flat]	A setting that produces a flatter image quality with lower saturation and contrast.
[Landscape]	A setting suited for sceneries with vivid blue skies and greens.
[Portrait]	A setting suited for portraits with a healthy and beautiful skin tone.
[Monochrome]	A monochrome setting with no color shades.



 [L.Monochrome]	A black-and-white setting with rich gradation and crisp black accents.
 [L.Monochrome D]	A monochrome setting that creates a dynamic impression with enhanced highlights and shadows.
 [L.Monochrome S]	A setting for a black and white effect with a gentle touch suited to portraits.
 [Cinelike D2]	A setting that creates a film-like finishing touch using a gamma curve and gives priority to the dynamic range. <ul style="list-style-type: none"> • This function is suitable for video editing processes.
 [Cinelike V2]	A setting that creates a film-like finishing touch using a gamma curve that gives priority to the contrast.
 [Like709]	A setting that minimizes overexposure by applying a gamma curve correction equivalent to Rec.709 to perform compression (knee adjustment) of high-luminance areas. <ul style="list-style-type: none"> • Rec.709 is an abbreviation of "ITU-R Recommendation BT.709", a standard for high definition broadcasting.
 [V-Log L]	Gamma curve setting intended for post production processing. <ul style="list-style-type: none"> • It allows you to add rich gradation to images during post production editing.
 [Hybrid Log Gamma]	A setting for recording motion pictures with a wide dynamic range in HLG format. (➔ HLG Videos: 400)



[MY PHOTO STYLE 1]¹ to
[MY PHOTO STYLE 10]**¹**

Adjusts the image quality of Photo Style items to your preferred settings and registers these as My Photo Style items. (→ [Registering Settings in My Photo Style: 292](#))

*1 Effects up to [MY PHOTO STYLE 4] are displayed with the default settings. You can set the items to display in the menu with [Show/Hide Photo Style] in [Photo Style Settings]. (→ [\[Photo Style Settings\]: 549](#))

- In [iA] mode, operation differs from that in other recording modes.
 - [Standard] or [Monochrome] can be set.
 - The setting will be reset to [Standard] when the camera is switched to another recording mode or it is turned off.
 - Image quality cannot be adjusted.
- The range of available ISO sensitivities is different when [Photo Style] is set to the following: (→ [Setting Items \(ISO Sensitivity\): 275](#))
 - [Like709], [V-Log L], [Hybrid Log Gamma]
- You can set the knee mode with [Like709]. (→ [Recording While Controlling Overexposure \(Knee\): 360](#))
- When [Filter Settings] is being used, [Photo Style] is not available.
- You can make detailed Photo Style settings:
[] ⇒ [] ⇒ [Photo Style Settings] (→ [\[Photo Style Settings\]: 549](#))





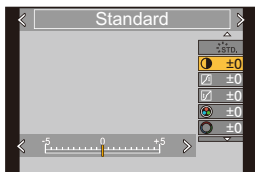





❖ Adjusting Image Quality



- 1 Press ◀▶ to select the type of Photo Style.
- 2 Press ▲▼ to select an item and then press ◀▶ to adjust.
 - Adjusted items are indicated with [*].





- 3 Press **MENU/SET** or .
 - When the image quality is adjusted, the Photo Style icon on the recording screen is indicated with [*].

Settings Items (Image Quality Adjustment)

	[Contrast]	Adjusts the contrast in the image.
	[Highlight]	Adjusts the brightness of bright areas.
	[Shadow]	Adjusts the brightness of dark areas.
	[Saturation]	Adjusts the vividness of colors.
	[Color Tone]	Adjusts blue and yellow tints.
	[Hue]	Assuming that the reference point is red, this rotates the hue toward violet/magenta or yellow/green to adjust the coloring of the entire image.
	[Yellow]	Enhances the contrast. (Effect: weak) Records the sky with a clear blue.
	[Orange]	Enhances the contrast. (Effect: medium) Records the sky with a darker blue.
	[Red]	Enhances the contrast. (Effect: strong) Records the sky with a much darker blue.
	[Green]	Skin and lips of people appear in natural tones. Green leaves appear brighter and more enhanced.
	[Off]	—
	[Low]/ [Standard]/ [High]	Sets the grain effect level.
	[Off]	—
	[Color Noise]	Color can be added with a grainy texture.
	[Sharpness]	Adjusts the outlines in the image.

NR [Noise Reduction]	Adjusts the noise reduction effect. <ul style="list-style-type: none"> Increasing the effect may cause a slight drop in picture resolution.
ISO [Sensitivity] ^{*1}	Sets the ISO sensitivity. (→ ISO Sensitivity: 273)
WB [White Balance] ^{*1}	Sets the white balance. (→ White Balance (WB): 278) <ul style="list-style-type: none"> While [WB] is selected, press [] to display the white balance setting screen. Press [] again to return to the original screen.

*1 Available when the following is set while [MY PHOTO STYLE 1] to [MY PHOTO STYLE 10] are selected:

[] ⇒ [] ⇒ [Photo Style Settings] ⇒ [My Photo Style Settings] ⇒ [Add Effects] ⇒ [Sensitivity]/[White Balance] ⇒ [ON]

- The items that you can adjust the image quality for depend on the Photo Style type.





	✓	✓	✓	—	—
	✓	✓	✓	—	—
	✓	✓	✓	—	—
 [[Saturation]]	✓	✓	—	✓	—
 [[Color Tone]]	—	—	✓	—	—
	✓	✓	—	✓	—
	—	—	✓	—	—
	—	✓	✓	—	—
	—	✓ ^{*2}	—	—	—
	✓	✓	✓	✓	✓
	✓	✓	✓	✓	✓

*2 Can be set when [Grain Effect] is one of [Low], [Standard], or [High].

- The effects of [Grain Effect] and [Color Noise] cannot be checked on the recording screen.
- [Grain Effect] and [Color Noise] are not available when using the following functions:
 - Video recording/[6K/4K PHOTO]/[Post-Focus]

❖ Registering Settings in My Photo Style



- 1 Press ◀▶ to select the type of Photo Style.
- 2 Adjust the image quality.
 - My Photo Style displays the types of Photo Style at the top of image quality adjustment.
Select the base Photo Style.
- 3 Press [DISP.].
- 4 (When [MY PHOTO STYLE 1] to [MY PHOTO STYLE 10] is selected)
Press ▲▼ to select [Save Current Setting] and then press  or .
- 5 Press ▲▼ to select the registration destination number and then press  or .
 - A confirmation screen will be displayed.
On the confirmation screen, press [DISP.] to change the My Photo Style name.
Up to 22 characters may be entered. Double-byte characters are treated as 2 characters.
How to enter characters (→ [Entering Characters: 609](#))

❖ Changing the Registered Contents of My Photo Style

- 1 Select any value from [MY PHOTO STYLE 1] to [MY PHOTO STYLE 10].
- 2 Press [DISP.] and then set the item.
 - [Load Preset Setting]
 - [Save Current Setting]
 - [Edit Title]
 - [Restore to Default]

[Filter Settings]

- [Simultaneous Record w/o Filter]: 302



This mode records with additional image effects (filters).

You can adjust the effect for each filter.



In addition, you can simultaneously take pictures without effects.

1 Set the [Filter Effect].

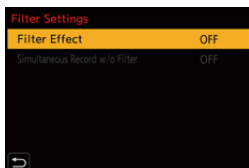
-  → [] → [] → [Filter Settings] → [Filter Effect] → [SET]



2 Select the filter.

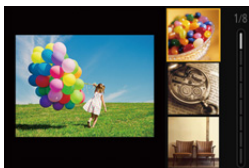

- Press ▲▼ to select, and then press  or .
- You can also select the image effect (filter) by touching the sample picture.
- Press [DISP.] to switch the screen in the order of normal display, guide display, and list display.

The guide display shows the description of each filter.





❖ Adjusting the Filter Effect

You can adjust the filter effect.



- 1 Select the filter.
- 2 On the recording screen, press [WB].
- 3 Rotate ,  or  to set.
 - To return to the recording screen, press [WB] again.
 - When the filter effect is adjusted, the filter icon on the recording screen is indicated with [*].





Filter	Items that can be adjusted
[Expressive]	Vividness
[Retro]	Coloring
[Old Days]	Contrast
[High Key]	Coloring
[Low Key]	Coloring
[Sepia]	Contrast
[Monochrome]	Coloring
[Dynamic Monochrome]	Contrast
[Rough Monochrome]	Grittiness
[Silky Monochrome]	Defocus level
[Impressive Art]	Vividness
[High Dynamic]	Vividness
[Cross Process]	Coloring
[Toy Effect]	Coloring
[Toy Pop]	Area with reduced peripheral brightness
[Bleach Bypass]	Contrast
[Miniature Effect]	Vividness
[Soft Focus]	Defocus level
[Fantasy]	Vividness
[Star Filter]	 Short rays/Long rays
	 Few rays/Many rays
	 Rotate to left/Rotate to right
[One Point Color]	Amount of color left
[Sunshine]	Coloring

❖ Setting a Filter with Touch Operation



- The default settings are for the Touch Tab to not be displayed.
Set [Touch Tab] to [ON] in [Touch Settings] in the [Custom] ([Operation]) menu.
(→ [Touch Settings]: 559)

- 1 Touch [].
- 2 Touch the item to set.
[]: Filter on/off
[EXPS]: Filter
[]: Filter effect adjustment





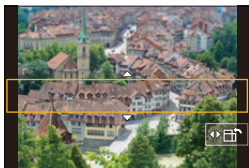

- White balance will be fixed to [AWB] and the flash will be fixed to [] (Forced Flash Off).
- The upper limit to ISO sensitivity is [3200].
- When [High Dynamic] is set, the ISO sensitivity is fixed to [AUTO].
- Depending on the filter, the recording screen may seem as if frames are missed.
- [Rough Monochrome]/[Silky Monochrome]/[Soft Focus]/[Star Filter]/[Sunshine] are not available when using the following function:
 - [M] mode
- When [Image Area of Video] is [PIXEL/PIXEL], recording video with [Toy Effect]/[Toy Pop] is not possible.
- [Filter Effect] is not available when using the following functions:
 - [Multiple Exposure]
 - [Live Cropping]
- When displaying the [Filter Effect] setting screen using the Fn button, pressing [DISP.] displays the filter selection screen.

❖ Setting the Type of Defocus ([Miniature Effect])



- 1 Set [Filter Effect] to [Miniature Effect].
- 2 Press ▲ to display the setting screen.
 - The setting screen can also be displayed by touching [] then [].
- 3 Press ▲▼ or ◀▶ to move the in-focus portion.
 - You can also move the in-focus portion by touching the screen.
 - You can also switch the defocus orientation by touching [].



- 4 Rotate ,  or  to change the size of in-focus portion.
 - The portion can also be enlarged/reduced by pinching out/pinching in the screen.
 - To reset the in-focus portion setting to the default, press [DISP.].
- 5 Press  or  to set.

- No audio is recorded in videos.
- When the system frequency is set to [59.94Hz (NTSC)], the length of the video recorded will be approx. 1/10 of the actual recording time. The displayed video recording time will be approx. 10 times longer than the recording time displayed during normal video recording.
When the system frequency is set to [50.00Hz (PAL)] or [24.00Hz (CINEMA)], the length of the video recorded will be approx. 1/8 of the actual recording time. The displayed video recording time will be approx. 8 times longer than the recording time displayed during normal video recording.
- If you end video recording after a short time, the camera may go on recording for a certain period.



❖ Setting the Color to Be Left ([One Point Color])

- 1 Set [Filter Effect] to [One Point Color].
- 2 Press ▲ to display the setting screen.
 - The setting screen can also be displayed by touching [] then [].
- 3 Press ▲▼◀▶ to move the frame and select the color you want to leave.
 - You can also select the color you want to leave by touching the screen.
 - To return the frame back to the center, press [DISP.].





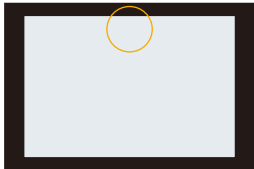

- 4 Press  or  to set.

❖ Setting the Light Source Position and Size ([Sunshine])

- 1 Set [Filter Effect] to [Sunshine].
- 2 Press ▲ to display the setting screen.
 - The setting screen can also be displayed by touching [] then [].
- 3 Press ▲▼◀▶ to move the center position of the light source.
 - The position of the light source can also be moved by touching the screen.



- 4 Rotate  ,  or  to adjust the size of the light source.
 - This can also be enlarged/reduced by pinching out/pinching in the screen.
 - To reset the light source setting to the default, press [DISP.].
- 5 Press  or  to set.

[Simultaneous Record w/o Filter]



You can simultaneously take pictures with no added filter effects.

 → [] → [] → **Select [Simultaneous Record w/o Filter]**

Settings: [ON]/[OFF]

- [Simultaneous Record w/o Filter] is not available when using the following functions:
 - Burst recording
 - [6K/4K PHOTO]/[Post-Focus]
 - [Time Lapse Shot]
 - [Stop Motion Animation]
 - [RAW+FINE]/[RAW+STD.]/[RAW] ([Picture Quality])
 - [Bracketing]

9. Flash

- [Using an External Flash \(Optional\): 304](#)
- [Setting Flash: 308](#)
- [Recording Using a Wireless Flash: 317](#)

Using an External Flash (Optional)

- [Removing the Hot Shoe Cover: 305](#)



If you attach the Flash (DMW-FL580L/DMW-FL360L/DMW-FL200L: optional) to the hot shoe, you can record using the flash.

You can also use a commercially available external flash by connecting a synchro cable to the flash synchro socket.

Furthermore, by attaching an external flash that supports wireless flash recording, you can wirelessly control an external flash that is in a position separate from the camera.

- Remove the lens hood to prevent vignetting.
- Flash recording is not possible when the following functions are being used:
 - [6K/4K PHOTO]/[Post-Focus]
 - [ELEC.]/[Silent Mode]
 - [Filter Settings]

Removing the Hot Shoe Cover

Before attaching the Flash (optional), remove the hot shoe cover.

Refer to the operating instructions for the Flash for details about how to attach it.

- 1 Remove the hot shoe cover by pulling it in the direction indicated by arrow (2) while pressing it in the direction indicated by arrow (1).**

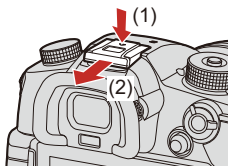

❖ Connecting a Synchro Cable to the Flash Synchro Socket

You can use a commercially available external flash by connecting a synchro cable to the flash synchro socket.

- Use an external flash with a synchronization voltage of 400 V or less.
- Do not use the synchro cables with the length of 3 m (9.8 feet) or more.

- 1 Rotate the flash synchro socket cap in the direction of the arrow to remove.
 - Be careful not to lose the flash synchro socket cap.

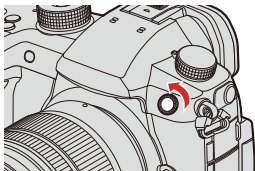

- 2 Connect the synchro cable to the flash synchro socket.
 - The socket has a lock screw to prevent the cable from falling off.
 - For the connection, refer to the operating instructions for the synchro cable.

- The flash synchro socket has no polarity. You can use a synchro cable regardless of its polarity.

❖ Notes on Flash Recording

- Do not bring any object near the flash. Heat or light may cause the object to deform or discolor.
- If you record repeatedly, time may be needed to charge the flash.
While the flash is charging, images will be recorded without the flash firing.
- When an external flash is attached, do not carry the camera by holding only the external flash. It may become detached.
- When using a commercially available external flash, do not use one with reversed polarity or function for communicating with a camera.
It may cause the camera to malfunction, or it may not operate correctly.
- Refer to the operating instructions for the external flash for details.

Setting Flash



- [Flash Mode]: 309
- [Firing Mode]/[Manual Flash Adjust.]: 311
- [Flash Adjust.]: 313
- [Flash Synchro]: 315
- [Auto Exposure Comp.]: 316



You can set the flash function to control flash firing from the camera.

[Flash Mode]

Sets the flash mode.

1  → [] → [] → Select [Flash Mode]



[] (Forced Flash On)/[] (Forced On/Red-Eye)

The flash fires every time regardless of the recording conditions.

This is suitable for recording when there is backlighting or under lighting such as fluorescent lighting.





[] (Slow Sync.)/[] (Slow Sync./Red-Eye)

When recording images against a nightscape, this will slow the shutter speed when the flash fires to make not only the subject but also the nightscape appear brighter.

- Slower shutter speeds may result in blurry images. To avoid this, we recommend using a tripod.

[] (Forced Flash Off)





The flash does not fire.



- The flash fires twice.
The interval between the first and second firings is longer when [] or [] is set. The subject should not move until the second firing has finished.
- [] and [] cannot be used when the following are set:
 - [Firing Mode]: [MANUAL]
 - [Flash Synchro]: [2ND]
 - [Wireless]: [ON]
- Some flash modes may not be available depending on the settings on the external flash.
- The effectiveness of red-eye reduction varies from person to person.
The effect, which is influenced by factors such as distance to the subject and whether the subject is looking at the camera when the preliminary flash is fired, may not be very noticeable in some cases.

❖ Available Flash Settings by Recording Mode

The available flash settings depend on the recording mode.

(✓: Available, —: Not available)

Recording mode	[]	[]	[]	[]	[]
[P]/[A]	✓	✓	✓	✓	✓
[S]/[M]	✓	✓	—	—	✓

- [] and [] can be set in [iA] mode. In [], the flash mode switches to one suited to the recording situation.

❖ Shutter Speeds for Flash Modes

[]/[]: 1/60 of a second*1 to 1/250 of a second

[]/[]: 1 second to 1/250 of a second

*1 In [S] mode, this will be 60 seconds and in [M] mode it will be [B] (Bulb).

[Firing Mode]/[Manual Flash Adjust.]

You can select whether to set the flash output automatically or manually.

- The settings made here are enabled when some flashes from other manufacturers are attached.
Set on the flash when a Flash (DMW-FL580L/DMW-FL360L/DMW-FL200L: optional) is attached.

1 Set the [Firing Mode].

- → [] → [] → [Firing Mode]



[TTL]

Sets flash output to be set automatically by the camera.

[MANUAL]

Sets the flash output manually.

- With [TTL], you can record the images you want even when recording dark scenes where the flash output tends to become greater.
- The flash output ([1/1], etc.) is displayed on the flash icon of the recording screen.

2 (When set to [MANUAL]) Select [Manual Flash Adjust.] and then press or .



3 Press to set the flash output and then press or .

- It can be set within the range of [1/1] (full flash output) to [1/128] in 1/3 steps.

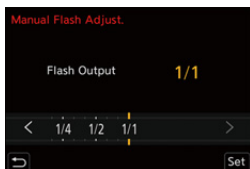

[Flash Adjust.]

You can adjust the flash output when taking pictures with the flash in TTL output mode.

1 Select [Flash Adjust.].

-  → [] → [] → [Flash Adjust.]



2 Press to adjust the flash output and then press or .

- It can be adjusted within the range of [-3 EV] to [+3 EV] in 1/3 EV steps.



- [🔦] is displayed on the recording screen.
- For information about adjusting the flash output when recording using a wireless flash (→ [\[Flash Adjust.\]: 321](#))
- [Flash Adjust.] cannot be used when the following are set:
 - [Firing Mode]: [MANUAL]
 - [Wireless]: [ON]

[Flash Synchro]

When a moving subject is recorded at night using a slow shutter and flash, a trail of light may appear in front of the subject.

If you set [Flash Synchro] to [2ND], you can take a dynamic picture with a trail of light appearing behind the subject by firing the flash immediately before the shutter closes.

1 → → → Select [Flash Synchro]



[1ST]

This is the normal method for recording with the Flash.



[2ND]

The light source appears behind the subject and the picture becomes dynamic.



- When [2ND] is set, [2nd] is displayed on the flash icon of the recording screen.
- When [Wireless] is set to [ON], this is fixed to [1ST].
- The effect may not be adequately achieved at faster shutter speeds.

[Auto Exposure Comp.]

Automatically adjust the flash output in conjunction with the exposure compensation value. (→ [Exposure Compensation: 269](#))

- 1  →  →  → **Select [Auto Exposure Comp.]**
Settings: [ON]/[OFF]

Recording Using a Wireless Flash



You can use a Flash (DMW-FL580L/DMW-FL360L/DMW-FL200L: optional) to record using a wireless flash.

You can separately control the firing of three flash groups and the flash attached to the hot shoe of the camera.

❖ Placing a Wireless Flash

Place the wireless flash with its wireless sensor facing the camera.

Placement example

When (C) is placed to erase the shadow in the background of the subject that the flash groups (A) and (B) will create

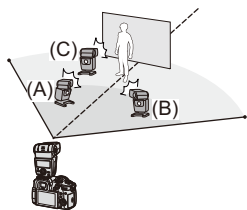

Placement range

When DMW-FL360L is attached

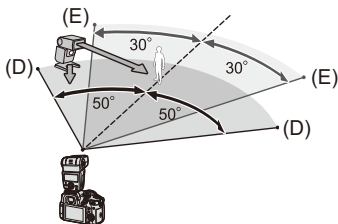

(D) 5.0 m (16 feet)

(E) 7.0 m (23 feet)

- The placement range serves as a guide for when recording with the camera held horizontally. The range differs depending on the surrounding environment.
- We recommend using a maximum of three wireless flashes in each group.
- If the subject is too close, communication light may affect the exposure. You can reduce the effect by setting [Communication Light] to [LOW] or lowering the output with a diffuser or similar device. (→[Communication Light]: 323)

1 Attach an external flash to the camera. (→[Removing the Hot Shoe Cover: 305](#))

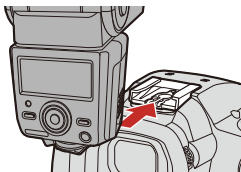

2 Set the wireless flashes to [RC] mode and then place them.

- Set the channel and group for the wireless flashes.

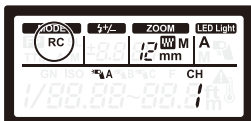

3 Enable the wireless flash function of the camera.

- **MENU/SET** → [📷] → [⚡] → [Wireless] → [ON]



4 Set [Wireless Channel].

- Select the same channel as on the wireless flash side.



5 Set [Wireless Setup].

- Set the firing mode and flash output.



❖ Setting Items ([Wireless Setup])

- To fire a test flash, press [DISP.].

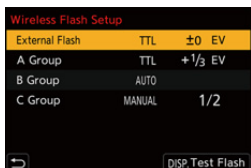

[External Flash]¹	[Firing Mode]	<p>[TTL]: The camera automatically sets the flash output.</p> <p>[AUTO]²: Sets the flash output on the external flash side.</p> <p>[MANUAL]: Sets the flash output of the external flash manually.</p> <p>[OFF]: The external flash outputs only communication light.</p>
	[Flash Adjust.]	Adjusts the flash output of the external flash manually when [Firing Mode] is set to [TTL].
	[Manual Flash Adjust.]	<p>Sets the flash output of the external flash when [Firing Mode] is set to [MANUAL].</p> <ul style="list-style-type: none"> It can be set within the range of [1/1] (full flash output) to [1/128] in 1/3 steps.

[A Group]/ [B Group]/ [C Group]	[Firing Mode]	<p>[TTL]: The camera automatically sets the flash output.</p> <p>[AUTO]*1: Sets the flash output on the wireless flash side.</p> <p>[MANUAL]: Sets the flash output of the wireless flash manually.</p> <p>[OFF]: The wireless flashes of the specified group will not fire.</p>
	[Flash Adjust.]	Adjusts the flash output of the wireless flash manually when [Firing Mode] is set to [TTL].
	[Manual Flash Adjust.]	<p>Sets the flash output of the wireless flash when [Firing Mode] is set to [MANUAL].</p> <ul style="list-style-type: none"> • It can be set within the range of [1/1] (full flash output) to [1/128] in 1/3 steps.

*1 This cannot be selected when [Wireless FP] is set.

*2 This cannot be set when using the Flash (DMW-FL200L: optional).

❖ [Wireless FP]

The external flash performs FP firing (repeated high-speed firing of the flash) during wireless recording, enabling recording using the Flash even at fast shutter speeds.

 ⇒ [] ⇒ [] ⇒ Select [Wireless FP]

Settings: [ON]/[OFF]

❖ [Communication Light]

Set the strength of communication light.

 ⇒ [] ⇒ [] ⇒ Select [Communication Light]

Settings: [HIGH]/[STANDARD]/[LOW]

10. Recording Videos

- Recording Videos: 325
- Creative Video Mode: 330
- Video Recording Settings: 335
- Time Code: 350
- Using AF (Video): 353
- Video Brightness and Coloring: 356
- Audio Settings: 364
- Main Assist Functions: 369
- [Variable Frame Rate]: 382
- [Focus Transition]: 386
- [Live Cropping]: 390
- Log Recording: 396
- HLG Videos: 400
- Anamorphic Recording: 405
- [Synchro Scan]: 410
- [Loop Recording (video)]: 412
- [Segmented File Recording]: 414
- List of Recording Qualities That Enable Special Videos to be Recorded:
416

Recording Videos

- [Recording Videos: 325](#)



It is possible to record video with a maximum resolution of 6K-A (4992×3744) on this camera.

It also supports switching of the system frequency and 2 types of recording file format; MP4, and MOV.

In the [M] mode (Creative Video mode), which is specifically for video recording, you can use all of the video functions.

Recording Videos

1 Start recording.

- Press the video rec. button.
- Release the video rec. button right after you press it.

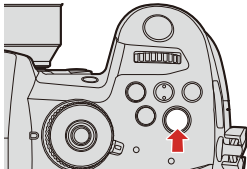

2 Stop recording.

- Press the video rec. button again.

❖ Screen Displays While Video Recording

The live view angle of view changes to the angle of view for video recording, and video recording time (A) and elapsed recording time (B) are displayed.

- “h” is an abbreviation for hour, “m” for minute and “s” for second.
- The recording state indication (C) and card access indication (D) turn red while videos are being recorded.

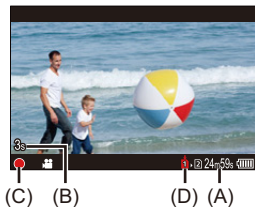

- If maintaining focus on the subject is difficult during video recording with AF, press the shutter button halfway to re-adjust the focus.







❖ Exposure Control While Video Recording

Videos will be recorded using the aperture, shutter speed, and ISO sensitivity settings below.

Recording mode	Aperture value/shutter speed/ISO sensitivity
[iA]	The camera automatically makes the settings to suit the scene. (→ Types of Automatic Scene Detection: 103)
[P]/[A]/[S]/[M]	The settings vary depending on the [Auto Exposure in P/A/S/M] in the [Custom] ([Image Quality]) menu. The default setting is [ON]. (→ Auto Exposure in P/A/S/M: 551) [ON] : Records with values set automatically by the camera. [OFF] : Records with manually set values.
[M]	Records with manually set values.

❖ Size Interval for Dividing Files

[Rec. File Format]	[Rec Quality]	Size interval for dividing files
[MP4]	[FHD]	A new file will be created to continue recording if the continuous recording time exceeds 30 minutes or the file size exceeds 4 GB.
	[4K]	When using an SDHC memory card: A new file will be created to continue recording if the continuous recording time exceeds 30 minutes or the file size exceeds 4 GB.
[MOV]	All	When using an SDXC memory card: A new file will be created to continue recording if the continuous recording time exceeds 3 hours and 4 minutes or the file size exceeds 96 GB.

- If an operation such as a zoom or button operation is performed during video recording, that operation sound may be recorded.
- The lens operation sound (AF and image stabilizer) may be recorded to video.
- If the operation sound of pressing the video rec. button or sub video rec. button to end recording bothers you, try the following:
 - Record the video about 3 seconds longer, and then divide the last part of the video using [Video Divide] in the [Playback] ([Edit Image]) menu.
 - Use the Shutter Remote Control (DMW-RS2: optional) for recording.
- Depending on the type of card, the card access indication may appear for a while after video recording. This is not a malfunction.
- Even when playback is performed on a supported device, situations may occur where image or sound quality is poor, recording information is not displayed correctly, or playback is not possible, for example.
If you experience any of these, play them back on the camera.
- If the camera temperature rises, [] may be displayed and recording may stop. Wait until the camera cools down.
- Video recording is not possible while you are using the following functions:
 - [Time Lapse Shot]
 - [Stop Motion Animation]
 - [Rough Monochrome]/[Silky Monochrome]/[Soft Focus]/[Star Filter]/[Sunshine] ([Filter Settings])
 - [Post-Focus]
- You can switch the recording screen display to suit video recording just as with the [] mode:
 - [] ⇒ [] ⇒ [Video-Priority Display] (⇒ [\[Video-Priority Display\]: 577](#))
- You can display a red frame on the recording screen that indicates that video is being recorded:
 - [] ⇒ [] ⇒ [Red REC Frame Indicator] (⇒ [\[Red REC Frame Indicator\]: 578](#))

Creative Video Mode

- [Setting the Exposure for Recording Videos: 331](#)
- [Separating Settings for Recording Video and Pictures: 334](#)



The [M] mode (Creative Video mode) is a recording mode specifically for video recording in which you can use all video functions.

In the recording modes specifically for video, you can start and stop video recording with the shutter button.

Change the exposure and audio settings with touch operation to prevent operation sounds from being recorded.

Settings such as exposure and white balance can be changed independent of picture taking settings.

Setting the Exposure for Recording Videos

1 Set the mode dial to [M].

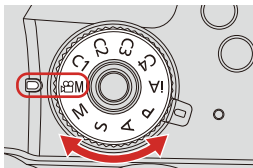

2 Set the exposure mode.

- **MENU/SET** → [**Video Mode**] → [**Exposure Mode**] → [P]/[A]/[S]/[M]
- You can perform the same exposure operations as the [P]/[A]/[S]/[M] modes.

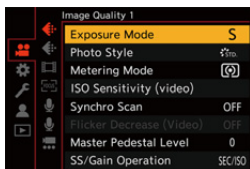

3 Close the menu.

- Press the shutter button halfway.

4 Start recording.

- Press the shutter button (A) or video rec. button (B).

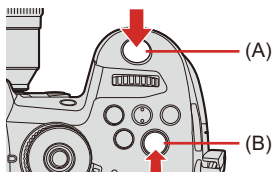

5 Stop recording.

- Press the shutter button or video rec. button again.

❖ Operations During Video Recording

Change the exposure and audio settings with touch operation to prevent operation sounds from being recorded.

- With the default settings, the Touch Tab is not displayed.
Set [Touch Tab] to [ON] in [Touch Settings] in the [Custom] ([Operation]) menu.
(→[Touch Settings]: 559)

1 Touch .

2 Touch an icon.

 : Zoom (When using an interchangeable lens supporting power zoom)

 : Aperture value



 : Shutter speed



 : Exposure compensation

 : ISO sensitivity/Gain (dB)

 : Sound recording level adjustment

3 Drag the slide bar to set the item.

[]/[]: Changes the setting slowly.

[]/[]: Changes the setting quickly.

- If you touch icon (C), the screen of Step 2 is redisplayed.



Separating Settings for Recording Video and Pictures



In default settings, settings such as exposure and white balance changed in [CAM] mode are also reflected in picture recording in [P]/[A]/[S]/[M] modes.

From the [CreativeVideo Combined Set.] menu, you can separate settings for video recording and for picture recording.

→ [⚙️] → [📷] → **Select [CreativeVideo Combined Set.]**

[F/SS/ISO/Exposure Comp.]	[📷]: The recording settings are linked across recording modes.
[White Balance]	
[Photo Style]	[🎥]: Recording settings can be separated by the [CAM] mode and the [P]/[A]/[S]/[M] mode.
[Metering Mode]	
[AF Mode]	

- The [iA] mode uses the optimum recording settings for the camera automatically, so the recording settings will be independent, irrespective of the settings made with this function.

Video Recording Settings

- [\[System Frequency\]: 336](#)
- [\[Rec. File Format\]: 337](#)
- [\[Rec Quality\]: 338](#)
- [\[Image Area of Video\]: 348](#)

This section describes the settings used when video recording.

- In "[4. Image Recording](#)", the functions described work with both pictures and video.

Please also refer to that section.

- [\[Double Card Slot Function\]: 118](#)
- [\[Folder / File Settings\]: 120](#)
- [\[File Number Reset\]: 123](#)

[System Frequency]



This changes the system frequency of videos that are recorded and played back with the camera.

The default setting is for the system frequency to be set to the TV broadcast system for the region where the camera was bought.

→ [] → [] → **Select [System Frequency]**

[59.94Hz (NTSC)]	System frequency for regions using the NTSC broadcasting system
[50.00Hz (PAL)]	System frequency for regions using the PAL broadcasting system
[24.00Hz (CINEMA)]	System frequency for producing cinema film

- After changing the setting, turn the camera off and on.
- If you record using a system frequency that differs from the broadcasting system of your region, it may not be possible for you to properly play back videos on your TV.

We recommend using the setting as it was at the time of purchase if you are unsure about broadcasting systems or if you will not be involved in producing cinema film.

- A video recorded with a system frequency different from the setting of [System Frequency] cannot be played back in the camera.

[Rec. File Format]



Sets the recording file format of videos to be recorded.

→ → → **Select [Rec. File Format]**

[MP4]	This file format is suitable for playback on PCs.
[MOV]	This file format is suitable for image editing.

- When [System Frequency] is set to [24.00Hz (CINEMA)], it is fixed to [MOV].

[Rec Quality]



Sets the image quality of videos to be recorded.

The image qualities you can select depend on the [System Frequency] and [Rec. File Format] settings.

[Rec Quality] settings can also be made using [Filtering] (→ [\[Filtering\]: 345](#)) to display only items that meet your conditions and [add to list] (→ [\[add to list\]: 346](#)) to register recording qualities you use often.

 →  →  → **Select [Rec Quality]**

- To record video with a bit rate of 72 Mbps or more, it requires a card with the corresponding Speed Class. (→ [Memory Cards That Can Be Used: 25](#))

❖ [Rec. File Format]: [MP4]

- Image compression: Long GOP
- Audio format: AAC (2ch)

(A) Recording frame rate

(B) Bit rate (Mbps)

(C) YUV/bit

(D) Video compression format (HEVC: H.265/HEVC, AVC: H.264/MPEG-4 AVC)

[System Frequency]: [59.94Hz (NTSC)]

[Rec Quality]	Resolution (Aspect ratio)	(A)	(B)	(C)	(D)
[4K/10bit/100M/60p]	3840×2160 (16:9)	59.94p	100	4:2:0/10 bit	HEVC
[4K/8bit/100M/30p]		29.97p	100	4:2:0/8 bit	AVC
[4K/10bit/72M/30p]		29.97p	72	4:2:0/10 bit	HEVC
[4K/8bit/100M/24p]		23.98p	100	4:2:0/8 bit	AVC
[4K/10bit/72M/24p]		23.98p	72	4:2:0/10 bit	HEVC
[FHD/8bit/28M/60p]	1920×1080 (16:9)	59.94p	28	4:2:0/8 bit	AVC
[FHD/8bit/24M/24p]		23.98p	24	4:2:0/8 bit	AVC
[FHD/8bit/20M/30p]		29.97p	20	4:2:0/8 bit	AVC

[System Frequency]: [50.00Hz (PAL)]

[Rec Quality]	Resolution (Aspect ratio)	(A)	(B)	(C)	(D)
[4K/10bit/100M/50p]	3840×2160 (16:9)	50.00p	100	4:2:0/10 bit	HEVC
[4K/8bit/100M/25p]		25.00p	100	4:2:0/8 bit	AVC
[4K/10bit/72M/25p]		25.00p	72	4:2:0/10 bit	HEVC
[FHD/8bit/28M/50p]	1920×1080 (16:9)	50.00p	28	4:2:0/8 bit	AVC
[FHD/8bit/20M/25p]		25.00p	20	4:2:0/8 bit	AVC

❖ **[Rec. File Format]: [MOV]**

- Audio format: LPCM (2ch)

[System Frequency]: [59.94Hz (NTSC)]

(A) Recording frame rate

(B) Bit rate (Mbps)

(C) YUV/bit

(D) Video compression format (HEVC: H.265/HEVC, AVC: H.264/MPEG-4 AVC)

(E) Image compression

[Rec Quality]	Resolution (Aspect ratio)	(A)	(B)	(C)	(D)	(E)
[6K-A/30p/420/10-L]	4992×3744 (4:3)	29.97p	200	4:2:0/10 bit	HEVC	Long GOP
[6K-A/24p/420/10-L]		23.98p	200	4:2:0/10 bit	HEVC	Long GOP
[4K-A/60p/420/8-L]	3328×2496 (4:3)	59.94p	150	4:2:0/8 bit	AVC	Long GOP
[4K-A/30p/422/10-I]		29.97p	400	4:2:2/10 bit	AVC	ALL-Intra
[4K-A/30p/422/10-L]		29.97p	150	4:2:2/10 bit	AVC	Long GOP
[4K-A/30p/420/8-L]		29.97p	100	4:2:0/8 bit	AVC	Long GOP
[4K-A/24p/422/10-I]		23.98p	400	4:2:2/10 bit	AVC	ALL-Intra
[4K-A/24p/422/10-L]		23.98p	150	4:2:2/10 bit	AVC	Long GOP
[4K-A/24p/420/8-L]		23.98p	100	4:2:0/8 bit	AVC	Long GOP
[C4K/60p/420/10-L]		4096×2160 (17:9)	59.94p	200	4:2:0/10 bit	HEVC
[C4K/60p/420/8-L]	59.94p		150	4:2:0/8 bit	AVC	Long GOP
[C4K/30p/422/10-I]	29.97p		400	4:2:2/10 bit	AVC	ALL-Intra
[C4K/30p/422/10-L]	29.97p		150	4:2:2/10 bit	AVC	Long GOP
[C4K/30p/420/8-L]	29.97p		100	4:2:0/8 bit	AVC	Long GOP
[C4K/24p/422/10-I]	23.98p		400	4:2:2/10 bit	AVC	ALL-Intra
[C4K/24p/422/10-L]	23.98p		150	4:2:2/10 bit	AVC	Long GOP
[C4K/24p/420/8-L]	23.98p		100	4:2:0/8 bit	AVC	Long GOP

[4K/60p/420/10-L]	3840×2160 (16:9)	59.94p	200	4:2:0/10 bit	HEVC	Long GOP
[4K/60p/420/8-L]		59.94p	150	4:2:0/8 bit	AVC	Long GOP
[4K/30p/422/10-I]		29.97p	400	4:2:2/10 bit	AVC	ALL-Intra
[4K/30p/422/10-L]		29.97p	150	4:2:2/10 bit	AVC	Long GOP
[4K/30p/420/8-L]		29.97p	100	4:2:0/8 bit	AVC	Long GOP
[4K/24p/422/10-I]		23.98p	400	4:2:2/10 bit	AVC	ALL-Intra
[4K/24p/422/10-L]		23.98p	150	4:2:2/10 bit	AVC	Long GOP
[4K/24p/420/8-L]		23.98p	100	4:2:0/8 bit	AVC	Long GOP
[FHD/60p/422/10-I]		1920×1080 (16:9)	59.94p	200	4:2:2/10 bit	AVC
[FHD/60p/422/10-L]	59.94p		100	4:2:2/10 bit	AVC	Long GOP
[FHD/60p/420/8-L]	59.94p		100	4:2:0/8 bit	AVC	Long GOP
[FHD/30p/422/10-I]	29.97p		200	4:2:2/10 bit	AVC	ALL-Intra
[FHD/30p/422/10-L]	29.97p		100	4:2:2/10 bit	AVC	Long GOP
[FHD/30p/420/8-L]	29.97p		100	4:2:0/8 bit	AVC	Long GOP
[FHD/24p/422/10-I]	23.98p		200	4:2:2/10 bit	AVC	ALL-Intra
[FHD/24p/422/10-L]	23.98p		100	4:2:2/10 bit	AVC	Long GOP
[FHD/24p/420/8-L]	23.98p		100	4:2:0/8 bit	AVC	Long GOP

[System Frequency]: [50.00Hz (PAL)]

(A) Recording frame rate

(B) Bit rate (Mbps)

(C) YUV/bit

(D) Video compression format (HEVC: H.265/HEVC, AVC: H.264/MPEG-4 AVC)

(E) Image compression

[Rec Quality]	Resolution (Aspect ratio)	(A)	(B)	(C)	(D)	(E)
[6K-A/25p/420/10-L]	4992×3744 (4:3)	25.00p	200	4:2:0/10 bit	HEVC	Long GOP
[4K-A/50p/420/10-L]	3328×2496 (4:3)	50.00p	200	4:2:0/10 bit	HEVC	Long GOP
[4K-A/50p/420/8-L]		50.00p	150	4:2:0/8 bit	AVC	Long GOP
[4K-A/25p/422/10-I]		25.00p	400	4:2:2/10 bit	AVC	ALL-Intra
[4K-A/25p/422/10-L]		25.00p	150	4:2:2/10 bit	AVC	Long GOP
[4K-A/25p/420/8-L]		25.00p	100	4:2:0/8 bit	AVC	Long GOP
[C4K/50p/420/10-L]	4096×2160 (17:9)	50.00p	200	4:2:0/10 bit	HEVC	Long GOP
[C4K/50p/420/8-L]		50.00p	150	4:2:0/8 bit	AVC	Long GOP
[C4K/25p/422/10-I]		25.00p	400	4:2:2/10 bit	AVC	ALL-Intra
[C4K/25p/422/10-L]		25.00p	150	4:2:2/10 bit	AVC	Long GOP
[C4K/25p/420/8-L]		25.00p	100	4:2:0/8 bit	AVC	Long GOP
[4K/50p/420/10-L]	3840×2160 (16:9)	50.00p	200	4:2:0/10 bit	HEVC	Long GOP
[4K/50p/420/8-L]		50.00p	150	4:2:0/8 bit	AVC	Long GOP
[4K/25p/422/10-I]		25.00p	400	4:2:2/10 bit	AVC	ALL-Intra
[4K/25p/422/10-L]		25.00p	150	4:2:2/10 bit	AVC	Long GOP
[4K/25p/420/8-L]		25.00p	100	4:2:0/8 bit	AVC	Long GOP

[FHD/50p/422/10-I]	1920×1080 (16:9)	50.00p	200	4:2:2/10 bit	AVC	ALL-Intra
[FHD/50p/422/10-L]		50.00p	100	4:2:2/10 bit	AVC	Long GOP
[FHD/50p/420/8-L]		50.00p	100	4:2:0/8 bit	AVC	Long GOP
[FHD/25p/422/10-I]		25.00p	200	4:2:2/10 bit	AVC	ALL-Intra
[FHD/25p/422/10-L]		25.00p	100	4:2:2/10 bit	AVC	Long GOP
[FHD/25p/420/8-L]		25.00p	100	4:2:0/8 bit	AVC	Long GOP

[System Frequency]: [24.00Hz (CINEMA)]

(A) Recording frame rate

(B) Bit rate (Mbps)

(C) YUV/bit

(D) Video compression format (HEVC: H.265/HEVC, AVC: H.264/MPEG-4 AVC)

(E) Image compression

[Rec Quality]	Resolution (Aspect ratio)	(A)	(B)	(C)	(D)	(E)
[6K-A/24p/420/10-L]	4992×3744 (4:3)	24.00p	200	4:2:0/10 bit	HEVC	Long GOP
[4K-A/24p/422/10-I]	3328×2496 (4:3)	24.00p	400	4:2:2/10 bit	AVC	ALL-Intra
[4K-A/24p/422/10-L]		24.00p	150	4:2:2/10 bit	AVC	Long GOP
[4K-A/24p/420/8-L]		24.00p	100	4:2:0/8 bit	AVC	Long GOP
[C4K/24p/422/10-I]	4096×2160 (17:9)	24.00p	400	4:2:2/10 bit	AVC	ALL-Intra
[C4K/24p/422/10-L]		24.00p	150	4:2:2/10 bit	AVC	Long GOP
[C4K/24p/420/8-L]		24.00p	100	4:2:0/8 bit	AVC	Long GOP
[4K/24p/422/10-I]	3840×2160 (16:9)	24.00p	400	4:2:2/10 bit	AVC	ALL-Intra
[4K/24p/422/10-L]		24.00p	150	4:2:2/10 bit	AVC	Long GOP
[4K/24p/420/8-L]		24.00p	100	4:2:0/8 bit	AVC	Long GOP
[FHD/24p/422/10-I]	1920×1080 (16:9)	24.00p	200	4:2:2/10 bit	AVC	ALL-Intra
[FHD/24p/422/10-L]		24.00p	100	4:2:2/10 bit	AVC	Long GOP
[FHD/24p/420/8-L]		24.00p	100	4:2:0/8 bit	AVC	Long GOP

- In this document, videos are indicated as follows according to their resolution:
 - 6K-A (4992×3744) video, 4K-A (3328×2496) video: **6K/4K Anamorphic (4:3) video**
 - C4K (4096×2160) video: **C4K video**
 - 4K (3840×2160) video: **4K video**
 - Full High Definition (1920×1080) video: **FHD video**

- Since the camera employs the VBR recording format, the bit rate is changed automatically depending on the subject to record. As a result, video recording time is shortened when a fast-moving subject is recorded.
- Videos in ALL-Intra and 4:2:2 10-bit formats are intended for editing on a PC used for video production.
- When the following functions are being used, [Image Area of Video] is fixed to [FULL].
 - 6K Anamorphic (4:3) video
- When using the following function, you can only select 8-bit FHD video:
 - [Miniature Effect] ([Filter Settings])
- You can register a combination of [System Frequency], [Rec. File Format], [Image Area of Video], and [Rec Quality] to My List. (→ [add to list](#): 346)

❖ [Filtering]

When the [Rec. File Format] is set to [MOV], you can specify items such as frame rate, resolution, and codec (YUV, Bit value, Image compression), and just display recording quality that meets those conditions.

- 1 In the [Rec Quality] setting screen, press [DISP.].



- 2 Press ▲▼ to select a setting item and then press or .
 - Settings: [Frame Rate]/[Resolution]/[Codec]/[Variable Frame Rate]/[Hybrid Log Gamma]
- 3 Press ▲▼ to select the filtering conditions and then press or .
- 4 Press [DISP.] to confirm the setting.
 - You are returned to the [Rec Quality] setting screen.

Clearing the filtering conditions

Select [ANY] in Step 3.

- The filtering conditions are also cleared when you do the following:
 - Change the [System Frequency]
 - Select a recording quality from [Rec Quality (My List)]





- When you change recording quality using a filter, the current filtering conditions are stored.

❖ [add to list]

Select a recording quality and register it in My List. The recording quality you register can be set in [Rec Quality (My List)].

- 1 In the [Rec Quality] setting screen, press [Q].
 - The following settings are also registered at the same time:
 - [System Frequency]
 - [Rec. File Format]
 - [Image Area of Video]

Setting or deleting in My List

- 1 Select [Rec Quality (My List)].
 -  ⇒ [] ⇒ [] ⇒ [Rec Quality (My List)]
- 2 Press ▲▼ to select a setting item and then press  or  .
 - You cannot select setting items that have different system frequencies.
 - To delete from My List, select the item and press [Q].

Display [Rec Quality (My List)] on the Control Panel

You can display the My List of recording quality from the control panel in [CAM] mode or when it is set to [Video-Priority Display].

1 Display the setting screen.

- Touch the recording quality item.
- When already registered in My List, the [Rec Quality (My List)] setting screen is displayed.

When not yet registered, the [Rec Quality] setting screen is displayed.

- [Rec Quality (My List)] and [Rec Quality] switch each time you press the [DISP.] button.
 - The next time the setting screen is displayed, the screen last used is displayed.

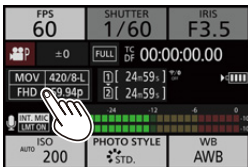

- Up to 12 types of recording quality can be registered.

[Image Area of Video]



Set the image area during video recording. The angle of view differs depending on the image area.

Narrowing the image area allows you to achieve a telescopic effect without image deterioration.

→ → → **Select [Image Area of Video]**

Item	Settings details
[FULL]	<p>Records according to the range that corresponds to the image circle of the lens that is for Micro four thirds.</p> <p>Angle of view: Wide</p> <p>Telescopic effect: Not possible</p>
[PIXEL/PIXEL]	<p>Records with one pixel on the sensor, which is equal to one pixel of the video.</p> <p>Records a range corresponding to the resolution range in [Rec Quality]. (→[Rec Quality]: 338)</p> <p>Angle of view: Narrow</p> <p>Telescopic effect: Possible</p>

Image area (Ex.: FHD video)

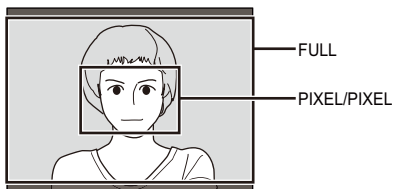

- When the following functions are being used, [Image Area of Video] is fixed to [FULL].
 - [Live Cropping]
 - 6K Anamorphic (4:3) video

Time Code

- [Setting the Time Code: 350](#)



When video is recorded in the MOV format, the hour, minute, seconds, and number of frames information (time code) is recorded automatically.

The time code is used to synchronize multiple image and audio sources.

- The time code is not recorded with video in the MP4 format.

Setting the Time Code

Sets the recording, display, and output of the time code.

1 Set [Rec. File Format] to [MOV].

- → → → [Rec. File Format] → [MOV]

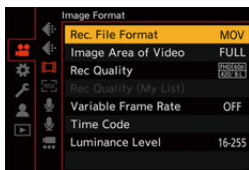

2 Select [Time Code].

-  →  →  → [Time Code]

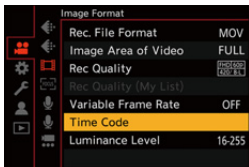

[Time Code Display]

Displays the time code on the recording screen/playback screen.

[Count Up]

[REC RUN]: Counts the time code only when recording videos.

[FREE RUN]: Counts the time code also when video recording is stopped and when the camera is turned off.

- When the following function is being used, [Count Up] is fixed to [REC RUN]:
– [Variable Frame Rate]

[Time Code Value]

[Reset]: Sets to 00:00:00:00 (hour: minute: second: frame)

[Manual Input]: Manually input hour, minute, second and frame.

[Current Time]: Sets hour, minute and second to current time and sets frame to 00.

[Time Code Mode]

[DF]: Drop Frame. The camera modifies the difference between recorded time and time code.

- Seconds and frames are separated by “.”. (Example: 00:00:00.00)

[NDF]: Non-Drop Frame. Records the time code without drop frame.

- Seconds and frames are separated by “:”. (Example: 00:00:00:00)
 - When the following functions are being used, [Time Code Mode] is fixed to [NDF]:
 - [50.00Hz (PAL)]/[24.00Hz (CINEMA)] ([System Frequency])
 - 23.98p [Rec Quality]
-

[HDMI Time Code Output]

Time code information is added to images output via HDMI when recording with the [Ⓜ] mode.

- The time code can also be output via HDMI by setting the mode dial to [Ⓜ] during playback.

In the [Setup] ([IN/OUT]) menu, set [Output Resolution(Playback)] in [HDMI Connection] to [AUTO]. (→[HDMI Connection]: 590)

- The device screen may go dark depending on the connected device.
-

Using AF (Video)

- [\[Continuous AF\]: 354](#)
- [\[AF Custom Setting\(Video\)\]: 355](#)

This section describes the use of AF when video recording.

- In “5. Focus/Zoom”, the functions described work with both pictures and video.
 - [Selecting the Focus Mode: 125](#)
 - [Selecting the AF Mode: 135](#)
 - [AF Area Movement Operation: 158](#)
 - [Record Using MF: 167](#)
 - [Recording with Zoom: 174](#)

[Continuous AF]



You can select how to set the focus in AF when recording videos.

MENU SET → **[AF]** → **[FOCUS]** → **Select [Continuous AF]**

[MODE1]	The camera continues to automatically focus only during recording.
[MODE2]	When recording with [pM] mode, the camera automatically keeps focusing on subjects during recording standby and during recording.
[OFF]	The camera maintains the focus point at the start of recording.

- In the [iA] mode, the camera automatically keeps focusing during recording standby, irrespective of the [Continuous AF] setting.
- Depending on the recording conditions or lens used, the AF operation sound may be recorded during video recording.
If the operation sound bothers you, we recommend recording with [Continuous AF] set to [OFF].
- If the zoom is operated while recording videos, the subject may take a while to come into focus.
- When the following function is being used, [MODE1] switches to [MODE2]:
 - HDMI output ([pM] mode)
- [MODE2] does not work during recording standby in the following cases:
 - In low light situations

[AF Custom Setting(Video)]



You can fine-adjust the focusing method for video recording using [Continuous AF].

→ → → **Select [AF Custom Setting(Video)]**

[ON]	Enables the following settings.
[OFF]	Disables the following settings.
[SET]	[AF Speed] [+] side: Focus moves at a faster speed. [-] side: Focus moves at a slower speed.
	[AF Sensitivity] [+] side: When the distance to the subject changes significantly, the camera immediately readjusts the focus. [-] side: When the distance to the subject changes significantly, the camera waits for a little before readjusting the focus.

Video Brightness and Coloring

- [Luminance Level]: 357
- [Master Pedestal Level]: 358
- Recording While Controlling Overexposure (Knee): 360
- [ISO Sensitivity (video)]: 362

This section describes the brightness and coloring settings used during video recording.

- In “7. Metering/Exposure/ISO Sensitivity” and “8. White Balance/Image Quality”, the functions described work with both pictures and video.

Please also refer to those sections.

- [Metering Mode]: 252
- Exposure Compensation: 269
- Locking Focus and Exposure (AF/AE Lock): 271
- ISO Sensitivity: 273
- White Balance (WB): 278
- [Photo Style]: 285
- [Filter Settings]: 293

[Luminance Level]



You can set the luminance range to suit the purpose of video recording. You can set to [16-235] or [16-255], the standard for video, or to [0-255], which covers the entire range of luminance, the same as pictures.

 →  →  → **Select [Luminance Level]**

Settings: [0-255]/[16-235]/[16-255]

- When set to a 10-bit [Rec Quality], the setting items change to [0-1023], [64-940], and [64-1023].
- When [Photo Style] is set to [V-Log L], this is fixed to [0-255] ([0-1023]).
- When [Photo Style] is set to [Hybrid Log Gamma], this is fixed to [64-940].

[Master Pedestal Level]



You can adjust the black level, which serves as the reference for images.

1 Set the mode dial to [M].

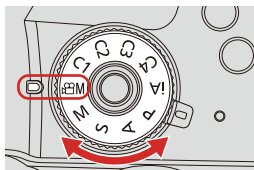

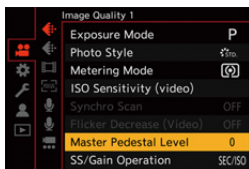

2 Select [Master Pedestal Level].

- [MENU/SET] → [Video Icon] → [Grid Icon] → [Master Pedestal Level]



3 Adjust master pedestal.

- Rotate ,  or .
- Set in the range between -15 and $+15$.

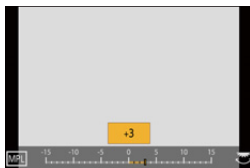

- [Master Pedestal Level] is not available when using the following function:
 - [V-Log L] ([Photo Style])

Recording While Controlling Overexposure (Knee)



When [Photo Style] is set to [Like709], you can adjust the knee so that recording can be performed with minimal overexposure.

1 Set [Photo Style] to [Like709].

-  →  →  → [Photo Style] → [Like709]

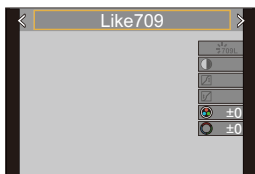

2 Press [Q].

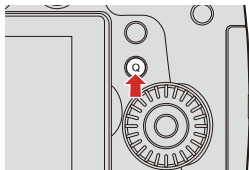

3 Select a knee setting.

- Press ◀▶ to select a setting item.

[AUTO]

Adjusts the compression levels of high-luminance areas automatically.



[MANUAL]

You can set the luminance where compression starts (knee master point) and the intensity of compression (knee master slope).

Press ▲▼ to select an item and then press ◀▶ to adjust.

[POINT]: Master knee point

[SLOPE]: Master knee slope

- Rotate  to adjust the knee master point, and  to adjust the knee master slope.
- Values within the following ranges can be set:
 - Master knee point: 80.0 to 107.0
 - Master knee slope: 0 to 99

[Off]

4 Confirm your selection.

- Press  or .

[ISO Sensitivity (video)]



Sets the lower and upper limits for ISO sensitivity when ISO sensitivity is set to [AUTO].

1 Set the mode dial to [M].

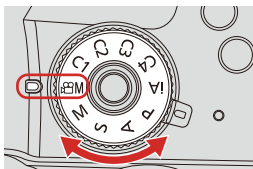

2 Set [ISO Sensitivity (video)].

- [MENU/SET] → [Video Icon] → [Grid Icon] → [ISO Sensitivity (video)]

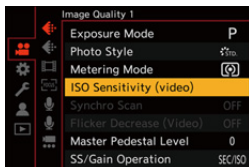

❖ Setting Items ([ISO Sensitivity (video)])

[ISO Auto Lower Limit Setting]	Sets the lower limit for ISO sensitivity when ISO sensitivity is [AUTO]. <ul style="list-style-type: none">• Set in the range between [200] and [6400].
[ISO Auto Upper Limit Setting]	Sets the upper limit for ISO sensitivity when ISO sensitivity is [AUTO]. <ul style="list-style-type: none">• Set to [AUTO] or in the range between [400] and [12800].

- When [Filter Settings] is set to [High Dynamic], [ISO Sensitivity (video)] cannot be used.

Audio Settings

- [Sound Rec Level Disp.]: 364
- [Mute Sound Input]: 365
- [Sound Rec Gain Level]: 365
- [Sound Rec Level Adj.]: 366
- [Sound Rec Level Limiter]: 366
- [Wind Noise Canceller]: 367
- [Lens Noise Cut]: 368



[Sound Rec Level Disp.]

The sound recording level is displayed on the recording screen.

 →  →  → **Select [Sound Rec Level Disp.]**

Settings: [ON]/[OFF]

- When [Sound Rec Level Limiter] is set to [OFF], [Sound Rec Level Disp.] is fixed to [ON].

[Mute Sound Input]

This mutes audio input.

 →  →  → **Select [Mute Sound Input]**

Settings: [ON]/[OFF]

-  is displayed on the recording screen.
- The audio input from the external microphone will also be muted.

[Sound Rec Gain Level]

This switches the gain of audio input.

 →  →  → **Select [Sound Rec Gain Level]**

[STANDARD]	This is the standard input gain setting. (0 dB)
[LOW]	Audio input is reduced for recording in environments with loud noises. (–12 dB)

[Sound Rec Level Adj.]

Manually adjust the sound recording level.

1 Select [Sound Rec Level Adj.].

-  → [] → [] → [Sound Rec Level Adj.]

2 Press ◀▶ to adjust the sound recording level and then press or .

- You can adjust the sound recording level within the range from [MUTE], [−18dB] to [+12dB] in steps of 1 dB.
- Displayed dB values are approximate.

- When set to [MUTE],  is displayed in the recording screen.

[Sound Rec Level Limiter]

The sound recording level is adjusted automatically to minimize sound distortion (crackling noise).

 → [] → [] → **Select [Sound Rec Level Limiter]**

Settings: [ON]/[OFF]

[Wind Noise Canceller]

This reduces the wind noise coming into the built-in microphone while maintaining sound quality.

 →  →  → **Select [Wind Noise Canceller]**

[HIGH]	This effectively reduces the wind noise by reducing the low-pitched sound when a strong wind is detected.
[STANDARD]	This reduces wind noise without loss of sound quality by filtering out only wind noise.
[OFF]	—

- You may not see the full effect depending on the recording conditions.
- This function works only with the built-in microphone.
When an external microphone is connected, [Wind Cut] is displayed.
(→ [Reduction of Wind Noise: 438](#))

[Lens Noise Cut]

You can reduce the zoom sound produced during video recording when you are using interchangeable lens compatible with power zoom.

 ➔  ➔  ➔ **Select [Lens Noise Cut]**

Settings: [ON]/[OFF]

- When this function is used, the sound quality may differ from that during normal operation.

Main Assist Functions

- [SS/Gain Operation]: 370
- [WFM/Vector Scope]: 371
- [Luminance Spot Meter]: 375
- [Zebra Pattern]: 377
- [Frame Marker]: 379
- Color bars/Test Tone: 380

This section describes the main assist functions that are convenient when recording.

- The [Custom] ([Monitor / Display (Video)]) menu has display assist functions such as the center marker. (→[Custom] menu ([Monitor / Display (Video)]): 575)

[SS/Gain Operation]



You can switch the units of shutter speed values and gain (sensitivity) values.

→ → → **Select [SS/Gain Operation]**

[SEC/ISO]	Displays the shutter speed in seconds and the gain in ISO.
[ANGLE/ISO]	Displays the shutter speed in degrees and the gain in ISO. <ul style="list-style-type: none"> • The angle can be set in a range between 11° and 358°. (When [Synchro Scan] is set to [OFF])
[SEC/dB]	Displays the shutter speed in seconds and the gain in dB. <ul style="list-style-type: none"> • 0 dB is equivalent to ISO 200. (When [Photo Style] is set to [V-Log L] or [Hybrid Log Gamma], it is equivalent to ISO 400.)

- When [SS/Gain Operation] is set to [SEC/dB], menu names change as shown below:
 - [ISO Sensitivity (video)] → [Gain Setting]
 - [ISO Auto Lower Limit Setting] → [Auto Gain Lower Limit Setting]
 - [ISO Auto Upper Limit Setting] → [Auto Gain Upper Limit Setting]
 - [Extended ISO] → [Extended Gain Setting]
 - [ISO Displayed Setting] → [Gain Displayed Setting]

[WFM/Vector Scope]



This displays the waveform monitor or the vector scope on the recording screen. You can change the size of the waveform display.

1 Set the mode dial to [iM].

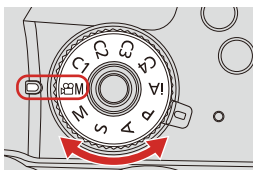

2 Set [WFM/Vector Scope].

- **MENU/SET** → **[Settings]** → **[Camera]** → [WFM/Vector Scope]



[WAVE]



Displays a waveform.

[VECTOR]

Displays the vector scope.

[OFF]

3 Select the position to display.

- Press ▲▼◀▶ to select and then press  or .
- You can also move using touch operations.
- You can rotate  to change the size of the waveform.
- To return the waveform or vector scope position back to the center, press [DISP.]. With waveform, pressing [DISP.] once again returns the size to the default setting.

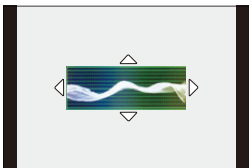

❖ Screen Displays

Waveform

- The waveform displayed on the camera indicates the luminance as values based on the conversions below:

0 % (IRE^{*1}): Luminance value 16 (8-bit)

100 % (IRE^{*1}): Luminance value 235 (8-bit)

*1 IRE: Institute of Radio Engineers



(A) 109 % (IRE) (Dotted line)

(B) 100 % (IRE)

(C) 50 % (IRE)

(D) 0 % (IRE)

(E) -4 % (IRE) (Dotted line)

(F) The range between 0 % and 100 % shows dotted lines at intervals of 10 %.

Display example

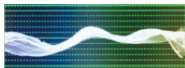

Vector scope

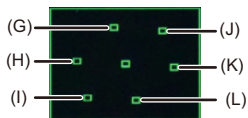

(G) R (Red)

(H) YL (Yellow)

(I) G (Green)

(J) MG (Magenta)

(K) B (Blue)

(L) CY (Cyan)

Display example



- You can also change the position by dragging on the recording screen.
- The waveform and vector scope are not output through HDMI.
- When [WFM/Vector Scope] is set, [Histogram] does not work.

[Luminance Spot Meter]



iA P A S M



Specify any spot on the subject to measure the luminance over a small area.

1 Set [Luminance Spot Meter].

- → → → [Luminance Spot Meter] → [ON]



2 Select the position where you want to measure the luminance.

- Press ▲▼◀▶ to select and then press  or .
- You can also change the position by dragging the frame on the recording screen.
- To return the position back to the center, press [DISP.].

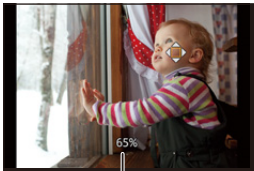

(A)

(A) Luminance value

❖ Measurement Range

Measuring is possible in the range -7% to 109% (IRE).

- When [Photo Style] is set to [V-Log L], this can be measured with “Stop” units.
(Calculated as “0 Stop”= 42% (IRE))

[Zebra Pattern]

Parts that are brighter than the benchmark value are displayed with stripes.

You can also set the benchmark value and the breadth of the range so that the stripes are displayed on parts that are within the range of brightness you specify.

**[ZEBRA1]****[ZEBRA2]****[ZEBRA1+2]**

→ [] → [] → **Select [Zebra Pattern]**

[ZEBRA1]	Parts that are brighter than the benchmark value are displayed with [ZEBRA1] stripes.
[ZEBRA2]	Parts that are brighter than the benchmark value are displayed with [ZEBRA2] stripes.
[ZEBRA1+2]	Both [ZEBRA1] and [ZEBRA2] are displayed.
[OFF]	—
[SET]	Sets the benchmark brightness. [Zebra 1]/[Zebra 2] [50%] to [105%]/[BASE/RANGE]

❖ When [BASE/RANGE] Was Selected with [SET]

Centered on the brightness set with [Base Level], parts with the brightness in the range set in [Range] are displayed with the stripes.

- [Base Level] can be set in the range between 0 % and 109 % (IRE).
- [Range] can be set in the range between ± 1 % and ± 10 % (IRE).
- When [Photo Style] is set to [V-Log L], these are set at “Stop” units.
(Calculated as “0 Stop”=42 % (IRE))

- [ZEBRA1+2] cannot be selected while you are setting [BASE/RANGE].

[Frame Marker]

A frame with the set aspect ratio is displayed on the recording screen. This allows you to see during recording the angle of view that will be achieved with trimming (cropping) in post-processing.

MENU/SET → **[Settings]** → **[Frame Marker]** → **Select [Frame Marker]**

[ON]	Displays video grid lines on the recording screen.
[OFF]	—
[SET]	Sets the aspect ratio of video grid lines. [Frame Aspect]: [2.39:1]/[2.35:1]/[2.00:1]/[1.85:1]/[16:9]/[4:3]/[5:4]/[1:1]/[4:5]/[9:16]
	[Frame Color]: Sets the color of video grid lines.
	Sets the outer side opacity of video grid lines. [Frame Mask]: [100%]/[75%]/[50%]/[25%]/[OFF]

Color bars/Test Tone



The color bars are displayed on the recording screen.
A test tone is output while the color bars are being displayed.



[SMPTE]



[EBU]



[ARIB]

 →  →  → **Select [Color Bars]**

Settings: [SMPTE]/[EBU]/[ARIB]

- To end the display, press .

❖ Adjusting the Test Tone

There are 4 levels ([−12dB], [−18dB], [−20dB], and [MUTE]) of test tone to select.

1 Rotate ,  or  to select the test tone level.

- The color bars and test tone will be recorded on the video if video recording is started while the color bars are being displayed.
- The brightness and coloring that appear on the camera's monitor or viewfinder may differ from those that appear on another device such as an external monitor.

[Variable Frame Rate]



By recording using a frame rate that is different to the playback frame rate, you can record smooth slow motion video and fast motion video.

<p>Slow Motion Video (Overcrank Recording)</p>	<p>Set a number of frames that is higher than the recording frame rate of the [Rec Quality]. For example: When recording at 48 fps and set to a 24.00p [Rec Quality], the speed is halved.</p>
<p>Fast Motion Video (Undercrank Recording)</p>	<p>Set a number of frames that is lower than the recording frame rate of the [Rec Quality]. For example: When recording at 12 fps and set to a 24.00p [Rec Quality], the speed is doubled.</p>

1 Set the mode dial to [iM].

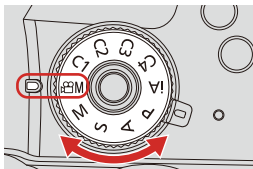

2 Set [Rec. File Format] to [MOV].

- **MENU/SET** → [] → [] → [Rec. File Format] → [MOV]

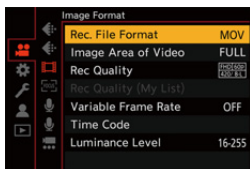

3 Select a recording quality with which you can use [Variable Frame Rate] recording.

- **MENU/SET** → [] → [] → [Rec Quality]
- Items with which you can use [Variable Frame Rate] are indicated as [VFR available].
- Recording qualities with which you can use [Variable Frame Rate] recording (→ [List of Recording Qualities That Enable Special Videos to be Recorded: 416](#))

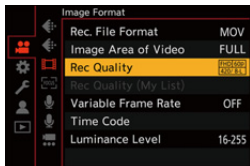

4 Set [Variable Frame Rate].

- Press **MENU/SET** → [] → [] → [Variable Frame Rate] → [ON]
- Press ◀▶ to switch between [ON] and [OFF].

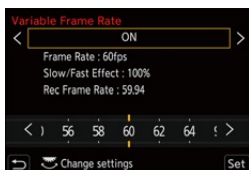

5 Set the frame rate.

- Rotate , or to select a numeric value, then press **MENU/SET** or .

❖ Available Frame Rate Setting Ranges

The frame rate you can set differs depending on the [Rec Quality] settings.

[Rec Quality]	Frame rate
4K Anamorphic (4:3) video	2 fps to 50 fps ^{*1}
C4K video/4K video	2 fps to 60 fps
FHD video	2 fps to 180 fps ^{*2}

*1 When set to a 23.98p or 24.00p [Rec Quality], a frame rate exceeding 48 fps cannot be set.

*2 When the frame rate is set to 150 fps or higher, [Image Area of Video] will be set to [FULL].

- You can filter to show just the recording qualities where [Variable Frame Rate] can be used. (→[\[Filtering\]: 345](#))
- We recommend using a tripod when recording images with [Variable Frame Rate].
- Focus mode switches to MF.
(When using an interchangeable lens with no focus ring, you cannot set focus with MF.)
- If you press the [AF ON] only before recording starts, the focus will be adjusted automatically.
 - You can also perform the same operation by pressing the Fn button assigned with [AF-ON]. (→[Fn Buttons: 471](#))
- Audio will not be recorded during variable frame rate recording.
- When set to a frame rate exceeding 60 fps, there may be some deterioration in recording quality.
- When the following functions are being used, [Variable Frame Rate] is not available:
 - [Filter Settings]
 - [Live Cropping]

[Focus Transition]



Smoothly transitions the focus position from the current position to a position registered in advance.

1 Set the mode dial to [iM].

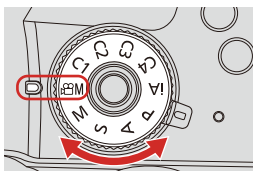

2 Select [Focus Transition].

- [MENU/SET] → [Video Camera Icon] → [Focus Transition Icon] → [Focus Transition]

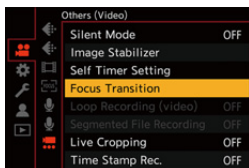



3 Set the recording settings.

[Start]

Start recording.

[Focus Pull Setting]

Registers the focus position.

- The setting screen for the focus position is displayed when you select either [1], [2], or [3]. Use the same procedure as MF (→ [Record Using MF: 167](#)) to check the focus, then press  or  to register the focus position.

[Focus Transition Speed]

Sets the moving speed of focus.

- Moving speed: [SH] (fast) to [SL] (slow)

[Focus Transition Rec]



Starts Focus Transition when recording starts.

- Select the position registered with [Focus Pull Setting].

[Focus Transition Wait]

Sets the wait time before the start of Focus Transition.

4 Close the menu.

- Selects [Start], and press  or .
- The recording screen is displayed.
- To return to the setting screen, press [DISP].

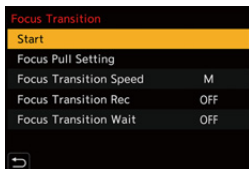

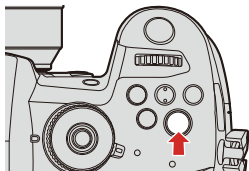

5 Start recording.

- Press the video rec. button.
- If you have enabled [Focus Transition Rec], Focus Transition will start when you start recording a video.



6 Start Focus Transition.

- Press ◀▶ to select [1], [2], or [3], and then press  or .
- When [Focus Transition Wait] is set, Focus Transition starts after the set time has elapsed.

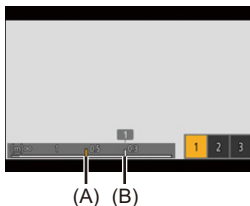

- (A) Current focus position
 (B) Registered focus position

7 End Focus Transition.

- Press [Q].

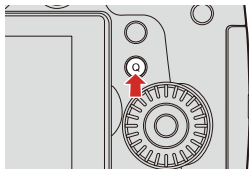

8 Stop recording.

- Press the video rec. button once again.

- Maintain the same distance to the subject after setting the focus position.
- The moving speed of focus varies depending on the lens being used.
- While using [Focus Transition], it is not possible to focus on anything other than the registered focus position.
- Any of the operations below will clear the focus position settings.
 - Operating the camera on/off switch
 - Zoom operation
 - Switching the focus mode
 - Switching the recording mode
 - Replacing the lens
- When the following functions are being used, [Focus Transition] is not available:
 - [Variable Frame Rate]
 - [Live Cropping]
- [Focus Transition] cannot be used when using an interchangeable lens that does not support the focus mode [AFC].

[Live Cropping]



By cropping a part of the image from the image displayed in the live view, it is possible to record FHD video that incorporates panning and zooming with the camera staying in a fixed position.



Pan



Zoom in

- Use a tripod to minimize camera shake.

1 Set the mode dial to [CAM].

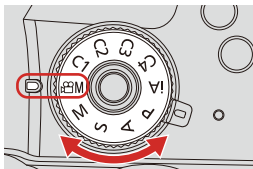

2 Set [Rec. File Format].

- **MENU/SET** → [CAM] → [Rec. File Format] → [MP4]/[MOV]

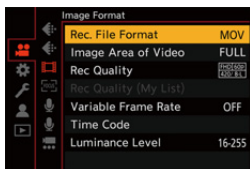

3 Select a recording quality with which you can record [Live Cropping] video.

- **MENU/SET** → [CAM] → [Rec Quality]
- A recording quality with which you can record [Live Cropping] video (→ [List of Recording Qualities That Enable Special Videos to be Recorded: 416](#))

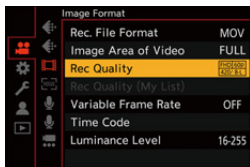

4 Set the time for panning or zooming.

- **MENU/SET** → [] → [] → [Live Cropping] → [40SEC]/[20SEC]
- If you have selected a recording quality where Live Cropping recording is not available, the camera switches to an FHD video recording quality where recording is possible.



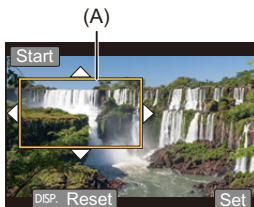

5 Set the cropping start frame.

- Select the range to be cropped and press **MENU/SET** or **DISP.**



(A) Cropping start frame

6 Set the cropping end frame.

- Select the range to be cropped and press  or .
- To redo the settings for the position and size of the start frame and the end frame, press ◀.

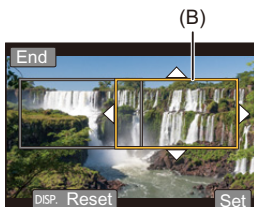

(B) Cropping end frame

7 Start Live Cropping recording.



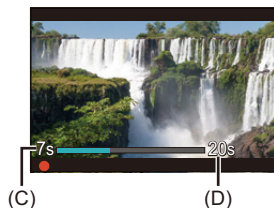
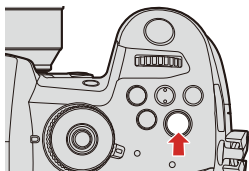

- Press the video rec. button.
- When the set operating time has elapsed, recording automatically ends.
To end recording midway, press the video rec. button again.





(C) Elapsed recording time

(D) Set operating time

❖ Operations for Setting the Cropping Frame

Button operation	Touch operation	Description of operation
	Touch	Moves the frame.
	Pinch out/ pinch in	Enlarges/reduces the frame in small steps.
	—	Enlarges/reduces the frame.
[DISP.]	[Reset]	Start frame: Returns the frame position and size to the default settings. End frame: Cancels the settings for the position and size of the frame.
	[Set]	Confirms the frame position and size.

- AF mode switches to [] ([Human Detect AF]). (Human bodies cannot be detected. It is not possible to specify the person to bring into focus.)
- Brightness measurements and focusing are performed within the cropping frame. To lock the focus point, set [Continuous AF] to [OFF], or set the focus mode to [MF].
- [Metering Mode] will be [] (multi-metering).

Log Recording

- [V-Log L] Settings: 396
- [V-LogL View Assist]: 398



[V-Log L] Settings

Setting [Photo Style] to [V-Log L] enables Log recording.

Images finished with rich gradation can be created through post production processing.

 ⇒  ⇒  ⇒ [Photo Style] ⇒ Select [V-Log L]

- Post-production processing is enabled by utilizing LUT (Look-Up Table).
You can download LUT data from the following support site:
<https://panasonic.jp/support/global/cs/dsc/download/index3.html>
(English only)

❖ ISO Sensitivity When [V-Log L] Is Set

The lower limit of available ISO sensitivities will become [400].

❖ Exposure When [V-Log L] Is Set

The [V-Log L] curve characteristics comply with “V-Log/V-Gamut REFERENCE MANUAL Rev.1.0”. When set to [V-Log L], the standard exposure when gray with a reflectance ratio of 18 % is imaged is IRE 42 %.

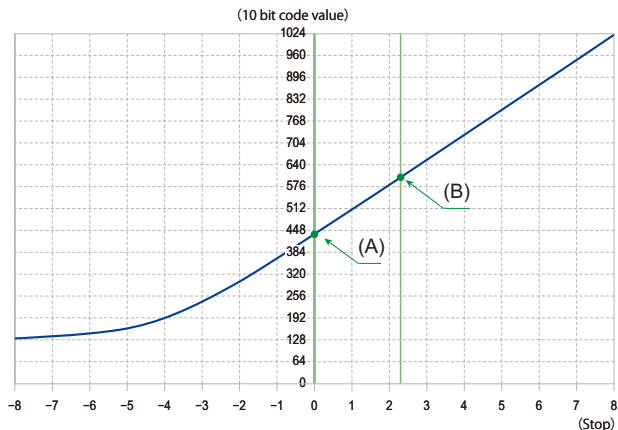

(A) Reflectance ratio: 18 %

(B) Reflectance ratio: 90 %

When [Photo Style] is set to [V-Log L]

Reflectance ratio (%)	0	18	90
IRE (%)	7.3	42	61
Stop	—	0.0	2.3
10 bit code value	128	433	602
12 bit code value	512	1732	2408

- When luminance is to be displayed by “Stop” units, this camera calculates IRE 42 % to “0 Stop”.

- Luminance can be checked by “Stop” units:

[] → [] → [Luminance Spot Meter] (→[Luminance Spot Meter]: 375)

[] → [] → [Zebra Pattern] (→[Zebra Pattern]: 377)

[V-LogL View Assist]

When [Photo Style] is set to [V-Log L], the recording screen and images output via HDMI will darken. Using [V-LogL View Assist] means you can show images with LUT data applied on the monitor/viewfinder and output them via HDMI.







 → [] → [] → **Select [V-LogL View Assist]**

[Read LUT File]	Reads LUT data from the card.
[LUT Select]	Selects the LUT data to be applied from among the preset ([Vlog_709]) and registered LUT data.
[LUT View Assist (Monitor)]	Displays the images with LUT data applied on the monitor/viewfinder of the camera.
[LUT View Assist (HDMI)]	Applies LUT data to images output over HDMI.

- When applying the LUT data, [LUT] is displayed on the recording screen.
- Up to 4 LUT data files can be registered.

❖ Reading LUT Files

- The following LUT data can be used:
 - The “.vlt” format, which meets the requirements specified in the “VARICAM 3DLUT REFERENCE MANUAL Rev.1.0”
 - The number of characters that can be used in a file name differs depending on the file system of the card.
(Use alphanumeric characters for the file name.)
 - FAT32 (SD/SDHC card):** Up to 8 characters (excluding extension).
 - exFAT (SDXC card):** Up to 255 characters (including the extension).
- Save the LUT data with a file extension of “.vlt” in the root directory of the card (the folder opened when the card is opened on a PC).

- 1 Insert a card on which LUT data is saved into the camera.
- 2 Select [Read LUT File].
 -  ⇒ [] ⇒ [] ⇒ [V-LogL View Assist] ⇒ [Read LUT File] ⇒ [Card Slot 1]/[Card Slot 2]
- 3 Press ▲▼ to select the LUT data to read and then press  or .
- 4 Press ▲▼ to select the location to register the data, and then press  or .
 - When registered items are selected, they will be overwritten.

HLG Videos

- [\[Hybrid Log Gamma\] settings: 401](#)
- [\[HLG View Assist\]: 404](#)



Record videos with the wide dynamic range of the HLG format. You can record in very bright light where overexposure can occur or in dark areas where underexposure can occur, maintaining the rich yet subtle colors you can see with your naked eye.

You can view the video that you record by outputting via HDMI to devices (TVs, etc.) that support the HLG format, or playing back directly on supporting devices.

- “HLG” is a standardized HDR video format that converts and expands the dynamic range of compressed high-luminance image data on a supported device.

[Hybrid Log Gamma] settings

1 Set the mode dial to [iBM].

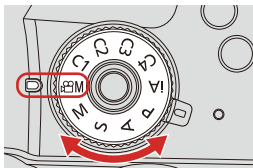

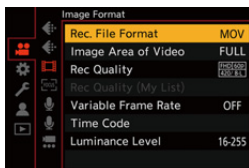

2 Set [Rec. File Format].

- **MENU/SET** → [] → [] → [Rec. File Format] → [MP4]/[MOV]





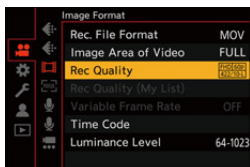

3 Select a recording quality with which you can record HLG video.

-  ⇒ [] ⇒ [] ⇒ [Rec Quality]
- Items available for recording with HLG video are indicated as [HLG available].
- Recording qualities with which you can record HLG video (⇒ [List of Recording Qualities That Enable Special Videos to be Recorded: 416](#))



4 Set [Photo Style] to [Hybrid Log Gamma].

-  ⇒ [] ⇒ [] ⇒ [Photo Style] ⇒ [Hybrid Log Gamma]
- You can also display the setting screen of [Photo Style] by pressing [] in the recording screen.



- When the [Rec. File Format] has been set to [MOV], you can display just the recording qualities where HLG video recording can be used. (→[Filtering]: 345)
- The monitor and viewfinder on this camera do not support display of HLG format images.
With [Monitor] in [HLG View Assist] in the [Custom] ([Monitor / Display (Video)]) menu, you can display the images converted for monitoring on the monitor/viewfinder of this camera. (→[HLG View Assist]: 404)
- HLG images are shown dark on devices that do not support the HLG format.
With [HDMI] in [HLG View Assist] of the [Custom] ([Monitor / Display (Video)]) menu, you can set the conversion method for images displayed for monitoring. (→[HLG View Assist]: 404)

❖ ISO Sensitivity When [Hybrid Log Gamma] Is Set

The lower limit of available ISO sensitivities will become [400].

[HLG View Assist]

At recording or playback of HLG video, this displays images with converted color gamut and brightness on the camera monitor/viewfinder, or outputs these over HDMI.

 →  →  → **[HLG View Assist]** → **[Monitor]** or **[HDMI]**

[AUTO]*1	Converts images before outputting them via HDMI while applying the effect of [MODE2]. This conversion setting works only when the camera is connected to a device that does not support HDR (HLG format).
[MODE1]	Converts with an emphasis on bright areas such as sky. • [MODE1] is displayed on the recording screen.
[MODE2]	Converts with an emphasis on the brightness of a main subject. • [MODE2] is displayed on the recording screen.
[OFF]	Displays without converting color gamut and brightness. • HLG images appear darker on devices that do not support the HLG format.

*1 Can only be set while [HDMI] is selected.

Anamorphic Recording

- [6K/4K Anamorphic \(4:3\) video: 406](#)
- [\[Anamorphic Desqueeze Display\]: 407](#)



This camera can record video with a resolution of 6K-A/4K-A (6K/4K anamorphic (4:3) video) that is compatible with anamorphic recording with an aspect ratio of 4:3.



Along with the normal 16:9 video aspect ratio, you can select the recording quality suited to anamorphic recording.

- It is also possible to switch to an image stabilizer that suits anamorphic recording. (→ [Image Stabilizer Settings: 246](#))

- When [Rec. File Format] is set to [MOV], by filtering [Rec Quality] by the number of pixels, you can display just those recording qualities with resolutions and aspect ratios that meet the conditions. (→ [\[Filtering\]: 345](#))



6K/4K Anamorphic (4:3) video

1 Set [Rec. File Format] to [MOV].

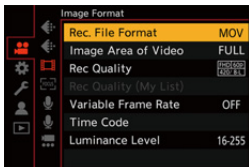
-  →  →  → [Rec. File Format] → [MOV]



2 Select a recording quality wherein you can record 6K/4K Anamorphic (4:3) video.

-  →  →  → [Rec Quality]
- Items available for recording 6K/4K Anamorphic (4:3) video are indicated as [ANAMOR].
- Recording qualities wherein you can record 6K/4K Anamorphic (4:3) video (→ [List of Recording Qualities That Enable Special Videos to be Recorded: 416](#))

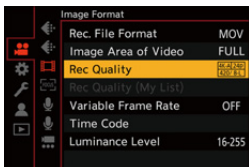

[Anamorphic Desqueeze Display]





Display the de-squeezed images suited to the magnification of the anamorphic lens on this camera.

Using the [Frame Marker], it is also possible to impose on display the frame of the angle of view when cropping after de-squeeze editing.

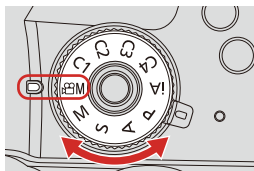
1 Set the mode dial to [iM].



2 Set [Anamorphic Desqueeze Display].

-  →  →  → [Anamorphic Desqueeze Display]

 ([2.0×])

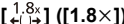
 ([1.8×])

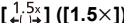
 ([1.5×])

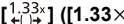
 ([1.33×])

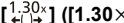

 ([1.30×])

[OFF]

- Make settings to suit the magnification of the anamorphic lens you are using.



3 Set [Frame Marker].

-  → [] → [] → [Frame Marker] (→ [\[Frame Marker\]: 379](#))



- Images output via HDMI are not de-squeezed.
- This camera is not compatible with de-squeeze editing of video recorded with anamorphic recording. Use compatible software.

[Synchro Scan]



Fine-adjust the shutter speed to reduce flickering and horizontal stripes. The shutter speed set in Synchro Scan is saved separately from the shutter speed used for normal recording.

In the Synchro Scan setting screen you can call up the current shutter speed for normal recording and adjust it.

1 Set the mode dial to [M].

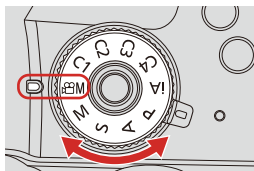

2 Set the exposure mode to [S] or [M].

- → → → [Exposure Mode] → [S]/[M]





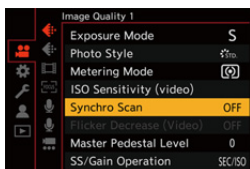

3 Set [Synchro Scan].

-  →  →  → [Synchro Scan] → [ON]



4 Set the shutter speed.

- Rotate ,  or  to select a numeric value, then press  or .
- You can call up the current shutter speed for normal recording by pressing [DISP.].
- Adjust the shutter speed while looking at the screen so that flickering and horizontal stripes will be minimized.

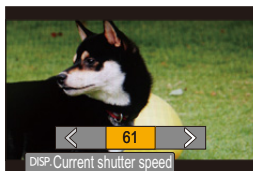

- When you set [Synchro Scan] to [ON], the available shutter speed range becomes narrower.

[Loop Recording (video)]



Even when recording uses up the card's free space, the camera continues the recording by deleting the oldest segment of the recorded data.

1 Set the mode dial to [M].

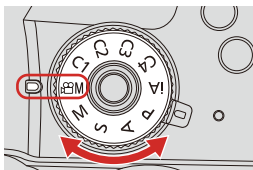

2 Set [Rec. File Format] to [MOV].

- **MENU/SET** → [Video Icon] → [Filmstrip Icon] → [Rec. File Format] → [MOV]

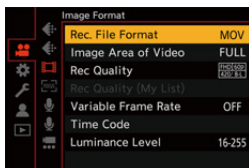

3 Set [Loop Recording (video)].

- **MENU/SET** → [] → [] → [Loop Recording (video)] → [ON]
- [] is displayed on the recording screen.
- When the recording fills the card to capacity, loop recording starts and video recording time is no longer displayed.

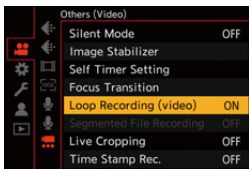

- Make sure the camera does not turn off during recording.
- Loop recording cannot start if there is insufficient available capacity on the card.
- When the recording time exceeds 12 hours, recording continues with data being deleted in order from the point where recording started.
- When the following functions are being used, [Loop Recording (video)] is not available:
 - [Rec Quality] with a bit rate of 400 Mbps
 - [Variable Frame Rate]
 - [Live Cropping]

[Segmented File Recording]



To avoid video loss due to unforeseen interruptions to the power supply, recorded video is divided every few minutes while MOV video is being recorded.

- The divided videos are saved as one group image.

1 Set [Rec. File Format] to [MOV].

- → → → [Rec. File Format] → [MOV]

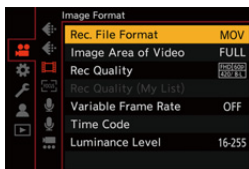

2 Set [Segmented File Recording].

- → → → [Segmented File Recording] → [10MIN.] / [5MIN.] / [3MIN.] / [1MIN.]



- When the following function is being used, [Segmented File Recording] is not available:
 - [Loop Recording (video)]

List of Recording Qualities That Enable Special Videos to be Recorded

VFR : Recording qualities that enable use of [Variable Frame Rate]

Live Crop : Recording qualities that enable use of [Live Cropping]

HLG : Recording qualities with which you can record HLG video

**ANAMOR
4:3** : Recording qualities for anamorphic recording with an aspect ratio of 4:3

❖ **[Rec. File Format]: [MP4]****[System Frequency]: [59.94Hz (NTSC)]**

[Rec Quality]	Live Crop	HLG
[4K/10bit/100M/60p]		✓
[4K/8bit/100M/30p]		
[4K/10bit/72M/30p]		✓
[4K/8bit/100M/24p]		
[4K/10bit/72M/24p]		✓
[FHD/8bit/28M/60p]	✓	
[FHD/8bit/24M/24p]		
[FHD/8bit/20M/30p]	✓	

[System Frequency]: [50.00Hz (PAL)]

[Rec Quality]	Live Crop	HLG
[4K/10bit/100M/50p]		✓
[4K/8bit/100M/25p]		
[4K/10bit/72M/25p]		✓
[FHD/8bit/28M/50p]	✓	
[FHD/8bit/20M/25p]	✓	

❖ [Rec. File Format]: [MOV]

[System Frequency]: [59.94Hz (NTSC)]

[Rec Quality]	VFR	Live Crop	HLG	ANAMOR 4:3
[6K-A/30p/420/10-L]			✓	✓
[6K-A/24p/420/10-L]			✓	✓
[4K-A/60p/420/8-L]				✓
[4K-A/30p/422/10-I]			✓	✓
[4K-A/30p/422/10-L]			✓	✓
[4K-A/30p/420/8-L]	✓			✓
[4K-A/24p/422/10-I]			✓	✓
[4K-A/24p/422/10-L]			✓	✓
[4K-A/24p/420/8-L]	✓			✓
[C4K/60p/420/10-L]			✓	
[C4K/60p/420/8-L]				
[C4K/30p/422/10-I]			✓	
[C4K/30p/422/10-L]			✓	
[C4K/30p/420/8-L]	✓			
[C4K/24p/422/10-I]			✓	
[C4K/24p/422/10-L]			✓	
[C4K/24p/420/8-L]	✓			
[4K/60p/420/10-L]			✓	
[4K/60p/420/8-L]				
[4K/30p/422/10-I]			✓	
[4K/30p/422/10-L]			✓	
[4K/30p/420/8-L]	✓			
[4K/24p/422/10-I]			✓	
[4K/24p/422/10-L]			✓	
[4K/24p/420/8-L]	✓			

[FHD/60p/422/10-I]			✓	
[FHD/60p/422/10-L]			✓	
[FHD/60p/420/8-L]	✓	✓		
[FHD/30p/422/10-I]		✓	✓	
[FHD/30p/422/10-L]		✓	✓	
[FHD/30p/420/8-L]	✓	✓		
[FHD/24p/422/10-I]		✓	✓	
[FHD/24p/422/10-L]		✓	✓	
[FHD/24p/420/8-L]	✓	✓		

[System Frequency]: [50.00Hz (PAL)]

[Rec Quality]	VFR	Live Crop	HLG	ANAMOR 4:3
[6K-A/25p/420/10-L]			✓	✓
[4K-A/50p/420/10-L]			✓	✓
[4K-A/50p/420/8-L]				✓
[4K-A/25p/422/10-I]			✓	✓
[4K-A/25p/422/10-L]			✓	✓
[4K-A/25p/420/8-L]	✓			✓
[C4K/50p/420/10-L]			✓	
[C4K/50p/420/8-L]				
[C4K/25p/422/10-I]			✓	
[C4K/25p/422/10-L]			✓	
[C4K/25p/420/8-L]	✓			
[4K/50p/420/10-L]			✓	
[4K/50p/420/8-L]				
[4K/25p/422/10-I]			✓	
[4K/25p/422/10-L]			✓	
[4K/25p/420/8-L]	✓			

[FHD/50p/422/10-I]			✓	
[FHD/50p/422/10-L]			✓	
[FHD/50p/420/8-L]	✓	✓		
[FHD/25p/422/10-I]		✓	✓	
[FHD/25p/422/10-L]		✓	✓	
[FHD/25p/420/8-L]	✓	✓		

[System Frequency]: [24.00Hz (CINEMA)]

[Rec Quality]	VFR	Live Crop	HLG	ANAMOR 4:3
[6K-A/24p/420/10-L]			✓	✓
[4K-A/24p/422/10-I]			✓	✓
[4K-A/24p/422/10-L]			✓	✓
[4K-A/24p/420/8-L]	✓			✓
[C4K/24p/422/10-I]			✓	
[C4K/24p/422/10-L]			✓	
[C4K/24p/420/8-L]	✓			
[4K/24p/422/10-I]			✓	
[4K/24p/422/10-L]			✓	
[4K/24p/420/8-L]	✓			
[FHD/24p/422/10-I]		✓	✓	
[FHD/24p/422/10-L]		✓	✓	
[FHD/24p/420/8-L]	✓	✓		

11. Connections with External Devices (Video)

- [HDMI Devices \(HDMI Output\): 422](#)
- [HDMI Output Image Quality \(Resolution/Frame Rate\): 429](#)
- [HDMI Output Settings: 432](#)
- [External Microphones \(Optional\): 436](#)
- [XLR Microphone Adaptor \(Optional\): 439](#)
- [Headphones: 441](#)

HDMI Devices (HDMI Output)

- [Attaching the Cable Holder: 424](#)
- [Images Output via HDMI: 427](#)



You can record while outputting the camera images to an external monitor or external recorder connected with an HDMI cable.

- HDMI output control differs between during recording and during playback.
For HDMI output settings during playback (→ [\[HDMI Connection\]: 590](#))

Getting started:

- Turn off the camera and the external monitor/external recorder.

1 Connect the camera and an external monitor or external recorder with a commercially available HDMI cable.

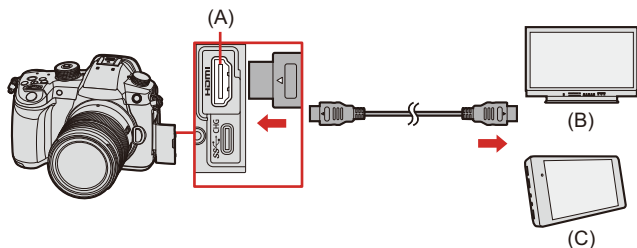

(A) [HDMI] socket (Type A)

(B) External monitor

(C) External recorder

- Check the direction of the terminals and plug in/out straight holding onto the plug. (Inserting at an angle can deform the terminal and cause malfunction.)
- Do not connect the cable to the wrong terminals. This may cause a malfunction.

• Use a “High Speed HDMI cable” with the HDMI logo.

Cables that do not comply with the HDMI standards will not work.

“High Speed HDMI cable” (Type A–Type A plug, up to 1.5 m (4.9 feet) long)

Attaching the Cable Holder

Use of the supplied cable holder prevents detachment of the cable and damage to the terminals.

- Put the camera on a stable surface to perform this task.

Example: Attaching to an HDMI cable

- 1 While pushing (A) (1), slide the clamp portion of the cable holder to remove it (2).**

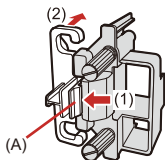

- 2 After placing the camera on a stable surface, loosely mount the cable holder to the mount on the camera (3), and secure the cable holder by rotating the screws in the direction of the arrows (4), (5).**

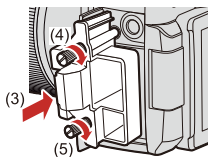

3 Attach the HDMI cable to the clamp portion (6).

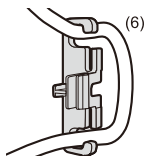

4 Slide the clamp portion to attach it to the cable holder (7).

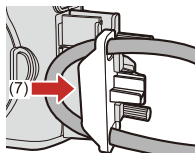

5 Connect the HDMI cable to the [HDMI] socket (8).

- You can also connect the HDMI cable and USB connection cable at the same time when the cable holder is attached.

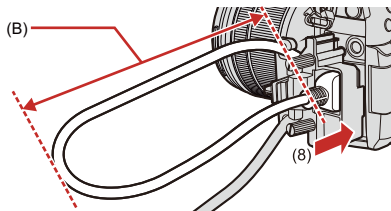

(B) Leave some slack so that this section has a length of at least 10 cm (0.33 feet).

Removing the cable holder

To remove the cable holder, follow the steps for attaching it in the reverse order.

- Do not use any other USB connection cables except the supplied USB connection cables.
- We recommend using an HDMI cable with a thickness diameter of 6 mm (0.24 inch) or less.
- It may not be possible to attach HDMI cables of certain shapes.
- Keep the clamp portion of the cable holder out of reach of children to prevent swallowing.

Images Output via HDMI

The images output via HDMI differ depending on the recording mode.

❖ [M] Mode

Aspect ratio, resolution, and frame rate output is according to the [Rec Quality] settings in the [Video] ([Image Format]) menu. Resolution and frame rate can be down-converted for output according to the application. YUV 4:2:2 is used for YUV and bit value output.

Recording to card	HDMI output
4:2:2 10-bit	4:2:2 10-bit
4:2:0 10-bit	4:2:2 10-bit
4:2:0 8-bit	4:2:2 8-bit

Resolution, frame rate

- Resolution and frame rate output according to the following menu combinations:
 - [Rec Quality] in the [Video] ([Image Format]) menu.
 - [Down Convert] in [HDMI Rec Output] of the [Custom] ([IN/OUT]) menu.
- 6K/4K Anamorphic (4:3) video is output with a 4K or FHD resolution.
- For details (→ [Image Quality When Outputting via HDMI: 430](#))

- When set to a 4:3 [Rec Quality], bands are added to the left and right of the image for output.
- Output may be in 8-bit if you output to devices that do not support 10-bit.

❖ [iA]/[P]/[A]/[S]/[M] Mode

- Output is the same as [M] mode during video recording.
- During recording standby, it is output according to the setting of [Aspect Ratio] in the [Photo] ([Image Quality]) menu.
 - When set to any [Aspect Ratio] other than 16:9, bands are added to the left and right of the image for output.
 - Resolution, frame rate, YUV, and bit value output matches the connected device.

❖ Notice Regarding HDMI Output

- It may take some time for the output method to change.
- When you use the HDMI output during recording, the image may be displayed with a time lag.
- Beep sounds, AF beep, and electronic shutter sounds are muted during HDMI output.
- When you check the image and audio from the TV connected to the camera, the microphone of the camera may pick up the sound from the speakers of the TV, producing an abnormal sound (audio feedback).
If this occurs, move the camera away from the TV or lower the volume on the TV.
- Certain setting screens are not output via HDMI.
- There is no output via HDMI while you are recording with the following functions:
 - [6K/4K PHOTO]/[Post-Focus]
- If the temperature of the camera rises, [] may be displayed, recording may stop, and some functions may become unavailable temporarily. Wait until the camera cools down.

HDMI Output Image Quality (Resolution/Frame Rate)

- [Settings for Down-Converting: 429](#)

Settings for Down-Converting

Make settings for the down-conversion of resolution and frame rate for HDMI output in the [CAM] mode.

 →  →  → **[HDMI Rec Output]** → **Select [Down Convert]**

[AUTO]	Outputs by down-converting to match the connected device.
[4K/30p] ([4K/25p])	Outputs by down-converting resolution to 4K and frame rate to either 29.97p or 25.00p.
[1080p]	Down-converts resolution to FHD (1080), and outputs as progressive.
[1080i]	Down-converts resolution to FHD (1080), and outputs as interlaced.
[OFF]	Outputs at the resolution and recording frame rate of the [Rec Quality].

- The items you can select depend on the [System Frequency] setting.
- 6K/4K Anamorphic (4:3) video is output with a 4K or FHD resolution.
- If down-converting, AF may take longer than usual for focusing, and the performance of continuous focus tracking may deteriorate.

❖ Image Quality When Outputting via HDMI

Output is with the resolution and frame rate according to the combinations of the [Rec Quality] and [Down Convert] settings.

- When [Down Convert] is set to [AUTO], the output matches the connected device.
- There is no HDMI output when setting combinations result in a [—] in the below tables.

[System Frequency]: [59.94Hz (NTSC)]

[Down Convert]	Resolution and recording frame rate of the [Rec Quality]		
	4K-A/59.94p 4K/59.94p	6K-A/29.97p 4K-A/29.97p 4K/29.97p	6K-A/23.98p 4K-A/23.98p 4K/23.98p
[4K/30p]	4K/29.97p	4K/29.97p	—
[1080p]	1080/59.94p	1080/29.97p ^{*1}	1080/23.98p
[1080i]	1080/59.94i	1080/59.94i	—
[OFF]	4K/59.94p	4K/29.97p	4K/23.98p

[Down Convert]	Resolution and recording frame rate of the [Rec Quality]		
	C4K/59.94p	C4K/29.97p	C4K/23.98p
[4K/30p]	4K/29.97p	4K/29.97p	—
[1080p]	1080/59.94p	1080/29.97p ^{*1}	1080/23.98p
[1080i]	1080/59.94i	1080/59.94i	—
[OFF]	C4K/59.94p	C4K/29.97p	C4K/23.98p

[Down Convert]	Resolution and recording frame rate of the [Rec Quality]		
	1080/59.94p	1080/29.97p	1080/23.98p
[4K/30p]	—	—	—
[1080p]	1080/59.94p	1080/29.97p ^{*1}	1080/23.98p
[1080i]	1080/59.94i	1080/59.94i	—
[OFF]	1080/59.94p	1080/29.97p	1080/23.98p

*1 Output is 1080/59.94p if the connected device is not compatible.

[System Frequency]: [50.00Hz (PAL)]

[Down Convert]	Resolution and recording frame rate of the [Rec Quality]			
	4K-A/50.00p 4K/50.00p	6K-A/25.00p 4K-A/25.00p 4K/25.00p	C4K/50.00p	C4K/25.00p
[4K/25p]	4K/25.00p	4K/25.00p	4K/25.00p	4K/25.00p
[1080p]	1080/50.00p	1080/25.00p ^{*2}	1080/50.00p	1080/25.00p ^{*2}
[1080i]	1080/50.00i	1080/50.00i	1080/50.00i	1080/50.00i
[OFF]	4K/50.00p	4K/25.00p	C4K/50.00p	C4K/25.00p

[Down Convert]	Resolution and recording frame rate of the [Rec Quality]	
	1080/50.00p	1080/25.00p
[4K/25p]	—	—
[1080p]	1080/50.00p	1080/25.00p ^{*2}
[1080i]	1080/50.00i	1080/50.00i
[OFF]	1080/50.00p	1080/25.00p

*2 Output is 1080/50.00p if the connected device is not compatible.

[System Frequency]: [24.00Hz (CINEMA)]

[Down Convert]	Resolution and recording frame rate of the [Rec Quality]		
	6K-A/24.00p 4K-A/24.00p 4K/24.00p	C4K/24.00p	1080/24.00p
[1080p]	1080/24.00p	1080/24.00p	1080/24.00p
[OFF]	4K/24.00p	C4K/24.00p	1080/24.00p

HDMI Output Settings

- [Outputting the Camera Information Display via HDMI: 432](#)
- [Outputting Control Information to an External Recorder: 433](#)
- [Outputting Down-converted Audio to an HDMI Device: 434](#)
- [Outputting Audio via HDMI: 434](#)
- [Output the enlarged display of MF assist via HDMI: 435](#)



Outputting the Camera Information Display via HDMI

Output the camera information display to an external device connected by HDMI.

 → [] → [] → [HDMI Rec Output] → Select [Info Display]

Settings: [ON]/[OFF]

Outputting Control Information to an External Recorder

Recording start and stop control information is output to an external recorder connected by HDMI.

 ➔  ➔  ➔ **[HDMI Rec Output]** ➔ **Select [HDMI Recording Control]**

Settings: [ON]/[OFF]

- [HDMI Recording Control] can be set when [HDMI Time Code Output] is set to [ON] in  mode.
- Control information is output when pressing the video rec. button or shutter button, even if the video cannot be recorded (such as when there is no card inserted into the camera).
- Only compatible external devices can be controlled.

Outputting Down-converted Audio to an HDMI Device

When an XLR Microphone Adaptor (DMW-XLR1: optional) is attached, audio is down-converted to a format suitable for the connected HDMI external device before being output.

 →  →  → **[HDMI Rec Output]** → **Select [Sound Down Convert]**

[AUTO]	Output is down-converted to match the connected device.
[OFF]	Output is according to the settings in [XLR Mic Adaptor Setting].

Outputting Audio via HDMI

Output audio to an external device connected by HDMI.

 →  →  → **[HDMI Rec Output]** → **Select [Sound Output (HDMI)]**

Settings: [ON]/[OFF]

Output the enlarged display of MF assist via HDMI

The MF Assist enlarged display is output to the external device connected via HDMI.

 → [] → [] → [HDMI Rec Output] → Select [HDMI MF Assist Output]

Settings: [ON]/[OFF]

- When [HDMI MF Assist Output] is set to [OFF] and the MF Assist enlarged display is being shown, the camera information display is not output via HDMI.

External Microphones (Optional)



With a Stereo Shotgun Microphone (DMW-MS2: optional) or Stereo Microphone (VW-VMS10: optional), you can record higher quality audio compared to the built-in microphone.

- Some optional accessories may not be available in some countries.

1 Set the camera on/off switch to [OFF].

2 Connect the camera and external microphone.

- If mounting the external microphone on the camera hot shoe, remove the hot shoe cover. (→ [Removing the Hot Shoe Cover: 305](#))

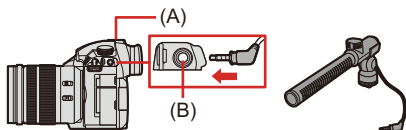

(A) Hot shoe

(B) [MIC] socket

- Do not use the stereo microphone cables with the length of 3 m (9.8 feet) or more.

❖ Setting the Sound Pickup Range (DMW-MS2: Optional)

When using the Stereo Shotgun Microphone (DMW-MS2: optional), you can set the microphone sound pickup range.

- 1 Select [Special Mic.].

-  ⇒ [] ⇒ [] ⇒ [Special Mic.]

[STEREO]

Picks up sound over a wide area.

[LENS AUTO]

Picks up sound from a range automatically set by the lens angle of view.

[SHOTGUN]

Helps prevent picking up background noise, and records sound from a specific direction.



[S.SHOTGUN]

Narrows the sound pickup range more than with [SHOTGUN].

[MANUAL]

Sets the range manually for sound pickup.

- 2 (When [MANUAL] is selected)



Press ◀▶ to adjust the sound pickup range and then press  or .

- You can register the [MANUAL] sound pickup range setting in a Fn button:

[] ⇒ [] ⇒ [Fn Button Set] ⇒ [Setting in REC mode] ⇒ [Special Mic. Directivity Adjust] (→ [Fn Buttons: 471](#))

❖ Reduction of Wind Noise

This reduces wind noise when an external microphone is connected.

 ⇒ [] ⇒ [] ⇒ Select [Wind Cut]

Settings: [HIGH]/[STANDARD]/[LOW]/[OFF]

- While the external microphone is connected, [] is displayed on the screen.
- When an external microphone is connected, [Sound Rec Level Disp.] automatically turns [ON], and the recording level is displayed on the screen.
- When the external microphone is attached, do not carry the camera by holding the external microphone. It may become detached.
- If noises are recorded when using the AC adaptor, use the battery.
- Setting [Wind Cut] may alter the usual sound quality.
- For details, refer to the operating instructions for the external microphone.

XLR Microphone Adaptor (Optional)



By attaching an XLR Microphone Adaptor (DMW-XLR1: optional) to the camera, you can use a commercially available XLR microphone to enable the recording of superior-quality high-res/stereo audio.

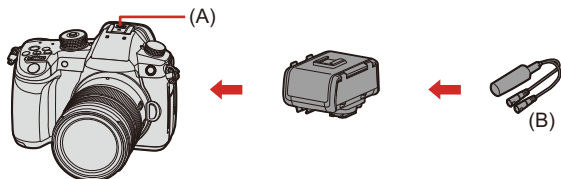

(A) Hot shoe

(B) Commercially available XLR microphone

Getting started:

- Turn off the camera, and remove the hot shoe cover. (→ [Removing the Hot Shoe Cover: 305](#))

- 1 Attach the XLR Microphone Adaptor to the hot shoe.**
- 2 Set the camera on/off switch to [ON].**

3 Select [XLR Mic Adaptor Setting].

-  →  →  → [XLR Mic Adaptor Setting]

[96kHz/24bit]

Records high resolution audio at 96 kHz/24-bit.

- Only available when [Rec. File Format] is set to [MOV].

[48kHz/24bit]

Records high-quality audio at 48 kHz/24-bit.

- Only available when [Rec. File Format] is set to [MOV].

[48kHz/16bit]

Records standard-quality audio at 48 kHz/16-bit.

[OFF]

Records audio using the built-in microphone of the camera.

- While an XLR Microphone Adaptor is attached, [XLR] is displayed on the screen.
- When [XLR Mic Adaptor Setting] is set to other than [OFF], the following settings are fixed:
 - [Sound Rec Level Limiter]: [OFF]
 - [Wind Noise Canceller]: [OFF]
 - [Sound Output]: [REC SOUND]
- [Sound Rec Gain Level] and [Sound Rec Level Adj.] cannot be used when [XLR Mic Adaptor Setting] is set to other than [OFF].
- When the XLR Microphone Adaptor is attached, [Sound Rec Level Disp.] automatically turns [ON], and the recording level is displayed on the screen.
- When the XLR Microphone Adaptor is attached, do not carry the camera by holding the XLR Microphone Adaptor. It may become detached.
- If noises are recorded when using the AC adaptor, use the battery.
- For details, refer to the operating instructions for the XLR Microphone Adaptor.

Headphones



You can record videos while monitoring their sound by connecting commercially available headphones to the camera.

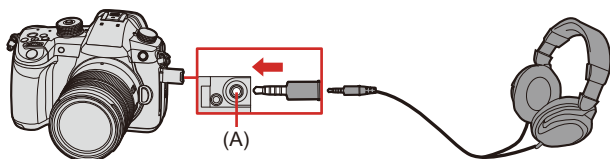

(A) Headphone socket

- Do not use the headphone cables with the length of 3 m (9.8 feet) or more.
- When headphones are connected, beep sounds, AF beep, and electronic shutter sounds are muted.

❖ Switching the Sound Output Method

 ⇒ [] ⇒ [] ⇒ Select [Sound Output]

[REALTIME]	Audio without time lag. It may differ from the sound recorded in videos.
[REC SOUND]	Audio to be recorded in videos. Output sound may be delayed from actual sound.



- The setting is fixed to [REC SOUND] in the following cases:
 - During output of audio via HDMI
 - When [Special Mic.] is set to [LENS AUTO], [SHOTGUN], [S.SHOTGUN], or [MANUAL]
 - When using an XLR Microphone Adaptor (DMW-XLR1: optional)

❖ Adjusting the Headphone Volume

Connect the headphones and rotate .



: Reduces the volume.



: Increases the volume.

- You can also adjust the volume by touching []/[] on the playback screen.

To adjust the volume using the menu:

1 Select [Headphone Volume].

-  ⇒ [] ⇒ [] ⇒ [Headphone Volume]

2 Press ▲▼ to adjust the headphone volume and then press  or .

- It can be adjusted in a range of [0] to [LEVEL15].

12. Playing Back and Editing of Images

- [Playing Back Pictures: 444](#)
- [Playing Back Videos: 446](#)
- [Switching the Display Mode: 450](#)
- [Group Images: 456](#)
- [Deleting Images: 458](#)
- [\[RAW Processing\]: 460](#)
- [\[Video Divide\]: 467](#)

This chapter explains how to play back and delete pictures and videos. It also explains editing using [RAW Processing] (→[\[RAW Processing\]: 460](#)) and [Video Divide] (→[\[Video Divide\]: 467](#)).

- Images recorded on devices other than this one may not be played back or edited correctly on this camera.
- For [Playback] menus other than [RAW Processing] and [Video Divide] (→[\[Playback\] Menu: 597](#))

Playing Back Pictures

1 Display the playback screen.

- Press [▶].

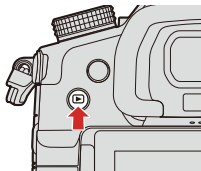

2 Select a picture.

- Select the pictures by pressing ◀▶.
- You can move continuously through images by pressing and holding ◀▶.
- You can also select by rotating 🌞 or ⚙️.
- You can also move through images by dragging the screen horizontally. By leaving your finger touching the left or right edge of the screen after dragging to change the image, you can continuously move through images.

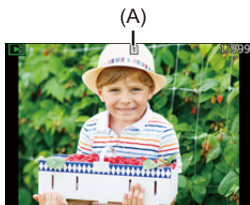

(A) Card slot

3 Stop playback.

- Press the shutter button halfway.
- You can also stop playback by pressing [▶].



❖ Switching the Card to Display

You can switch the card displayed just by pressing [] during playback.

- You can also perform the same operation by pressing the Fn button assigned with [Card Slot Change]. (→ [Fn Buttons: 471](#))

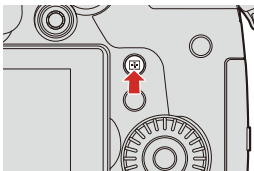
- 1 Press [].



- 2 Press ▲▼ to select [Card Slot 1] or [Card Slot 2] and then press  or .

Playing Back Videos

- [Extracting a Picture: 449](#)

1 Display the playback screen.

- Press [▶].

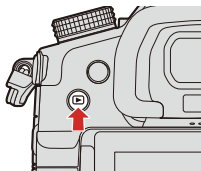

2 Select a video.

- For information about how to select images (→ [Playing Back Pictures: 444](#))
- The [👤] video icon is displayed for a video.
- The video recording time is displayed on the screen.



(A) Video recording time

3 Play back the video.

- Press ▲.
- You can also start playback by touching [▶] at the center of the screen.















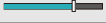

- (B) Elapsed playback time
(C) Playback bar

4 Stop playback.

- Press ▼.

❖ Operations During Video Playback

Button operation	Touch operation	Description of operation
		Plays/pauses.
	—	Stops.
	—	Performs fast-rewind playback. • If you press  again, the fast-rewind speed increases.
		Performs frame-by-frame rewinding (while paused).
	—	Performs fast-forward playback. • If you press  again, the fast-forward speed increases.
		Performs frame-by-frame forwarding (while paused).
—		Selects the frame to display.
 / 		Extracts a picture (while paused). (→ Extracting a Picture: 449)
		Reduces the volume.
		Increases the volume.

- The camera can play back videos in MP4, and MOV formats.
- Video recorded with a [System Frequency] setting that is different to the current one cannot be played back.

Extracting a Picture

Extract one frame of a video and save it as a JPEG image.

1 Pause playback at the position you wish to extract a picture.

- Press ▲.
- To fine-adjust the position, press ◀▶ (rewind frame-by-frame or forward frame-by-frame).



2 Save the picture.

- Press  or .
- You can also save the picture by touching [Save].

- The picture created from the video is saved with a [FINE] picture quality. The picture is saved with a size according to the resolution of the [Rec Quality].
- The image quality of a picture created from a video may be coarser than normal.
-  is displayed on the detailed information display screen for a picture created from a video.

Switching the Display Mode

- [Enlarged Display: 450](#)
- [Thumbnail Screen: 452](#)
- [Calendar Playback: 454](#)





You can use features to do things like enlarge recorded images for display and switch to thumbnail display to display multiple images at once (multiplayback).

You can also switch to calendar display to show images of a selected recording date.

Enlarged Display



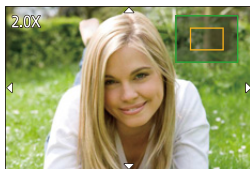

Playback images can be displayed enlarged (Playback Zoom).

1 Enlarging the playback screen.

- Rotate  to the right.
- The playback screen is enlarged in the order of 2×  4×  8×  16×.
- Rotating  to the left returns to the previous display size.
- Pictures taken with [Picture Quality] set to [RAW] cannot be displayed enlarged at 16×.



❖ Operations During Enlarged Display





Button operation	Touch operation	Description of operation
	—	Enlarges/reduces the screen.
—	Pinch out/ pinch in	Enlarges/reduces the screen in small steps.
	Drag	Moves the enlarged display position.
 / 	—	Forwards or rewinds images while maintaining the same zoom magnification and zoom position.

- You can display the point focused with AF. You can enlarge the display from that point:

[] ⇒ [] ⇒ [Magnify from AF Point] (⇒ [\[Magnify from AF Point\]: 600](#))

Thumbnail Screen

1 Switch to thumbnail display.

- Rotate  to the left.
- The display is switched in the order of 12-image screen  30-image screen.
- Rotating  to the left during 30-image screen display switches to calendar display. (→ [Calendar Playback: 454](#))
- Rotating  to the right returns to the previous display.
- You can also switch the display by touching an icon.

[]: 1-image screen

[]: 12-image screen

[]: 30-image screen







[]: Calendar (→ [Calendar Playback: 454](#))



(A)



(A) Card slot



2 Select an image.

- Press     to select an image and then press  or .

- When you press [] while a thumbnail is being displayed, you can switch to the card being displayed.
- You can scroll the screen by dragging the thumbnail display up or down.
- Images indicated with [] cannot be played back.

Calendar Playback

1 Switch to calendar playback.

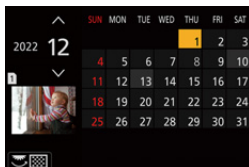

- Rotate  to the left.
- The display is switched in the order of thumbnail screen (12 images) ⇨ Thumbnail screen (30 images) ⇨ Calendar playback.
- Rotating  to the right returns to the previous display.



2 Select the recording date.

- Press ▲▼◀▶ to select a date and then press  or .

3 Select an image.

- Press ▲▼◀▶ to select an image and then press  or .
- Rotating  to the left returns to calendar playback.

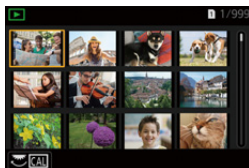

- The card to display cannot be switched during calendar display.
- The range that the calendar can be displayed is January 2000 to December 2099.

Group Images

Images recorded with Time Lapse Shot or Stop Motion Shooting are handled as group images in the camera, and can be deleted and edited on a group basis.

(For example, if you delete a group image, all images in the group are deleted.)

You can also delete and edit each image in a group individually.

❖ Images Handled as Group Images by the Camera



	Group images saved with [6K/4K PHOTO Bulk Saving].
	Group images recorded with Focus Bracket.
	Group images recorded with Time Lapse Shot.
	Group images recorded with Stop Motion Shooting.
	Group images recorded with [Segmented File Recording].

❖ **Playing and Editing the Images in a Group One by One**

Operations such as displaying thumbnails and deleting images are available with images in groups just as with normal playback.

- 1 Select the group image in the playback state. (→ [Playing Back Pictures: 444](#))
- 2 Press ▼ to display the images in the group.
 - You can also perform the same operation by touching the group image icon.
- 3 Press ◀▶ to select an image.
 - To return to the normal playback screen, press ▼ or touch [▼▶] again.

Deleting Images

- Images cannot be restored once they have been deleted. Carefully confirm the images before deletion.
- You can only delete the images in the card of the selected card slot.
- If you delete a group image, all images in the group are deleted.

1 Press [] in playback state.

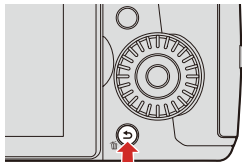

2 Press ▲▼ to select the deletion method and then press





 or .





[Delete Single]

Deletes the selected image.

[Delete Multi]

Selecting and deleting multiple images.

- 1 Press ▲▼◀▶ to select the image to delete and then press  or .
 -  is displayed for the selected image.
 - If you press  or  again, the selection is canceled.
 - Up to 100 images can be selected.
- 2 Press [DISP.] to delete the selected image.

- To switch the card selected for deleting images, press [] and then select the card slot.
- Depending on the number of images to be deleted, it may take some time to delete them.
- You can set which of [Yes] and [No] is selected initially in the confirmation screen when deleting:
[] ⇒ [] ⇒ [Delete Confirmation] (→ [\[Delete Confirmation\]: 608](#))
- All images on the card can be deleted:
[] ⇒ [] ⇒ [Delete All Images] (→ [\[Delete All Images\]: 608](#))

[RAW Processing]



This processes pictures taken in RAW format on the camera and saves them in JPEG format.

1 Select [RAW Processing].

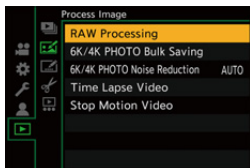
-  → [▶] → [🖼️] → [RAW Processing]





2 Select the RAW image.

- Press ◀▶ to select an image and then press  or .
- When group images are selected, press ▼ and then select an image in the group.
Press ▼ again to return to the normal selection screen.
- The settings from the time of recording are reflected in displayed images.



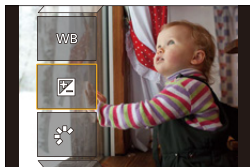

3 Select a setting item.

- Press ▲▼ to select an item and then press  or .





4 Change the setting.

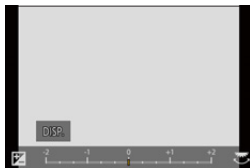

- Rotate , , or .
- The image can be enlarged/reduced by pinching out/pinching in the screen.



5 Confirm the setting.



- Press  or .
- The screen of Step 3 reappears.
To set another item, repeat Steps 3 to 5.

6 Save the image.

- Press ▲▼ to select [Begin Processing] and then press  or .



❖ Setting Items ([RAW Processing])

[Begin Processing]	Saves the image.
[White Balance]	<p>Selects and adjusts the white balance.</p> <p>Selecting the item with [] enables processing with the same setting as at the time of recording.</p> <ul style="list-style-type: none"> • If you press ▼ in the [White Balance] selection screen, the white balance adjustment screen appears. • If you press ▲ while [] to [] is selected, the color temperature setting screen appears.
[Brightness correction]	<p>Corrects the brightness.</p> <ul style="list-style-type: none"> • The [Brightness correction] effect differs from the effect of exposure compensation during recording.
[Photo Style]	<p>Selects a Photo Style.</p> <ul style="list-style-type: none"> • If you press [Q] while [Like709] is selected, the knee setting screen appears. (→ Recording While Controlling Overexposure (Knee): 360) • You cannot select a Photo Style for images recorded with [V-Log L]. You cannot select [V-Log L] for images not recorded with [V-Log L]. • You cannot select a Photo Style other than [Cinelike D2] or [Cinelike V2] for images recorded with [Cinelike D2] or [Cinelike V2]. You cannot select [Cinelike D2] or [Cinelike V2] for images not recorded with Photo Style [Cinelike D2] or [Cinelike V2].

[i.Dynamic Range]	Selects the setting of [i.Dynamic Range].
[Contrast]	Adjusts the contrast.
[Highlight]	Adjusts the brightness of bright portions.
[Shadow]	Adjusts the brightness of dark portions.
[Saturation]/[Color Tone]	Adjusts the saturation or color tone.
[Hue]	Adjusts the hue.
[Filter Effect]	Selects filter effects.
[Grain Effect]	Selects a grain effect setting.
[Color Noise]	Color can be added with a grainy texture.
[Noise Reduction]	Sets noise reduction.
[Sharpness]	Adjusts the sharpness.
[More Settings]	<p>[Revert To Original]: Returns the settings to the ones from the time of recording.</p> <p>[Color Space]: Selects a Color Space setting from [sRGB] or [AdobeRGB].</p> <p>[Picture Size]: Selects the size for storing images.</p> <p>[Destination Card Slot]: You can select the card slot to which to save images processed with RAW. When [AUTO] is selected, the image is saved to the same card slot as the RAW format image to be processed.</p>

- The items that can be adjusted depend on the selected [Photo Style].





	STD. VIVID NAT FLAT LAND PORT CNE2 CNEV2	L.CLAS N	MONO L.MONO L.MONOD L.MONOS	709L	V-LogL
WB	✓	✓	✓	✓	✓
	✓	✓	✓	✓	✓
	✓	✓	✓	✓	—
	✓	✓	✓	—	—
	✓	✓	✓	—	—
	✓	✓	✓	—	—
	✓	✓	✓	—	—
 ([Saturation])	✓	✓	—	✓	—
 ([Color Tone])	—	—	✓	—	—
	✓	✓	—	✓	—
	—	—	✓	—	—
	—	✓	✓	—	—
	—	✓	—	—	—
NR	✓	✓	✓	✓	✓
S	✓	✓	✓	✓	✓

❖ Displaying a Comparison Screen

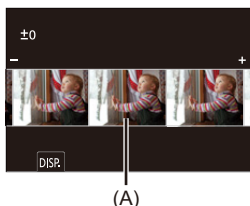
You can change a setting while checking the effect by displaying images with the applied setting value side by side.

- 1 Press [DISP.] in the screen of Step 4.
 - The image with the current setting (A) is displayed at the center.
 - Touching the image with the current setting enlarges it.
 - Touching [↩] returns to the original display.
 - A comparison screen cannot be displayed while [Noise Reduction] or [Sharpness] is selected.



- 2 Rotate , , or  to change the setting.
- 3 Press  or  to confirm the setting.

- RAW images recorded with the camera are recorded in the [L] size of [4:3]. With this function, images are processed with the aspect ratio and the angle of view of [Ex. Tele Conv.] from the time of recording.
- The [White Balance] item is fixed to the setting from the time of recording for pictures recorded with multiple exposures.
- The results of RAW processing with this function and with the “SILKYPIX Developer Studio” software do not completely match.

[Video Divide]

Divide a recorded video or 6K/4K burst file into two.



- Images cannot be returned to their original state once they have been divided. Carefully confirm the images before performing the divide operation.
- Do not remove the card or battery from the camera during the divide process. The images may be lost.

1 Select [Video Divide].

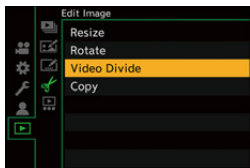
-  → [▶] → [✂] → [Video Divide]



2 Select and play the image.

- Press ◀▶ to select an image and then press  or .



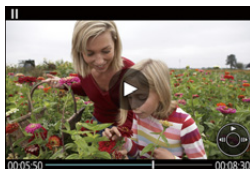

3 Pause playback at the position you wish to divide.

- Press ▲.
- To fine-adjust the position, press ◀▶ (frame-by-frame rewind or frame-by-frame forward).



4 Divide the video.

- Press  or .
- You can also divide the video by touching [Divide].

- Dividing the video at a point close to the start or end may not be possible.
- Videos with a short recording time cannot be divided.
- [Video Divide] cannot be used on images recorded using [Segmented File Recording].

13. Camera Customization

- [Fn Buttons: 471](#)
- [\[Dial Operation Switch\]: 487](#)
- [Quick Menu Customization: 490](#)
- [Custom Mode: 498](#)
- [My Menu: 503](#)
- [\[Save/Restore Camera Setting\]: 505](#)

This chapter describes the customization function with which you can configure the camera to your preferred settings.

Change how buttons, dials, etc. on the camera are to be operated.

- [\[Fn Button Set\]](#) (→ [Fn Buttons: 471](#))



- [\[Dial Operation Switch Setup\]](#) (→ [\[Dial Operation Switch\]: 487](#))



Register the currently set information of the camera.

- Custom mode (→ [Custom Mode: 498](#))



Change menu display items.

- Quick menu (→ [Quick Menu Customization: 490](#))
- My Menu (→ [My Menu: 503](#))

Import camera settings information onto another camera.

- [Save/Restore Camera Setting] (→ [\[Save/Restore Camera Setting\]: 505](#))

- Detailed settings for camera operations and screen display are available in the [Custom] menu. (→ [\[Custom\] Menu: 548](#))

Fn Buttons





- [Fn Button Default Settings: 472](#)
- [Register Functions to the Fn Buttons: 474](#)
- [Use the Fn Buttons: 485](#)

You can register functions to the Fn (Function) buttons. Additionally, you can register other functions to specialized buttons such as [WB] button, in the same way as with the Fn buttons.

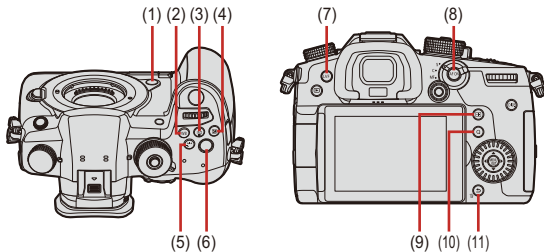
Different functions can be set for both during recording and playback.

Fn Button Default Settings



Fn buttons		[Setting in REC mode]	[Setting in PLAY mode]
(1)	[Fn2]	[Preview]	[No Setting]
(2)	[WB]	[White Balance]	[No Setting]
(3)	[ISO]	[Sensitivity]	[No Setting]
(4)	[]	[Exposure Comp.]	[No Setting]
(5)	[]	[Photo Style]	[No Setting]
(6)	Video rec. button	[Video Record]	[Video Record]
(7)	[LVF]	[LVF/Monitor Switch]	[LVF/Monitor Switch]
(8)	[AF ON]	[AF-ON]	[Rating★3]
(9)	[]	[AF Mode]	[Card Slot Change]
(10)	[Q]	[Q.MENU]	[Send Image (Smartphone)]
(11)	[Fn1]/[]/[]	[Level Gauge]	<ul style="list-style-type: none"> • Cannot be used as Fn buttons during playback.

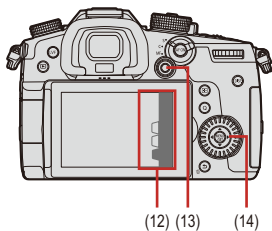

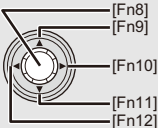
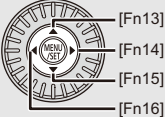

Fn buttons	[Setting in REC mode]	[Setting in PLAY mode]
(12) [Fn3]	[Wi-Fi]	<ul style="list-style-type: none"> • Cannot be used as Fn buttons during playback.
[Fn4]	[Histogram]	
[Fn5]	[Boost I.S. (Video)]	
[Fn6]	[Off (Disable Press and Hold)]	
[Fn7]	[Off (Disable Press and Hold)]	
(13) 	[No Setting]	
(14) 	[No Setting]	

Register Functions to the Fn Buttons







- With default settings, [Fn8] to [Fn12] on the joystick cannot be used.
When using functions, set the [Joystick Setting] in the [Custom] ([Operation]) menu to [Fn]. (→[Joystick Setting]: 563)

1 Select [Fn Button Set].

-  → [] → [] → [Fn Button Set] → [Setting in REC mode]/
[Setting in PLAY mode]







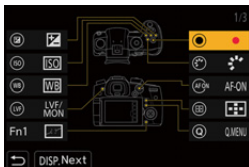



2 Select the button.

- Press   to select the button and then press  or .
- Selection is also possible by rotating  or .
- Press [DISP.] to change the page.









3 Find the function to register.

- Rotate  to select the sub tab where the function to register is categorized (→ [Setting Items \(\[Fn Button Set\]/\[Setting in REC mode\]\): 477](#), [Setting Items \(\[Fn Button Set\]/\[Setting in PLAY mode\]\): 483](#)) and then press  or .
- You can also select by pressing  to select the sub tab, pressing   or rotating , and then pressing .
- Each press of [Q] switches between tabs [1] and [3].



4 Register the function.

- Press   to select a function and then press  or .
- Selection is also possible by rotating  or .
- Select items with [>] by selecting the item again.
- Depending on the button, some functions cannot be registered.

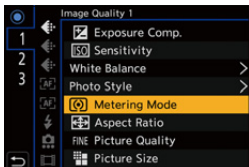

- You can also touch [Fn] on the control panel (→ [Recording Screen: 88](#)) to display the screen in Step **2**.
- You can also press and hold the Fn button (2 sec.) to display the screen in Step **4**.
(This may not be displayed depending on the registered function and on the button type.)

❖ Setting Items ([Fn Button Set]/[Setting in REC mode])

[1] tab

[Image Quality]

- [Exposure Comp.] (→ [Exposure Compensation: 269](#))
- [Sensitivity] (→ [ISO Sensitivity: 273](#))
- [White Balance] (→ [White Balance \(WB\): 278](#))
- [Photo Style] (→ [Photo Style: 285](#))
- [Metering Mode] (→ [Metering Mode: 252](#))
- [Aspect Ratio] (→ [Aspect Ratio: 114](#))
- [Picture Quality] (→ [Picture Quality: 116](#))
- [Picture Size] (→ [Picture Size: 115](#))
- [1 Shot Spot Metering]
 - Records with the metering mode set to [] (Spot metering) once only.
- [Long Exposure NR] (→ [Long Exposure NR: 519](#))
- [Min. Shutter Speed] (→ [Min. Shutter Speed: 520](#))
- [1 Shot RAW+JPG]
 - Records a RAW image and a JPEG image simultaneously once only.
- [i.Dynamic Range] (→ [i.Dynamic Range: 536](#))
- [Filter Effect] (→ [Filter Settings: 293](#))
- [One Push AE]
 - Adjusts the aperture value and shutter speed to the settings suited for the correct exposure determined by the camera.
- [Touch AE] (→ [Touch AE: 111](#))
- [Exposure Mode] (→ [Creative Video Mode: 330](#))
- [Synchro Scan] (→ [Synchro Scan: 410](#))

[Focus/Shutter]

- [AF Mode] (→ [Selecting the AF Mode: 135](#))
- [AF Custom Setting(Photo)] (→ [\[AF Custom Setting\(Photo\)\]: 132](#))
- [AF Custom Setting(Video)] (→ [\[AF Custom Setting\(Video\)\]: 355](#))
- [Focus Peaking] (→ [\[Focus Peaking\]: 541](#))
- [Focus Peaking Sensitivity] (→ [\[Focus Peaking\]: 541](#))
- [1-Area AF Moving Speed] (→ [\[1-Area AF Moving Speed\]: 541](#))
- [Focus Ring Lock] (→ [\[Focus Ring Lock\]: 555](#))
- [AE LOCK] (→ [Locking Focus and Exposure \(AF/AE Lock\): 271](#))
- [AF LOCK] (→ [Locking Focus and Exposure \(AF/AE Lock\): 271](#))
- [AF/AE LOCK] (→ [Locking Focus and Exposure \(AF/AE Lock\): 271](#))
- [AF-ON]
 - AF works.
- [AF-ON : Near Shift]
 - AF operates giving priority to close-up subjects.
- [AF-ON : Far Shift]
 - AF operates giving priority to distant subjects.
- [AF-Point Scope] (→ [Magnify the AF Area Position \(\[AF-Point Scope\]\): 131](#))
- [Focus Area Set]
 - Displays the AF area/MF Assist transition screen.

[Flash]

- [Flash Mode] (→ [\[Flash Mode\]: 309](#))
- [Flash Adjust.] (→ [\[Flash Adjust.\]: 313](#))
- [Wireless Flash Setup] (→ [Recording Using a Wireless Flash: 317](#))

[Others (Photo)]

- [Drive Mode Setting] (→ [Selecting the Drive Mode: 182](#))
- [1 Shot "6K/4K PHOTO"]
 - Performs 6K/4K photo recording only once.
- [Bracketing] (→ [Bracket Recording: 231](#))
- [Silent Mode] (→ [\[Silent Mode\]: 239](#))
- [Image Stabilizer] (→ [Image Stabilizer: 243](#))
- [Shutter Type] (→ [\[Shutter Type\]: 240](#))
- [Ex. Tele Conv.] (→ [Extended Tele Conversion: 176](#))

[Image Format]

- [Rec. File Format] (→ [\[Rec. File Format\]: 337](#))
- [Rec Quality] (→ [\[Rec Quality\]: 338](#))
- [Rec Quality (My List)] (→ [\[add to list\]: 346](#))
- [Variable Frame Rate] (→ [\[Variable Frame Rate\]: 382](#))
- [Time Code Display] (→ [Setting the Time Code: 350](#))

[2] tab

[Audio]

- [Sound Rec Level Disp.] (→ [\[Sound Rec Level Disp.\]: 364](#))
- [Mute Sound Input] (→ [\[Mute Sound Input\]: 365](#))
- [Sound Rec Level Adj.] (→ [\[Sound Rec Level Adj.\]: 366](#))
- [Sound Rec Level Limiter] (→ [\[Sound Rec Level Limiter\]: 366](#))
- [XLR Mic Adaptor Setting] (→ [XLR Microphone Adaptor \(Optional\): 439](#))
- [Special Mic. Directivity Adjust]
 - Sets the sound pickup range for [MANUAL] in [Special Mic.]. (→ [Setting the Sound Pickup Range \(DMW-MS2: Optional\): 437](#))

[Others (Video)]

- [Image Stabilizer] (→ [Image Stabilizer: 243](#))
- [E-Stabilization (Video)] (→ [E-Stabilization \(Video\): 246](#))
- [Boost I.S. (Video)] (→ [Boost I.S. \(Video\): 246](#))
- [Image Area of Video] (→ [Image Area of Video: 348](#))
- [Focus Transition] (→ [Focus Transition: 386](#))
- [Live Cropping] (→ [Live Cropping: 390](#))

[Operation]

- [Q.MENU] (→ [Quick Menu: 91](#))
- [Rec / Playback Switch]
 - Switches to the playback screen.
- [Video Record] (→ [Recording Videos: 325](#))
- [LVF/Monitor Switch] (→ [Eye Sensor: 587](#))
- [Operation Lock]
 - A certain type of operation is disabled. Set the type of operation to be disabled in [\[Operation Lock Setup\]](#) (→ [Operation Lock Setup: 560](#)).
- [Dial Operation Switch] (→ [Temporarily Change Dial Operation: 489](#))

[Monitor / Display]

- [Preview] (→ [Preview Mode: 267](#))
- [Preview Aperture Effect]
 - The aperture effect can be previewed while the Fn button is being pressed.
- [Constant Preview] (→ [Constant Preview: 565](#))
- [Level Gauge] (→ [Level Gauge: 573](#))
- [Histogram] (→ [Histogram: 566](#))
- [Luminance Spot Meter] (→ [Luminance Spot Meter: 573](#))
- [Frame Marker] (→ [Frame Marker: 379](#))
- [Photo Grid Line] (→ [Photo Grid Line: 567](#))
- [Live View Boost] (→ [Live View Boost: 568](#))
- [Monochrome Live View] (→ [Monochrome Live View: 576](#))
- [Night Mode] (→ [Night Mode: 569](#))
- [LVF/Monitor Disp. Set]
 - Switches the displayed monitor or viewfinder display style.
- [Video-Priority Display] (→ [Video-Priority Display: 577](#))
- [Zebra Pattern] (→ [Zebra Pattern: 377](#))
- [LUT View Assist (Monitor)] (→ [V-LogL View Assist: 398](#))
- [LUT View Assist (HDMI)] (→ [V-LogL View Assist: 398](#))
- [LUT Select] (→ [V-LogL View Assist: 398](#))
- [HLG View Assist (Monitor)] (→ [HLG View Assist: 404](#))
- [HLG View Assist (HDMI)] (→ [HLG View Assist: 404](#))
- [Sheer Overlay] (→ [Sheer Overlay: 572](#))
- [I.S. Status Scope] (→ [I.S. Status Scope: 572](#))
- [WFM/Vector Scope] (→ [WFM/Vector Scope: 577](#))
- [Anamorphic Desqueeze Display] (→ [Anamorphic Desqueeze Display: 407](#))
- [Color Bars] (→ [Color bars/Test Tone: 380](#))

[Lens / Others]

- [Focus Ring Control] (→ [\[Focus Ring Control\]: 581](#))
- [Zoom Control]
 - You can operate zoom when using an interchangeable lens that supports the power zoom.
- [Step Zoom] (→ [\[Power Zoom Lens\]: 180](#))
- [Zoom Speed] (→ [\[Power Zoom Lens\]: 180](#))
- [Lens Information] (→ [\[Lens Information\]: 249](#))

[Card/File]

- [Destination Card Slot]
 - Changes the priority of cards for recording. This can be used if [\[Double Card Slot Function\]](#) (→ [\[Double Card Slot Function\]: 118](#)) is set to [\[Relay Rec\]](#).

[3] tab

[IN/OUT]

- [Wi-Fi] (→ [15. Wi-Fi/Bluetooth: 610](#))

[Others]

- [No Setting]
 - Set when not using as an Fn button.
- [Off (Disable Press and Hold)]
 - The button does not work as an Fn button. The function registering screen is not displayed when you press and hold (2 seconds) the Fn button.
- [Restore to Default]
 - Restore the default settings for the Fn button. (→ [Fn Button Default Settings: 472](#))

❖ Setting Items ([Fn Button Set]/[Setting in PLAY mode])

[1] tab

[Playback Mode]

- [Magnify from AF Point] (→ [\[Magnify from AF Point\]: 600](#))
- [LUT View Assist (Monitor)] (→ [\[V-LogL View Assist\]: 398](#))
- [HLG View Assist (Monitor)] (→ [\[HLG View Assist\]: 404](#))
- [Anamorphic Desqueeze Display] (→ [\[Anamorphic Desqueeze Display\]: 407](#))

[Process Image]

- [RAW Processing] (→ [\[RAW Processing\]: 460](#))
- [6K/4K PHOTO Bulk Saving] (→ [\[6K/4K PHOTO Bulk Saving\]: 206](#))

[Add/Delete Info.]

- [Delete Single] (→ [\[Deleting Images\]: 458](#))
- [Protect] (→ [\[Protect\]: 604](#))
- [Rating★1] (→ [\[Rating\]: 604](#))
- [Rating★2] (→ [\[Rating\]: 604](#))
- [Rating★3] (→ [\[Rating\]: 604](#))
- [Rating★4] (→ [\[Rating\]: 604](#))
- [Rating★5] (→ [\[Rating\]: 604](#))

[Edit Image]

- [Copy] (→ [\[Copy\]: 607](#))

[Operation]

- [Rec / Playback Switch]
 - Switches to the recording screen.
- [LVF/Monitor Switch]
- [Video Record] (→ [\[Recording Videos\]: 325](#))

[Monitor / Display]

- [Night Mode] (→ [\[Night Mode\]: 569](#))

[Card/File]

- [Card Slot Change] (→ [Switching the Card to Display: 445](#))

[IN/OUT]

- [Wi-Fi] (→ [15. Wi-Fi/Bluetooth: 610](#))
- [Send Image (Smartphone)] (→ [Sending Images on the Camera to a Smartphone with Simple Operations: 653](#))
- [LUT View Assist (HDMI)] (→ [\[V-LogL View Assist\]: 398](#))
- [HLG View Assist (HDMI)] (→ [\[HLG View Assist\]: 404](#))

[2] tab

[Others]





- [6K/4K Photo Play]
 - Displays the screen to select pictures to save from a 6K/4K burst file.
- [No Setting]
 - Set when not using as an Fn button.
- [Off (Disable Press and Hold)]
 - The button does not work as an Fn button. The function registering screen is not displayed when you press and hold (2 seconds) the Fn button.
- [Restore to Default]
 - Restore the default settings for the Fn button. (→ [Fn Button Default Settings: 472](#))

Use the Fn Buttons

During recording, pressing the Fn buttons enables usage of the functions registered in [Setting in REC mode], and during playback, it enables usage of the functions registered in [Setting in PLAY mode].

1 Press the Fn button.

2 Select a setting item.

- Press ◀▶ to select a setting item and then press  or .
- Selection is also possible by rotating ,  or .
- Display and selection methods of a setting item differ depending on the menu item.

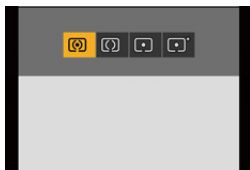

❖ Use [Fn3] to [Fn7] (Touch Icons)

During recording, you can use the Fn buttons within the Touch Tab.



- With the default settings, the Touch Tab is not displayed. Set [Touch Tab] to [ON] in [Touch Settings] in the [Custom] ([Operation]) menu. (→ [\[Touch Settings\]: 559](#))

- 1 Touch [Fn].
- 2 Touch one of [Fn3] to [Fn7].





[Dial Operation Switch]





- Register Functions to the Dials: 487
- Temporarily Change Dial Operation: 489

This temporarily changes the functions operated with  (front dial) and  (rear dial).

Register Functions to the Dials

Register functions to each of  and .

1 Select [Dial Operation Switch Setup].

-  → [] → [] → [Dial Set.] → [Dial Operation Switch Setup] → []/[]

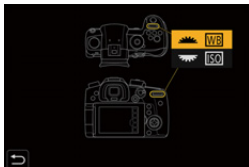

2 Register the function.

- Press   to select a function and then press  or .

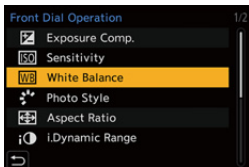

❖ Functions That Can Be Registered

- [Exposure Comp.] (→ [Exposure Compensation: 269](#))
- [Sensitivity]^{*1} (→ [ISO Sensitivity: 273](#))
- [White Balance]^{*2} (→ [White Balance \(WB\): 278](#))
- [Photo Style] (→ [\[Photo Style\]: 285](#))
- [Aspect Ratio] (→ [\[Aspect Ratio\]: 114](#))
- [i.Dynamic Range] (→ [\[i.Dynamic Range\]: 520](#))
- [Filter Effect] (→ [\[Filter Settings\]: 293](#))
- [AF Mode] (→ [Selecting the AF Mode: 135](#))
- [Flash Mode] (→ [\[Flash Mode\]: 309](#))
- [Flash Adjust.] (→ [\[Flash Adjust.\]: 313](#))

*1  default setting



*2  default setting

Temporarily Change Dial Operation

Use the Fn button to temporarily change dial operation.

1 Set [Dial Operation Switch] to the Fn button. (→Fn Buttons: 471)

2 Switch dial operation.

- Press the Fn button set in Step 1.
- A guide will display the functions registered to  and .
- If no operations are performed, then several seconds later, the guide disappears.

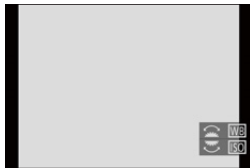

3 Set the registered function.

- Rotate  or  while the guide is displayed.

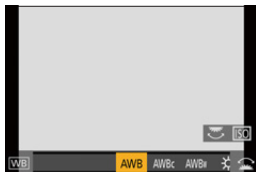

4 Confirm your selection.

- Press the shutter button halfway.

Quick Menu Customization

- [Register to the Quick Menu: 490](#)

You can change Quick menu items depending on the recording mode. Additionally, you can change the items to display on the Quick menu and their order to suit your preferences.



- For information about Quick menu operation methods (→ [Quick Menu: 91](#))

Register to the Quick Menu

Change the menus to be displayed in the Quick menu.



These can be set separately for [P/M] mode (Video) and for other recording modes (Photo).

1 Select [Q.MENU Settings].

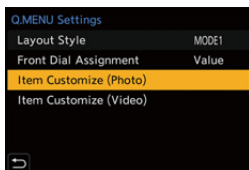
-  → [] → [] → [Q.MENU Settings] → [Item Customize (Photo)]/[Item Customize (Video)]





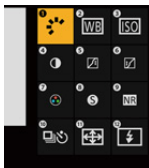

2 Select the item position (1 to 12).

- Press ▲▼◀▶ to select the position and then press  or .
- Selection is also possible by rotating .







3 Find the function to register.

- Rotate  to select the sub tab where the function to register is categorized (→ [Menu Items That Can Be Registered: 493](#)) and then press  or .
- You can also select by pressing ◀ to select the sub tab, pressing ▲▼ or rotating , and then pressing ▶.
- Each press of [Q] switches between tabs [1] and [2].



4 Register menu items.

- Press ▲▼ to select an item and then press  or .
- Selection is also possible by rotating  or .
- Select items with [>] by selecting the item again.



❖ Menu Items That Can Be Registered

[1] tab

[Image Quality]

- [Exposure Comp.] (→ [Exposure Compensation: 269](#))
- [Sensitivity] (→ [ISO Sensitivity: 273](#))
- [White Balance] (→ [White Balance \(WB\): 278](#))
- [Photo Style] (→ [Photo Style: 285](#))
- [Metering Mode] (→ [Metering Mode: 252](#))
- [Aspect Ratio] (→ [Aspect Ratio: 114](#))
- [Picture Quality] (→ [Picture Quality: 116](#))
- [Picture Size] (→ [Picture Size: 115](#))
- [Long Exposure NR] (→ [Long Exposure NR: 519](#))
- [Min. Shutter Speed] (→ [Min. Shutter Speed: 520](#))
- [i.Dynamic Range] (→ [i.Dynamic Range: 536](#))
- [Filter Effect] (→ [Filter Settings: 293](#))
- [Exposure Mode] (→ [Creative Video Mode: 330](#))
- [Synchro Scan] (→ [Synchro Scan: 410](#))

[Focus/Shutter]

- [AF Mode] (→ [Selecting the AF Mode: 135](#))
- [AF Custom Setting(Photo)] (→ [AF Custom Setting\(Photo\): 132](#))
- [AF Custom Setting(Video)] (→ [AF Custom Setting\(Video\): 355](#))
- [Focus Peaking] (→ [Focus Peaking: 541](#))
- [Focus Peaking Sensitivity] (→ [Focus Peaking: 541](#))
- [1-Area AF Moving Speed] (→ [1-Area AF Moving Speed: 541](#))

[Flash]

- [Flash Mode] (→ [\[Flash Mode\]: 309](#))
- [Flash Adjust.] (→ [\[Flash Adjust.\]: 313](#))
- [Wireless Flash Setup] (→ [Recording Using a Wireless Flash: 317](#))

[Others (Photo)]

- [Drive Mode Setting] (→ [Selecting the Drive Mode: 182](#))
- [Bracketing] (→ [Bracket Recording: 231](#))
- [Silent Mode] (→ [\[Silent Mode\]: 239](#))
- [Image Stabilizer] (→ [Image Stabilizer: 243](#))
- [Shutter Type] (→ [\[Shutter Type\]: 240](#))
- [Ex. Tele Conv.] (→ [Extended Tele Conversion: 176](#))

[Image Format]

- [Rec. File Format] (→ [\[Rec. File Format\]: 337](#))
- [Rec Quality] (→ [\[Rec Quality\]: 338](#))
- [Rec Quality (My List)] (→ [\[add to list\]: 346](#))
- [Variable Frame Rate] (→ [\[Variable Frame Rate\]: 382](#))
- [Time Code Display] (→ [Setting the Time Code: 350](#))

[Audio]

- [Sound Rec Level Disp.] (→ [\[Sound Rec Level Disp.\]: 364](#))
- [Sound Rec Level Adj.] (→ [\[Sound Rec Level Adj.\]: 366](#))
- [Sound Rec Level Limiter] (→ [\[Sound Rec Level Limiter\]: 366](#))
- [XLR Mic Adaptor Setting] (→ [XLR Microphone Adaptor \(Optional\): 439](#))
- [Special Mic. Directivity Adjust]
 - Sets the sound pickup range for [MANUAL] in [Special Mic.]. (→ [Setting the Sound Pickup Range \(DMW-MS2: Optional\): 437](#))

 **[Others (Video)]**

- [Image Stabilizer] (→[Image Stabilizer: 243])
- [E-Stabilization (Video)] (→[E-Stabilization (Video)]: 246)
- [Boost I.S. (Video)] (→[Boost I.S. (Video)]: 246)
- [Image Area of Video] (→[Image Area of Video]: 348)
- [Focus Transition] (→[Focus Transition]: 386)
- [Live Cropping] (→[Live Cropping]: 390)

[2] tab **[Monitor / Display]**

- [Constant Preview] (→[Constant Preview]: 565)
- [Level Gauge] (→[Level Gauge]: 573)
- [Histogram] (→[Histogram]: 566)
- [Luminance Spot Meter] (→[Luminance Spot Meter]: 573)
- [Frame Marker] (→[Frame Marker]: 379)
- [Photo Grid Line] (→[Photo Grid Line]: 567)
- [Live View Boost] (→[Live View Boost]: 568)
- [Monochrome Live View] (→[Monochrome Live View]: 576)
- [Night Mode] (→[Night Mode]: 569)
- [LVF/Monitor Disp. Set]
 - Switches the displayed monitor or viewfinder display style.
- [Video-Priority Display] (→[Video-Priority Display]: 577)
- [Zebra Pattern] (→[Zebra Pattern]: 377)
- [LUT View Assist (Monitor)] (→[V-LogL View Assist]: 398)
- [LUT View Assist (HDMI)] (→[V-LogL View Assist]: 398)
- [HLG View Assist (Monitor)] (→[HLG View Assist]: 404)
- [HLG View Assist (HDMI)] (→[HLG View Assist]: 404)
- [Sheer Overlay] (→[Sheer Overlay]: 572)
- [I.S. Status Scope] (→[I.S. Status Scope]: 572)
- [WFM/Vector Scope] (→[WFM/Vector Scope]: 577)
- [Anamorphic Desqueeze Display] (→[Anamorphic Desqueeze Display]: 407)
- [Color Bars] (→[Color bars/Test Tone]: 380)

[Lens / Others]

- [Focus Ring Control] (→ [Focus Ring Control]: 581)
- [Step Zoom] (→ [Power Zoom Lens]: 180)
- [Zoom Speed] (→ [Power Zoom Lens]: 180)
- [Lens Information] (→ [Lens Information]: 249)

[Card/File]

- [Destination Card Slot]
 - Changes the priority of cards for recording. This can be used if [Double Card Slot Function] (→ [Double Card Slot Function]: 118) is set to [Relay Rec].

[IN/OUT]



- [Wi-Fi] (→ 15. Wi-Fi/Bluetooth: 610)

[Others]

- [No Setting]
 - Set when not using.

❖ Quick Menu Detailed Settings

Change the appearance of the Quick menu and the operation of  during menu display.

 ⇒ [] ⇒ [] ⇒ Select [Q.MENU Settings]

[Layout Style]	<p>Changes the appearance of the Quick menu.</p> <p>[MODE1]: Displays the live view and the menu simultaneously.</p> <p>[MODE2]: Displays the menu in full screen.</p>
[Front Dial Assignment]	<p>Changes the operation of  in the Quick menu.</p> <p>[Item]: Selects menu items.</p> <p>[Value]: Selects setting values.</p>
[Item Customize (Photo)]	<p>Customizes the Quick menu to display when the mode dial is set to [iA]/[P]/[A]/[S]/[M].</p>
[Item Customize (Video)]	<p>Customizes the Quick menu to display when the mode dial is set to [v] [M].</p>

Custom Mode

- Register in Custom Mode: 498
- Using Custom Mode: 501
- Calling Up Settings: 502



Recording modes and menu settings that match your preferences can be registered in Custom mode. You can use registered settings by switching the mode dial to [C1] to [C4] modes.

Register in Custom Mode

You can register the currently set information of the camera.



At the time of purchase, the default settings of the [P] mode menus are registered with all Custom modes.

- 1 **Set menu settings of the state you wish to save.**
- 2 **Select [Save to Custom Mode].**

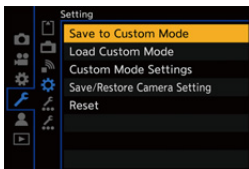
-  → [] → [] → [Save to Custom Mode]



3 Register.

- Select the save-to number and then press  or .
- A confirmation screen will be displayed. Press [DISP.] to change the Custom mode name.

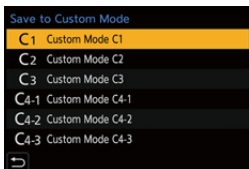

How to enter characters (→ [Entering Characters: 609](#))



- You cannot register [iA] mode in Custom mode.
- List of settings that can be registered in Custom mode (→ [List of Default Settings/Custom Saving/Settings Available for Copying: 771](#))

❖ Custom Mode Detailed Settings

You can create additional Custom mode sets, and how long to retain temporarily changed settings details.

 ⇒ [] ⇒ [] ⇒ Select [Custom Mode Settings]

[Limit No. of Custom Mode]	Sets the number of Custom modes that can be registered in [C4]. A maximum of 10 sets can be registered; 3 sets are available as default settings.
[Edit Title]	Changes the Custom mode name. A maximum of 22 characters can be entered. A two-byte character is treated as two characters. • How to enter characters (→ Entering Characters: 609)
[How to Reload Custom Mode]	Sets the timing at which to return the settings that were changed temporarily while the Custom mode was being used to their registered settings. [Change Recording Mode]/[Return from Sleep Mode]/[Turn the Power ON]
[Select Loading Details]	Sets the types of settings to call up with [Load Custom Mode]. [F / SS / ISO Sensitivity]: Enables calling up of aperture value, shutter speed, and ISO sensitivity settings. [White Balance]: Enables calling up of white balance settings.



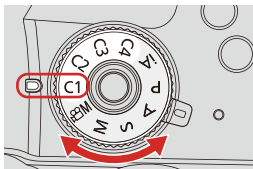

Using Custom Mode

1 Set the mode dial to one of [C1] to [C4].

- If [C4], the last-used Custom mode will be called up.



❖ [C4] Custom Mode Selection

- 1 Set the mode dial to [C4].
 - 2 Press .
 - 3 Press   to select the Custom mode and then press  or .
- The selected Custom mode icon will be displayed on the recording screen.



❖ Changing Registered Details

Registered settings do not change even if you change the camera settings temporarily with the mode dial set to [C1] to [C4].

To change the registered details, overwrite them by using [Save to Custom Mode] in the [Setup] ([Setting]) menu.

Calling Up Settings

Call up registered Custom mode settings to the selected recording mode and overwrite the current settings with the called up settings.



1 Set to the mode dial to use.

2 Select [Load Custom Mode].

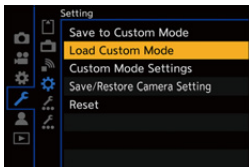
-  → [] → [] → [Load Custom Mode]



3 Select the Custom mode to call up.

- Select the Custom mode and then press  or .

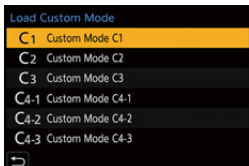



- Calling up of Custom modes is not possible between those created from [P]/[A]/[S]/[M] modes and those created from [] mode.

My Menu

- [Registration in My Menu: 503](#)
- [Edit My Menu: 504](#)

Register frequently-used menus in My Menu.

A maximum of 23 items can be registered.

Registered menus can be called up from [] to [].



Registration in My Menu

1 Select [Add].

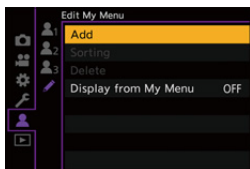
-  → [] → [] → [Add]



2 Register.

- Select the menu to register and then press  or .



❖ Calling up My Menu

Call up the menus registered in My Menu.

 ⇒ [] ⇒ []/[]/[] ⇒ Registered menus

Edit My Menu

You can reorder the display order of My Menu, and delete unnecessary menus.

 ⇒ [] ⇒ **Select** []

[Add]	Selects and registers the menus to be displayed in My Menu.
[Sorting]	Changes the order of My Menu. Select the menu to change, then set the destination.
[Delete]	Deletes menus that are registered to My Menu. [Delete Item]: Selects the menu, then deletes. [Delete All]: Deletes all menus registered in My Menu.
[Display from My Menu]	Displays My Menu first when displaying a menu. [ON]: Displays My Menu. [OFF]: Displays the last-used menu.

[Save/Restore Camera Setting]

Saves the camera's settings information to the card.

Saved settings information can be loaded to the camera, letting you set the same settings on multiple cameras.

 → [] → [] → **Select [Save/Restore Camera Setting]**

[Save]	<p>Saves the camera's settings information to the card.</p> <ul style="list-style-type: none"> • If saving new data, then select [New File], and if overwriting an existing file, select that existing file. • When [New File] is selected, a screen to select the file name to save as is displayed. <p>[OK]: Saves using the file name on the screen.</p> <p>[Change the file name]: Changes the file name and saves the file.</p> <ul style="list-style-type: none"> • Available characters: alphabetic characters (upper-case), numerals, up to 8 characters • How to enter characters (→ Entering Characters: 609)
[Load]	<p>Loads the settings information on the card and copies it to the camera.</p>
[Delete]	<p>Deletes settings information on the card.</p>
[Keep Settings While Format]	<p>When formatting the card, formats the card while keeping camera settings information stored on the card.</p>

- Only settings information from the same model can be loaded.
- Up to 10 instances of settings information can be saved on one card.
- List of functions for which saving of settings information is possible (→ [List of Default Settings/Custom Saving/Settings Available for Copying: 771](#))

14. Menu Guide

- [List of Menu: 508](#)
- [\[Photo\] Menu: 518](#)
- [\[Video\] Menu: 534](#)
- [\[Custom\] Menu: 548](#)
- [\[Setup\] Menu: 583](#)
- [\[Playback\] Menu: 597](#)
- [Entering Characters: 609](#)

This chapter provides a list of menus and describes them in detail.

- For information about menu operation methods (➔ [Menu Operation Methods: 95](#))
- Refer to the “18. Materials” chapter for the following list:
 - [List of Default Settings/Custom Saving/Settings Available for Copying: 771](#)
 - [List of Functions That Can Be Set in Each Recording Mode: 790](#)

List of Menu



: Menu items common to the [Photo] menu and [Video] menu. Their settings are synchronized.

[Photo] menu

[Image Quality] (→ [Photo] menu ([Image Quality]): 518)

- [Photo Style]: 518 
- [Metering Mode]: 518 
- [Aspect Ratio]: 519
- [Picture Quality]: 519
- [Picture Size]: 519
- [Long Exposure NR]: 519
- [ISO Sensitivity (photo)]: 520
- [Min. Shutter Speed]: 520
- [i.Dynamic Range]: 520 
- [Vignetting Comp.]: 521 
- [Diffraction Compensation]: 521 
- [Filter Settings]: 522 

[Focus] (→ [Photo] menu ([Focus]): 523)

- [AF Custom Setting(Photo)]: 523
- [AF Assist Light]: 523 
- [Focus Peaking]: 524 
- [1-Area AF Moving Speed]: 524 

 **[Flash] (→[Photo] menu ([Flash]): 525)**

- [Flash Mode]: 525
- [Firing Mode]: 525
- [Flash Adjust.]: 525
- [Flash Synchro]: 525
- [Manual Flash Adjust.]: 526
- [Auto Exposure Comp.]: 526
- [Wireless]: 526
- [Wireless Channel]: 526
- [Wireless FP]: 527
- [Communication Light]: 527
- [Wireless Setup]: 527

 **[Others (Photo)] (→[Photo] menu ([Others (Photo)]): 528)**

- [Bracketing]: 528
- [Silent Mode]: 528 
- [Image Stabilizer]: 528 
- [Burst Rate]: 529
- [Shutter Type]: 529
- [Shutter Delay]: 529
- [Ex. Tele Conv.]: 530
- [Time Lapse/Animation]: 530
- [Self Timer]: 530 
- [6K/4K PHOTO]: 531
- [Post-Focus]: 531
- [Multiple Exposure]: 531
- [Time Stamp Rec.]: 533 

[Video] menu







[Image Quality] (→[Video] menu ([Image Quality]): 534)

- [Exposure Mode]: 534
- [Photo Style]: 534  
- [Metering Mode]: 535  
- [ISO Sensitivity (video)]: 535
- [Synchro Scan]: 535
- [Flicker Decrease (Video)]: 535
- [Master Pedestal Level]: 536
- [SS/Gain Operation]: 536
- [i.Dynamic Range]: 536  
- [Vignetting Comp.]: 536  
- [Diffraction Compensation]: 537  
- [Filter Settings]: 537  

[Image Format] (→[Video] menu ([Image Format]): 538)

- [Rec. File Format]: 538
- [Image Area of Video]: 538
- [Rec Quality]: 538
- [Rec Quality (My List)]: 538
- [Variable Frame Rate]: 538
- [Time Code]: 539
- [Luminance Level]: 539

[Focus] (→[Video] menu ([Focus]): 540)

- [AF Custom Setting(Video)]: 540
- [Continuous AF]: 540
- [AF Assist Light]: 540  
- [Focus Peaking]: 541  
- [1-Area AF Moving Speed]: 541  

 **[Audio] (→[Video] menu ([Audio]): 542)**

- [Sound Rec Level Disp.]: 542
- [Mute Sound Input]: 542
- [Sound Rec Gain Level]: 542
- [Sound Rec Level Adj.]: 542
- [Sound Rec Level Limiter]: 543
- [Wind Noise Canceller]: 543 / [Wind Cut]: 543
- [Lens Noise Cut]: 543
- [Special Mic.]: 543
- [XLR Mic Adaptor Setting]: 544
- [Sound Output]: 544
- [Headphone Volume]: 544

 **[Others (Video)] (→[Video] menu ([Others (Video)]): 545)**

- [Silent Mode]: 545 
- [Image Stabilizer]: 545 
- [Self Timer Setting]: 545 
- [Focus Transition]: 546
- [Loop Recording (video)]: 546
- [Segmented File Recording]: 546
- [Live Cropping]: 547
- [Time Stamp Rec.]: 547 

[Custom] menu

[Image Quality] (→ [Custom] menu ([Image Quality]): 549)

- [Photo Style Settings]: 549
- [ISO Increments]: 549
- [Extended ISO]: 550
- [Exposure Offset Adjust.]: 550
- [Color Space]: 551
- [Exposure Comp. Reset]: 551
- [Auto Exposure in P/A/S/M]: 551
- [CreativeVideo Combined Set.]: 552

[Focus/Shutter] (→ [Custom] menu ([Focus/Shutter]): 553)

- [Focus/Shutter Priority]: 553
- [Focus Switching for Vert / Hor]: 553
- [AF/AE Lock Hold]: 553
- [AF+MF]: 554
- [MF Assist]: 554
- [MF Guide]: 555
- [Focus Ring Lock]: 555
- [Show/Hide AF Mode]: 555
- [Pinpoint AF Setting]: 556
- [AF-Point Scope Setting]: 556
- [Shutter AF]: 556
- [Half-Press Shutter]: 556
- [Assign REC to Shutter Button]: 557
- [Quick AF]: 557
- [Eye Sensor AF]: 557
- [Looped Focus Frame]: 557
- [AFC Start Point (225-Area)]: 558

 **[Operation] (→[Custom] menu ([Operation]): 559)**

- [Q.MENU Settings]: 559
- [Touch Settings]: 559
- [Operation Lock Setup]: 560
- [Fn Button Set]: 560
- [WB/ISO/Expo. Button]: 561
- [ISO Displayed Setting]: 561
- [Exposure Comp. Disp. Setting]: 561
- [Dial Set.]: 562
- [Joystick Setting]: 563
- [Video Rec. Button (Remote)]: 563

 **[Monitor / Display (Photo)] (→[Custom] menu ([Monitor / Display (Photo)]: 564)**

- [Auto Review]: 564
- [Constant Preview]: 565
- [Histogram]: 566
- [Photo Grid Line]: 567
- [AF Area Display]: 567
- [Live View Boost]: 568
- [Night Mode]: 569
- [LVF/Monitor Disp. Set]: 570
- [Expo.Meter]: 571
- [Focal Length]: 571
- [Blinking Highlights]: 571
- [Sheer Overlay]: 572
- [I.S. Status Scope]: 572
- [Level Gauge]: 573
- [Luminance Spot Meter]: 573
- [Framing Outline]: 573
- [Show/Hide Monitor Layout]: 574

 **[Monitor / Display (Video)] (→[Custom] menu ([Monitor / Display (Video)]): 575)**

- [V-LogL View Assist]: 575
- [HLG View Assist]: 575
- [Anamorphic Desqueeze Display]: 575
- [Monochrome Live View]: 576
- [Center Marker]: 576
- [Frame Marker]: 576
- [Zebra Pattern]: 576
- [WFM/Vector Scope]: 577
- [Color Bars]: 577
- [Video-Priority Display]: 577
- [Red REC Frame Indicator]: 578
- [Streaming Blue Frame Indicator]: 578

 **[IN/OUT] (→[Custom] menu ([IN/OUT]): 579)**

- [HDMI Rec Output]: 579

 **[Lens / Others] (→[Custom] menu ([Lens / Others]): 580)**

- [Lens Focus Resume]: 580
- [Power Zoom Lens]: 580
- [Lens Fn Button Setting]: 580
- [Aperture Ring Increment]: 581
- [Focus Ring Control]: 581
- [Lens Information]: 582
- [Lens Info. Confirmation]: 582
- [Vertical Position Info (Video)]: 582

[Setup] menu

[Card/File] (→[Setup] menu ([Card/File]): 583)

- [Card Format]: 583
- [Double Card Slot Function]: 583
- [Folder / File Settings]: 583
- [File Number Reset]: 584
- [Copyright Information]: 584

[Monitor / Display] (→[Setup] menu ([Monitor / Display]): 585)

- [Power Save Mode]: 585
- [Monitor Frame Rate]: 585
- [LVF Frame Rate]: 586
- [Monitor Settings]/[Viewfinder]: 586
- [Monitor Backlight]/[LVF Luminance]: 587
- [Eye Sensor]: 587
- [Level Gauge Adjust.]: 587

[IN/OUT] (→[Setup] menu ([IN/OUT]): 588)

- [Beep]: 588
- [Headphone Volume]: 588
- [Wi-Fi]: 588
- [Bluetooth]: 589
- [USB]: 589
- [Battery Use Priority]: 590
- [HDMI Connection]: 590
- [Power/Network Indicator]: 591

 **[Setting] (→[Setup] menu ([Setting]): 592)**

- [Save to Custom Mode]: 592
- [Load Custom Mode]: 592
- [Custom Mode Settings]: 592
- [Save/Restore Camera Setting]: 593
- [Reset]: 593

 **[Others] (→[Setup] menu ([Others]): 594)**

- [Clock Set]: 594
- [Time Zone]: 594
- [System Frequency]: 595
- [Pixel Refresh]: 595
- [Sensor Cleaning]: 595
- [Language]: 596
- [Firmware Version]: 596
- [Online Manual]: 596
- [Approved Regulations]: 596

[My Menu]

 **[Page 1] (→My Menu: 503)**

 **[Page 2] (→My Menu: 503)**

 **[Page 3] (→My Menu: 503)**

 **[Edit My Menu] (→Edit My Menu: 504)**

- [Add]
- [Sorting]
- [Delete]
- [Display from My Menu]

[Playback] menu

[Playback Mode] (→[Playback] menu ([Playback Mode]): 599)

- [Playback Mode]: 599
- [Slide Show]: 599
- [Rotate Disp.]: 600
- [Picture Sort]: 600
- [Magnify from AF Point]: 600
- [LUT View Assist (Monitor)]: 600
- [HLG View Assist (Monitor)]: 601
- [Anamorphic Desqueeze Display]: 601

[Process Image] (→[Playback] menu ([Process Image]): 602)

- [RAW Processing]: 602
- [6K/4K PHOTO Bulk Saving]: 602
- [6K/4K PHOTO Noise Reduction]: 602
- [Time Lapse Video]: 603
- [Stop Motion Video]: 603

[Add/Delete Info.] (→[Playback] menu ([Add/Delete Info.]): 604)

- [Protect]: 604
- [Rating]: 604

[Edit Image] (→[Playback] menu ([Edit Image]): 605)

- [Resize]: 605
- [Rotate]: 606
- [Video Divide]: 606
- [Copy]: 607

[Others] (→[Playback] menu ([Others]): 608)

- [Delete Confirmation]: 608
- [Delete All Images]: 608

[Photo] Menu

- [Photo] menu ([Image Quality]): 518
- [Photo] menu ([Focus]): 523
- [Photo] menu ([Flash]): 525
- [Photo] menu ([Others (Photo)]): 528

: Menu items common to the [Photo] menu and [Video] menu. Their settings are synchronized.

[Photo] menu ([Image Quality])

▶: Default settings

[Photo Style]

▶[Standard] / [Vivid] / [Natural] / [L.ClassicNeo] / [Flat] / [Landscape] / [Portrait] / [Monochrome] / [L.Monochrome] / [L.Monochrome D] / [L.Monochrome S] / [Cinelike D2] / [Cinelike V2] / [Like709] / [V-Log L] / [MY PHOTO STYLE 1] to [MY PHOTO STYLE 10]

You can select the finishing settings of images to suit your subjects and expression styles.

(→ [\[Photo Style\]: 285](#))

[Metering Mode]

▶   

Type of optical measurement to measure brightness can be changed.

(→ [\[Metering Mode\]: 252](#))

[Aspect Ratio]

▶[4:3]/[3:2]/[16:9]/[1:1]

You can select the image aspect ratio.

(→[Aspect Ratio]: 114)

[Picture Quality]

▶[FINE]/[STD.]/[RAW+FINE]/[RAW+STD.]/[RAW]

Set the compression rate used for storing pictures.

(→[Picture Quality]: 116)

[Picture Size]

▶[L]/[M]/[S]

Sets the picture's image size.

(→[Picture Size]: 115)

[Long Exposure NR]

▶[ON]/[OFF]

iA P A S M 

The camera automatically removes noise generated when recording images with a slow shutter speed.

- Recording is not possible during noise reduction.
- When the following functions are being used, [Long Exposure NR] is not available:
 - Video recording/[6K/4K PHOTO]/[Post-Focus]
 - [ELEC.] (Excluding [ELEC.+NR])/[Silent Mode]

[ISO Sensitivity (photo)]

[ISO Auto Lower Limit Setting]	▶[200] to [12800]
[ISO Auto Upper Limit Setting]	▶[AUTO]/[400] to [25600]

iA P A S M 

Sets the lower and upper limits for ISO sensitivity when ISO sensitivity is set to [AUTO].

[Min. Shutter Speed]

▶[AUTO]/[1/16000] to [1/1]

iA P A S M 

Sets the minimum shutter speed when the ISO sensitivity is set to [AUTO].

- The shutter speed may become slower than the set value in recording situations where correct exposure cannot be achieved.

[i.Dynamic Range] 

[AUTO]/[HIGH]/[STANDARD]/[LOW]▶[OFF]

iA P A S M 

Contrast and exposure are compensated when the brightness difference between the background and subject is great.

- Compensation effect may not be achieved depending on the recording conditions.
- When the following functions are being used, [i.Dynamic Range] is not available:
 - [Like709]/[V-Log L]/[Hybrid Log Gamma] ([Photo Style])
 - [Filter Settings]

[Vignetting Comp.]  

[ON]▶[OFF]

iA P A S M  M

When the screen periphery darkens as a result of the lens characteristics, you can record pictures with the brightness of the screen periphery corrected.

- Compensation effect may not be achieved depending on the recording conditions.
- Noise in the periphery of the picture may stand out with higher ISO sensitivity.
- When the following function is being used, [Vignetting Comp.] is not available:
 - [Ex. Tele Conv.]
 - [PIXEL/PIXEL] ([Image Area of Video])
 - [Variable Frame Rate]

[Diffraction Compensation]  

[AUTO]▶[OFF]

iA P A S M  M

The camera raises the image resolution by correcting the blurriness caused by diffraction when the aperture is closed.

- Compensation effect may not be achieved depending on the recording conditions.
- Noise may stand out with higher ISO sensitivity.

[Filter Settings]  

[Filter Effect]	[ON]/▶[OFF]/[SET]
[Simultaneous Record w/o Filter]	[ON]/▶[OFF]
This mode records with additional image effects (filters). (→ [Filter Settings]: 293)	

[Photo] menu ([Focus])

▶: Default settings

[AF Custom Setting(Photo)]

▶[Set 1]/[Set 2]/[Set 3]/[Set 4]

Select features of AF operation when recording using [AFC] that are appropriate for the subject and scene.

(→ [\[AF Custom Setting\(Photo\)\]: 132](#))

[AF Assist Light]

▶[ON]/[OFF]

iA P A S M 

When recording in low light conditions, the AF assist light turns on when you press the shutter button halfway, making it easier for the camera to focus.

- The effective range of the AF assist light is different depending on the lens used.
 - When the interchangeable lens (H-ES12060) is attached and at wide-angle end.
Approx. 1.0 m (3.3 feet) to 3.5 m (11 feet)
 - When the interchangeable lens (H-FS12060) is attached and at wide-angle end.
Approx. 1.0 m (3.3 feet) to 3.0 m (9.8 feet)
- Remove the lens hood.
- The AF assist light may be greatly blocked, and it may become harder to focus when a lens with large diameter is used.

[Focus Peaking] 

▶[ON]/[OFF]	
[SET]	[Focus Peaking Sensitivity]
	[Display Color]
	[Display During AFS]

iA P A S M 

During MF operation, in-focus portions (portions on the screen with clear outlines) are highlighted with color.

- If the [Focus Peaking Sensitivity] is adjusted to the negative direction, portions to be highlighted are reduced, allowing you to achieve a more precise focus.
- With [Display Color], you can set the display color of the in-focus portion.
- When [Display During AFS] is set to [ON], the Focus Peaking display is also possible when the shutter button is pressed halfway in the [AFS] focus mode.
- You can display the Touch Tab (→[Touch Settings]: 559) and then touch [PEAK] in [] to switch [ON]/[OFF].
- When [Rough Monochrome] of [Filter Settings] is being used, [Focus Peaking] is not available.
- When [Live View Boost] is being used, [Focus Peaking] is not available.

[1-Area AF Moving Speed] 

▶[FAST]/[NORMAL]

iA P A S M 

Sets the speed when moving a single AF area.

[Photo] menu ([Flash])

▶: Default settings

[Flash Mode]

▶[]/[]/[S]/[S[Ⓢ]]/[S[Ⓢ]]/[S[Ⓢ]]

Sets the flash mode.

(→[Flash Mode]: 309)

[Firing Mode]

▶[TTL]/[MANUAL]

You can select whether to set the flash output automatically or manually.

(→[Firing Mode]/[Manual Flash Adjust.]: 311)

[Flash Adjust.]

[–3 EV] to [+3 EV] (▶[±0 EV])

When [Firing Mode] is set to [TTL], you can adjust the flash output.

(→[Flash Adjust.]: 313)

[Flash Synchro]

▶[1ST]/[2ND]

Sets the flash mode to Second Curtain Synchro.

(→[Flash Synchro]: 315)

[Manual Flash Adjust.]

[1/128] to ▶[1/1]

When [Firing Mode] is set to [MANUAL], you can set the flash output.
(→ [Firing Mode]/[Manual Flash Adjust.]: 311)

[Auto Exposure Comp.]

[ON]/▶[OFF]

Automatically adjust the flash output in conjunction with the exposure compensation value.
(→ [Auto Exposure Comp.]: 316)

[Wireless]

[ON]/▶[OFF]

Enables recording using a wireless flash.
(→ [Recording Using a Wireless Flash]: 317)

[Wireless Channel]

▶[1CH]/[2CH]/[3CH]/[4CH]

Sets the channel to use when recording with a wireless flash.
(→ [Recording Using a Wireless Flash]: 317)

[Wireless FP]

[ON]▶[OFF]

Uses FP firing for an external flash when recording with a wireless flash.

(→ [\[Wireless FP\]: 323](#))**[Communication Light]**

▶[HIGH]/[STANDARD]/[LOW]

Set the strength of communication light.

(→ [\[Communication Light\]: 323](#))**[Wireless Setup]**

[External Flash]

[Firing Mode]/[Flash Adjust.]/[Manual
Flash Adjust.]

[A Group]/[B Group]/[C Group]

[Firing Mode]/[Flash Adjust.]/[Manual
Flash Adjust.]



Sets details for wireless flash recording.

(→ [Setting Items \(\[Wireless Setup\]\): 321](#))

[Photo] menu ([Others (Photo)])

▶: Default settings









[Bracketing]

[Bracketing Type]	[] / [] / [FOCUS] / [WB] / [WB] / [OFF]
[More Settings]	
You can take multiple pictures while automatically adjusting a setting. (→ Bracket Recording: 231)	

[Silent Mode]

[ON] ▶ [OFF]
Disables all operation sounds and light output at once. (→ Silent Mode: 239)

[Image Stabilizer]

[Operation Mode]	▶ [] / [] / [] / [OFF]
[E-Stabilization (Video)]	[ON] ▶ [OFF]
[Boost I.S. (Video)]	[ON] ▶ [OFF]
[Anamorphic (Video)]	^{A2.0} [] / ^{A1.8} [] / ^{A1.5} [] / ^{A1.33} [] / ^{A1.30} [] / [OFF]
[Lens Information]	[Lens1] to [Lens12] (▶[Lens1])
Configures image stabilizer settings. (→ Image Stabilizer: 243)	

[Burst Rate]

▶[H]/[M]/[L]

Sets the burst recording operation.

(→ [Taking Burst Pictures: 184](#))

[Shutter Type]

[AUTO]/▶[MECH.]/[EFC]/[ELEC.]/[ELEC.+NR]

Selects the shutter type to use for taking pictures.

(→ [\[Shutter Type\]: 240](#))

[Shutter Delay]

[8SEC]/[4SEC]/[2SEC]/[1SEC]/▶[OFF]

iA P A S M 

To reduce camera shake and shutter-induced blur, the shutter is released after the specified time has passed since the shutter button was pressed.

- When the following functions are being used, [Shutter Delay] is not available:
 - Video recording/[6K/4K PHOTO]/[Post-Focus]

[Ex. Tele Conv.]

[ZOOM]/[TELE CONV.]▶[OFF]

You can take pictures that are further enlarged beyond what is available with the optical zoom, without any deterioration in image quality.

(→ [Extended Tele Conversion: 176](#))

[Time Lapse/Animation]





[Mode]

▶[Time Lapse Shot]

[Stop Motion Animation]

Time Lapse Shot automatically starts/stops recording at a set recording interval. Stop Motion Animation enables you to take pictures while moving the subject little by little.

(→ [Recording with Time Lapse Shot: 216](#), [Recording with Stop Motion Animation: 221](#))

[Self Timer] ▶[10]/[10■]/[2]/[3] etc. (Custom)

[SET]

[Custom Time]

[Display Countdown]

Sets the self-timer duration.

(→ [Recording Using the Self-timer: 227](#))

[6K/4K PHOTO]

[Picture Size / Burst Speed]	▶[6K 18M]/[4K H 8M]/[4K 8M]
[Rec Method]	▶[6K/4K Burst]/[6K/4K Burst(S/S)]/[6K/4K Pre-Burst]
[Pre-Burst Recording]	[ON]▶[OFF]
<p>Sets 6K/4K photos.</p> <p>You can save pictures extracted from a burst file taken using high-speed burst. (→ 6K/4K Photo Recording: 190)</p>	

[Post-Focus]

▶[6K 18M]/[4K 8M]
<p>Taking burst pictures with the same image quality as 6K/4K photos while automatically changing the focus point.</p> <p>You can select the focus point for the picture to save after recording. (→ Post-Focus Recording: 207)</p>

[Multiple Exposure]

[Start]	
[Auto Gain]	▶[ON]/[OFF]
[Overlay]	[ON]▶[OFF]
<p>iA P A S M </p> <p>You can apply an effect equivalent to four exposures on a single image.</p> <p>[Start]: Starts exposure for multiple exposures.</p> <p>[Auto Gain]: Automatically adjusts brightness in accordance with image count.</p> <p>[Overlay]: Allows multiple exposure for recorded RAW images. After selecting [Start], a selection screen for images to stack is displayed.</p>	

- After selecting [Start], pressing the shutter button fully starts multiple exposure.
- Preview is displayed for each recording, and the following operations are available:



- [Next] (You can also perform the same operation by pressing the shutter button halfway.)
 - [Retake]
 - [Exit]: Records the picture, and finishes multiple exposure recording.
- To finish multiple exposure recording before starting the recording, press [Q] on the recording screen.
 - Recording information for the last-recorded image will be saved as recording information for images recorded with multiple exposures.
 - [Overlay] can be set only for RAW images recorded with the camera.
 - When the following functions are being used, [Multiple Exposure] is not available:
 - [Time Lapse Shot]
 - [Stop Motion Animation]
 - [Filter Settings]
 - HDMI output

[Time Stamp Rec.]

[ON]▶[OFF]

iA P A S M 

Records the recorded date and time superimposed on the images.

- You cannot delete recording dates after superimposing them.
- The recorded date and time are not recorded in 6K/4K burst files or RAW images.
- When the following functions are being used, [Time Stamp Rec.] is not available:
 - [Post-Focus]
 - 6K/4K Anamorphic (4:3) video
 - [Variable Frame Rate]

[Video] Menu

- [Video] menu ([Image Quality]): 534
- [Video] menu ([Image Format]): 538
- [Video] menu ([Focus]): 540
- [Video] menu ([Audio]): 542
- [Video] menu ([Others (Video)]): 545

: Menu items common to the [Photo] menu and [Video] menu. Their settings are synchronized.

[Video] menu ([Image Quality])

▶: Default settings

[Exposure Mode]

▶[P]/[A]/[S]/[M]

Sets the exposure mode to use in  mode.

(→ [Creative Video Mode: 330](#))

[Photo Style]

▶[Standard] / [Vivid] / [Natural] / [L.ClassicNeo] / [Flat] / [Landscape] / [Portrait] / [Monochrome] / [L.Monochrome] / [L.Monochrome D] / [L.Monochrome S] / [Cinelike D2] / [Cinelike V2] / [Like709] / [V-Log L] / [Hybrid Log Gamma] / [MY PHOTO STYLE 1] to [MY PHOTO STYLE 10]

You can select the finishing settings of images to suit your subjects and expression styles.

(→ [Photo Style: 285](#))

[Metering Mode] ▶  /  /  / 

Type of optical measurement to measure brightness can be changed.

(→ [\[Metering Mode\]: 252](#))**[ISO Sensitivity (video)]**

[ISO Auto Lower Limit Setting]

▶ [200] to [6400]

[ISO Auto Upper Limit Setting]

▶ [AUTO]/[400] to [12800]

Sets the lower and upper limits for ISO sensitivity when ISO sensitivity is set to [AUTO].

(→ [\[ISO Sensitivity \(video\)\]: 362](#))**[Synchro Scan]**

[ON]▶[OFF]

Fine-adjust the shutter speed to reduce flickering and horizontal stripes.

(→ [\[Synchro Scan\]: 410](#))**[Flicker Decrease (Video)]**

[1/50]/[1/60]/[1/100]/[1/120]▶[OFF]

 **P** **A** **S** **M** 

The shutter speed can be fixed to reduce the flicker or striping in the video.

• This can be set when [Auto Exposure in P/A/S/M] is [ON].

[Master Pedestal Level]

[-15] to [15] (▶[0])

You can adjust the black level, which serves as the reference for images.

(→ [\[Master Pedestal Level\]: 358](#))

[SS/Gain Operation]

▶[SEC/ISO]/[ANGLE/ISO]/[SEC/dB]

You can switch the units of shutter speed values and gain (sensitivity) values.

(→ [\[SS/Gain Operation\]: 370](#))

[i.Dynamic Range] 

[AUTO]/[HIGH]/[STANDARD]/[LOW]▶[OFF]

Contrast and exposure are compensated when the brightness difference between the background and subject is great.

(→ [\[i.Dynamic Range\]: 520](#))

[Vignetting Comp.] 

[ON]▶[OFF]

When the screen periphery darkens as a result of the lens characteristics, you can record pictures with the brightness of the screen periphery corrected.

(→ [\[Vignetting Comp.\]: 521](#))

[Diffraction Compensation] 

[AUTO]▶[OFF]

The camera raises the image resolution by correcting the blurriness caused by diffraction when the aperture is closed.

(→ [\[Diffraction Compensation\]: 521](#))

[Filter Settings] 

[Filter Effect]	[ON]▶[OFF]/[SET]
[Simultaneous Record w/o Filter]	[ON]▶[OFF]
This mode records with additional image effects (filters).	
(→ [Filter Settings]: 293)	

[Video] menu ([Image Format])

▶: Default settings

[Rec. File Format]

▶[MP4]/[MOV]

Sets the video recording file format.

(→ [\[Rec. File Format\]: 337](#))

[Image Area of Video]

▶[FULL]/[PIXEL/PIXEL]

Sets the image area during video recording.

(→ [\[Image Area of Video\]: 348](#))

[Rec Quality]

Sets the video recording image quality.

(→ [\[Rec Quality\]: 338](#))

[Rec Quality (My List)]

Calls up a recording quality registered in My List.

(→ [\[add to list\]: 346](#))

[Variable Frame Rate]

[ON]▶[OFF]

Varies the recording frame rate to record slow motion video and fast motion video.

(→ [\[Variable Frame Rate\]: 382](#))

[Time Code]

[Time Code Display]	[ON]/▶[OFF]
[Count Up]	▶[REC RUN]/[FREE RUN]
[Time Code Value]	[Reset]
	[Manual Input]
	[Current Time]
[Time Code Mode]	▶[DF]/[NDF]
[HDMI Time Code Output]	[ON]/▶[OFF]
Sets the recording, display, and output of the time code. (→ Time Code: 350)	

[Luminance Level]

[0-255]/[16-235]/▶[16-255]
You can set the luminance range to suit the purpose of video recording. (→ Luminance Level: 357)

[Video] menu ([Focus])

▶: Default settings

[AF Custom Setting(Video)]

[ON]▶[OFF]	
[SET]	[AF Speed]/[AF Sensitivity]
You can fine-adjust the focusing method for video recording using [Continuous AF]. (→ [AF Custom Setting(Video)]: 355)	

[Continuous AF]

▶[MODE1]/[MODE2]/[OFF]
You can select how to set the focus in AF when recording videos. (→ [Continuous AF]: 354)

[AF Assist Light]

▶[ON]/[OFF]
When recording in low light conditions, the AF assist light turns on when you press the shutter button halfway, making it easier for the camera to focus. (→ [AF Assist Light]: 523)

[Focus Peaking] 

▶[ON]/[OFF]	
[SET]	[Focus Peaking Sensitivity]
	[Display Color]
	[Display During AFS]
<p>During MF operation, in-focus portions (portions on the screen with clear outlines) are highlighted with color. (→[Focus Peaking]: 524)</p>	

[1-Area AF Moving Speed] 

▶[FAST]/[NORMAL]
<p>Sets the speed when moving a single AF area. (→[1-Area AF Moving Speed]: 524)</p>

[Video] menu ([Audio])

▶: Default settings

[Sound Rec Level Disp.]

[ON]▶[OFF]

The sound recording level is displayed on the recording screen.

(→[Sound Rec Level Disp.]: 364)

[Mute Sound Input]

[ON]▶[OFF]

This mutes audio input.

(→[Mute Sound Input]: 365)

[Sound Rec Gain Level]

▶[STANDARD]/[LOW]

This switches the gain of audio input.

(→[Sound Rec Gain Level]: 365)

[Sound Rec Level Adj.]

[MUTE], [−18dB] to [+12dB] (▶[0dB])

Manually adjust the sound recording level.

(→[Sound Rec Level Adj.]: 366)

[Sound Rec Level Limiter]

▶[ON]/[OFF]

The sound recording level is adjusted automatically to minimize sound distortion (crackling noise).

(→[\[Sound Rec Level Limiter\]: 366](#))

[Wind Noise Canceller]

[HIGH]/▶[STANDARD]/[OFF]

This reduces the wind noise coming into the built-in microphone while maintaining sound quality.

(→[\[Wind Noise Canceller\]: 367](#))

[Wind Cut]

[HIGH]/[STANDARD]/[LOW]/▶[OFF]

This reduces wind noise when an external microphone is connected.

(→[Reduction of Wind Noise: 438](#))

[Lens Noise Cut]

▶[ON]/[OFF]

You can reduce the zoom sound produced during video recording when you are using interchangeable lens compatible with power zoom.

(→[\[Lens Noise Cut\]: 368](#))

[Special Mic.]

▶[STEREO]/[LENS AUTO]/[SHOTGUN]/[S.SHOTGUN]/[MANUAL]

Sets the sound pickup range when using the Stereo Shotgun Microphone (DMW-MS2: optional).

(→[Setting the Sound Pickup Range \(DMW-MS2: Optional\): 437](#))

[XLR Mic Adaptor Setting]

[96kHz/24bit]/[48kHz/24bit]/▶[48kHz/16bit]/[OFF]

Sets the audio input for when an XLR Microphone Adaptor (DMW-XLR1: optional) is attached.

(→ [XLR Microphone Adaptor \(Optional\): 439](#))

[Sound Output]

▶[REALTIME]/[REC SOUND]

Sets the audio output method when headphones are connected.

(→ [Switching the Sound Output Method: 442](#))

[Headphone Volume]

[0] to [LEVEL15] (▶[LEVEL3])

Adjusts the volume when headphones are connected.

(→ [Adjusting the Headphone Volume: 442](#))

[Video] menu ([Others (Video)])

▶: Default settings

[Silent Mode]



[ON]▶[OFF]

Disables all operation sounds and light output at once.

(→ [\[Silent Mode\]: 239](#))

[Image Stabilizer]

[Operation Mode]

▶[]/[]/[]/[OFF]





[E-Stabilization (Video)]

[ON]▶[OFF]

[Boost I.S. (Video)]

[ON]▶[OFF]

[Anamorphic (Video)]

^{A2.0}
[]/[^{A1.8}
[]]/[^{A1.5}
[]]/[^{A1.33}
[]]/[^{A1.30}
[]]▶[OFF]

[Lens Information]





[Lens1] to [Lens12] (▶[Lens1])

Configures image stabilizer settings.

(→ [Image Stabilizer: 243](#))

[Self Timer Setting]

[Self Timer]

▶[]₁₀]/[]₁₀]/[]₂]/[]₃] etc. (Custom)

[SET]

[Custom Time]

[Display Countdown]

[Self Timer For Video]

[ON]▶[OFF]

Sets the self-timer duration.

(→ [Setting the Self-timer Time: 229](#))

[Focus Transition]

[Start]	
[Focus Pull Setting]	[1]/[2]/[3]
[Focus Transition Speed]	[SH]/[H]/▶[M]/[L]/[SL]
[Focus Transition Rec]	[1]/[2]/[3]/▶[OFF]
[Focus Transition Wait]	[10SEC]/[5SEC]/▶[OFF]
<p>Smoothly transitions the focus position from the current position to a position registered in advance.</p> <p>(→ [Focus Transition]: 386)</p>	

[Loop Recording (video)]

[ON]/▶[OFF]
<p>When the recording fills the card to capacity, recording continues while deleting older data.</p> <p>(→ [Loop Recording (video)]: 412)</p>

[Segmented File Recording]

[10MIN.]/[5MIN.]/[3MIN.]/[1MIN.]/▶[OFF]
<p>Video is divided every few minutes while being recorded.</p> <p>(→ [Segmented File Recording]: 414)</p>

[Live Cropping]

[40SEC]/[20SEC]▶[OFF]

By cropping a part of the range displayed in the live view, it is possible to record FHD video that incorporates panning and zooming with the camera staying in a fixed position.

(→[Live Cropping]: 390)

[Time Stamp Rec.]

[ON]▶[OFF]

Records the recorded date and time superimposed on the images.

(→[Time Stamp Rec.]: 533)

[Custom] Menu

- [Custom] menu ([Image Quality]): 549
- [Custom] menu ([Focus/Shutter]): 553
- [Custom] menu ([Operation]): 559
- [Custom] menu ([Monitor / Display (Photo)]): 564
- [Custom] menu ([Monitor / Display (Video)]): 575
- [Custom] menu ([IN/OUT]): 579
- [Custom] menu ([Lens / Others]): 580

[Custom] menu ([Image Quality])

▶: Default settings

[Photo Style Settings]

[Show/Hide Photo Style]	[Vivid]/[Natural]/[L.ClassicNeo]/[Flat]/ [Landscape]/[Portrait]/[L.Monochrome]/ [L.Monochrome D]/[L.Monochrome S]/ [Cinelike D2]/[Cinelike V2]/[Like709]/ [V-Log L]/[Hybrid Log Gamma]/[MY PHOTO STYLE 1] to [MY PHOTO STYLE 10]
Sets Photo Style items to be displayed on the menu.	
[My Photo Style Settings]	[Add Effects] [Load Preset Setting]
Enables detailed image quality adjustment settings for My Photo Style. [Add Effects]: Enables [Sensitivity] and [White Balance] settings in image quality adjustment. [Load Preset Setting]: Sets the timing at which image quality adjustment values changed in My Photo Style are returned to their registered state.	
[Reset Photo Style]	
Returns details changed in [Photo Style] and [Photo Style Settings] to their default settings.	

[ISO Increments]

▶[1/3 EV]/[1 EV]
Changes the intervals between ISO sensitivity adjustment values.

[Extended ISO]

[ON]▶[OFF]

Setting of ISO sensitivity to a minimum of [ISO100] is possible.

[Exposure Offset Adjust.]

[Multi Metering]	[− 1EV] to [+ 1EV] (▶[±0EV])
[Center Weighted]	[− 1EV] to [+ 1EV] (▶[±0EV])
[Spot]	[− 1EV] to [+ 1EV] (▶[±0EV])
[Highlight Weighted]	[− 1EV] to [+ 1EV] (▶[±0EV])
<p>Adjusts the exposure level that is the standard exposure for each item of [Metering Mode]. Adds the adjustment value from this function to the exposure compensation value (→ Exposure Compensation: 269) when recording.</p> <ul style="list-style-type: none"> • For video recording, [6K/4K PHOTO], and [Post-Focus], it is not possible to add an adjustment value of a range that exceeds ± 3 EV. 	

[Color Space]

▶[sRGB]/[AdobeRGB]

This sets the method for correcting the color reproduction of the recorded images on the screens of a PC or on a device such as a printer.

[sRGB]: This is widely used in PCs and similar devices.

[AdobeRGB]: AdobeRGB is mainly used for business purposes such as professional printing because it has a greater range of reproducible colors than sRGB.

- Set to [sRGB] if you are not very familiar with AdobeRGB.
- When the following functions are being used, the setting is fixed to [sRGB]:
 - Video recording/[6K/4K PHOTO]/[Post-Focus]
 - [Like709]/[V-Log L] ([Photo Style])
 - [Filter Settings]

[Exposure Comp. Reset]

[ON]▶[OFF]

This resets the exposure value when you change the recording mode or turn off the camera.

[Auto Exposure in P/A/S/M]











▶[ON]/[OFF]

Selects the setting method for aperture value, shutter speed, and ISO sensitivity for the video being recorded in the [P]/[A]/[S]/[M] modes.

[ON]: Records with values set automatically by the camera.

[OFF]: Records with manually set values.

[CreativeVideo Combined Set.]

[F/SS/ISO/Exposure Comp.]	▶ [] / []
[White Balance]	▶ [] / []
[Photo Style]	▶ [] / []
[Metering Mode]	▶ [] / []
[AF Mode]	▶ [] / []
Content set in [ M] mode can be separated from when taking pictures. (→ Separating Settings for Recording Video and Pictures: 334)	

[Custom] menu ([Focus/Shutter])

▶: Default settings

[Focus/Shutter Priority]

[AFS]	▶[FOCUS]/[BALANCE]/[RELEASE]
[AFC]	[FOCUS]▶[BALANCE]/[RELEASE]

This sets whether to give priority to focus or shutter release during AF.

[FOCUS]: Disables recording when focus is not achieved.

[BALANCE]: Performs recording while controlling the balance between focusing and shutter release timing.

[RELEASE]: Enables recording even when focus is not achieved.

[Focus Switching for Vert / Hor]

[ON]▶[OFF]

This stores separate AF area positions (MF positions for MF Assist) for when the camera is held vertically and when it is held horizontally.

(→ [\[Focus Switching for Vert / Hor\]: 166](#))

[AF/AE Lock Hold]

[ON]▶[OFF]

This sets button operations for AF/AE Lock.

Turning this [ON] maintains the lock after releasing the button until it is pressed again.

[AF+MF]

[ON]▶[OFF]

When the focus mode is set to [AFS], you can fine-adjust the focus manually during AF lock.

- When the shutter button is pressed halfway
- When [AF ON] is pressed
- When locked using the Fn button [AF LOCK] or [AF/AE LOCK]

[MF Assist]

(When an interchangeable lens with a focus ring is attached) [Focus Ring]	▶[ON]/[OFF]
[AF Mode]	▶[ON]/[OFF]
[Press Joystick]	[ON]▶[OFF]
[MF Assist Display]	[FULL]▶[PIP]

This sets the display method of MF Assist (enlarged screen).

[Focus Ring]: The screen is enlarged by focusing with the lens.

[AF Mode]: The screen is enlarged by pressing [].

[Press Joystick]: Press the joystick to enlarge the display. (if [Joystick Setting] is set to [D.FOCUS Movement]) (→[\[Joystick Setting\]: 563](#))

[MF Assist Display]: Sets the display method (full screen mode/windowed mode) of MF Assist (enlarged screen).

- While you are using the following functions, MF Assist will not be displayed:
 - Video recording
 - [6K/4K Pre-Burst]

[MF Guide]

[m]/[ft.]/[OFF]

* Default setting specifications vary depending on the country or area where the camera was purchased.

During MF, MF Guide, which acts as a guide to recording distance, is displayed on the screen. You can select from meters or feet for the display unit.

- The distance index of the [MF Guide] depends on the lens and zoom position. If the lens does not support the display of the distance index, only the scale is displayed on the MF guide.

[Focus Ring Lock]

[ON]▶[OFF]

This disables the focus ring operation during MF to lock the focus.

- [MFL] is displayed on the recording screen while the focus ring is locked.

[Show/Hide AF Mode]

[Human/Animal Detect AF]	▶[ON]/[OFF]
[Tracking]	▶[ON]/[OFF]
[225-Area]	▶[ON]/[OFF]
[Zone (Vert./ Horz.)]	▶[ON]/[OFF]
[Zone (Square)]	[ON]▶[OFF]
[Zone (Oval)]	▶[ON]/[OFF]
[1-Area+]	▶[ON]/[OFF]
[Pinpoint]	▶[ON]/[OFF]
[Custom1]	[ON]▶[OFF]
[Custom2]	[ON]▶[OFF]
[Custom3]	[ON]▶[OFF]
Sets the AF mode items to be displayed on the AF mode selection screen.	

[Pinpoint AF Setting]

[Pinpoint AF Time]	[LONG]▶[MID]/[SHORT]
[Pinpoint AF Display]	[FULL]▶[PIP]

Changes enlarged screen settings displayed when AF mode is [**+**].

[Pinpoint AF Time]: Sets the time for which the screen is enlarged when the shutter button is pressed halfway.

[Pinpoint AF Display]: Sets the display method (full screen mode/windowed mode) of the enlarged screen.

[AF-Point Scope Setting]

[Keep Enlarged Display]	[ON]▶[OFF]
[PIP Display]	[FULL]▶[PIP]

Changes the enlarged screen settings of AF-Point Scope (→ [Magnify the AF Area Position \(\[AF-Point Scope\]: 131\)](#)).

[Keep Enlarged Display]: Setting this to [ON] maintains the enlarged screen after pressing the Fn button until it is pressed again.

[PIP Display]: Sets the display method (full screen mode/windowed mode) of the enlarged screen.

[Shutter AF]

▶[ON]/[OFF]

This adjusts focus automatically when you press the shutter button halfway.

[Half-Press Shutter]

[ON]▶[OFF]

You can release the shutter quickly by pressing the shutter button halfway.

[Assign REC to Shutter Button]

▶[ON]/[OFF]

Use the shutter button for the start/stop operation of video recording in the [CAM] mode.

The start/stop operation of video recording using the shutter button can be disabled when set to [OFF].

[Quick AF]

[ON]▶[OFF]

When the amount of camera shake becomes small, the camera will automatically adjust the focus and focus adjustment will then be quicker when the shutter button is pressed.

- The battery will drain faster than usual.
- This function is not available in the following cases:
 - In preview mode
 - In low light situations

[Eye Sensor AF]

[ON]▶[OFF]

When looking through the viewfinder, if the eye sensor operates, then AF will function.

- [Eye Sensor AF] may not work in low light situations.

[Looped Focus Frame]

[ON]▶[OFF]

When moving the AF area or MF Assist, this enables its position to loop from one edge to the other edge of the screen.

[AFC Start Point (225-Area)]

[ON]▶[OFF]

When the focus mode is set to [AFC] in the [] AF mode, you can specify which area to start [AFC].

(→[225-Area]: 145)

[Custom] menu ([Operation])

▶: Default settings















[Q.MENU Settings]

[Layout Style]	▶[MODE1]/[MODE2]
[Front Dial Assignment]	[Item]/▶[Value]
[Item Customize (Photo)]	
[Item Customize (Video)]	
Customizes the Quick menu. (→ Quick Menu Detailed Settings: 497)	

[Touch Settings]

[Touch Screen]	▶[ON]/[OFF]
[Touch Tab]	[ON]/▶[OFF]
[Touch AF]	▶[AF]/[AF+AE]
[Touch Pad AF]	[EXACT]/[OFFSET1] to [OFFSET7]/ ▶[OFF]
<p>Enables touch operation on the monitor display.</p> <p>[Touch Screen]: All touch operations.</p> <p>[Touch Tab]: Operations of tabs, such as [] on the right side of the screen.</p> <p>[Touch AF]: Operation to optimize the focus ([AF]) for a touched subject. Alternatively, operation to optimize both the focus and brightness ([AF+AE]). (→ Moving the AF Area by Touch: 161)</p> <p>[Touch Pad AF]: Touch pad operation during viewfinder display. (→ Moving the AF Area Position with the Touch Pad: 163)</p>	

[Operation Lock Setup]

[Cursor]	▶[]/[]
[Joystick]	▶[]/[]
[Touch Screen]	▶[]/[]
[Dial]	▶[]/[]
[DISP. Button]	▶[]/[]
<p>This sets the control functions to be disabled with the Fn button [Operation Lock]. (Only for recording screen)</p> <p>[Cursor]: Cursor buttons, [MENU/SET] button, and </p> <p>[Joystick]: Joystick</p> <p>[Touch Screen]: Touch screen</p> <p>[Dial]: , , and </p> <p>[DISP. Button]: [DISP.] button</p>	

[Fn Button Set]

[Setting in REC mode]
[Setting in PLAY mode]
<p>Registers a function to the Fn button.</p> <p>(→ Register Functions to the Fn Buttons: 474)</p>

[WB/ISO/Expo. Button]

[WHILE PRESSING]/[AFTER PRESSING1]/▶[AFTER PRESSING2]

This sets the operation to be performed when [WB] (White balance), [ISO] (ISO sensitivity) or [] (Exposure compensation) is pressed.

[WHILE PRESSING]: Allows you to change the setting while pressing and holding the button. Release the button to confirm the settings value, and to return to the recording screen.

[AFTER PRESSING1]: Press the button to change settings. Press the button again to confirm the settings value, and to return to the recording screen.

[AFTER PRESSING2]: Press the button to change settings. Each press of the button switches the settings value. (Except that of exposure compensation) To confirm your selection and return to the recording screen, press the shutter button halfway.

[ISO Displayed Setting]

[Front/Rear Dials]

▶[ISO/ISO] / [ / ISO] / [OFF/ISO] / [ISO/ ] / [ISO/OFF]

This sets the operations of the dials in the setting screen for ISO sensitivity. Assigning [] lets you change [ISO Auto Upper Limit Setting].









[Exposure Comp. Disp. Setting]

[Cursor Buttons (Up/Down)]

[]/▶[OFF]

This sets the operations of the ▲▼ buttons in the exposure compensation screen. Assigning [] lets you set exposure bracketing.

















[Front/Rear Dials]

▶[ / ] / [ / ] / [OFF/ ] / [ / ] / [ /OFF]

This sets the operations of the dials in the exposure compensation screen. Assigning [] lets you adjust flash output.

[Dial Set.]

[Assign Dial (F/SS)]		▶[SET1]/[SET2]/[SET3]/[SET4]/[SET5]			
Sets the operations to be assigned to the dials in [P]/[A]/[S]/[M] modes. P/↗: Program Shift, F: Aperture value, SS: Shutter speed					
		[P]	[A]	[S]	[M]
[SET1]		P/↗	F	SS	F
		P/↗	F	SS	SS
[SET2]		—	F	—	F
		P/↗	—	SS	SS
[SET3]		—	—	SS	SS
		P/↗	F	—	F
[SET4]		—	—	—	F
		P/↗	F	SS	SS
[SET5]		P/↗	F	SS	F
		—	—	—	SS
[Rotation (F/SS)]		▶ /[
Changes the rotational directions of the dials for aperture value and shutter speed adjustment.					
[Control Dial Assignment]		▶ ([Headphone Volume])/ ([Exposure / Aperture])/ ([Exposure Comp.])/ ([Sensitivity])/ ([Focus Frame Size])			
Sets the function to be assigned to on the recording screen. : In [M] mode, this assigns the operation to adjust the aperture value. In other than [M] mode, this assigns the operation of exposure compensation.					

[Exposure Comp.]	[]/[]/▶[OFF]
Assigns exposure compensation to  or  . (Except in [M] mode)	
• The [Assign Dial (F/SS)] setting takes priority.	
[Dial Operation Switch Setup]	[]
	[]
In the Fn button [Dial Operation Switch], this sets the functions to be registered temporarily to  or  . (→ Register Functions to the Dials: 487)	
[Rotation (Menu Operation)]	▶[] []/[] []/[] []/ [] []
Changes the rotational direction of the dials when operating menus.	

[Joystick Setting]

▶[D.FOCUS Movement]/[Fn]/[MENU]/[OFF]
Sets the joystick movement on the recording screen.
[D.FOCUS Movement]: Moves the AF area and MF Assist. (→ AF Area Movement Operation: 158 , Record Using MF: 167)
[Fn]: Operates as Fn buttons.
[MENU]: Operates as  . Operations that can be performed by moving the joystick are disabled.
[OFF]: Disables the joystick.

[Video Rec. Button (Remote)]

You can register a favorite function to the video rec. button on a Shutter Remote Control (optional).
(→ Shutter Remote Control (Optional): 711)
• [Video Record] is registered in the default setting.

[Custom] menu ([Monitor / Display (Photo)])

▶: Default settings

[Auto Review]

[Duration Time (photo)]	[HOLD]/[5SEC] to [0.5SEC]▶[OFF]
[Duration Time (6K/4K PHOTO)]	▶[HOLD]/[OFF]
[Duration Time (Post-Focus)]	▶[HOLD]/[OFF]
[Playback Operation Priority]	[ON]▶[OFF]

This displays an image immediately after it is recorded.

[Duration Time (photo)]: Sets the Auto Review when taking pictures.

[Duration Time (6K/4K PHOTO)]: Sets the Auto Review when recording 6K/4K photos.

[Duration Time (Post-Focus)]: Sets the Auto Review when recording with Post-Focus.

[Playback Operation Priority]: When this is set to [ON], you can toggle the playback screen during Auto Review, or delete pictures.

- If you set [Duration Time (photo)] to [HOLD], the image recorded stays displayed until the shutter button is pressed halfway.
[Playback Operation Priority] will be fixed to [ON].

[Constant Preview]

[ON]▶[OFF]	
[SET]	[Effect]
	[Preview While MF Assist]
<p>You can always confirm the effects of aperture on the recording screen when in [A]/[M] mode.</p> <p>You can also confirm the shutter speed at the same time when in [M] mode.</p> <ul style="list-style-type: none"> • You can set the combination of the aperture effect and the shutter speed effect in [Effect]. • Preview also operates in the MF Assist screen when [Preview While MF Assist] is set to [ON]. • The preview of the shutter speed effect does not work when using a flash. 	

[Histogram]

[ON]▶[OFF]

This displays the histogram.

Turning this [ON] displays the histogram transition screen.

Press ▲▼◀▶ to set the position.

- A histogram is a graph that displays brightness along the horizontal axis, and the number of pixels at each brightness level on the vertical axis.

By looking at the distribution of the graph, you can determine the current exposure.



(A) ↔ (B)

(A) Dark

(B) Bright



- When the recorded image and the histogram do not match each other under the following conditions, the histogram is displayed in orange:
 - During exposure compensation
 - When the standard exposure is not achieved, such as in low light situations.
- When the following function is being used, the [Histogram] is not available:
 - [WFM/Vector Scope]
- The histogram is an approximation in the recording mode.

[Photo Grid Line]

 ▶[OFF]





Sets the grid line pattern to be displayed on the recording screen.

When using , you can press ▲▼◀▶ to set the position.

- When using , you can also drag  on the grid lines on the recording screen to move the position.

[AF Area Display]

▶[ON]/[OFF]

Displays the AF areas for the , , , , [C1] to [C3] AF modes.

- AF areas are not displayed in the following cases:
 - When [AFC Start Point (225-Area)] is not used during 
 - When AF area shapes are not registered in [C1] to [C3]
- When the following functions are being used, [AF Area Display] is not available:
 - Video recording
 - [6K/4K PHOTO]

[Live View Boost]

[MODE1]/[MODE2]▶[OFF]

[SET]

[P/A/S/M]▶[M]

Displays the screen brighter to make it easier to check subjects and compositions even in low-light environment.

[MODE1]: Setting for low brightness, with priority given to a soft display.

[MODE2]: Setting for high brightness, with priority given to image visibility.

- You can change the recording mode in which [Live View Boost] works by using [SET].
- This mode does not affect recorded images.
- Noise may be more noticeable in the screen than in the recorded image.
- This function does not work in the following cases:
 - When adjusting the exposure (when the shutter button is pressed halfway, for example)
 - When recording a video or 6K/4K photo
 - When using [Filter Settings]
 - When displaying the shutter speed effect of [Constant Preview] in the [M] mode



[Night Mode]

[Monitor]	[ON]▶[OFF]
[LVF]	[ON]▶[OFF]





Displays the monitor and viewfinder in red.

In dark environments, this reduces brightness of the screen that can make the surroundings difficult to see.

You can also set the luminance of the red display.

- 1 Press ▲▼◀▶ to select [ON] on the monitor or viewfinder (LVF).
- 2 Press [DISP.] to display the brightness adjustment screen.
 - Display the monitor to adjust the monitor, and display the viewfinder to adjust the viewfinder.
- 3 Press ◀▶ to adjust luminance and then press  or  .
 - This effect is not applied to images output via HDMI.

[LVF/Monitor Disp. Set]

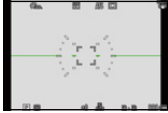
[LVF Disp. Set]	
[Monitor Disp. Set]	
<p>Selects whether to show the live view without covering the information display, or to display over the entire screen.</p> <p>: Scales down images slightly so you can better review the composition of the images.</p>  <p>: Scales images to fill the entire screen so you can see their details.</p> 	
[Horizontal Image Flip(Monitor)]	▶[AUTO]/[ON]/[OFF]
[Vertical Image Flip(Monitor)]	▶[AUTO]/[ON]/[OFF]
<p>[Horizontal Image Flip(Monitor)]</p> <p>[AUTO]: The screen automatically flips horizontally according to the angle to which the monitor is opened or closed.</p> <p>[ON]: The screen is flipped horizontally all the time.</p> <p>[OFF]: Screen is not flipped.</p> <p>[Vertical Image Flip(Monitor)]</p> <p>[AUTO]: The screen automatically flips vertically according to the angle to which the monitor is rotated.</p> <p>[ON]: The screen is flipped vertically all the time.</p> <p>[OFF]: Screen is not flipped.</p> <ul style="list-style-type: none"> • The settings for this function are not reflected in the playback screen. 	

[Expo.Meter]

[ON]▶[OFF]

This displays the exposure meter.

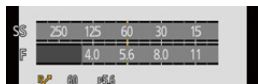

- Set to [ON] to display the exposure meter when performing Program Shift, setting aperture, and setting shutter speed.
- If no operations are performed for a certain period of time, the exposure meter disappears.

[Focal Length]

▶[ON]/[OFF]

Displays the focal length on the recording screen during zoom control.

[Blinking Highlights]

[ON]▶[OFF]



Overexposed areas appear blinking in black and white during Auto Review or playback.

- The display without the highlights is added to the display shown when [DISP.] is pressed in the playback screen.

Use this to delete the highlight display. (→ [Playback Screen: 90](#))



[Sheer Overlay]

[ON]▶[OFF]	
[SET]	[Transparency]
	[Image Select]
	[Reset at Power Off]
	[Disp. Image (shutter-press)]
<p>Displays recorded pictures by overlapping on the recording screen.</p> <ul style="list-style-type: none"> • Use [Image Select] to select the pictures to be displayed. Press ◀▶ to select pictures and then press  or  to confirm. • If you set [Disp. Image (shutter-press)] to [OFF], [Sheer Overlay] is canceled while the shutter button is being pressed halfway or pressed fully. • When the following functions are being used, [Sheer Overlay] is not available: <ul style="list-style-type: none"> – Video recording/[6K/4K PHOTO]/[Post-Focus] 	

[I.S. Status Scope]

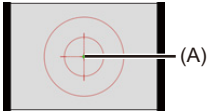
[ON]▶[OFF]	
<p>Displays a reference point (A) on the recording screen in order to let you check for camera shake.</p>	
	
<ul style="list-style-type: none"> • When the following functions are being used, [I.S. Status Scope] is not available: <ul style="list-style-type: none"> – Video recording/[6K/4K PHOTO]/[Post-Focus] 	

[Level Gauge]

▶[ON]/[OFF]

Displays the level gauge which is useful in correcting camera tilt.

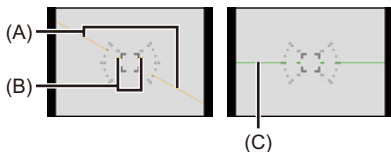

(A) Horizontal

(B) Vertical

(C) Green (no tilt)

- Even after correcting the tilt, there may still be an error of approx. $\pm 1^\circ$.
- When the camera is tilted significantly upwards or downwards, the level gauge may not be displayed correctly.
- You can adjust the level gauge and reset the adjusted values in [Level Gauge Adjust.] in the [Setup] ([Monitor / Display]) menu. (→[Level Gauge Adjust.]: 587)

[Luminance Spot Meter]

[ON]▶[OFF]

Specify any spot on the subject to measure the luminance over a small area.

(→[Luminance Spot Meter]: 375)

[Framing Outline]

[ON]▶[OFF]

Displays the outline for the live view.

[Show/Hide Monitor Layout]

[Control Panel]	▶[ON]/[OFF]
[Black Screen]	▶[ON]/[OFF]
Displays the control panel and black screen when switching between displays using [DISP.] button. (→ Recording Screen: 88)	

[Custom] menu ([Monitor / Display (Video)])

▶: Default settings

[V-LogL View Assist]

[Read LUT File]	
[LUT Select]	
[LUT View Assist (Monitor)]	[ON]▶[OFF]
[LUT View Assist (HDMI)]	[ON]▶[OFF]
<p>You can show images with LUT data applied on the monitor/viewfinder, or output them via HDMI.</p> <p>(→ [V-LogL View Assist]: 398)</p>	

[HLG View Assist]

[Monitor]	[MODE1]▶[MODE2]/[OFF]
[HDMI]	▶[AUTO]/[MODE1]/[MODE2]/[OFF]
<p>At recording or playback of HLG video, this displays images with converted color gamut and brightness on the camera monitor/viewfinder, or outputs these over HDMI.</p> <p>(→ [HLG View Assist]: 404)</p>	

[Anamorphic Desqueeze Display]

$2.0\times$ $1.8\times$ $1.5\times$ $1.33\times$ $1.30\times$
<p>This displays the de-squeezed images suited to the magnification of the anamorphic lens on this camera.</p> <p>(→ [Anamorphic Desqueeze Display]: 407)</p>

[Monochrome Live View]

[ON]▶[OFF]

You can display the recording screen in black and white.

- If you use the HDMI output during recording, the output image will not be displayed in black and white.
- [Monochrome Live View] is not available when [Night Mode] is used.

[Center Marker]

[ON]▶[OFF]

The center of the recording screen will be displayed as [+].

[Frame Marker]

[ON]▶[OFF]

[SET]

[Frame Aspect]

[Frame Color]

[Frame Mask]

A frame with the set aspect ratio is displayed on the recording screen.

(→[Frame Marker]: 379)

[Zebra Pattern]

[ZEBRA1]/[ZEBRA2]/[ZEBRA1+2]▶[OFF]

[SET]

[Zebra 1]

[Zebra 2]

Parts that are brighter than the benchmark value are displayed with stripes.

(→[Zebra Pattern]: 377)

[WFM/Vector Scope]

[WAVE]/[VECTOR]▶[OFF]

This displays the waveform monitor or the vector scope on the recording screen.

(→ [\[WFM/Vector Scope\]: 371](#))

[Color Bars]

[SMPTE]/[EBU]/[ARIB]

The color bars are displayed on the recording screen.

(→ [Color bars/Test Tone: 380](#))

[Video-Priority Display]

[ON]▶[OFF]

When in [iA]/[P]/[A]/[S]/[M] modes, switch the recording screen display and the control panel to suit video recording, as with the [P_{CM}] mode.

The playback screen also switches to a display that prioritizes video.

- When set to a setting where video recording is not available, such as [Post-Focus], [Video-Priority Display] is fixed to [OFF].
- [Video-Priority Display] works only during video recording when using the following functions:
 - [6K/4K PHOTO]
 - [Time Lapse Shot]
 - [Stop Motion Animation]
 - [Multiple Exposure]

[Red REC Frame Indicator]

[ON]▶[OFF]

A red frame is displayed on the recording screen that indicates that video is being recorded.

[Streaming Blue Frame Indicator]

[ON]▶[OFF]

Displays a blue frame on the screen during streaming.

[Custom] menu ([IN/OUT])

▶: Default settings

[HDMI Rec Output]

[Info Display]	▶[ON]/[OFF]
[Down Convert]	▶[AUTO]/[4K/30p]([4K/25p])/[1080p]/ [1080i]/[OFF]
[HDMI Recording Control]	[ON]/▶[OFF]
[Sound Down Convert]	[AUTO]/▶[OFF]
[Sound Output (HDMI)]	▶[ON]/[OFF]
[HDMI MF Assist Output]	▶[ON]/[OFF]
Sets HDMI output during recording.(→ HDMI Output Image Quality (Resolution/ Frame Rate): 429 , HDMI Output Settings: 432)	

[Custom] menu ([Lens / Others])

▶: Default settings

[Lens Focus Resume]

[ON]▶[OFF]

The camera saves the focus position when you turn it off. When an interchangeable lens that is compatible with power zoom is in use, the zoom position is also saved.

[Power Zoom Lens]

[Step Zoom]

[ON]▶[OFF]

[Zoom Speed]

[Photo]: [H]▶[M]/[L]

[Video]: [H]▶[M]/[L]

[Zoom Ring]

▶[ON]/[OFF]

Sets the screen display and operation when using an interchangeable lens compatible with power zoom. (→[Power Zoom Lens]: 180)

[Lens Fn Button Setting]

▶[Focus Stop] / [AF Mode] / [Focus Ring Lock] / [AE LOCK] / [AF LOCK] / [AF/AE LOCK] / [AF-ON] / [AF-ON : Near Shift] / [AF-ON : Far Shift] / [AF-Point Scope] / [Focus Area Set] / [Image Stabilizer] / [Preview] / [Preview Aperture Effect] / [No Setting] / [Off (Disable Press and Hold)] / [Restore to Default]

Sets the function to be assigned to the focus button of an interchangeable lens.

- When [Focus Stop] is set, focus is fixed while the focus button is being pressed.

[Aperture Ring Increment]

[SMOOTH]▶[1/3EV]

[SMOOTH]: You can finely adjust the aperture value.**[1/3EV]:** You can adjust the aperture value in increments of 1/3 EV.

You can change the aperture adjustment increment by operating the aperture ring.

- This setting is available when an interchangeable lens that supports a click-less aperture ring (H-X1025: optional) is attached (As of May 2021).
- When taking pictures, this setting will take effect if the aperture ring is set to a position other than [A].
- If the position of the aperture ring is set to [A], the aperture value set by the camera will take effect and can be adjusted like with [1/3EV].
- During video recording, fine adjustments can be made like with [SMOOTH].
- When [SMOOTH] is set, fractions of aperture values are not displayed on the screen.

[Focus Ring Control]

▶[NON-LINEAR]/[LINEAR]

[SET]

[90°] to [360°] (▶[300°])/[Maximum]

Sets the amount of movement for focusing using the focus ring. (When using supported lenses)

[NON-LINEAR]: Focus responds by accelerating according to rotation speed of the focus ring.**[LINEAR]:** Focus responds at a constant amount according to the rotational angle of the focus ring.**[SET]:** Sets the rotational angle of the focus ring for when [LINEAR] is selected.

- For the latest information on lenses that support focus ring control, see the support site below.

<https://panasonic.jp/support/global/cs/dsc/>

(English only)

[Lens Information]

[Lens1] to [Lens12] (▶[Lens1])

When using a lens that does not have a communication function with the camera, register the lens information in the camera.

- This is linked with [Lens Information] in [Image Stabilizer] under the [Photo] ([Others (Photo)]) menu. (→[Lens Information]: 249)

[Lens Info. Confirmation]

▶[ON]/[OFF]

When you have attached a lens that does not have a communication function with this camera, a message asking for confirmation of the lens information is displayed when you turn on the camera.

[Vertical Position Info (Video)]

▶[ON]/[OFF]

You can set on the menu, whether or not to record the camera's vertical orientation information during video recording.

[ON]: Records vertical orientation information. Videos recorded with the camera held vertically will be automatically played vertically on the PC or smartphone etc. during playback.

[OFF]: Does not record vertical orientation information.

- On the playback screen of the camera, only the thumbnail display is played in vertical orientation.

[Setup] Menu

- [Setup] menu ([Card/File]): 583
- [Setup] menu ([Monitor / Display]): 585
- [Setup] menu ([IN/OUT]): 588
- [Setup] menu ([Setting]): 592
- [Setup] menu ([Others]): 594

[Setup] menu ([Card/File])

▶: Default settings

[Card Format]

[Card Slot 1]/[Card Slot 2]

Formats the card (initialization).

(→ [Formatting Cards \(Initialization\): 62](#))

[Double Card Slot Function]

[Recording Method]

▶ 

This sets the way recording to the card slots 1 and 2 is performed.

(→ [\[Double Card Slot Function\]: 118](#))

[Folder / File Settings]

[Select Folder]/[Create a New Folder]/[File Name Setting]

Set the folder and file name where to save the images.

(→ [\[Folder / File Settings\]: 120](#))

[File Number Reset]

[Card Slot 1]/[Card Slot 2]

Resets the file number of the next recording to 0001.

(→ [\[File Number Reset\]: 123](#))**[Copyright Information]**

[Artist]

[ON]▶[OFF]/[SET]

[Copyright Holder]

[ON]▶[OFF]/[SET]

[Display Copyright Info.]

The registered names of the artist and the copyright holder are recorded in the Exif data of the image.

- You can register each name from [SET] in [Artist] and [Copyright Holder].
How to enter characters (→ [Entering Characters: 609](#))
- Up to 63 characters may be entered.
- You can confirm registered copyright information in [Display Copyright Info.].

[Setup] menu ([Monitor / Display])

▶: Default settings

[Power Save Mode]

[Sleep Mode]	[10MIN.]▶[5MIN.]/[2MIN.]/[1MIN.]/[OFF]
[Sleep Mode(Wi-Fi)]	▶[ON]/[OFF]
[Auto LVF/Monitor Off]	▶[5MIN.]/[2MIN.]/[1MIN.]/[OFF]
[Power Save LVF Shooting]	[Time to Sleep]
	[Method of Activation]
<p>This is a function to automatically turn the camera to sleep (power save) status or turn off the viewfinder/monitor if no operation is performed for a set time. (→[Power Save Mode]: 57)</p>	

[Monitor Frame Rate]

[30fps]/▶[60fps]
<p>Sets the display speed for live view on the monitor when recording pictures.</p> <p>[30fps]: Reduces the power consumption for a longer operating time.</p> <p>[60fps]: Enables smooth display of movements.</p> <ul style="list-style-type: none"> • When the following functions are being used, [Monitor Frame Rate] is not available: <ul style="list-style-type: none"> – [6K/4K PHOTO] – HDMI output

[LVF Frame Rate]

▶[60fps]/[120fps]

Sets the display speed for live view on the viewfinder when recording pictures.

[60fps]: Reduces the power consumption for a longer operating time.

[120fps]: Enables smooth display of movements.

- [LVF120] is displayed on the viewfinder when it is displayed at [120fps].
- When the following functions are being used, [LVF Frame Rate] is not available:
 - [6K/4K PHOTO]
 - HDMI output

[Monitor Settings]/[Viewfinder]

[Brightness]/[Contrast]/[Saturation]/[Red Tint]/[Blue Tint]

This adjusts the brightness, coloring, and red or blue tints of the monitor/viewfinder.

1 Press ▲▼ to select the setting item, and press ◀▶ to adjust.

2 Press  or  to confirm the setting.

- It will adjust the monitor when the monitor is in use, and the viewfinder when the viewfinder is in use.

[Monitor Backlight]/[LVF Luminance]

▶[AUTO]/[-3] to [+3]

Adjusts monitor/viewfinder luminance.

[AUTO]: The brightness is adjusted automatically depending on how bright it is around the camera.

- Adjusts the monitor luminance when displaying the monitor, and the viewfinder luminance when displaying the viewfinder.
- When either [AUTO] is set, or the adjusted value is set to positive side, the usage period will shorten.
- When [Night Mode] is being used, [Monitor Backlight]/[LVF Luminance] are not available.

[Eye Sensor]

[Sensitivity]

▶[HIGH]/[LOW]

This will set the sensitivity of the eye sensor.

[LVF/Monitor Switch]



▶[LVF/MON AUTO] (automatic viewfinder/monitor switching)/[LVF] (viewfinder)/[MON] (monitor)

This will set the method for switching between the viewfinder and monitor.

- If you press [LVF] to switch the display, the [LVF/Monitor Switch] setting will also switch.

[Level Gauge Adjust.]

[Adjust.]

Hold the camera in a horizontal position, and press  or . The level gauge will be adjusted.

[Level Gauge Value Reset]

Restores the default level gauge setting.

[Setup] menu ([IN/OUT])

▶: Default settings

[Beep]

[Beep Volume]	[] (High)/▶[] (Low)/[] (Off)
[AF Beep Volume]	[] (High)/▶[] (Low)/[] (Off)
[AF Beep Tone]	▶[] (Pattern 1)/[] (Pattern 2)/ [] (Pattern 3)
[E-Shutter Vol]	[] (High)/▶[] (Low)/[] (Off)
[E-Shutter Tone]	▶[] (Pattern 1)/[] (Pattern 2)/ [] (Pattern 3)
Sets the beep sounds, AF beep, and electronic shutter sounds.	

[Headphone Volume]

[0] to [LEVEL15] (▶[LEVEL3])
Adjusts the volume when headphones are connected. (→ Adjusting the Headphone Volume: 442) • This functions in tandem with [Headphone Volume] in the [Video] ([Audio]) menu.









[Wi-Fi]

[Wi-Fi Function] (→ 15. Wi-Fi/Bluetooth: 610)
[Wi-Fi Setup] (→ [Wi-Fi Setup] Menu: 674)
[Streaming Setup] (→ 16. Streaming Function: 676)

[Bluetooth]

[Bluetooth] (→ Connecting to a Smartphone (Bluetooth Connection): 615)
[Send Image (Smartphone)] (→ [Smartphone]: 651)
[Remote Wakeup] (→ [Remote Wakeup]: 644)
[Returning from Sleep Mode] (→ Shortening the Return Time from [Sleep Mode]: 636)
[Auto Transfer] (→ [Auto Transfer]: 639)
[Location Logging] (→ [Location Logging]: 642)
[Auto Clock Set] (→ [Auto Clock Set]: 645)
[Wi-Fi network settings]
[Wi-Fi network settings]: Registers the Wi-Fi access point. Wireless access points used to connect the camera to Wi-Fi networks will be registered automatically.

[USB]

[USB Mode]	 [Select on connection]/  [PC(Storage)]/  [PC(Tether)]/  [PictBridge(PTP)]
<p>This sets the communication method to be used when the USB connection cable is connected.</p> <p> [Select on connection]: Select this setting to select the USB communication system when connecting to another device.</p> <p> [PC(Storage)]: Select this setting to export images to a connected PC.</p> <p> [PC(Tether)]: Select this setting to control the camera from a PC installed with "LUMIX Tether".</p> <p> [PictBridge(PTP)]: Select this setting when connecting to a printer that supports PictBridge.</p>	

[USB Power Supply]	▶[ON]/[OFF]
<p>Provides power from the USB connection cable.</p> <ul style="list-style-type: none"> • Even if this item is set to [OFF], power will be supplied when the AC adaptor is connected. 	

[Battery Use Priority]

[BODY]/▶[BG]
<p>Selects which battery to use first when the batteries are installed in both the camera and the Battery Grip.</p>

[HDMI Connection]

[Output Resolution(Playback)]	▶[AUTO] / [C4K/60p] / [C4K/50p] / [C4K/30p] / [C4K/25p] / [C4K/24p] / [4K/60p] / [4K/50p] / [4K/30p] / [4K/25p] / [4K/24p] / [1080p] / [1080i] / [720p] / [576p] / [480p]
<p>Sets the HDMI output resolution for playback.</p> <p>[AUTO]: Outputs with a resolution suited to the connected external device.</p> <ul style="list-style-type: none"> • The items you can select depend on the [System Frequency] setting. • If no image appears on the external device with [AUTO], switch to a constant setting other than [AUTO] to set a format supported by your external device. (Refer to the operating instructions for the external device.) 	
[LUT View Assist (HDMI)]	[ON]/▶[OFF]
<p>Images with LUT (Look-Up Table) data applied are output when you play back videos recorded with [Photo Style] set to [V-Log L].</p> <ul style="list-style-type: none"> • This is linked with [LUT View Assist (HDMI)] in [V-LogL View Assist] under the [Custom] ([Monitor / Display (Video)]) menu. (→[V-LogL View Assist]: 398) 	

[HLG View Assist (HDMI)]	▶[AUTO]/[MODE1]/[MODE2]/[OFF]
<p>At recording or playback of HLG video, this converts their color gamut and brightness for display.</p> <ul style="list-style-type: none"> • This is linked with [HDMI] in [HLG View Assist] under the [Custom] ([Monitor / Display (Video)]) menu. (→[HLG View Assist]: 404) 	
[VIERA Link (CEC)]	[ON]/▶[OFF]
<p>You can use the device remote control to operate the camera when it is connected to a VIERA Link compatible device using an HDMI cable.</p> <p>(→Using VIERA Link: 692)</p>	
[Background Color(Playback)]	[■]/▶[■]
<p>Sets the color of the bands displayed on the top and bottom or the left and right of images output on an external device or similar display.</p> <ul style="list-style-type: none"> • We recommend setting to [■] to prevent burn-in on the screen of the output destination. 	
[Photo Luminance Level]	[0-255]/▶[16-255]
<p>Sets the level of luminance when outputting pictures to external devices, etc.</p>	

[Power/Network Indicator]

▶[ON]/[OFF]
This will light up the status indicator and NETWORK connection lamp.

[Setup] menu ([Setting])

[Save to Custom Mode]

[C1]/[C2]/[C3]/[C4-1] to [C4-10]

You can register the currently set information of the camera.

(→ [Register in Custom Mode: 498](#))

[Load Custom Mode]

[C1]/[C2]/[C3]/[C4-1] to [C4-10]

Calls up registered Custom mode settings to the selected recording mode and overwrites the current settings with called up settings.

(→ [Calling Up Settings: 502](#))

[Custom Mode Settings]

[Limit No. of Custom Mode]

[Edit Title]

[How to Reload Custom Mode]

[Select Loading Details]

Sets the ease of use of Custom mode.

(→ [Custom Mode Detailed Settings: 500](#))

[Save/Restore Camera Setting]

[Save]/[Load]/[Delete]/[Keep Settings While Format]

Saves the camera's settings information to the card.
Saved settings information can be loaded to the camera, letting you set the same settings on multiple cameras.

(→ [\[Save/Restore Camera Setting\]: 505](#))

[Reset]

Returns the camera to its default settings.

(→ [\[Reset\]: 100](#))

[Setup] menu ([Others])



[Clock Set]

Sets the date and time.

(→ Clock Set: 70)

[Time Zone]

Sets the time zone.

1 Press ◀▶ to select the time zone and then press  or  to confirm.

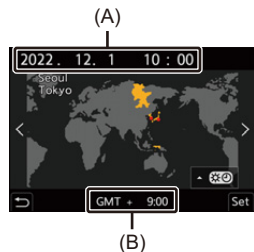

(A) Current time

(B) Time difference from GMT (Greenwich Mean Time)

- If you are using Daylight Savings [], press ▲. (The time will move forward by 1 hour.)

To return to the normal time, press ▲ again.

[System Frequency]

[59.94Hz (NTSC)]/[50.00Hz (PAL)]/[24.00Hz (CINEMA)]

* Default setting specifications vary depending on the country or area where the camera was purchased.

This changes the system frequency of videos that are recorded and played back.

(→[System Frequency]: 336)

[Pixel Refresh]

This optimizes the image sensor and image processing.

- The image sensor and image processing are optimized when the camera is purchased. Use this function when bright spots that do not exist in the subject get recorded.
- Turn the camera off and on after the pixels are corrected.

[Sensor Cleaning]

Dust reduction to blow off the debris and dust that have affixed to the front of the image sensor is performed.

- You can use this function when the dust is particularly noticeable.
- Turn the camera off and on after cleaning.

[Language]

This set the language displayed on the screen.

- If you set a different language by mistake, select [] from the menu icons to set the desired language.



[Firmware Version]

[Firmware Update]/[Software info]

You can check the firmware versions of the camera and lens.

In addition, you can update the firmware, and display information about the camera software.

[Firmware Update]: Updates firmware.

- 1 Download the firmware. (→ [Firmware of Your Camera/Lens: 19](#))
- 2 Save the firmware to the root directory of the card (the first folder that appears when you access the card on your PC), and then insert the card into the camera.
- 3 Select [Firmware Update], press  or , and then select [Yes] to update the firmware.

[Software info]: Displays information about the camera software.

- When a supported optional item (XLR Microphone Adaptor, etc.) is attached to the camera, you can also check its firmware version.

[Online Manual]

[URL display]/[QR Code display]

Displays the URL or QR code in order to browse the “Owner’s Manual <Complete Guide>”.

[Approved Regulations]

Displays the certification number for radio regulations.

[Playback] Menu

- How to Select an Image(s) in the [Playback] menu: 597
- [Playback] menu ([Playback Mode]): 599
- [Playback] menu ([Process Image]): 602
- [Playback] menu ([Add/Delete Info.]): 604
- [Playback] menu ([Edit Image]): 605
- [Playback] menu ([Others]): 608

How to Select an Image(s) in the [Playback] menu

Follow the steps below when the image selection screen is displayed.

- Images are displayed separately by card slot.
 - To switch the card to display, press [**▶◀**] and select the card slot.
- You can only select/edit images on one card at a time.

❖ When [Single] has been selected

- 1 Press **◀▶** to select the image.

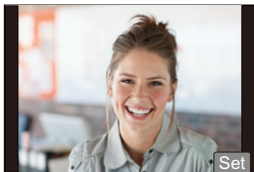

- 2 Press **MENU/SET** or **⏪**.
 - If [Set/Cancel] is displayed at the right bottom of the screen, the setting is canceled when **MENU/SET** or **⏪** is pressed again.

❖ When [Multi] has been selected

- 1 Press **▲▼◀▶** to select the image and then press **MENU/SET** or **OK** (repeat).
 - The setting is canceled when **MENU/SET** or **OK** is pressed again.
- 2 Press **[DISP.]** to execute.

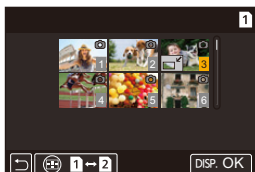

When [Protect] is selected

- 1 Press **▲▼◀▶** to select the image, and then press **MENU/SET** or **OK** to set (repeat).
 - The setting is canceled when **MENU/SET** or **OK** is pressed again.

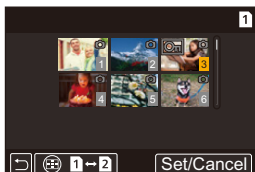

[Playback] menu ([Playback Mode])

▶: Default settings

[Playback Mode]

▶[Normal Play]/[Picture Only]/[Video Only]/[Rating]/[6K/4K PHOTO]/[Post-Focus]

Filters the type of images to play back.

- When you have set [Rating], put a check mark in the rating level you want to display, then press [DISP.].

[Slide Show]

[All]/[Picture Only]/[Video Only]/[Rating]/[6K/4K PHOTO]/[Post-Focus]

Selects image types and plays them back at regular intervals in order.

- When you have set [Rating], put a check mark in the rating level you want to display, then press [DISP.].

[Start]: Starts slide show playback.

[Duration]: Sets repeat playback.

[Repeat]: Sets repeat playback.

Operations during slide show

▲: Plays/pauses (You can also perform the same operation by touching [▶] or [⏸])

◀: Move to the previous image

▶: Move to the next image

▼: Ends the slide show

⊙: Adjusts the volume (You can also perform the same operation by touching [−] or [+])

- When [Video Only] is set, [Duration] is not available.

[Rotate Disp.]

▶[ON]/[OFF]

Automatically displays pictures vertically if they were recorded when holding the camera vertically.

[Picture Sort]

[FILE NAME]▶[DATE/TIME]

This sets the order in which the camera displays images during playback.

[FILE NAME]: Displays images by folder name/file name.

[DATE/TIME]: Displays images by recording date.

- If you insert another card, it may take some time to read all data, therefore pictures may not be displayed in the set order.

[Magnify from AF Point]

[ON]▶[OFF]

Displays the point focused with AF.

Enlarges the AF focus location when enlarging the image.

[LUT View Assist (Monitor)]

[ON]▶[OFF]

When playing back video recorded with [Photo Style] set to [V-Log L], this displays the images with LUT data applied on the monitor/viewfinder.

- This functions in tandem with [LUT View Assist (Monitor)] in [V-LogL View Assist] in the [Custom] ([Monitor / Display (Video)]) menu. (→ [\[LUT View Assist \(Monitor\): 398\]](#))

[HLG View Assist (Monitor)]

[MODE1]▶[MODE2]/[OFF]

At recording or playback of HLG video, this converts their color gamut and brightness for display.

- This functions in tandem with [Monitor] in [HLG View Assist] in the [Custom] ([Monitor / Display (Video)]) menu. (→ [\[HLG View Assist\]: 404](#))

[Anamorphic Desqueeze Display][\leftarrow 2.0x \rightarrow]/[\leftarrow 1.8x \rightarrow]/[\leftarrow 1.5x \rightarrow]/[\leftarrow 1.33x \rightarrow]/[\leftarrow 1.30x \rightarrow]/▶[OFF]

This displays the de-squeezed images suited to the magnification of the anamorphic lens on this camera. (→ [\[Anamorphic Desqueeze Display\]: 407](#))

- This is linked with [Anamorphic Desqueeze Display] under the [Custom] ([Monitor / Display (Video)]) menu.

[Playback] menu ([Process Image])

▶: Default settings

[RAW Processing]

Processes pictures taken in RAW format on the camera and saves them in JPEG format.

(→ [\[RAW Processing\]: 460](#))

[6K/4K PHOTO Bulk Saving]

You can save any 5 second period of pictures from a 6K/4K burst file all at once.

(→ [\[6K/4K PHOTO Bulk Saving\]: 206](#))

[6K/4K PHOTO Noise Reduction]



▶[AUTO]/[OFF]

When saving pictures, reduce the noise that occurs due to high ISO sensitivity.

(→ [Reducing Noise Caused by High Sensitivity \(\[6K/4K PHOTO Noise Reduction\]\): 201](#))



[Time Lapse Video]

This creates videos from group images recorded with [Time Lapse Shot]. (→ [Time Lapse Shot/Stop Motion Animation Videos: 225](#))

- 1 Press ◀▶ to select a [Time Lapse Shot] group and then press  or .
- 2 Select the options for creating a video to combine the pictures into a video.
 - When [System Frequency] is set to [24.00Hz (CINEMA)], [Time Lapse Video] is not available.

[Stop Motion Video]

This creates videos from group images recorded with [Stop Motion Animation]. (→ [Time Lapse Shot/Stop Motion Animation Videos: 225](#))

- 1 Press ◀▶ to select the Stop Motion Animation group and then press  or .
- 2 Select the options for creating a video to combine the pictures into a video.
 - When [System Frequency] is set to [24.00Hz (CINEMA)], [Stop Motion Video] is not available.

[Playback] menu ([Add/Delete Info.]

[Protect]

[Single]/[Multi]/[Cancel]



You can set protection for images so that they will not be deleted by mistake. However, if you format the card, the protected images will also be deleted.

- For information about how to select images (→ [How to Select an Image\(s\) in the \[Playback\] menu: 597](#))
- Be careful because the [Protect] setting may be disabled on a device other than this camera.

[Rating]

[Single]/[Multi]/[Cancel]

If you set any of the five different rating levels for images, you can do the following:

- Deleting all images except for those with ratings.
 - Play back or show a slide show of images by the rating level.
 - Check the rating level in the file details display in operating systems such as Windows 10, Windows 8.1, and Windows 8. (JPEG images only)
- 1 Select an image. (→ [How to Select an Image\(s\) in the \[Playback\] menu: 597](#))
 - 2 Press ◀▶ to select a rating level (1 to 5) and then press  or .
 - When [Multi] is selected, repeat Steps 1 and 2.
 - To cancel the setting, set the rating level to [OFF].





[Playback] menu ([Edit Image])

▶: Default settings

[Resize]

[Single]/[Multi]

Reduce the picture size of JPEG images and save them as different images to enable them to be easily used for web pages or sent as email attachments.

- For information about how to select images (→ [How to Select an Image\(s\) in the \[Playback\] menu: 597](#))
 - When [Single] is selected, after choosing the image, press ▲▼ to select the size, then press  or .
 - When [Multi] is selected, before choosing the images, press ▲▼ to select the size, then press  or .
- You can set up to 100 images at once with [Multi].
- The image quality of the resized image becomes lower.
- [Resize] is not available for images recorded using the following functions:
 - Video recording/[6K/4K PHOTO]/[Post-Focus]
 - Group images
 - [RAW] ([Picture Quality])
 - Pictures created from [C4K] video

[Rotate]

Rotate images manually in 90° steps.

[]: Rotates 90° clockwise.



[]: Rotates 90° counter-clockwise.

[Video Divide]

Divide a recorded video or 6K/4K burst file into two.

(→ [\[Video Divide\]: 467](#))

[Copy]

[Copy Direction]	▶[1→2]/[2→1]
[Select Copy]/[Copy All in Folder]/[Copy All in Card]	
<p>You can copy the images in one of the cards to the other card.</p> <ul style="list-style-type: none"> • Copied images will be saved in a new folder. <p>[Select Copy]: Copies selected images.</p> <ol style="list-style-type: none"> 1 Select the folder containing the images to copy. 2 Select the images. (→How to Select an Image(s) in the [Playback] menu: 597) <p>[Copy All in Folder]: Copies all images in a folder.</p> <ol style="list-style-type: none"> 1 Select the folder to copy. 2 Check the images to be copied and then press  or  to execute copying. <p>[Copy All in Card]: Copies all images in the card.</p> <p>Using the Fn button to copy images</p> <p>If you press the Fn button with [Copy] assigned while playing back one image at a time, the image currently being played back will be copied to the other card. Select the copy destination folder from the following options. In the case of group images, [Create a New Folder] is selected automatically.</p> <p>[Same Folder Number as Source]: Copies to a folder with the same name as the folder of the image to be copied.</p> <p>[Create a New Folder]: Creates a new folder with an incremented folder number and then copies the image to it.</p> <p>[Select Folder]: Selects a folder to store the image and then copies the image to it.</p> <ul style="list-style-type: none"> • You can set up to 100 images at once with [Select Copy]. • The [Protect] setting is not copied. • Copying may take a while. • When using the following combinations of cards, videos, 6K/4K photos, and images recorded with [Post-Focus] cannot be copied: <ul style="list-style-type: none"> – Copying from an SDXC memory card to an SD memory card or SDHC memory card 	

[Playback] menu ([Others])

▶: Default settings

[Delete Confirmation]

["Yes" first]/▶["No" first]

This sets which option, [Yes] or [No], will be highlighted first when the confirmation screen for deleting an image is displayed.

["Yes" first]: [Yes] is highlighted first.

["No" first]: [No] is highlighted first.

[Delete All Images]

[Card Slot 1]/[Card Slot 2]









Deletes all images in a card.

- Images cannot be restored once they have been deleted. Carefully confirm the images before deletion.
- If you select [Delete All Non-rating], all images except those with a rating set are deleted.
- [Delete All Images] can be used when [Playback Mode] is set to [Normal Play].

Entering Characters



Follow the steps below when the character entry screen is displayed.

1 Enter characters.

- Press ▲▼◀▶ to select characters and then press  or  until the character to enter is displayed. (Repeat this)
- To repeatedly enter the same character, rotate  or  to the right to move the entry position cursor.
- If you select an item and press  or , you can perform the following operations:
 - []: Change the character type to [A] (upper case characters), [a] (lower case characters), [1] (numbers), and [&] (special characters)
 - []: Enter a blank
 - [Delete]: Delete a character
 - [<]: Move the entry position cursor to the left
 - [>]: Move the entry position cursor to the right
- When entering a password, (A) shows the number of characters you have entered and the number of characters you can enter.



2 Complete entering.

- Select [Set] and then press  or .

15. Wi-Fi/Bluetooth

- [Connecting to a Smartphone: 612](#)
- [Operating the Camera with a Smartphone: 629](#)
- [Sending Images from the Camera: 647](#)
- [Wi-Fi Connections: 661](#)
- [Send Settings and Selecting Images: 671](#)
- [\[Wi-Fi Setup\] Menu: 674](#)

This chapter explains the Wi-Fi[®] and Bluetooth[®] functions of the camera.

Remote Operations from a Smartphone



You can use the “LUMIX Sync” smartphone app for remote recording and image transfers.

(→ [Connecting to a Smartphone: 612](#))

Transferring Images from This Camera



You can transfer images to another device, such as a smartphone or PC, by operating the camera.



(→ [Sending Images from the Camera: 647](#))

This document refers to both smartphones and tablets as **smartphones**.

❖ Checking operation of the Wi-Fi and Bluetooth functions

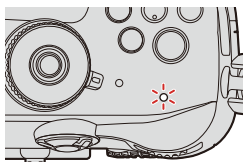
NETWORK connection lamp



Light (blue)	Monitor	Operation
Lit		The Wi-Fi function is set to on, or there is a connection.
		The Bluetooth function is set to on, or there is a connection.
Blinking		When image data is sent using a camera operation.

- Do not remove the card or battery or move to an area without any reception while sending images.
- The camera cannot be used to connect to a public wireless LAN connection.
- We strongly recommend that you set an encryption to maintain information security.
- We recommend that you use a sufficiently charged battery when sending images.
- When the remaining battery level is low, it may not be possible to connect to or maintain communication with other devices.
(A message such as [Communication error] is displayed.)
- Images may not be completely sent depending on radio wave conditions.
If the connection is terminated while sending images, images with missing parts may be sent.

Connecting to a Smartphone

- [Flow of connecting a smartphone: 612](#)
- [Installing “LUMIX Sync”: 614](#)
- [Connecting to a Smartphone \(Bluetooth Connection\): 615](#)
- [Connecting to a Smartphone \(\[Wi-Fi connection\]\): 622](#)

Connect with a smartphone which has the “Panasonic LUMIX Sync” (below: “LUMIX Sync”) smartphone app installed.

Use “LUMIX Sync” for remote recording and image transfers.

Flow of connecting a smartphone

- 1 Install “LUMIX Sync” on your smartphone. (→ [Installing “LUMIX Sync”: 614](#))**
- 2 Connect to a smartphone.**
 - Using a smartphone that supports Bluetooth Low Energy (→ [Connecting to a Smartphone \(Bluetooth Connection\): 615](#))
 - Using a smartphone that does not support Bluetooth Low Energy (→ [Connecting to a Smartphone \(\[Wi-Fi connection\]\): 622](#))

3 Operate the camera using the smartphone. (→ [Operating the Camera with a Smartphone: 629](#))

- [\[Remote shooting\]: 631](#)
 - [\[Shutter Remote Control\]: 634](#)
 - [\[Import images\]: 637](#)
 - [\[Auto Transfer\]: 639](#)
 - [\[Location Logging\]: 642](#)
 - [\[Remote Wakeup\]: 644](#)
 - [\[Auto Clock Set\]: 645](#)
 - [\[Camera settings copy\]: 646](#)
- You can also use the camera to transfer images to a smartphone.
(→ [Sending Images from the Camera: 647](#))

Installing “LUMIX Sync”

“LUMIX Sync” is an application for smartphones provided by Panasonic.

Supported OS

Android™: Android 7 or higher

iOS: iOS 12 or higher

- 1 Connect the smartphone to a network.**
- 2 (Android) Select “Google Play™ Store”.**
(iOS) Select “App Store”.
- 3 Enter “LUMIX” or “panasonic lumix sync” into the search box.**
- 4 Select and install the “Panasonic LUMIX Sync”** 

- Use the latest version.
 - Supported OSs are current as of May 2021 and are subject to change.
 - Read the [Help] in the “LUMIX Sync” menu for further details on how to operate.
 - The app may not operate correctly depending on your smartphone.
- For information on the “LUMIX Sync”, refer to the following support site:
<https://panasonic.jp/support/global/cs/dsc/>
(English only)

Connecting to a Smartphone (Bluetooth Connection)

Follow a simple connection setup procedure (pairing) to connect to a smartphone that supports Bluetooth Low Energy.

When pairing is set up, the Wi-Fi connection will be established automatically by just operating “LUMIX Sync”.

- For the first-time connection, pairing settings are required.

For information about connecting for the second and subsequent times

(→ [Connecting to a Paired Smartphone: 620](#))

- Supported smartphones

Android™: Android 7 or higher with Bluetooth 4.0 or higher (excluding those that do not support Bluetooth Low Energy)

iOS: iOS 12 or higher

- **Turn on the smartphone's Bluetooth function in advance.**

1 On the smartphone, start up “LUMIX Sync”.

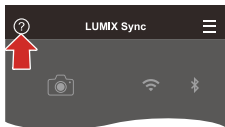
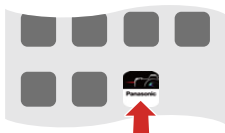

- A message regarding device (camera) registration is displayed. Select [Next].
- If you have closed the message, select [?], then register the camera using [Camera registration (pairing)].



2 Check the content in the displayed guide and select [Next] until the screen to register the camera is displayed.

Operating the camera in accordance with the smartphone guide.

3 Set the camera to Bluetooth pairing standby state.

-  ⇒ [] ⇒ [] ⇒ [Bluetooth] ⇒ [Bluetooth] ⇒ [SET] ⇒ [Pairing]
- The camera enters pairing standby state and the device name (A) is displayed.

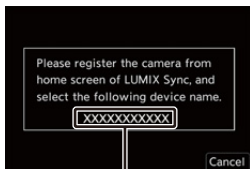

(A)

4 On the smartphone, select the camera's device name.

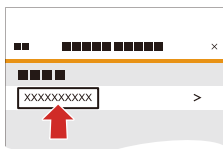

- (iOS devices) When a message to confirm the change of destination is displayed, select [Join].



5 When a message indicating that device registration is complete, select [OK].

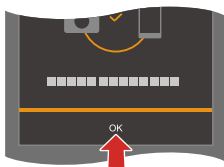

- A Bluetooth connection between the camera and the smartphone will be made.



- The paired smartphone is registered as a paired device.
- During Bluetooth connection, [] is displayed in the recording screen. When the Bluetooth function is enabled, but a connection is not established with the smartphone, [] appears translucent.
- Up to 16 smartphones can be registered. If you try to register more than 16 smartphones, the registration information will be deleted from the oldest first.



❖ Wi-Fi connection with a Bluetooth connected smartphone

You can establish Wi-Fi connection by operating “LUMIX Sync”.

- 1 Select [] ([Remote shooting]) or [] ([Import images]) in the “LUMIX Sync” home screen.

❖ End Bluetooth Connection

To terminate the Bluetooth connection, turn off the Bluetooth function of the camera.

 ⇒ [] ⇒ [] ⇒ [Bluetooth] ⇒ [Bluetooth] ⇒ Select [OFF]

- Even if you terminate the connection, the pairing information for it will not be deleted.

❖ Connecting to a Paired Smartphone

Connect paired smartphones using the following procedure.

- 1 Enable the Bluetooth function of the camera.
 - MENU SET ⇒ [] ⇒ [] ⇒ [Bluetooth] ⇒ [Bluetooth] ⇒ [ON]
- 2 On the smartphone, start up “LUMIX Sync”.
 - If a message is displayed indicating that the smartphone is searching for cameras, close the message.
- 3 Select [≡].

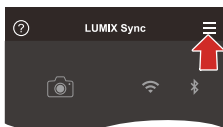

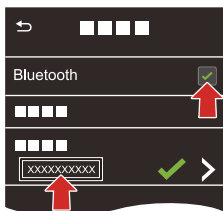

- 4 Select [Bluetooth Setup].
- 5 Turn Bluetooth ON.



- 6 From [Camera registered] items, select the camera's device name.

- Even if you set up pairing with more than one smartphone, you can only connect to one smartphone at a time.
- When pairing takes some time, canceling the pairing settings on both the smartphone and camera and re-establishing the connection may result in the camera being detected correctly.

❖ Canceling Pairing

- 1 Cancel the pairing setting of the camera.
 -  ⇒ [] ⇒ [] ⇒ [Bluetooth] ⇒ [Bluetooth] ⇒ [SET] ⇒ [Delete]
- 2 Select the smartphone for which to cancel the pairing.

- Also cancel the pairing setting on the smartphone.
- When [Reset] in the [Setup] ([Setting]) menu is used to reset the network settings, the information for registered devices is deleted.



Connecting to a Smartphone ([Wi-Fi connection])

Use Wi-Fi to connect the camera and a smartphone.

With default settings, simple connection with smartphones is possible without entering a password.

You can also use password authentication for enhanced connection security.

1 Set the camera to Wi-Fi connection standby status.

-  ⇒ [] ⇒ [] ⇒ [Wi-Fi] ⇒ [Wi-Fi Function] ⇒ [New Connection] ⇒ [Control With Smartphone]
- The SSID (A) of the camera is displayed on the screen.
- You can also perform the same operation by pressing the Fn button assigned with [Wi-Fi].

(⇒ [Fn Buttons: 471](#))



- 2 In the setting menu of the smartphone, turn the Wi-Fi function ON.**
- 3 Select the SSID displayed on the camera.**

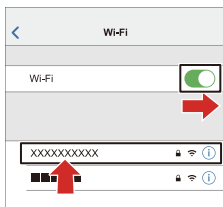

- 4 On the smartphone, start up “LUMIX Sync”.**

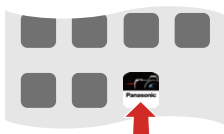

- 5 (At the first connection) Confirm the device name displayed on the camera and then select [Yes].**











- When a device different than the one you want to connect to is displayed, the camera will automatically connect to that device if you select [Yes].
If there are other Wi-Fi connection devices nearby, we recommend using either QR code or manual password input to connect with password authentication.
(→ [Using Password Authentication to Connect: 624](#))
- When the following functions are being used, [Wi-Fi Function] is not available:
 - [Streaming Function]
 - [Auto Transfer]

❖ Using Password Authentication to Connect

You can enhance Wi-Fi connection security by using password authentication through either QR code or manual input.

Scanning QR code to connect

- 1 Set [Wi-Fi Password] on the camera to [ON].
 -  ⇒ [] ⇒ [] ⇒ [Wi-Fi] ⇒ [Wi-Fi Setup] ⇒ [Wi-Fi Password] ⇒ [ON]
- 2 Display the QR code (A).
 -  ⇒ [] ⇒ [] ⇒ [Wi-Fi] ⇒ [Wi-Fi Function] ⇒ [New Connection] ⇒ [Control With Smartphone]
 - You can also perform the same operation by pressing the Fn button assigned with [Wi-Fi]. (→ [Fn Buttons: 471](#))
 - Press  or  to enlarge the QR code.



- 3 On the smartphone, start up “LUMIX Sync”.
 - If a message is displayed indicating that the smartphone is searching for cameras, close the message.
- 4 Select [].
- 5 Select [Wi-Fi connection].
- 6 Select [QR code].
- 7 Scan the QR code displayed on the screen of the camera using “LUMIX Sync”.
 - (iOS devices) When a message to confirm the change of destination is displayed, select [Join].
- 8 (At the first connection) Confirm the device name displayed on the screen of the camera and then select [Yes].



Manually entering a password to connect

- 1 Display the screen in Step 2 (→ [Scanning QR code to connect: 624](#)).
- 2 In the setting menu of the smartphone, turn the Wi-Fi function ON.

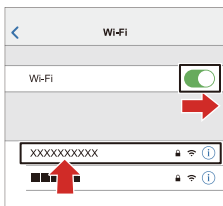

- 3 On the Wi-Fi setup screen, select the SSID (B) displayed on the camera.

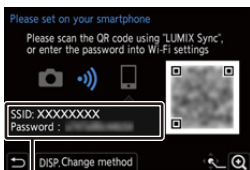



(B)

- 4 (At the first connection) Enter the password (B) displayed on the camera.
- 5 On the smartphone, start up "LUMIX Sync".
- 6 (At the first connection) Confirm the device name displayed on the screen of the camera and then select [Yes].



❖ Connection Methods Other Than the Default Settings



When connecting with [Via Network], or [WPS Connection] in [Direct], follow the steps below:

- 1 Display the connection method setting screen for the camera.
 -  ⇒ [] ⇒ [] ⇒ [Wi-Fi] ⇒ [Wi-Fi Function] ⇒ [New Connection] ⇒ [Control With Smartphone]
- 2 Press [DISP.].

Connecting via network

- 1 Select [Via Network] and then press  or  .
 - Connect the camera to a wireless access point. (⇒ [\[Via Network\]: 662](#))
- 2 In the setting menu of the smartphone, turn the Wi-Fi function ON.
- 3 Connect the smartphone to the wireless access point that the camera is connected to.
- 4 On the smartphone, start up “LUMIX Sync”.

Connecting directly



- 1 Select [Direct] and then press  or  .
 - Select [WPS Connection] to connect the camera to a smartphone. (⇒ [\[Direct\]: 666](#))
- 2 On the smartphone, start up “LUMIX Sync”.

❖ Terminating the Wi-Fi Connection

To end the Wi-Fi connection between the camera and smartphone, follow the steps below.

1 Press the shutter button halfway to put the camera in recording mode.

2 Terminate the Wi-Fi connection.

-  → [] → [] → [Wi-Fi] → [Wi-Fi Function] → [Yes]
- You can also perform the same operation by pressing the Fn button assigned with [Wi-Fi]. (→ [Fn Button Assigned with \[Wi-Fi\]: 650](#))

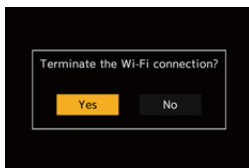

3 On the smartphone, close the “LUMIX Sync”.

Operating the Camera with a Smartphone

- [Remote shooting]: 631
- [Shutter Remote Control]: 634
- [Import images]: 637
- [Auto Transfer]: 639
- [Location Logging]: 642
- [Remote Wakeup]: 644
- [Auto Clock Set]: 645
- [Camera settings copy]: 646

This explains the functions for operating the camera from a smartphone. Functions described in this document with the (**Bluetooth**) symbol require a Bluetooth connection by a smartphone that supports Bluetooth Low Energy.

❖ Home Screen

When you start up “LUMIX Sync”, the home screen is displayed.

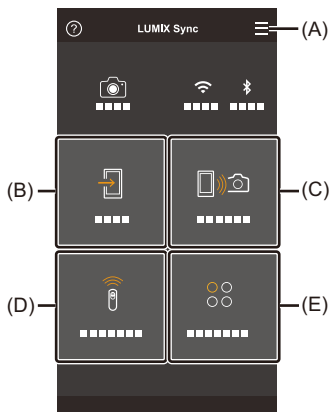

(A) : App settings

This allows connection settings, camera ON/OFF operations, and displays Help.

(B) : [Import images] (→[\[Import images\]: 637](#))

(C) : [Remote shooting] (→[\[Remote shooting\]: 631](#))

(D) : [Shutter Remote Control] (→[\[Shutter Remote Control\]: 634](#))

(E) : [Others] (Camera settings copy/live streaming) (→[\[Camera settings copy\]: 646](#), [16. Streaming Function: 676](#))

[Remote shooting]

You can use the smartphone to record from a remote location while viewing the live view images from the camera.



Getting started:

- Connect the camera to a smartphone. (→ [Connecting to a Smartphone: 612](#))
- On the smartphone, start up “LUMIX Sync”.

1 Select ([Remote shooting]) in the home screen.

- (iOS devices) When a message to confirm the change of destination is displayed, select [Join].

2 Start recording.

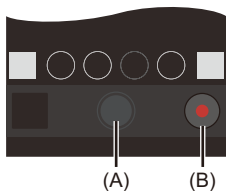

(A) Takes a picture



(B) Starts/ends the video recording



- The recorded image is saved on the camera.

• Certain features, including some settings, may not be available.

❖ Operation Method During Remote Recording

Set either the camera or the smartphone as the priority control device to be used during remote recording.

 → [] → [] → [Wi-Fi] → [Wi-Fi Setup] → Select [Priority of Remote Device]

 [Camera]	<p>Operation is possible on both the camera and the smartphone.</p> <ul style="list-style-type: none"> • The camera's dial settings, etc. cannot be changed with the smartphone.
 [Smartphone]	<p>Operation is possible only on the smartphone.</p> <ul style="list-style-type: none"> • The camera's dial settings, etc. can be changed with the smartphone. • To end remote recording, press any of the buttons on the camera to turn on the screen, and select [End].

- The default setting is [Camera].

- The setting of this function cannot be changed while the connection is active.

[Shutter Remote Control]

Bluetooth

You can use the smartphone as a remote control for the shutter.

Getting started:

- Connect the camera to a smartphone. (→ [Connecting to a Smartphone: 612](#))
- On the smartphone, start up "LUMIX Sync".

1 Select [] ([Shutter Remote Control]) in the home screen.

2 Start recording.



Starts/ends the video recording







Takes a picture

❖ Bulb Recording

The shutter can be kept open from the start to end of recording, which is useful for recording of starry skies or night scenery.

Getting started:

- Set the camera to [M] mode. (→ [Manual Exposure Mode: 263](#))
- Set the camera shutter speed to [B] (Bulb). (→ [\[B\] \(Bulb\): 266](#))

- 1 Touch [] to start recording (keep touching, without removing your finger).
- 2 Remove your finger from [] to end recording.
 - Slide [] in the direction of [LOCK] to record with the shutter button locked in a fully-pressed state.
(Slide [] back to its original position or press the camera shutter button to end recording)
 - During [B] (Bulb) recording, if the Bluetooth connection is broken, then carry out Bluetooth connection again, then end recording from the smartphone.



❖ Shortening the Return Time from [Sleep Mode]

You can shorten the time it takes for the camera to return from [Sleep Mode] when the [Shutter Remote Control] is used.

Getting started:

- Connect the camera to a smartphone by Bluetooth. (→ [Connecting to a Smartphone \(Bluetooth Connection\): 615](#))
- Set [Remote Wakeup] in [Bluetooth] to [ON].

 ⇒ [] ⇒ [] ⇒ [Bluetooth] ⇒ Select [Returning from Sleep Mode]

	[Import / Remote Priority]	Shortens the time to return when using [Import images] or [Remote shooting].
	[Remote Shutter Priority]	Shortens the time to return when using [Shutter Remote Control].

- To use the [Shutter Remote Control] to cancel [Sleep Mode] on the camera, set [Bluetooth] in the [Setup] ([IN/OUT]) menu as follows, then connect via Bluetooth:
 - [Remote Wakeup]: [ON] (→ [Remote Wakeup: 644](#))
 - [Auto Transfer]: [OFF] (→ [Auto Transfer: 639](#))
- The camera cannot be turned on by using [Shutter Remote Control].

[Import images]

Transfer an image stored on the card to the smartphone.

Getting started:

- Connect the camera to a smartphone. (→ [Connecting to a Smartphone: 612](#))
- On the smartphone, start up “LUMIX Sync”.

1 Select [] ([Import images]) in the home screen.

- (iOS devices) When a message to confirm the change of destination is displayed, select [Join].

2 Select the image to transfer.

- You can switch the card displayed by touching (A).

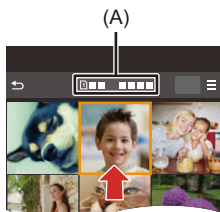

3 Transfer the image.

- Select [➔].
- If the image is a video, you can play it back by touching [▶] at the center of the screen.

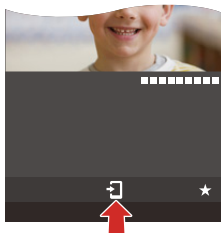

- When a video is played back, this has a small data size and is transmitted using “LUMIX Sync”, therefore its image quality will differ from that of the actual video recording.

Depending on the smartphone and on the usage conditions, the image quality may deteriorate or the sound may skip during video or picture playback.

- It is not possible to transfer images with file sizes exceeding 4 GB.
- Images recorded using the following functions cannot be transferred:
 - [MOV] videos
 - [6K/4K PHOTO]/[Post-Focus]

[Auto Transfer]



Bluetooth

You can automatically transfer recorded pictures to a smartphone as they are taken.

Getting started:

- Connect the camera to a smartphone by Bluetooth. (→ [Connecting to a Smartphone \(Bluetooth Connection\): 615](#))

1 Enable [Auto Transfer] on the camera.

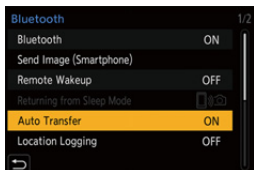

-  → [] → [] → [Bluetooth] → [Auto Transfer] → [ON]
- If a confirmation screen is displayed on the camera asking you to terminate the Wi-Fi connection, select [Yes] to terminate it.



2 On the smartphone, select [Yes] (for Android devices) or [Join] (for iOS devices).

- The camera automatically makes a Wi-Fi connection.

3 Check the send settings on the camera and then press

 or .

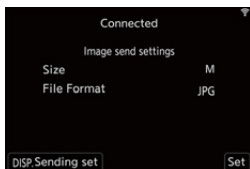

- To change the send setting, press [DISP.]. (→ [Image Send Settings: 671](#))
- Automatic image transfer is possible when [] is displayed on the camera recording screen.



4 Record with the camera.

- [] is displayed in the recording screen of the camera while a file is being sent.

❖ To Stop the Automatic Transfer of Images

 ⇒ [] ⇒ [] ⇒ [Bluetooth] ⇒ [Auto Transfer] ⇒ Select [OFF]

- A confirmation screen is displayed, asking you to terminate the Wi-Fi connection.

- If the [Bluetooth] and [Auto Transfer] settings of the camera are [ON], the camera automatically connects to the smartphone via Bluetooth and Wi-Fi when you turn on the camera.

Start up the “LUMIX Sync” on the smartphone to connect to the camera.

- When [Auto Transfer] is set to [ON], [Wi-Fi Function] cannot be used.
- If the camera is turned off during image transfer, and the file sending is interrupted, then turn on the camera to restart the sending.
 - If the storage status of unsent files changes, then sending of files may no longer be possible.
 - If there are many unsent files, then sending of all files may not be possible.
- Images recorded with the following functions cannot be transferred automatically:
 - Video recording/[6K/4K PHOTO]/[Post-Focus]

[Location Logging]



Bluetooth

The smartphone sends its location information to the camera via Bluetooth, and the camera performs recording while writing the acquired location information.

Getting started:

- Enable the GPS function on the smartphone.
- Connect the camera to a smartphone by Bluetooth. (→ [Connecting to a Smartphone \(Bluetooth Connection\): 615](#))

1 Enable [Location Logging] on the camera.

-  ⇒ [] ⇒ [] ⇒ [Bluetooth] ⇒ [Location Logging] ⇒ [ON]
- The camera will enter a mode where location information can be recorded and [GPS] is displayed in the recording screen of the camera.

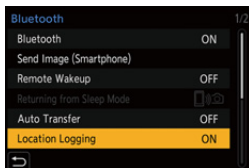

2 Record images with the camera.

- Location information will be written to the recorded images.



- When [GPS] on the recording screen appears translucent, location information cannot be acquired, therefore data cannot be written.
Smartphone GPS positioning may not be possible if the smartphone is within a building, a bag, or similar. Move the smartphone to a position affording a wide view of the sky to improve positioning performance.
In addition, refer to the operating instructions of your smartphone.
- Images with location information are indicated with [GPS].
- Be sure to pay special attention to the privacy, and likeness rights, etc. of the subject when you use this function. Use at your own risk.
- The smartphone drains its battery faster while acquiring location information.

[Remote Wakeup]

Bluetooth

Even when the camera is turned off, the smartphone can be used to start the camera and record images, or check the recorded images.

Getting started:

- 1 Connect to a smartphone using Bluetooth. (→ [Connecting to a Smartphone \(Bluetooth Connection\): 615](#))
- 2 Enable [Remote Wakeup] on the camera.
 -  ⇒ [] ⇒ [] ⇒ [Bluetooth] ⇒ [Remote Wakeup] ⇒ [ON]
- 3 Set the camera on/off switch to [OFF].
- 4 On the smartphone, start up “LUMIX Sync”.

❖ Turning On the Camera

- 1 Select [Remote shooting] in the “LUMIX Sync” home screen.
 - (iOS devices) When a message to confirm the change of destination is displayed, select [Join].
 - The camera turns on, and automatically connects using Wi-Fi.

❖ Turning Off the Camera

- 1 Select [] in the “LUMIX Sync” home screen.
- 2 Select [Turn off the camera].
- 3 Select [Power OFF].

- When you turn on the camera with the smartphone, the status indicator will flash.
- When [Remote Wakeup] has been set, the Bluetooth function continues to work even if the camera on/off switch is set to [OFF], so the battery will drain.

[Auto Clock Set]

Bluetooth

Synchronize the clock and the time zone setting of the camera with those of a smartphone.

Getting started:

- Connect the camera to a smartphone by Bluetooth. (→ [Connecting to a Smartphone \(Bluetooth Connection\): 615](#))

1 Enable [Auto Clock Set] on the camera.

-  →  →  → [Bluetooth] → [Auto Clock Set] → [ON]

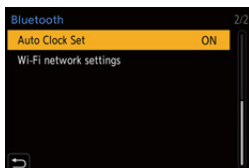

[Camera settings copy]

Bluetooth

This saves the camera's settings information to the smartphone. Saved settings information can be loaded to the camera, letting you set the same settings on multiple cameras.

Getting started:

- Connect the camera to a smartphone by Bluetooth. (→ [Connecting to a Smartphone \(Bluetooth Connection\): 615](#))

1 Select [] ([Others]) → [] ([Camera settings copy]) in the “LUMIX Sync” home screen.

2 Save or load settings information.

- Read the [Help] in the “LUMIX Sync” menu for further details on how to operate the “LUMIX Sync”.

- Only settings information from the same model can be loaded.
- When transferring settings information, a Wi-Fi connection is automatically created.
(iOS devices) When a message to confirm the change of destination is displayed, select [Join].
- You can save or load the settings information of items that are the same as those in [Save/Restore Camera Setting] under the [Setup] ([Setting]) menu. (→ [List of Default Settings/Custom Saving/Settings Available for Copying: 771](#))

Sending Images from the Camera

- [\[Smartphone\]: 651](#)
- [\[PC\]: 655](#)
- [\[Printer\]: 659](#)

Operate the camera to send recorded images to a device connected by Wi-Fi.

Operation flow

1 Select the sending method.

Select the sending method from the **[Send Images While Recording]** and **[Send Images Stored in the Camera]** camera menus.

2 Select the destination (type of the destination device).

- [\[Smartphone\]](#) (→ [\[Smartphone\]: 651](#))
- [\[PC\]](#) (→ [\[PC\]: 655](#))
- [\[Printer\]](#) (→ [\[Printer\]: 659](#))

3 Select the connection method and then connect by Wi-Fi.

- [\[Via Network\]](#) (→ [\[Via Network\]: 662](#))
- [\[Direct\]](#) (→ [\[Direct\]: 666](#))

4 Check the send settings.

Change the send settings as necessary.

- Image send settings (→ [Image Send Settings: 671](#))

5 ([Send Images While Recording]) Take pictures.

This automatically sends the recorded pictures as they are taken.

([Send Images Stored in the Camera]) Select an image.

Send the selected images.

- Selecting images (→ [Selecting Images: 673](#))

Refer to the following pages for the steps common to all devices.

- Wi-Fi connections: [Via Network] (→ [\[Via Network\]: 662](#))/[Direct] (→ [\[Direct\]: 666](#))
- Image send settings (→ [Image Send Settings: 671](#))
- Selecting images (→ [Selecting Images: 673](#))

- When recording, recording is prioritized so it will take time for sending to complete.
- If the camera is turned off, or the Wi-Fi is disconnected before sending is completed, then sending will not restart.
- You may not be able to delete files or use the [Playback] menu while sending.
- When the following functions are being used, [Wi-Fi Function] is not available:
 - [Streaming Function]
 - [Auto Transfer]

❖ Images That Can be Sent

Images that can be sent differ depending on the destination device.

Destination device	Images that can be sent	
	[Send Images While Recording]	[Send Images Stored in the Camera]
[Smartphone] (→[Smartphone]: 651)	JPEG/RAW	JPEG/RAW/MP4
[PC] (→[PC]: 655)	JPEG/RAW	JPEG/RAW/ MP4/MOV/ 6K/4K burst files/ Post-Focus images
[Printer] (→[Printer]: 659)	—	JPEG

- Depending on the smartphone or the OS version, these may not be displayed correctly.
- It is not possible to send images with file sizes exceeding 4 GB to [Smartphone].

- Sending may not be possible depending on your device.
- It may not be possible to send images recorded with devices other than this camera, or images edited or processed on a PC.

❖ Fn Button Assigned with [Wi-Fi]

You can perform the following operations by pressing the Fn button assigned with [Wi-Fi] after connecting to Wi-Fi.

(→ [Fn Buttons: 471](#))

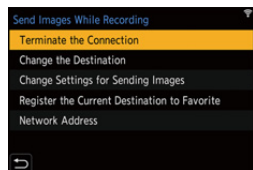

[Terminate the Connection]	Terminates the Wi-Fi connection.
[Change the Destination]	Terminates the Wi-Fi connection, and allows you to select a different Wi-Fi connection.
[Change Settings for Sending Images]	Sets the image size, file format, and other items for sending recorded images. (→ Image Send Settings: 671)
[Register the Current Destination to Favorite]	Registers the current connection destination or method so that you can easily connect with the same connection settings next time.
[Network Address]	Displays the MAC address and IP address of the camera. (→ [Network Address]: 675)

- Depending on the Wi-Fi function being used or the connection destination, you may not be able to perform some of these operations.



[Smartphone]

Transfer recorded images to a smartphone connected using Wi-Fi.

Getting started:

- Install “LUMIX Sync” on your smartphone. (→ [Installing “LUMIX Sync”: 614](#))

1 Select the method for sending the images on the camera.

-  ⇒ [] ⇒ [] ⇒ [Wi-Fi] ⇒ [Wi-Fi Function] ⇒ [New Connection] ⇒ [Send Images While Recording]/[Send Images Stored in the Camera]

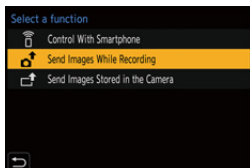

2 Set the destination to [Smartphone].



3 Connect the camera to a smartphone by Wi-Fi.

- Select [Via Network] (→[Via Network]: 662) or [Direct] (→[Direct]: 666), and then connect.

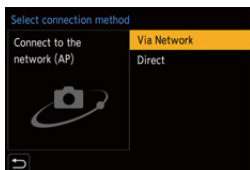

4 On the smartphone, start up “LUMIX Sync”.

5 Select the destination smartphone on the camera.

6 Check the send settings and then press or .

- To change the send settings of images, press [DISP.]. (→Image Send Settings: 671)

7 (When [Send Images While Recording] is selected) Take pictures.

- [] is displayed in the recording screen of the camera while a file is being sent.
- To end the connection, follow the steps below:

 ⇒ [] ⇒ [] ⇒ [Wi-Fi] ⇒ [Wi-Fi Function] ⇒ [Yes]

(When [Send Images Stored in the Camera] is selected) Select an image.

- To end the connection, select [Exit].

❖ Sending Images on the Camera to a Smartphone with Simple Operations

You can transfer pictures to a smartphone connected by Bluetooth just by pressing the [Q] button during playback.

You can also use the menu to connect easily.

- You can also perform the same operation by pressing the Fn button registered with [Send Image (Smartphone)]. (→ [Fn Buttons: 471](#))



Getting started:

- Install “LUMIX Sync” on your smartphone. (→ [Installing “LUMIX Sync”: 614](#))
- Connect the camera to a smartphone by Bluetooth. (→ [Connecting to a Smartphone \(Bluetooth Connection\): 615](#))
- Press [] on the camera to display the playback screen.

Send a single image



- 1 Press ◀▶ to select the image.
- 2 Press [Q].
- 3 Select [Single Select].
 - To change the send settings of images, press [DISP.]. (→ [Image Send Settings: 671](#))
- 4 On the smartphone, select [Yes] (for Android devices) or [Join] (for iOS devices).
 - This connects automatically using Wi-Fi.

Send multiple images



- 1 Press [Q].
- 2 Select [Multi Select].
 - To change the send settings of images, press [DISP.]. (→ [Image Send Settings: 671](#))
- 3 Select the images and then transfer.
◀▶ : Select images
 or  : Set/Cancel
[DISP.]: Transfer
- 4 On the smartphone, select [Yes] (for Android devices) or [Join] (for iOS devices).
 - This connects automatically using Wi-Fi.

- When the following functions are being used, [Wi-Fi Function] is not available:
 - [Streaming Function]
 - [Auto Transfer]

Using the menu to transfer easily

 ⇒ [] ⇒ [] ⇒ [Bluetooth] ⇒ [Send Image (Smartphone)]

Settings: [Single Select]/[Multi Select]

- If [Single Select], press ◀▶ to select the image and then press  or  to execute.
- If [Multi Select], use the same operation as with “[Send multiple images](#)”.

[PC]

Send recorded images to the PC connected with Wi-Fi.

Supported OS

Windows: Windows 10

Mac: macOS 10.13, 10.14, 10.15.3 to 10.15.7, 11.0 to 11.2

Getting started:

- Turn on the PC.
- Create a destination folder for images.
- If the workgroup of the destination PC has been changed from the standard setting, change the corresponding setting of the camera in [PC Connection]. (→[\[PC Connection\]: 674](#))

❖ Create a Destination Folder for Images

When using Windows (Example for Windows 10)



- 1 Select the destination folder and then right-click.
- 2 Select [Properties] and then enable folder sharing.

When using Mac (Example for macOS 10.14)

- 1 Select the destination folder and then click the items in the following order.
[File] ⇒ [Get Info]
- 2 Enable folder sharing.

- Create a PC account name (up to 254 characters) and password (up to 32 characters) consisting of alphanumeric characters.
A destination folder may not be created if the account name includes non-alphanumeric characters.
- When the computer name (NetBIOS name for Mac) contains a space (blank character), etc., it may not be recognized.
In that case, we recommend changing the name to one consisting only of 15 or less alphanumeric characters.
- Refer to the operating instructions for your PC or Help on the OS for detailed setting procedures.

1 Select the method for sending images on the camera.

-  ⇒ [] ⇒ [] ⇒ [Wi-Fi] ⇒ [Wi-Fi Function] ⇒ [New Connection] ⇒ [Send Images While Recording]/[Send Images Stored in the Camera]

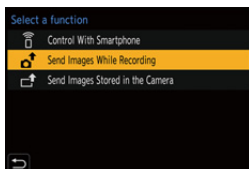

2 Set the destination to [PC].

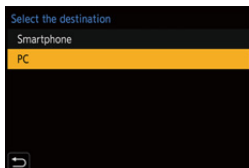

3 Connect the camera and PC by Wi-Fi.

- Select [Via Network] (→[\[Via Network\]: 662](#)) or [Direct] (→[\[Direct\]: 666](#)), and then connect.

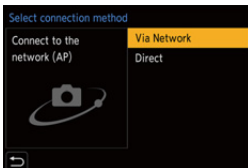

4 Enter the computer name of the PC name you want to connect to (for Mac, the NetBIOS name).

- How to enter characters (→[Entering Characters: 609](#))



5 Select a folder for storing images.

- Folders sorted by sent date will be created in the selected folder, and images will be saved there.

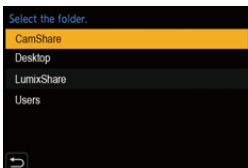

6 Check the send settings and then press or .

- To change the send setting, press [DISP.]. (→ [Image Send Settings: 671](#))

7 (When [Send Images While Recording] is selected) Take pictures.

- [] is displayed in the recording screen of the camera while a file is being sent.
- To end the connection, follow the steps below:

 ⇒ [] ⇒ [] ⇒ [Wi-Fi] ⇒ [Wi-Fi Function] ⇒ [Yes]

(When [Send Images Stored in the Camera] is selected) Select an image.

- To end the connection, select [Exit].



- If the screen for a user account and password entry appears, enter the one you set on your PC.
- When the firewall of the OS, security software, etc. is enabled, connecting to the PC may not be possible.
- When the following functions are being used, [Wi-Fi Function] is not available:
 - [Streaming Function]
 - [Auto Transfer]

[Printer]

You can send images to a PictBridge (wireless LAN)*1-supported printer connected by Wi-Fi for printing.

*1 DPS over IP standard-compliant

1 Select the method for sending images on the camera.

-  → [] → [] → [Wi-Fi] → [Wi-Fi Function] → [New Connection] → [Send Images Stored in the Camera]

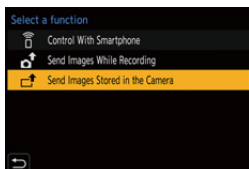

2 Set the destination to [Printer].

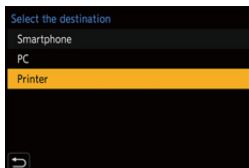

3 Connect the camera to a printer by Wi-Fi.

- Select [Via Network] (→[Via Network]: 662) or [Direct] (→[Direct]: 666), and then connect.

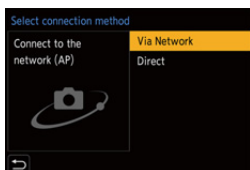

4 Select the destination printer.

5 Select and print images.

- The procedure for selecting images is the same as the one for when the USB connection cable is connected. (→[Printing: 702])
- To terminate the connection, press [↵].

- For details about PictBridge (wireless LAN-compatible) printers, contact their manufacturers.
- When the following functions are being used, [Wi-Fi Function] is not available:
 - [Streaming Function]
 - [Auto Transfer]

Wi-Fi Connections

- [\[Via Network\]: 662](#)
- [\[Direct\]: 666](#)
- [Connect to Wi-Fi Using Previously Saved Settings: 668](#)

When [New Connection] has been selected in [Wi-Fi Function] in [Wi-Fi] of the [Setup] ([IN/OUT]) menu, select the connection method from either [Via Network] or [Direct] to connect.

On the other hand, when you use [Select a destination from History] or [Select a destination from Favorite], the camera connects to the selected device with the previously-used settings.



[Via Network]

Connect the camera and an external device through the wireless access point.



1 Select the method for connecting to a wireless access point.

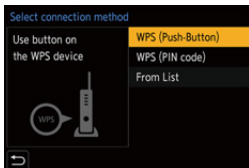

Settings: [WPS (Push-Button)]/[WPS (PIN code)]/[From List]

- After selecting [Via Network] once, the camera will connect to the previously-used wireless access point.
To change the wireless access point used for connection, press [DISP.] and change the connection destination.
- Check the operating instructions and settings of the wireless access point.

❖ [WPS (Push-Button)]

Press the WPS button on the wireless access point to set up a connection.

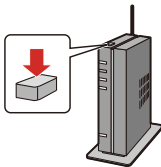

- 1 Press the wireless access point WPS button until it switches to WPS mode.

Example)



❖ [WPS (PIN code)]

Enter a PIN code into the wireless access point to set up a connection.

- 1 On the camera screen, select the wireless access point you are connecting to.
- 2 Enter the PIN code displayed on the camera screen into the wireless access point.
- 3 Press  or  of the camera.

❖ [From List]

Searches for a wireless access point to use, and connects to it.

- Confirm the encryption key of the wireless access point.

- 1 Select the wireless access point you are connecting to.
 - Press [DISP.] to run a wireless access point search again.
 - If no wireless access point is found (→ [Connecting by Manual Input: 665](#))

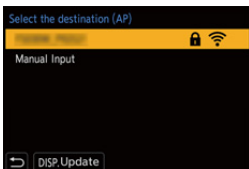

- 2 (If network authentication is encrypted) Enter the encryption key.
 - How to enter characters (→ [Entering Characters: 609](#))

❖ Connecting by Manual Input

- Check the SSID, network authentication, encryption, and encryption key of the wireless access point you are using.

- 1 In the screen in Step 1 of “[From List]”, select [Manual Input].
- 2 Enter the SSID of the wireless access point you are connecting to, and then select [Set].
 - How to enter characters (→ [Entering Characters: 609](#))
- 3 Select the network authentication.

[WPA2-PSK]/[WPA2/WPA-PSK]

Supported encryption: [TKIP], [AES]

[No Encryption]

- 4 (When other than [No Encryption] is selected) Enter the encryption key and then select [Set].

[Direct]

Directly connect the camera and the external device.



1 Select the method for connecting with the destination device.

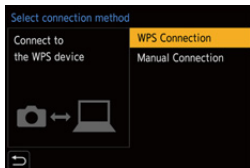

[WPS Connection]

[WPS (Push-Button)]: Press the WPS button on the external device to connect.

- On the camera, press [DISP.] to extend the connection wait time.

[WPS (PIN code)]: Enter the PIN code into the camera, and connect.

[Manual Connection]

Search for the camera on the destination device to connect.

Enter the SSID and password displayed on the camera into the device.

- If the destination is set to [Smartphone], the password is not displayed. Select the SSID to establish a connection. (→ [Connecting to a Smartphone \(\[Wi-Fi connection\]\): 622](#))





-
- Please also refer to the operating instructions for the device to be connected.

Connect to Wi-Fi Using Previously Saved Settings

Use the Wi-Fi connection history to connect using the same settings as previously.

1 Display the Wi-Fi connection history.

-  → [] → [] → [Wi-Fi] → [Wi-Fi Function] → [Select a destination from History]/[Select a destination from Favorite]



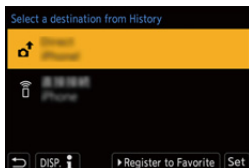

2 Select the History item to connect to.

- Press [DISP.] to confirm details of the connection history.





❖ Register to Favorite

You can register the Wi-Fi connection history to Favorite.

- 1 Display the Wi-Fi connection history.
 -  ⇒ [] ⇒ [] ⇒ [Wi-Fi] ⇒ [Wi-Fi Function] ⇒ [Select a destination from History]
- 2 Select the History item to register and then press ►.
- 3 Enter a registration name and then select [Set].
 - How to enter characters (→ [Entering Characters: 609](#))
 - A maximum of 30 characters can be entered. A two-byte character is treated as two characters.

❖ Editing Items Registered in Favorite

- 1 Display items registered to Favorite.
 -  ⇒ [] ⇒ [] ⇒ [Wi-Fi] ⇒ [Wi-Fi Function] ⇒ [Select a destination from Favorite]
- 2 Select the History item to edit in Favorite and then press ►.

[Remove from Favorite]

[Change the Order in Favorite]

Specify the destination location of the desired item to change the display order.

[Change the Registered Name]

Enter characters to change the registered name.

- How to enter characters (→ [Entering Characters: 609](#))
-

- The number of items that can be saved in History is limited. Register frequently-used connection settings to Favorite.
- When [Reset] in the [Setup] ([Setting]) menu is used to reset the network settings, the content registered in History and Favorite is deleted.
- If the device you want to connect to (smartphone, etc.) is connected to a wireless access point other than the camera, you cannot connect the device to the camera using [Direct].

Change the Wi-Fi settings of the device you want to connect to so that the access point to be used is set to the camera. You can also select [New Connection] and reconnect the devices. (→ [Connecting to a Smartphone \(\[Wi-Fi connection\]\): 622](#))

- It may be difficult to connect to networks to which many devices are connected. In these cases, connect using [New Connection].
- When the following functions are being used, [Wi-Fi Function] is not available:
 - [Streaming Function]
 - [Auto Transfer]

Send Settings and Selecting Images

- [Image Send Settings: 671](#)
- [Selecting Images: 673](#)

Image Send Settings

Set the size, file format, and other items for sending the image to the destination device.

- 1 After Wi-Fi connection, the send settings confirmation screen will be displayed, so press [DISP.].**

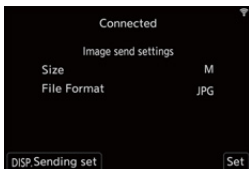

- 2 Change the send settings.**

[Size]

Resize the image to send.

[Original]/[Change] ([M], [S], or [VGA])

[File Format]

Sets the file format of images to send.

[JPG]/[RAW+JPG]/[RAW]

- This setting is possible when the destination supports the sending of RAW images from this camera. (→ [Images That Can be Sent: 649](#))
-

Selecting Images

When sending by [Send Images Stored in the Camera], select the images using the following procedure.

- 1 Select [Single Select] or [Multi Select].
- 2 Select the image.



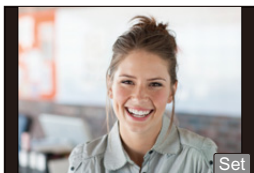

[Single Select] setting

- 1 Press ◀▶ to select an image.



- 2 Press  or .

[Multi Select] setting

- 1 Press ▲▼◀▶ to select an image and then press  or . (Repeat this)
 - To cancel the setting, press  or  again.
 - Images are displayed separately by card slot.
To switch the card to display, press [].
 - Selecting images at once is possible only for the images in a single card.

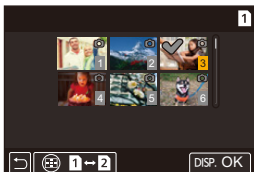

- 2 Press [DISP.] to execute.

[Wi-Fi Setup] Menu

This configures the settings required for the Wi-Fi function.
The settings cannot be changed when connected to Wi-Fi.

1 Displaying the [Wi-Fi Setup] menu.

-  → [] → [] → [Wi-Fi] → [Wi-Fi Setup]

[Priority of Remote Device]

This sets either the camera or the smartphone as the priority control device to be used during remote recording. (→ [Operation Method During Remote Recording: 633](#))

[Wi-Fi Password]



You can use a password to connect for enhanced security. (→ [Using Password Authentication to Connect: 624](#))

[PC Connection]

You can set the workgroup.

To send images to a PC, you need to connect to the same workgroup as the destination PC.

(The default setting is "WORKGROUP".)

- To change the workgroup name, press  or  and enter the new workgroup name.

How to enter characters (→ [Entering Characters: 609](#))

- To return to the default settings, press [DISP.].
-

[Device Name]

You can change the name (SSID) of the camera.

- To change the SSID name, press [DISP.] and enter the new SSID name.
How to enter characters (→ [Entering Characters: 609](#))
 - A maximum of 32 characters can be entered.
-

[Wi-Fi Function Lock]

To prevent incorrect operation and use of the Wi-Fi function by a third party and to protect personal information in the camera and included with images, protect the Wi-Fi function with a password.

[Setup]: Enter any 4-digit numbers as the password.

- How to enter characters (→ [Entering Characters: 609](#))

[Cancel]: Cancel the password.

- Once a password is set, you are required to enter it each time you use the Wi-Fi function.
 - If you forget your password, you can use [Reset] in the [Setup] ([Setting]) menu to reset the network settings and thereby reset the password.
-

[Network Address]

Displays the MAC address and IP address of the camera.

16. Streaming Function

- [Stream by Operating a Smartphone: 677](#)
- [Stream by Operating the Camera: 679](#)
- [Streaming Settings: 682](#)

Live stream the camera's images and audio over the internet.

- To start streaming, there is a smartphone operation method and camera operation method.
- This camera supports RTMP/RTMPS^{*1}.

You can stream to video sharing websites that support RTMP or RTMPS.

*1 Communication protocol for streaming

Stream by Operating a Smartphone



Operate the smartphone app “LUMIX Sync” to start streaming.



Getting started:

- Install “LUMIX Sync” on your smartphone. (→ [Installing “LUMIX Sync”](#): 614)
- Connect the camera to a smartphone by Bluetooth. (→ [Connecting to a Smartphone \(Bluetooth Connection\)](#): 615)

(Camera operation)

1 Set the mode dial to [iA/M].

(Smartphone operation)

2 Set streaming with “LUMIX Sync”.

- 1 Start up “LUMIX Sync”.
- 2 Select [Others] → [Live streaming] in the “LUMIX Sync” home screen.
- 3 Select a video sharing website and login.
 - When inputting a streaming destination address manually, select [Stream with RTMP/RTMPS].

4 Set streaming details.

[Wi-Fi Connection Setting]: Sets the wireless access point the camera connects to when streaming.

[Streaming Quality]: Sets the image quality that will be streamed.

[Privacy settings]: Selects privacy setting.

5 Select [Set to the camera].

- If the message [Unable to confirm security of the streaming address. Continue?] is displayed, check that the URL of the streaming destination is correct before continuing the connecting operation.
- The settings will be sent from the smartphone to the camera.
- The [Streaming Setup] of the camera turns [ON], and the camera connects via Wi-Fi to the access point.
- [▲] is displayed on the recording screen.

3 **Start streaming.**

- Select [Start streaming] on “LUMIX Sync”.
- [▲] is displayed on the recording screen.

4 **Stop streaming.**

- Select [Stop streaming] on “LUMIX Sync”.

5 **End the streaming function.**

- If you select [End streaming] on “LUMIX Sync”, the [Streaming Setup] of the camera will be set to [OFF].

Stream by Operating the Camera



Sets the streaming destination on a PC and saves it to a card. Insert the card to the camera and start streaming by operating the camera.



Getting started:

- Install “LUMIX Network Setting Software” to the PC.
<https://panasonic.jp/support/global/cs/dsc/download/index3.html>
(English only)
Supported OS
Windows: Windows 10
Mac: macOS 10.13, 10.14, 10.15.3 to 10.15.7, 11.0 to 11.2
- Insert a card into the PC.

(PC operation)

1 Set the streaming destination on the “LUMIX Network Setting Software”.











- 1 Start up “LUMIX Network Setting Software”.
- 2 Login to a video sharing website and retrieve a streaming destination (URL, stream key).

- 3 Input the streaming destination (URL, stream key) to “LUMIX Network Setting Software” and select [Next].
- 4 Set the output destination (card) and file name, and select [Save].
 - Characters that can be set in [File Name]: Alphabet (uppercase), numbers, up to 8 characters.
 - To prevent usage from a third party, you can secure the streaming destination with a password.
 - Put a check mark in [Password].
 - When you set a password, password input will be required when loading the streaming destination.
 - You can enter any 4-digit numbers as the password.
 - The settings set at step 3 is saved in the card.

(Camera operation)

2 Insert a card to the camera.

3 Set up streaming settings on the camera.

- 1 Set the mode dial to [CAM].
- 2 Load the streaming destination to the camera.
 -  ⇒ [] ⇒ [] ⇒ [Wi-Fi] ⇒ [Streaming Setup] ⇒ [Save/Load Streaming Address] ⇒ [Load]
 - If a password is set at step 1, input the password.
- 3 Set the streaming quality and wireless access point to connect to.
 -  ⇒ [] ⇒ [] ⇒ [Wi-Fi] ⇒ [Streaming Setup] ⇒ [Streaming Quality]/[Wi-Fi Connection Setting] (⇒ [Streaming Settings: 682](#))
- 4 Set [Streaming Function] to [ON].
 -  ⇒ [] ⇒ [] ⇒ [Wi-Fi] ⇒ [Streaming Setup] ⇒ [Streaming Function] ⇒ [ON]
 - If the message [Unable to confirm security of the streaming address. Continue?] is displayed, check that the URL of the streaming destination is correct before continuing the connecting operation.
 - The camera connects to the access point via Wi-Fi.
 - [] is displayed on the recording screen.



4 Start streaming.

- Press the shutter button or video rec. button.
- [] is displayed on the recording screen.
- Operations to start streaming may be needed on the video sharing website.

5 Stop streaming.

- Press the shutter button or video rec. button.

6 End the streaming function.

-  ⇒ [] ⇒ [] ⇒ [Wi-Fi] ⇒ [Streaming Setup] ⇒ [Streaming Function] ⇒ [OFF]

Streaming Settings

- [Notes When Using the Streaming Function: 686](#)



Configures streaming settings.

→ → → [Wi-Fi] → Select [Streaming Setup]

[Streaming Function]	<p>[ON]: Performs Wi-Fi connection and gets into a state where streaming can start.</p> <p>[OFF]: Ends the Wi-Fi connection for performing streaming.</p>
[Streaming Quality]	<p>Sets the image quality that will be streamed. (→ [Streaming Quality]: 685)</p>
[Streaming Address]	<p>Displays the current streaming destination address.</p> <p>To change the streaming destination, press [DISP.] first then input the streaming destination address.</p> <ul style="list-style-type: none"> • For information on how to enter characters (→ [Entering Characters]: 609)

[Save/Load Streaming Address]	[Save]	<p>Saves the current streaming destination address to the card.</p> <ul style="list-style-type: none"> • If saving new data, then select [New File], and if overwriting an existing file, select that existing file. • When [New File] is selected, a screen to select the file name to save as is displayed. <p>[OK]: Saves using the file name on the screen.</p> <p>[Change the file name]: Changes the file name and saves the file.</p> <ul style="list-style-type: none"> • Available characters: alphabetic characters (uppercase), numerals, up to 8 characters • For information on how to enter characters (→ Entering Characters: 609)
	[Load]	<p>Copy the streaming destination address in the card to the camera.</p> <ul style="list-style-type: none"> • If you set a password when you saved the streaming destination address on the card, the password entry screen is displayed.
	[Delete]	<p>Deletes the streaming destination address within the card.</p>
	[Keep Settings While Format]	<p>When formatting the card, you can keep the streaming destination address saved in the card and format.</p>
	[Password]	<p>Displays the password input screen when [Save] is selected.</p>

[Wi-Fi Connection Setting]	Sets the wireless access point the camera connects to when streaming. (→ [Via Network]: 662)
---	---

- Up to 10 streaming destination addresses can be saved onto one card.
- Set [Wi-Fi Connection Setting] before setting [Streaming Function] to [ON].
- If you forget the password, save the streaming destination address again with a new password.

❖ [Streaming Quality]

Video compression format: H.264/MPEG-4 AVC

[System Frequency]: [59.94Hz (NTSC)]

[Streaming Quality]	Resolution	Frame rate	Bit rate
FHD/16M/60p	1920×1080	59.94p	16 Mbps
FHD/8M/60p		59.94p	8 Mbps
FHD/6M/30p		29.97p	6 Mbps
FHD/3M/30p		29.97p	3 Mbps
HD/6M/60p	1280×720	59.94p	6 Mbps
HD/4M/30p		29.97p	4 Mbps

[System Frequency]: [50.00Hz (PAL)]





[Streaming Quality]	Resolution	Frame rate	Bit rate
FHD/16M/50p	1920×1080	50.00p	16 Mbps
FHD/8M/50p		50.00p	8 Mbps
FHD/6M/25p		25.00p	6 Mbps
FHD/3M/25p		25.00p	3 Mbps
HD/6M/50p	1280×720	50.00p	6 Mbps
HD/4M/25p		25.00p	4 Mbps

- If the streaming destination is an RTMPS, an image quality with a bit rate of 16 Mbps or above cannot be set.
- The image output via HDMI is output with the resolution and frame rate according to the combinations of the [Streaming Quality] and [Down Convert] settings.
 - When [Streaming Quality] is set to [HD], the output is in [FHD] resolution.

Notes When Using the Streaming Function

Operation is as follows when using the streaming function:

- The following functions are not available:
 - [Hybrid Log Gamma] ([Photo Style])
 - [Miniature Effect] ([Filter Settings])
 - [Rec. File Format]
 - [Rec Quality]
 - [Rec Quality (My List)]
 - [Variable Frame Rate]
 - [96kHz/24bit], [48kHz/24bit] ([XLR Mic Adaptor Setting])
 - [Loop Recording (video)]
 - [Segmented File Recording]
 - [Live Cropping]
 - [Wi-Fi Function] (Wi-Fi connection destination during streaming can be set in [Streaming Setup].)
 - Pairing function of [Bluetooth]
- The streaming function is not available when using the following functions:
 - When [System Frequency] is set to [24.00Hz (CINEMA)]
 - During USB connection (Excludes when supplying power using a USB connection cable)

- Displays a blue frame on the screen during streaming:
[] ⇒ [] ⇒ [Streaming Blue Frame Indicator] (⇒[Streaming Blue Frame Indicator]: 578)
- When you press the video rec. button, the images being streamed will be recorded on the external recorder output via HDMI:
[] ⇒ [] ⇒ [HDMI Rec Output] ⇒ [HDMI Recording Control]
- If you turn the camera off without ending the streaming function, when the next time the camera is turned on, it is automatically reconnected to the connection destination that was previously connected.
- Video cannot be recorded to the cards while using streaming function.
- The menu screen cannot be displayed while streaming.
- The camera's recording information will not be displayed on the streamed images.
- The required conditions for streaming differ depending on the video sharing website. Check the video sharing website for details.

17. Connecting to Other Devices

- Viewing on a TV: 690
- Importing Images to a PC: 694
- Storing on a Recorder: 698
- Tethered Recording: 699
- Printing: 702

This chapter describes connections with other devices, such as TVs and PCs.

Connect using either the [HDMI] socket or the USB port on the camera. Refer to the sections below for more details about connections.

- Check the direction of the terminals and plug in/out straight holding onto the plug. (Inserting these at an angle may cause deformation or malfunction)
- Do not connect the cable to the wrong terminals. This may cause a malfunction.

[HDMI] socket

Connect the camera and TV with a commercially available HDMI cable.

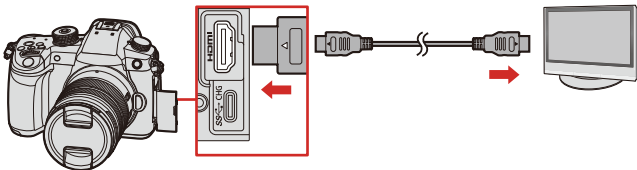

- Use a “High Speed HDMI cable” with the HDMI logo. Cables that do not comply with the HDMI standards will not work. “High Speed HDMI cable” (Type A–Type A plug, up to 1.5 m (4.9 feet) long)

USB port

Use a USB connection cable to connect the camera to a PC, recorder, or printer.

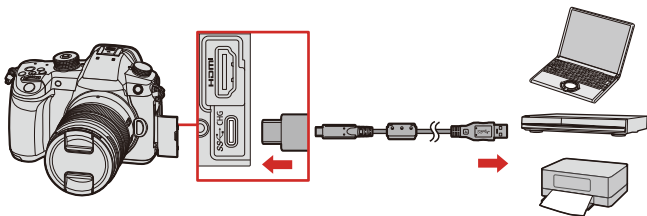

- Do not use any other USB connection cables except the supplied one.

Viewing on a TV

You can connect the camera to an external monitor or TV to view recorded pictures and videos.

Getting started:

- Turn off the camera and TV.

- 1 Connect the camera and TV with a commercially available HDMI cable. (→ [\[HDMI\] socket: 688](#))**
- 2 Turn on the TV.**
- 3 Switch the TV input to HDMI input.**
- 4 Turn on the camera.**
- 5 Display the playback screen.**
 - Press [].
 - The recorded images are displayed on the TV. (The monitor and viewfinder of the camera will turn off.)

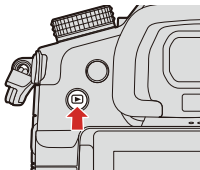





- With the default settings, pictures are output at the optimal resolution for the connected TV.
The output resolution can be changed in [Output Resolution(Playback)].
(→[HDMI Connection]: 590)
- Depending on the aspect ratio, gray bands may be displayed on the top and bottom or the left and right of images.
You can change the band color in [Background Color(Playback)] in [HDMI Connection] of the [Setup] ([IN/OUT]) menu. (→[HDMI Connection]: 590)
- HDMI output is not possible if you connect a USB connection cable at the same time while [USB Mode] is set to [PC(Storage)] or [PictBridge(PTP)].
- If the temperature of the camera rises, [,] may be displayed, recording may stop, and some functions may become unavailable temporarily. Wait until the camera cools down.
- Change the screen mode on your TV if images are displayed with the top or bottom cut off.
- Depending on the connected TV, 6K/4K burst files may not be played back correctly.
- Please also refer to the operating instructions for the TV.

❖ Using VIERA Link

VIERA Link (HDAVI Control™) is a function that allows you to use your remote control for the Panasonic TV for easy operations when the camera has been connected to a VIERA Link compatible device using an HDMI cable for automatic linked operations.

(Not all operations are possible.)

- To use VIERA Link, you need to also configure the settings on the TV. For the setting procedure, refer to the operating instructions for the TV.

- 1 Connect the camera to a Panasonic TV compatible with VIERA Link using a commercially available HDMI cable. (→[HDMI] socket: 688)
- 2 Turn on the camera.
- 3 Turn on the VIERA Link.
 -  ⇒ [] ⇒ [] ⇒ [HDMI Connection] ⇒ [VIERA Link (CEC)] ⇒ [ON]
- 4 Display the playback screen.
 - Press [].
- 5 Operate with the remote control for the TV.

Power off link

If you turn off the TV with its remote control, the camera will also turn off.

Automatic input switching

If you turn on the camera and then press [], the input of the TV automatically switches to input to which this camera is connected.

Furthermore, when the TV power is in the standby state, it turns on automatically.

(When “Power on link” on the TV is set to “Set”)

- VIERA Link is a unique Panasonic function built on an HDMI control function using the standard HDMI CEC (Consumer Electronics Control) specification. Linked operations with HDMI CEC compatible devices made by other companies are not guaranteed.
- The camera supports “VIERA Link Ver.5”. “VIERA Link Ver.5” is the standard for Panasonic’s VIERA Link compatible devices. This standard is compatible with Panasonic’s conventional VIERA Link devices.
- Operation using the buttons on the camera will be limited.

Importing Images to a PC

- [Installing Software: 696](#)

After connecting to the PC, you can copy the recorded images by dragging files and folders on this camera to the PC.

- The camera can be connected to a PC running any of the following OSs which can detect mass storage devices.



Supported OS

Windows: Windows 10

Mac: macOS 10.13, 10.14, 10.15.3 to 10.15.7, 11.0 to 11.2

Getting started:

- Turn on the camera and PC.

- 1 Connect the camera and PC with the USB connection cable. (→ [USB port: 689](#))**
- 2 Press ▲▼ to select [PC(Storage)] and then press  or .**
 - Windows: A drive (“LUMIX”) is displayed in [This PC].
 - Mac: A drive (“LUMIX”) is displayed on the desktop.
- 3 Drag the files and folders from the camera to the PC.**

- You can use software to perform operations such as organizing and correcting recorded images, processing RAW images, and editing videos. (→ [Installing Software: 696](#))
- Supported by “Final Cut Pro X”.
For details on “Final Cut Pro X”, please contact Apple Inc.

❖ Folder Structure Inside Card

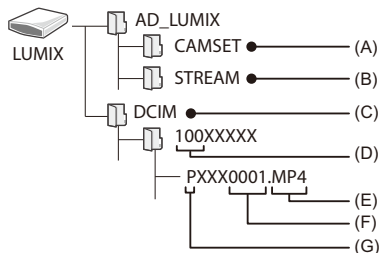

- (A) The camera's setup information
 (B) Streaming Settings
 (C) Images
 (D) Folder number
 (E) JPG: JPEG format pictures
 RW2: RAW format pictures
 MP4: MP4 videos, 6K/4K burst files
 MOV: MOV videos
 (F) File number
 (G) Color space
 P: sRGB
 _: AdobeRGB

- If [USB Mode] is set to [PC(Storage)] in the [Setup] ([IN/OUT]) menu, the camera will be automatically connected to the PC without the [USB Mode] selection screen being displayed. (→[USB]: 589)
- Take care not to turn off the camera while images are being imported.
- After importing of the images is completed, perform the operation to safely remove the USB connection cable on the PC.
- Turn off the camera and disconnect the USB connection cable before removing the card from the camera. Otherwise, the recorded data may be damaged.

Installing Software

Install the software to perform operations such as organizing and correcting recorded images, processing RAW images, and editing videos.

- To download the software, your PC needs to be able to connect to the internet.
- Supported OSs are current as of May 2021 and are subject to change.

❖ **SILKYPIX Developer Studio SE**

This software processes and edits RAW images.

Edited images can be saved in a format (JPEG, TIFF, etc.) that can be displayed on a PC.

Check the following site and then download and install the software:

<http://www.isl.co.jp/SILKYPIX/english/p/>

Operating environment

● **Supported OS**

Windows: Windows 10, Windows 8.1 (64-bit recommended)

Mac: macOS 10.13 to macOS 10.15, macOS 11

- For more information such as how to use “SILKYPIX Developer Studio”, refer to the Help or the Ichikawa Soft Laboratory’s support site.

❖ **30-Day Full Trial Version of “LoiLoScope”**

This software allows you to easily edit videos.

Check the following site and then download and install the software:

<http://loilo.tv/product/20>

Operating environment

● **Supported OS**

Windows: Windows 10, Windows 8.1, Windows 8



- You can download a trial version that can be used for free for 30 days.
- For more information on how to use “LoiLoScope”, refer to the “LoiLoScope” manual available for download at the site.
- “LoiLoScope” is not available for Mac.

Storing on a Recorder

By connecting the camera to a Panasonic Blu-ray disc recorder or DVD recorder, you can store the pictures and videos.

Getting started:

- Turn on the camera and recorder.
- Insert a card into card slot 1.

- 1 Connect the camera and recorder with the USB connection cable. (→ [USB port: 689](#))**
- 2 Press ▲▼ to select [PC(Storage)] and then press  or .**
- 3 Operate the recorder to store the images.**

- If [USB Mode] is set to [PC(Storage)] in the [Setup] ([IN/OUT]) menu, the camera will be automatically connected to the recorder without the [USB Mode] selection screen being displayed. (→ [\[USB\]: 589](#))
- Take care not to turn off the camera while storage is in progress.
- Images such as 4K videos may not be supported depending on your recorder.
- Turn off the camera and disconnect the USB connection cable before removing the card from the camera. Otherwise, the recorded data may be damaged.
- For the storage and playback procedures, refer to the operating instructions for the recorder.

Tethered Recording

- [Installing Software: 700](#)
- [Operating the Camera from a PC: 701](#)

If you install the “LUMIX Tether” camera control software on your PC, you can connect the camera to the PC via USB and then control the camera from the PC and record while checking the live view on the PC screen (tethered recording).

In addition, you can output via HDMI to an external monitor or TV during tethered recording.

Installing Software

❖ “LUMIX Tether”

This software is for controlling the camera from a PC.

It allows you to change various settings and to record remotely and then save the images to the PC.

Check the following site and then download and install the software:

https://panasonic.jp/support/global/cs/soft/download/d_lumixtether.html

(English only)

Operating environment

● Supported OS

Windows: Windows 10 (64 bit)

Mac: macOS 10.13, 10.14, 10.15.3 to 10.15.7, 11.0 to 11.2

● Interface



USB port (SuperSpeed USB (USB 3.1))

- Supported OSs are current as of May 2021 and are subject to change.
- To download the software, your PC needs to be able to connect to the internet.
- For how to operate the software, refer to the operation guide for “LUMIX Tether”.

Operating the Camera from a PC

Getting started:

- Turn on the camera and PC.
- Install “LUMIX Tether” on PC.

- 1 Connect the camera and PC with the USB connection cable. (→[USB port: 689](#))**
- 2 Press ▲▼ to select [PC(Tether)] and then press  or .**
 - [] is displayed on the camera's screen.
- 3 Use “LUMIX Tether” to operate the camera from the PC.**

- If [USB Mode] is set to [PC(Tether)] in the [Setup] ([IN/OUT]) menu, the camera will be automatically connected to the PC without the [USB Mode] selection screen being displayed. (→[\[USB Mode\]: 589](#))
- The Wi-Fi/Bluetooth functions are not available while there is a PC connection with [PC(Tether)].



Printing

If you connect the camera to a printer that supports PictBridge, you can select pictures on the camera's monitor and then print them.

Getting started:

- Turn on the camera and printer.
- Set the print quality and other settings on the printer.

1 Play back the card that contains the picture you want to print.

- Press [▶].
- After pressing [⏏], press ▲▼ to select [Card Slot 1] or [Card Slot 2], and then press  or .
- The card for printing cannot be changed after connecting to the printer.

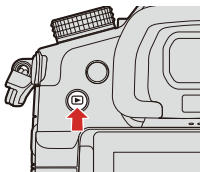

2 Connect the camera and printer with the USB connection cable. (→USB port: 689)

3 Press ▲▼ to select [PictBridge(PTP)] and then press or .

4 Press ◀▶ to select a picture and then press or .

- To print multiple pictures, press ▲, set the picture selection method, and then select pictures.

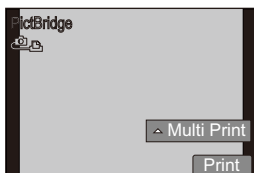

[Multi Select]

Selects the picture to print.

- 1 Press ▲▼◀▶ to select a picture and then press  or .
 - To cancel the setting, press  or  again.
- 2 Press [DISP.] to end selection.

[Select All]

Prints all the stored pictures.



[Rating]

Prints all pictures with [Rating] levels from [★1] to [★5].

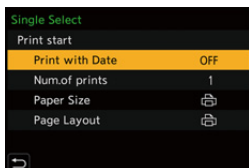
5 Set the print settings.



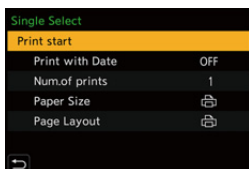

6 Start printing.

- Select [Print start] and then press  or .



❖ Setting Items (Print Settings)

[Print start]	Starts printing.
[Print with Date]	Sets printing with date. <ul style="list-style-type: none"> • If the printer does not support printing with date, the date cannot be printed.
[Num.of prints]	Sets the number of prints to be printed (up to 999).
[Paper Size]	Sets the paper size.
[Page Layout]	Sets whether to add borders and how many images to be printed on each sheet of paper.

- If [USB Mode] is set to [PictBridge(PTP)] in the [Setup] ([IN/OUT]) menu, the camera will be automatically connected to the printer without the [USB Mode] selection screen being displayed. (→[USB]: 589)
- Take care not to turn off the camera while printing is in progress.
- When connecting with the printer is not possible, set [USB Power Supply] to [OFF] and then try connecting again. (→[USB]: 589)
- Do not disconnect the USB connection cable while [] (Cable disconnect prohibit icon) is displayed.
- Disconnect the USB connection cable after printing.
- Turn off the camera and disconnect the USB connection cable before removing the card from the camera. Otherwise, the recorded data may be damaged.
- To print images with paper size and layout settings not supported by the camera, set the [Paper Size] and [Page Layout] to [] and then select the desired settings on the printer.
(For details, refer to the operating instructions for your printer.)
- If a yellow [●] is displayed, the camera is receiving an error message from the printer. Check that there is no problem with the printer.
- If the number of prints is high, the pictures may be printed in batches. In this case, the remaining number of prints indicated may differ from the number set.
- RAW images cannot be printed.
- Images recorded with the following functions cannot be printed:
 - Video recording/[6K/4K PHOTO]/[Post-Focus]

18. Materials

- Digital Camera Accessory System: 707
- Using Optional Accessories: 709
- Monitor/Viewfinder Displays: 714
- Message Displays: 733
- Troubleshooting: 736
- Cautions for Use: 750
- Number of Pictures That Can Be Taken and Available Recording Time with the Battery: 762
- Number of Still Images That Can Be Taken and Video Recording Time with Cards: 766
- List of Default Settings/Custom Saving/Settings Available for Copying: 771
- List of Functions That Can Be Set in Each Recording Mode: 790
- Specifications: 797
- Trademarks and Licences: 809

Digital Camera Accessory System

(Product numbers correct as of May 2021.)

Product name	Model number
Battery pack	DMW-BLK22
Battery charger ^{*1}	DMW-BTC15
AC Adaptor ^{*2}	DMW-AC10
DC Coupler ^{*2}	DMW-DCC17
Battery Grip	DMW-BGGH5
Flash	DMW-FL580L, DMW-FL360L, DMW-FL200L
LED Video Light	VW-LED1
Stereo Shotgun Microphone	DMW-MS2
Stereo Microphone	VW-VMS10
XLR Microphone Adaptor	DMW-XLR1
Body Cap	DMW-BDC1
Shutter Remote Control	DMW-RS2
Tripod Grip	DMW-SHGR1
Mount Adaptor	DMW-MA2M
Tripod adaptor ^{*3}	DMW-TA1
Shoulder Strap	DMW-SSTG9

*1 Supplied with an AC adaptor, an AC cable and a USB connection cable. (Charging time: approx. 175 min)

*2 The AC Adaptor (optional) can only be used with the designated Panasonic DC Coupler (optional).

The AC Adaptor (optional) cannot be used by itself.

*3 Use if the attached lens is in contact with the tripod pedestal.

- Some optional accessories may not be available in some countries.
- For lens-related optional accessories such as compatible lenses and filters, refer to our catalogs/web pages, etc.
- For the latest information on optional accessories, refer to our catalogs/web pages, etc.
- (For U.S.A. only)
To order optional accessories please visit
<http://shop.panasonic.com>
or your local Photo Specialty Dealer.

Using Optional Accessories

- [Battery Grip \(Optional\): 709](#)
 - [Shutter Remote Control \(Optional\): 711](#)
 - [Tripod Grip \(Optional\): 712](#)
 - [AC Adaptor \(Optional\)/DC Coupler \(Optional\): 713](#)
-
- For information on the external flash (→ [Using an External Flash \(Optional\): 304](#))
 - For information on the external microphone (→ [External Microphones \(Optional\): 436](#))
 - For information on the XLR Microphone Adaptor (→ [XLR Microphone Adaptor \(Optional\): 439](#))
 - Some optional accessories may not be available in some countries.

Battery Grip (Optional)

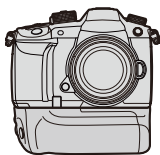



When mounted on the camera, the Battery Grip (DMW-BGGH5: optional) improves ease of operation and grip when the camera is held vertically. Also, inserting a battery (DMW-BLK22) into the Battery Grip provides a stable supply of power even for long periods of recording.

❖ Selecting Battery Usage Priority

Selects which battery to use first when the batteries are installed in both the camera and the Battery Grip.

Getting started:

- Turn the camera off, and remove the cover for the battery grip connector.



- 1 Attach the Battery Grip to the camera.
- 2 Turn on the camera.
- 3 Set the battery use priority.
 -  ⇒ [] ⇒ [] ⇒ [Battery Use Priority]

[BODY]

The battery in the camera is used first.

[BG]

The battery in the Battery Grip is used first.

- When the battery in the Battery Grip is used, [] is displayed on the monitor.
- You can register functions of your choice to the [Fn] button on the Battery Grip. (→ [Fn Buttons: 471](#))
The [WB] button, [ISO] button, [] button and joystick each work the same as the buttons and joystick on the camera body.
- The [AF/AE LOCK] button on the Battery Grip works the same as the [AF ON] button on the camera body.
- You can also use DMW-BLF19 (optional), but since it has a smaller battery capacity than DMW-BLK22, it is recommended to use DMW-BLK22.
- Refer to the operating instructions for the Battery Grip for details.

Shutter Remote Control (Optional)

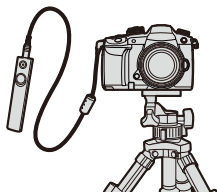

You can connect the Shutter Remote Control (DMW-RS2: optional) to use the camera as follows:



- Fully pressing the shutter button without camera shake
- Securing the shutter button during bulb recording and burst recording
- Start/end the video recording
- Using the functions registered in the video rec. button of the Shutter Remote Control

❖ Registering Functions to the Video Rec. Button

You can register a favorite function to the video rec. button on a Shutter Remote Control.

The functions that can be registered are the same as the functions that can be registered to the Fn buttons for recording. (→ [Setting Items \(\[Fn Button Set\]/\[Setting in REC mode\]\): 477](#))

[Video Record] is registered in the default setting.

 ⇒ [] ⇒ [] ⇒ Select [Video Rec. Button (Remote)]

- Register functions using the same operations as [Fn Button Set]. (→ [Fn Buttons: 471](#))

- Always use a genuine Panasonic Shutter Remote Control (DMW-RS2: optional).
- Refer to the operating instructions for the Shutter Remote Control for details.

Tripod Grip (Optional)

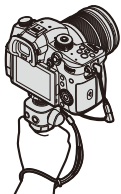

Attach a Tripod Grip (DMW-SHGR1: optional) to use it as a grip for recording while walking, a tripod, or a Shutter Remote Control.

- Connect the grip cable to the [REMOTE] socket on the camera.

- Always use a genuine Panasonic Tripod Grip (DMW-SHGR1: optional).
- The [Video Rec. Button (Remote)] menu does not work with the Tripod Grip.
- Do not carry just by holding the hand strap when the camera is attached.
- For details, refer to the operating instructions for the Tripod Grip.

AC Adaptor (Optional)/DC Coupler (Optional)

With an AC Adaptor (DMW-AC10: optional) and DC Coupler (DMW-DCC17: optional), you can perform recording and playback without worrying about the remaining battery charge.

- Be sure to purchase both an AC Adaptor and a DC Coupler as a set. They cannot be used independently of one another.
- When the DC Coupler is being mounted, the DC Coupler cover opens, so the structure ceases to be dust and splash resistant. Do not allow sand, dust and water droplets to adhere to or enter the camera. After use, confirm that no foreign objects are adhering to the DC Coupler cover, then firmly close the cover.
- For details, refer to the operating instructions for the AC Adaptor and DC Coupler.

Monitor/Viewfinder Displays

- [Recording Screen: 714](#)
- [Playback Screen: 728](#)
- The screen is an monitor display example of when [LVF/Monitor Disp. Set] is set to [].

Recording Screen

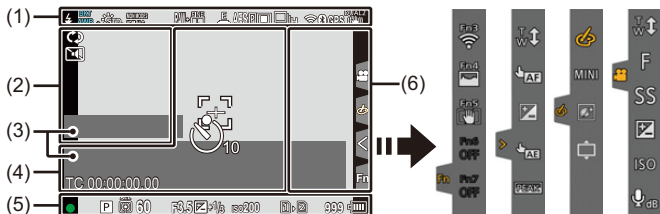











(1)





	Flash mode (→ [Flash Mode]: 309)
	Flash synchro (→ [Flash Synchro]: 315) Wireless mode (→ Recording Using a Wireless Flash: 317)
	White balance (→ White Balance (WB): 278)

	White Balance Bracket White Balance Bracket (Color Temperature) (→ [More Settings] (White Balance Bracket): 238)
AWB + AWB -	Adjusting the white balance (→ Adjusting the White Balance: 283)
	Photo Style (→ [Photo Style]: 285)
*EXPS	Filter setting (→ [Filter Settings]: 293) Filter effect adjustment (→ Adjusting the Filter Effect: 295)
MON LUT HDMI V-LogL	LUT View Assist (→ [V-LogL View Assist]: 398)
MON MODE2 HDMI HLG	HLG View Assist (→ [HLG View Assist]: 404)
RAW+  	Picture quality (→ [Picture Quality]: 116) Picture size (→ [Picture Size]: 115)
	Extended Tele Conversion (→ Extended Tele Conversion: 176)
	Recording file format (→ [Rec. File Format]: 337) Recording quality (→ [Rec Quality]: 338)
59.94p 60/59.94p	Recording frame rate (→ [Rec Quality]: 338) Variable frame rate (→ [Variable Frame Rate]: 382)
	Electronic shutter (→ [Shutter Type]: 240)
AFS AFC MF	Focus mode (→ Selecting the Focus Mode: 125 , Record Using MF: 167)
	Focus Bracket (→ [More Settings] (Focus Bracket): 237)
AFL	AF Lock (→ Locking Focus and Exposure (AF/AE Lock): 271)

(2)







	Pre-Burst recording (→ [Pre-Burst Recording] ([6K/4K Burst] / [6K/4K Burst(S/S)]): 195)
	Multiple exposures (→ [Multiple Exposure] : 531)
	Silent mode (→ [Silent Mode] : 239)
	Image area of video (→ [Image Area of Video] : 348)
	Anamorphic Desqueeze Display (→ [Anamorphic Desqueeze Display] : 407)
	Overlay indication (→ [Sheer Overlay] : 572)
	LUT View Assist (→ [V-LogL View Assist] : 398)
	Loop recording (→ [Loop Recording (video)] : 412)
	Streaming function is ON (→ 16. Streaming Function : 676)
	Currently streaming (→ 16. Streaming Function : 676)

(3)







	Time code (→ Time Code : 350)
	Mute (→ [Mute Sound Input] : 365)
	Built-in microphone, External microphone (→ Audio Settings : 364, External Microphones (Optional) : 436) XLR microphone adaptor setting (→ XLR Microphone Adaptor (Optional) : 439)
	Sound recording level limiter (→ [Sound Rec Level Limiter] : 366)











Sound recording level (→ [\[Sound Rec Level Disp.\]](#): 364)Exposure meter (→ [\[Expo.Meter\]](#): 571)

(4)

















	Histogram (→ [Histogram]: 566)
	AF area
	Spot metering target (→ [Metering Mode]: 252)
	Center marker (→ [Center Marker]: 576)
	Self-timer (→ Recording Using the Self-timer: 227)
	Operation lock (→ [Operation Lock Setup]: 560)
XXmXXs	Elapsed recording time (→ Screen Displays While Video Recording: 326)



(5)

2021.12. 1 10:00:00	Time stamp recording (→ [Time Stamp Rec.]: 547)
	Focus (turns green) (→ Recording: 77) Recording state (turns red) (→ Screen Displays While Video Recording: 326)
LOW 	Focus (in low light AF situations) (→ Low illumination AF: 129)
STAR 	Focus (Starlight AF) (→ Starlight AF: 129)
	Flash adjustment (→ [Flash Adjust.]: 313)
iA P A S M  C3-1 P	Recording mode (→ Selecting the Recording Mode: 79)
	Program Shift (→ Program Shift: 255)

	Metering mode (→ [Metering Mode]: 252)
AEL	AE Lock (→ Locking Focus and Exposure (AF/AE Lock): 271)
60	Shutter speed
F3.5	Aperture value
^{BKT} F3.5	Aperture Bracket (→ [More Settings] (Aperture Bracket): 236)
^{BKT}  +1/3	Exposure compensation value (→ Exposure Compensation: 269) Exposure Bracket (→ [More Settings] (Exposure Bracket): 235)
 +1	Manual Exposure Assist (→ Manual Exposure Assist: 266)
ISO 200	ISO sensitivity (→ ISO Sensitivity: 273)
	Card access indication (turns red) (→ Screen Displays While Video Recording: 326)
	Card slot (→ Inserting Cards (Optional): 59) Double card slot function (→ [Double Card Slot Function]: 118)
	No card
	Card full
999	Number of still images that can be taken (→ Number of Still Images That Can Be Taken and Video Recording Time with Cards: 766)
r20	Number of pictures that can be taken continuously (→ Number of Pictures That Can Be Taken Continuously: 187)
XXmXXs	Video recording time (→ Number of Still Images That Can Be Taken and Video Recording Time with Cards: 766)
 	Battery indication/Power supply (→ Power Indications: 55)
 BG	Battery Grip (→ Battery Grip (Optional): 709)

(6)

	Temperature rise warning icon (→ Recording: 737)
	Image being sent (→ [Auto Transfer]: 639)
Touch Tab (→ [Touch Settings]: 559)	
	
	Fn button (→ Use [Fn3] to [Fn7] (Touch Icons): 486)
	
	Touch Zoom (→ Touch operation: 178)
	Touch AF, Touch Shutter (→ Touch AF/Touch Shutter: 108)
	Exposure compensation (→ Exposure Compensation: 269)
	Touch AE (→ Touch AE: 111)
	Focus Peaking (→ [Focus Peaking]: 524)
 (→ Setting a Filter with Touch Operation: 297)/	
 (→ Operations During Video Recording: 333)	
	Type of defocus ([Miniature Effect]) (→ Setting the Type of Defocus ([Miniature Effect]): 299)
	One Point Color (→ Setting the Color to Be Left ([One Point Color]): 300)
	Light source position ([Sunshine]) (→ Setting the Light Source Position and Size ([Sunshine]): 301)
	Filter effect adjustment (→ Adjusting the Filter Effect: 295)
	Filter on/off (→ Setting a Filter with Touch Operation: 297)

MINI	Filter setting (→ [Filter Settings]: 293)
	Touch Zoom (→ Operations During Video Recording: 333)
F	Aperture value (→ Operations During Video Recording: 333)
SS	Shutter speed (→ Operations During Video Recording: 333)
	Exposure compensation (→ Operations During Video Recording: 333)
ISO	ISO sensitivity (→ Operations During Video Recording: 333)
	Sound recording level adjustment (→ Operations During Video Recording: 333)

❖ Control Panel









(1)

	Recording mode (→ Selecting the Recording Mode: 79)
1/60	Shutter speed (→ Recording: 77)
F3.5	Aperture value (→ Recording: 77)
	Battery indication/Power supply (→ Power Indications: 55)
	Battery indication (battery grip) (→ Power Indications: 55)



(2)

	ISO sensitivity (→ ISO Sensitivity: 273)
	Exposure compensation value (→ Exposure Compensation: 269) Manual Exposure Assist (→ Manual Exposure Assist: 266)
	Flash setting (→ [Flash Adjust.]: 313 , [Flash Synchro]: 315 , Recording Using a Wireless Flash: 317) Flash mode (→ [Flash Mode]: 309)

(3)

	Drive mode (→ Selecting the Drive Mode: 182)
AFS	Focus mode (→ Selecting the Focus Mode: 125 , Record Using MF: 167)
	AF mode (→ Selecting the AF Mode: 135)
FINE PIXEL PIXEL 	Picture quality (→ [Picture Quality]: 116) Image area of video (→ [Image Area of Video]: 348) Recording file format (→ [Rec. File Format]: 337) Recording quality (→ [Rec Quality]: 338)
4:3 	Aspect ratio (→ [Aspect Ratio]: 114) Picture size (→ [Picture Size]: 115)
	Wi-Fi/Bluetooth connection state (→ Checking operation of the Wi-Fi and Bluetooth functions: 611)
Fn 	Fn button settings (→ Fn Buttons: 471)

(4)

 STD.	Photo Style (→ [Photo Style]: 285)
AWB	White balance (→ White Balance (WB): 278)
 OFF	i.Dynamic Range (→ [i.Dynamic Range]: 520)
	Metering mode (→ [Metering Mode]: 252)
	Card slot (→ Inserting Cards (Optional): 59)
	Double card slot function (→ [Double Card Slot Function]: 118)
	No card
	Card full
999	Number of still images that can be taken (→ Number of Still Images That Can Be Taken and Video Recording Time with Cards: 766)
r20	Number of pictures that can be taken continuously (→ Number of Pictures That Can Be Taken Continuously: 187)
RXXmXXs	Video recording time (→ Number of Still Images That Can Be Taken and Video Recording Time with Cards: 766)
----	No card

❖ Control Panel (Creative Video mode)

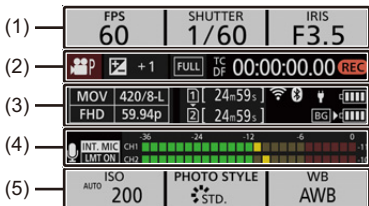







(1)

FPS 60	Frame rate (→ [Rec Quality]: 338) Variable frame rate (→ [Variable Frame Rate]: 382)
SHUTTER 1/60	Shutter speed
IRIS F3.5	Aperture value







(2)

	Exposure mode (→ Setting the Exposure for Recording Videos: 331)
	Exposure compensation value (→ Exposure Compensation: 269)
	Manual Exposure Assist (→ Manual Exposure Assist: 266)
	Image area of video (→ [Image Area of Video]: 348)
TC DF 00:00:00.00	Time code (→ Time Code: 350)
	Recording state (→ Screen Displays While Video Recording: 326)

(3)

	Recording file format (→[Rec. File Format]: 337) Recording quality (→[Rec Quality]: 338)
	Card slot (→Inserting Cards (Optional): 59) Double card slot function (→[Double Card Slot Function]: 118)
24m59s	Video recording time (→Number of Still Images That Can Be Taken and Video Recording Time with Cards: 766)
	Wi-Fi/Bluetooth connection state (→Checking operation of the Wi-Fi and Bluetooth functions: 611)
	Streaming function is ON (→16. Streaming Function: 676)
	Currently streaming (→16. Streaming Function: 676)
	Battery indication/Power supply (→Power Indications: 55)
	Battery indication (battery grip) (→Power Indications: 55)

(4)

	Mute (→[Mute Sound Input]: 365)
 	Built-in microphone, External microphone (→Audio Settings: 364, External Microphones (Optional): 436)
48kHz/16bit 	XLR microphone adaptor setting (→XLR Microphone Adaptor (Optional): 439)
 	Sound recording level limiter (→[Sound Rec Level Limiter]: 366)

Sound recording level (→[Sound Rec Level Disp.]: 364)







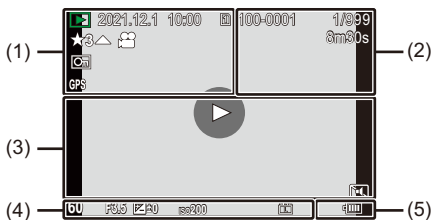

(5)



	ISO sensitivity (→ ISO Sensitivity: 273)
	Photo Style (→ [Photo Style]: 285)
	LUT View Assist (→ [V-LogL View Assist]: 398)
	HLG View Assist (→ [HLG View Assist]: 404)
	White balance (→ White Balance (WB): 278)

Playback Screen







(1)







	Playback mode (→ [Playback Mode]: 599)
2021.12.1 10:00	Recording date and time (→ Clock Set: 70)
	Card slot (→ Inserting Cards (Optional): 59)
★3	Rating (→ [Rating]: 604)
	Video playback (→ Playing Back Videos: 446)
	Protected picture (→ [Protect]: 604)
GPS	Location logging (→ [Location Logging]: 642)
	Obtaining information
	Cable disconnect prohibit icon
	Marker available (→ Picture Selection Slide View Screen Operations: 202 , 6K/4K Burst Playback Screen Operations: 204)
	Reduce Rolling Shutter (→ Correcting Distortion in Pictures ([Reduce Rolling Shutter]): 200)

	Saving pictures from a 6K/4K burst file (→ Selecting Pictures from a 6K/4K Burst File: 197)
	Saving pictures from a Post-Focus image (→ Selecting the Focus Point for the Picture to Save: 211)

(2)

100-0001	Folder/file number (→ Folder Structure Inside Card: 695)
1/999	Image number/Total number of images
9 pic. 9 files	Number of group images Number of files (→ Group Images: 456)
XXmXXs	Video recording time (→ Playing Back Videos: 446)
 XXmXXs XXs	Variable frame rate (→ [Variable Frame Rate]: 382)
 XXmXXs	Loop recording (→ [Loop Recording (video)]: 412)
	LUT View Assist (→ [V-LogL View Assist]: 398)
	HLG View Assist (→ [HLG View Assist]: 404)



(3)

	Playback (video) (→ Playing Back Videos: 446)
	Group images (→ Group Images: 456)
TC 00:00:00.00	Time code (→ Time Code: 350)
48kHz/16bit 	XLR microphone adaptor setting (→ XLR Microphone Adaptor (Optional): 439)
MP4 FHD 420/8-L	Recording file format (→ [Rec. File Format]: 337) Recording quality (→ [Rec Quality]: 338)
59.94p 60/59.94p	Recording frame rate (→ [Rec Quality]: 338) Variable frame rate (→ [Variable Frame Rate]: 382)
FULL  <small>PIXEL</small>	Image area of video (→ [Image Area of Video]: 348)
	Wi-Fi/Bluetooth connection state (→ Checking operation of the Wi-Fi and Bluetooth functions: 611)
	Silent mode (→ [Silent Mode]: 239)

(4)

Recording information

(5)

 	Battery indication/Power supply (→ Power Indications: 55)
	Battery Grip (→ Battery Grip (Optional): 709)

❖ Detailed information display

- (1) Card slot (→ [Inserting Cards \(Optional\): 59](#))
- (2) Recording date and time (→ [Clock Set: 70](#))
- (3) Folder/file number (→ [Folder Structure Inside Card: 695](#))
- (4) Recording information (basic)
- (5) Recording information (advanced)

Detailed information display

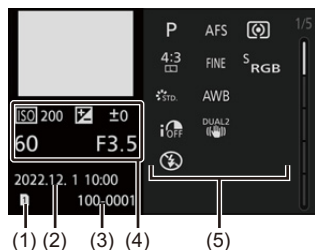

Histogram display

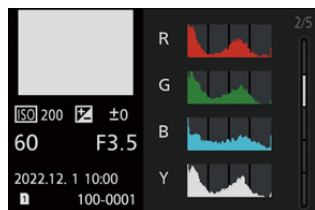
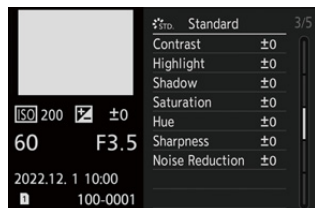
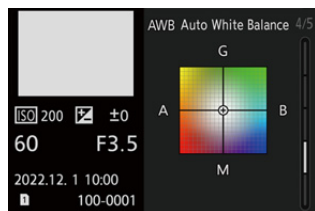

Photo Style display



White balance display



Lens information display



Message Displays

Meanings of main messages displayed on the camera screen, and response methods.

❖ Card

[Memory Card Error]/[Format this card?]

- It is a format that cannot be used with the camera.
Either insert another card, or back up any necessary data before formatting.
(→ [Formatting Cards \(Initialization\): 62](#))

[Memory Card Error]/[This memory card cannot be used]

- Use a card compatible with the camera. (→ [Memory Cards That Can Be Used: 25](#))

[Insert memory card again.]/[Try another card]

- Unable to access the card. Reinsert the card.
- Insert a different card.

[Read Error]/[Write Error]/[Please check the card]

- Failure to read or write data.
Turn off the camera, reinsert the card, and then turn it on again.
- The card may be broken.
- Insert a different card.

[Recording was cancelled due to the limitation of the writing speed of the card]

- The card does not meet the writing speed requirements for recording. Use a card of a supported Speed Class. (→ [Memory Cards That Can Be Used: 25](#))
- If the recording stops even when you are using a card that meets the specified Speed Class rating, the data writing speed of the card is getting slow. We recommend backing up data, and formatting. (→ [Formatting Cards \(Initialization\): 62](#))

❖ Lens

[The lens is not attached properly. Do not push lens release button while lens is attached.]

- Remove the lens once, and then attach it again without pressing the lens release button. (→ [Attaching a Lens: 63](#))
Turn on the camera again, and if it is still displaying, contact the dealer.

[Lens attachment failed. Please make sure the lens is attached correctly.]

- Remove the lens from the camera body and gently wipe the contacts on the lens and the camera body using a dry cotton swab.
Attach the lens, turn on the camera again, and if it is still displaying, contact the dealer.

❖ Battery

[This battery cannot be used]

- Use a genuine Panasonic battery.
If this message is displayed even when a genuine Panasonic battery is used, contact the dealer.
- If the terminal of the battery is dirty, remove the dirt and dust from the terminal.

❖ Others

[Some pictures cannot be deleted]/[This picture cannot be deleted]

- Images that do not comply with the DCF standard cannot be deleted.
Back up any necessary data before formatting the card. (→ [Formatting Cards \(Initialization\): 62](#))

[A folder cannot be created]

- The maximum number of folder numbers has been reached, so new folders cannot be created.
After formatting the card, execute [File Number Reset] in the [Setup] ([Card/File]) menu. (→ [\[File Number Reset\]: 123](#))

[Please turn camera off and then on again]/[System Error]

- Turn off and on the camera.
If the message is displayed even when doing this several times, contact the dealer.

Troubleshooting

- [Power, Battery: 736](#)
- [Recording: 737](#)
- [Video: 742](#)
- [Playback: 743](#)
- [Monitor/Viewfinder: 744](#)
- [Flash: 744](#)
- [Wi-Fi Function: 745](#)
- [TV, PC, Printer: 748](#)
- [Others: 749](#)

First, try out the following procedures.

If the problem is not resolved, it may be improved by selecting [Reset] (→[Reset]: 100) on the [Setup] ([Setting]) menu.

Power, Battery

The camera turns off automatically.

- [Power Save Mode] is enabled. (→[\[Power Save Mode\]: 57](#))

The battery becomes flat too quickly.

- When [6K/4K Pre-Burst] or [Pre-Burst Recording] is set, the battery drains faster. Set these settings only when recording.
- When connected to Wi-Fi, the battery drains quickly. Turn the camera off frequently such as by using [Power Save Mode] (→[\[Power Save Mode\]: 57](#)).

Recording

Recording stops before finishing. Cannot record. Cannot use some functions.

- In high ambient temperatures or if the camera is continuously used for High-definition video recording, high-speed burst pictures, and HDMI output etc., the temperature of the camera will rise.
If the camera temperature rises, [,] will be displayed blinking on the screen.
If you continue to use the camera, a message indicating the camera cannot be used is displayed on the screen and recording or HDMI output stops.
Wait until the camera cools down.

Cannot record images. The shutter will not operate immediately when the shutter button is pressed.

- If [Focus/Shutter Priority] is set to [FOCUS], then recording will not take place until focus is achieved. (→[\[Focus/Shutter Priority\]: 553](#))

The recorded image is whitish.

- Images may look whitish when the lens or image sensor gets dirty with fingerprints or similar.
If the lens is dirty, turn the camera off, then wipe the lens surface with a soft, dry cloth.
For information about how to clean the image sensor (→[Dirt on the Image Sensor: 752](#))

The recorded image is too bright or dark.

- Ensure AE Lock is not set where it is not appropriate. (→ [Locking Focus and Exposure \(AF/AE Lock\): 271](#))

Multiple images are recorded at once.

- When drive mode is set to [] (Burst Shot), pressing and holding the shutter button will take burst pictures. (→ [Selecting the Drive Mode: 182](#))
- When [Bracketing] is set, then pressing the shutter button records multiple images while automatically changing the settings. (→ [Bracket Recording: 231](#))

The subject is not focused properly.

- Confirm the following details:
 - Is the subject outside of the focus range?
 - Is [Shutter AF] set to [OFF]? (→ [Shutter AF: 556](#))
 - Is [Focus/Shutter Priority] set to [RELEASE]? (→ [Focus/Shutter Priority: 553](#))
 - Is AF Lock (→ [Locking Focus and Exposure \(AF/AE Lock\): 271](#)) set where it is not appropriate?

The recorded image is blurred. The image stabilizer is not effective.

- The shutter speed will become slower and the image stabilizer function may not work properly when recording in dark places.
In these cases, use a tripod and the self-timer when recording.

The recorded image looks rough. Noise appears on the picture.

- Try the following:
 - Reduce the ISO sensitivity. (→ [ISO Sensitivity: 273](#))
 - Increase [Noise Reduction] of [Photo Style] to the positive direction, or adjust each item other than [Noise Reduction] to the negative direction. (→ [Adjusting Image Quality: 288](#))
 - Set [Long Exposure NR] to [ON]. (→ [Long Exposure NR: 519](#))
- When using the camera continuously, the temperature inside of the camera rises and the image quality may deteriorate.
Turning the camera off except when recording is recommended.

The subject appears distorted on the image.

- When a moving subject is recorded while using the following functions, the subject may appear distorted in the picture:
 - [ELEC.]
 - Video recording
 - [6K/4K PHOTO]
- This is a characteristic of the MOS sensor that is the image sensor of the camera, and is not a malfunction.

Striping or flicker may appear under lighting such as fluorescent or LED lighting.

- This is characteristic of MOS sensors which serve as the camera's pickup sensors. This is not a malfunction.
- When using the electronic shutter (→ [\[Shutter Type\]: 240](#)), lowering the shutter speed may reduce the effect of the horizontal stripes.
- If flicker or horizontal stripes are noticeable when recording video, this can be mitigated by fixing the shutter speed.

Either set [\[Flicker Decrease \(Video\)\]](#) (→ [\[Flicker Decrease \(Video\)\]: 535](#)), or fix the shutter speed with the [\[M\]](#) mode (→ [Creative Video Mode: 330](#)).

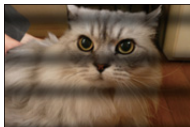

Stripes appear in high ISO sensitivity.

- Stripes may appear in high ISO sensitivity or depending on the lens you use. Decrease the ISO sensitivity. (→ [ISO Sensitivity: 273](#))

The brightness or coloring of the recorded image is different from the actual scene.

- When recording under lighting such as fluorescent or LED lighting, increasing the shutter speed may introduce slight changes to brightness or coloring. These are a result of the characteristics of the light source and do not indicate a malfunction.
- When recording subjects in extremely bright locations or recording under lighting such as fluorescent, LED, mercury, or sodium lighting, the coloring or screen brightness may change or horizontal striping may appear on the screen.

Bright spot not in subject is recorded.

- Pixels may be missing from the image sensor.
Perform [Pixel Refresh]. (→[\[Pixel Refresh\]: 595](#))

Video

Cannot record videos.

- When using a large capacity card, you may not be able to record for a while after turning on the camera.

Video recording stops in the middle.

- Recording video requires a card of a supported Speed Class. Use a compatible card. (→[Memory Cards That Can Be Used: 25](#))

In videos, abnormal clicking and buzzing sounds are recorded.

The recorded audio is very quiet.

- Depending on the recording conditions or the lens used, the sound of aperture and focus actions may be recorded in videos.
You can set the focus operation during video recording to [OFF] in [Continuous AF] (→[\[Continuous AF\]: 354](#)).
- Do not block the microphone hole during video recording.

An operation sound is recorded in a video.

- We recommend setting the [P/M] mode and recording with touch operation if you are bothered about the operation sounds during recording. (→[Operations During Video Recording: 333](#))

Playback

Cannot playback. There are no recorded pictures.

- Folders and images processed on a PC cannot be played on the camera.
- Some images are not displayed when the [Playback Mode] is set. Set to [Normal Play]. (→[\[Playback Mode\]: 599](#))
- Videos recorded with a different [System Frequency] setting cannot be played back. Return the [System Frequency] setting to the one you used during the recording. (→[\[System Frequency\]: 336](#))

Monitor/Viewfinder

The monitor/viewfinder turns off when the camera is turned on.

- If no operations are performed during the set time period, [Auto LVF/Monitor Off] (→[Auto LVF/Monitor Off]: 57) is activated, and the monitor/viewfinder turns off.
- When an object or your hand is positioned near the eye sensor, the monitor display may switch to the viewfinder display.

It may flicker for an instant or the brightness of the screen may change significantly for an instant.

- This occurs when the shutter button is pressed halfway, or when the subject brightness changes, making the lens aperture change.
This is not a malfunction.

Unevenly bright parts or irregular colors appear on the viewfinder.

- The viewfinder of the camera is built with OLED components. Screen burn-in may occur on the screen/viewfinder when a same image is displayed for a long period of time, but it does not affect the recorded images.

Flash

The flash does not fire.

- The flash does not fire when using the following functions:
 - Video recording/[6K/4K PHOTO]/[Post-Focus]
 - [ELEC.]/[Silent Mode]
 - [Filter Settings]

Wi-Fi Function

A Wi-Fi connection cannot be established. Radio waves get disconnected. Wireless access point is not displayed.

General tips for using a Wi-Fi connection

- Use within the communication range of the device to be connected.
- Usage near devices that utilize the 2.4 GHz frequency such as microwave ovens and cordless telephones may result in the radio wave being lost.
Use the camera at a sufficient distance from these devices.
- When the remaining battery level is low, it may not be possible to connect to or maintain communication with other devices.
(A message such as [Communication error] is displayed.)
- If you place the camera on a metal table or shelf, the radio waves may be adversely affected. In such cases, you may not be able to establish a connection.
Move the camera away from the metal surface.

Wireless access point

- Confirm that the connected wireless access point can be used.
- Confirm the radio wave conditions of the wireless access point.
 - Move the camera closer to the wireless access point.
 - Change the location and angle of the wireless access point.
- Depending on the wireless access point, the radio wave may not be displayed even though it is present.
 - Turn off and then on the wireless access point.
 - If the wireless channel of the wireless access point cannot be set automatically, manually set the channel supported by the camera.
 - If the wireless access point SSID is set not to broadcast, it may not be detected.
Enter the SSID, and then connect. (→ [Connecting by Manual Input: 665](#))
- Depending on the wireless access point, connection may be automatically disconnected after specific time has passed.
Reconnect the connection again.

Cannot connect with a wireless access point.

- The wireless access point information set on the camera is wrong.
Check the authentication type and encryption key. (→ [Connecting by Manual Input: 665](#))
- Radio waves from other devices may block the connection to a wireless access point.
Check the status of other devices that are connected to the wireless access point as well as the status of other wireless devices.

Wi-Fi connection on an iOS device fails.

- Follow the message displayed to allow connection to the camera.
If you still cannot connect, select the SSID of the camera on the Wi-Fi setup screen of the smartphone to connect.
If the SSID is not displayed, turn off and on the camera, then perform the connection settings again.

Wi-Fi connection with a smartphone is not possible.

- Change the access point to connect to in the smartphone Wi-Fi settings to the camera.

When trying to connect to a PC by Wi-Fi, this does not recognize the user name and password, and connection is not possible.

- Depending on the version of the OS, there are two types of user account (local account/Microsoft account).
Ensure you use the local account user name and password.

The PC is not recognized when I use a Wi-Fi connection. The camera cannot be connected to the PC using the Wi-Fi function.

- At the time of purchase, this camera is set to use a workgroup name of "WORKGROUP".

If you have changed the workgroup name of the PC, this will not be recognized.

In the [Wi-Fi Setup] menu, [PC Connection], change the workgroup name of the PC to which to connect. (→[PC Connection]: 674)

- Check that the login name and password are correctly typed.
- When the clock settings of the PC connected to the camera differs considerably from those of the camera, the camera cannot be connected to the PC depending on the OS.

I have forgotten the password for the Wi-Fi.

- In the [Setup] ([Setting]) menu, [Reset], reset network settings. (→[Reset]: 100)
However, all information set in [Wi-Fi Setup] and [Bluetooth] will also be reset.

TV, PC, Printer

The TV images are displayed with gray bands.

- Depending on the [Aspect Ratio], gray bands may be displayed on the top and bottom or the left and right of the images. You can change the band color in [Background Color(Playback)] in [HDMI Connection] of the [Setup] ([IN/OUT]) menu. (→[HDMI Connection]: 590)

Images cannot be imported even when connected to a PC.

- Set the [USB Mode] of the camera to [PC(Storage)]. (→[USB]: 589)
- Turn the camera off and on.

Cannot print when the camera is connected to a printer.

- Pictures cannot be printed using a printer that does not support PictBridge.
- Set the camera's [USB Mode] to [PictBridge(PTP)]. (→[USB]: 589)

Others

When the camera is shaken, a rattling sound is heard from the camera.





- The sound is caused by the in-body stabilizer. This is not a malfunction.

There is rattling noise from the lens when the camera is turned on or off, or when the camera is swung. There is a sound from the lens when recording.

- This is the sound of the lens moving and aperture operation. It is not a malfunction.

An unreadable language was selected by mistake.

- Reselect the language from the menu using the following procedure:

 ⇒ [] ⇒ [] ⇒ [] ⇒ Select desired language (⇒ [\[Language\]: 596](#))

The camera becomes warm.

- The camera surface and back of the monitor may become warm during use, but this does not indicate a problem with performance or quality.

Cautions for Use

❖ The camera

Keep this unit as far away as possible from electromagnetic equipment (such as microwave ovens, TVs, video games etc.).

- If you use this unit on top of or near a TV, the pictures and/or sound on this unit may be disrupted by electromagnetic wave radiation.
- Do not use this unit near cell phones because doing so may result in noise adversely affecting the pictures and/or sound.
- Recorded data may be damaged, or pictures may be distorted, by strong magnetic fields created by speakers or large motors.
- Electromagnetic wave radiation may adversely affect this unit, disturbing the pictures and/or sound.
- If this unit is adversely affected by electromagnetic equipment and stops functioning properly, turn this unit off and remove the battery or disconnect AC adaptor. Then reinsert the battery or reconnect AC adaptor and turn this unit on.

Do not use this unit near radio transmitters or high-voltage lines.

- If you record near radio transmitters or high-voltage lines, the recorded pictures and/or sound may be adversely affected.

Always use the supplied cords and cables.

If you use optional accessories, use the cords and the cables supplied with them.

Do not extend the cords or the cables.

Do not keep objects such as credit cards that may be influenced magnetically close to this unit.

The data on these objects may become corrupted and unusable.

Do not spray the camera with insecticides or volatile chemicals.

- If the camera is sprayed with such chemicals, the body of the camera may be damaged and the surface finish may peel off.

Do not keep products made of rubber, PVC or similar materials in contact with the camera for a long period of time.

❖ When using in cold places or at low temperatures

- **Skin burns may result if you leave the metal parts of the camera in direct contact with the skin for long periods of time at cold places (environments with temperatures at or below 0 °C (32 °F), such as ski resorts or places at high altitude).**

Use gloves or similar when using it for long periods.

- The performance of the battery (Number of pictures that can be taken/available recording time) may decrease temporarily at temperatures between – 10 °C and 0 °C (14 °F and 32 °F).
Keep the battery warm as you are using by keeping it inside your cold weather gear or clothes. Battery performance will recover when the internal temperature rises again.
- The battery cannot be charged at temperatures below 0 °C (32 °F).
An error message is shown on the charger or on the camera body when charging is not possible.
 - When charging with the charger: The 50 % charged light blinks rapidly.
 - When charging in the camera body: The charging light blinks.
- If using in cold locations, do not allow water droplets and snow to remain on the camera.
If these are left on the camera, water may freeze in gaps in the camera on/off switch, speaker, and microphone, making these parts difficult to move, and/or leading to reduced volume. This is not a malfunction.

❖ Cleaning

Before cleaning the camera, remove the battery or the DC Coupler, and disconnect the power plug from the electrical outlet. Then wipe the camera with a dry, soft cloth.

- When the camera is soiled badly, it can be cleaned by wiping the dirt off with a wrung wet cloth, and then with a dry cloth.
- Do not use solvents such as benzine, thinner, alcohol, kitchen detergents, etc., to clean the camera, since it may deteriorate the external case or the coating may peel off.
- When using a chemical cloth, be sure to follow the accompanying instructions.

❖ Dirt on the Image Sensor

If dirt gets inside the mount when changing lenses, depending on the recording conditions, it may adhere to the image sensor and appear on the recorded picture.

To prevent debris or dust adhering to internal parts of the body, avoid changing the lens in a dusty environment and always fit the body cap or a lens when storing the camera.

Remove any dirt on the body cap before attaching it.

Dust reduction function

The camera has a dust reduction function that will blow off the dirt and dust that have affixed to the front of the image sensor.

If the dirt is particularly noticeable, from the [Setup] ([Others]) menu, perform [Sensor Cleaning]. (→[Sensor Cleaning]: 595)

Removing dirt on the image sensor

The image sensor is very precise and delicate, so be sure to observe the following when you do have to clean it yourself.

- Blow dust off the surface of the image sensor using a commercially available blower. Do not blow the dust off with excessive power.
- Do not put the blower further inside than the lens mount. The blower can scratch the image sensor if it touches.
- Do not use any objects except a blower to clean the image sensor.
- If you cannot remove the dirt or dust with the blower, consult the dealer or Panasonic.

❖ Cleaning the Viewfinder

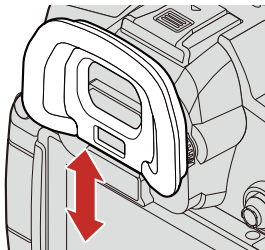

If the viewfinder is dirty, then remove the eye cup and clean.

Blow dirt off the surface of the viewfinder using a commercially available blower, then lightly wipe with a soft, dry cloth.

- After cleaning, attach the eye cup.
- Be careful not to lose the eye cup.

❖ Monitor/Viewfinder

- Do not push hard on the monitor.

This may cause irregular coloration or malfunction.

- Extremely high precision technology is employed to produce the monitor/viewfinder screen. However there may be some dark or bright spots, or spots that light constantly (red, blue, or green) on the screen.

This is not a malfunction.

Though the monitor/viewfinder screen parts are produced with highly controlled precision technology, some pixels may be inactive or always lit.

The spots will not be recorded on images on a card.

❖ Lens

- **When using this lens, take care not to drop, bump, or apply undue force to it. Doing so may cause malfunction or damage to this lens and the digital camera.**

- Do not aim the lens at the sun or strong light sources.

The concentrated light may cause fire or damage.

- Images may be affected by dust, dirt, and soiling (water, oil, fingerprints, etc.) on the lens surface.

Before and after recording, use a blower to blow off dust and dirt from the surface of the lens, then lightly wipe with a soft dry cloth to remove soiling.

- When the camera is not being used, attach the lens cap and lens rear cap to prevent dust and dirt from adhering to or entering the camera.

- To protect the lens contact points (A), do not do the following.

These may cause a malfunction.

- Touch the lens contact points.
- Soil the lens contact points.
- Place the lens with its mount surface facing down.

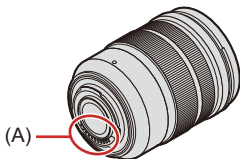

- To improve the dust and splash resistant performance of the interchangeable lens (H-ES12060/H-FS12060), a lens mount rubber is used in the mount.
 - The lens mount rubber will leave scuff marks on the digital camera mount, but this does not impact performance.
 - To replace the lens mount rubber, contact Panasonic.

❖ Battery

The battery is a rechargeable lithium ion battery.

It is highly sensitive to temperature and humidity, and the effect on performance increases as the temperature rises or drops.

Always remove the battery after use.

- Place the removed battery in a plastic bag, etc., and keep away from metallic objects (clips, etc.) for storage or transport.

If you drop the battery accidentally, check to see if the body of the battery and the contacts are deformed.

- Damage to the camera will result if a battery with deformed contacts is inserted into the camera.

Dispose of unusable battery.

- The battery has a limited life.
- Do not throw the battery into fire because it may cause an explosion.
- The unusable battery should be discarded in accordance with battery recycling laws. Call the RBRC hotline at 1-800-822-8837 for information.

Do not allow battery terminals to come into contact with metal objects (such as necklaces, hairpins, etc.).

- This can cause short-circuiting or heat generation and you may be badly burned if you touch a battery.

❖ Charger, AC Adaptor

- The charging lights may blink under the influence of static electricity or electromagnetic wave, depending on the charging environment. This phenomenon has no effects on charging.
- If you use the AC adaptor near a radio, the radio reception may be disturbed. Keep the AC adaptor 1 m (3.3 feet) or more away from radio.
- During usage, the AC adaptor may emit an electrical hum; this is not a malfunction.
- After use, be sure to disconnect the power plug from the electrical outlet. (A very small amount of current is consumed if it is left connected.)
- Keep the contacts (B) of the charger and battery clean. Wipe them with a dry cloth if they get dirty.

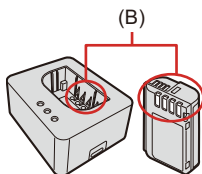

❖ Card

Do not leave the card in areas with high temperatures, direct sunlight, or areas prone to electromagnetic waves and static.

Do not bend or drop the card.

Do not subject the card to strong vibration.

- Otherwise, the card and recorded data may be damaged.
- Put the card in the card case or the storage bag after use and when storing or carrying the card.
- Do not allow dirt, water or other foreign objects to get into the contacts on the card. Additionally, do not touch the contacts with your hands.

Personal Information

Personal information is stored within the camera and in recorded images. We recommend that you enhance security by setting a Wi-Fi password and Wi-Fi function lock to protect personal information. (→ [\[Wi-Fi Setup\] Menu: 674](#))

- Images may contain information that can be used to identify the user, such as recording dates and times, and location information.
Confirm details carefully before uploading images to a web service.

Disclaimer

- Information including personal information may be altered or vanish due to erroneous operation, effect of static electricity, accident, malfunction, repair, or other handlings.

Please note in advance that Panasonic is not liable in any way for any direct or indirect damage from the alteration or vanishing of information or personal information.

When requesting a repair or transferring/disposing of the camera

- After making a copy of personal information, be sure to delete information, including personal information, such as wireless LAN connection settings that you have registered or saved within the camera with [Reset] (→ [\[Reset\]: 100](#)).
- Reset the settings to protect the personal information. (→ [\[Reset\]: 100](#))
- Remove the card from the camera.
- Settings may return to factory default when camera is repaired.
- Please contact the dealer where you purchased the camera or Panasonic if above operations are not possible due to malfunction.

Points to remember when disposing of/transferring the memory card

Format or delete using the camera or a PC will only modify the file management information, so it will not delete the data in the card completely.

We recommend physically destroying the card or using commercially available PC data deletion software to delete the card data completely when disposing of/transferring the card.

You are responsible for handling of data on cards.

❖ When Not Using the Camera for a Long Period of Time

- Ensure you remove the battery and card from the camera.
If the battery is left in the camera, it may over-discharge, and be rendered unusable even after charging.
- Store the battery in a cool and dry place with a relatively stable temperature. (Recommended temperature: 15 °C to 25 °C (59 °F to 77 °F); recommended humidity: 40 %RH to 60 %RH)
- If storing for a long period of time, it is recommended that the battery be charged once per year, fully drained in the camera, then removed from the camera and then stored again.
- We recommend storing the camera with a desiccant (silica gel) when you keep it in a closet or a cabinet.
- Check all the parts before recording when you have not used the camera for a long period of time.

❖ Image Data

- Recorded data may be damaged or lost if the camera breaks down due to inappropriate handling.
Panasonic will not be liable for any damage caused due to loss of recorded data.

❖ Tripod

- Make sure the tripod is stable when the camera is attached to it.
- When using a tripod, removal of the battery may not be possible.
- When using this unit with a large-diameter lens, the lens may come into contact with the pedestal depending on the tripod.

Tightening the screw with the lens and pedestal in contact with each other may damage this unit or the lens.

Therefore it is recommended to attach the tripod adaptor (DMW-TA1: optional) before mounting on the tripod.

- Also refer to the operating instructions for the tripod.

❖ Shoulder Strap

- If you attach a heavy interchangeable lens to the camera body, do not carry the camera by the shoulder strap.

Hold the camera and the lens when carrying them.

❖ Wi-Fi Function

Use the camera as a wireless LAN device

When using devices or computer systems that require more reliable security than wireless LAN devices, ensure that the appropriate measures are taken for safety designs and defects for the systems used.

Panasonic will not take any responsibility for any damage that arises when using the camera for any purpose other than as a wireless LAN device.

Use of the Wi-Fi function of the camera is presumed to be in countries where it is sold

There is the risk that the camera violates the radio wave regulations if used in countries other than those where it is sold, and Panasonic takes no responsibility for any violations.

There is the risk that data sent and received via radio waves may be intercepted

Please note that there is the risk that data sent and received via radio waves may be intercepted by a third party.

Do not use the camera in areas with magnetic fields, static electricity or interference

- Do not use the camera in areas with magnetic fields, static electricity or interference, such as near microwave ovens.
These may cause the interruption of the radio waves.
- Using the camera near devices such as microwave ovens or cordless telephones that use the 2.4 GHz radio wave band may cause a decrease in performance in both devices.

Do not connect to the wireless network you are not authorized to use

When using Wi-Fi, wireless networks (SSID) that you are not allowed to use may be displayed, but you should not connect to these as it may be viewed as unauthorized access.

Number of Pictures That Can Be Taken and Available Recording Time with the Battery

Listed below are the numbers of pictures that can be taken and the time lengths available for recording when the supplied battery is being used.

- The number of pictures that can be taken is according to the CIPA (Camera & Imaging Products Association) standards.
- Using a Panasonic UHS-II compatible SDXC memory card.
- The values listed are approximate.

❖ Recording Pictures (When Using the Monitor)

When the interchangeable lens (H-ES12060) is used

Number of pictures that can be taken: 400

When the interchangeable lens (H-FS12060) is used

Number of pictures that can be taken: 410

❖ Recording Pictures (When Using the Viewfinder)

When the interchangeable lens (H-ES12060) is used

Number of pictures that can be taken: 400 (1200)

When the interchangeable lens (H-FS12060) is used

Number of pictures that can be taken: 410 (1200)

- The numbers in parentheses indicate the values that result when [Time to Sleep] in [Power Save LVF Shooting] is set to [1SEC] and the [Power Save LVF Shooting] function works as intended.
(Based on the test conditions derived from the CIPA standard and specified by Panasonic)

❖ Recording Videos (When Using the Monitor)

[Rec. File Format]: [MP4]

When the interchangeable lens (H-ES12060) is used		
[Rec Quality]	Continuous available recording time (Actual available recording time) (minutes)	
	[Image Area of Video]	
	[FULL]	[PIXEL/PIXEL]
[4K/10bit/100M/60p] [4K/10bit/100M/50p]	120 (60)	120 (60)
[4K/8bit/100M/30p] [4K/8bit/100M/25p]	130 (65)	130 (65)
[FHD/8bit/28M/60p] [FHD/8bit/28M/50p]	140 (70)	150 (75)
When the interchangeable lens (H-FS12060) is used		
[Rec Quality]	Continuous available recording time (Actual available recording time) (minutes)	
	[Image Area of Video]	
	[FULL]	[PIXEL/PIXEL]
[4K/10bit/100M/60p] [4K/10bit/100M/50p]	120 (60)	130 (65)
[4K/8bit/100M/30p] [4K/8bit/100M/25p]	130 (65)	140 (70)
[FHD/8bit/28M/60p] [FHD/8bit/28M/50p]	140 (70)	160 (80)

[Rec. File Format]: [MOV]

When the interchangeable lens (H-ES12060) is used		
[Rec Quality]	Continuous available recording time (Actual available recording time) (minutes)	
	[Image Area of Video]	
	[FULL]	[PIXEL/PIXEL]
[4K/60p/420/10-L] [4K/50p/420/10-L]	110 (55)	120 (60)
[4K/30p/422/10-L] [4K/25p/422/10-L]	120 (60)	130 (65)
[FHD/60p/422/10-L] [FHD/50p/422/10-L]	130 (65)	140 (70)
[FHD/60p/420/8-L] [FHD/50p/420/8-L]	140 (70)	150 (75)
When the interchangeable lens (H-FS12060) is used		
[Rec Quality]	Continuous available recording time (Actual available recording time) (minutes)	
	[Image Area of Video]	
	[FULL]	[PIXEL/PIXEL]
[4K/60p/420/10-L] [4K/50p/420/10-L]	120 (60)	120 (60)
[4K/30p/422/10-L] [4K/25p/422/10-L]	130 (65)	120 (60)
[FHD/60p/422/10-L] [FHD/50p/422/10-L]	130 (65)	130 (65)
[FHD/60p/420/8-L] [FHD/50p/420/8-L]	140 (70)	140 (70)

- Actual available recording time is the time available for recording when repeating actions such as turning the camera on and off, starting/stopping recording, etc.

❖ Playback (When Using the Monitor)

When the interchangeable lens (H-ES12060) is used

Playback time (minutes): 240

When the interchangeable lens (H-FS12060) is used

Playback time (minutes): 250

- The number of pictures that can be taken and the available recording time vary depending on the surrounding environment and the usage conditions.
For example, these will reduce in the following case:
 - In low-temperature environments, such as on ski slopes.
- If the usage duration drops significantly even when the battery is fully charged, then the battery is at the end of its service life.
Replace with a new battery.

Number of Still Images That Can Be Taken and Video Recording Time with Cards

Listed below are the numbers of pictures and the time lengths of videos that can be recorded on a card.

- The values listed are approximate.

❖ Number of Still Images That Can Be Taken

- [Aspect Ratio]: [4:3]; [Picture Quality]: [FINE]

[Picture Size]	Card capacity		
	32 GB	64 GB	128 GB
[L] (20M)	2910	5810	11510
[M] (10.5M)	5280	10510	20810
[S] (5M)	9220	17640	34940

- [Aspect Ratio]: [4:3]; [Picture Quality]: [RAW+FINE]

[Picture Size]	Card capacity		
	32 GB	64 GB	128 GB
[L] (20M)	900	1810	3590
[M] (10.5M)	1050	2110	4180
[S] (5M)	1150	2290	4550

❖ Video Recording Time

- “h” is an abbreviation for hour, “m” for minute and “s” for second.
- Video recording time is the total time of all the videos which have been recorded.

• **[Rec. File Format]: [MP4]**

[System Frequency]: [59.94Hz (NTSC)]

[Rec Quality]	Card capacity		
	32 GB	64 GB	128 GB
[4K/10bit/100M/60p] [4K/8bit/100M/30p] [4K/8bit/100M/24p]	41m00s	1h25m	2h45m
[4K/10bit/72M/30p] [4K/10bit/72M/24p]	58m00s	1h55m	3h55m
[FHD/8bit/28M/60p]	2h25m	4h55m	9h45m
[FHD/8bit/24M/24p]	2h50m	5h40m	11h25m
[FHD/8bit/20M/30p]	3h15m	6h30m	13h00m

[System Frequency]: [50.00Hz (PAL)]

[Rec Quality]	Card capacity		
	32 GB	64 GB	128 GB
[4K/10bit/100M/50p] [4K/8bit/100M/25p]	41m00s	1h25m	2h45m
[4K/10bit/72M/25p]	58m00s	1h55m	3h55m
[FHD/8bit/28M/50p]	2h25m	4h55m	9h45m
[FHD/8bit/20M/25p]	3h15m	6h30m	13h00m

- [Rec. File Format]: [MOV]
[System Frequency]: [59.94Hz (NTSC)]

[Rec Quality]	Card capacity		
	32 GB	64 GB	128 GB
[4K-A/30p/422/10-I]/[4K-A/24p/422/10-I]/ [C4K/30p/422/10-I]/[C4K/24p/422/10-I]/ [4K/30p/422/10-I]/[4K/24p/422/10-I]	10m00s	21m00s	42m00s
[6K-A/30p/420/10-L]/[6K-A/24p/420/10-L]/ [C4K/60p/420/10-L]/[4K/60p/420/10-L]/ [FHD/60p/422/10-I]/[FHD/30p/422/10-I]/ [FHD/24p/422/10-I]	20m00s	42m00s	1h20m
[4K-A/60p/420/8-L]/[4K-A/30p/422/10-L]/ [4K-A/24p/422/10-L]/[C4K/60p/420/8-L]/ [C4K/30p/422/10-L]/[C4K/24p/422/10-L]/ [4K/60p/420/8-L]/[4K/30p/422/10-L]/ [4K/24p/422/10-L]	27m00s	56m00s	1h50m
[4K-A/30p/420/8-L]/[4K-A/24p/420/8-L]/ [C4K/30p/420/8-L]/[C4K/24p/420/8-L]/ [4K/30p/420/8-L]/[4K/24p/420/8-L]/ [FHD/60p/422/10-L]/[FHD/60p/420/8-L]/ [FHD/30p/422/10-L]/[FHD/30p/420/8-L]/ [FHD/24p/422/10-L]/[FHD/24p/420/8-L]	41m00s	1h25m	2h45m

[System Frequency]: [50.00Hz (PAL)]

[Rec Quality]	Card capacity		
	32 GB	64 GB	128 GB
[4K-A/25p/422/10-I]/[C4K/25p/422/10-I]/ [4K/25p/422/10-I]	10m00s	21m00s	42m00s
[6K-A/25p/420/10-L]/[4K-A/50p/420/10-L]/ [C4K/50p/420/10-L]/[4K/50p/420/10-L]/ [FHD/50p/422/10-I]/[FHD/25p/422/10-I]	20m00s	42m00s	1h20m
[4K-A/50p/420/8-L]/[4K-A/25p/422/10-L]/ [C4K/50p/420/8-L]/[C4K/25p/422/10-L]/ [4K/50p/420/8-L]/[4K/25p/422/10-L]	27m00s	56m00s	1h50m
[4K-A/25p/420/8-L]/[C4K/25p/420/8-L]/ [4K/25p/420/8-L]/[FHD/50p/422/10-L]/ [FHD/50p/420/8-L]/[FHD/25p/422/10-L]/ [FHD/25p/420/8-L]	41m00s	1h25m	2h45m

[System Frequency]: [24.00Hz (CINEMA)]

[Rec Quality]	Card capacity		
	32 GB	64 GB	128 GB
[4K-A/24p/422/10-I]/[C4K/24p/422/10-I]/ [4K/24p/422/10-I]	10m00s	21m00s	42m00s
[6K-A/24p/420/10-L]/[FHD/24p/422/10-I]	20m00s	42m00s	1h20m
[4K-A/24p/422/10-L]/[C4K/24p/422/10-L]/ [4K/24p/422/10-L]	27m00s	56m00s	1h50m
[4K-A/24p/420/8-L]/[C4K/24p/420/8-L]/ [4K/24p/420/8-L]/[FHD/24p/422/10-L]/ [FHD/24p/420/8-L]	41m00s	1h25m	2h45m







- The number of pictures that can be taken and the available recording time will be shorter depending on the SD card used when recording with [Segmented File Recording] or [Loop Recording (video)].
- Depending on the recording conditions and the type of card, number of still images that can be taken, video recording time vary.
- [9999+] is displayed on the recording screen if the remaining number of still images that can be taken is 10000 or more.
- The continuous recordable time for videos is displayed on the screen.





List of Default Settings/Custom Saving/ Settings Available for Copying







: Using [Reset], the function to return to default settings

: Using [Save to Custom Mode], the function to save settings details in the Custom mode







: Using [Save/Restore Camera Setting], the function to copy settings details





Menu		Default setting			
 [Photo]:  [Image Quality]					
[Photo Style]		[ STD.]	✓	✓	✓
[Metering Mode]		[ M]	✓	✓	✓
[Aspect Ratio]		[4:3]	✓	✓	✓
[Picture Quality]		[FINE]	✓	✓	✓
[Picture Size]		[L] (20M)	✓	✓	✓
[Long Exposure NR]		[ON]	✓	✓	✓
[ISO Sensitivity (photo)]	[ISO Auto Lower Limit Setting]	[200]	✓	✓	✓
	[ISO Auto Upper Limit Setting]	[AUTO]	✓	✓	✓
[Min. Shutter Speed]		[AUTO]	✓	✓	✓
[i.Dynamic Range]		[OFF]	✓	✓	✓
[Vignetting Comp.]		[OFF]	✓	✓	✓
[Diffraction Compensation]		[OFF]	✓	✓	✓
[Filter Settings]	[Filter Effect]	[OFF]	✓	✓	✓
	[Simultaneous Record w/o Filter]	[OFF]	✓	✓	✓





Menu		Default setting			
 [Photo]:  [Focus]					
[AF Custom Setting(Photo)]		[Set 1]	✓	✓	✓
[AF Assist Light]		[ON]	✓	✓	✓
[Focus Peaking]	[ON]/[OFF]	[ON]	✓	✓	✓
	[SET]	—	✓	✓	✓
[1-Area AF Moving Speed]		[FAST]	✓	✓	✓





Menu		Default setting			
 [Photo]:  [Flash]					
[Flash Mode]		[	✓	✓	✓
[Firing Mode]		[TTL]	✓	✓	✓
[Flash Adjust.]		[±0 EV]	✓	✓	✓
[Flash Synchro]		[1ST]	✓	✓	✓
[Manual Flash Adjust.]		[1/1]	✓	✓	✓
[Auto Exposure Comp.]		[OFF]	✓	✓	✓
[Wireless]		[OFF]	✓	✓	✓
[Wireless Channel]		[1CH]	✓	✓	✓
[Wireless FP]		[OFF]	✓	✓	✓
[Communication Light]		[HIGH]	✓	✓	✓
[Wireless Setup]		—	✓	✓	✓







Menu		Default setting			
 [Photo]:  [Others (Photo)]					
[Bracketing]	[Bracketing Type]	[OFF]	✓	✓	✓
	[More Settings]	—	✓	✓	✓
[Silent Mode]		[OFF]	✓	✓	✓
[Image Stabilizer]	[Operation Mode]	[]	✓	✓	✓
	[E-Stabilization (Video)]	[OFF]	✓	✓	✓
	[Boost I.S. (Video)]	[OFF]	✓	✓	✓
	[Anamorphic (Video)]	[OFF]	✓	✓	✓
	[Lens Information]	[Lens1]	✓		✓
[Burst Rate]		[H]	✓	✓	✓
[Shutter Type]		[MECH.]	✓	✓	✓
[Shutter Delay]		[OFF]	✓	✓	✓
[Ex. Tele Conv.]		[OFF]	✓	✓	✓
[Time Lapse/ Animation]	[Mode]	[Time Lapse Shot]	✓	✓	✓
	[Shooting Interval Setting]	[ON]	✓	✓	✓
	[Start Time]	[Now]	✓	✓	✓
	[Image Count]	[1]	✓	✓	✓
	[Shooting Interval]	[1m00s]	✓	✓	✓
	[Exposure Leveling]	[OFF]	✓	✓	✓
[Self Timer]		[ ₁₀]	✓	✓	✓
[6K/4K PHOTO]	[Picture Size / Burst Speed]	[6K 18M]	✓	✓	✓
	[Rec Method]	[]	✓	✓	✓
	[Pre-Burst Recording]	[OFF]	✓	✓	✓
[Post-Focus]		[6K 18M]	✓	✓	✓
[Multiple Exposure]	[Start]	—			
	[Auto Gain]	[ON]	✓	✓	✓
	[Overlay]	[OFF]	✓	✓	✓
[Time Stamp Rec.]		[OFF]	✓	✓	✓











Menu		Default setting			
 [Video]:  [Image Quality]					
[Exposure Mode]		[P]	✓	✓	✓
[Photo Style]		[ STD.]	✓	✓	✓
[Metering Mode]		[]	✓	✓	✓
[ISO Sensitivity (video)]	[ISO Auto Lower Limit Setting]	[200]	✓	✓	✓
	[ISO Auto Upper Limit Setting]	[AUTO]	✓	✓	✓
[Synchro Scan]		[OFF]	✓	✓	✓
[Flicker Decrease (Video)]		[OFF]	✓	✓	✓
[Master Pedestal Level]		[0]	✓	✓	✓
[SS/Gain Operation]		[SEC/ISO]	✓	✓	✓
[i.Dynamic Range]		[OFF]	✓	✓	✓
[Vignetting Comp.]		[OFF]	✓	✓	✓
[Diffraction Compensation]		[OFF]	✓	✓	✓
[Filter Settings]	[Filter Effect]	[OFF]	✓	✓	✓
	[Simultaneous Record w/o Filter]	[OFF]	✓	✓	✓







Menu		Default setting			
 [Video]:  [Image Format]					
[Rec. File Format]		When [System Frequency] is set to [59.94Hz (NTSC)] or [50.00Hz (PAL)]: [MP4]	✓	✓	✓
		When [System Frequency] is set to [24.00Hz (CINEMA)]: [MOV]			
[Image Area of Video]		[FULL]	✓	✓	✓
[Rec Quality]		When [System Frequency] is set to [59.94Hz (NTSC)]: [FHD/8bit/28M/60p]	✓	✓	✓
		When [System Frequency] is set to [50.00Hz (PAL)]: [FHD/8bit/28M/50p]			
		When [System Frequency] is set to [24.00Hz (CINEMA)]: [FHD/24p/420/8-L]			
[Rec Quality (My List)]		—	✓	✓	✓
[Variable Frame Rate]		[OFF]	✓	✓	✓
[Time Code]	[Time Code Display]	[OFF]	✓	✓	✓
	[Count Up]	[REC RUN]	✓	✓	✓
	[Time Code Value]	—			
	[Time Code Mode]	[DF]	✓	✓	✓
	[HDMI Time Code Output]	[OFF]	✓	✓	✓
[Luminance Level]		[16-255]	✓	✓	✓

Menu		Default setting			
 [Video]:  [Focus]					
[AF Custom Setting(Video)]	[ON]/[OFF]	[OFF]	✓	✓	✓
	[SET]	—	✓	✓	✓
[Continuous AF]		[MODE1]	✓	✓	✓
[AF Assist Light]		[ON]	✓	✓	✓
[Focus Peaking]	[ON]/[OFF]	[ON]	✓	✓	✓
	[SET]	—	✓	✓	✓
[1-Area AF Moving Speed]		[FAST]	✓	✓	✓















Menu		Default setting			
 [Video]:  [Audio]					
[Sound Rec Level Disp.]		[OFF]	✓	✓	✓
[Mute Sound Input]		[OFF]	✓	✓	✓
[Sound Rec Gain Level]		[STANDARD]	✓	✓	✓
[Sound Rec Level Adj.]		[0dB]	✓	✓	✓
[Sound Rec Level Limiter]		[ON]	✓	✓	✓
[Wind Noise Canceller]		[STANDARD]	✓	✓	✓
[Wind Cut]		[OFF]	✓	✓	✓
[Lens Noise Cut]		[ON]	✓	✓	✓
[Special Mic.]		[STEREO]	✓	✓	✓
[XLR Mic Adaptor Setting]		[48kHz/16bit]	✓	✓	✓
[Sound Output]		[REALTIME]	✓	✓	✓
[Headphone Volume]		[LEVEL3]	✓		✓





Menu		Default setting			
 [Video]:  [Others (Video)]					
[Silent Mode]		[OFF]	✓	✓	✓
[Image Stabilizer]	[Operation Mode]	[]	✓	✓	✓
	[E-Stabilization (Video)]	[OFF]	✓	✓	✓
	[Boost I.S. (Video)]	[OFF]	✓	✓	✓
	[Anamorphic (Video)]	[OFF]	✓	✓	✓
	[Lens Information]	[Lens1]	✓		✓
[Self Timer Setting]	[Self Timer]	[ 10]	✓	✓	✓
	[Self Timer For Video]	[OFF]	✓	✓	✓
[Focus Transition]	[Start]	—			
	[Focus Pull Setting]	—			
	[Focus Transition Speed]	[M]	✓	✓	✓
	[Focus Transition Rec]	[OFF]	✓	✓	✓
	[Focus Transition Wait]	[OFF]	✓	✓	✓
[Loop Recording (video)]		[OFF]	✓	✓	✓
[Segmented File Recording]		[OFF]	✓	✓	✓
[Live Cropping]		[OFF]	✓	✓	✓
[Time Stamp Rec.]		[OFF]	✓	✓	✓





Menu		Default setting			
 [Custom]:  [Image Quality]					
[Photo Style Settings]	[Show/Hide Photo Style]	—	✓	✓	✓
	[My Photo Style Settings]	—	✓	✓	✓
	[Reset Photo Style]	—			
[ISO Increments]		[1/3 EV]	✓	✓	✓
[Extended ISO]		[OFF]	✓	✓	✓
[Exposure Offset Adjust.]	[Multi Metering]	[±0EV]	✓	✓	✓
	[Center Weighted]	[±0EV]	✓	✓	✓
	[Spot]	[±0EV]	✓	✓	✓
	[Highlight Weighted]	[±0EV]	✓	✓	✓
[Color Space]		[sRGB]	✓	✓	✓
[Exposure Comp. Reset]		[OFF]	✓		✓
[Auto Exposure in P/A/S/M]		[ON]	✓	✓	✓
[CreativeVideo Combined Set.]	[F/SS/ISO/Exposure Comp.]	[]	✓	✓	✓
	[White Balance]	[]	✓	✓	✓
	[Photo Style]	[]	✓	✓	✓
	[Metering Mode]	[]	✓	✓	✓
	[AF Mode]	[]	✓	✓	✓

Menu		Default setting			
 [Custom]:  [Focus/Shutter]					
[Focus/Shutter Priority]	[AFS]	[FOCUS]	✓	✓	✓
	[AFC]	[BALANCE]	✓	✓	✓
[Focus Switching for Vert / Hor]		[OFF]	✓	✓	✓
[AF/AE Lock Hold]		[OFF]	✓	✓	✓
[AF+MF]		[OFF]	✓	✓	✓
[MF Assist]	[Focus Ring]	[ON]	✓	✓	✓
	[AF Mode]	[ON]	✓	✓	✓
	[Press Joystick]	[OFF]	✓	✓	✓
	[MF Assist Display]	[PIP]	✓	✓	✓
[MF Guide]		[]/[] ¹	✓	✓	✓
[Focus Ring Lock]		[OFF]	✓	✓	✓
[Show/Hide AF Mode]	[Human/Animal Detect AF]	[ON]	✓	✓	✓
	[Tracking]	[ON]	✓	✓	✓
	[225-Area]	[ON]	✓	✓	✓
	[Zone (Vert./ Horz.)]	[ON]	✓	✓	✓
	[Zone (Square)]	[OFF]	✓	✓	✓
	[Zone (Oval)]	[ON]	✓	✓	✓
	[1-Area+]	[ON]	✓	✓	✓
	[Pinpoint]	[ON]	✓	✓	✓
	[Custom1]	[OFF]	✓	✓	✓
	[Custom2]	[OFF]	✓	✓	✓
	[Custom3]	[OFF]	✓	✓	✓
[Pinpoint AF Setting]	[Pinpoint AF Time]	[MID]	✓	✓	✓
	[Pinpoint AF Display]	[PIP]	✓	✓	✓
[AF-Point Scope Setting]	[Keep Enlarged Display]	[OFF]	✓	✓	✓
	[PIP Display]	[PIP]	✓	✓	✓
[Shutter AF]		[ON]	✓	✓	✓
[Half-Press Shutter]		[OFF]	✓	✓	✓



[Assign REC to Shutter Button]	[ON]	✓	✓	✓
[Quick AF]	[OFF]	✓	✓	✓
[Eye Sensor AF]	[OFF]	✓	✓	✓
[Looped Focus Frame]	[OFF]	✓	✓	✓
[AFC Start Point (225-Area)]	[OFF]	✓	✓	✓





Menu		Default setting			
 [Custom]:  [Operation]					
[Q.MENU Settings]	[Layout Style]	[MODE1]	✓	✓	✓
	[Front Dial Assignment]	[Value]	✓	✓	✓
	[Item Customize (Photo)]	—	✓	✓	✓
	[Item Customize (Video)]	—	✓	✓	✓
[Touch Settings]	[Touch Screen]	[ON]	✓	✓	✓
	[Touch Tab]	[OFF]	✓	✓	✓
	[Touch AF]	[AF]	✓	✓	✓
	[Touch Pad AF]	[OFF]	✓	✓	✓
[Operation Lock Setup]	[Cursor]	[	✓	✓	✓
	[Joystick]	[	✓	✓	✓
	[Touch Screen]	[	✓	✓	✓
	[Dial]	[	✓	✓	✓
	[DISP. Button]	[	✓	✓	✓
[Fn Button Set]	[Setting in REC mode]	—	✓	✓	✓
	[Setting in PLAY mode]	—	✓	✓	✓
[WB/ISO/Expo. Button]	[AFTER PRESSING2]	✓	✓	✓	
[ISO Displayed Setting]	[Front/Rear Dials]	[ / 	✓	✓	✓
[Exposure Comp. Disp. Setting]	[Cursor Buttons (Up/Down)]	[OFF]	✓	✓	✓
	[Front/Rear Dials]	[ / 	✓	✓	✓











[Dial Set.]	[Assign Dial (F/SS)]	[SET1]	✓	✓	✓
	[Rotation (F/SS)]	[ 	✓	✓	✓
	[Control Dial Assignment]	[	✓	✓	✓
	[Exposure Comp.]	[OFF]	✓	✓	✓
	[Dial Operation Switch Setup]	—	✓	✓	✓
	[Rotation (Menu Operation)]	[ 	✓	✓	✓
[Joystick Setting]	[D.FOCUS Movement]	✓	✓	✓	
[Video Rec. Button (Remote)]	[Video Record]	✓	✓	✓	







Menu		Default setting			
 [Custom]:  [Monitor / Display (Photo)]					
[Auto Review]	[Duration Time (photo)]	[OFF]	✓	✓	✓
	[Duration Time (6K/4K PHOTO)]	[HOLD]	✓	✓	✓
	[Duration Time (Post-Focus)]	[HOLD]	✓	✓	✓
	[Playback Operation Priority]	[OFF]	✓	✓	✓
[Constant Preview]	[ON]/[OFF]	[OFF]	✓	✓	✓
	[SET]	—	✓	✓	✓
[Histogram]	[OFF]	✓	✓	✓	
[Photo Grid Line]	[OFF]	✓	✓	✓	
[AF Area Display]	[ON]	✓	✓	✓	
[Live View Boost]	[MODE1]/[MODE2]/[OFF]	[OFF]	✓	✓	✓
	[SET]	[M]	✓	✓	✓
[Night Mode]	[Monitor]	[OFF]	✓	✓	✓
	[LVF]	[OFF]	✓	✓	✓





18. Materials – List of Default Settings/Custom Saving/Settings Available for Copying













[LVF/Monitor Disp. Set]	[LVF Disp. Set]	[	✓	✓	✓
	[Monitor Disp. Set]	[	✓	✓	✓
	[Horizontal Image Flip(Monitor)]	[AUTO]	✓	✓	✓
	[Vertical Image Flip(Monitor)]	[AUTO]	✓	✓	✓
[Expo.Meter]		[OFF]	✓	✓	✓
[Focal Length]		[ON]	✓	✓	✓
[Blinking Highlights]		[OFF]	✓	✓	✓
[Sheer Overlay]	[ON]/[OFF]	[OFF]	✓		
	[SET]	—	✓		
[I.S. Status Scope]		[OFF]	✓	✓	✓
[Level Gauge]		[ON]	✓	✓	✓
[Luminance Spot Meter]		[OFF]	✓	✓	✓
[Framing Outline]		[OFF]	✓	✓	✓
[Show/Hide Monitor Layout]	[Control Panel]	[ON]	✓	✓	✓
	[Black Screen]	[ON]	✓	✓	✓











Menu		Default setting			
 [Custom]:  [Monitor / Display (Video)]					
[V-LogL View Assist]	[Read LUT File]	—			
	[LUT Select]	[Vlog_709]	✓	✓	
	[LUT View Assist (Monitor)]	[OFF]	✓	✓	
	[LUT View Assist (HDMI)]	[OFF]	✓	✓	
[HLG View Assist]	[Monitor]	[MODE2]	✓	✓	✓
	[HDMI]	[AUTO]	✓	✓	✓
[Anamorphic Desqueeze Display]		[OFF]	✓	✓	✓
[Monochrome Live View]		[OFF]	✓	✓	✓
[Center Marker]		[OFF]	✓	✓	✓
[Frame Marker]	[ON]/[OFF]	[OFF]	✓	✓	✓
	[SET]	—	✓	✓	✓
[Zebra Pattern]	[ZEBRA1]/[ZEBRA2]/ [ZEBRA1+2]/[OFF]	[OFF]	✓	✓	✓
	[SET]	—	✓	✓	✓
[WFM/Vector Scope]		[OFF]	✓	✓	✓
[Color Bars]		—	✓	✓	✓
[Video-Priority Display]		[OFF]	✓	✓	✓
[Red REC Frame Indicator]		[OFF]	✓	✓	✓
[Streaming Blue Frame Indicator]		[OFF]	✓	✓	✓





Menu		Default setting			
 [Custom]:  [IN/OUT]					
[HDMI Rec Output]	[Info Display]	[ON]	✓	✓	✓
	[Down Convert]	[AUTO]	✓	✓	✓
	[HDMI Recording Control]	[OFF]	✓	✓	✓
	[Sound Down Convert]	[OFF]	✓	✓	✓
	[Sound Output (HDMI)]	[ON]	✓	✓	✓
	[HDMI MF Assist Output]	[ON]	✓	✓	✓
Menu		Default setting			
 [Custom]:  [Lens / Others]					
[Lens Focus Resume]		[OFF]	✓	✓	✓
[Power Zoom Lens]	[Step Zoom]	[OFF]	✓	✓	✓
	[Zoom Speed] ([Photo])	[M]	✓	✓	✓
	[Zoom Speed] ([Video])	[M]	✓	✓	✓
	[Zoom Ring]	[ON]	✓	✓	✓
[Lens Fn Button Setting]		[Focus Stop]	✓	✓	✓
[Aperture Ring Increment]		[1/3EV]	✓	✓	✓
[Focus Ring Control]	[NON-LINEAR]/[LINEAR]	[NON-LINEAR]	✓	✓	✓
	[SET]	[300°]	✓	✓	✓
[Lens Information]		[Lens1]	✓		✓
[Lens Info. Confirmation]		[ON]	✓	✓	✓
[Vertical Position Info (Video)]		[ON]	✓	✓	✓





Menu		Default setting			
 [Setup]:  [Card/File]					
[Card Format]		—			
[Double Card Slot Function]	[Recording Method]	[]	✓		✓
	[Destination Card Slot]	[1 → 2]	✓		✓
[Folder / File Settings]	[Select Folder]	—			
	[Create a New Folder]	—			
	[File Name Setting]	[Folder Number Link]	✓		✓
[File Number Reset]		—			
[Copyright Information]	[Artist]	[OFF]	✓		✓
	[Copyright Holder]	[OFF]	✓		✓
	[Display Copyright Info.]	—			





Menu		Default setting			
 [Setup]:  [Monitor / Display]					
[Power Save Mode]	[Sleep Mode]	[5MIN.]	✓		✓
	[Sleep Mode(Wi-Fi)]	[ON]	✓		✓
	[Auto LVF/Monitor Off]	[5MIN.]	✓		✓
	[Power Save LVF Shooting]	—	✓		✓
[Monitor Frame Rate]		[60fps]	✓		✓
[LVF Frame Rate]		[60fps]	✓		✓
[Monitor Settings]/[Viewfinder]		—	✓		
[Monitor Backlight]/[LVF Luminance]		[AUTO]	✓		✓
[Eye Sensor]	[Sensitivity]	[HIGH]	✓		✓
	[LVF/Monitor Switch]	[LVF/MON AUTO]	✓		✓
[Level Gauge Adjust.]	[Adjust.]	—	✓		
	[Level Gauge Value Reset]	—			





Menu		Default setting			
 [Setup]:  [IN/OUT]					
[Beep]	[Beep Volume]	[]	✓		✓
	[AF Beep Volume]	[]	✓		✓
	[AF Beep Tone]	[]	✓		✓
	[E-Shutter Vol]	[]	✓		✓
	[E-Shutter Tone]	[]	✓		✓
[Headphone Volume]		[LEVEL3]	✓		✓
[Wi-Fi]		—	✓		*2
[Bluetooth]		—	✓		
[USB]	[USB Mode]	[] [Select on connection]	✓		✓
	[USB Power Supply]	[ON]	✓		✓
[Battery Use Priority]		[BG]	✓		✓
[HDMI Connection]	[Output Resolution(Playback)]	[AUTO]	✓		✓
	[LUT View Assist (HDMI)]	[OFF]	✓	✓	
	[HLG View Assist (HDMI)]	[AUTO]	✓	✓	✓
	[VIERA Link (CEC)]	[OFF]	✓		✓
	[Background Color(Playback)]	[]	✓		✓
[Photo Luminance Level]		[16-255]	✓		✓
[Power/Network Indicator]		[ON]	✓		✓





Menu		Default setting			
 [Setup]:  [Setting]					
[Save to Custom Mode]		—	✓		✓
[Load Custom Mode]		—	✓		✓
[Custom Mode Settings]	[Limit No. of Custom Mode]	[3]	✓		✓
	[Edit Title]	—	✓		✓
	[How to Reload Custom Mode]	—	✓		✓
	[Select Loading Details]	—	✓		✓
[Save/Restore Camera Setting]	[Save]	—			
	[Load]	—			
	[Delete]	—			
	[Keep Settings While Format]	[OFF]	✓		✓
[Reset]		—			
Menu		Default setting			
 [Setup]:  [Others]					
[Clock Set]		0:00:00 1/1/2021			
[Time Zone]		*1			✓
[System Frequency]		[59.94Hz (NTSC)]/ [50.00Hz (PAL)]*1	✓		✓
[Pixel Refresh]		—			
[Sensor Cleaning]		—			
[Language]		*1	✓		✓
[Firmware Version]		—			
[Online Manual]		—			
[Approved Regulations]		—			





Menu	Default setting			
 [My Menu]:  [Edit My Menu]				
[Add]	—	✓		✓
[Sorting]	—			
[Delete]	—			
[Display from My Menu]	[OFF]	✓		✓

Menu	Default setting			
 [Playback]:  [Playback Mode]				
[Playback Mode]	[Normal Play]	✓		✓
[Slide Show]	—	✓		✓
[Rotate Disp.]	[ON]	✓		✓
[Picture Sort]	[DATE/TIME]	✓		✓
[Magnify from AF Point]	[OFF]	✓		✓
[LUT View Assist (Monitor)]	[OFF]	✓	✓	
[HLG View Assist (Monitor)]	[MODE2]	✓	✓	✓
[Anamorphic Desqueeze Display]	[OFF]	✓	✓	✓

Menu	Default setting			
 [Playback]:  [Process Image]				
[RAW Processing]	—			
[6K/4K PHOTO Bulk Saving]	—			
[6K/4K PHOTO Noise Reduction]	[AUTO]	✓		✓
[Time Lapse Video]	—			
[Stop Motion Video]	—			

Menu	Default setting			
 [Playback]:  [Add/Delete Info.]				
[Protect]	—			
[Rating]	—			

Menu	Default setting			
 [Playback]:  [Edit Image]				
[Resize]	—			
[Rotate]	—			
[Video Divide]	—			
[Copy]	—			

Menu	Default setting			
 [Playback]:  [Others]				
[Delete Confirmation]	["No" first]	✓		✓
[Delete All Images]	—			

*1 Default setting specifications vary depending on the country or area where the camera was purchased.

*2 Only the settings of [Streaming Function] and [Streaming Quality] in [Streaming Setup] are saved.

List of Functions That Can Be Set in Each Recording Mode



Menu		iA	P	A	S	M	BM
[Photo]: [Image Quality]							
[Photo Style]		✓	✓	✓	✓	✓	
[Metering Mode]			✓	✓	✓	✓	
[Aspect Ratio]		✓	✓	✓	✓	✓	
[Picture Quality]		✓	✓	✓	✓	✓	
[Picture Size]		✓	✓	✓	✓	✓	
[Long Exposure NR]			✓	✓	✓	✓	
[ISO Sensitivity (photo)]	[ISO Auto Lower Limit Setting]		✓	✓	✓	✓	
	[ISO Auto Upper Limit Setting]		✓	✓	✓	✓	
[Min. Shutter Speed]			✓	✓			
[i.Dynamic Range]			✓	✓	✓	✓	
[Vignetting Comp.]			✓	✓	✓	✓	
[Diffraction Compensation]			✓	✓	✓	✓	
[Filter Settings]	[Filter Effect]		✓	✓	✓	✓	
	[Simultaneous Record w/ o Filter]		✓	✓	✓	✓	

18. Materials – List of Functions That Can Be Set in Each Recording Mode



Menu		iA	P	A	S	M	EM
[Photo]: [Focus]							
[AF Custom Setting(Photo)]			✓	✓	✓	✓	
[AF Assist Light]			✓	✓	✓	✓	
[Focus Peaking]	[ON]/[OFF]	✓	✓	✓	✓	✓	
	[SET]	✓	✓	✓	✓	✓	
[1-Area AF Moving Speed]		✓	✓	✓	✓	✓	

Menu		iA	P	A	S	M	EM
[Photo]: [Flash]							
[Flash Mode]		✓	✓	✓	✓	✓	
[Firing Mode]			✓	✓	✓	✓	
[Flash Adjust.]			✓	✓	✓	✓	
[Flash Synchro]			✓	✓	✓	✓	
[Manual Flash Adjust.]			✓	✓	✓	✓	
[Auto Exposure Comp.]			✓	✓	✓	✓	
[Wireless]			✓	✓	✓	✓	
[Wireless Channel]			✓	✓	✓	✓	
[Wireless FP]			✓	✓	✓	✓	
[Communication Light]			✓	✓	✓	✓	
[Wireless Setup]			✓	✓	✓	✓	





18. Materials – List of Functions That Can Be Set in Each Recording Mode

Menu		iA	P	A	S	M	BM
 [Photo]:  [Others (Photo)]							
[Bracketing]	[Bracketing Type]	✓	✓	✓	✓	✓	
	[More Settings]	✓	✓	✓	✓	✓	
[Silent Mode]		✓	✓	✓	✓	✓	
[Image Stabilizer]	[Operation Mode]	✓	✓	✓	✓	✓	
	[E-Stabilization (Video)]	✓	✓	✓	✓	✓	
	[Boost I.S. (Video)]	✓	✓	✓	✓	✓	
	[Anamorphic (Video)]	✓	✓	✓	✓	✓	
[Lens Information]		✓	✓	✓	✓	✓	
[Burst Rate]		✓	✓	✓	✓	✓	
[Shutter Type]		✓	✓	✓	✓	✓	
[Shutter Delay]		✓	✓	✓	✓	✓	
[Ex. Tele Conv.]		✓	✓	✓	✓	✓	
[Time Lapse/Animation]		✓	✓	✓	✓	✓	
[Self Timer]		✓	✓	✓	✓	✓	
[6K/4K PHOTO]	[Picture Size / Burst Speed]	✓	✓	✓	✓	✓	
	[Rec Method]	✓	✓	✓	✓	✓	
	[Pre-Burst Recording]	✓	✓	✓	✓	✓	
[Post-Focus]		✓	✓	✓	✓	✓	
[Multiple Exposure]	[Start]		✓	✓	✓	✓	
	[Auto Gain]		✓	✓	✓	✓	
	[Overlay]		✓	✓	✓	✓	
[Time Stamp Rec.]		✓	✓	✓	✓	✓	



18. Materials – List of Functions That Can Be Set in Each Recording Mode

Menu		iA	P	A	S	M	EM
 [Video]:  [Image Quality]							
[Exposure Mode]							✓
[Photo Style]		✓	✓	✓	✓	✓	✓
[Metering Mode]			✓	✓	✓	✓	✓
[ISO Sensitivity (video)]	[[ISO Auto Lower Limit Setting]						✓
	[[ISO Auto Upper Limit Setting]						✓
[Synchro Scan]							✓
[Flicker Decrease (Video)]			✓	✓	✓	✓	
[Master Pedestal Level]							✓
[SS/Gain Operation]							✓
[i.Dynamic Range]			✓	✓	✓	✓	✓
[Vignetting Comp.]			✓	✓	✓	✓	✓
[Diffraction Compensation]			✓	✓	✓	✓	✓
[Filter Settings]	[Filter Effect]		✓	✓	✓	✓	✓
	[Simultaneous Record w/o Filter]		✓	✓	✓	✓	



18. Materials – List of Functions That Can Be Set in Each Recording Mode

Menu		iA	P	A	S	M	MEM
 [Video]:  [Image Format]							
[Rec. File Format]		✓	✓	✓	✓	✓	✓
[Image Area of Video]		✓	✓	✓	✓	✓	✓
[Rec Quality]		✓	✓	✓	✓	✓	✓
[Rec Quality (My List)]		✓	✓	✓	✓	✓	✓
[Variable Frame Rate]							✓
[Time Code]	[Time Code Display]	✓	✓	✓	✓	✓	✓
	[Count Up]	✓	✓	✓	✓	✓	✓
	[Time Code Value]	✓	✓	✓	✓	✓	✓
	[Time Code Mode]	✓	✓	✓	✓	✓	✓
	[HDMI Time Code Output]						✓
[Luminance Level]		✓	✓	✓	✓	✓	✓
Menu		iA	P	A	S	M	MEM
 [Video]:  [Focus]							
[AF Custom Setting(Video)]	[ON]/[OFF]	✓	✓	✓	✓	✓	✓
	[SET]	✓	✓	✓	✓	✓	✓
[Continuous AF]		✓	✓	✓	✓	✓	✓
[AF Assist Light]			✓	✓	✓	✓	✓
[Focus Peaking]	[ON]/[OFF]	✓	✓	✓	✓	✓	✓
	[SET]	✓	✓	✓	✓	✓	✓
[1-Area AF Moving Speed]		✓	✓	✓	✓	✓	✓

18. Materials – List of Functions That Can Be Set in Each Recording Mode

Menu	iA	P	A	S	M	iBM
 [Video]:  [Audio]						
[Sound Rec Level Disp.]	✓	✓	✓	✓	✓	✓
[Mute Sound Input]	✓	✓	✓	✓	✓	✓
[Sound Rec Gain Level]	✓	✓	✓	✓	✓	✓
[Sound Rec Level Adj.]	✓	✓	✓	✓	✓	✓
[Sound Rec Level Limiter]	✓	✓	✓	✓	✓	✓
[Wind Noise Canceller]	✓	✓	✓	✓	✓	✓
[Wind Cut]	✓	✓	✓	✓	✓	✓
[Lens Noise Cut]	✓	✓	✓	✓	✓	✓
[Special Mic.]	✓	✓	✓	✓	✓	✓
[XLR Mic Adaptor Setting]	✓	✓	✓	✓	✓	✓
[Sound Output]	✓	✓	✓	✓	✓	✓
[Headphone Volume]	✓	✓	✓	✓	✓	✓

18. Materials – List of Functions That Can Be Set in Each Recording Mode

Menu		iA	P	A	S	M	MEM
 [Video]:  [Others (Video)]							
[Silent Mode]		✓	✓	✓	✓	✓	✓
[Image Stabilizer]	[Operation Mode]	✓	✓	✓	✓	✓	✓
	[E-Stabilization (Video)]	✓	✓	✓	✓	✓	✓
	[Boost I.S. (Video)]	✓	✓	✓	✓	✓	✓
	[Anamorphic (Video)]	✓	✓	✓	✓	✓	✓
	[Lens Information]	✓	✓	✓	✓	✓	✓
[Self Timer Setting]	[Self Timer]	✓	✓	✓	✓	✓	✓
	[Self Timer For Video]	✓	✓	✓	✓	✓	✓
[Focus Transition]							✓
[Loop Recording (video)]							✓
[Segmented File Recording]		✓	✓	✓	✓	✓	✓
[Live Cropping]							✓
[Time Stamp Rec.]		✓	✓	✓	✓	✓	✓

Specifications

The specifications are subject to change for performance enhancement.

Digital camera body (DC-GH5M2):

Information for your safety

Power source:

9.0 V===

Power consumption:

4.5 W (when recording with the monitor), 3.8 W (when playing back with the monitor)

[When using the interchangeable lens (H-ES12060)]

4.4 W (when recording with the monitor), 3.7 W (when playing back with the monitor)

[When using the interchangeable lens (H-FS12060)]

Type

● **Type**

Digital Single Lens Mirrorless camera

● **Recording media**

SD memory card / SDHC memory card*1 / SDXC memory card*1

*1 Compliant with UHS-I/UHS-II UHS Speed Class 3, UHS-II Video Speed Class 90

Double slot recording function is available.

● **Lens mount**

Micro Four Thirds mount

Image sensor● **Image sensor**

4/3" Live MOS sensor, total pixel number 21,770,000 pixels, Primary color filter

● **Effective number of pixels of the camera**

20,330,000 pixels

Latitude

12 stops ([V-Log L])

Recording format for still images● **File format for still images**

JPEG (DCF compliant, Exif 2.31 compliant) / RAW

● **File format for 6K/4K photos**

6K photo: MP4 (H.265/HEVC, AAC (2ch))

4K photo: MP4 (H.264/MPEG-4 AVC, AAC (2ch))

● **Picture size (pixels)****When the aspect ratio setting is [4:3]**

[L]: 5184×3888

[M]: 3712×2784

[S]: 2624×1968

6K photo: 4992×3744

4K photo: 3328×2496

When the aspect ratio setting is [3:2]

[L]: 5184×3456

[M]: 3712×2480

[S]: 2624×1752

6K photo: 5184×3456

4K photo: 3504×2336

When the aspect ratio setting is [16:9]

[L]: 5184×2920

[M]: 3840×2160

[S]: 1920×1080

4K photo: 3840×2160

When the aspect ratio setting is [1:1]

[L]: 3888×3888

[M]: 2784×2784

[S]: 1968×1968

4K photo: 2880×2880

● **Image quality for pictures**

Fine / Standard / RAW+Fine / RAW+Standard / RAW

Recording format for video

● **Video format**

MP4 (H.264/MPEG-4 AVC, H.265/HEVC)

MOV (H.264/MPEG-4 AVC, H.265/HEVC)

● **Audio format**

MP4: AAC (2ch)

MOV: LPCM (2ch, 48 kHz/16-bit)^{*2}

*2 When an XLR Microphone Adaptor (DMW-XLR1: optional) is attached, LPCM (2ch, 48 kHz/24-bit, 96 kHz/24-bit) can be selected

● **System frequency**

59.94 Hz / 50.00 Hz / 24.00 Hz

● **Image quality for video**

Refer to [Rec Quality] in this document for information about resolution, recording frame rate, and other elements of recording quality (→[Rec Quality]: 338)

Viewfinder

- **System**

Aspect ratio 4:3, 0.5 inches, approx. 3,680,000 dots, organic EL (OLED) live view viewfinder

- **Field of view ratio**

Approx. 100 %

- **Magnification**

Approx. $0.76\times$ (35 mm film camera equivalent)

(-1.0 m^{-1} 50 mm at infinity, with aspect ratio set to [4:3])

- **Eye point**

Approx. 21 mm (at -1.0 m^{-1})

- **Diopter adjustment range**

-4.0 to $+3.0$ diopter

- **Eye sensor**

Yes

Monitor

- **System**

Aspect ratio 3:2, 3.0 inches, approx. 1,840,000 dots monitor, capacitive touch screen

- **Field of view ratio**

Approx. 100 %

Focus

- **AF type**

TTL type based on image detection (Contrast AF)

- **Focus mode**

AFS / AFC / MF

- **AF mode**

Automatic detection (Face/Eye/Body/Animal) / Tracking / 225-Area / Zone (Vertical/Horizontal) / Zone (Square) / Zone (Oval) /

1-Area+ Supplementary (Automatic detection possible) / 1-Area (Automatic detection possible) / Pinpoint / Custom1, 2, 3,

Focus area selection is possible by touching or with the joystick

Exposure control

- **Light metering system, Light metering mode**

1728-zone metering, multi-metering / center-weighted metering / spot metering / highlight-weighted metering

- **Metering range**

EV 0 to EV 18 (F2.0 lens, ISO100 conversion)

- **Exposure**

Program AE (P) / Aperture-Priority AE (A) / Shutter-Priority AE (S) / Manual Exposure (M)

- **Exposure compensation**

1/3 EV steps, ± 5 EV

- **ISO sensitivity (standard output sensitivity)**

AUTO / 200 to 25600,

When [Extended ISO] is set: AUTO / 100 to 25600,

1/3 EV steps

White balance

AWB / AWBc / AWBw / Daylight / Cloudy / Shade / Incandescent lights / Flash / White set 1, 2, 3, 4 / Color temperature 1, 2, 3, 4

Shutter

- **Format**

Focal-plane shutter

- **Shutter speed**

Pictures:

Mechanical shutter: Bulb (max. approx. 30 minutes), 60 seconds to 1/8000 of a second

Electronic front curtain: Bulb (max. approx. 30 minutes), 60 seconds to 1/2000 of a second

Electronic shutter: Bulb (max. approx. 60 seconds), 60 seconds to 1/16000 of a second

Videos:

1/25^{*3} of a second to 1/16000 of a second

*3 When [Exposure Mode] is set to [M] in [⊞M] and focus mode is set to [MF], this can be set up to 1/2

- **Flash synchronization speed**

Equal to or smaller than 1/250 of a second

Burst recording

- **Burst rate**

High speed (Mechanical shutter/Electronic front curtain): 12 frames/second ([AFS], [MF]), 9 frames/second ([AFC])

High speed (Electronic shutter): 12 frames/second ([AFS], [MF]), 7 frames/second ([AFC])

Medium speed: 7 frames/second

Low speed: 2 frames/second

- **Maximum number of frames recordable**

[FINE] / [STD.]: 999 frames or more

[RAW+FINE] / [RAW+STD.] / [RAW]: 108 frames or more

[When recording is performed under the test conditions specified by Panasonic (Using an UHS-II compatible card.)]

Zoom

- **Extended Tele Conversion (Picture)**

Max. 2.0× (when a picture size of [S] is selected.)

Display language

[ENGLISH] / [DEUTSCH] / [FRANÇAIS] / [ITALIANO] / [ESPAÑOL] / [繁體中文] / [PORTUGUÉS] / [日本語]

Microphone / Speaker

- **Microphone**

Stereo

- **Speaker**

Monaural

Interface● **USB**

USB Type-C™, SuperSpeed USB3.1 GEN1, Supports USB Power Delivery (9.0 V/
3.0 A)

● **[HDMI]**

HDMI Type A

● **[REMOTE]**

∅ 2.5 mm jack

● **[MIC]**

∅ 3.5 mm stereo mini jack

● **Headphones**

∅ 3.5 mm stereo mini jack

● **Flash Synchro**

Yes

Splash Resistant

Yes

External dimensions / Mass● **External dimensions**

Approx. 138.5 mm (W)×98.1 mm (H)×87.4 mm (D)

(5.45" (W)×3.86" (H)×3.44" (D))

(excluding the projecting parts)

● **Mass (Weight)**

Approx. 727 g/1.60 lb (camera body, with battery and one card)

Approx. 647 g/1.43 lb (only camera body)

Operating environment

- **Recommended operating temperature**

–10 °C to 40 °C (14 °F to 104 °F)

- Battery performance temporarily worsens at low temperatures (–10 °C to 0 °C (14 °F to 32 °F)), reducing the number of pictures that can be taken and the available recording time.

- **Permissible relative humidity**

10 %RH to 80 %RH

Wi-Fi

- **Compliance standard**

IEEE 802.11a/b/g/n/ac (standard wireless LAN protocol)

- **Frequency range used (central frequency)**

Specifications vary depending on the country or area where the camera was purchased.

Refer to the “Owner’s Manual <Quick Start Guide>” (supplied) for details.

- **Encryption method**

Wi-Fi compliant WPA™ / WPA2™

- **Access method**

Infrastructure mode

Bluetooth



- **Compliance standard**

Bluetooth v4.2, Bluetooth Low Energy (BLE)

- **Frequency range used (central frequency)**

2402 MHz to 2480 MHz

The symbols on this product (including the accessories) represent the following:

	AC
	DC
	Class II equipment (The construction of the product is double-insulated.)

- This camera complies with the “Design rule for Camera File system” (DCF) and “Exchangeable Image File Format” (Exif) standards established by “Japan Electronics and Information Technology Industries Association” (JEITA).
The camera cannot play back files that do not comply with the DCF standard.
Exif is a file format for pictures which allows recording information, etc. to be added.

Interchangeable Lens:

H-ES12060 “LEICA DG VARIO-ELMARIT 12–60mm/F2.8–4.0 ASPH./POWER O.I.S.”

Mount	Micro Four Thirds Mount
Focal length	f=12 mm to 60 mm (35 mm film camera equivalent: 24 mm to 120 mm)
Lens construction	14 elements in 12 groups (4 aspherical lenses, 2 ED lenses)
Aperture type	9 diaphragm blades/circular aperture diaphragm
Maximum aperture	F2.8 (Wide) to F4.0 (Tele)
Minimum aperture value	F22
Angle of view	84° (Wide) to 20° (Tele)
In focus distance	Wide: 0.20 m (0.66 feet) to ∞ / Tele: 0.24 m (0.79 feet) to ∞ (from the focus distance reference line)
Maximum image magnification	0.3× (35 mm film camera equivalent: 0.6×)
Optical Image Stabilizer	Yes
Filter diameter	62 mm

Maximum diameter	Ø68.4 mm (2.7")
Overall length	Approx. 86 mm (3.4") (from the tip of the lens to the base side of the lens mount)
Mass (Weight)	Approx. 320 g (0.70 lb)
Dust and splash resistant	Yes
Recommended operating temperature	-10 °C to 40 °C (14 °F to 104 °F)
Permissible relative humidity	10 %RH to 80 %RH

- LEICA is a registered trademark of Leica Microsystems IR GmbH. ELMARIT is a registered trademark of Leica Camera AG.

The LEICA DG lenses are manufactured using measurement instruments and quality assurance systems that have been certified by Leica Camera AG based on the company's quality standards.

Interchangeable Lens:

H-FS12060 "LUMIX G VARIO 12–60mm/F3.5–5.6 ASPH./POWER O.I.S."

Mount	Micro Four Thirds Mount
Focal length	f=12 mm to 60 mm (35 mm film camera equivalent: 24 mm to 120 mm)
Lens construction	11 elements in 9 groups (3 aspherical lenses, 1 ED lens)
Aperture type	7 diaphragm blades/circular aperture diaphragm
Maximum aperture	F3.5 (Wide) to F5.6 (Tele)
Minimum aperture value	F22
Angle of view	84° (Wide) to 20° (Tele)

In focus distance	Wide: 0.20 m (0.66 feet) to ∞ / Tele: 0.25 m (0.82 feet) to ∞ (from the focus distance reference line)
Maximum image magnification	0.27 \times (35 mm film camera equivalent: 0.54 \times)
Optical Image Stabilizer	Yes
Filter diameter	58 mm
Maximum diameter	\varnothing 66.0 mm (2.6")
Overall length	Approx. 71 mm (2.8") (from the tip of the lens to the base side of the lens mount)
Mass (Weight)	Approx. 210 g (0.46 lb)
Dust and splash resistant	Yes
Recommended operating temperature	0 °C to 40 °C (32 °F to 104 °F)
Permissible relative humidity	10 %RH to 80 %RH

Trademarks and Licences



- Micro Four Thirds™ and Micro Four Thirds Logo marks are trademarks or registered trademarks of OM Digital Solutions Corporation, in Japan, the United States, the European Union and other countries.
- SDXC Logo is a trademark of SD-3C, LLC.
- The terms HDMI and HDMI High-Definition Multimedia Interface, and the HDMI Logo are trademarks or registered trademarks of HDMI Licensing Administrator, Inc. in the United States and other countries.
- USB Type-C™ and USB-C™ are trademarks of USB Implementers Forum.
- The USB Type-C™ Charging Trident Logos are trademarks of USB Implementers Forum, Inc.
- The SuperSpeed USB Trident Logo is a registered trademark of USB Implementers Forum, Inc.
- QuickTime and the QuickTime logo are trademarks or registered trademarks of Apple Inc., used under license therefrom.
- HDAVI Control™ is a trademark of Panasonic Corporation.
- Adobe is a trademark or registered trademark of Adobe Systems Incorporated in the United States and/or other countries.
- Pentium is a trademark of Intel Corporation in the U.S. and/or other countries.



- Windows is a registered trademark or trademark of Microsoft Corporation in the United States and/or other countries.
 - Final Cut Pro, Mac, OS X and macOS are trademarks of Apple Inc., registered in the U.S. and other countries.
 - App Store is a service mark of Apple Inc.
 - Google, Android and Google Play are trademarks of Google LLC.
 - The Bluetooth® word mark and logos are registered trademarks owned by Bluetooth SIG, Inc. and any use of such marks by Panasonic Corporation is under license. Other trademarks and trade names are those of their respective owners.
 - The Wi-Fi CERTIFIED™ Logo is a registered trademark of Wi-Fi Alliance®.
 - The Wi-Fi Protected Setup™ Logo is a trademark of Wi-Fi Alliance®.
 - “Wi-Fi®” is a registered trademark of Wi-Fi Alliance®.
 - “Wi-Fi Protected Setup™”, “WPA™”, and “WPA2™” are trademarks of Wi-Fi Alliance®.
 - This product uses “DynaFont” from DynaComware Corporation. DynaFont is a registered trademark of DynaComware Taiwan Inc.
 - QR Code is a registered trademark of DENSO WAVE INCORPORATED.
 - Other names, company names, product names mentioned in this document are trademarks or registered trademarks of the companies concerned.
-

This product incorporates the following software:

- (1) the software developed independently by or for Panasonic Corporation,
- (2) the software owned by third party and licensed to Panasonic Corporation,
- (3) the software licensed under the GNU General Public License, Version 2.0 (GPL V2.0),
- (4) the software licensed under the GNU LESSER General Public License, Version 2.1 (LGPL V2.1), and/or
- (5) open source software other than the software licensed under the GPL V2.0 and/or LGPL V2.1.

The software categorized as (3) - (5) are distributed in the hope that it will be useful, but WITHOUT ANY WARRANTY, without even the implied warranty of MERCHANTABILITY or FITNESS FOR A PARTICULAR PURPOSE. Please refer to the detailed terms and conditions thereof displayed by selecting [MENU/SET] ➔ [Setup] ➔ [Others] ➔ [Firmware Version] ➔ [Software info].

At least three (3) years from delivery of this product, Panasonic will give to any third party who contacts us at the contact information provided below, for a charge no more than our cost of physically performing source code distribution, a complete machine-readable copy of the corresponding source code covered under GPL V2.0 or LGPL V2.1, as well as the respective copyright notice thereof.

Contact Information: oss-cd-request@gg.jp.panasonic.com

The source code and the copyright notice are also available for free in our website below.

<https://panasonic.net/cns/oss/index.html>

This product is licensed under the AVC Patent Portfolio License for the personal use of a consumer or other uses in which it does not receive remuneration to (i) encode video in compliance with the AVC Standard ("AVC Video") and/or (ii) decode AVC Video that was encoded by a consumer engaged in a personal activity and/or was obtained from a video provider licensed to provide AVC Video. No license is granted or shall be implied for any other use. Additional information may be obtained from MPEG LA, L.L.C.

See <http://www.mpegla.com>