

Panasonic®

Basic Owner's Manual Digital Camera

Model No. DC-FZ80

LUMIX



Please read these instructions carefully before using this product, and save this manual for future use.

More detailed owner's manual is available in "Owner's Manual for advanced features (PDF format)". To read it, download it from the website. (→61)

Register online at <http://shop.panasonic.com/support> (U.S. customers only)

If you have any questions, visit:

USA : <http://shop.panasonic.com/support>

Canada : www.panasonic.ca/english/support



DVQX1136ZA
M0117KZ0

**Dear Customer,
Thank you for choosing Panasonic!**

You have purchased one of the most sophisticated and reliable products on the market today. Used properly, we're sure it will bring you and your family years of enjoyment. Please take time to fill in the information below. The serial number is on the tag located on the underside of your camera. Be sure to **retain this manual** as your convenient camera information source.

Date of Purchase	Dealer Phone No.
Dealer Purchased From	Model No.
Dealer Address	Serial No.

Please note that the actual controls and components, menu items, etc. of your Digital Camera may look somewhat different from those shown in the illustrations in this Owner's Manual.

Carefully observe copyright laws.

- Recording of pre-recorded tapes or discs or other published or broadcast material for purposes other than your own private use may infringe copyright laws. Even for the purpose of private use, recording of certain material may be restricted.

For the U.S.A. and Canada only



A lithium ion battery that is recyclable powers the product you have purchased. Please call 1-800-8-BATTERY for information on how to recycle this battery.

Information for Your Safety

WARNING:

To reduce the risk of fire, electric shock or product damage,

- Do not expose this unit to rain, moisture, dripping or splashing.
- Use only the recommended accessories.
- Do not remove covers.
- Do not repair this unit by yourself. Refer servicing to qualified service personnel.

The socket outlet shall be installed near the equipment and shall be easily accessible.

■ Product identification marking

Product	Location
Digital camera	Bottom

THE FOLLOWING APPLIES ONLY IN THE U.S.A.

Certification and Compliance

See Camera for the certification and compliance mark specific to that device.

- 1 Select **[Wi-Fi]** in the **[Setup]** menu
- 2 Select **[Wi-Fi Setup]** in the **[Wi-Fi]**
- 3 Press **▲ ▼** to select **[Approved Regulations]**, and press **[MENU/SET]**

Contains FCC ID : VPYLBXN604

This transmitter must not be co-located or operated in conjunction with any other antenna or transmitter.

This equipment complies with FCC radiation exposure limits set forth for an uncontrolled environment and meets the FCC radio frequency (RF) Exposure Guidelines in Supplement C to OET65.

This equipment has very low levels of RF energy that are deemed to comply without testing of specific absorption ratio (SAR).

THE FOLLOWING APPLIES ONLY IN THE U.S.A.

FCC Note:

This equipment has been tested and found to comply with the limits for a Class B digital device, pursuant to Part 15 of the FCC Rules. These limits are designed to provide reasonable protection against harmful interference in a residential installation. This equipment generates, uses, and can radiate radio frequency energy and, if not installed and used in accordance with the instructions, may cause harmful interference to radio communications. However, there is no guarantee that interference will not occur in a particular installation. If this equipment does cause harmful interference to radio or television reception, which can be determined by turning the equipment off and on, the user is encouraged to try to correct the interference by one or more of the following measures:

- Reorient or relocate the receiving antenna.
- Increase the separation between the equipment and receiver.
- Connect the equipment into an outlet on a circuit different from that to which the receiver is connected.
- Consult the dealer or an experienced radio/TV technician for help.

FCC Caution: To assure continued compliance, follow the attached installation instructions and use only shielded interface cables with ferrite core when connecting to computer or peripheral devices.

Any changes or modifications not expressly approved by the party responsible for compliance could void the user's authority to operate this equipment.

This device complies with Part 15 of the FCC Rules. Operation is subject to the following two conditions: (1) This device may not cause harmful interference, and (2) this device must accept any interference received, including interference that may cause undesired operation.

Declaration of Conformity

Trade Name: Panasonic

Model No.: DC-FZ80

Responsible Party: Panasonic Corporation of North America
Two Riverfront Plaza, Newark, NJ 07102-5490

Support Contact: <http://shop.panasonic.com/support>



THE FOLLOWING APPLIES ONLY IN CANADA.

Certification and Compliance

See Camera for the certification and compliance mark specific to that device.

- 1 Select **[Wi-Fi]** in the **[Setup]** menu
- 2 Select **[Wi-Fi Setup]** in the **[Wi-Fi]**
- 3 Press **▲ ▼** to select **[Approved Regulations]**, and press **[MENU/SET]**

CAN ICES-3(B)/NMB-3(B)

Contains IC : 772C-LBXN604

This device complies with Industry Canada's licence-exempt RSSs. Operation is subject to the following two conditions:

- (1) this device may not cause interference, and
- (2) this device must accept any interference, including interference that may cause undesired operation of the device.

This equipment complies with IC radiation exposure limits set forth for an uncontrolled environment and meets RSS-102 of the IC radio frequency (RF) Exposure rules. This equipment has very low levels of RF energy that are deemed to comply without testing of specific absorption ratio (SAR).

■ About the battery pack

CAUTION

Battery pack (Lithium ion battery pack)

- Use the specified unit to recharge the battery pack.
- Do not use the battery pack with equipment other than the specified unit.
- Do not get dirt, sand, liquids, or other foreign matter on the terminals.
- Do not touch the plug terminals (+ and -) with metal objects.
- Do not disassemble, remodel, heat or throw into fire.

If any electrolyte should come into contact with your hands or clothes, wash it off thoroughly with water.

If any electrolyte should come into contact with your eyes, never rub the eyes. Rinse eyes thoroughly with water, and then consult a doctor.

CAUTION

- Danger of explosion if battery is incorrectly replaced. Replace only with the type recommended by the manufacturer.
- When disposing of the batteries, please contact your local authorities or dealer and ask for the correct method of disposal.
- Do not heat or expose to flame.
- Do not leave the battery(ies) in a car exposed to direct sunlight for a long period of time with doors and windows closed.

Warning

Risk of fire, explosion and burns. Do not disassemble, heat above 60 °C (140 °F) or incinerate.

■ About the AC adaptor (supplied)

CAUTION!

To reduce the risk of fire, electric shock or product damage,

- Do not install or place this unit in a bookcase, built-in cabinet or in another confined space. Ensure this unit is well ventilated.

AC adaptor

This AC adaptor operates on AC between 110V and 240V.

But

- In the U.S.A. and Canada, the AC adaptor must be connected to a 120V AC power supply only.
- When connecting to an AC supply outside of the U.S.A. or Canada, use a plug adaptor to suit the AC outlet configuration.

■ Cautions for Use

- Do not use any other USB connection cables except the supplied one.
- Use a “High Speed HDMI micro cable” with the HDMI logo. Cables that do not comply with the HDMI standards will not work.
“High Speed HDMI micro cable” (Type D-Type A plug, up to 2 m (6.6 feet) long)

Keep this unit as far away as possible from electromagnetic equipment (such as microwave ovens, TVs, video games etc.).

- If you use this unit on top of or near a TV, the pictures and/or sound on this unit may be disrupted by electromagnetic wave radiation.
- Do not use this unit near cell phones because doing so may result in noise adversely affecting the pictures and/or sound.
- Recorded data may be damaged, or pictures may be distorted, by strong magnetic fields created by speakers or large motors.
- Electromagnetic wave radiation may adversely affect this unit, disturbing the pictures and/or sound.
- If this unit is adversely affected by electromagnetic equipment and stops functioning properly, turn this unit off and remove the battery or disconnect AC adaptor (supplied)/AC adaptor (DMW-AC10PP: optional). Then reinsert the battery or reconnect AC adaptor and turn this unit on.

Do not use this unit near radio transmitters or high-voltage lines.

- If you record near radio transmitters or high-voltage lines, the recorded pictures and/or sound may be adversely affected.

-
- To clean your camera, remove the battery, the DC coupler (DMW-DCC6: optional) or a card, or disconnect the power plug from the outlet, and wipe with a soft, dry cloth.
 - Do not press the monitor with excessive force.
 - Do not press the lens with excessive force.
 - Do not allow camera to come into contact with pesticides or volatile substances (can cause surface damage or coating to peel).
 - Do not keep rubber or plastic products in contact with the camera for a long period of time.
 - Do not use solvents such as benzine, thinner, alcohol, kitchen detergents, etc., to clean the camera, since it may deteriorate the external case or the coating may peel off.
 - Do not leave the camera with the lens facing the sun, as rays of light from the sun may cause it to malfunction.
 - Always use the supplied cords and cables.
 - Do not extend the supplied cord or cable.
 - While the camera is accessing the card (for an operation such as picture writing, reading, deletion, or formatting), do not turn off the camera or remove the battery, card, AC adaptor (DMW-AC10PP: optional) or DC coupler (DMW-DCC6: optional).
Furthermore, do not subject the camera to vibration, impact or static electricity.
 - The data on the card may be damaged or lost due to electromagnetic waves, static electricity or breakdown of the camera or the card. We recommend storing important data on a PC etc.
 - Do not format the card on your PC or other equipment. Format it on the camera only to ensure proper operation.

-
- **The battery is not charged when the camera is shipped. Charge the battery before use.**
 - **The battery is a rechargeable lithium ion battery. If the temperature is too high or too low, the operating time of the battery will become shorter.**
 - The battery becomes warm after using and during and after charging. The camera also becomes warm during use. This is not a malfunction.
 - **Do not leave any metal items (such as clips) near the contact areas of the power plug or near the batteries.**
 - Store the battery in a cool and dry place with a relatively stable temperature. (Recommended temperature: 15 °C to 25 °C (59 °F to 77 °F), Recommended humidity: 40%RH to 60%RH)
 - **Do not store the battery for a long time while fully charged.** When storing the battery for a long period of time, we recommend charging it once a year. Remove the battery from the camera and store it again after it has completely discharged.
-

Contents

Information for Your Safety	3
-----------------------------------	---

Preparations

Before use	10
Standard accessories	11
Names and Functions of Main Parts	12
Attaching the Lens Cap/ Shoulder Strap	14
Inserting and removing the battery or SD memory card (optional)	16
Charging the battery	17
Setting the clock	19

Basics

Basic operations	20
Setting the menu	26

Recording

Taking pictures with automatic settings (Intelligent Auto Mode)	27
Taking pictures with Manual Focus	28
Taking pictures with Exposure Compensation	29
Recording with the 4K Photo function ...	30
Adjusting the focus after recording ([Post Focus] / [Focus Stacking])	33
Taking Pictures While Adjusting a Setting Automatically (Bracket Recording)	36
Recording Motion Picture/ 4K Motion Picture	37
[4K Live Cropping]	39

Playback

Viewing your pictures	41
[Light Composition]	42

Menu

Menu list	43
-----------------	----

Wi-Fi

What you can do with the Wi-Fi® function	45
Operating the camera by connecting it to a smartphone	46

Others

Downloading software	49
List of monitor/viewfinder displays	50
Q&A Troubleshooting	54
Specifications	56
Digital Camera Accessory System	60
Reading the Owner's Manual (PDF format)	61
Limited Warranty (ONLY FOR U.S.A.)	62
Limited Warranty (ONLY FOR CANADA)	65

Recording mode icons

Recording mode:         

In Recording modes that show icons in black, you can select and execute indicated menus and functions.

 has different functions depending on the recording mode that is registered.

Before use

■ Camera handling

Keep the camera away from excessive vibration, force, or pressure.

- Avoid using the camera under the following conditions, which may damage the lens, monitor, viewfinder, or camera body.

This may also cause the camera to malfunction or prevent recording.

- Dropping or hitting the camera against a hard surface
- Pushing with excessive force on the lens or monitor

Do not hold the lens barrel as you take pictures. There is a risk that your finger will be trapped as the lens retracts.

When camera is not in use or when using the playback feature, ensure that the lens is in the stored position.

There are times when rattling sounds or vibrations will come from the camera, but these are due to the motion of the aperture, the zoom and the motor and do not indicate a defect.

The camera is not dust resistant, splash resistant, or waterproof.

Avoid using the camera in places with excessive dust or sand, or where water can come into contact with the camera.

■ Condensation (When the lens, the monitor, or viewfinder, is fogged up)



- Condensation may occur when the camera is exposed to sudden changes of temperature or humidity. Avoid these conditions, which may make the lens, monitor, or viewfinder dirty, cause mold, or damage the camera.
- If condensation does occur, turn off the camera and wait about two hours before using it. Once the camera adjusts to the surrounding temperature, the fogging will clear naturally.

MENU Indicates that the menu can be set by pressing [MENU/SET] button.

In this Owner's Manual, steps for setting a menu item are described as follows:





MENU →  [Rec] → [Quality] → [**..**]

- In this manual, dial and lever operations are illustrated as below.

Rotate the rear dial		Press the rear dial	
Rotate the zoom lever			

Standard accessories

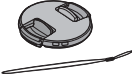
Check that all the accessories are supplied before using the camera. Part numbers are as of February 2017. These may be subject to change.

<input type="checkbox"/> Battery pack DMW-BMB9PP <ul style="list-style-type: none"> • Charge the battery before use. • Battery pack is indicated as battery pack or battery in the text. 		<input type="checkbox"/> USB connection cable K1HY04YY0106 
<input type="checkbox"/> AC adaptor SAE0012A 	<input type="checkbox"/> Lens Cap/ Lens Cap String VYQ8752 	<input type="checkbox"/> Shoulder Strap VFC4453 

- **Cards are optional.** (SD Memory Card, SDHC Memory Card and SDXC Memory Card are indicated as card in the text.)
 - This unit is compatible with UHS-I UHS Speed Class 3 standard SDHC/SDXC memory cards.
 - The following SD standard-based cards can be used.
 - SD Memory Card (512 MB to 2 GB)/SDHC Memory Card (4 GB to 32 GB)/SDXC Memory Card (48 GB to 128 GB)
 - Depending on recording conditions, the required card differs.

(For U.S.A. only)

- If accessories are lost, customers can visit us at <http://shop.panasonic.com/support> for further information about obtaining replacement parts.

(For Canada only)

- If any accessories are lost, customers in Canada should visit our support page at www.panasonic.ca/english/support for further information about obtaining replacement parts.
- Please dispose of all packaging appropriately.
- The illustrations and screens in this manual may differ from the actual product.
- A lens hood is not supplied with this unit.

Names and Functions of Main Parts

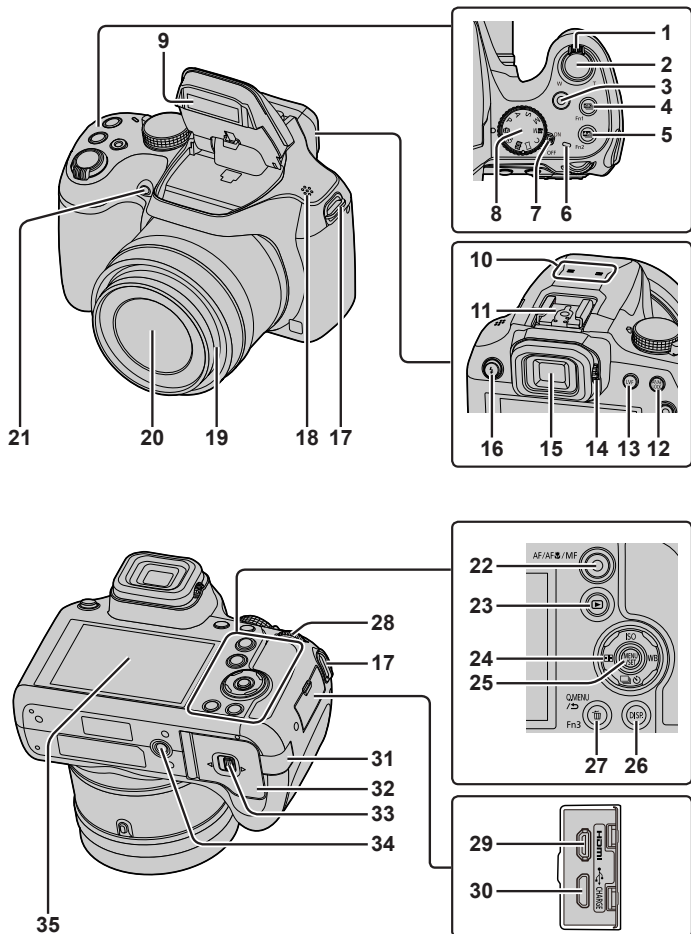

- 1 Zoom lever (→20)
- 2 Shutter button (→21)
- 3 Motion picture button (→37)
- 4 [4K] (4K photo mode) button (→30) / [Fn1] button
- 5 [Post Focus] ([Post Focus]) button (→33) / [Fn2] button
- 6 Charging lamp (→18) / Wi-Fi® connection lamp
- 7 Camera [ON/OFF] switch (→19)
- 8 Mode dial (→22)
- 9 Flash
- 10 Stereo microphone
- 11 Hot shoe
- 12 [AF/AE LOCK] button
- 13 [LVF] button (→23)
- 14 Diopter adjustment dial (→23)
- 15 Viewfinder (→23, 50)
- 16 [Flash open] button
 - The flash opens, and recording with the flash becomes possible.
- 17 Shoulder strap eyelet (→14, 15)
- 18 Speaker
- 19 Lens barrel
- 20 Lens
- 21 Self-timer indicator / AF Assist Lamp
- 22 [AF/AF-LOCK/MF] button (→23)
- 23 [Play] (Playback) button (→41)
- 24 Cursor button (→24)
- 25 [MENU/SET] button (→26)
- 26 [DISP.] button
 - Use this to change display.
- 27 [Q.MENU/Cancel] (Cancel) button / [Delete] (Delete) button (→41) / [Fn3] button
 - You can easily call some of the menu items and set them during recording.
- 28 Rear dial (→24)
- 29 [HDMI] socket
 - You can view pictures on a TV screen by connecting your camera to your TV with the HDMI micro cable.
- 30 [USB/CHARGE] socket (→17)
- 31 DC coupler cover (→60)
- 32 Card/Battery door (→16)
- 33 Release lever (→16)
- 34 Tripod mount
 - Do not attach this unit to tripods that have screws with a length of 5.5 mm (0.22 inch) or more. Doing so may damage this unit or the unit may not be secured properly on the tripod.
- 35 Touch screen (→25) / monitor (→50)
 - Always use a genuine Panasonic AC adaptor (DMW-AC10PP: optional). (→60)
When using an AC adaptor (DMW-AC10PP: optional), ensure that the Panasonic DC coupler (DMW-DCC6: optional) and AC adaptor (DMW-AC10PP: optional) are used.
 - [Fn4] to [Fn8] (→25) are touch icons. They are displayed by touching the [Fn] tab on the recording screen.

Attaching the Lens Cap/Shoulder Strap

Attaching the Lens Cap

Cover the lens with the lens cap to protect it when you are not taking pictures.

- Do not hang or swing around the camera with the lens cap string.
- Make sure to detach the lens cap when turning this unit on.
- Be careful that the lens cap string does not become entangled with the shoulder strap.

1 Pass the string through the shoulder strap eyelet on the camera

Ⓐ Shoulder strap eyelet

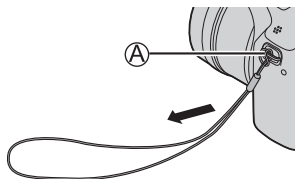

2 Pass the same string through the hole on the lens cap

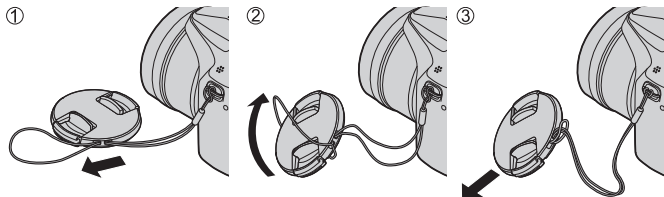

3 Attach the lens cap

Ⓑ Pinch here to attach or detach the cap.

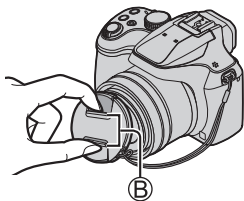

Attaching the Shoulder Strap

We recommend attaching the shoulder strap when using the camera to prevent it from dropping.

1 Pass the shoulder strap through the hole at the shoulder strap eyelet

- Attach the shoulder strap so that the “LUMIX” Logo is on the outside.

(A) Shoulder strap eyelet

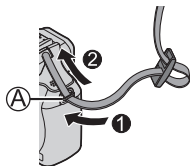

2 Pass the end of the shoulder strap through the stopper

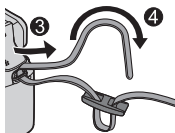

3 Pass the end of the shoulder strap through the hole on the other side of the stopper

(B) Pull the shoulder strap 2 cm (0.066 feet) or more.

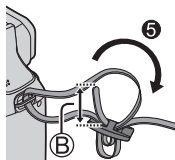

4 Pull the shoulder strap and then check that it will not come out

- Perform steps 1 to 4 and then attach the other side of the shoulder strap.
- Use the shoulder strap around your shoulder.
 - Do not wrap the strap around your neck. It may result in injury or accident.
- Do not leave the shoulder strap where an infant can reach it.
 - It may result in an accident by mistakenly wrapping around the neck.

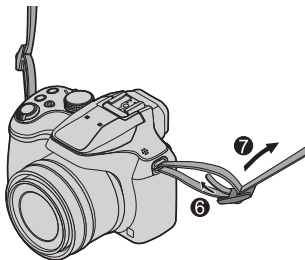

Inserting and removing the battery or SD memory card (optional)

Make sure that the camera is turned off.

1 Slide the release lever (A) to the [OPEN] position and open the card/battery door

2 Insert the battery and card, making sure that their orientation is correct

- Battery: Insert the battery all the way firmly and check that it is locked by lever (B).
- Card: Insert the card all the way firmly until it clicks. Do not touch the terminal.

3 Close the door

Slide the release lever to the [LOCK] position.

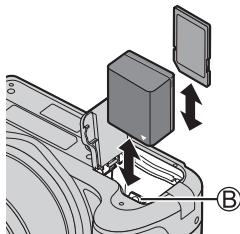
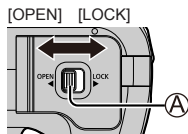

■ To remove

• To remove battery

Move lever (B) in direction of arrow.

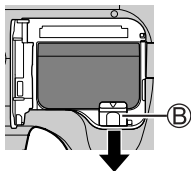

• To remove card

Push the card until it clicks, then pull the card out.

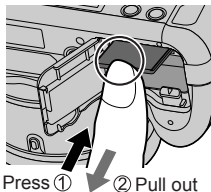

- Always use genuine Panasonic batteries (DMW-BMB9PP).
- If you use other batteries, we cannot guarantee the quality of this product.
- Keep the Memory Card out of reach of children to prevent swallowing.

Charging the battery

- The battery that can be used with this unit is DMW-BMB9PP.
- We recommend charging in a location where the ambient temperature is between 10 °C and 30 °C (50 °F to 86 °F).

Make sure that the camera is turned off.

1 Insert the battery to this unit, and then connect this unit to the AC adaptor (supplied) (B) or a PC (D)

- (A) USB connection cable (supplied)
 - (B) AC adaptor (supplied)
 - (C) To the electrical outlet
 - (D) Computer
- Getting ready: Turn on the computer.

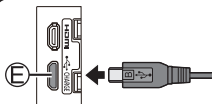
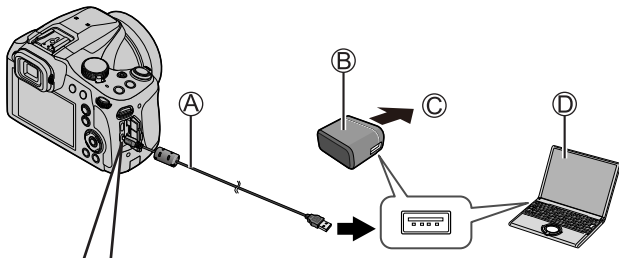

(E) [USB/CHARGE] socket

- This terminal is located at the bottom when the camera is in an upright position.

- Always check the direction of the pins and hold the plug straight to insert or remove it. (If the cable is inserted in the wrong direction, the pins could become deformed and cause faulty operation.) Also, do not insert into the wrong socket. Doing so may cause damage to this unit.

■ Charging lamp indications

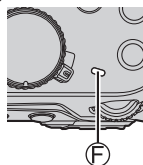
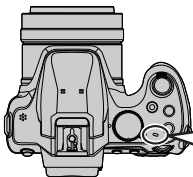

ⓕ Charging lamp

On: Charging in progress

Off: Charging complete (After charging stops, disconnect the camera from the electrical outlet or your computer.)

Flashing: Charging error (→54)

■ Notes on charging time

When using the AC adaptor (supplied)	Approx. 170 min.
--------------------------------------	------------------

- The charging time indicated above is the time required for charging in case when the battery is completely used up. The time required for charging differs depending on conditions of battery usage. Charging takes longer in cases when temperatures are either high or low and when the battery has not been used for a long period of time.
 - The time required for charging through the computer varies depending on the power supply capacity of the computer.
- Do not use any other USB connection cables except the supplied one.
 - Do not use any other AC adaptors except the supplied one.
 - Do not use the AC adaptor (supplied) or the USB connection cable (supplied) with other devices.

Setting the clock

The clock is not set when the camera is shipped.

1 Turn the camera on

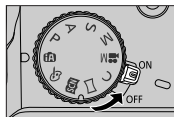

2 Press [MENU/SET]

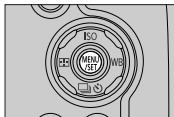

3 Press ▲ ▼ to select the language and press [MENU/SET]

• The [Please set the clock] message appears.

4 Press [MENU/SET]

5 Press ◀ ▶ to select the items (year, month, day, hour, minute), and press ▲ ▼ to set

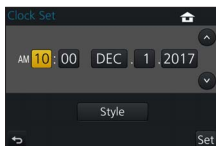

6 Press [MENU/SET]

7 When [The clock setting has been completed.] is displayed, press [MENU/SET]

8 When [Please set the home area] is displayed, press [MENU/SET]

9 Press ◀ ▶ to set your home area and press [MENU/SET]



Basic operations

Zoom lever (Use zoom)

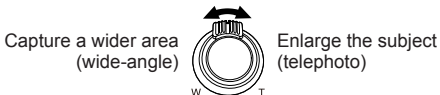

■ Zoom types and use

Optical Zoom:

You can zoom in without degrading the picture quality.

Maximum magnification: 60x

Extended optical zoom:

This function works when picture sizes with [EX] have been selected in [Picture Size]. Extended optical zoom allows you to zoom in using a higher zoom ratio than optical zoom, without degrading the picture quality.

Maximum magnification: 122x*

*Including the optical zoom ratio. The maximum zoom ratio varies depending on the picture size.

[i.Zoom]:

You can use the camera's intelligent resolution technology to increase the zoom ratio up to 2x higher than the original zoom ratio with limited deterioration of picture quality. (Up to 1.5x the original zoom ratio when [Picture Size] is set to [S]) Set the [i.Zoom] in the [Rec] menu to [ON].

[Digital Zoom]:

Zoom 4x further than Optical/Extended optical zoom. When [Digital Zoom] is used simultaneously with [i.Zoom], you can only increase the zoom ratio up to 2x. Note that, with Digital Zoom, enlarging will decrease picture quality. Set the [Digital Zoom] in the [Rec] menu to [ON].

- When [Live View Mode] (→44) is set to [ECO 30fps], Digital Zoom is not available (default setting).

Shutter button (Taking pictures)

1 Press the shutter button halfway (press lightly) to focus on the subject

- The aperture value and shutter speed are displayed. (If the aperture value and shutter speed are shown in red and flashing, you do not have the appropriate exposure, unless you are using the flash.)

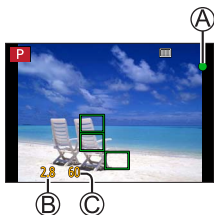

- (A) Focus display
(When focus is aligned: illuminated
When focus is not aligned: flashing)
- (B) Aperture value
- (C) Shutter speed

2 Press the shutter button fully (push the button all the way), and take the picture



- Pictures can be taken only when the image is correctly focused as long as the [Focus/Release Priority] (→44) is set to [FOCUS].

■ Estimated number of recordable pictures

1610*

- * (When [Aspect Ratio] is set to [4:3], [Quality] is set to [L], [Picture Size] is set to [L] (18M), and using a card of 16 GB)

■ Check the picture you have taken

- [Auto Review] displays the pictures you have taken after taking still pictures.
- Press the [] (Playback) button to display the picture. (→41)

Mode dial (Select the recording mode)

1 Set to the desired recording mode

- Rotate the mode dial slowly to select the desired mode.



iA	iA Intelligent Auto Mode (→27)
	iA+ Intelligent Auto Plus Mode (→27)
P	Program AE Mode Take pictures with automatic shutter speed and aperture value settings.
A	Aperture-Priority AE Mode Determine aperture, then take pictures.
S	Shutter-Priority AE Mode Determine shutter speed, then take pictures.
M	Manual Exposure Mode Determine aperture and shutter speed, then take pictures.
M	Creative Video Mode Determine aperture and shutter speed, then record motion pictures. • You cannot take still pictures.
C	Custom Mode Take pictures using pre-registered settings.
	Panorama Shot Mode Take panorama pictures.
	Scene Guide Mode Take pictures that match the scene being recorded.
	Creative Control Mode Take pictures by selecting your preferred picture effect.

[AF/AF \updownarrow /MF] button (Switching the focus mode)

1 Press [AF/AF \updownarrow /MF] button

- [AF]
 - Focus is set automatically when the shutter button is pressed halfway. To switch [AF Mode] (→24)
- [AF \updownarrow] ([AF Macro])
 - You can take pictures of a subject as close as 1 cm (0.033 feet) from the lens by rotating the zoom lever upmost to Wide.
- [AF \updownarrow (M)] ([Macro Zoom])
 - Use this setting to get close to the subject and then further enlarge when taking the picture. You can take a picture with the digital zoom up to 3x while maintaining the distance to the subject for the extreme Wide position (1 cm (0.033 feet)).
- [MF] (→28)

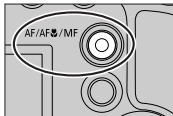

2 Press \blacktriangleleft \blacktriangleright to select the focus mode and press [MENU/SET]

[LVF] button (Switching the Monitor/Viewfinder)

1 Press [LVF] (A) button

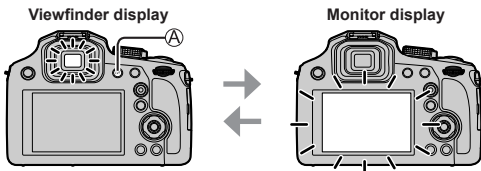

- If [Monitor Priority (Play)] of the [Setup] menu is set to [ON], pictures will be played back on the monitor after switching to playback mode.

■ About diopter adjustment

Rotate the diopter adjustment dial (B) to adjust until you are able to clearly see the characters displayed in the viewfinder.

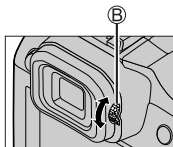

Rear dial

There are 2 ways to operate the rear dial, rotating left or right, and deciding by pressing.

Rotating:

Selection of items or setting of values is performed during the various settings.

Pressing:

Operations that are the same as [MENU/SET] button, such as determine settings, etc., are performed during the various settings.



- You can use the rear dial to compensate the exposure (→29) or adjust the aperture value and shutter speed. The items that can be adjusted differ according to the recording mode.

Cursor button

- Selection of items or setting of values etc., is performed.
- This Owner's Manual expresses the up, down, left, and right of the cursor button as ▲▼◀▶.

You can perform the following operations while recording. (Some items or settings cannot be selected depending on the mode or display style the camera is in.)





[ISO] (ISO sensitivity) (▲)

- Set ISO sensitivity (sensitivity to lighting). We recommend higher settings to take clear pictures in darker locations.

[WB] (White balance) (▶)

- Adjusts the color depending on the light source to ensure natural color.

[] (Drive mode) (▼)

- [] ([Burst])*
 - Records a burst of still pictures while you press the shutter button fully.
- [] ([4K PHOTO])* (→30)
- [] ([Post Focus])* (→33)
- [] ([Self Timer])*

* To cancel drive mode, select [] ([Single]) or [] ([Off]).

[] (AF Mode) (◀)

- This allows the focusing method that suits the positions and number of the subjects to be selected.

Function buttons

- [Fn1] to [Fn3] are buttons on the camera.
- [Fn4] to [Fn8] are touch icons. They are displayed by touching the [Fn] tab on the recording screen.
- You can assign frequently-used functions to particular buttons or icons with [Fn Button Set] in [Custom] menu.

Touch screen (Touch operations)

Touch screen of this unit is capacitive. Touch the panel directly with your bare finger.

Touch

To touch and release the touch screen. Be sure to touch the center of the desired icon.



Drag

To touch and slide your finger across the touch screen. This can also be used to forward or rewind a picture during playback, etc.



Pinch (spread/pinch)

On the touch screen, spread (pinch out) your 2 fingers to zoom in, and pinch (pinch in) your 2 fingers to zoom out.



Setting the menu

- 1 Press [MENU/SET] to bring up the menu
- 2 Press ▲▼ to select the menu item and press [MENU/SET]
- 3 Press ▲▼ to select the setting and press [MENU/SET]

- The setting methods vary depending on the menu item.



- 4 Press [Q.MENU/↵] button repeatedly until the recording or playback screen reappears

- During recording, the menu screen can also be exited by pressing the shutter button halfway.

■ Switching menu type

- ① Press ◀ after performing step 1 above
- ② Press ▲▼ to select a tab such as [wrench]
- ③ Press [MENU/SET]



■ Menu types (→43)

- [Rec] [Camera icon]
- [Motion Picture] [Motion Picture icon]
- [Setup] [Wrench icon]
- [Playback] [Play button icon]
- [Custom] [Custom icon]



Taking pictures with automatic settings

(Intelligent Auto Mode)

Recording mode:  

This mode is recommended for those who want to point and shoot as the camera optimizes settings to match the subject and recording environment.

1 Set mode dial to

- The camera will switch to either the most recently used of Intelligent Auto Plus Mode  or Intelligent Auto Mode .





2 Point the camera at the subject



- When the camera identifies the optimal scene, the icon for each scene turns blue for 2 seconds and then changes to the normal red indication.





■ Switching between Intelligent Auto Plus Mode and Intelligent Auto Mode



- Touch the recording mode icon at the upper left in recording screen
- Select  or  and touch [Set]



-  allows you to adjust some settings such as the brightness and color tone while also using  for other settings so that you can record pictures more suited to your preferences.

■ Auto Focus (Face/Eye Detection)

[AF Mode] is automatically set to . If you touch the subject, the camera switches to  and the AF tracking function starts operating.

You can also switch to  by pressing . Align the AF tracking area with the subject and press the shutter button halfway to operate the AF tracking function.

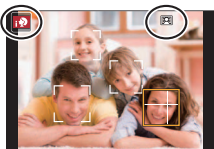

Taking pictures with Manual Focus

Recording mode: 

Manual Focus is convenient when you want to lock the focus to take pictures or when it is difficult to adjust focus using Auto Focus.

1 Press [AF/AF-L/MF] button

2 Press ◀▶ to select [MF] and press [MENU/SET]



3 Press [MF Assist] button (◀)

- The focus adjusting screen will be displayed.
- When [MF Assist] is set to [ON], MF Assist (enlarged screen) is displayed (→44). You can move the enlarged part by dragging the screen (→25).

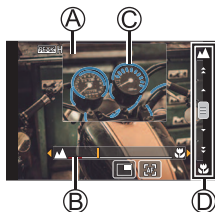

4 Adjust the focus

- (A) MF Assist (Enlarged screen)
- (B) MF Guide
- (C) Peaking
- (D) Slide bar



	Focuses on nearby subject
	Focuses on distant subjects

- Pressing and holding ◀▶ will increase the focus speed.
- Focus can also be adjusted by dragging the slide bar.
- Color is added to the portions of the image that are in focus. (Peaking)

Operation	Touch operation	Description
—	Pinch in / Pinch out	Enlarges/reduces the screen in small steps.
	—	Enlarges/reduces the screen in large steps.
		Switches the enlarged display. (windowed/full screen)

* This setting is not available in Intelligent Auto Mode.

5 Press the shutter button halfway

- The recording screen will be displayed.

Taking pictures with Exposure Compensation

Recording mode: **iA** **FAV** **P** **A** **S** **M** **CM** **□** **SCN** **Ⓜ**

Corrects the exposure when there is a backlight or when the subject is too dark or too bright.

1 Press the rear dial to switch to Exposure Compensation operation

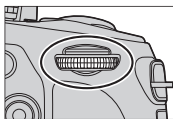

2 Rotate the rear dial to compensate the exposure

- (A) Exposure Bracket
- (B) Exposure Compensation

Operation	Description
	Compensates the exposure
	Sets the exposure bracket (→36)

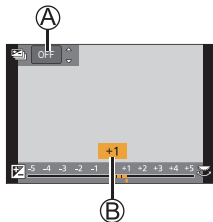

3 Press the rear dial to set

- You can also press the shutter button halfway to set.

- You can set the exposure compensation value in the range between -5 EV and $+5$ EV.
Settings can be made within a range of -3 EV to $+3$ EV while recording motion pictures, recording 4K photos, or recording in [Post Focus].
- Depending on the brightness, this may not be possible in some cases.

Recording with the 4K Photo function

Recording mode:

You can take burst pictures of approximately 8 million pixels with a burst rate of 30 fps. You can select and save a frame from the burst file.

- To record pictures, use a UHS Speed Class 3 card.
- When recording, the angle of view becomes narrower.

1 Press [] button

2 Press ◀▶ to select the recording method and press [MENU/SET]





<p>[4K Burst]</p>	<p>For capturing the best shot of a fast-moving subject Burst recording is performed while the shutter button is pressed and held.</p> <ul style="list-style-type: none"> • Recording will start approximately 0.5 seconds after you press the shutter button fully. Therefore, press the button fully as soon as possible. <p>(A) Press and hold (B) Recording is performed</p>	
<p>[4K Burst(S/S)] “S/S” is an abbreviation of “Start/Stop”.</p>	<p>For capturing unpredictable photo opportunities Burst recording starts when the shutter button is pressed and stops when pressed again.</p> <p>(C) Start (First) (D) Stop (Second) (E) Recording is performed</p>	
<p>[4K Pre-Burst]</p>	<p>For recording as needed whenever a photo opportunity arises Burst recording is performed for approximately 1 second before and after the moment that the shutter button is pressed.</p> <p>(F) Approximately 1 second (G) Recording is performed</p>	

3 Record a 4K photo

- When you perform 4K burst photo recording, a 4K burst file will be saved in the MP4 format.
- When [Auto Review] is enabled, the picture selection screen will be displayed automatically.
- You can compare multiple frames captured in a 4K burst file, overlay the bright areas, and combine them into one picture. ([Light Composition]) (→42)

■ To cancel the 4K Photo functions

In step 2, select [].

- If the surrounding temperature is high or 4K photos are recorded continuously, [] may be displayed and recording may be stopped halfway through. Wait until the camera cools down.
- **When [] ([4K Pre-Burst]) is set, the battery drains faster and the camera temperature rises. (to protect itself, the camera may switch to [] ([4K Burst]))**
Select [] ([4K Pre-Burst]) only when recording.
- Recording stops when the continuous recording time exceeds 15 minutes. When using an SDHC memory card, files are split into smaller picture files for recording and playback if the file size exceeds 4 GB. (You can continue to record pictures without interruption.)
If using an SDXC Memory Card, you can record pictures in a single file even if the size is greater than 4 GB.

Selecting pictures from 4K burst file and saving

1 Select a picture with the [▲] [4K] on the playback screen, and press ▲

- In the case of recording with [4K PRE] ([4K Pre-Burst]), proceed to the step 3.



2 Drag the slide bar to perform rough scene selection

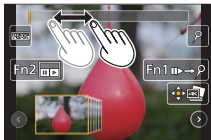

3 Drag to select the frame you want to save as a picture

- Touch [◀] / [▶] to display the previous or next set of frames (45) in slide view.



4 Touch [SAVE] to save the picture

- The picture will be saved in JPEG format.

- For details, refer to "Owner's Manual for advanced features (PDF format)" or "Quick Guide for 4K Photo (supplied)".

[4K PHOTO Bulk Saving]

If you use [4K PHOTO Bulk Saving] in the [Playback] menu, you can bulk save 5 seconds' worth of 4K recording.

1 Use ◀▶ to select the 4K burst files and press [MENU/SET]

- If the burst time is 5 seconds or less, all the frames can be saved as a picture.

2 Select the first frame to be bulk saved as a picture

- The selection method is the same as the operation to choose the frame you want to save as a picture from a 4K burst file. (above)
- The picture will be saved in JPEG format as a single burst picture group.

Adjusting the focus after recording

([Post Focus] / [Focus Stacking])

Recording mode: 

You can record 4K burst pictures while changing the focus point and then select a focus point after recording. This function is best for non-moving subjects.

You can select multiple focus points and combine them into one picture. ([Focus Stacking])

- We recommend using a tripod to perform [Focus Stacking].
- To record pictures, use a UHS Speed Class 3 card.
- During recording, the angle of view will be narrower.

1 Press button

2 Press to select [ON] and press [MENU/SET]

3 Determine the composition and press the shutter button halfway

- Auto Focus activates and automatically detects the focus point on the screen.
- If there is no focus point on the screen, the Focus indicator (A) blinks and you cannot record.



From halfway pressing the shutter button to completion of recording

- Do not change the distance to subject or the composition.

4 Press the shutter button fully to start recording

- The focus point changes automatically while recording. When the recording progress bar (B) disappears, recording automatically ends.
- A motion picture will be recorded in MP4 format. (No audio is recorded.)
- If Auto Review is set, a screen will automatically appear that lets you select the focus point. (→34)



■ Canceling [Post Focus]

Select [OFF] in step 2.

- If the surrounding temperature is high or [Post Focus] recording is performed continuously,  may be displayed and recording may be stopped halfway through. Wait until the camera cools down.

Select the focus point and save the picture ([Post Focus])









1 On the playback screen, select the image with the  icon and press **▲**



2 Touch the focus point

- If there are no pictures with the focus on the selected point, a red frame will be displayed, and pictures cannot be saved.
- The edge of the screen cannot be selected.



Operation		Touch operation	Description
		Touch	Select focus point <ul style="list-style-type: none"> • No selection can be made while display is enlarged.
	 / 		Enlarge display / Shrink display (when in enlarged display)
[Fn1]			Switches to [Focus Stacking] operation (→35)
[Fn2]			In-focus portions are highlighted with color. ([Peaking]) <ul style="list-style-type: none"> • Switches in order of [PEAK OFF] → [PEAK L] ([LOW]) → [PEAK H] ([HIGH]).
[MENU/SET]			Save picture

- You can make fine adjustments to the focus by dragging the slide bar during enlarged display.

3 Touch  to save the picture

- The picture will be saved in JPEG format.

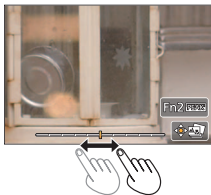

- You cannot choose and save the picture from a TV screen even if the camera is connected to a TV through an HDMI micro cable.

Select the focus range to combine and create a single picture ([Focus Stacking])

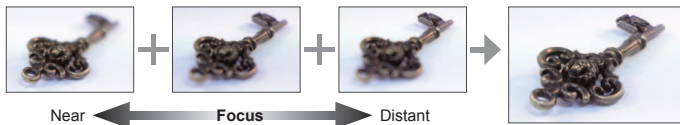

- 1 Touch on screen in step 2 of “Select the focus point and save the picture ([Post Focus])” (→34)
- 2 Choose a stacking method and touch it

[Auto Merging]	Automatically select photos suitable for stacking and combine them into one picture. <ul style="list-style-type: none"> • Choose by giving preference to near-focus pictures. • Perform the focus stacking and save the picture.
[Range Merging]	Combine the pictures with the selected focus position into one picture.

- 3 (When selecting [Range Merging])
Touch the focus point

- Select positions at two or more points.
- Focus points between the selected two positions will be selected.
- Positions that cannot be selected, or that would produce an unnatural result will be grayed out.

- Touch a position again to deselect it.

- 4 Touch to combine and save the picture

- The picture will be saved in JPEG format.

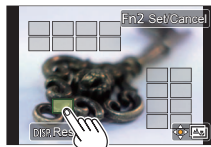

- Only pictures taken using [Post Focus] are eligible for [Focus Stacking].

Taking Pictures While Adjusting a Setting Automatically (Bracket Recording)

Recording mode:

You can take multiple pictures while automatically adjusting a setting by pressing the shutter button.

1 Set the menu (→26)

MENU → [Rec] → [Bracket] → [Bracket Type]	
(Exposure Bracket)	Press the shutter button to perform recording while adjusting the exposure.
(White Balance Bracket)	Press the shutter button once to take three pictures with different white balance settings automatically.

2 Press ▼ to select [More settings] and then press [MENU/SET]

- If [] is set, rotate the rear dial to set the adjustment range.
- Press the shutter button halfway to exit the menu.

3 Focus on the subject and take a picture

■ To cancel [Bracket]

Select [OFF] in step 1.

Exposure Bracket

■ About [More settings] (step 2 above)

[Step]	Sets the number of pictures to be taken and the exposure compensation range.
[Sequence]	Sets the order in which pictures are taken.
[Single Shot Setting]*	: Takes one picture each time you press the shutter button. : Takes all the pictures set to be taken when you press the shutter button once.

* Not available for burst recording.

Recording Motion Picture/4K Motion Picture

Recording mode:        

You can record full high-definition quality images that comply with the AVCHD standard, as well as motion pictures or 4K motion pictures recorded in MP4.

1 Press the motion picture button to start recording

- (A) Recording (flashes red)
- (B) Elapsed recording time
- (C) Remaining recording time

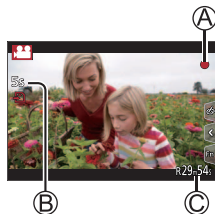

- Recording of motion picture appropriate for each motion picture mode is possible.
- Immediately release the motion picture button after pressing it.
- If you press the shutter button down fully, you can take still pictures while recording motion pictures. (Except for in Creative Video Mode)

2 Press the motion picture button again to end recording

- If the surrounding temperature is high, or a motion picture is recorded continuously, [>] is displayed and recording may be stopped halfway through. Wait until the camera cools down.
- **With recording in a quiet environment, the sound of aperture, focus and other actions may be recorded in motion pictures. This is not a malfunction.**
- To record 4K motion pictures, use a UHS Speed Class 3 card.
- When you record 4K motion pictures, the angle of view will be narrower than motion pictures of other sizes.
- To ensure highly accurate focus, 4K motion pictures are recorded at reduced Auto Focus speeds. It may be difficult to focus on the subject with Auto Focus, but this is not a malfunction.

■ Setting the format, picture size and recording frame rate

MENU →  **[Motion Picture]** → **[Rec Format]**

Settings: **[AVCHD]** / **[MP4]**

MENU →  **[Motion Picture]** → **[Rec Quality]**

When **[AVCHD]** is selected:

[FHD/28M/60p]*1 / **[FHD/17M/60i]** / **[FHD/24M/30p]**

● **[AVCHD]** motion pictures:

Files are split into smaller motion picture files for recording when the file size exceeds 4 GB.

● Motion pictures with **[Rec Quality]** setting of **[FHD/28M/60p]**/**[FHD/17M/60i]** in **[AVCHD]**:

Recording stops when the continuous recording time exceeds 29 minutes and 59 seconds.

When **[MP4]** is selected:

[4K/100M/30p]*2 / **[FHD/28M/60p]** / **[FHD/20M/30p]** / **[HD/10M/30p]**

● Motion pictures with their file size set to **[FHD]** or **[HD]** in **[MP4]**:

Files are split into smaller motion picture files for recording and playback when the file size exceeds 4 GB. (You can continue to record motion pictures without interruption.)

● Motion pictures with **[Rec Quality]** setting of **[FHD/28M/60p]** in **[MP4]**:

Recording stops when the continuous recording time exceeds 29 minutes and 59 seconds.

● Motion pictures with their file size set to **[4K]** in **[MP4]**:

Recording stops when the continuous recording time exceeds 15 minutes.

When using an SDHC memory card, files are split into smaller motion picture files for recording and playback if the file size exceeds 4 GB. (You can continue to record motion pictures without interruption.)

If using an SDXC Memory Card, you can record a motion picture in a single file even if the size is greater than 4 GB.

*1 AVCHD Progressive

*2 4K motion pictures

[4K Live Cropping]

Recording mode: 

By cropping your motion picture down from the 4K angle of view to Full High Definition, you can record a motion picture that pans and zooms in/out while leaving the camera in a fixed position.

- Hold the camera firmly in place while recording.
- A motion picture will be recorded at [FHD/20M/30p] under [MP4].

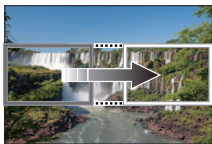

Pan

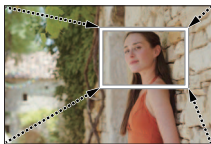

Zoom in

- When you want to zoom in/out, set different angles of view for the cropping start and end frames. For example, to zoom in, set a larger angle of view for the start frame and a smaller angle of view for the end frame.

1 Set mode dial to [M]

2 Set the menu (→26)

MENU →  [Motion Picture] → [4K Live Cropping]

Settings: [40SEC] / [20SEC] / [OFF]

- The angle of view narrows.

3 Set the crop start frame

- When making settings for the first time, a crop start frame of size 1920×1080 is displayed. (After setting the crop start frame and end frame, the start frame and end frame that you set immediately before will be displayed.)

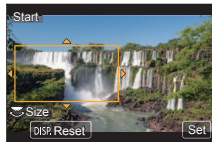

Operation	Touch operation	Description
▲▼◀▶	Touch	Moves the frame
	Pinch out / Pinch in	Enlarges/reduces the frame (The range of settings allowed is from 1920×1080 to 3840×2160.)
[DISP.]	[Reset]	Returns the position of the frame to the center and its size to the default setting.
[MENU/SET]	[Set]	Decides the position and size of the frame

4 Repeat step 3, and then set the crop end frame



5 Press the motion picture button (or the shutter button) to start recording

- (A) Elapsed recording time
- (B) Set operating time

- Immediately release the motion picture button (or the shutter button) after pressing it.
- When the set operating time has elapsed, recording automatically ends. To end recording midway, press the motion picture button (or the shutter button) again.

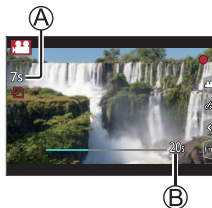

■ Changing the position and size of a crop frame

Press [Fn1] button while the recording screen is displayed, and perform steps 3 and 4.

■ To cancel [4K Live Cropping] recording

Set [OFF] in step 2.

- Focus is adjusted and fixed in the crop start frame.
- [Continuous AF] is set to [OFF].
- [Metering Mode] will be [(☉)] (Multi Metering).

Viewing your pictures

1 Press [▶] (Playback) button

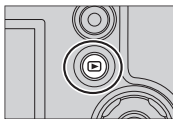

2 Press ◀▶ to select a picture to be displayed

- The playback screen appears if the camera is turned on while pressing [▶] (Playback) button.
- When [Lens Retraction] (→44) is set to [ON], the lens barrel is retracted after approx. 15 seconds as the camera is switched to the playback screen from the recording screen.

■ Viewing motion pictures

This unit was designed to play motion pictures using the AVCHD and MP4 formats.

- Motion pictures are displayed with the motion picture icon ([▶]).

① Press ▲ to start playback

- If you press [MENU/SET] during a pause, you can create a picture from a motion picture.



■ Deleting pictures

Deleted pictures cannot be recovered.

- ① Press [⏏] button to delete displayed picture
- ② Use ▲ to select [Delete Single] and press [MENU/SET]

■ Ending Playback

Press [▶] (Playback) button again or press the motion picture button.
The playback can also be ended by pressing the shutter button halfway.

■ Sending pictures to the WEB services

If you press ▼ while a single picture is being displayed, you can send the picture to the WEB service quickly.

[Light Composition]

Select multiple frames from 4K burst files that you wish to combine. Parts of the image that are brighter than the preceding frame will be superimposed on the preceding frame to combine the frames into one picture.



- When using [Light Composition], it is recommended to use a tripod or use a smartphone instead of the shutter and do remote recording (→48) to control camera shaking.

MENU → **[Playback]** → **[Light Composition]**

1 Use to select the 4K burst files and press **[MENU/SET]**

2 Choose the combining method and press **[MENU/SET]**

■ [Composite Merging]: Selecting frames to combine

① Drag the slide bar or use to select the frames to combine

② Press **[MENU/SET]**

- The selected frames are remembered, and the display goes to the preview screen.
- Use to select items and press **[MENU/SET]** to perform the following operations.



– [Next]: Lets you select more frames for combining.

– [Reselect]: Discards the frame selected immediately before and lets you select a different image.

③ Repeat steps ① - ② to select more frames to combine (up to 40 frames)

④ Press to select [Save] and press **[MENU/SET]**

■ [Range Merging]: Selecting a range to combine

① Select the frame of the first picture and then press **[MENU/SET]**

- The selection method is the same as in step ① of [Composite Merging] setting. (→42)

② Select the frame of the last picture and then press **[MENU/SET]**

3 Select **[Yes]** at the confirmation screen and press **[MENU/SET]**

- The picture will be saved in JPEG format.

Menu list

- The [Photo Style], [Filter Settings], [AFS/AFF/AFC], [Metering Mode], [Highlight Shadow], [i.Dynamic], [i.Resolution], [Diffraction Compensation], [i.Zoom], [Digital Zoom], [Stabilizer], and [Conversion] menu items are common for both [Rec] and [Motion Picture] menus. If a setting in one menu is changed, the setting with the same name in other menu will also be changed automatically.

■ To display explanations of the menu items

When [Menu Information] in the [Setup] menu is set to [ON], explanations of the menu items and settings are displayed on the menu screen.

Ⓐ Explanations of the menu items and settings

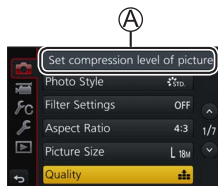

📷 [Rec]

[Photo Style]	[i.Dynamic]	[ISO Limit Set]
[Filter Settings]	[i.Resolution]	[ISO Increments]
[Aspect Ratio]	[iHandheld Night Shot]	[Extended ISO]
[Picture Size]	[iHDR]	[Diffraction Compensation]
[Quality]	[HDR]	[i.Zoom]
[AFS/AFF/AFC]	[Multi Exp.]	[Digital Zoom]
[Metering Mode]	[Time Lapse Shot]	[Conversion]
[Burst Rate]	[Stop Motion Animation]	[Color Space]
[4K PHOTO]	[Panorama Settings]	[Stabilizer]
[Bracket]	[Shutter Type]	[Face Recog.]
[Self Timer]	[Flash]	[Profile Setup]
[Highlight Shadow]	[Red-Eye Removal]	

📹 [Motion Picture]

[4K Live Cropping]	[Exposure Mode]	[Silent Operation]
[Snap Movie]	[High Speed Video]	[Wind Noise Canceller]
[Rec Format]	[Continuous AF]	[Zoom Mic]
[Rec Quality]	[Flkr Decrease]	

fC [Custom]

[Cust.Set Mem.]	[MF Assist Display]	[Monitor Info. Disp.]
[Silent Mode]	[MF Guide]	[Rec Area]
[AF/AE Lock]	[Peaking]	[Remaining Disp.]
[AF/AE Lock Hold]	[Histogram]	[Auto Review]
[Shutter AF]	[Guide Line]	[Fn Button Set]
[Half Press Release]	[Center Marker]	[Zoom lever]
[Quick AF]	[Highlight]	[Lens Position Resume]
[Pinpoint AF Time]	[Zebra Pattern]	[Lens Retraction]
[Pinpoint AF Display]	[Monochrome Live View]	[Q.MENU]
[AF Assist Lamp]	[Constant Preview]	[Video Button]
[Direct Focus Area]	[Expo.Meter]	[Touch Settings]
[Focus/Release Priority]	[Dial Guide]	[Touch Scroll]
[AF+MF]	[LVF Disp.Style]	[Menu Guide]
[MF Assist]	[Monitor Disp. Style]	

f [Setup]

[Online Manual]	[Monitor Luminance]	[Language]
[Clock Set]	[Monitor Priority (Play)]	[Version Disp.]
[World Time]	[Economy]	[Exposure Comp. Reset]
[Travel Date]	[USB Mode]	[Self Timer Auto Off]
[Wi-Fi]	[TV Connection]	[No.Reset]
[Beep]	[m/ft]	[Reset]
[Live View Mode]	[Menu Resume]	[Reset Wi-Fi Settings]
[Monitor Display]/ [Viewfinder]	[Menu Background]	[Demo Mode]
	[Menu Information]	[Format]

▶ [Playback]

[Slide Show]	[Title Edit]	[Rotate]
[Playback Mode]	[Text Stamp]	[Rotate Disp.]
[Location Logging]	[Video Divide]	[Favorite]
[RAW Processing]	[Time Lapse Video]	[Print Set]
[4K PHOTO Bulk Saving]	[Stop Motion Video]	[Protect]
[Light Composition]	[Resize]	[Face Rec Edit]
[Clear Retouch]	[Cropping]	[Picture Sort]

What you can do with the Wi-Fi[®] function

● Operating the camera by connecting it to a smartphone

- Taking pictures via a smartphone (→48)
- Playing back pictures in the camera on a smartphone (→48)
- Saving pictures in the camera to a smartphone
- Sending pictures in the camera to social networking services
- Adding location information to pictures in the camera from a smartphone
- Combining motion pictures recorded with Snap Movie according to your preference on a smartphone

● Displaying still pictures on a TV

● Wireless printing

● Sending pictures to AV device

● Sending pictures to a PC

● Using WEB services

- This manual uses the term “smartphone” for both smartphones and tablets unless it is necessary to distinguish between them.
- The camera cannot be used to connect to a public wireless LAN connection.
- For details, refer to “Owner’s Manual for advanced features (PDF format)”.

■ About the [Wi-Fi] button

In this Owner’s Manual, a function button to which [Wi-Fi] is assigned is referred to as the [Wi-Fi] button. (At the time of purchase, [Wi-Fi] is assigned to [Fn4] button in recording mode, and [Fn1] in playback mode.)

- For details on the function button, refer to (→25).

To start up the Wi-Fi function (When in recording mode):

① Touch [Fn]



② Touch [Wi-Fi]



Operating the camera by connecting it to a smartphone

Installing the smartphone app “Panasonic Image App”

The “Image App” is an application provided by Panasonic.

Supported OS	Android™: Android 4.0 or later iOS: iOS 7.0 or later
Installation procedure	<ol style="list-style-type: none"> ① Connect your device to a network ② (Android) Select “Google Play™ Store” (iOS) Select “App Store” ③ Enter “Panasonic Image App” or “LUMIX” to search for the app ④ Select “Panasonic Image App” and install it 

- Use the latest version.
- Supported OS versions as of February 2017. Supported OS versions may be changed without prior notice.
- The service may not be able to be used properly depending on the type of smartphone being used.

For the latest information on the “Image App”, refer to the support site below.

**<http://panasonic.jp/support/global/cs/dsc/>
(This site is available in English only.)**

- When downloading the app on a mobile network, high packet communication fees may be incurred depending on the details of your contract.
- For details about the operating procedure, etc., refer to [Help] in the “Image App” menu.
- When you operate the “Image App” on the smartphone that is connected to the camera via Wi-Fi, [Help] in the “Image App” may not be displayed depending on the smartphone. In this case, after terminating the connection to the camera, reconnect the smartphone to a mobile phone network such as the 3G or LTE network or to a Wi-Fi router, and then display [Help] in the “Image App”.
- Some of the screens and information provided in this document may be different depending on the supported operating system and “Image App” version.

Connecting to a smartphone

You can easily establish a Wi-Fi connection on this unit without entering a password on your smartphone.

(On the camera)

MENU →  **[Setup]** → **[Wi-Fi]** → **[Wi-Fi Function]** → **[New Connection]**
→ **[Remote Shooting & View]**

- The information required for directly connecting your smartphone to this unit (SSID (A)) is displayed.
- You can also display the information by pressing the function button that [Wi-Fi] function is assigned.



(On your smartphone)

- 1 Turn on the Wi-Fi function in the setting menu
- 2 Select the SSID displayed on the screen of the camera
- 3 Start “Image App” (→46)

- When the connection confirmation screen appears on the camera, select [Yes] and press [MENU/SET]. (Only when making a connection for the first time.)



[Wi-Fi Password] is set to [OFF] at the time of purchase. When you start a Wi-Fi connection, be sure to verify that the device displayed on the camera's connection confirmation screen is really the device you want to connect to. Even if the wrong device is displayed, you will still be connected to it if you select “Yes”. If there seem to be other Wi-Fi enabled devices in the vicinity, we recommend that you set [Wi-Fi Password] to [ON]. For details, refer to “Owner’s Manual for advanced features (PDF format)”.

Closing the connection

1 Set the camera to Recording Mode

- Press the shutter button halfway to return to recording mode.

2 Select the camera's menu items to terminate the Wi-Fi connection

MENU →  [Setup] → [Wi-Fi]
→ [Wi-Fi Function] → [Yes]

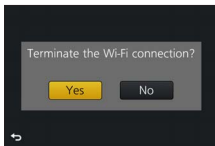

3 On the smartphone, close "Image App"

- For details on how to close the application, refer to the operating instructions of your device.

Taking pictures via a smartphone (remote recording)

1 Connect to a smartphone (→47)

2 Operate the smartphone

- ① Select 
- ② Take pictures
 - The recorded images are saved in the camera.
 - Some settings are not available.



Playing back pictures in the camera on a smartphone

1 Connect to a smartphone (→47)

2 Operate the smartphone

- ① Select 
 - When the picture is touched, it is played back at a larger size.



Downloading software

Still/motion pictures can be copied from the camera to your computer by connecting the two together. If you wish to play back or edit pictures on a PC, download software from the supplier's website and install it on your PC.

- To download the software, your PC must be connected to the Internet.
- It may take time to download the software in some communication environments.

PHOTOfunSTUDIO 9.9 PE

You can capture still pictures or motion pictures to your PC, or organize captured pictures by categorizing by recording date, model name of the digital camera used to record, etc. You can also correct still pictures, edit motion pictures, or write to DVD.

- Check the website below to download/install the software.
The software is available for download until the end of February 2022.
http://panasonic.jp/support/global/cs/soft/download/d_pfs99pe.html
- Supported OS: Windows® 10 / 8.1 / 8 / 7
 - “PHOTOfunSTUDIO” is not compatible with Mac.
 - For details, refer to “Owner’s Manual for advanced features (PDF format)”.

SILKYPIX Developer Studio SE

This software develops and edits RAW file pictures. Edited pictures can be saved in a file format such as JPEG or TIFF that can be displayed on a PC, etc.

- Check the website below to download/install the software.
<http://www.isl.co.jp/SILKYPIX/english/p/>
- Supported OS: Windows® 10 / 8.1 / 8 / 7
Mac OS X v10.6 - v10.12
- For details on the operating environment and how to use the SILKYPIX Developer Studio, refer to the “Help” or the Ichikawa Soft Laboratory’s support website.

LoiLoScope 30 day full trial version

Motion pictures can be edited easily.

- Check the website below to download/install the software.
<http://loilo.tv/product/20>
- Supported OS: Windows® 10 / 8.1 / 8 / 7
- For more information on how to use LoiLoScope and its operating environment, read the LoiLoScope manual available for download at the website.
- “LoiLoScope” is not compatible with Mac.

List of monitor/viewfinder displays

- The following images are examples of when the display screen is set to  (monitor style) in the monitor.



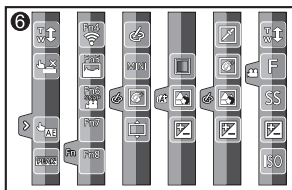
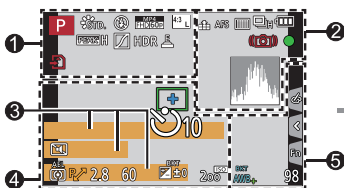













In recording



1	P	Recording mode (→22)
	C 1	Custom Set
	STD.	[Photo Style]
		[Flash]
	MP4 FHD/60p	[Rec Format]/ [Rec Quality]
	SNAP 4SEC	[Snap Movie]
	4:3 L	[Aspect Ratio]/ [Picture Size]
	STD.	Image size (Panorama Shot Mode)
		Picture effect (Filter) adjustment display
	EXPS	Types of picture effects (Filter)

	Card (displayed only during recording)
XXhXXmXXs	Elapsed recording time*1
	Simultaneous recording indicator (When taking still pictures while recording a motion picture)
PEAK H	[Peaking]
	[Highlight Shadow]
HDR	[HDR]/[iHDR]
	[Multi Exp.]
	[Conversion]
E	Electronic shutter
	Overheat indicator (→31, 33, 37)









②

	[Quality]
240fps 120fps	[High Speed Video]
AFS	[AFS/AFF/AFC]/MF
	AF Mode
	[Pull Focus]
	[Face Recog.]
AFL	AF Lock
	Burst
	[4K PHOTO] (→30)
	[Post Focus] (→33)
	[Self Timer]
	Remaining battery
AF 	Macro recording (→23)
	[Stabilizer]
	Jitter alert
	Recording state (Flashes red.) (→37)/ Focus (Lights green.) (→21)
	Focus (Under low illumination)
	Wi-Fi connection status
	Histogram

③

Name*2
Travel elapsed days*3
Age in years/months*2
Location*3
Current date/time*3
Travel destination setting*3: 
Exposure meter
Zoom (→20)

④

	AF area
+	Spot metering target
+	[Center Marker]
	[Self Timer]
	[Zoom Mic]
	[Silent Mode]
AEL	AE Lock
	[Metering Mode]
	Program Shift
2.8	Aperture value
60	Shutter speed
	Exposure compensation (→29)
	Exposure Bracket (→36)
	Brightness (exposure)
	Manual Exposure Assist
	ISO sensitivity

5

	[Dial Guide]
BKT AWB+	White Balance Bracket (→36)
	White Balance Fine Adjustment
	White Balance
	Coloring
98	Number of recordable pictures
RXXmXXs	Available recording time*1

6

Touch tab

	Touch zoom
	Touch Shutter
	[Touch AE]
	[Peaking]
	Function buttons (→25)

	Coloring
	Defocus control function
	Brightness (exposure)
	Type of defocus ([Miniature Effect])
	[One Point Color]
	[Sunshine]
	Picture effect (Filter) adjustment display
	Picture effects ON or OFF
	Picture effects (Filter)
	Aperture value
	Shutter speed
	ISO sensitivity

*1 [h], [m] and [s] indicate “hour”, “minute” and “second”.

*2 This is displayed for about 5 seconds when the camera is turned on if the [Profile Setup] (→43) setting is set.

*3 This is displayed for about 5 seconds when the camera is turned on, after setting the clock and after switching from Playback Mode to Recording mode.

- The information displayed, such as histograms, magnifications, and numeric values, are only for the purpose of reference.

■ On-monitor recording information

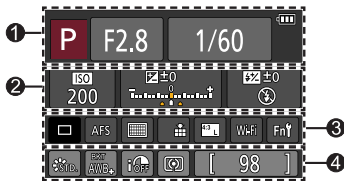

1

P	Recording mode (→22)
F2.8	Aperture value
1/60	Shutter speed
	Remaining battery

2

ISO 200	ISO sensitivity
	Exposure compensation (→29)
	Exposure Bracket (→36)
	Brightness (exposure)
	Manual Exposure Assist
	[Flash]

3

	Single
	Burst
	[4K PHOTO] (→30)
	[Self Timer]
AFS	[AFS/AFF/AFC]/MF
	AF Mode
	[Quality]
	[Aspect Ratio]/ [Picture Size]
Wi-Fi	Wi-Fi (→45)
Fn	Function button setting (→25)

4

	[Photo Style]
BKT AWB+	White Balance Bracket (→36)
AWB	White Balance Fine Adjustment
AWB	White Balance
	[i.Dynamic]
	[Metering Mode]
98	Number of recordable pictures
RXXmXXs	Available recording time*

* [h], [m] and [s] indicate "hour", "minute" and "second".

Q&A Troubleshooting

- Performing [Reset] in the [Setup] menu may resolve the issue.
- Further information is provided in the “Owner’s Manual for advanced features (PDF format)”. Check it together with the information in this section.

The charging lamp blinks.

- Charging is being performed in a place with extremely high or low temperature.
→ **Reconnect the USB connection cable (supplied) and retry charging in a place where ambient temperature is 10 °C to 30 °C (50 °F to 86 °F) (temperature conditions also apply to the battery itself).**
- Charging is not possible if the power supply capacity of the computer is low.

The battery runs down quickly.

- [4K PHOTO] is set to [Pre-Burst] ([4K Pre-Burst]).
→ When [Pre-Burst] ([4K Pre-Burst]) has been selected, the battery drains faster.
Select [Pre-Burst] ([4K Pre-Burst]) only when recording.

Focus not aligned correctly.

- Subject outside of focus range.
- [Focus/Release Priority] is set to [RELEASE]. (→44)
- [Shutter AF] is set to [OFF]. (→44)
- AF Lock is set inappropriately.
- If there are fingerprints or dirt on the lens, the focus may be set to the lens and not the subject.

Subject appears skewed in pictures.

- If you take a picture of a moving subject in the electronic shutter mode, motion picture recording mode, or 4K photo recording mode, the subject in the picture may be skewed in some cases. This is characteristic of MOS sensors which serve as the camera’s pickup sensors. This is not a malfunction.

Striping or flicker may appear under lighting such as fluorescent lighting and LED lighting fixture.

- This is characteristic of MOS sensors which serve as the camera’s pickup sensors. This is not a malfunction.
- If you are taking still pictures using the electronic shutter, the striping may be reduced by setting a slower shutter speed.
- When noticeable flicker or striping is seen under lighting such as a fluorescent or LED lighting fixture in the motion picture recording mode, you can reduce the flicker or striping by setting up [Flkr Decrease] (→43) and fixing the shutter speed. It is possible to select a shutter speed from [1/50], [1/60], [1/100], or [1/120]. You can set the shutter speed manually in the Creative Video Mode. (→22)

4K photo recording stops before finishing.

- When the ambient temperature is high or recording of the 4K Photo function is performed continuously, the camera may display [] and stop the recording. Wait until the camera cools down.

Cannot record motion pictures.

- When a large capacity card is used, you may not be able to take a picture for a while after you turn on the camera.

Sometimes focus adjustment with auto focus mode is difficult while recording 4K motion pictures.

- This may occur when taking a picture by reducing the auto focus speed in order to adjust the focus at high precision. This is not a malfunction.

No flash emitted.

- The flash becomes unavailable in the following cases.
 - The flash is closed.
- Set [Shutter Type] to [AUTO] or [MSHTR]. (→43)
- Set [Silent Mode] to [OFF]. (→44)

It cannot connect to the wireless LAN. Radio waves get disconnected.**General tips for using a Wi-Fi connection**

- Use within the communication range of the wireless LAN network.
- If any device, such as microwave oven, cordless phone, etc., that uses 2.4 GHz frequency are used nearby this unit simultaneously, radio waves may get interrupted.
 - Use them sufficiently away from the device.
- When the battery indicator is flashing red, the connection with other equipment may not start or the connection may be disrupted. (A message such as [Communication error] is displayed.)
- When this unit is placed on a metal table or shelf, the connection may not be established easily because the camera is affected by radio waves. Use the camera away from metal surfaces.

The lens makes a clicking noise.

- When the camera is turned on or off, the lens is moved, or an aperture operation is performed, such a noise may be heard. This is not a malfunction.
- When the brightness changes after a zooming operation or moving the camera, the lens may make a noise while adjusting the aperture. This is not a malfunction.

Zooming stops instantaneously.

- When using the Extended Optical Zoom, the zooming action will stop temporarily. This is not a malfunction.

Specifications

Digital Camera: Information for your safety

Power Source	DC 8.4 V (=== 8.4 V)
Power Consumption	1.9 W (When recording with monitor) 2.7 W (When recording with viewfinder) 1.5 W (When playing back with monitor) 1.6 W (When playing back with viewfinder)

Camera effective pixels	18,100,000 pixels
Image sensor	1/2.3" MOS sensor, total pixel number 18,900,000 pixels Primary color filter
Lens	Optical 60x zoom f=3.58 mm to 215 mm (35 mm film camera equivalent: 20 mm to 1,200 mm) Max. Wide: F2.8 to F8.0 Max. Tele: F5.9 to F8.0
Image Stabilizer	Optical method
Focus range	AF: 30 cm (0.98 feet) (Max. Wide)/ 1.5 m (4.9 feet) (Max. Tele) to ∞ AF Macro/MF/Intelligent Auto/Motion picture: 1 cm (0.033 feet) (Max. Wide)/ 1.5 m (4.9 feet) (Max. Tele) to ∞
Shutter system	Electronic shutter + Mechanical shutter
Minimum Illumination	Approx. 9 lx (when i-Low light is used, the shutter speed is 1/30th of a second)

Shutter speed	<p>Still picture: 60 seconds to 1/2000th of a second (When the mechanical shutter is used and [Artistic Nightscape] is selected as the Scene Guide Mode), 4 seconds to 1/2000th of a second (When the mechanical shutter is used, in cases other than the above), 1 second to 1/16000th of a second (When the electronic shutter is used) Motion picture: 1/2 second to 1/16000th of a second (When [Exposure Mode] is set to [M] in Creative Video Mode and [MF] is selected), 1/30th of a second to 1/16000th of a second (Other than the above)</p>
Exposure (AE)	Program AE (P)/Aperture-priority AE (A)/ Shutter-priority AE (S)/Manual exposure (M)/AUTO Exposure Compensation (1/3 EV steps, -5 EV to +5 EV)
[Metering Mode]	Multiple/Center weighted/Spot
Monitor	3.0" TFT LCD (3:2) (Approx. 1,040,000 dots) (field of view ratio about 100%) Touch screen
Viewfinder	0.2" Color LCD Live Viewfinder (4:3) (Approx. 1,170,000 dots equivalent) (field of view ratio about 100%) [Magnification approx. 2.59x, 0.46x (35 mm film camera equivalent), with 50 mm lens at infinity; -1.0 m ⁻¹] (with diopter adjustment -4.0 to +4.0 diopter)
Flash	Built-in pop up flash AUTO, AUTO/Red-Eye Reduction, Forced ON, Forced ON/Red-Eye Reduction, Slow Sync., Slow Sync./Red-Eye Reduction, Forced OFF
Microphones	Stereo
Speaker	Monaural

Recording media	SD Memory Card/SDHC Memory Card*/ SDXC Memory Card* * UHS-I UHS Speed Class 3
Recording file format	
Still picture	RAW/JPEG (based on Design rule for Camera File system, based on Exif 2.3 standard/DPOF corresponding)
Motion picture	AVCHD Progressive/AVCHD/MP4
Audio compression format	AVCHD: Dolby Audio™ (2 ch) MP4: AAC (2 ch)
Interface	
[HDMI]	Micro HDMI Type D
[USB/CHARGE]	USB 2.0 (High Speed) Micro-B
Dimensions	Approx. 130.2 mm (W) x 94.3 mm (H) x 119.2 mm (D) [5.13" (W) x 3.71" (H) x 4.69" (D)] (excluding the projection part)
Mass (weight)	With card and battery: Approx. 616 g (1.36 lb) Excluding card and battery: Approx. 572 g (1.26 lb)
Operating temperature	0 °C to 40 °C (32 °F to 104 °F)
Operating humidity	10%RH to 80%RH
Language select	[ENGLISH] / [DEUTSCH] / [FRANÇAIS] / [ESPAÑOL] / [PORTUGUÊS] / [ITALIANO] / [繁體中文] / [日本語]

■ Wi-Fi

Compliance standard	IEEE 802.11b/g/n (standard wireless LAN protocol)
Frequency range used (central frequency)	2412 MHz to 2462 MHz (1 to 11 ch)
Encryption method	Wi-Fi compliant WPA™/WPA2™
Access method	Infrastructure mode

■ AC adaptor

(Panasonic SAE0012A): Information for your safety

Input:	110 V – 240 V ~ 50/60 Hz 0.2 A
Output:	5 V === 1.0 A

■ Battery pack (lithium-ion)

(Panasonic DMW-BMB9PP): Information for your safety

Voltage/capacity:	7.2 V/895 mAh
--------------------------	---------------

The symbols on this product (including the accessories) represent the following:

~	AC
===	DC
	Class II equipment (The construction of the product is double-insulated.)

Specifications are subject to change without notice.

Digital Camera Accessory System

Description	Accessory#
Battery pack*1	DMW-BMB9
AC adaptor*2	DMW-AC10
DC coupler*2	DMW-DCC6
Lens adaptor	DMW-LA8
Tele conversion lens*3	DMW-LT55
Close-up lens*3	DMW-LC55
MC protector	DMW-LMCH55
ND filter	DMW-LNDH55
PL filter (Circular type)	DMW-LPL55
Flash	DMW-FL200L / DMW-FL360L / DMW-FL580L
LED video light	VW-LED1

*1 The battery pack can be charged from the camera using the AC adaptor (supplied).

*2 By using the AC adaptor (DMW-AC10: optional) and DC coupler (DMW-DCC6: optional), you can record and play back without worrying about the remaining battery charge.

When using an AC adaptor (optional), use the AC cable supplied with the AC adaptor. The AC adaptor (optional) can only be used with the designated Panasonic DC coupler (optional). The AC adaptor (optional) cannot be used by itself.

*3 The lens adaptor (DMW-LA8: optional) is necessary to attach a tele conversion lens or close-up lens.

- Part numbers are as of February 2017. These may be subject to change.
- Some optional accessories may not be available in some countries.
- (For U.S.A. only)

To order optional accessories please visit <http://shop.panasonic.com> or your local Photo Specialty Dealer.

Reading the Owner's Manual (PDF format)

More detailed operating instructions are available in "Owner's Manual for advanced features (PDF format)". To read it, download it from the website.

<http://panasonic.jp/support/dsc/oi/index.html?model=DC-FZ80&dest=P>



- Click the desired language.

■ Confirming URLs and QR codes with the camera

MENU →  **[Setup]** → **[Online Manual]**

Settings: [URL display] / [QR Code display]

- The URL or QR code will be displayed on the camera monitor.
- You will need Adobe Reader to browse or print the Owner's Manual (PDF format). You can download and install a version of Adobe Reader that you can use with your OS from the following website. (As of February 2017)
<http://www.adobe.com/products/acrobat/readstep2.html>

Limited Warranty (ONLY FOR U.S.A.)

Panasonic Products Limited Warranty

Limited Warranty Coverage (For USA Only)

If your product does not work properly because of a defect in materials or workmanship, Panasonic Corporation of North America (referred to as “the warrantor”) will, for the length of the period indicated on the chart below, which starts with the date of original purchase (“warranty period”), at its option either (a) repair your product with new or refurbished parts, (b) replace it with a new or a refurbished equivalent value product, or (c) refund your purchase price. The decision to repair, replace or refund will be made by the warrantor.

Product or Part Name	Parts	Labor
Digital Camera	1 Year	1 Year
All included Accessories (Except Non-Rechargeable Batteries)	90 Days	Not Applicable
Only Non-Rechargeable Batteries	10 Days	Not Applicable

During the “Labor” warranty period there will be no charge for labor. During the “Parts” warranty period, there will be no charge for parts. This Limited Warranty excludes both parts and labor for non-rechargeable batteries, antennas, and cosmetic parts (cabinet). This warranty only applies to products purchased and serviced in the United States. This warranty is extended only to the original purchaser of a new product which was not sold “as is”.

Mail-In Service--Online Repair Request

Online Repair Request

To submit a new repair request and for quick repair status visit our Web Site at <http://shop.panasonic.com/support>.

When shipping the unit, carefully pack, include all supplied accessories listed in the Owner’s Manual, and send it prepaid, adequately insured and packed well in a carton box. When shipping Lithium Ion batteries please visit our Web Site at <http://shop.panasonic.com/support> as Panasonic is committed to providing the most up to date information. Include a letter detailing the complaint, a return address and provide a daytime phone number where you can be reached. A valid registered receipt is required under the Limited Warranty.

IF REPAIR IS NEEDED DURING THE WARRANTY PERIOD, THE PURCHASER WILL BE REQUIRED TO FURNISH A SALES RECEIPT/PROOF OF PURCHASE INDICATING DATE OF PURCHASE, AMOUNT PAID AND PLACE OF PURCHASE. CUSTOMER WILL BE CHARGED FOR THE REPAIR OF ANY UNIT RECEIVED WITHOUT SUCH PROOF OF PURCHASE.

Limited Warranty Limits and Exclusions

This warranty ONLY COVERS failures due to defects in materials or workmanship, and DOES NOT COVER normal wear and tear or cosmetic damage. The warranty ALSO DOES NOT COVER damages which occurred in shipment, or failures which are caused by products not supplied by the warrantor, or failures which result from accidents, misuse, abuse, neglect, mishandling, misapplication, alteration, faulty installation, set-up adjustments, misadjustment of consumer controls, improper maintenance, power line surge, lightning damage, modification, introduction of sand, humidity or liquids, commercial use such as hotel, office, restaurant, or other business or rental use of the product, or service by anyone other than a Factory Service Center or other Authorized Servicer, or damage that is attributable to acts of God.

THERE ARE NO EXPRESS WARRANTIES EXCEPT AS LISTED UNDER "LIMITED WARRANTY COVERAGE".

THE WARRANTOR IS NOT LIABLE FOR INCIDENTAL OR CONSEQUENTIAL DAMAGES RESULTING FROM THE USE OF THIS PRODUCT, OR ARISING OUT OF ANY BREACH OF THIS WARRANTY.

(As examples, this excludes damages for lost time, travel to and from the servicer, loss of or damage to media or images, data or other memory or recorded content. The items listed are not exclusive, but for illustration only.)

ALL EXPRESS AND IMPLIED WARRANTIES, INCLUDING THE WARRANTY OF MERCHANTABILITY, ARE LIMITED TO THE PERIOD OF THE LIMITED WARRANTY.

Some states do not allow the exclusion or limitation of incidental or consequential damages, or limitations on how long an implied warranty lasts, so the exclusions may not apply to you.

This warranty gives you specific legal rights and you may also have other rights which vary from state to state. If a problem with this product develops during or after the warranty period, you may contact your dealer or Service Center. If the problem is not handled to your satisfaction, then write to:

Consumer Affairs Department
Panasonic Corporation of North America
661 Independence Pkwy
Chesapeake, VA 23320

PARTS AND SERVICE, WHICH ARE NOT COVERED BY THIS LIMITED WARRANTY, ARE YOUR RESPONSIBILITY.

Shop Accessories!

for all your Panasonic gear

Go to

<http://shop.panasonic.com/support>

Get everything you need to get the most out of your Panasonic products
Accessories & Parts for your Camera, Phone, A/V products, TV,
Computers & Networking, Personal Care, Home Appliances, Headphones,
Batteries, Backup Chargers & more...

Customer Services Directory

For Product Information, Operating Assistance, Parts, Owner's Manuals,
Dealer and Service info go to <http://shop.panasonic.com/support>

For the hearing or speech impaired TTY: 1- 877-833-8855

As of July 2015

Limited Warranty (ONLY FOR CANADA)

Panasonic Canada Inc.

5770 Ambler Drive, Mississauga, Ontario L4W 2T3

PANASONIC PRODUCT – LIMITED WARRANTY

Panasonic Canada Inc. warrants this product to be free from defects in material and workmanship under normal use and for a period as stated below from the date of original purchase agrees to, at its option either (a) repair your product with new or refurbished parts, (b) replace it with a new or a refurbished equivalent value product, or (c) refund your purchase price. The decision to repair, replace or refund will be made by Panasonic Canada Inc.

Digital Camera	One (1) year, parts and labour
Digital Camera Peripherals	One (1) year, parts and labour
Digital Camera Accessories	Ninety (90) days, parts and labour

This warranty is given only to the original purchaser, or the person for whom it was purchased as a gift, of a Panasonic brand product mentioned above sold by an authorized Panasonic dealer in Canada and purchased and used in Canada, which product was not sold "as is", and which product was delivered to you in new condition in the original packaging.

**IN ORDER TO BE ELIGIBLE TO RECEIVE WARRANTY SERVICE
HEREUNDER, A PURCHASE RECEIPT OR OTHER PROOF OF DATE
OF ORIGINAL PURCHASE, SHOWING AMOUNT PAID AND PLACE OF
PURCHASE IS REQUIRED**

LIMITATIONS AND EXCLUSIONS

This warranty **ONLY COVERS** failures due to defects in materials or workmanship, and **DOES NOT COVER** normal wear and tear or cosmetic damage. The warranty **ALSO DOES NOT COVER** damages which occurred in shipment, or failures which are caused by products not supplied by Panasonic Canada Inc., or failures which result from accidents, misuse, abuse, neglect, mishandling, misapplication, alteration, faulty installation, set-up adjustments, misadjustment of consumer controls, improper maintenance, improper batteries, power line surge, lightning damage, modification, introduction of sand, humidity or liquids, commercial use such as hotel, office, restaurant, or other business or rental use of the product, or service by anyone other than a Authorized Servicer, or damage that is attributable to acts of God.

Dry cell batteries, printer ink cartridge and paper are also excluded from coverage under this warranty.

Rechargeable batteries are warranted for ninety (90) days from date of original purchase.

THIS EXPRESS, LIMITED WARRANTY IS IN LIEU OF ALL OTHER WARRANTIES, EXPRESS OR IMPLIED, INCLUDING ANY IMPLIED WARRANTIES OF MERCHANTABILITY AND FITNESS FOR A PARTICULAR PURPOSE. IN NO EVENT WILL PANASONIC CANADA INC. BE LIABLE FOR ANY SPECIAL, INDIRECT OR CONSEQUENTIAL DAMAGES RESULTING FROM THE USE OF THIS PRODUCT OR ARISING OUT OF ANY BREACH OF ANY EXPRESS OR IMPLIED WARRANTY. (As examples, this warranty excludes damages for lost time, travel to and from the Authorized Servicer, loss of or damage to media or images, data or other memory or recorded content. This list of items is not exhaustive, but for illustration only.)

In certain instances, some jurisdictions do not allow the exclusion or limitation of incidental or consequential damages, or the exclusion of implied warranties, so the above limitations and exclusions may not be applicable. This warranty gives you specific legal rights and you may have other rights which vary depending on your province or territory.

WARRANTY SERVICE

For product operation, repairs and information assistance, please visit our Support page :

www.panasonic.ca/english/support

- SDXC Logo is a trademark of SD-3C, LLC.
- The terms HDMI and HDMI High-Definition Multimedia Interface, and the HDMI Logo are trademarks or registered trademarks of HDMI Licensing, LLC in the United States and other countries.
- HDAVI Control™ is a trademark of Panasonic Corporation.
- “AVCHD”, “AVCHD Progressive” and the “AVCHD Progressive” logo are trademarks of Panasonic Corporation and Sony Corporation.
- Dolby, Dolby Audio, and the double-D symbol are trademarks of Dolby Laboratories.
- Pentium is a trademark of Intel Corporation in the U.S. and/or other countries.
- Windows is either registered trademark or trademark of Microsoft Corporation in the United States and/or other countries.
- iMovie, Mac and Mac OS are trademarks of Apple Inc., registered in the U.S. and other countries.
- iPad, iPhone, iPod, and iPod touch are trademarks of Apple Inc., registered in the U.S. and other countries.
- App Store is a service mark of Apple Inc.
- Android and Google Play are trademarks or registered trademarks of Google Inc.
- The Wi-Fi CERTIFIED™ Logo is a certification mark of Wi-Fi Alliance®.
- The Wi-Fi Protected Setup™ Identifier mark is a certification mark of Wi-Fi Alliance®.
- “Wi-Fi®” is a registered trademark of Wi-Fi Alliance®.
- “Wi-Fi Protected Setup™”, “WPA™”, and “WPA2™” are trademarks of Wi-Fi Alliance®.
- DLNA, the DLNA Logo and DLNA CERTIFIED are trademarks, service marks, or certification marks of the Digital Living Network Alliance.
- QR Code is a registered trademark of DENSO WAVE INCORPORATED.
- This product uses “DynaFont” from DynaComware Corporation. DynaFont is a registered trademark of DynaComware Taiwan Inc.
- Other names, company names, and product names mentioned in these instructions are trademarks or registered trademarks of the companies concerned.



Panasonic Corporation of North America

Two Riverfront Plaza, Newark, NJ 07102-5490

<http://shop.panasonic.com>

Panasonic Canada Inc.

5770 Ambler Drive
Mississauga, Ontario
L4W 2T3

www.panasonic.com

© Panasonic Corporation 2017

Printed in China